

Simulink®

User's Guide



MATLAB® & SIMULINK®

R2017a



## How to Contact MathWorks



Latest news: [www.mathworks.com](http://www.mathworks.com)  
Sales and services: [www.mathworks.com/sales\\_and\\_services](http://www.mathworks.com/sales_and_services)  
User community: [www.mathworks.com/matlabcentral](http://www.mathworks.com/matlabcentral)  
Technical support: [www.mathworks.com/support/contact\\_us](http://www.mathworks.com/support/contact_us)



Phone: 508-647-7000



The MathWorks, Inc.  
3 Apple Hill Drive  
Natick, MA 01760-2098

*Simulink*<sup>®</sup> *User's Guide*

© COPYRIGHT 1990–2017 by The MathWorks, Inc.

The software described in this document is furnished under a license agreement. The software may be used or copied only under the terms of the license agreement. No part of this manual may be photocopied or reproduced in any form without prior written consent from The MathWorks, Inc.

**FEDERAL ACQUISITION:** This provision applies to all acquisitions of the Program and Documentation by, for, or through the federal government of the United States. By accepting delivery of the Program or Documentation, the government hereby agrees that this software or documentation qualifies as commercial computer software or commercial computer software documentation as such terms are used or defined in FAR 12.212, DFARS Part 227.72, and DFARS 252.227-7014. Accordingly, the terms and conditions of this Agreement and only those rights specified in this Agreement, shall pertain to and govern the use, modification, reproduction, release, performance, display, and disclosure of the Program and Documentation by the federal government (or other entity acquiring for or through the federal government) and shall supersede any conflicting contractual terms or conditions. If this License fails to meet the government's needs or is inconsistent in any respect with federal procurement law, the government agrees to return the Program and Documentation, unused, to The MathWorks, Inc.

### **Trademarks**

MATLAB and Simulink are registered trademarks of The MathWorks, Inc. See [www.mathworks.com/trademarks](http://www.mathworks.com/trademarks) for a list of additional trademarks. Other product or brand names may be trademarks or registered trademarks of their respective holders.

### **Patents**

MathWorks products are protected by one or more U.S. patents. Please see [www.mathworks.com/patents](http://www.mathworks.com/patents) for more information.



## Revision History

November 1990	First printing	New for Simulink 1
December 1996	Second printing	Revised for Simulink 2
January 1999	Third printing	Revised for Simulink 3 (Release 11)
November 2000	Fourth printing	Revised for Simulink 4 (Release 12)
July 2002	Fifth printing	Revised for Simulink 5 (Release 13)
April 2003	Online only	Revised for Simulink 5.1 (Release 13SP1)
April 2004	Online only	Revised for Simulink 5.1.1 (Release 13SP1+)
June 2004	Sixth printing	Revised for Simulink 5.0 (Release 14)
October 2004	Seventh printing	Revised for Simulink 6.1 (Release 14SP1)
March 2005	Online only	Revised for Simulink 6.2 (Release 14SP2)
September 2005	Eighth printing	Revised for Simulink 6.3 (Release 14SP3)
March 2006	Online only	Revised for Simulink 6.4 (Release 2006a)
March 2006	Ninth printing	Revised for Simulink 6.4 (Release 2006a)
September 2006	Online only	Revised for Simulink 6.5 (Release 2006b)
March 2007	Online only	Revised for Simulink 6.6 (Release 2007a)
September 2007	Online only	Revised for Simulink 7.0 (Release 2007b)
March 2008	Online only	Revised for Simulink 7.1 (Release 2008a)
October 2008	Online only	Revised for Simulink 7.2 (Release 2008b)
March 2009	Online only	Revised for Simulink 7.3 (Release 2009a)
September 2009	Online only	Revised for Simulink 7.4 (Release 2009b)
March 2010	Online only	Revised for Simulink 7.5 (Release 2010a)
September 2010	Online only	Revised for Simulink 7.6 (Release 2010b)
April 2011	Online only	Revised for Simulink 7.7 (Release 2011a)
September 2011	Online only	Revised for Simulink 7.8 (Release 2011b)
March 2012	Online only	Revised for Simulink 7.9 (Release 2012a)
September 2012	Online only	Revised for Simulink 8.0 (Release 2012b)
March 2013	Online only	Revised for Simulink 8.1 (Release 2013a)
September 2013	Online only	Revised for Simulink 8.2 (Release 2013b)
March 2014	Online only	Revised for Simulink 8.3 (Release 2014a)
October 2014	Online only	Revised for Simulink 8.4 (Release 2014b)
March 2015	Online only	Revised for Simulink 8.5 (Release 2015a)
September 2015	Online only	Revised for Simulink 8.6 (Release 2015b)
October 2015	Online only	Rereleased for Simulink 8.5.1 (Release 2015aSP1)
March 2016	Online only	Revised for Simulink 8.7 (Release 2016a)
September 2016	Online only	Revised for Simulink 8.8 (Release 2016b)
March 2017	Online only	Revised for Simulink 8.9 (Release 2017a)



## Introduction to Simulink

### Simulink Basics

1

<b>Start the Simulink Software</b> .....	<b>1-2</b>
Start the MATLAB Software .....	1-2
Open the Simulink Editor .....	1-2
Open the Library Browser .....	1-3
<b>Create Models and Open Existing Models</b> .....	<b>1-5</b>
Create a Model .....	1-5
Use Customized Settings When Creating New Models ..	1-8
Open a Model .....	1-10
Load Variables When Opening a Model .....	1-11
Open a Model with Different Character Encoding ....	1-12
Simulink Model File Types .....	1-12
<b>Programmatic Modeling Basics</b> .....	<b>1-14</b>
Load a Model .....	1-14
Create a Model and Specify Parameter Settings .....	1-14
Programmatically Load Variables When Opening a Model .....	1-15
Programmatically Add and Connect Blocks .....	1-16
Name a Signal Programmatically .....	1-18
Open the Same Model in Multiple Windows .....	1-18
Get a Simulink Identifier .....	1-18
Specify Colors Programmatically .....	1-22
<b>Build and Edit a Model in the Simulink Editor</b> .....	<b>1-24</b>
Start Simulink and Create a New Model .....	1-24
Add Blocks to the Model .....	1-24
Align and Connect Blocks .....	1-25

Set Block Parameters .....	1-26
Add More Blocks .....	1-27
Branch a Connection .....	1-28
Organize Your Model .....	1-31
Simulate Model and View Results .....	1-33
Modify the Model .....	1-34
<b>Save a Model .....</b>	<b>1-38</b>
How to Tell If a Model Needs Saving .....	1-38
Save a Model .....	1-38
What Happens When You Save a Model? .....	1-39
Save Models in the SLX File Format .....	1-40
Save Models with Different Character Encodings .....	1-42
Export a Model to a Previous Simulink Version .....	1-44
Save from One Earlier Simulink Version to Another ..	1-44
<b>Model Editing Environment .....</b>	<b>1-46</b>
Simulink Editor .....	1-46
Interactive Model Building .....	1-48
Model Design Error Detection .....	1-49
Library Browser .....	1-49
Setting Properties and Parameters .....	1-51
<b>Parts of a Model .....</b>	<b>1-54</b>
About Blocks .....	1-54
Block Parameters and Properties in Simulink .....	1-55
Signals .....	1-57
<b>Preview Content of Hierarchical Items .....</b>	<b>1-58</b>
What Is Content Preview? .....	1-58
Enable Content Preview .....	1-59
What Content Preview Displays .....	1-59
<b>Use Viewmarks to Save Views of Models .....</b>	<b>1-61</b>
What Are Viewmarks? .....	1-61
Create a Viewmark .....	1-62
Open and Navigate Viewmarks .....	1-63
Manage Viewmarks .....	1-63
Refresh a Viewmark .....	1-64
<b>Update Diagram and Run Simulation .....</b>	<b>1-65</b>
Updating the Diagram .....	1-65
Simulation Updates the Diagram .....	1-65

Update Diagram While Editing .....	1-65
Simulate a Model .....	1-66
<b>Print Model Diagrams .....</b>	<b>1-68</b>
Print Interactively or Programmatically .....	1-68
Printing Options .....	1-68
Canvas Color .....	1-68
<b>Basic Printing .....</b>	<b>1-70</b>
Print the vdp Model Using Default Settings .....	1-70
Print a Subsystem Hierarchy .....	1-72
<b>Select the Systems to Print .....</b>	<b>1-74</b>
Print Current System .....	1-74
Print Subsystems .....	1-74
Print a Model Referencing Hierarchy .....	1-75
<b>Specify the Page Layout and Print Job .....</b>	<b>1-76</b>
Page and Print Job Setup .....	1-76
Set Paper Size and Orientation Without Printing .....	1-76
<b>Tiled Printing .....</b>	<b>1-77</b>
<b>Print Multiple Pages for Large Models .....</b>	<b>1-78</b>
<b>Add a Log of Printed Models .....</b>	<b>1-79</b>
<b>Add a Sample Time Legend .....</b>	<b>1-80</b>
<b>Print from the MATLAB Command Line .....</b>	<b>1-81</b>
Printing Commands .....	1-81
Print Systems with Multiline Names or Names with Spaces .....	1-81
Set Paper Orientation and Type .....	1-82
Position and Size a System .....	1-82
Use Tiled Printing .....	1-83
<b>Print to a PDF .....</b>	<b>1-85</b>
<b>Print Model Reports .....</b>	<b>1-86</b>
Model Report Options .....	1-87

<b>Print Models to Image File Formats</b> .....	<b>1-89</b>
Copy Model Views to Third-Party Applications .....	<b>1-89</b>
<b>Keyboard and Mouse Actions for Simulink Modeling</b> .	<b>1-90</b>
Object Selection and Clipboard Operations .....	<b>1-90</b>
Block and Signal Line Shortcuts and Actions .....	<b>1-91</b>
Signal Name and Label Actions .....	<b>1-92</b>
Simulation Keyboard Shortcuts .....	<b>1-93</b>
Debugging and Breakpoints Keyboard Shortcuts .....	<b>1-93</b>
Zooming and Scrolling Shortcuts .....	<b>1-93</b>
Library Browser Shortcuts .....	<b>1-94</b>
File Operations .....	<b>1-95</b>

## Simulation Stepping

# 2

<b>How Simulation Stepper Helps With Model Analysis</b> ..	<b>2-2</b>
<b>How Stepping Through a Simulation Works</b> .....	<b>2-3</b>
Simulation Snapshots .....	<b>2-3</b>
How Simulation Stepper Uses Snapshots .....	<b>2-4</b>
How Simulation Stepper Differs from Simulink Debugger .....	<b>2-5</b>
<b>Use Simulation Stepper</b> .....	<b>2-8</b>
Simulation Stepper Access .....	<b>2-8</b>
Simulation Stepper Pause Status .....	<b>2-8</b>
Tune Parameters .....	<b>2-9</b>
Referenced Models .....	<b>2-10</b>
Simulation Stepper and Interval Logging .....	<b>2-10</b>
Simulation Stepper and Stateflow Debugger .....	<b>2-10</b>
<b>Simulation Stepper Limitations</b> .....	<b>2-12</b>
Interface .....	<b>2-12</b>
Model Configuration .....	<b>2-12</b>
Blocks .....	<b>2-12</b>
<b>Step Through a Simulation</b> .....	<b>2-15</b>
Step Forward and Back .....	<b>2-15</b>

<b>Set Conditional Breakpoints for Stepping a Simulation</b> .....	<b>2-18</b>
Add and Edit Conditional Breakpoints .....	<b>2-18</b>
Observe Conditional Breakpoint Values .....	<b>2-19</b>

## How Simulink Works

# 3

<b>How Simulink Works</b> .....	<b>3-2</b>
<b>Modeling Dynamic Systems</b> .....	<b>3-3</b>
Block Diagram Semantics .....	<b>3-3</b>
Creating Models .....	<b>3-4</b>
Time .....	<b>3-4</b>
States .....	<b>3-5</b>
Block Parameters .....	<b>3-8</b>
Tunable Parameters .....	<b>3-8</b>
Block Sample Times .....	<b>3-9</b>
Custom Blocks .....	<b>3-9</b>
Systems and Subsystems .....	<b>3-10</b>
Signals .....	<b>3-14</b>
Block Methods .....	<b>3-15</b>
Model Methods .....	<b>3-16</b>
<b>Simulation Phases in Dynamic Systems</b> .....	<b>3-17</b>
Model Compilation .....	<b>3-17</b>
Link Phase .....	<b>3-18</b>
Simulation Loop Phase .....	<b>3-18</b>
<b>Solvers</b> .....	<b>3-21</b>
Fixed-Step Solvers Versus Variable-Step Solvers .....	<b>3-21</b>
Continuous Versus Discrete Solvers .....	<b>3-21</b>
Minor Time Steps .....	<b>3-22</b>
Shape Preservation .....	<b>3-22</b>
<b>Zero-Crossing Detection</b> .....	<b>3-24</b>
Demonstrating Effects of Excessive Zero-Crossing Detection .....	<b>3-24</b>
How the Simulator Can Miss Zero-Crossing Events ...	<b>3-29</b>
Preventing Excessive Zero Crossings .....	<b>3-30</b>

Zero-Crossing Algorithms .....	3-32
Understanding Signal Threshold .....	3-33
How Blocks Work with Zero-Crossing Detection .....	3-34
<b>Algebraic Loops .....</b>	<b>3-38</b>
What Is an Algebraic Loop? .....	3-38
Interpretations of Algebraic Loops .....	3-39
What is an Artificial Algebraic Loop? .....	3-42
Why Algebraic Loops Are Undesirable .....	3-43
Identify Algebraic Loops in Your Model .....	3-44
How to Handle Algebraic Loops in a Model .....	3-47
How the Algebraic Loop Solver Works .....	3-49
Remove Algebraic Loops .....	3-51
Remove Artificial Algebraic Loops .....	3-54
How Simulink Eliminates Artificial Algebraic Loops ..	3-65
When Simulink Cannot Eliminate Artificial Algebraic Loops .....	3-71
Managing Large Models with Artificial Algebraic Loops	3-73
Changing Block Priorities When Using Algebraic Loop Solver .....	3-74

## Modeling Dynamic Systems

### Creating a Model

# 4

<b>Create a Template from a Model .....</b>	<b>4-2</b>
<b>Describe Models Using Annotations .....</b>	<b>4-3</b>
Add a Text Annotation .....	4-3
Resize an Annotation .....	4-4
Make an Annotation Interactive .....	4-4
Add an Image Annotation .....	4-5
Use TeX Commands in an Annotation .....	4-5
Add Lines to Connect Annotations to Blocks .....	4-6
Select Font Dialog Box on Linux Machines .....	4-6



<b>Create an Annotation</b> .....	4-7
Add and Lay Out an Annotation .....	4-7
Add a Hyperlink and Format Text .....	4-8
Add a Bullet List .....	4-8
Copy and Paste a Web Image .....	4-9
Add a Numbered List .....	4-9
<b>Show or Hide Annotations</b> .....	4-10
Configure an Annotation for Hiding .....	4-10
Hide Markup Annotations .....	4-10
<b>Add an Annotation Callback</b> .....	4-11
Annotation Callback Functions .....	4-11
Associate a Click Function with an Annotation .....	4-11
Select and Edit Click-Function Annotations .....	4-12
<b>Create an Annotation Programmatically</b> .....	4-13
Annotations API .....	4-13
Create Annotations Programmatically .....	4-13
Delete an Annotation Programmatically .....	4-14
Find Annotations in a Model .....	4-14
Show or Hide Annotations Programmatically .....	4-14
<b>TeX for Simulink Model Annotations</b> .....	4-16
<b>Create a Subsystem</b> .....	4-18
Subsystem Advantages .....	4-18
Ways to Create a Subsystem .....	4-18
Create a Subsystem in a Subsystem Block .....	4-19
Create a Subsystem from Selected Blocks .....	4-20
Create a Subsystem Using Context Options .....	4-21
<b>Configure a Subsystem</b> .....	4-23
Subsystem Execution .....	4-23
Label Subsystem Ports .....	4-23
Control Access to Subsystems .....	4-23
Control Subsystem Behavior with Callbacks .....	4-24
<b>Navigate Subsystems in the Model Hierarchy</b> .....	4-26
Open a Subsystem .....	4-26
<b>Subsystem Expansion</b> .....	4-30
What Is Subsystem Expansion? .....	4-30

Why Expand a Subsystem? .....	4-31
Subsystems That You Can Expand .....	4-32
Results of Expanding a Subsystem .....	4-32
Data Stores .....	4-33
<b>Expand Subsystem Contents .....</b>	<b>4-35</b>
Expand a Subsystem .....	4-35
Expand a Subsystem from the Command Line .....	4-36
<b>Use Control Flow Logic .....</b>	<b>4-37</b>
What is a Control Flow Subsystem .....	4-37
Equivalent C Language Statements .....	4-37
Conditional Control Flow Logic .....	4-37
While and For Loops .....	4-40
<b>Callbacks for Customized Model Behavior .....</b>	<b>4-46</b>
Model, Block, and Port Callbacks .....	4-46
What You Can Do with Callbacks .....	4-46
Avoid run Commands in Callback Code .....	4-46
<b>Model Callbacks .....</b>	<b>4-48</b>
Create Model Callbacks .....	4-48
Model Callback Parameters .....	4-49
<b>Block Callbacks .....</b>	<b>4-52</b>
Specify Block Callbacks .....	4-52
Block Callback Parameters .....	4-52
<b>Port Callbacks .....</b>	<b>4-59</b>
<b>Callback Tracing .....</b>	<b>4-60</b>
<b>Manage Model Versions and Specify Model Properties .....</b>	<b>4-61</b>
How Simulink Helps You Manage Model Versions .....	4-61
Model File Change Notification .....	4-61
Manage Model Properties .....	4-62
Log Comments History .....	4-64
Version Information Properties .....	4-65
<b>Model Discretizer .....</b>	<b>4-68</b>
What Is the Model Discretizer? .....	4-68
Requirements .....	4-68
Discretize a Model with the Model Discretizer .....	4-69

View the Discretized Model .....	4-77
Discretize Blocks from the Simulink Model .....	4-80
Discretize a Model with the sldiscmdl Function .....	4-90

## Model Advisor

### 5

<b>Select and Run Model Advisor Checks</b> .....	5-2
Model Advisor Overview .....	5-2
To Run Model Advisor Checks: .....	5-2
To display an HTML report of check results: .....	5-5
Set Model Advisor Window Preferences .....	5-6
Display and Run Checks .....	5-7
Run the Same Set of Checks Consistently .....	5-7
Run Model Checks Programmatically .....	5-8
Access Other Advisors .....	5-8
<b>Model Advisor Limitations</b> .....	5-9
<b>Save Model Analysis Time</b> .....	5-10
<b>Run Model Checks in Background</b> .....	5-12
<b>Address Model Check Results</b> .....	5-14
Address Model Check Results with Highlighting .....	5-14
Fix a Model Check Warning or Failure .....	5-18
Revert Changes .....	5-19
<b>Save and View Model Advisor Reports</b> .....	5-22
Save Model Advisor Reports .....	5-22
View Model Advisor Reports .....	5-22

## Upgrade Advisor

### 6

<b>Consult the Upgrade Advisor</b> .....	6-2
Upgrade Programmatically .....	6-3

## Working with Sample Times

# 7

<b>What Is Sample Time?</b> .....	7-2
<b>Specify Sample Time</b> .....	7-3
Designate Sample Times .....	7-3
Specify Block-Based Sample Times Interactively .....	7-5
Specify Port-Based Sample Times Interactively .....	7-6
Specify Block-Based Sample Times Programmatically ..	7-7
Specify Port-Based Sample Times Programmatically ...	7-7
Access Sample Time Information Programmatically ...	7-8
Specify Sample Times for a Custom Block .....	7-8
Determining Sample Time Units .....	7-8
Change the Sample Time After Simulation Start Time .	7-8
<b>View Sample Time Information</b> .....	7-9
View Sample Time Display .....	7-9
Sample Time Legend .....	7-10
<b>Print Sample Time Information</b> .....	7-14
<b>Types of Sample Time</b> .....	7-15
Discrete Sample Time .....	7-15
Continuous Sample Time .....	7-16
Fixed-in-Minor-Step .....	7-16
Inherited Sample Time .....	7-16
Constant Sample Time .....	7-17
Variable Sample Time .....	7-17
Triggered Sample Time .....	7-18
Asynchronous Sample Time .....	7-18
<b>Blocks for Which Sample Time Is Not Recommended</b> .	7-20
Best Practice to Model Sample Times .....	7-20
Appropriate Blocks for the Sample Time Parameter ..	7-21
Specify Sample Time in Blocks Where Hidden .....	7-21
<b>Block Compiled Sample Time</b> .....	7-23

<b>Sample Times in Subsystems</b> .....	<b>7-26</b>
<b>Sample Times in Systems</b> .....	<b>7-28</b>
Purely Discrete Systems .....	<b>7-28</b>
Hybrid Systems .....	<b>7-30</b>
<b>Resolve Rate Transitions</b> .....	<b>7-34</b>
Automatic Rate Transition .....	<b>7-34</b>
Visualize Inserted Rate Transition Blocks .....	<b>7-35</b>
<b>How Propagation Affects Inherited Sample Times</b> ...	<b>7-38</b>
Process for Sample Time Propagation .....	<b>7-38</b>
Simulink Rules for Assigning Sample Times .....	<b>7-38</b>
<b>Backpropagation in Sample Times</b> .....	<b>7-40</b>

## Referencing a Model

# 8

<b>Overview of Model Referencing</b> .....	<b>8-2</b>
Reference One Model From Another Model .....	<b>8-2</b>
Model Reference Hierarchies .....	<b>8-3</b>
Model Block and Referenced Model Ports .....	<b>8-4</b>
Using Referenced Models as Standalone Models .....	<b>8-5</b>
Examples of Models That Use Model Referencing .....	<b>8-5</b>
Simulation of Model Referencing Models .....	<b>8-6</b>
Code Generation for Referenced Models .....	<b>8-6</b>
<b>When to Use Model Referencing</b> .....	<b>8-7</b>
Referenced Model Advantages .....	<b>8-7</b>
Compare Model Referencing to Other Componentization Techniques .....	<b>8-8</b>
<b>Create a Referenced Model</b> .....	<b>8-9</b>
Masking Model Blocks .....	<b>8-11</b>
<b>Subsystem to Referenced Model Conversion</b> .....	<b>8-13</b>
When to Convert to Model Referencing .....	<b>8-13</b>
Limitations on Subsystems That You Can Convert ...	<b>8-13</b>
Conversion Process .....	<b>8-13</b>

Conversion Checking .....	8-15
Conversion Results .....	8-15
Conversion Report .....	8-16
<b>Convert a Subsystem to a Referenced Model .....</b>	<b>8-17</b>
Determine Whether to Convert the Subsystem .....	8-17
Update the Model Before Converting the Subsystem ..	8-17
Run the Model Reference Conversion Advisor .....	8-21
Compare Simulation Results Before and After	
Conversion .....	8-22
Revert the Conversion Results .....	8-23
Integrate the Referenced Model into the Parent Model	8-23
<b>Sample Times for Model Referencing .....</b>	<b>8-26</b>
How Sample-Time Inheritance Works for Model Blocks	8-26
Conditions for Inheriting Sample Times .....	8-26
Determining Sample Time of a Referenced Model ....	8-27
Blocks That Depend on Absolute Time .....	8-27
Blocks Whose Outputs Depend on Inherited Sample	
Time .....	8-28
Sample Time Consistency .....	8-29
<b>Simulate Model Referencing Models .....</b>	<b>8-31</b>
Simulate a Top Model .....	8-31
Referenced Model Simulation .....	8-31
Faster Simulations Using Simulink Cache Files .....	8-36
<b>Simulate Models with Multiple Referenced Model</b>	
<b>Instances .....</b>	<b>8-37</b>
Normal Mode Visibility .....	8-37
Example Models with Multiple Referenced Model	
Instances .....	8-37
Configure Models with Multiple Referenced Model	
Instances .....	8-39
Specify the Instance Having Normal Mode Visibility ..	8-40
<b>View a Model Referencing Hierarchy .....</b>	<b>8-44</b>
Display Version Numbers .....	8-44
<b>Model Referencing Simulation Targets .....</b>	<b>8-46</b>
Simulation Targets .....	8-46
Build Simulation Targets .....	8-47
Simulation Target Output File Control .....	8-48

Reduce Update Time for Referenced Models . . . . .	8-50
<b>Reuse Simulation Builds for Faster Simulations . . . . .</b>	<b>8-55</b>
Examples of Using Simulink Cache Files . . . . .	8-55
Simulink Cache Files . . . . .	8-56
Share Simulink Cache Files . . . . .	8-57
<b>Simulink Model Referencing Requirements . . . . .</b>	<b>8-59</b>
About Model Referencing Requirements . . . . .	8-59
Name Length Requirement . . . . .	8-59
Configuration Parameter Requirements . . . . .	8-59
Model Structure Requirements . . . . .	8-63
<b>Parameterize Instances of a Reusable Referenced Model . . . . .</b>	<b>8-65</b>
Specify Different Value for Each Instance of Reusable Model . . . . .	8-65
Combine Multiple Arguments into a Structure . . . . .	8-66
Parameterize a Referenced Model . . . . .	8-66
Rename Model Argument . . . . .	8-72
Programmatically Change Specific Argument Value in a Model Block . . . . .	8-73
Customize User Interface for Reusable Component . . . . .	8-73
Specify Argument Values for a Model Variants Block . . . . .	8-74
Configure Instance-Specific Data for Lookup Tables . . . . .	8-74
<b>Model Arguments for Model Variants Blocks . . . . .</b>	<b>8-78</b>
Configure Model Arguments in Referenced Model . . . . .	8-78
Assign Model Argument Values . . . . .	8-79
<b>Create and Reference Conditional Referenced Models . . . . .</b>	<b>8-82</b>
Conditional Referenced Models . . . . .	8-82
Create Conditional Models . . . . .	8-83
Requirements for Conditional Models . . . . .	8-85
Reference Conditional Models . . . . .	8-86
<b>Simulate Conditional Referenced Models . . . . .</b>	<b>8-88</b>
Triggered, Enabled, and Triggered and Enabled Models . . . . .	8-88
Function-Call Models . . . . .	8-88
<b>Protected Model . . . . .</b>	<b>8-90</b>

<b>Use Protected Model in Simulation</b> .....	<b>8-92</b>
Protected Model Web View .....	<b>8-93</b>
<b>Refresh Model Blocks</b> .....	<b>8-94</b>
<b>S-Functions with Referenced Models</b> .....	<b>8-95</b>
S-Function Support for Model Referencing .....	<b>8-95</b>
Sample Times .....	<b>8-95</b>
S-Functions with Accelerator Mode Referenced Models	<b>8-96</b>
Using C S-Functions in Normal Mode Referenced	
Models .....	<b>8-96</b>
Protected Models .....	<b>8-97</b>
Simulink Coder Considerations .....	<b>8-97</b>
<b>Buses in Referenced Models</b> .....	<b>8-98</b>
<b>Signal Logging in Referenced Models</b> .....	<b>8-99</b>
<b>Model Referencing Limitations</b> .....	<b>8-100</b>
Introduction .....	<b>8-100</b>
Limitations on All Model Referencing .....	<b>8-100</b>
Limitations on Normal Mode Referenced Models . . . .	<b>8-103</b>
Limitations on Accelerator Mode Referenced Models .	<b>8-103</b>
Limitations on Rapid Accelerator Mode Referenced	
Models .....	<b>8-106</b>
Certain Diagnostic Configuration Parameters Ignored for	
Models Referenced in Accelerator Mode .....	<b>8-106</b>
Limitations on SIL and PIL Mode Referenced Models	<b>8-107</b>
Configuration Parameters Changed During Code	
Generation .....	<b>8-107</b>

## Simulink Units

# 9

<b>Unit Specification in Simulink Models</b> .....	<b>9-2</b>
Specify Physical Quantities .....	<b>9-4</b>
Specify Units in Objects .....	<b>9-4</b>
Specify Units for Temperature Signals .....	<b>9-6</b>
Specify Units in MATLAB Function Blocks .....	<b>9-6</b>
Specify Units for Logging and Loading Signal Data . . . .	<b>9-6</b>



Restricting Unit Systems .....	9-6
<b>Displaying Units .....</b>	<b>9-9</b>
<b>Unit Consistency Checking and Propagation .....</b>	<b>9-11</b>
Unit Propagation Between Simulink and Simscape ...	9-14
<b>Converting Units .....</b>	<b>9-16</b>
Automatic Unit Conversion Limitations .....	9-16
<b>Update an Existing Model to Use Units .....</b>	<b>9-18</b>
<b>Troubleshooting Units .....</b>	<b>9-26</b>
Undefined Units .....	9-26
Overflow and Underflow Errors or Warning .....	9-26
Mismatched Units Detected .....	9-27
Mismatched Units Detected While Loading .....	9-27
Disallowed Unit Systems .....	9-27
Automatic Unit Conversions .....	9-27
Unsuccessful Automatic Unit Conversions .....	9-28
Simscape Unit Specification Incompatible with Simulink .....	9-28

## Conditional Subsystems

# 10

<b>Conditional Subsystems .....</b>	<b>10-2</b>
<b>Enabled Subsystems .....</b>	<b>10-4</b>
Create an Enabled Subsystem .....	10-5
Blocks in Enabled Subsystems .....	10-6
Alternately Executing Enabled Subsystems .....	10-8
<b>Triggered Subsystems .....</b>	<b>10-14</b>
Create a Triggered Subsystem .....	10-15
Triggering with Discrete Time Systems .....	10-17
Triggered Model Versus a Triggered Subsystem .....	10-17
Blocks in a Triggered Subsystem .....	10-18

<b>Enabled and Triggered Subsystems</b> .....	<b>10-19</b>
Creating an Enabled and Triggered Subsystem .....	<b>10-20</b>
Blocks in an Enabled and Triggered Subsystem .....	<b>10-22</b>
<b>Function-Call Subsystems</b> .....	<b>10-23</b>
Creating a Function-Call Subsystem .....	<b>10-23</b>
Sample Time Propagation in a Function-Call Subsystem .....	<b>10-25</b>
<b>Conditional Subsystem Initial Output Values</b> .....	<b>10-27</b>
Inherit Initial Output Values from Input Signals ...	<b>10-27</b>
Specify Initial Output Values .....	<b>10-28</b>
<b>Conditional Subsystem Output Values When Disabled</b> .....	<b>10-29</b>
<b>Simplified Initialization Mode</b> .....	<b>10-30</b>
When to Use Simplified Initialization .....	<b>10-30</b>
Set Initialization Mode to Simplified .....	<b>10-31</b>
<b>Classic Initialization Mode</b> .....	<b>10-32</b>
When to Use Classic Initialization .....	<b>10-32</b>
Set Initialization Mode to Classic .....	<b>10-32</b>
Classic Initialization Issues .....	<b>10-33</b>
Identity Transformation Can Change Model Behavior	<b>10-34</b>
Discrete-Time Integrator or S-Function Block Can Produce Inconsistent Output .....	<b>10-37</b>
Sorted Order Can Affect Merge Block Output .....	<b>10-40</b>
<b>Convert from Classic to Simplified Initialization Mode</b> .....	<b>10-50</b>
Blocks to Consider .....	<b>10-50</b>
<b>Export-Function Models</b> .....	<b>10-52</b>
About Export-Function Models .....	<b>10-52</b>
Requirements for Export-Function Models .....	<b>10-53</b>
Sample Time for Function-Call Subsystems in Export- Function Models .....	<b>10-54</b>
Control Export Function Scheduling Using Sample Time .....	<b>10-56</b>
Execution Order for Function-Call Root-Level Inport Blocks .....	<b>10-59</b>
Workflows for Export-Function Models .....	<b>10-64</b>

Nested Export-Function Models . . . . .	10-69
Comparison Between Export-Function Models and Models with Asynchronous Function-Call Inputs . . . . .	10-70
<b>Resettable Subsystems . . . . .</b>	<b>10-72</b>
Behavior of Resettable Subsystems . . . . .	10-72
Comparison of Resettable Subsystems and Enabled Subsystems . . . . .	10-75
<b>Action Subsystem . . . . .</b>	<b>10-79</b>
What Are Action Subsystems? . . . . .	10-79
Set States When an Action Subsystem Executes . . . . .	10-80
<b>Simulink Functions . . . . .</b>	<b>10-82</b>
What Are Simulink Functions? . . . . .	10-82
What Are Simulink Function Callers? . . . . .	10-82
Connect to Local Signals . . . . .	10-83
Reusable Logic with Functions . . . . .	10-83
Input/Output Argument Behavior . . . . .	10-84
Shared Resources with Functions . . . . .	10-85
How a Function Caller Identifies a Function . . . . .	10-86
Reasons to Use a Simulink Function Block . . . . .	10-87
Choose a Simulink Function or Reusable Subsystem . . . . .	10-88
When Not to Use a Simulink Function Block . . . . .	10-88
Tracing Simulink Functions . . . . .	10-88
<b>Simulink Functions in Models . . . . .</b>	<b>10-93</b>
Create Simulink Functions in a Simulink Model . . . . .	10-93
Call Simulink Functions with a Function Caller Block . . . . .	10-100
Call Simulink Functions from a MATLAB Function Block . . . . .	10-103
Call Simulink Functions from a Stateflow Chart . . . . .	10-105
Call a Simulink Function Block from Multiple Sites . . . . .	10-107
<b>Argument Specification for Simulink Functions . . . . .</b>	<b>10-111</b>
Example Argument Specifications for Data Types . . . . .	10-111
Input Argument Specification for Bus Data Type . . . . .	10-112
Input Argument Specification for Enumerated Data Type . . . . .	10-113
Input Argument Specification for an Alias Data Type . . . . .	10-114
<b>Simulink Functions in Referenced Models . . . . .</b>	<b>10-116</b>
Simulink Function Block in Referenced Model . . . . .	10-116

Function Caller Block in Referenced Model . . . . .	10-119
Function and Function Caller in Separate Models . .	10-121
Function and Function Caller in the Same Model . .	10-123
<b>Private Scoping of Simulink Functions . . . . .</b>	<b>10-125</b>
Resolve to a Function Hierarchically . . . . .	10-125
Resolve to a Function by Qualification . . . . .	10-126
<b>Diagnostics Using a Client-Server Architecture . . .</b>	<b>10-130</b>
Diagnostic Messaging with Simulink Functions . . . .	10-130
Client-Server Architecture . . . . .	10-130
Modifier Pattern . . . . .	10-132
Observer Pattern . . . . .	10-134
<b>Initialize, Reset, and Terminate Function</b>	
<b>Limitations . . . . .</b>	<b>10-136</b>
Unsupported Blocks . . . . .	10-136
Unsupported Features . . . . .	10-136
Component I/O Blocks . . . . .	10-137
<b>Create Model to Initialize, Reset, and Terminate</b>	
<b>State . . . . .</b>	<b>10-139</b>
Create Model Component with State . . . . .	10-139
Initialize Block State . . . . .	10-141
Reset Block State . . . . .	10-144
Read and Save Block State . . . . .	10-147
Prepare Model Component for Testing . . . . .	10-151
Create an Export-Function Model . . . . .	10-152
<b>Create Test Harness to Generate Function Calls . . .</b>	<b>10-155</b>
Reference the Export-Function Model . . . . .	10-155
Model an Event Scheduler . . . . .	10-158
Connect Chart to Test Model . . . . .	10-160

## Modeling Variant Systems

# 11

<b>What Are Variants and When to Use Them . . . . .</b>	<b>11-2</b>
What Are Variants? . . . . .	11-2
Advantages of Using Variants . . . . .	11-4

When to Use Variants .....	11-5
Options for Representing Variants in Simulink .....	11-6
Mapping Inports and Outports of Variant Choices .....	11-7
Variant Badges .....	11-8
Comment Out and Comment Through .....	11-10
<b>Working with Variant Choices .....</b>	<b>11-12</b>
Default Variant Choice .....	11-13
Active Variant Choice .....	11-13
Inactive Variant Choice .....	11-14
Empty Variant Choice .....	11-14
Open Active Variant .....	11-14
<b>Introduction to Variant Controls .....</b>	<b>11-16</b>
Operands .....	11-16
Operators .....	11-16
Approaches for Specifying Variant Controls .....	11-17
Operators and Operands in Variant Condition Expressions .....	11-23
<b>Create a Simple Variant Model .....</b>	<b>11-25</b>
<b>Create Variant Controls Programmatically .....</b>	<b>11-29</b>
Create and Export Variant Controls .....	11-29
Reuse Variant Conditions .....	11-29
Enumerated Types as Variant Controls .....	11-30
<b>Define, Configure, and Activate Variants .....</b>	<b>11-31</b>
Represent Variant Choices .....	11-31
Include Simulink Model as Variant Choice .....	11-35
Configure Variant Controls .....	11-37
Convert Subsystem to Variant Subsystem .....	11-38
<b>Prepare Variant-Containing Model for Code Generation .....</b>	<b>11-40</b>
Convert Variant Control Variables into Simulink.Parameter Objects .....	11-40
Configure Model for Generating Preprocessor Conditionals .....	11-42
<b>Set up Model Variants .....</b>	<b>11-45</b>
Configure the Model Variants Block .....	11-46
Disable and Enable Model Variants .....	11-48

Parameterize Model Variants .....	11-49
Additional Examples .....	11-49
<b>Visualize Variant Implementations in a Single Layer</b>	<b>11-51</b>
How Variant Sources and Sinks Work .....	11-51
Advantages of Using Variant Sources and Sinks ....	11-52
Limitations of Using Variant Sources and Sinks ....	11-53
<b>Define and Configure Variant Sources and Sinks ...</b>	<b>11-54</b>
<b>Variant Condition Propagation with Variant Sources and Sinks .....</b>	<b>11-61</b>
View Variant Condition Annotations .....	11-61
How Variant Condition Propagation Works .....	11-64
Condition Propagation with Subsystems .....	11-67
Condition Propagation with Other Simulink Blocks ..	11-68
Known Limitations .....	11-72
<b>Create and Validate Variant Configurations .....</b>	<b>11-73</b>
Step 1: Open Variant Manager .....	11-73
Step 2: Define Variant Configuration .....	11-74
Step 3: Activate and Validate Variant Configuration .	11-75
<b>Import Control Variables to Variant Configuration .</b>	<b>11-77</b>
Step 1: Open Variant Manager .....	11-77
Step 2: Import Variant Configuration .....	11-78
Step 3: View Submodel Configuration .....	11-79
<b>Define Constraints .....</b>	<b>11-81</b>
<b>Reduce Models Containing Variant Blocks .....</b>	<b>11-84</b>
Reduce Model Programmatically .....	11-91
Considerations and Limitations .....	11-92
<b>Condition Propagation with Variant Subsystem ....</b>	<b>11-93</b>
Propagate Conditions Without Generate Preprocessor Conditionals .....	11-94
Propagate Conditions with Generate Preprocessor Conditionals .....	11-96
Adaptive Interface for Variant Subsystems .....	11-98
Known Limitations .....	11-100
Propagate Conditions Programmatically .....	11-100

<b>Variants Example Models</b> .....	<b>11-102</b>
<b>Use Subsystem Variants To Generate Code That Uses C Preprocessor Conditionals</b> .....	<b>11-104</b>
<b>Propagating Variant Conditions to Subsystems</b> ...	<b>11-111</b>
<b>Variant Subsystems</b> .....	<b>11-114</b>
<b>Model Reference Variants</b> .....	<b>11-123</b>
<b>Variant Source and Variant Sink Blocks</b> .....	<b>11-128</b>
<b>Control Variant Condition Propagation</b> .....	<b>11-132</b>
<b>Propagate Variant Condition to Conditional Subsystem</b> .....	<b>11-137</b>

# 12

## Exploring, Searching, and Browsing Models

<b>Search and Edit Using Model Explorer</b> .....	<b>12-2</b>
What You Can Do Using the Model Explorer .....	<b>12-2</b>
Open the Model Explorer and Edit Object Properties ..	<b>12-3</b>
Search Bar Controls .....	<b>12-3</b>
Model Explorer Components .....	<b>12-6</b>
Add Objects to a Model, Chart, or Workspace .....	<b>12-8</b>
Focus on Specific Elements of a Model or Chart .....	<b>12-9</b>
Model Explorer: Model Hierarchy Pane .....	<b>12-10</b>
Model Explorer: Contents Pane .....	<b>12-18</b>
Organize Data Display in Model Explorer .....	<b>12-23</b>
Filter Objects in the Model Explorer .....	<b>12-31</b>
Model Explorer: Property Dialog Pane .....	<b>12-36</b>
<b>Customize Model Explorer Views</b> .....	<b>12-39</b>
Using Views .....	<b>12-39</b>
Customizing Views .....	<b>12-42</b>
Managing Views .....	<b>12-43</b>

<b>Find Model Elements in Simulink Models</b> . . . . .	12-48
Explore the Model Hierarchy Using the Model Browser . . . . .	12-48
Search for Model Elements Using Find . . . . .	12-49
Search Using Model Explorer . . . . .	12-52
<b>Model Dependency Viewer</b> . . . . .	12-56
Model Dependency Views . . . . .	12-56
View Model File and Library Dependencies . . . . .	12-59
<b>View Linked Requirements in Models and Blocks</b> . . . . .	12-61
Requirements Traceability in Simulink . . . . .	12-61
Highlight Requirements in a Model . . . . .	12-61
View Information About a Requirements Link . . . . .	12-64
Navigate to Requirements from a Model . . . . .	12-65
Filter Requirements in a Model . . . . .	12-66
<b>Trace Connections Using Interface Display</b> . . . . .	12-69
How Interface Display Works . . . . .	12-69
Trace Connections in a Subsystem . . . . .	12-69

## Managing Model Configurations

# 13

<b>About Model Configurations</b> . . . . .	13-2
<b>Multiple Configuration Sets in a Model</b> . . . . .	13-3
<b>Share a Configuration for Multiple Models</b> . . . . .	13-4
Convert an Existing Configuration Set to a Configuration Reference . . . . .	13-4
Create a Configuration Reference in Another Model . . . . .	13-4
<b>Share a Configuration Across Referenced Models</b> . . . . .	13-6
<b>Manage a Configuration Set</b> . . . . .	13-11
Create a Configuration Set in a Model . . . . .	13-11
Create a Configuration Set in the Base Workspace . . . . .	13-11
Open a Configuration Set in the Configuration Parameters Dialog Box . . . . .	13-12



Activate a Configuration Set . . . . .	13-13
Set Values in a Configuration Set . . . . .	13-13
Copy, Delete, and Move a Configuration Set . . . . .	13-13
Save a Configuration Set . . . . .	13-14
Load a Saved Configuration Set . . . . .	13-15
Copy Configuration Set Components . . . . .	13-15
Compare Configuration Sets . . . . .	13-16
<b>Manage a Configuration Reference . . . . .</b>	<b>13-18</b>
Create and Attach a Configuration Reference . . . . .	13-18
Resolve a Configuration Reference . . . . .	13-19
Activate a Configuration Reference . . . . .	13-21
Manage Configuration Reference Across Referenced Models . . . . .	13-22
Change Parameter Values in a Referenced Configuration Set . . . . .	13-23
Save a Referenced Configuration Set . . . . .	13-23
Load a Saved Referenced Configuration Set . . . . .	13-24
<b>About Configuration Sets . . . . .</b>	<b>13-25</b>
What Is a Configuration Set? . . . . .	13-25
What Is a Freestanding Configuration Set? . . . . .	13-26
<b>About Configuration References . . . . .</b>	<b>13-28</b>
What Is a Configuration Reference? . . . . .	13-28
Why Use Configuration References? . . . . .	13-28
Unresolved Configuration References . . . . .	13-29
Configuration Reference Limitations . . . . .	13-29
Configuration References for Models with Older Simulation Target Settings . . . . .	13-30
<b>Model Configuration Command Line Interface . . . . .</b>	<b>13-32</b>
Overview . . . . .	13-32
Load and Activate a Configuration Set at the Command Line . . . . .	13-33
Save a Configuration Set at the Command Line . . . . .	13-34
Create a Freestanding Configuration Set at the Command Line . . . . .	13-34
Create and Attach a Configuration Reference at the Command Line . . . . .	13-35
Attach a Configuration Reference to Multiple Models at the Command Line . . . . .	13-36
Get Values from a Referenced Configuration Set . . . . .	13-37
Change Values in a Referenced Configuration Set . . . . .	13-37

## Configuring Models for Targets with Multicore Processors

# 14

<b>Concepts in Multicore Programming . . . . .</b>	<b>14-2</b>
Basics of Multicore Programming . . . . .	14-2
Types of Parallelism . . . . .	14-3
System Partitioning for Parallelism . . . . .	14-6
Challenges in Multicore Programming . . . . .	14-7
<b>Multicore Programming with Simulink . . . . .</b>	<b>14-10</b>
Basic Workflow . . . . .	14-10
How Simulink Helps You to Overcome Challenges in Multicore Programming . . . . .	14-11
<b>Implement Data Parallelism in Simulink . . . . .</b>	<b>14-14</b>
<b>Implement Task Parallelism in Simulink . . . . .</b>	<b>14-18</b>
<b>Implement Pipelining in Simulink . . . . .</b>	<b>14-21</b>
<b>Configure Your Model for Concurrent Execution . . . . .</b>	<b>14-24</b>
<b>Specify a Target Architecture . . . . .</b>	<b>14-25</b>
Choose from Predefined Architectures . . . . .	14-25
Define a Custom Architecture File . . . . .	14-27
<b>Partition Your Model Using Explicit Partitioning . . . . .</b>	<b>14-31</b>
Prerequisites for Explicit Partitioning . . . . .	14-31
Add Periodic Triggers and Tasks . . . . .	14-31
Add Aperiodic Triggers and Tasks . . . . .	14-32
Map Blocks to Tasks, Triggers, and Nodes . . . . .	14-34
<b>Implicit and Explicit Partitioning of Models . . . . .</b>	<b>14-37</b>
Partitioning Guidelines . . . . .	14-37
<b>Configure Data Transfer Settings Between Concurrent     Tasks . . . . .</b>	<b>14-40</b>

<b>Optimize and Deploy on a Multicore Target</b> . . . . .	14-44
Generate Code . . . . .	14-44
Build on Desktop . . . . .	14-45
Profile and Evaluate on a Desktop . . . . .	14-47
Customize the Generated C Code . . . . .	14-51
<b>Concurrent Execution Models</b> . . . . .	14-52
<b>Programmatic Interface for Concurrent Execution</b> .	14-53
Map Blocks to Tasks . . . . .	14-53
<b>Supported Targets For Multicore Programming</b> . . . .	14-55
Supported Multicore Targets . . . . .	14-55
Supported Heterogeneous Targets . . . . .	14-55
<b>Limitations with Multicore Programming in Simulink</b> . . . . .	14-57

## Modeling Best Practices

# 15

<b>General Considerations when Building Simulink Models</b> . . . . .	15-2
Avoiding Invalid Loops . . . . .	15-2
Shadowed Files . . . . .	15-4
Model Building Tips . . . . .	15-6
<b>Model a Continuous System</b> . . . . .	15-8
<b>Best-Form Mathematical Models</b> . . . . .	15-11
Series RLC Example . . . . .	15-11
Solving Series RLC Using Resistor Voltage . . . . .	15-12
Solving Series RLC Using Inductor Voltage . . . . .	15-13
<b>Model a Simple Equation</b> . . . . .	15-15
<b>Model Differential Algebraic Equations</b> . . . . .	15-17
Overview of Robertson Reaction Example . . . . .	15-17
Simulink Model from ODE Equations . . . . .	15-17
Simulink Model from DAE Equations . . . . .	15-20

Simulink Model from DAE Equations Using Algebraic Constraint Block .....	15-23
<b>Componentization Guidelines .....</b>	<b>15-29</b>
Componentization .....	15-29
Componentization Techniques .....	15-29
General Componentization Guidelines .....	15-30
Summary of Componentization Techniques .....	15-31
Subsystems Summary .....	15-32
Libraries Summary .....	15-36
Model Referencing Summary .....	15-39
<b>Model Complex Logic .....</b>	<b>15-46</b>
<b>Model Physical Systems .....</b>	<b>15-47</b>
<b>Model Signal Processing Systems .....</b>	<b>15-48</b>

## Simulink Project Setup

# 16

<b>Organize Large Modeling Projects .....</b>	<b>16-2</b>
<b>What Are Simulink Projects? .....</b>	<b>16-3</b>
<b>Explore Simulink Project Tools with the Airframe</b>	
<b>Project .....</b>	<b>16-5</b>
Explore the Airframe Project .....	16-5
Set Up Project Files and Open Simulink Project .....	16-6
View, Search, and Sort Project Files .....	16-6
Understand Project Startup and Shutdown Tasks .....	16-7
Create a Startup Shortcut .....	16-9
Open and Run Frequently Used Files .....	16-9
Review Changes in Modified Files .....	16-10
Run Project Integrity Checks .....	16-11
Run Dependency Analysis .....	16-11
Commit Modified Files .....	16-14
View Project and Source Control Information .....	16-14
<b>Create a Project from a Model .....</b>	<b>16-16</b>

<b>Create a New Project to Manage Existing Files . . . . .</b>	<b>16-18</b>
<b>Add Files to the Project . . . . .</b>	<b>16-20</b>
<b>Create a New Project from an Archived Project . . . . .</b>	<b>16-22</b>
<b>Create a New Project Using Templates . . . . .</b>	<b>16-23</b>
Use Project Templates from R2014a or Before . . . . .	<b>16-23</b>
<b>Open Recent Projects . . . . .</b>	<b>16-24</b>
<b>Change the Project Name, Root, Description, and Startup Folder . . . . .</b>	<b>16-26</b>
<b>Specify Project Path . . . . .</b>	<b>16-27</b>
<b>What Can You Do With Project Shortcuts? . . . . .</b>	<b>16-29</b>
<b>Automate Startup Tasks with Shortcuts . . . . .</b>	<b>16-30</b>
<b>Automate Shutdown Tasks with Shortcuts . . . . .</b>	<b>16-32</b>
<b>Create Shortcuts to Frequent Tasks . . . . .</b>	<b>16-34</b>
Create Shortcuts . . . . .	<b>16-34</b>
Group Shortcuts . . . . .	<b>16-35</b>
Annotate Shortcuts to Use Meaningful Names . . . . .	<b>16-36</b>
Customize Shortcut Icons . . . . .	<b>16-37</b>
<b>Use Shortcuts to Find and Run Frequent Tasks . . . . .</b>	<b>16-38</b>
<b>Create Templates for Standard Project Settings . . . . .</b>	<b>16-41</b>
Using Templates to Create Standard Project Settings	<b>16-41</b>
Create a Template from the Current Project . . . . .	<b>16-41</b>
Create a Template from a Project Under Version Control . . . . .	<b>16-42</b>
Edit a Template . . . . .	<b>16-42</b>
Explore the Example Templates . . . . .	<b>16-43</b>

<b>Group and Sort File Views</b> .....	17-2
<b>Search Inside Project Files and Filter File Views</b> ....	17-4
Project-Wide Search .....	17-4
Filter Project File Views .....	17-6
More Ways to Search .....	17-7
<b>Work with Project Files</b> .....	17-8
<b>Manage Shadowed and Dirty Model Files</b> .....	17-10
Identify Shadowed Project Files When Opening a Project .....	17-10
Find Models and MATLAB Files With Unsaved Changes .....	17-11
Manage Open Models When Closing a Project .....	17-11
<b>Move, Rename, Copy, or Delete Project Files</b> .....	17-12
Move or Add Files .....	17-12
Automatic Updates When Renaming, Deleting, or Removing Files .....	17-12
<b>Back Out Changes</b> .....	17-17
<b>Upgrade Model Files to SLX and Preserve Revision History</b> .....	17-18
Project Tools for Migrating Model Files to SLX .....	17-18
Upgrade the Model and Commit the Changes .....	17-18
Verify Changes After Upgrade to SLX .....	17-21
<b>Create Labels</b> .....	17-24
<b>Add Labels to Files</b> .....	17-25
<b>View and Edit Label Data</b> .....	17-26
<b>Automate Simulink Project Tasks Using Scripts</b> ....	17-28
<b>Create a Custom Task Function</b> .....	17-41

<b>Create Shortcuts to Custom Task Job Functions . . . .</b>	<b>17-42</b>
<b>Run a Simulink Project Custom Task and Publish Report . . . . .</b>	<b>17-43</b>
<b>Sharing Simulink Projects . . . . .</b>	<b>17-47</b>
<b>Share Project by Email . . . . .</b>	<b>17-49</b>
<b>Share Project as a MATLAB Toolbox . . . . .</b>	<b>17-50</b>
<b>Share Project on GitHub . . . . .</b>	<b>17-51</b>
<b>Archive Projects in Zip Files . . . . .</b>	<b>17-53</b>
<b>Upgrade All Project Models . . . . .</b>	<b>17-55</b>

## Simulink Project Dependency Analysis

# 18

<b>What Is Dependency Analysis? . . . . .</b>	<b>18-2</b>
Project Dependency Analysis . . . . .	18-2
Model Dependency Analysis . . . . .	18-3
<b>Run Dependency Analysis . . . . .</b>	<b>18-4</b>
<b>Perform Impact Analysis . . . . .</b>	<b>18-7</b>
About Impact Analysis . . . . .	18-7
Run Dependency Analysis . . . . .	18-7
Find Required Toolboxes . . . . .	18-9
Find Dependencies of Selected Files . . . . .	18-12
Select, Edit, and Export File Dependencies . . . . .	18-13
<b>Check Dependency Results and Resolve Problems . .</b>	<b>18-17</b>
Investigate Problem Files in Impact View . . . . .	18-20
Investigate Problem Files in Table View . . . . .	18-21
<b>Find Requirements Documents in a Project . . . . .</b>	<b>18-22</b>

<b>Save, Open, and Compare Dependency Analysis</b>	
<b>Results</b> . . . . .	18-23
Export Impact Graph Results to Files or Images . . . . .	18-23
<b>Analyze Model Dependencies</b> . . . . .	18-25
What Are Model Dependencies? . . . . .	18-25
Generate Manifests . . . . .	18-26
Command-Line Dependency Analysis . . . . .	18-31
Edit Manifests . . . . .	18-34
Compare Manifests . . . . .	18-37
Export Files in a Manifest . . . . .	18-38
Scope of Dependency Analysis . . . . .	18-40
Best Practices for Dependency Analysis . . . . .	18-43
Use the Model Manifest Report . . . . .	18-44

## Simulink Project Source Control

# 19

<b>About Source Control with Projects</b> . . . . .	19-2
Classic and Distributed Source Control . . . . .	19-3
<b>Add a Project to Source Control</b> . . . . .	19-6
Add a Project to Git Source Control . . . . .	19-6
Add a Project to SVN Source Control . . . . .	19-7
<b>Register Model Files with Source Control Tools</b> . . . . .	19-10
<b>Set Up SVN Source Control</b> . . . . .	19-11
Set Up SVN Integration Provided with Simulink Project . . . . .	19-11
Set Up SVN Integration for SVN Version Already Installed . . . . .	19-12
Set Up SVN Integration for SVN Version Not Yet Provided with Simulink Project . . . . .	19-12
Register Model Files with Subversion . . . . .	19-13
Enforce SVN Locking Model Files Before Editing . . . . .	19-16
Share a Subversion Repository . . . . .	19-17
Manage SVN Externals . . . . .	19-18



<b>Set Up Git Source Control</b> .....	<b>19-20</b>
About Git Source Control .....	19-20
Use Git Source Control in Simulink Project .....	19-21
Install Command-Line Git Client .....	19-22
Register Model Files with Git .....	19-23
Add Git Submodules .....	19-24
<b>Disable Source Control</b> .....	<b>19-26</b>
<b>Change Source Control</b> .....	<b>19-27</b>
<b>Write a Source Control Integration with the SDK</b> ...	<b>19-28</b>
<b>Retrieve a Working Copy of a Project from Source Control</b> .....	<b>19-29</b>
Troubleshooting .....	19-32
<b>Tag and Retrieve Versions of Project Files</b> .....	<b>19-34</b>
<b>Refresh Status of Project Files</b> .....	<b>19-36</b>
<b>Check for Modifications</b> .....	<b>19-37</b>
<b>Update Revisions of Project Files</b> .....	<b>19-38</b>
Update Revisions with SVN .....	19-38
Update Revisions with Git .....	19-38
Update Selected Files .....	19-39
<b>Get SVN File Locks</b> .....	<b>19-40</b>
<b>View Modified Files</b> .....	<b>19-41</b>
Project Definition Files .....	19-42
<b>Compare Revisions</b> .....	<b>19-44</b>
<b>Run Project Checks</b> .....	<b>19-47</b>
<b>Commit Modified Files to Source Control</b> .....	<b>19-49</b>
<b>Revert Changes</b> .....	<b>19-51</b>
Discard Local Changes .....	19-51
Revert a File to a Specified Revision .....	19-51
Revert the Project to a Specified Revision .....	19-52

<b>Pull, Push, and Fetch Files with Git</b> .....	<b>19-54</b>
Pull and Push .....	19-54
Pull, Fetch, and Merge .....	19-55
Push Empty Folders .....	19-58
<b>Branch and Merge Files with Git</b> .....	<b>19-59</b>
Create a Branch .....	19-59
Switch Branch .....	19-61
Merge Branches .....	19-61
Revert to Head .....	19-62
Delete Branches .....	19-62
<b>Resolve Conflicts</b> .....	<b>19-64</b>
Resolve Conflicts .....	19-64
Merge Text Files .....	19-66
Merge Models .....	19-67
Extract Conflict Markers .....	19-67
<b>Work with Derived Files in Projects</b> .....	<b>19-69</b>
<b>Customize External Source Control to Use MATLAB for Diff and Merge</b> .....	<b>19-70</b>

## Project Reference

# 20

<b>Componentization Using Referenced Projects</b> .....	<b>20-2</b>
<b>Add or Remove a Reference to Another Project</b> .....	<b>20-5</b>
<b>View or Run Referenced Project Files</b> .....	<b>20-7</b>
<b>Open a Referenced Project</b> .....	<b>20-8</b>
<b>Extract a Folder to Create a Referenced Project</b> .....	<b>20-9</b>
<b>Manage Referenced Project Changes Using Checkpoints</b> .....	<b>20-11</b>

<b>Design Partitioning</b> .....	21-2
When to Partition a Design .....	21-2
When Not to Partition a Design .....	21-3
Plan for Componentization in Model Design .....	21-4
Guidelines for Component Size and Functionality .....	21-4
Choose Components for Team-Based Development .....	21-8
Partition an Existing Design .....	21-10
Manage Components Using Libraries .....	21-11
<b>Interface Design</b> .....	21-13
Why Interface Definitions Are Important .....	21-13
Recommendations for Interface Design .....	21-13
Partitioning Data .....	21-15
Configure Data Interface for Component .....	21-15
<b>Configuration Management</b> .....	21-18
Manage Designs Using Source Control .....	21-18
Determine the Files Used by a Component .....	21-19
Manage Model Versions .....	21-19
Create Configurations .....	21-20

<b>Power Window</b> .....	22-2
Study Power Windows .....	22-2
MathWorks Software Used in This Example .....	22-3
Quantitative Requirements .....	22-4
Simulink Power Window Controller in Simulink Project .....	22-13
Simulink Power Window Controller .....	22-15
Create Model Using Model-Based Design .....	22-34
Automatic Code Generation for Control Subsystem ..	22-56
References .....	22-57

<b>Simulate a Model Interactively</b> .....	<b>23-2</b>
Simulation Basics .....	23-2
Run, Pause, and Stop a Simulation .....	23-3
Use Blocks to Stop or Pause a Simulation .....	23-3
<b>Specify Simulation Start and Stop Time</b> .....	<b>23-6</b>
<b>About Solvers</b> .....	<b>23-7</b>
<b>Choose a Solver</b> .....	<b>23-9</b>
Solver Classification Criteria .....	23-11
Choose a Fixed-Step Solver .....	23-15
Choose a Variable-Step Solver .....	23-20
Choose a Jacobian Method for an Implicit Solver .....	23-27
<b>Use Auto Solver to Select a Solver</b> .....	<b>23-34</b>
Use Auto Solver with vdp Model .....	23-34
Auto Solver Heuristics .....	23-35
<b>Save and Restore Simulation State as SimState</b> .....	<b>23-37</b>
SimState and Repetitive Simulations .....	23-37
Information Saved in a SimState .....	23-38
Benefits of Using SimState .....	23-38
When You Can Save a SimState .....	23-39
Save SimState .....	23-39
Restore SimState .....	23-40
Change the States of a Block Within SimState .....	23-41
S-Functions .....	23-41
Model Changes and SimState .....	23-41
Limitations of SimState .....	23-42
<b>View Diagnostics</b> .....	<b>23-45</b>
Toolbar .....	23-46
Diagnostic Message Pane .....	23-46
Suppress Warnings .....	23-47

Suggested Actions . . . . .	23-48
<b>Systematic Diagnosis of Errors and Warnings . . . . .</b>	<b>23-51</b>
<b>Suppress Diagnostic Messages Programmatically . . .</b>	<b>23-56</b>
Suppress Diagnostic Messages Programmatically . . .	23-56
Suppress Diagnostic Messages of a Referenced Model	23-61
<b>Customize Diagnostic Messages . . . . .</b>	<b>23-65</b>
Display Custom Text . . . . .	23-65
Create Hyperlinks to Files, Folders, or Blocks . . . . .	23-66
Create Programmatic Hyperlinks . . . . .	23-66
<b>Report Diagnostic Messages Programmatically . . . . .</b>	<b>23-68</b>
Create Diagnostic Stages . . . . .	23-68
Report Diagnostic Messages . . . . .	23-69
Log Diagnostic Messages . . . . .	23-70

## Running a Simulation Programmatically

# 24

<b>Run Simulations Programmatically . . . . .</b>	<b>24-2</b>
Specify Parameter Name-Value Pairs . . . . .	24-2
Specify a Configuration Set . . . . .	24-3
Enable Simulation Timeouts . . . . .	24-4
Capture Simulation Errors . . . . .	24-4
Access Simulation Metadata . . . . .	24-5
<b>Control Simulations Programmatically . . . . .</b>	<b>24-8</b>
Control and Check Status of Simulation . . . . .	24-8
Automate Simulation Tasks Using Block Callbacks . . .	24-9
<b>Run Parallel Simulations . . . . .</b>	<b>24-11</b>
Overview of Calling sim from Within parfor . . . . .	24-11
Simulink and Parallel Computing Toolbox Software .	24-15
Simulink and MATLAB Distributed Computing Server	
Software . . . . .	24-16
sim in parfor with Normal Mode . . . . .	24-16
sim in parfor with Normal Mode and MATLAB	
Distributed Computing Server Software . . . . .	24-18

sim in parfor with Rapid Accelerator Mode . . . . .	24-19
Workspace Access Issues . . . . .	24-21
Resolving Workspace Access Issues . . . . .	24-21
Data Concurrency Issues . . . . .	24-24
Resolving Data Concurrency Issues . . . . .	24-25
<b>Error Handling in Simulink Using MSLErrorException . .</b>	<b>24-28</b>
Error Reporting in a Simulink Application . . . . .	24-28
The MSLErrorException Class . . . . .	24-28
Methods of the MSLErrorException Class . . . . .	24-28
Capturing Information about the Error . . . . .	24-28

## Multiple Simulations

# 25

<b>Run Multiple Simulations . . . . .</b>	<b>25-2</b>
Overview . . . . .	25-2
Other Advantages . . . . .	25-3
Data Logging For Multiple Simulations . . . . .	25-3
<b>Example of Parallel Simulations Workflow . . . . .</b>	<b>25-5</b>

## Visualizing and Comparing Simulation Results

# 26

<b>Prototype and Debug Models with Scopes . . . . .</b>	<b>26-2</b>
<b>Scope Blocks and Scope Viewer Overview . . . . .</b>	<b>26-8</b>
Overview of Methods . . . . .	26-8
Simulink Scope Versus Floating Scope . . . . .	26-9
Simulink Scope Versus DSP System Toolbox Time Scope . . . . .	26-11
<b>Debugging a Model with Scope Blocks . . . . .</b>	<b>26-14</b>
<b>Scope Trace Selection Panel . . . . .</b>	<b>26-15</b>

<b>Scope Triggers Panel</b> .....	<b>26-16</b>
What Is the Trigger Panel .....	26-16
Main Pane .....	26-17
Source/Type and Levels/Timing Panes .....	26-17
Hysteresis of Trigger Signals .....	26-27
Delay/Holdoff Pane .....	26-28
<b>Scope Cursor Measurements Panel</b> .....	<b>26-30</b>
Settings Pane .....	26-30
Measurements Pane .....	26-31
<b>Scope Signal Statistics Panel</b> .....	<b>26-33</b>
<b>Scope Bilevel Measurements Panel</b> .....	<b>26-35</b>
Settings .....	26-35
Transitions Pane .....	26-38
Overshoots / Undershoots Pane .....	26-42
Cycles Pane .....	26-45
<b>Scope Peak Finder Panel</b> .....	<b>26-49</b>
Settings Pane .....	26-49
Peaks Pane .....	26-51
<b>Scope Tasks</b> .....	<b>26-54</b>
Add Scope Block to Model .....	26-54
Connect Signals to Scope Block .....	26-54
Save Simulation Data Using a Scope Block .....	26-56
Share Scope Image .....	26-58
Plot an Array of Signals .....	26-60
Scopes Within an Enabled Subsystem .....	26-61
Show Signal Units on a Scope Display .....	26-62
Select Number of Displays and Layout .....	26-66
Dock and Undock Scope Window to MATLAB Desktop .....	26-67
<b>Floating Scope and Scope Viewer Tasks</b> .....	<b>26-69</b>
Add Floating Scope Block to Model .....	26-69
Add Scope Viewer with Signal & Scope Manager .....	26-69
Connect Signals to Floating Scope Block or Scope Viewer .....	26-70
Save Simulation Data Using Floating Scope Block .....	26-71
Run Simulation from Floating Scope Window .....	26-73
Delete Scope Viewer .....	26-73
View Signals on a Floating Scope Quickly .....	26-73

Connect Scope Viewers Without Using Signal Selector	26-73
<b>Signal Generator Tasks</b> .....	<b>26-75</b>
Attach Signal Generator .....	26-75
Attach and Remove Signal Generator .....	26-75
<b>Signal and Scope Manager</b> .....	<b>26-77</b>
About the Signal & Scope Manager .....	26-77
Change Scope Viewer Parameters .....	26-78
Connect Viewers and Generators .....	26-78
View Test Point Data .....	26-78
Customize Signal & Scope Manager .....	26-79
<b>Signal Selector</b> .....	<b>26-81</b>
About the Signal Selector .....	26-81
Select Signals .....	26-82
Model Hierarchy .....	26-82
Inputs/Signals List .....	26-82
<b>Control Scopes Programmatically</b> .....	<b>26-85</b>
Use Simulink Configuration Object .....	26-85
Scope Configuration Properties .....	26-87

## Inspecting and Comparing Simulation Data

# 27

<b>Simulation Data Inspector in Your Workflow</b> .....	<b>27-2</b>
<b>Open the Simulation Data Inspector</b> .....	<b>27-4</b>
Why Is the Simulation Data Inspector Empty? .....	27-4
<b>Log Signals to the Simulation Data Inspector</b> .....	<b>27-6</b>
Iterate Model Design with the Simulation Data Inspector .....	27-7
<b>Record Data with the Simulation Data Inspector</b> . . .	<b>27-10</b>
Configure Your Model to Record Data .....	27-10
Record a Run .....	27-11
<b>Import Data</b> .....	<b>27-12</b>



<b>Share Simulation Data Inspector Data and Views . . .</b>	<b>27-14</b>
Save and Load Simulation Data Inspector Sessions . .	27-14
Export Data from the Simulation Data Inspector . . . .	27-15
Share Simulation Data Inspector Data Views . . . . .	27-16
Create Images of Plots . . . . .	27-16
Create MATLAB Figures . . . . .	27-17
<b>Inspect Simulation Data . . . . .</b>	<b>27-18</b>
Log and View Signals . . . . .	27-18
Explore Simulation Data . . . . .	27-19
View Signals on Multiple Plots . . . . .	27-21
Filter Runs and Signals . . . . .	27-24
Inspect Event-Based Data . . . . .	27-26
<b>Compare Simulation Data . . . . .</b>	<b>27-27</b>
Compare Signals . . . . .	27-27
Compare Runs . . . . .	27-30
<b>Create A Simulation Data Inspector Report . . . . .</b>	<b>27-33</b>
<b>How the Simulation Data Inspector Compares Data . .</b>	<b>27-35</b>
Signal Alignment in the Simulation Data Inspector . .	27-35
Synchronization Options in the Simulation Data Inspector . . . . .	27-37
Interpolation Options in the Simulation Data Inspector . . . . .	27-37
Tolerances in the Simulation Data Inspector . . . . .	27-37
<b>Run Management and Configuration . . . . .</b>	<b>27-39</b>
Append New Runs . . . . .	27-39
Specify a Run Naming Rule . . . . .	27-39
Overwrite a Run . . . . .	27-40
<b>Customize the Simulation Data Inspector Interface . .</b>	<b>27-41</b>
Modify the Simulation Data Inspector Layout . . . . .	27-41
Modify Displayed Properties . . . . .	27-41
View Signal and Run Properties . . . . .	27-45
Rename a Run . . . . .	27-49
Modify Grouping in Inspect Pane . . . . .	27-49
Modify Signal Alignment for Comparisons . . . . .	27-51
Specify Colors and Style . . . . .	27-52
Modify Logged Signal Properties . . . . .	27-53
Modify a Plot in the Simulation Data Inspector . . . . .	27-54

<b>Limitations of the Simulation Data Inspector</b> . . . . .	<b>27-57</b>
<b>Inspect and Compare Data Programmatically</b> . . . . .	<b>27-58</b>
Create a Run from Workspace Variables . . . . .	27-58
Compare Signals Programmatically . . . . .	27-58
Compare Runs of Simulation Data . . . . .	27-59
Analyze Simulation Data with Signal Tolerances . . . . .	27-59
Generate a Report from the Simulation Data	
Inspector . . . . .	27-61
Clear All Logged Signals . . . . .	27-61
<b>Keyboard Shortcuts for the Simulation Data</b>	
<b>Inspector</b> . . . . .	<b>27-63</b>
General Actions . . . . .	27-63
Plot Zooming . . . . .	27-63
Data Cursors . . . . .	27-64
Import Dialog Box . . . . .	27-64
<b>Tune and Visualize Your Model with Dashboard</b>	
<b>Blocks</b> . . . . .	<b>27-65</b>
Explore Connections Within the Model . . . . .	27-65
Simulate Changing Model States . . . . .	27-67
View Signal Data . . . . .	27-67
Tune Parameters During Simulation . . . . .	27-69

## Analyzing Simulation Results

# 28

<b>Decide How to Visualize Simulation Data</b> . . . . .	<b>28-2</b>
Visualizing Simulation Data . . . . .	28-2
Port Value Displays . . . . .	28-2
Scope Blocks and Scope Viewers . . . . .	28-3
Simulation Data Inspector . . . . .	28-4
Dashboard Controls and Displays . . . . .	28-6
Outport Block . . . . .	28-7
To Workspace Block . . . . .	28-7
Signal Logging Without Blocks . . . . .	28-8
<b>Linearizing Models</b> . . . . .	<b>28-9</b>
About Linearizing Models . . . . .	28-9

Linearization with Referenced Models .....	28-11
Linearization Using the 'v5' Algorithm .....	28-13
<b>Finding Steady-State Points .....</b>	<b>28-14</b>

## Improving Simulation Performance and Accuracy

# 29

<b>How Optimization Techniques Improve Performance and Accuracy .....</b>	<b>29-2</b>
<b>Speed Up Simulation .....</b>	<b>29-3</b>
<b>How Profiler Captures Performance Data .....</b>	<b>29-5</b>
How Profiler Works .....	29-5
Start Profiler .....	29-7
Save Profiler Results .....	29-10
<b>Check and Improve Simulation Accuracy .....</b>	<b>29-11</b>
Check Simulation Accuracy .....	29-11
Unstable Simulation Results .....	29-11
Inaccurate Simulation Results .....	29-11
<b>Modeling Techniques That Improve Performance ...</b>	<b>29-13</b>
Accelerate the Initialization Phase .....	29-13
Reduce Model Interactivity .....	29-14
Reduce Model Complexity .....	29-15
Choose and Configure a Solver .....	29-16
Save the Simulation State .....	29-18
<b>Use Performance Advisor to Improve Simulation Efficiency .....</b>	<b>29-20</b>

<b>Improve Simulation Performance Using Performance Advisor</b> .....	<b>30-2</b>
Performance Advisor Workflow .....	30-2
Prepare Your Model .....	30-3
Create a Performance Advisor Baseline Measurement .....	30-5
Run Performance Advisor Checks .....	30-6
View and Respond to Results .....	30-8
View and Save Performance Advisor Reports .....	30-11
<b>Perform a Quick Scan Diagnosis</b> .....	<b>30-14</b>
Run Quick Scan on a Model .....	30-14
Checks in Quick Scan Mode .....	30-14
<b>Improve vdp Model Performance</b> .....	<b>30-16</b>
Enable Data Logging for the Model .....	30-16
Create Baseline .....	30-16
Select Checks and Run .....	30-17
Review Results .....	30-18
Apply Advice and Validate Manually .....	30-20
<b>Performance Advisor Window</b> .....	<b>30-22</b>

<b>Examine Model Dynamics Using Solver Profiler</b> .....	<b>31-2</b>
<b>Understand Profiling Results</b> .....	<b>31-6</b>
Zero-Crossing Events .....	31-6
Tolerance-Exceeding Events .....	31-9
Newton Iteration Failures .....	31-12
Differential Algebraic Equation Failures .....	31-14
Jacobian Logging and Analysis .....	31-17
<b>Modify Solver Profiler Rules</b> .....	<b>31-19</b>
Change Thresholds of Profiler Rules .....	31-19

Develop Profiler Rule Set .....	31-20
<b>Customize State Ranking .....</b>	<b>31-22</b>
<b>Solver Profiler Interface .....</b>	<b>31-25</b>
Statistics Pane .....	31-26
Suggestions and Exceptions Pane .....	31-26

## Simulink Debugger

# 32

<b>Introduction to the Debugger .....</b>	<b>32-2</b>
<b>Debugger Graphical User Interface .....</b>	<b>32-3</b>
Displaying the Graphical Interface .....	32-3
Toolbar .....	32-4
Breakpoints Pane .....	32-5
Simulation Loop Pane .....	32-5
Outputs Pane .....	32-7
Sorted List Pane .....	32-7
Status Pane .....	32-8
<b>Debugger Command-Line Interface .....</b>	<b>32-10</b>
Controlling the Debugger .....	32-10
Method ID .....	32-10
Block ID .....	32-10
Accessing the MATLAB Workspace .....	32-11
<b>Debugger Online Help .....</b>	<b>32-12</b>
<b>Start the Simulink Debugger .....</b>	<b>32-13</b>
Starting from a Model Window .....	32-13
Starting from the Command Window .....	32-13
<b>Start a Simulation .....</b>	<b>32-15</b>
<b>Run a Simulation Step by Step .....</b>	<b>32-18</b>
Introduction .....	32-18
Block Data Output .....	32-19
Stepping Commands .....	32-20

Continuing a Simulation .....	32-21
Running a Simulation Nonstop .....	32-21
<b>Set Breakpoints .....</b>	<b>32-23</b>
About Breakpoints .....	32-23
Setting Unconditional Breakpoints .....	32-23
Setting Conditional Breakpoints .....	32-25
<b>Display Information About the Simulation .....</b>	<b>32-29</b>
Display Block I/O .....	32-29
Display Algebraic Loop Information .....	32-31
Display System States .....	32-31
Display Solver Information .....	32-32
<b>Display Information About the Model .....</b>	<b>32-34</b>
Display Model's Sorted Lists .....	32-34
Display a Block .....	32-35

## Accelerating Models

# 33

<b>What Is Acceleration? .....</b>	<b>33-2</b>
<b>How Acceleration Modes Work .....</b>	<b>33-4</b>
Overview .....	33-4
Normal Mode .....	33-4
Accelerator Mode .....	33-5
Rapid Accelerator Mode .....	33-7
<b>Code Regeneration in Accelerated Models .....</b>	<b>33-9</b>
Determine If the Simulation Will Rebuild .....	33-9
Parameter Tuning in Rapid Accelerator Mode .....	33-9
<b>Choosing a Simulation Mode .....</b>	<b>33-12</b>
Simulation Mode Tradeoffs .....	33-12
Comparing Modes .....	33-13
Decision Tree .....	33-15
<b>Design Your Model for Effective Acceleration .....</b>	<b>33-18</b>
Select Blocks for Accelerator Mode .....	33-18

Select Blocks for Rapid Accelerator Mode . . . . .	33-19
Control S-Function Execution . . . . .	33-19
Accelerator and Rapid Accelerator Mode Data Type Considerations . . . . .	33-20
Behavior of Scopes and Viewers with Rapid Accelerator Mode . . . . .	33-21
Factors Inhibiting Acceleration . . . . .	33-22
<b>Perform Acceleration . . . . .</b>	<b>33-25</b>
Customize the Build Process . . . . .	33-25
Run Acceleration Mode from the User Interface . . . . .	33-25
Making Run-Time Changes . . . . .	33-27
<b>Interact with the Acceleration Modes</b>	
<b>Programmatically . . . . .</b>	<b>33-29</b>
Why Interact Programmatically? . . . . .	33-29
Build JIT Accelerated Execution Engine . . . . .	33-29
Control Simulation . . . . .	33-29
Simulate Your Model . . . . .	33-30
Customize the Acceleration Build Process . . . . .	33-31
<b>Run Accelerator Mode with the Simulink Debugger . . . . .</b>	<b>33-33</b>
Advantages of Using Accelerator Mode with the Debugger . . . . .	33-33
How to Run the Debugger . . . . .	33-33
When to Switch Back to Normal Mode . . . . .	33-33
<b>Comparing Performance . . . . .</b>	<b>33-35</b>
Performance of the Simulation Modes . . . . .	33-35
Measure Performance . . . . .	33-37
<b>How to Improve Performance in Acceleration Modes</b>	<b>33-39</b>
Techniques . . . . .	33-39
C Compilers . . . . .	33-39

<b>Nonvirtual and Virtual Blocks</b> .....	<b>34-2</b>
<b>Specify Block Properties</b> .....	<b>34-4</b>
Set Block Annotation Properties .....	<b>34-4</b>
Specify Block Callbacks .....	<b>34-5</b>
Specify Block Execution Priority and Tag .....	<b>34-5</b>
Use Block Description to Identify a Block .....	<b>34-6</b>
Create Block Annotations Programmatically .....	<b>34-6</b>
<b>Adjust Visual Presentation to Improve Model</b>	
<b>Readability</b> .....	<b>34-8</b>
Flip or Rotate a Block .....	<b>34-8</b>
Move and Hide Block Names .....	<b>34-10</b>
Specify Model Colors .....	<b>34-10</b>
Specify Fonts in Models .....	<b>34-11</b>
Increase Drop Shadow Depth .....	<b>34-12</b>
Box and Label Areas of a Model .....	<b>34-12</b>
Copy Formatting Between Model Elements .....	<b>34-14</b>
<b>Display Port Values for Debugging</b> .....	<b>34-16</b>
Display Port Values for Easy Debugging .....	<b>34-16</b>
Display Value for a Specific Port .....	<b>34-20</b>
Display Port Values for a Model .....	<b>34-23</b>
Port Value Display Limitations .....	<b>34-24</b>
<b>Control and Display the Sorted Order</b> .....	<b>34-27</b>
What Is Sorted Order? .....	<b>34-27</b>
Display the Sorted Order .....	<b>34-27</b>
Sorted Order Notation .....	<b>34-28</b>
How Simulink Determines the Sorted Order .....	<b>34-38</b>
Assign Block Priorities .....	<b>34-41</b>
Rules for Block Priorities .....	<b>34-41</b>
Block Priority Violations .....	<b>34-44</b>



<b>Access Block Data During Simulation</b> .....	<b>34-46</b>
About Block Run-Time Objects .....	<b>34-46</b>
Access a Run-Time Object .....	<b>34-46</b>
Listen for Method Execution Events .....	<b>34-47</b>
Synchronizing Run-Time Objects and Simulink Execution .....	<b>34-48</b>

## Working with Block Parameters

# 35

<b>Set Block Parameter Values</b> .....	<b>35-2</b>
Programmatically Access Parameter Values .....	<b>35-2</b>
Specify Parameter Values .....	<b>35-3</b>
Considerations for Other Modeling Goals .....	<b>35-8</b>
<b>Share and Reuse Block Parameter Values by Creating Variables</b> .....	<b>35-11</b>
Reuse Parameter Values in Multiple Blocks and Models .....	<b>35-11</b>
Define a System Constant .....	<b>35-12</b>
Control Scope of Parameter Values .....	<b>35-12</b>
Permanently Store Workspace Variables .....	<b>35-13</b>
Manage and Edit Workspace Variables .....	<b>35-15</b>
Package Shared Breakpoint and Table Data for Lookup Tables .....	<b>35-16</b>
<b>Parameter Interfaces for Reusable Components</b> ....	<b>35-20</b>
Referenced Models .....	<b>35-20</b>
Subsystems .....	<b>35-21</b>
<b>Organize Related Block Parameter Definitions in Structures</b> .....	<b>35-22</b>
Create and Use Parameter Structure .....	<b>35-22</b>
Store Data Type Information in Field Values .....	<b>35-24</b>
Control Field Data Types and Characteristics by Creating Parameter Object .....	<b>35-24</b>
Manage Structure Variables .....	<b>35-27</b>
Define Parameter Hierarchy by Creating Nested Structures .....	<b>35-27</b>
Group Multiple Parameter Structures into an Array .	<b>35-28</b>

Create a Structure of Constant-Valued Signals . . . . .	35-32
Considerations Before Migrating to Parameter Structures . . . . .	35-33
Combine Existing Parameter Objects Into a Structure	35-33
Parameter Structures in the Generated Code . . . . .	35-35
Parameter Structure Limitations . . . . .	35-35
Package Shared Breakpoint and Table Data for Lookup Tables . . . . .	35-36
Create Parameter Structure According to Structure Type from Existing C Code . . . . .	35-36
<b>Tune and Experiment with Block Parameter Values</b>	<b>35-38</b>
Iteratively Adjust Block Parameter Value Between Simulation Runs . . . . .	35-38
Tune Block Parameter Value During Simulation . . . . .	35-40
Prepare for Parameter Tuning and Experimentation . . . . .	35-41
Interactively Tune Using Dashboard Blocks . . . . .	35-42
Which Block Parameters Are Tunable During Simulation? . . . . .	35-43
Why Did the Simulation Output Stay the Same? . . . . .	35-44
Tunability Considerations for Other Modeling Goals . . . . .	35-45
<b>Manage Variables from Block Parameters</b> . . . . .	<b>35-47</b>
Rename Variable . . . . .	35-47
Edit Variable Value or Property . . . . .	35-48
Navigate to Mask Parameter . . . . .	35-48
Create Variable . . . . .	35-48
<b>Optimize, Estimate, and Sweep Block Parameter Values</b> . . . . .	<b>35-50</b>
Sweep Parameter Value and Inspect Simulation Results . . . . .	35-50
Store Sweep Values in Simulink.SimulationInput Objects . . . . .	35-53
Capture and Visualize Simulation Results . . . . .	35-54
Improve Simulation Speed . . . . .	35-55
Sweep Parameter Values to Test and Verify System . . . . .	35-55
Estimate and Calibrate Model Parameters . . . . .	35-55
Tune and Optimize PID and Controller Parameters . . . . .	35-56
<b>Control Block Parameter Data Types</b> . . . . .	<b>35-57</b>
Reduce Maintenance Effort with Data Type Inheritance . . . . .	35-57

Techniques to Explicitly Specify Parameter Data Types .....	35-58
Calculate Best-Precision Fixed-Point Scaling for Tunable Block Parameters .....	35-59
Detect Numerical Accuracy Issues Due to Quantization and Overflow .....	35-63
Reuse Custom C Data Types for Parameter Data ...	35-63
Data Types of Mathematical Expressions .....	35-64
Block Parameter Data Types in the Generated Code .	35-65
<b>Specify Minimum and Maximum Values for Block Parameters .....</b>	
Specify Block Parameter Value Ranges .....	35-66
Restrict Allowed Values for Block Parameters .....	35-68
Specify Range Information for Tunable Fixed-Point Parameters .....	35-68
Unexpected Errors or Warnings for Data with Greater Precision or Range than <code>double</code> .....	35-69
Optimize Generated Code .....	35-69
<b>Switch Between Sets of Parameter Values During Simulation and Code Execution .....</b>	35-71

## Working with Lookup Tables

# 36

<b>About Lookup Table Blocks .....</b>	36-2
<b>Anatomy of a Lookup Table .....</b>	36-4
<b>Lookup Tables Block Library .....</b>	36-6
<b>Guidelines for Choosing a Lookup Table .....</b>	36-8
Data Set Dimensionality .....	36-8
Data Set Numeric and Data Types .....	36-8
Data Accuracy and Smoothness .....	36-8
Dynamics of Table Inputs .....	36-9
Efficiency of Performance .....	36-9
Summary of Lookup Table Block Features .....	36-10

<b>Enter Breakpoints and Table Data</b> .....	<b>36-12</b>
Entering Data in a Block Parameter Dialog Box .....	<b>36-12</b>
Entering Data in the Lookup Table Editor .....	<b>36-12</b>
Entering Data Using Imports of the Lookup Table Dynamic Block .....	<b>36-14</b>
<b>Characteristics of Lookup Table Data</b> .....	<b>36-17</b>
Sizes of Breakpoint Data Sets and Table Data .....	<b>36-17</b>
Monotonicity of Breakpoint Data Sets .....	<b>36-18</b>
Representation of Discontinuities in Lookup Tables ..	<b>36-18</b>
Formulation of Evenly Spaced Breakpoints .....	<b>36-20</b>
<b>Methods for Estimating Missing Points</b> .....	<b>36-22</b>
About Estimating Missing Points .....	<b>36-22</b>
Interpolation Methods .....	<b>36-22</b>
Extrapolation Methods .....	<b>36-23</b>
Rounding Methods .....	<b>36-24</b>
Example Output for Lookup Methods .....	<b>36-25</b>
<b>Edit Lookup Tables</b> .....	<b>36-27</b>
Edit N-Dimensional Lookup Tables .....	<b>36-27</b>
Edit Custom Lookup Table Blocks .....	<b>36-29</b>
<b>Import Lookup Table Data from MATLAB</b> .....	<b>36-31</b>
Import Standard Format Lookup Table Data .....	<b>36-31</b>
Propagate Standard Format Lookup Table Data .....	<b>36-32</b>
Import Nonstandard Format Lookup Table Data .....	<b>36-33</b>
Propagate Nonstandard Format Lookup Table Data ..	<b>36-34</b>
<b>Import Lookup Table Data from Excel</b> .....	<b>36-38</b>
<b>Create a Logarithm Lookup Table</b> .....	<b>36-39</b>
<b>Prelookup and Interpolation Blocks</b> .....	<b>36-42</b>
<b>Optimize Generated Code for Lookup Table Blocks</b> .	<b>36-44</b>
Remove Code That Checks for Out-of-Range Inputs ..	<b>36-44</b>
Optimize Breakpoint Spacing in Lookup Tables .....	<b>36-46</b>
Reduce Data Copies for Lookup Table Blocks .....	<b>36-47</b>
<b>Update Lookup Table Blocks to New Versions</b> .....	<b>36-48</b>
Comparison of Blocks with Current Versions .....	<b>36-48</b>

Compatibility of Models with Older Versions of Lookup Table Blocks . . . . .	36-49
How to Update Your Model . . . . .	36-50
What to Expect from the Model Advisor Check . . . . .	36-50
<b>Lookup Table Glossary . . . . .</b>	<b>36-54</b>

## Working With Block Masks

# 37

<b>Masking Fundamentals . . . . .</b>	<b>37-2</b>
Masking Terminology . . . . .	37-4
<b>Create a Simple Mask . . . . .</b>	<b>37-7</b>
Step 1: Open Mask Editor . . . . .	37-7
Step 2: Define the Mask . . . . .	37-8
Step 3: Operate on Mask . . . . .	37-14
<b>Manage Existing Masks . . . . .</b>	<b>37-16</b>
Change a Block Mask . . . . .	37-16
View Mask Parameters . . . . .	37-16
Look Under Block Mask . . . . .	37-16
Remove Mask . . . . .	37-16
<b>Mask Callback Code . . . . .</b>	<b>37-18</b>
Add Mask Code . . . . .	37-18
Execute Drawing Command . . . . .	37-18
Execute Initialization Command . . . . .	37-19
Execute Callback Code . . . . .	37-20
<b>Draw Mask Icon . . . . .</b>	<b>37-22</b>
Draw Static Icon . . . . .	37-22
Draw Dynamic Icon . . . . .	37-23
<b>Initialize Mask . . . . .</b>	<b>37-26</b>
Dialog Variables . . . . .	37-27
Initialization Commands . . . . .	37-28
Mask Initialization Best Practices . . . . .	37-28

<b>Promote Parameter to Mask</b> .....	<b>37-30</b>
Promote Underlying Parameters to Block Mask .....	<b>37-32</b>
Promote Underlying Parameters to Subsystem Mask .....	<b>37-34</b>
Unresolved Promoted Parameter .....	<b>37-36</b>
Best Practices .....	<b>37-36</b>
<b>Control Masks Programmatically</b> .....	<b>37-37</b>
Use Simulink.Mask and Simulink.MaskParameter ..	<b>37-37</b>
Use <code>get_param</code> and <code>set_param</code> .....	<b>37-38</b>
Programmatically Create Mask Parameters and Dialogs .....	<b>37-39</b>
<b>Pass Values to Blocks Under the Mask</b> .....	<b>37-44</b>
Parameter Promotion .....	<b>37-44</b>
Mask Initialization .....	<b>37-44</b>
Referencing Block Parameters Using Variable Names	<b>37-44</b>
<b>Mask Linked Blocks</b> .....	<b>37-47</b>
Guidelines for Mask Parameters .....	<b>37-49</b>
Mask Behavior for Masked, Linked Blocks .....	<b>37-49</b>
Mask a Linked Block .....	<b>37-50</b>
<b>Dynamic Mask Dialog Box</b> .....	<b>37-51</b>
Show Parameter .....	<b>37-51</b>
Enable Parameter .....	<b>37-52</b>
Create Dynamic Mask Dialog Box .....	<b>37-52</b>
Set Up Nested Masked Block Parameters .....	<b>37-53</b>
<b>Dynamic Masked Subsystem</b> .....	<b>37-55</b>
Allow Library Block to Modify Its Contents .....	<b>37-55</b>
Create Self-Modifying Masks for Library Blocks .....	<b>37-55</b>
Evaluate Blocks Under Self-Modifying Mask .....	<b>37-59</b>
<b>Debug Masks That Use MATLAB Code</b> .....	<b>37-61</b>
Code Written in Mask Editor .....	<b>37-61</b>
Code Written Using MATLAB Editor/Debugger .....	<b>37-61</b>
<b>Introduction to Model Mask</b> .....	<b>37-63</b>
<b>Create and Reference a Masked Model</b> .....	<b>37-64</b>
Step 1: Define Mask Arguments .....	<b>37-64</b>
Step 2: Create Model Mask .....	<b>37-65</b>
Step 3: View Model Mask Parameters .....	<b>37-67</b>

Step 4: Reference Masked Model .....	37-68
<b>Control Model Mask Programmatically .....</b>	<b>37-71</b>
Simulink.Mask.create .....	37-71
Simulink.Mask.get .....	37-72
<b>Constraints .....</b>	<b>37-73</b>
<b>Masking Example Models .....</b>	<b>37-74</b>
<b>Mask a Variant Subsystem .....</b>	<b>37-75</b>

## Creating Custom Blocks

# 38

<b>Create Your Own Simulink Block .....</b>	<b>38-2</b>
Why Create Blocks .....	38-2
Types of Custom Blocks .....	38-2
Comparing MATLAB S-Functions to MATLAB Functions for Code Generation .....	38-5
Using S-Function Blocks to Incorporate Legacy Code ..	38-5
<b>Comparison of Custom Block Functionality .....</b>	<b>38-7</b>
Block Type Flowchart .....	38-8
Model State Behavior .....	38-10
Simulation Performance .....	38-11
Code Generation .....	38-13
Multiple Input and Output Ports .....	38-14
Speed of Updating the Simulink Diagram .....	38-14
Callback Methods .....	38-15
<b>Expanding Custom Block Functionality .....</b>	<b>38-18</b>
<b>Create a Custom Block .....</b>	<b>38-19</b>
How to Design a Custom Block .....	38-19
Defining Custom Block Behavior .....	38-21
Deciding on a Custom Block Type .....	38-22
Placing Custom Blocks in a Library .....	38-26
Adding a User Interface to a Custom Block .....	38-29
Adding Block Functionality Using Block Callbacks ..	38-37

<b>Custom Libraries and Linked Blocks</b> .....	39-2
Why Create Custom Libraries? .....	39-2
How Block Instances Connect to Libraries .....	39-2
<b>Create a Custom Library</b> .....	39-4
Create a Library .....	39-4
Blocks for Custom Libraries .....	39-5
Annotations in Custom Libraries .....	39-7
Lock and Unlock Libraries .....	39-8
Prevent Disabling of Library Links .....	39-8
<b>Add Libraries to the Library Browser</b> .....	39-10
Specify Library Order in the Library List .....	39-13
<b>Linked Blocks</b> .....	39-15
Rules for Linked Blocks .....	39-16
Linked Block Terminology .....	39-16
<b>Parameterized Links and Self-Modifiable Linked Subsystems</b> .....	39-19
Parameterized Links .....	39-19
Self-Modifiable Linked Subsystems .....	39-24
<b>Display Library Links</b> .....	39-25
<b>Disable or Break Links to Library Blocks</b> .....	39-27
Break Links .....	39-27
<b>Lock Links to Blocks in a Library</b> .....	39-29
Rules for Locked Links .....	39-30
<b>Restore Disabled or Parameterized Links</b> .....	39-31
Pushing or Restoring Link Hierarchies .....	39-33
<b>Fix Unresolved Library Links</b> .....	39-34
<b>Control Linked Block Programmatically</b> .....	39-37
Linked Block Information .....	39-37
Lock Linked Blocks .....	39-37



Link Status .....	39-37
<b>Forwarding Tables .....</b>	<b>39-40</b>
Create Forwarding Table .....	39-40
Create Mask Parameter Aliases .....	39-46

## Using the MATLAB Function Block

# 40

<b>Integrate MATLAB Algorithm in Model .....</b>	<b>40-3</b>
Defining Local Variables for Code Generation .....	40-3
<b>What Is a MATLAB Function Block? .....</b>	<b>40-5</b>
Calling Functions in MATLAB Function Blocks .....	40-5
<b>Why Use MATLAB Function Blocks? .....</b>	<b>40-7</b>
<b>Use Nondirect Feedthrough in a MATLAB Function Block .....</b>	<b>40-8</b>
<b>Create Model That Uses MATLAB Function Block ...</b>	<b>40-9</b>
Adding a MATLAB Function Block to a Model .....	40-9
Programming the MATLAB Function Block .....	40-10
Building the Function and Checking for Errors .....	40-11
Defining Inputs and Outputs .....	40-13
<b>Code Generation Readiness Tool .....</b>	<b>40-15</b>
Summary Tab .....	40-16
Code Structure Tab .....	40-18
<b>Check Code Using the Code Generation Readiness Tool .....</b>	<b>40-21</b>
Run Code Generation Readiness Tool at the Command Line .....	40-21
Run the Code Generation Readiness Tool From the Current Folder Browser .....	40-21
<b>Debugging a MATLAB Function Block .....</b>	<b>40-22</b>
Debugging the Function in Simulation .....	40-22
Set Conditions on Breakpoints .....	40-25

Watching Function Variables During Simulation . . . .	40-26
Checking for Data Range Violations . . . . .	40-28
Debugging Tools . . . . .	40-28
<b>Prevent Algebraic Loop Errors in MATLAB Function and Stateflow Blocks . . . . .</b>	<b>40-32</b>
<b>MATLAB Function Block Editor . . . . .</b>	<b>40-34</b>
Customizing the MATLAB Function Block Editor . . .	40-34
MATLAB Function Block Editor Tools . . . . .	40-34
Editing and Debugging MATLAB Function Block Code . . . . .	40-35
Ports and Data Manager . . . . .	40-36
<b>MATLAB Function Reports . . . . .</b>	<b>40-48</b>
About MATLAB Function Reports . . . . .	40-48
Opening MATLAB Function Reports . . . . .	40-49
Description of MATLAB Function Reports . . . . .	40-49
Viewing Your MATLAB Function Code . . . . .	40-49
Viewing Call Stack Information . . . . .	40-50
Viewing the Compilation Summary Information . . . .	40-51
Viewing Error and Warning Messages . . . . .	40-51
MATLAB Code Variables in a Report . . . . .	40-52
Keyboard Shortcuts for the MATLAB Function Report	40-57
Searching in the MATLAB Function Report . . . . .	40-59
Report Limitations . . . . .	40-59
<b>Type Function Arguments . . . . .</b>	<b>40-61</b>
About Function Arguments . . . . .	40-61
Specifying Argument Types . . . . .	40-61
Inheriting Argument Data Types . . . . .	40-63
Built-In Data Types for Arguments . . . . .	40-63
Specifying Argument Types with Expressions . . . . .	40-64
Specifying Fixed-Point Designer Data Properties . . . .	40-64
<b>Size Function Arguments . . . . .</b>	<b>40-68</b>
Specifying Argument Size . . . . .	40-68
Inheriting Argument Sizes from Simulink . . . . .	40-68
Specifying Argument Sizes with Expressions . . . . .	40-69
<b>Units in MATLAB Function Blocks . . . . .</b>	<b>40-71</b>
Units for Input and Output Data . . . . .	40-71
Consistency Checking . . . . .	40-71

Units for Stateflow Limitations .....	40-71
<b>Add Parameter Arguments .....</b>	<b>40-72</b>
<b>Resolve Signal Objects for Output Data .....</b>	<b>40-73</b>
Implicit Signal Resolution .....	40-73
Eliminating Warnings for Implicit Signal Resolution in the Model .....	40-73
Disabling Implicit Signal Resolution for a MATLAB Function Block .....	40-73
Forcing Explicit Signal Resolution for an Output Data Signal .....	40-74
<b>Types of Structures in MATLAB Function Blocks ...</b>	<b>40-75</b>
<b>Attach Bus Signals to MATLAB Function Blocks ....</b>	<b>40-76</b>
Structure Definitions in Example .....	40-76
Bus Objects Define Structure Inputs and Outputs ...	40-76
<b>How Structure Inputs and Outputs Interface with Bus Signals .....</b>	<b>40-78</b>
Working with Virtual and Nonvirtual Buses .....	40-78
<b>Rules for Defining Structures in MATLAB Function Blocks .....</b>	<b>40-79</b>
<b>Index Substructures and Fields .....</b>	<b>40-80</b>
<b>Create Structures in MATLAB Function Blocks ....</b>	<b>40-82</b>
<b>Assign Values to Structures and Fields .....</b>	<b>40-84</b>
<b>Initialize a Matrix Using a Nontunable Structure Parameter .....</b>	<b>40-86</b>
<b>Define and Use Structure Parameters .....</b>	<b>40-89</b>
Defining Structure Parameters .....	40-89
FIMATH Properties of Nontunable Structure Parameters .....	40-89
<b>Limitations of Structures and Buses in MATLAB Function Blocks .....</b>	<b>40-91</b>

<b>Control Support for Variable-Size Arrays in a MATLAB Function Block</b> .....	<b>40-92</b>
<b>Declare Variable-Size Inputs and Outputs</b> .....	<b>40-93</b>
<b>Use a Variable-Size Signal in a Filtering Algorithm</b> .	<b>40-94</b>
About the Example .....	<b>40-94</b>
Simulink Model .....	<b>40-94</b>
Source Signal .....	<b>40-95</b>
MATLAB Function Block: uniquify .....	<b>40-95</b>
MATLAB Function Block: avg .....	<b>40-97</b>
Variable-Size Results .....	<b>40-98</b>
<b>Control Memory Allocation for Variable-Size Arrays in a MATLAB Function Block</b> .....	<b>40-102</b>
Provide Upper Bounds for Variable-Size Arrays . . . .	<b>40-102</b>
Disable Dynamic Memory Allocation for MATLAB Function Blocks .....	<b>40-103</b>
Modify the Dynamic Memory Allocation Threshold .	<b>40-103</b>
<b>Use Dynamic Memory Allocation for Variable-Size Arrays in a MATLAB Function Block</b> .....	<b>40-104</b>
Create Model .....	<b>40-104</b>
Configure Model for Dynamic Memory Allocation . .	<b>40-105</b>
Simulate Model Using Dynamic Memory Allocation .	<b>40-105</b>
Use Dynamic Memory Allocation for Bounded Arrays	<b>40-105</b>
Generate C Code That Uses Dynamic Memory Allocation .....	<b>40-106</b>
<b>Code Generation for Enumerations</b> .....	<b>40-108</b>
Define Enumerations for MATLAB Function Blocks	<b>40-108</b>
Use Allowed Operations on Enumerations .....	<b>40-110</b>
Use MATLAB Toolbox Functions That Support Enumerations .....	<b>40-110</b>
<b>Add Enumerated Inputs, Outputs, and Parameters to a MATLAB Function Block</b> .....	<b>40-112</b>
<b>Use Enumerations to Control an LED Display</b> .....	<b>40-113</b>
Simulink Model .....	<b>40-113</b>
Enumeration Class Definitions .....	<b>40-114</b>
MATLAB Function Block Function .....	<b>40-114</b>
Simulation .....	<b>40-115</b>

<b>Share Data Globally</b> .....	<b>40-116</b>
When Do You Need to Use Global Data? .....	40-116
Using Global Data with the MATLAB Function Block .....	40-116
Choosing How to Store Global Data .....	40-117
How to Use Data Store Memory Blocks .....	40-118
How to Use Simulink.Signal Objects .....	40-120
Using Data Store Diagnostics to Detect Memory Access Issues .....	40-122
Limitations of Using Shared Data in MATLAB Function Blocks .....	40-122
<b>Create Custom Block Libraries</b> .....	<b>40-124</b>
When to Use MATLAB Function Block Libraries ...	40-124
How to Create Custom MATLAB Function Block Libraries .....	40-124
Example: Creating a Custom Signal Processing Filter Block Library .....	40-125
Code Reuse with Library Blocks .....	40-137
Debugging MATLAB Function Library Blocks .....	40-142
Properties You Can Specialize Across Instances of Library Blocks .....	40-142
<b>Use Traceability in MATLAB Function Blocks</b> .....	<b>40-144</b>
Extent of Traceability in MATLAB Function Blocks .	40-144
Traceability Requirements .....	40-144
Basic Workflow for Using Traceability .....	40-144
Tutorial: Using Traceability in a MATLAB Function Block .....	40-145
<b>Include MATLAB Code as Comments in Generated Code</b> .....	<b>40-148</b>
How to Include MATLAB Code as Comments in the Generated Code .....	40-148
Location of Comments in Generated Code .....	40-149
Including MATLAB Function Help Text in the Function Banner .....	40-151
Limitations of MATLAB Source Code as Comments .	40-151
<b>Integrate C Code Using the MATLAB Function Block</b>	<b>40-153</b>
Call C Code from a Simulink model .....	40-153
Control Imported Bus and Enumeration Type Definitions .....	40-155

<b>Enhance Code Readability for MATLAB Function</b>	
<b>Blocks</b> . . . . .	40-157
Requirements for Using Readability Optimizations . . . . .	40-157
Converting If-Elseif-Else Code to Switch-Case Statements . . . . .	40-157
Example of Converting Code for If-Elseif-Else Decision Logic to Switch-Case Statements . . . . .	40-159
<b>Control Run-Time Checks</b> . . . . .	40-165
Types of Run-Time Checks . . . . .	40-165
When to Disable Run-Time Checks . . . . .	40-165
How to Disable Run-Time Checks . . . . .	40-166
<b>Track Object Using MATLAB Code</b> . . . . .	40-167
Learning Objectives . . . . .	40-167
Tutorial Prerequisites . . . . .	40-167
Example: The Kalman Filter . . . . .	40-168
Files for the Tutorial . . . . .	40-171
Tutorial Steps . . . . .	40-172
Best Practices Used in This Tutorial . . . . .	40-189
Key Points to Remember . . . . .	40-189
<b>Filter Audio Signal Using MATLAB Code</b> . . . . .	40-191
Learning Objectives . . . . .	40-191
Tutorial Prerequisites . . . . .	40-191
Example: The LMS Filter . . . . .	40-192
Files for the Tutorial . . . . .	40-194
Tutorial Steps . . . . .	40-196
<b>Encapsulating the Interface to External Code</b> . . . . .	40-219
<b>Encapsulate Interface to an External C Library</b> . . . . .	40-220
<b>Best Practices for Using coder.ExternalDependency</b> . . . . .	40-223
Terminate Code Generation for Unsupported External Dependency . . . . .	40-223
Parameterize Methods for MATLAB and Generated Code . . . . .	40-223
Parameterize updateBuildInfo for Multiple Platforms . . . . .	40-224
<b>Update Build Information from MATLAB code</b> . . . . .	40-225

<b>Customize System Block Appearance</b> .....	41-2
Specify Input and Output Names .....	41-2
Add Text to Block Icon .....	41-3
Add Image to Block Icon .....	41-5
<b>Customize System Block Dialog Box</b> .....	41-7
Add Header to MATLAB System Block .....	41-7
Add Data Types Tab to MATLAB System Block .....	41-8
Add Property Groups to System Object and MATLAB System Block .....	41-10
Control Simulation Type in MATLAB System Block .	41-15
Add Button to MATLAB System Block .....	41-17
<b>Specify Output</b> .....	41-20
Set Output Size .....	41-20
Specify Whether Output Is Fixed-Size or Variable- Size .....	41-22
Set Output Data Type .....	41-24
Set Output Complexity .....	41-27
Specify Discrete State Output Specification .....	41-29
<b>Set Model Reference Discrete Sample Time     Inheritance</b> .....	41-32
<b>Use Update and Output for Nondirect Feedthrough</b> .	41-34
<b>Enable For Each Subsystem Support</b> .....	41-37
<b>Define System Object for Use in Simulink</b> .....	41-39
Develop System Object for Use in System Block .....	41-39
Define Block Dialog Box for Plot Ramp .....	41-40
<b>Use Enumerations in System Objects</b> .....	41-45
<b>Use Global Variables in System Objects</b> .....	41-46
System Object Global Variables in MATLAB .....	41-46
System Object Global Variables in Simulink .....	41-46

<b>Use System Objects in Simulink</b> . . . . .	<b>41-50</b>
System Objects in the MATLAB Function Block . . . .	<b>41-50</b>
System Objects in the MATLAB System Block . . . . .	<b>41-50</b>
<b>System Design in Simulink Using System Objects</b> . . .	<b>41-51</b>
System Design and Simulation in Simulink . . . . .	<b>41-51</b>
Define New Kinds of System Objects for Use in Simulink . . . . .	<b>41-51</b>
Test New System Objects in MATLAB . . . . .	<b>41-57</b>
Add System Objects to Your Simulink Model . . . . .	<b>41-57</b>

## System Objects in Simulink

# 42

<b>MATLAB System Block</b> . . . . .	<b>42-2</b>
Why Use the MATLAB System Block? . . . . .	<b>42-2</b>
Choosing the Right Block Type . . . . .	<b>42-2</b>
System Objects . . . . .	<b>42-3</b>
Interpreted Execution or Code Generation . . . . .	<b>42-3</b>
Default Input Signal Attributes . . . . .	<b>42-4</b>
MATLAB System Block Limitations . . . . .	<b>42-4</b>
MATLAB System and System Objects Examples . . . . .	<b>42-5</b>
<b>Implement a MATLAB System Block</b> . . . . .	<b>42-8</b>
Understanding the MATLAB System Block . . . . .	<b>42-9</b>
<b>Change Blocks Implemented with System Objects</b> . .	<b>42-11</b>
<b>Change Block Icon and Port Labels</b> . . . . .	<b>42-12</b>
Modify MATLAB System Block Dialog . . . . .	<b>42-12</b>
Change the MATLAB System Block Icon to an Image	<b>42-13</b>
<b>Nonvirtual Buses and MATLAB System Block</b> . . . . .	<b>42-14</b>
<b>Use System Objects in Feedback Loops</b> . . . . .	<b>42-15</b>
<b>Simulation Modes</b> . . . . .	<b>42-17</b>
Interpreted Execution vs. Code Generation . . . . .	<b>42-17</b>
Simulation Using Code Generation . . . . .	<b>42-18</b>



<b>Mapping System Objects to Block Dialog Box</b> . . . . .	<b>42-20</b>
System Object to Block Dialog Box Default Mapping .	42-20
System Object to Block Dialog Box Custom Mapping .	42-22
<b>Considerations for Using System Objects in Simulink</b>	<b>42-25</b>
System Objects in Simulink . . . . .	42-25
System Objects in For Each Subsystems . . . . .	42-26
Input Validation . . . . .	42-26
<b>Simulink Engine Interaction with System Object</b>	
<b>Methods</b> . . . . .	<b>42-28</b>
Simulink Engine Phases Mapped to System Object	
Methods . . . . .	42-28
<b>Add and Implement Propagation Methods</b> . . . . .	<b>42-31</b>
When to Use Propagation Methods . . . . .	42-31
Add Propagation Methods to System Objects . . . . .	42-31
Implement Propagation Methods . . . . .	42-32
<b>Share Data with Other Blocks</b> . . . . .	<b>42-34</b>
Data Sharing with the MATLAB System Block . . . . .	42-34
Choose How to Store Shared Data . . . . .	42-35
How to Use Data Store Memory Blocks for the MATLAB	
System Block . . . . .	42-36
How to Set Up Simulink.Signal Objects . . . . .	42-38
Using Data Store Diagnostics to Detect Memory Access	
Issues . . . . .	42-41
Limitations of Using Shared Data in MATLAB System	
Blocks . . . . .	42-41
Use Shared Data with P-Coded System Objects . . . . .	42-41
<b>Troubleshoot System Objects in Simulink</b> . . . . .	<b>42-43</b>
Class Not Found . . . . .	42-43
Error Invoking Object Method . . . . .	42-43
Performance . . . . .	42-44

<b>When to Generate Code from MATLAB Algorithms . . .</b>	<b>43-2</b>
When Not to Generate Code from MATLAB Algorithms . . . . .	43-2
<b>Which Code Generation Feature to Use . . . . .</b>	<b>43-4</b>
<b>Prerequisites for C/C++ Code Generation from MATLAB . . . . .</b>	<b>43-6</b>
<b>MATLAB Code Design Considerations for Code Generation . . . . .</b>	<b>43-7</b>
See Also . . . . .	43-8
<b>Differences Between Generated Code and MATLAB Code . . . . .</b>	<b>43-9</b>
Character Size . . . . .	43-9
Order of Evaluation in Expressions . . . . .	43-9
Termination Behavior . . . . .	43-11
Size of Variable-Size N-D Arrays . . . . .	43-11
Size of Empty Arrays . . . . .	43-11
Size of Empty Array That Results from Deleting Elements of an Array . . . . .	43-11
Floating-Point Numerical Results . . . . .	43-12
NaN and Infinity Patterns . . . . .	43-13
Code Generation Target . . . . .	43-13
MATLAB Class Initial Values . . . . .	43-13
Variable-Size Data . . . . .	43-13
Complex Numbers . . . . .	43-13
<b>MATLAB Language Features Supported for C/C++ Code Generation . . . . .</b>	<b>43-14</b>
MATLAB Features That Code Generation Supports . . . . .	43-14
MATLAB Language Features That Code Generation Does Not Support . . . . .	43-15

# Functions, Classes, and System Objects Supported for Code Generation

44

<b>Functions and Objects Supported for C/C++ Code Generation — Alphabetical List</b> . . . . .	44-2
--	------

<b>Functions and Objects Supported for C/C++ Code Generation — Category List</b> . . . . .	44-67
Aerospace Toolbox . . . . .	44-69
Arithmetic Operations in MATLAB . . . . .	44-69
Audio System Toolbox . . . . .	44-70
Automated Driving System Toolbox . . . . .	44-71
Bit-Wise Operations MATLAB . . . . .	44-72
Casting in MATLAB . . . . .	44-73
Character Functions in MATLAB . . . . .	44-73
Communications System Toolbox . . . . .	44-74
Complex Numbers in MATLAB . . . . .	44-80
Computer Vision System Toolbox . . . . .	44-81
Control Flow in MATLAB . . . . .	44-85
Control System Toolbox . . . . .	44-85
Data and File Management in MATLAB . . . . .	44-85
Data Types in MATLAB . . . . .	44-86
Desktop Environment in MATLAB . . . . .	44-87
Discrete Math in MATLAB . . . . .	44-87
DSP System Toolbox . . . . .	44-87
Error Handling in MATLAB . . . . .	44-93
Exponents in MATLAB . . . . .	44-93
Filtering and Convolution in MATLAB . . . . .	44-94
Fixed-Point Designer . . . . .	44-94
Histograms in MATLAB . . . . .	44-100
Image Acquisition Toolbox . . . . .	44-100
Image Processing in MATLAB . . . . .	44-101
Image Processing Toolbox . . . . .	44-101
Input and Output Arguments in MATLAB . . . . .	44-105
Interpolation and Computational Geometry in MATLAB . . . . .	44-105
Linear Algebra in MATLAB . . . . .	44-106
Logical and Bit-Wise Operations in MATLAB . . . . .	44-107
MATLAB Compiler . . . . .	44-107
Matrices and Arrays in MATLAB . . . . .	44-108
Neural Network Toolbox . . . . .	44-111

Numerical Integration and Differentiation in MATLAB .....	44-111
Optimization Functions in MATLAB .....	44-112
Optimization Toolbox .....	44-112
Phased Array System Toolbox .....	44-113
Polynomials in MATLAB .....	44-119
Programming Utilities in MATLAB .....	44-120
Relational Operators in MATLAB .....	44-120
Robotics System Toolbox .....	44-120
Rounding and Remainder Functions in MATLAB ..	44-122
Set Operations in MATLAB .....	44-122
Signal Processing in MATLAB .....	44-123
Signal Processing Toolbox .....	44-123
Special Values in MATLAB .....	44-126
Specialized Math in MATLAB .....	44-127
Statistics in MATLAB .....	44-127
Statistics and Machine Learning Toolbox .....	44-128
System Identification Toolbox .....	44-134
System object Methods .....	44-135
Trigonometry in MATLAB .....	44-135
Wavelet Toolbox .....	44-137
WLAN System Toolbox .....	44-138

## System Objects Supported for Code Generation

### 45

Code Generation for System Objects .....	45-2
--	------

## Defining MATLAB Variables for C/C++ Code Generation

### 46

Variables Definition for Code Generation .....	46-2
Best Practices for Defining Variables for C/C++ Code Generation .....	46-3
Define Variables By Assignment Before Using Them ..	46-3

Use Caution When Reassigning Variables . . . . .	46-5
Use Type Cast Operators in Variable Definitions . . . . .	46-5
Define Matrices Before Assigning Indexed Variables . . . . .	46-6
<b>Eliminate Redundant Copies of Variables in Generated Code . . . . .</b>	<b>46-7</b>
When Redundant Copies Occur . . . . .	46-7
How to Eliminate Redundant Copies by Defining Uninitialized Variables . . . . .	46-7
Defining Uninitialized Variables . . . . .	46-8
<b>Reassignment of Variable Properties . . . . .</b>	<b>46-9</b>
<b>Reuse the Same Variable with Different Properties . . . . .</b>	<b>46-10</b>
When You Can Reuse the Same Variable with Different Properties . . . . .	46-10
When You Cannot Reuse Variables . . . . .	46-10
Limitations of Variable Reuse . . . . .	46-13
<b>Avoid Overflows in for-Loops . . . . .</b>	<b>46-14</b>
<b>Supported Variable Types . . . . .</b>	<b>46-16</b>

## Defining Data for Code Generation

# 47

<b>Data Definition for Code Generation . . . . .</b>	<b>47-2</b>
<b>Code Generation for Complex Data . . . . .</b>	<b>47-4</b>
Restrictions When Defining Complex Variables . . . . .	47-4
Code Generation for Complex Data with Zero-Valued Imaginary Parts . . . . .	47-4
Results of Expressions That Have Complex Operands . . . . .	47-7
<b>Code Generation for Character Arrays . . . . .</b>	<b>47-8</b>
<b>Array Size Restrictions for Code Generation . . . . .</b>	<b>47-9</b>
See Also . . . . .	47-9

<b>Code Generation for Constants in Structures and Arrays</b> .....	<b>47-10</b>
---	--------------

# 48

## Code Generation for Variable-Size Data

<b>Code Generation for Variable-Size Arrays</b> .....	<b>48-2</b>
Memory Allocation for Variable-Size Arrays .....	<b>48-3</b>
Enabling and Disabling Support for Variable-Size Arrays .....	<b>48-3</b>
Variable-Size Arrays in a MATLAB Function Report ..	<b>48-4</b>
<b>Specify Upper Bounds for Variable-Size Arrays</b> .....	<b>48-5</b>
Specify Upper Bounds for MATLAB Function Block Inputs and Outputs .....	<b>48-5</b>
Specify Upper Bounds for Local Variables .....	<b>48-5</b>
<b>Define Variable-Size Data for Code Generation</b> .....	<b>48-7</b>
Use a Matrix Constructor with Nonconstant Dimensions .....	<b>48-7</b>
Assign Multiple Sizes to the Same Variable .....	<b>48-8</b>
Define Variable-Size Data Explicitly by Using <code>coder.ysize</code> .....	<b>48-8</b>
<b>Diagnose and Fix Variable-Size Data Errors</b> .....	<b>48-13</b>
Diagnosing and Fixing Size Mismatch Errors .....	<b>48-13</b>
Diagnosing and Fixing Errors in Detecting Upper Bounds .....	<b>48-15</b>
<b>Incompatibilities with MATLAB in Variable-Size Support for Code Generation</b> .....	<b>48-17</b>
Incompatibility with MATLAB for Scalar Expansion ..	<b>48-17</b>
Incompatibility with MATLAB in Determining Size of Variable-Size N-D Arrays .....	<b>48-19</b>
Incompatibility with MATLAB in Determining Size of Empty Arrays .....	<b>48-20</b>
Incompatibility with MATLAB in Determining Class of Empty Arrays .....	<b>48-21</b>
Incompatibility with MATLAB in Matrix-Matrix Indexing .....	<b>48-22</b>

Incompatibility with MATLAB in Vector-Vector Indexing . . . . .	48-22
Incompatibility with MATLAB in Matrix Indexing Operations for Code Generation . . . . .	48-23
Incompatibility with MATLAB in Concatenating Variable-Size Matrices . . . . .	48-24
Differences When Curly-Brace Indexing of Variable-Size Cell Array Inside Concatenation Returns No Elements . . . . .	48-24
<b>Variable-Sizing Restrictions for Code Generation of Toolbox Functions . . . . .</b>	<b>48-26</b>
Common Restrictions . . . . .	48-26
Toolbox Functions with Restrictions for Variable-Size Data . . . . .	48-27

## Code Generation for MATLAB Structures

# 49

<b>Structure Definition for Code Generation . . . . .</b>	<b>49-2</b>
<b>Structure Operations Allowed for Code Generation . . . . .</b>	<b>49-3</b>
<b>Define Scalar Structures for Code Generation . . . . .</b>	<b>49-4</b>
Restrictions When Defining Scalar Structures by Assignment . . . . .	49-4
Adding Fields in Consistent Order on Each Control Flow Path . . . . .	49-4
Restriction on Adding New Fields After First Use . . . . .	49-5
<b>Define Arrays of Structures for Code Generation . . . . .</b>	<b>49-6</b>
Ensuring Consistency of Fields . . . . .	49-6
Using repmat to Define an Array of Structures with Consistent Field Properties . . . . .	49-6
Defining an Array of Structures by Using struct . . . . .	49-7
Defining an Array of Structures Using Concatenation . . . . .	49-7
<b>Index Substructures and Fields . . . . .</b>	<b>49-8</b>
<b>Assign Values to Structures and Fields . . . . .</b>	<b>49-10</b>

## Code Generation for Cell Arrays

# 50

<b>Code Generation for Cell Arrays . . . . .</b>	<b>50-2</b>
Homogeneous vs. Heterogeneous Cell Arrays . . . . .	50-2
Controlling Whether a Cell Array Is Homogeneous or Heterogeneous . . . . .	50-3
Cell Arrays in Reports . . . . .	50-3
<b>Control Whether a Cell Array Is Variable-Size . . . . .</b>	<b>50-5</b>
<b>Cell Array Limitations for Code Generation . . . . .</b>	<b>50-8</b>
Cell Array Element Assignment . . . . .	50-8
Definition of Variable-Size Cell Array by Using cell . . . . .	50-9
Cell Array Indexing . . . . .	50-13
Growing a Cell Array by Using {end + 1} . . . . .	50-13
Variable-Size Cell Arrays . . . . .	50-14
Cell Array Contents . . . . .	50-15
Cell Arrays in Structures . . . . .	50-15
Passing Cell Arrays to External C/C++ Functions . . . . .	50-15
Use in MATLAB Function Block . . . . .	50-15

## Code Generation for MATLAB Classes

# 51

<b>MATLAB Classes Definition for Code Generation . . . . .</b>	<b>51-2</b>
Language Limitations . . . . .	51-2
Code Generation Features Not Compatible with Classes . . . . .	51-3
Defining Class Properties for Code Generation . . . . .	51-4
Calls to Base Class Constructor . . . . .	51-6
Inheritance from Built-In MATLAB Classes Not Supported . . . . .	51-7
<b>Classes That Support Code Generation . . . . .</b>	<b>51-8</b>



<b>Generate Code for MATLAB Value Classes</b> . . . . .	<b>51-9</b>
<b>Generate Code for MATLAB Handle Classes and System Objects</b> . . . . .	<b>51-14</b>
<b>MATLAB Classes in Code Generation Reports</b> . . . . .	<b>51-17</b>
What Reports Tell You About Classes . . . . .	<b>51-17</b>
How Classes Appear in Code Generation Reports . . .	<b>51-17</b>
<b>Troubleshooting Code Generation Issues with MATLAB Classes</b> . . . . .	<b>51-20</b>
Class class does not have a property with name name	<b>51-20</b>
<b>Handle Object Limitations for Code Generation</b> . . . .	<b>51-22</b>
A Variable Outside a Loop Cannot Refer to a Handle Object Created Inside a Loop . . . . .	<b>51-22</b>
A Handle Object That a Persistent Variable Refers To Must Be a Singleton Object . . . . .	<b>51-22</b>
<b>System Objects in MATLAB Code Generation</b> . . . . .	<b>51-25</b>
Usage Rules and Limitations for System Objects for Generating Code . . . . .	<b>51-25</b>
System Objects in codegen . . . . .	<b>51-28</b>
System Objects in the MATLAB Function Block . . . .	<b>51-28</b>
System Objects in the MATLAB System Block . . . . .	<b>51-28</b>
System Objects and MATLAB Compiler Software . . .	<b>51-28</b>

## Code Generation for Function Handles

**52**

<b>Function Handle Limitations for Code Generation</b> . . .	<b>52-2</b>
--	-------------

## Defining Functions for Code Generation

**53**

<b>Code Generation for Variable Length Argument Lists</b>	<b>53-2</b>
---	-------------

<b>Specify Number of Entry-Point Function Input or Output Arguments to Generate</b> . . . . .	<b>53-3</b>
Control Number of Input Arguments . . . . .	<b>53-3</b>
Control the Number of Output Arguments . . . . .	<b>53-3</b>
<b>Code Generation for Anonymous Functions</b> . . . . .	<b>53-5</b>
Anonymous Function Limitations for Code Generation	<b>53-5</b>
<b>Code Generation for Nested Functions</b> . . . . .	<b>53-6</b>
Nested Function Limitations for Code Generation . . . .	<b>53-6</b>

## Calling Functions for Code Generation

# 54

<b>Resolution of Function Calls for Code Generation</b> . . .	<b>54-2</b>
Key Points About Resolving Function Calls . . . . .	<b>54-4</b>
Compile Path Search Order . . . . .	<b>54-4</b>
When to Use the Code Generation Path . . . . .	<b>54-5</b>
<b>Resolution of File Types on Code Generation Path</b> . . .	<b>54-6</b>
<b>Compilation Directive %#codegen</b> . . . . .	<b>54-8</b>
<b>Extrinsic Functions</b> . . . . .	<b>54-9</b>
Declaring MATLAB Functions as Extrinsic Functions	<b>54-10</b>
Calling MATLAB Functions Using feval . . . . .	<b>54-14</b>
Resolution of Extrinsic Functions During Simulation .	<b>54-14</b>
Working with mxArray . . . . .	<b>54-15</b>
Restrictions on Extrinsic Functions for Code Generation . . . . .	<b>54-17</b>
Limit on Function Arguments . . . . .	<b>54-17</b>
<b>Code Generation for Recursive Functions</b> . . . . .	<b>54-18</b>
Compile-Time Recursion . . . . .	<b>54-18</b>
Run-Time Recursion . . . . .	<b>54-19</b>
Disallow Recursion . . . . .	<b>54-19</b>
Disable Run-Time Recursion . . . . .	<b>54-19</b>
Recursive Function Limitations for Code Generation .	<b>54-20</b>

<b>Force Code Generator to Use Run-Time Recursion . .</b>	<b>54-21</b>
Treat the Input to the Recursive Function as a Nonconstant . . . . .	<b>54-21</b>
Make the Input to the Recursive Function Variable- Size . . . . .	<b>54-22</b>
Assign Output Variable Before the Recursive Call . . .	<b>54-23</b>

## Generate Efficient and Reusable Code

# 55

<b>Modularize MATLAB Code . . . . .</b>	<b>55-2</b>
<b>Eliminate Redundant Copies of Function Inputs . . . .</b>	<b>55-3</b>
<b>Inline Code . . . . .</b>	<b>55-6</b>
Prevent Function Inlining . . . . .	<b>55-6</b>
Use Inlining in Control Flow Statements . . . . .	<b>55-6</b>
<b>Control Inlining . . . . .</b>	<b>55-8</b>
Control Size of Functions Inlined . . . . .	<b>55-8</b>
Control Size of Functions After Inlining . . . . .	<b>55-9</b>
Control Stack Size Limit on Inlined Functions . . . . .	<b>55-9</b>
<b>Fold Function Calls into Constants . . . . .</b>	<b>55-11</b>
<b>Control Stack Space Usage . . . . .</b>	<b>55-13</b>
<b>Stack Allocation and Performance . . . . .</b>	<b>55-14</b>
Allocate Heap Space from Command Line . . . . .	<b>55-14</b>
Allocate Heap Space Using the MATLAB Coder App . .	<b>55-14</b>
<b>Dynamic Memory Allocation and Performance . . . . .</b>	<b>55-15</b>
When Dynamic Memory Allocation Occurs . . . . .	<b>55-15</b>
<b>Minimize Dynamic Memory Allocation . . . . .</b>	<b>55-16</b>
<b>Provide Maximum Size for Variable-Size Arrays . . . .</b>	<b>55-17</b>
<b>Disable Dynamic Memory Allocation During Code     Generation . . . . .</b>	<b>55-23</b>

<b>Set Dynamic Memory Allocation Threshold</b> . . . . .	<b>55-24</b>
Set Dynamic Memory Allocation Threshold Using the MATLAB Coder App . . . . .	<b>55-24</b>
Set Dynamic Memory Allocation Threshold at the Command Line . . . . .	<b>55-25</b>
<b>Excluding Unused Paths from Generated Code</b> . . . . .	<b>55-26</b>
<b>Prevent Code Generation for Unused Execution Paths</b> . . . . .	<b>55-27</b>
Prevent Code Generation When Local Variable Controls Flow . . . . .	<b>55-27</b>
Prevent Code Generation When Input Variable Controls Flow . . . . .	<b>55-28</b>
<b>Generate Code with Parallel for-Loops (parfor)</b> . . . . .	<b>55-29</b>
<b>Minimize Redundant Operations in Loops</b> . . . . .	<b>55-31</b>
<b>Unroll for-Loops</b> . . . . .	<b>55-33</b>
<b>Disable Support for Integer Overflow or Non-Finites</b>	<b>55-35</b>
Disable Support for Integer Overflow . . . . .	<b>55-35</b>
Disable Support for Non-Finite Numbers . . . . .	<b>55-36</b>
<b>Integrate External/Custom Code</b> . . . . .	<b>55-37</b>
<b>Generate Reusable Code</b> . . . . .	<b>55-43</b>
<b>LAPACK Calls for Linear Algebra in a MATLAB Function Block</b> . . . . .	<b>55-44</b>

## Troubleshooting MATLAB Code in MATLAB Function Blocks

# 56

<b>Compile-Time Recursion Limit Reached</b> . . . . .	<b>56-2</b>
Issue . . . . .	<b>56-2</b>
Cause . . . . .	<b>56-2</b>
Solutions . . . . .	<b>56-2</b>

Force Run-Time Recursion .....	56-2
Increase the Compile-Time Recursion Limit .....	56-5
<b>Output Variable Must Be Assigned Before Run-Time</b>	
<b>Recursive Call</b> .....	56-7
Issue .....	56-7
Cause .....	56-7
Solution .....	56-7
<b>Unable to Determine That Every Element of Cell Array Is</b>	
<b>Assigned</b> .....	56-10
Issue .....	56-10
Cause .....	56-10
Solution .....	56-12
<b>Nonconstant Index into varargin or varargin in a for-Loop .</b>	56-14
Issue .....	56-14
Cause .....	56-14
Solution .....	56-15

## Managing Data

### Working with Data

# 57

<b>About Data Types in Simulink</b> .....	57-3
About Data Types .....	57-3
Data Typing Guidelines .....	57-4
Data Type Propagation .....	57-4
<b>Data Types Supported by Simulink</b> .....	57-6
Block Support for Data and Signal Types .....	57-6
<b>Control Signal Data Types</b> .....	57-8
Entering Valid Data Type Values .....	57-9
Using the Model Explorer for Batch Editing .....	57-12
Use the Model Data Editor for Batch Editing of Inport and	
Outport Blocks .....	57-16

Share a Data Type Between Separate Algorithms, Data Paths, Models, and Bus Elements . . . . .	57-16
Reuse Custom C Data Types for Signal Data . . . . .	57-17
Display Signal Data Types on Block Diagram . . . . .	57-18
Data Types Remain double Despite Changing Settings . . . . .	57-18
<b>Validate a Floating-Point Embedded Model . . . . .</b>	<b>57-20</b>
Apply a Data Type Override to Floating-Point Data Types . . . . .	57-20
Validate a Single-Precision Model . . . . .	57-21
Blocks That Support Single Precision . . . . .	57-24
<b>Fixed-Point Numbers . . . . .</b>	<b>57-25</b>
Binary Point Interpretation . . . . .	57-26
Signed Fixed-Point Numbers . . . . .	57-27
<b>Benefits of Using Fixed-Point Hardware . . . . .</b>	<b>57-28</b>
<b>Scaling, Precision, and Range . . . . .</b>	<b>57-30</b>
Scaling . . . . .	57-30
Precision . . . . .	57-31
Range . . . . .	57-31
<b>Fixed-Point Data in MATLAB and Simulink . . . . .</b>	<b>57-33</b>
Fixed-Point Data in Simulink . . . . .	57-33
Fixed-Point Data in MATLAB . . . . .	57-35
Scaled Doubles . . . . .	57-36
<b>Share Fixed-Point Models . . . . .</b>	<b>57-37</b>
<b>Control Fixed-Point Instrumentation and Data Type Override . . . . .</b>	<b>57-39</b>
Control Instrumentation Settings . . . . .	57-39
Control Data Type Override . . . . .	57-40
<b>Specify Fixed-Point Data Types . . . . .</b>	<b>57-42</b>
Overriding Fixed-Point Specifications . . . . .	57-42
<b>Specify Data Types Using Data Type Assistant . . . . .</b>	<b>57-45</b>
Specifying a Fixed-Point Data Type . . . . .	57-48
Specify an Enumerated Data Type . . . . .	57-55
Specify a Bus Object Data Type . . . . .	57-55

<b>Data Types for Bus Signals</b> .....	<b>57-58</b>
<b>Data Objects</b> .....	<b>57-59</b>
Data Class Naming Conventions .....	<b>57-60</b>
Use Data Objects in Simulink Models .....	<b>57-60</b>
Data Object Properties .....	<b>57-63</b>
Create Data Objects from Built-In Data Class Package Simulink .....	<b>57-65</b>
Create Data Objects from Another Data Class Package .....	<b>57-66</b>
Create Data Objects Directly from Dialog Boxes .....	<b>57-67</b>
Create Data Objects for a Model Using Data Object Wizard .....	<b>57-68</b>
Create Data Objects from External Data Source Programmatically .....	<b>57-73</b>
Data Object Methods .....	<b>57-74</b>
Handle Versus Value Classes .....	<b>57-75</b>
Compare Data Objects .....	<b>57-77</b>
Create Persistent Data Objects .....	<b>57-78</b>
<b>Define Data Classes</b> .....	<b>57-80</b>
<b>Determine Where to Store Variables and Objects for Simulink Models</b> .....	<b>57-85</b>
Types of Data .....	<b>57-85</b>
Store Data for Your Design .....	<b>57-86</b>
Storage Locations .....	<b>57-88</b>
<b>Edit and Manage Workspace Variables Used by Models</b> .....	<b>57-92</b>
Finding Variables That Are Used by a Model or Block .....	<b>57-92</b>
Finding Blocks That Use a Specific Variable .....	<b>57-95</b>
Finding Unused Workspace Variables .....	<b>57-96</b>
Editing Workspace Variables .....	<b>57-98</b>
Rename Variables .....	<b>57-99</b>
Compare Duplicate Workspace Variables .....	<b>57-100</b>
Export Workspace Variables .....	<b>57-102</b>
Importing Workspace Variables .....	<b>57-104</b>
<b>Model Workspaces</b> .....	<b>57-106</b>
Model Workspace Differences from MATLAB Workspace .....	<b>57-106</b>
Troubleshooting Memory Issues .....	<b>57-107</b>

Manipulate Model Workspace Programmatically . . .	57-107
<b>Specify Source for Data in Model Workspace . . . . .</b>	<b>57-109</b>
Data source . . . . .	57-110
MAT-File and MATLAB File Source Controls . . . . .	57-111
MATLAB Code Source Controls . . . . .	57-112
<b>Change Model Workspace Data . . . . .</b>	<b>57-114</b>
Change Workspace Data Whose Source Is the Model File . . . . .	57-114
Change Workspace Data Whose Source Is a MAT-File or MATLAB File . . . . .	57-115
Changing Workspace Data Whose Source Is MATLAB Code . . . . .	57-115
Use MATLAB Commands to Change Workspace Data	57-116
Create Model Mask . . . . .	57-116
<b>Symbol Resolution . . . . .</b>	<b>57-118</b>
Symbols . . . . .	57-118
Symbol Resolution Process . . . . .	57-118
Numeric Values with Symbols . . . . .	57-120
Other Values with Symbols . . . . .	57-120
Limit Signal Resolution . . . . .	57-121
Explicit and Implicit Symbol Resolution . . . . .	57-121
<b>Configure Data Properties by Using a Table . . . . .</b>	<b>57-123</b>
Configure Distant Data Items . . . . .	57-123
Select Data Items in a Block Diagram . . . . .	57-125
Refine List by Filtering, Sorting, and Grouping . . . . .	57-126
Navigate to Blocks That Own Data . . . . .	57-127
Configure Data Interface for Component . . . . .	57-127
Purpose of Columns . . . . .	57-127
Model Data Editor Limitations . . . . .	57-128
<b>Upgrade Level-1 Data Classes . . . . .</b>	<b>57-130</b>
<b>Associating User Data with Blocks . . . . .</b>	<b>57-132</b>
<b>Support Limitations for Simulink Software Features</b>	<b>57-133</b>
<b>Supported and Unsupported Simulink Blocks . . . . .</b>	<b>57-136</b>



<b>Support Limitations for Stateflow Software Features</b>	<b>57-148</b>
ml Namespace Operator, ml Function, ml Expressions	57-148
C Math Functions	57-148
Atomic Subcharts That Call Exported Graphical Functions	
Outside a Subchart	57-149
Atomic Subchart Input and Output Mapping	57-149
Recursion and Cyclic Behavior	57-149
Custom C or C++ Code	57-151
Machine-Parented Data	57-151
Textual Functions with Literal String Arguments	57-151

## Enumerations and Modeling

### 58

<b>Simulink Enumerations</b>	<b>58-2</b>
Simulink Constructs that Support Enumerations	58-3
Simulink Enumeration Limitations	58-5
<b>Use Enumerated Data in Simulink Models</b>	<b>58-7</b>
Define Simulink Enumerations	58-7
Simulate with Enumerations	58-14
Specify Enumerations as Data Types	58-16
Get Information About Enumerated Data Types	58-17
Enumeration Value Display	58-18
Instantiate Enumerations	58-19
Enumerated Values in Computation	58-22

## Importing and Exporting Simulation Data

### 59

<b>Export Simulation Data</b>	<b>59-4</b>
Simulation Data	59-4
Approaches for Exporting Signal Data	59-5
Enable Simulation Data Export	59-7
View Logged Data Using Simulation Data Inspector	59-8
Memory Performance	59-8

<b>Provide Signal Data for Simulation</b> .....	<b>59-10</b>
Identify Model Signal Data Requirements .....	<b>59-10</b>
Load Input Signal Data .....	<b>59-11</b>
Log Output Signal Data .....	<b>59-11</b>
<b>Signal Data Storage for Loading</b> .....	<b>59-13</b>
MATLAB Workspace for Signal Data .....	<b>59-13</b>
Source and Signal Builder Blocks for Signal Data ...	<b>59-14</b>
MAT-Files for Signal Data .....	<b>59-15</b>
Spreadsheets for Signal Data .....	<b>59-15</b>
<b>Data Format for Logged Simulation Data</b> .....	<b>59-18</b>
Data Format for Block-Based Logged Data .....	<b>59-18</b>
Data Format for Model-Based Logged Data .....	<b>59-18</b>
Logged Data Store Format .....	<b>59-18</b>
Time, State, and Output Data Format .....	<b>59-18</b>
<b>Dataset Conversion for Logged Data</b> .....	<b>59-24</b>
Why Convert to Dataset Format? .....	<b>59-24</b>
Results of Conversion .....	<b>59-25</b>
Dataset Conversion Limitations .....	<b>59-27</b>
<b>Convert Logged Data to Dataset Format</b> .....	<b>59-28</b>
Convert Workspace Data to Dataset .....	<b>59-28</b>
Convert Structure Without Time to Dataset .....	<b>59-30</b>
Programmatically Access Logged Dataset Format Data .....	<b>59-34</b>
<b>Log Signal Data That Uses Units</b> .....	<b>59-40</b>
<b>Limit Amount of Exported Data</b> .....	<b>59-43</b>
Decimation .....	<b>59-43</b>
Limit Data Points .....	<b>59-44</b>
Logging Intervals .....	<b>59-44</b>
<b>Working with Big Data for Simulations</b> .....	<b>59-46</b>
Big Data Workflow .....	<b>59-46</b>
<b>Log Data to Persistent Storage</b> .....	<b>59-49</b>
When to Log to Persistent Storage .....	<b>59-49</b>
Log to Persistent Storage .....	<b>59-51</b>
Enable Logging to Persistent Storage Programmatically .....	<b>59-51</b>

How Simulation Data Is Stored . . . . .	59-52
Save Logged Data from Successive Simulations . . . . .	59-52
<b>Load Big Data for Simulations . . . . .</b>	<b>59-54</b>
Create References to Persistent Storage Dataset Objects . . . . .	59-54
Get List of Dataset Variables . . . . .	59-56
Create a SimulationDatastore for a Logged Signal . . . . .	59-57
Create a Dataset Object for Root-Level Imports . . . . .	59-58
Specify Data for an Input Dataset . . . . .	59-58
Stream Data into a Model . . . . .	59-60
<b>Analyze Big Data from a Simulation . . . . .</b>	<b>59-62</b>
Create DatasetRef Objects to Access Logged Datasets	59-62
Use SimulationDatastore Objects to Access Signal Data . . . . .	59-62
Create Timetables for MATLAB Analysis . . . . .	59-63
Create Tall Timetables . . . . .	59-63
Access Persistent Storage Metadata and Error Information . . . . .	59-63
Access Data Store Memory Data . . . . .	59-64
<b>Samples to Export for Variable-Step Solvers . . . . .</b>	<b>59-66</b>
Output Options . . . . .	59-66
Refine Output . . . . .	59-66
Produce Additional Output . . . . .	59-67
Produce Specified Output Only . . . . .	59-68
<b>Export Signal Data Using Signal Logging . . . . .</b>	<b>59-70</b>
Signal Logging . . . . .	59-70
Signal Logging Workflow . . . . .	59-70
Signal Logging in Rapid Accelerator Mode . . . . .	59-71
Signal Logging Limitations . . . . .	59-71
<b>Configure a Signal for Logging . . . . .</b>	<b>59-73</b>
Mark a Signal for Logging . . . . .	59-73
Specify Signal-Level Logging Name . . . . .	59-75
Limit Data Logged . . . . .	59-77
Set Sample Time for a Logged Signal . . . . .	59-78
<b>View the Signal Logging Configuration . . . . .</b>	<b>59-81</b>
Approaches for Viewing the Signal Logging Configuration . . . . .	59-81

Use Simulink Editor to View Signal Logging Configuration .....	59-82
View Logging Configuration with Signal Logging Selector .....	59-84
Use Model Explorer to View Signal Logging Configuration .....	59-86
Programmatically Find Signals Configured for Logging .....	59-87
<b>Enable Signal Logging for a Model .....</b>	<b>59-88</b>
Enable and Disable Logging at the Model Level .....	59-88
Migrate Scripts That Use ModelDataLogs API .....	59-89
Specify a Name for Signal Logging Data .....	59-91
<b>Override Signal Logging Settings .....</b>	<b>59-92</b>
Benefits of Overriding Signal Logging Settings .....	59-92
Two Interfaces for Overriding Signal Logging Settings .....	59-92
Scope of Signal Logging Setting Overrides .....	59-93
Override Signal Logging Settings with the Signal Logging Selector .....	59-93
Override Signal Logging Settings from MATLAB ...	59-99
<b>Access Signal Logging Data .....</b>	<b>59-106</b>
View Signal Logging Data .....	59-106
View Data in Simulation Data Inspector .....	59-106
Signal Logging Object .....	59-107
Access Data Programmatically .....	59-107
Handling Spaces and Newlines in Logged Names ..	59-108
Access Logged Signal Data in ModelDataLogs Format .....	59-110
<b>Log Signals in For Each Subsystems .....</b>	<b>59-111</b>
Log Signal in Nested For Each Subsystem .....	59-111
Log Bus Signals in For Each Subsystem .....	59-113
<b>Overview of Signal Loading Techniques .....</b>	<b>59-116</b>
Source Blocks .....	59-116
Root-Level Input Ports .....	59-117
From File Block .....	59-119
From Spreadsheet Block .....	59-120
From Workspace Block .....	59-121
Signal Builder Block .....	59-122

<b>Comparison of Signal Loading Techniques</b> . . . . .	<b>59-124</b>
Techniques . . . . .	59-124
Impact of Loading Techniques on Block Diagrams . . . . .	59-125
Comparison of Techniques . . . . .	59-126
<b>Map Data Using Root Inport Mapper Tool</b> . . . . .	<b>59-132</b>
The Model . . . . .	59-132
Create Signal Data . . . . .	59-133
Import and Visualize Workspace Signal Data . . . . .	59-134
Map the Data to Inports . . . . .	59-135
Save the Mapping and Data . . . . .	59-136
Simulate the Model . . . . .	59-136
<b>Log Simulation Data for Roundtrip Data Loading</b> . . . . .	<b>59-138</b>
Use Dataset Format for Consistent Logged Data . . . . .	59-138
Limit the Scope of Logged Data . . . . .	59-139
<b>Import Data to Model a Continuous Plant</b> . . . . .	<b>59-140</b>
Use Simulation Data to Model a Continuous Plant . . . . .	59-140
<b>Import Data to Test a Discrete Algorithm</b> . . . . .	<b>59-143</b>
<b>Import Data for an Input Test Case</b> . . . . .	<b>59-145</b>
Guidelines for Importing a Test Case . . . . .	59-145
Example of Test Case Data . . . . .	59-146
Use From Workspace Block for Test Case . . . . .	59-146
Use Signal Builder Block for Test Case . . . . .	59-147
<b>Specify Data for Root-Level Input Ports</b> . . . . .	<b>59-149</b>
Root-Level Input Ports . . . . .	59-149
Specify Input Data . . . . .	59-150
Forms of Input Data . . . . .	59-151
Time Data for the Input Parameter . . . . .	59-151
<b>Create Data for a From File Block</b> . . . . .	<b>59-153</b>
Data Saved by a To File Block . . . . .	59-153
Supported MAT-File Versions . . . . .	59-153
Storage Formats . . . . .	59-154
Timestamps . . . . .	59-155
Bus Data . . . . .	59-155
MAT-File Variable . . . . .	59-155

<b>Create Data for a From Workspace Block</b> .....	<b>59-157</b>
Use Data from a To Workspace Block .....	<b>59-157</b>
Specify Variable-Size Signals .....	<b>59-157</b>
Data for the From Workspace Block .....	<b>59-157</b>
Bus Data .....	<b>59-161</b>
Use Data from a To File Block .....	<b>59-161</b>
Store Data for Model Linked to Data Dictionary ...	<b>59-161</b>
<b>Load Signal Logging Data</b> .....	<b>59-162</b>
<b>Load Data to Root-Level Input Ports</b> .....	<b>59-164</b>
Loading the Data .....	<b>59-164</b>
<b>Import Bus Data to Top-Level Input Ports</b> .....	<b>59-166</b>
Imported Bus Data Requirements .....	<b>59-166</b>
Import Bus Data to a Top-Level Inport .....	<b>59-167</b>
Get Information about Bus Objects .....	<b>59-170</b>
Create Structures of Timeseries Objects from Buses	<b>59-170</b>
Import Array of Buses Data .....	<b>59-171</b>
<b>Map Root Inport Signal Data</b> .....	<b>59-178</b>
Open the Root Inport Mapper Tool .....	<b>59-178</b>
Command-Line Interface .....	<b>59-179</b>
Import and Mapping Workflow .....	<b>59-179</b>
Choose a Map Mode .....	<b>59-179</b>
<b>Create Signal Data for Root Inport Mapping</b> .....	<b>59-181</b>
Identify Signal Data to Import and Map .....	<b>59-181</b>
Choose a Naming Convention for Signal and Buses .	<b>59-182</b>
Choose a Base Workspace and MAT-File Format ...	<b>59-182</b>
Bus Signal Data for Root Inport Mapping .....	<b>59-183</b>
Create Signal Data in a MAT-File for Root Inport	
Mapping .....	<b>59-184</b>
Supported Microsoft Excel File Formats .....	<b>59-185</b>
<b>Import Signal Data for Root Inport Mapping</b> .....	<b>59-187</b>
Import Signal Data .....	<b>59-187</b>
Import Bus Data .....	<b>59-189</b>
Import Signal Data from Other Sources .....	<b>59-189</b>
Import Test Vectors from Simulink Design Verifier	
Environment .....	<b>59-189</b>
<b>View and Inspect Signal Data</b> .....	<b>59-191</b>

<b>Create and Edit Signal Data</b> .....	<b>59-194</b>
Signal Editor Table Editing Limitations .....	<b>59-194</b>
Create Signal Data .....	<b>59-195</b>
Work with Signal Data .....	<b>59-199</b>
Save and Send Changes to the Root Inport Mapper Tool .....	<b>59-202</b>
Create Signals with the Same Properties .....	<b>59-202</b>
Add Signals to Scenarios .....	<b>59-204</b>
Work with Data in Signals .....	<b>59-207</b>
<b>Map Signal Data to Root Inports</b> .....	<b>59-210</b>
Select Map Mode .....	<b>59-210</b>
Set Options for Mapping .....	<b>59-211</b>
Select Data to Map .....	<b>59-212</b>
Map Data .....	<b>59-212</b>
Understand Mapping Results .....	<b>59-213</b>
Converting Harness-Driven Models to Use Harness-Free External Inputs .....	<b>59-216</b>
Alternative Workflows to Load Data .....	<b>59-223</b>
<b>Preview Signal Data</b> .....	<b>59-226</b>
<b>Generate MATLAB Scripts for Simulation with     Scenarios</b> .....	<b>59-229</b>
<b>Create and Use Custom Map Modes</b> .....	<b>59-230</b>
Create Custom Mapping File Function .....	<b>59-230</b>
<b>Root Inport Mapping Scenarios</b> .....	<b>59-233</b>
Open Scenarios .....	<b>59-233</b>
Save Scenarios .....	<b>59-234</b>
Open Existing Scenarios .....	<b>59-234</b>
Work with Multiple Scenarios .....	<b>59-235</b>
<b>Load Signal Data That Uses Units</b> .....	<b>59-237</b>
Loading Bus Signals That Have Units .....	<b>59-237</b>
<b>Load Data Using the From File Block</b> .....	<b>59-239</b>
Data Loading .....	<b>59-239</b>
Sample Time .....	<b>59-240</b>
Simulation Time Hits Without Corresponding Time Data .....	<b>59-240</b>
Duplicate Timestamps .....	<b>59-240</b>

Detect Zero Crossings . . . . .	59-241
<b>Load Data Using the From Workspace Block . . . . .</b>	<b>59-242</b>
Specify the Workspace Data . . . . .	59-242
Sample Time . . . . .	59-243
Interpolate Missing Data Values . . . . .	59-243
Specify Output After Final Data . . . . .	59-243
Detect Zero Crossings . . . . .	59-244
<b>Create Dataset Data for Root Inport Ports . . . . .</b>	<b>59-245</b>
Specify a Dataset Using the Input Parameter . . . . .	59-245
Dataset Elements . . . . .	59-245
Import Dataset Objects for Buses . . . . .	59-246
Create Dataset Object for Inport Blocks . . . . .	59-246
<b>Create MATLAB Timeseries Data for Root Inports . . . . .</b>	<b>59-248</b>
Specify Time Dimension . . . . .	59-248
Models with Multiple Root Inport Blocks . . . . .	59-249
<b>Create Data Arrays for Root-Level Inports . . . . .</b>	<b>59-250</b>
Data Array Format . . . . .	59-250
Specify the Input Expression . . . . .	59-250
Arrays for Input Ports Driving Function-Call Subsystems . . . . .	59-251
<b>Create MATLAB Time Expressions for Root Inports . . . . .</b>	<b>59-254</b>
Specify the Input Expression . . . . .	59-254
<b>Create Data Structures for Root Inports . . . . .</b>	<b>59-255</b>
Data Structures . . . . .	59-255
Structures for All Ports or for Each Port . . . . .	59-256
Specify Signal Data . . . . .	59-256
Specify Time Data . . . . .	59-257
Examples of Specifying Signal and Time Data . . . . .	59-258
<b>State Information . . . . .</b>	<b>59-261</b>
Simulation State Information . . . . .	59-261
Types of State Information . . . . .	59-261
Format for State Information Saved Without SimState . . . . .	59-264
State Information for Referenced Models . . . . .	59-265



<b>Save State Information</b> .....	<b>59-267</b>
Save State Information for Each Simulation Step ..	59-267
Save Partial Final State Information .....	59-267
Examine State Information Saved Without the SimState .....	59-268
Save Final State Information with SimState .....	59-270
<b>Load State Information</b> .....	<b>59-271</b>
Import Initial States .....	59-271
Initialize a State .....	59-271
Initialize States in Referenced Models .....	59-273

## Working with Data Stores

# 60

<b>Data Store Basics</b> .....	<b>60-2</b>
When to Use a Data Store .....	60-2
Local and Global Data Stores .....	60-3
Data Store Diagnostics .....	60-3
Specify Initial Value for Data Store .....	60-11
<b>Model Global Data by Creating Data Stores</b> .....	<b>60-13</b>
Data Store Examples .....	60-13
Create and Apply Data Stores .....	60-15
Data Stores with Data Store Memory Blocks .....	60-17
Data Stores with Signal Objects .....	60-20
Access Data Stores with Simulink Blocks .....	60-22
Order Data Store Access .....	60-24
Data Stores with Buses and Arrays of Buses .....	60-30
Accessing Specific Bus and Matrix Elements .....	60-31
Rename Data Stores .....	60-36
Customized Data Store Access Functions in Generated Code .....	60-38
<b>Log Data Stores</b> .....	<b>60-39</b>
Logging Local and Global Data Store Values .....	60-39
Supported Data Types, Dimensions, and Complexity for Logging Data Stores .....	60-39
Data Store Logging Limitations .....	60-40

Logging Data Stores Created with a Data Store Memory Block .....	60-40
Logging Icon for the Data Store Memory Block .....	60-40
Logging Data Stores Created with a Simulink.Signal Object .....	60-41
Accessing Data Store Logging Data .....	60-41

## Simulink Data Dictionary

# 61

<b>What Is a Data Dictionary?</b> .....	61-2
Dictionary Capabilities .....	61-2
Sections of a Dictionary .....	61-3
Manage and Edit Entries in a Dictionary .....	61-4
Dictionary Referencing .....	61-4
Import and Export File Formats .....	61-4
<b>Migrate Models to Use Simulink Data Dictionary</b> .....	61-6
Migrate Single Model to Use Dictionary .....	61-6
Migrate Model Reference Hierarchy to Use Dictionary ..	61-8
Considerations before Migrating to Data Dictionary ..	61-9
<b>Enumerations in Data Dictionary</b> .....	61-14
Migrate Enumerated Types into Data Dictionary .....	61-14
Manipulate Enumerations in Data Dictionary .....	61-18
<b>Import and Export Dictionary Data</b> .....	61-20
Import Data to Dictionary from File .....	61-20
Export Design Data from Dictionary .....	61-25
<b>View and Revert Changes to Dictionary Data</b> .....	61-27
View and Revert Changes to Dictionary Entries .....	61-27
View and Revert Changes to Entire Dictionary .....	61-31
<b>Partition Dictionary Data Using Referenced Dictionaries</b> .....	61-34
<b>Partition Data for Model Reference Hierarchy Using Data Dictionaries</b> .....	61-37
Create a Dictionary for Each Component .....	61-37

Migrate Model Hierarchy to Dictionaries Incrementally .....	61-47
<b>Store Data in Dictionary Programmatically .....</b>	<b>61-52</b>
Add Entry to Design Data Section of Data Dictionary .....	61-52
Increment Value of Data Dictionary Entry .....	61-53
Data Dictionary Management .....	61-53
Dictionary Section Management .....	61-54
Dictionary Entry Manipulation .....	61-55
Transition to Using Data Dictionary .....	61-56
Programmatically Migrate Single Model to Use Dictionary .....	61-57
Import Directly From External File to Dictionary ...	61-57
Programmatically Partition Data Dictionary .....	61-59

## Managing Signals

### Working with Signals

# 62

<b>Signal Basics .....</b>	<b>62-2</b>
About Signals .....	62-2
Creating Signals .....	62-3
Signal Line Styles .....	62-3
Signal Properties .....	62-4
Store Design Attributes of Signals and States .....	62-6
Testing Signals .....	62-6
<b>Signal Types .....</b>	<b>62-8</b>
Summary of Signal Types .....	62-8
Control Signals .....	62-8
Composite (Bus) Signals .....	62-9
<b>Virtual Signals .....</b>	<b>62-11</b>
About Virtual Signals .....	62-11
Mux Signals .....	62-11

<b>Signal Values</b> .....	<b>62-15</b>
Signal Data Types .....	<b>62-15</b>
Signal Dimensions, Size, and Width .....	<b>62-15</b>
Complex Signals .....	<b>62-15</b>
Initializing Signal Values .....	<b>62-16</b>
Viewing Signal Values .....	<b>62-16</b>
Displaying Signal Values in Model Diagrams .....	<b>62-17</b>
Exporting Signal Data .....	<b>62-18</b>
<b>Signal Label Propagation</b> .....	<b>62-19</b>
Propagated Signal Labels .....	<b>62-19</b>
Blocks That Support Signal Label Propagation .....	<b>62-19</b>
Display Propagated Signal Labels .....	<b>62-20</b>
How Simulink Propagates Signal Labels .....	<b>62-21</b>
<b>Signal Dimensions</b> .....	<b>62-30</b>
About Signal Dimensions .....	<b>62-30</b>
Simulink Blocks that Support Multidimensional Signals .....	<b>62-31</b>
<b>Determine Output Signal Dimensions</b> .....	<b>62-32</b>
About Signal Dimensions .....	<b>62-32</b>
Determining the Output Dimensions of Source Blocks .....	<b>62-32</b>
Determining the Output Dimensions of Nonsource Blocks .....	<b>62-33</b>
Signal and Parameter Dimension Rules .....	<b>62-33</b>
Scalar Expansion of Inputs and Parameters .....	<b>62-34</b>
<b>Display Signal Sources and Destinations</b> .....	<b>62-38</b>
About Signal Highlighting .....	<b>62-38</b>
Highlighting Signal Sources .....	<b>62-38</b>
Highlighting Signal Destinations .....	<b>62-39</b>
Removing Highlighting .....	<b>62-40</b>
Resolving Incomplete Highlighting to Library Blocks .....	<b>62-40</b>
<b>Signal Ranges</b> .....	<b>62-41</b>
About Signal Ranges .....	<b>62-41</b>
Blocks That Allow Signal Range Specification .....	<b>62-41</b>
Specify Ranges for Signals .....	<b>62-42</b>
Check for Signal Range Errors .....	<b>62-44</b>
Unexpected Errors or Warnings for Data with Greater Precision or Range than <code>double</code> .....	<b>62-46</b>
Optimize Generated Code .....	<b>62-47</b>

<b>Initialize Signals and Discrete States</b> .....	<b>62-48</b>
About Initialization .....	<b>62-48</b>
Using Block Parameters to Initialize Signals and Discrete States .....	<b>62-49</b>
Use Signal Objects to Initialize Signals and Discrete States .....	<b>62-49</b>
Using Signal Objects to Tune Initial Values .....	<b>62-51</b>
Example: Using a Signal Object to Initialize a Subsystem Output .....	<b>62-52</b>
Initialization Behavior Summary for Signal Objects .	<b>62-53</b>
<b>Test Points</b> .....	<b>62-56</b>
What Is a Test Point? .....	<b>62-56</b>
Configure Signals as Test Points .....	<b>62-56</b>
Displaying Test Point Indicators .....	<b>62-57</b>
<b>Display Signal Attributes</b> .....	<b>62-59</b>
Ports & Signals Menu .....	<b>62-59</b>
Port Data Types .....	<b>62-60</b>
Design Ranges .....	<b>62-61</b>
Signal Dimensions .....	<b>62-62</b>
Signal to Object Resolution Indicator .....	<b>62-63</b>
Wide Nonscalar Lines .....	<b>62-64</b>
<b>Signal Groups</b> .....	<b>62-65</b>
About Signal Groups .....	<b>62-65</b>
Using the Signal Builder Block with Fast Restart . . .	<b>62-65</b>
Signal Builder Window .....	<b>62-66</b>
Creating Signal Group Sets .....	<b>62-80</b>
Editing Waveforms .....	<b>62-106</b>
Signal Builder Time Range .....	<b>62-111</b>
Exporting Signal Group Data .....	<b>62-112</b>
Printing, Exporting, and Copying Waveforms .....	<b>62-114</b>
Simulating with Signal Groups .....	<b>62-114</b>
Simulation Options Dialog Box .....	<b>62-115</b>

<b>Overview of Composite Signal Techniques</b> .....	<b>63-3</b>
Buses .....	63-3
Bus Element Ports .....	63-6
Arrays of Buses .....	63-7
Muxes .....	63-9
Concatenated Contiguous Output Signals .....	63-9
<b>Select a Composite Signal Technique</b> .....	<b>63-11</b>
Virtual Bus Usage Guidelines .....	63-11
Nonvirtual Bus Usage Guidelines .....	63-11
Bus Element Port Usage Guidelines .....	63-12
Array of Buses Usage Guidelines .....	63-14
Mux Usage Guidelines .....	63-14
Concatenated Contiguous Output Signal Guidelines ..	63-15
<b>Getting Started with Buses</b> .....	<b>63-16</b>
Create and Use Virtual Buses .....	63-16
Create and Use Nonvirtual Buses .....	63-19
Generate Code for Buses .....	63-22
<b>Simplify Subsystem Bus Interfaces</b> .....	<b>63-26</b>
Bus Element Ports .....	63-27
Create Bus Element Ports .....	63-28
Convert Models to Use Bus Element Ports .....	63-30
<b>Display Information About Buses</b> .....	<b>63-37</b>
Signal Hierarchy Viewer .....	63-37
Port Value Display .....	63-39
CompiledBusType and SignalHierarchy Parameters ..	63-41
<b>Bus-Capable Blocks</b> .....	<b>63-43</b>
<b>Nested Buses</b> .....	<b>63-46</b>
Circular Dependency in Bus Definitions .....	63-47
<b>Assign Signal Values to a Bus</b> .....	<b>63-48</b>
Update a Bus Element .....	63-48

<b>Correct Buses Used as Vectors</b> .....	<b>63-51</b>
Three Approaches .....	<b>63-51</b>
Use the Model Advisor .....	<b>63-51</b>
Explicitly Add Bus to Vector Blocks .....	<b>63-51</b>
Reorganize the Model .....	<b>63-53</b>
Bus to Vector Block Compatibility Issues .....	<b>63-54</b>
<b>Specify Bus Signal Sample Times</b> .....	<b>63-55</b>
Sample Times for Nonvirtual Buses .....	<b>63-55</b>
Specify Sample Times for Signal Elements .....	<b>63-57</b>
<b>When to Use Bus Objects</b> .....	<b>63-59</b>
Required Uses of Bus Objects .....	<b>63-60</b>
Optional Uses of Bus Object .....	<b>63-60</b>
Bus Object Use with Blocks .....	<b>63-60</b>
Bus Object Workflow .....	<b>63-62</b>
<b>Create Bus Objects with the Bus Editor</b> .....	<b>63-63</b>
Open the Bus Editor .....	<b>63-63</b>
Create Bus Objects .....	<b>63-63</b>
Create Bus Elements for the Bus Object .....	<b>63-65</b>
Nest Bus Object Definitions .....	<b>63-68</b>
Use the Bus Objects in the Model .....	<b>63-71</b>
<b>Create Bus Objects Programmatically</b> .....	<b>63-73</b>
Create Simulink.Bus and Simulink.BusElement Objects Directly .....	<b>63-73</b>
Create Bus Objects from Blocks .....	<b>63-74</b>
Create Bus Objects from MATLAB Data .....	<b>63-74</b>
<b>Modify Bus Objects</b> .....	<b>63-76</b>
Edit Bus Objects .....	<b>63-77</b>
Edit Bus Element Objects .....	<b>63-77</b>
Copy and Paste Bus Objects and Elements .....	<b>63-77</b>
Change the Order of Bus Elements .....	<b>63-77</b>
Delete Bus Objects and Bus Elements .....	<b>63-78</b>
Filter Displayed Bus Objects .....	<b>63-78</b>
<b>Save and Import Bus Objects</b> .....	<b>63-82</b>
Locations for Saving Bus Objects .....	<b>63-83</b>
Data Dictionary .....	<b>63-84</b>
MATLAB Code File .....	<b>63-84</b>
MAT-File .....	<b>63-85</b>

Database or Other External Files .....	63-87
<b>Map Bus Objects to Models .....</b>	<b>63-88</b>
Use a Rigorous Naming Convention .....	63-88
<b>Customize Bus Object Import and Export .....</b>	<b>63-90</b>
Required Background Knowledge .....	63-90
Write a Bus Object Export Function .....	63-91
Write a Bus Object Import Function .....	63-91
Register Customizations .....	63-92
Change Customizations .....	63-93
<b>Use Buses for Inports and Outports .....</b>	<b>63-95</b>
Use Buses with Root-Level Inports .....	63-95
Use Buses with Root-Level Outports .....	63-95
Buses for Atomic Subsystem Nonvirtual Inports .....	63-96
Buses with Model Referencing .....	63-98
<b>Specify Initial Conditions for Bus Signals .....</b>	<b>63-99</b>
Bus Signal Initialization .....	63-99
Create Initial Condition Structures .....	63-100
Initialize Bus Signals Using Block Parameters .....	63-105
Set Diagnostics to Support Bus Signal Initialization .....	63-108
<b>Combine Buses into an Array of Buses .....</b>	<b>63-110</b>
What Is an Array of Buses? .....	63-110
Benefits of an Array of Buses .....	63-111
Define an Array of Buses .....	63-112
<b>Use Arrays of Buses in Models .....</b>	<b>63-115</b>
Array of Buses Requirements and Limitations .....	63-115
Blocks That Support Arrays of Buses .....	63-116
Signal Line Style .....	63-118
<b>Work with Array of Buses Signals .....</b>	<b>63-120</b>
Set Up Model for Arrays of Buses .....	63-120
Perform Iterative Processing .....	63-121
Assign Values into an Array of Buses .....	63-122
Select Bus Elements from an Array of Buses .....	63-122
Import Array of Buses Data .....	63-123
Log Array of Buses Signals .....	63-123
Initialize Arrays of Buses .....	63-124
Code Generation .....	63-126



<b>Convert Models to Use Arrays of Buses</b> .....	<b>63-127</b>
General Conversion Approach .....	<b>63-127</b>
<b>Repeat an Algorithm Using a For Each Subsystem</b> .	<b>63-131</b>
Explore Example Model .....	<b>63-131</b>
Reduce Signal Line Density with Buses .....	<b>63-132</b>
Repeat an Algorithm .....	<b>63-135</b>
Organize Parameters into Arrays of Structures ....	<b>63-138</b>
Inspect the Converted Model .....	<b>63-140</b>
<b>Bus Data Crossing Model Reference Boundaries</b> ...	<b>63-142</b>
Connect Multi-Rate Buses to Referenced Models ...	<b>63-142</b>
Limitations for Virtual Buses .....	<b>63-143</b>
Update Models Saved Before R2016a .....	<b>63-143</b>
<b>Bus Conversion</b> .....	<b>63-145</b>
<b>Buses and Libraries</b> .....	<b>63-146</b>
<b>Buses in the Generated Code</b> .....	<b>63-147</b>
Control Data Types of Initial Condition Structure	
Fields .....	<b>63-148</b>
Limitations for Virtual Buses Crossing Model Reference	
Boundaries .....	<b>63-154</b>
Code Generation for Arrays of Buses .....	<b>63-155</b>

## Working with Variable-Size Signals

# 64

<b>Variable-Size Signal Basics</b> .....	<b>64-2</b>
About Variable-Size Signals .....	<b>64-2</b>
Creating Variable-Size Signals .....	<b>64-2</b>
How Variable-Size Signals Propagate .....	<b>64-3</b>
Programmatically Determine Whether Signal Line Has	
Variable Size .....	<b>64-4</b>
Empty Signals .....	<b>64-5</b>
Subsystem Initialization of Variable-Size Signals ....	<b>64-5</b>
<b>Simulink Models Using Variable-Size Signals</b> .....	<b>64-7</b>
Variable-Size Signal Generation and Operations .....	<b>64-7</b>

Variable-Size Signal Length Adaptation .....	64-11
Mode-Dependent Variable-Size Signals .....	64-15
<b>S-Functions Using Variable-Size Signals .....</b>	<b>64-21</b>
Level-2 MATLAB S-Function with Variable-Size Signals .....	64-21
C S-Function with Variable-Size Signals .....	64-22
<b>Simulink Block Support for Variable-Size Signals ..</b>	<b>64-24</b>
Simulink Block Data Type Support .....	64-24
Conditionally Executed Subsystem Blocks .....	64-24
Switching Blocks .....	64-25
<b>Variable-Size Signal Limitations .....</b>	<b>64-28</b>

## Customizing Simulink Environment and Printed Models

### 65 | Customizing the Simulink User Interface

<b>Add Items to Model Editor Menus .....</b>	<b>65-2</b>
About Adding Items .....	65-2
Code for Adding Menu Items .....	65-2
Define Menu Items .....	65-4
Register Menu Customizations .....	65-10
Callback Info Object .....	65-10
Debugging Custom Menu Callbacks .....	65-11
Menu Tags .....	65-11
<b>Disable and Hide Model Editor Menu Items .....</b>	<b>65-16</b>
About Disabling and Hiding Model Editor Menu Items	65-16
Example: Disabling the New Model Command on the Simulink Editor's File Menu .....	65-16
Creating a Filter Function .....	65-16
Registering a Filter Function .....	65-17
<b>Disable and Hide Dialog Box Controls .....</b>	<b>65-18</b>
About Disabling and Hiding Controls .....	65-18

Disable a Button on a Dialog Box . . . . .	65-18
Write Control Customization Callback Functions . . . . .	65-19
Dialog Box Methods . . . . .	65-20
Dialog Box and Widget IDs . . . . .	65-20
Register Control Customization Callback Functions . . . . .	65-21
<b>Customize Library Browser Appearance . . . . .</b>	<b>65-23</b>
Reorder Libraries . . . . .	65-23
Disable and Hide Libraries . . . . .	65-24
Expand or Collapse Library in Browser Tree . . . . .	65-25
<b>Registering Customizations . . . . .</b>	<b>65-26</b>
About Registering Customizations in Simulink . . . . .	65-26
Reading and Refreshing the Customization File . . . . .	65-27

## Frames for Printed Models

# 66

<b>Print Frames . . . . .</b>	<b>66-2</b>
What Are Print Frames? . . . . .	66-2
PrintFrame Editor . . . . .	66-3
Single Use or Multiple Use Print Frames . . . . .	66-4
Text and Variable Content . . . . .	66-5
<b>Create a Print Frame . . . . .</b>	<b>66-6</b>
<b>Add Rows and Cells to Print Frames . . . . .</b>	<b>66-7</b>
Add and Remove Rows . . . . .	66-7
Add and Remove Cells . . . . .	66-7
Resize Rows and Cells . . . . .	66-7
<b>Add Content to Print Frame Cells . . . . .</b>	<b>66-9</b>
Types of Content . . . . .	66-9
Add Content to Cells . . . . .	66-9
Block Diagram . . . . .	66-10
Variables . . . . .	66-10
Text . . . . .	66-11
Format Content in Cells . . . . .	66-12
<b>Print Using Print Frames . . . . .</b>	<b>66-13</b>

# Running Models on Target Hardware

## About Run on Target Hardware Feature

**67**

<b>Simulink Supported Hardware</b> .....	<b>67-2</b>
<b>Tune and Monitor Models Running on Target</b>	
<b>Hardware</b> .....	<b>67-3</b>
Overview of Using External Mode .....	<b>67-3</b>
Run Your Simulink Model in External Mode .....	<b>67-4</b>
Stop External Mode .....	<b>67-5</b>
External Mode Control Panel .....	<b>67-5</b>
<b>Block Produces Zeros or Does Nothing in Simulation</b> .	<b>67-8</b>

## Running Simulations in Fast Restart

**68**

<b>How Fast Restart Improves Iterative Simulations</b> .....	<b>68-2</b>
<b>Fast Restart Workflow</b> .....	<b>68-4</b>
<b>Get Started with Fast Restart</b> .....	<b>68-6</b>
Prepare a Model to Use Fast Restart .....	<b>68-6</b>
Enable Fast Restart .....	<b>68-6</b>
<b>Simulate a Model Using Fast Restart</b> .....	<b>68-8</b>
<b>Stop Simulation and Exit Fast Restart</b> .....	<b>68-10</b>
Stop a Simulation .....	<b>68-10</b>
Exit Fast Restart .....	<b>68-10</b>
<b>Fast Restart Methodology</b> .....	<b>68-11</b>
Simulation Modes .....	<b>68-11</b>
Tuning Parameters Between Simulations .....	<b>68-11</b>
Model Methods and Callbacks in Fast Restart .....	<b>68-11</b>

SimState and Initial State Values .....	68-13
Analyze Data Using the Simulation Data Inspector .....	68-13
Custom Code in the Initialize Function .....	68-13
<b>Factors Affecting Fast Restart .....</b>	<b>68-15</b>

## Package Models to Share

---

# 69

Packaged Models .....	69-2
-----------------------	------



# Introduction to Simulink





# Simulink Basics

---

The following sections explain how to perform basic tasks when using the Simulink product.

- “Start the Simulink Software” on page 1-2
- “Create Models and Open Existing Models” on page 1-5
- “Programmatic Modeling Basics” on page 1-14
- “Build and Edit a Model in the Simulink Editor” on page 1-24
- “Save a Model” on page 1-38
- “Model Editing Environment” on page 1-46
- “Parts of a Model” on page 1-54
- “Preview Content of Hierarchical Items” on page 1-58
- “Use Viewmarks to Save Views of Models” on page 1-61
- “Update Diagram and Run Simulation” on page 1-65
- “Print Model Diagrams” on page 1-68
- “Basic Printing” on page 1-70
- “Select the Systems to Print” on page 1-74
- “Specify the Page Layout and Print Job” on page 1-76
- “Tiled Printing” on page 1-77
- “Print Multiple Pages for Large Models” on page 1-78
- “Add a Log of Printed Models” on page 1-79
- “Add a Sample Time Legend” on page 1-80
- “Print from the MATLAB Command Line” on page 1-81
- “Print to a PDF” on page 1-85
- “Print Model Reports” on page 1-86
- “Print Models to Image File Formats” on page 1-89
- “Keyboard and Mouse Actions for Simulink Modeling” on page 1-90

## Start the Simulink Software

To build models, use the Simulink Editor and the Library Browser.

### Start the MATLAB Software

Before you start Simulink, start MATLAB®. See “Startup and Shutdown” (MATLAB).

#### Configure MATLAB to Start Simulink

The first model that you open in a MATLAB session takes longer to open than subsequent models because, by default, MATLAB starts Simulink when opening the first model. This just-in-time starting of Simulink reduces MATLAB startup time and avoids unnecessary system memory use.

To speed up opening the first model, you can configure MATLAB startup to also start Simulink. To start Simulink without opening models or the Library Browser, use `start_simulink`.

Depending on how you start MATLAB, use the command:

- In the MATLAB `startup.m` file
- At the operating system command line, with the `matlab` command and the `-r` switch

For example, to start Simulink when MATLAB starts on a computer running the Microsoft® Windows® operating system, create a desktop shortcut with this target:

```
matlabroot\bin\win64\matlab.exe -r start_simulink
```

On Macintosh and Linux® computers, use this command to start Simulink when you start MATLAB:

```
matlab -r start_simulink
```

### Open the Simulink Editor

To open the Simulink Editor, you can:

- Create a model. On the MATLAB **Home** tab, click **Simulink** and choose a model template.

Alternatively, if you already have the Library Browser open, click the **New Model** button . For additional ways to create a model, see “Create a Model” on page 1-5.

- Open an existing model. To open recent models, on the MATLAB **Home** tab, click **Simulink**.

Alternatively, if you know the name of the model you want, at the MATLAB command prompt, enter the name, such as `vdp`. For additional ways to open a model, see “Open a Model” on page 1-10.

---

**Tip:** The Simulink Editor opens on top of the MATLAB desktop. To move the MATLAB desktop on top, in the Simulink Editor, select **View > MATLAB Desktop**.

---

## Open the Library Browser

Use any of these techniques to open the Simulink Library Browser from MATLAB:

- On the **Home** tab, click **Simulink**, and choose a model template. In the new model, click the **Library Browser** button .
- At the command prompt, enter `slLibraryBrowser`.

The Library Browser opens and displays a tree view of the Simulink block libraries on your system. As you click libraries in the tree, the contents of the library appear in the right pane.

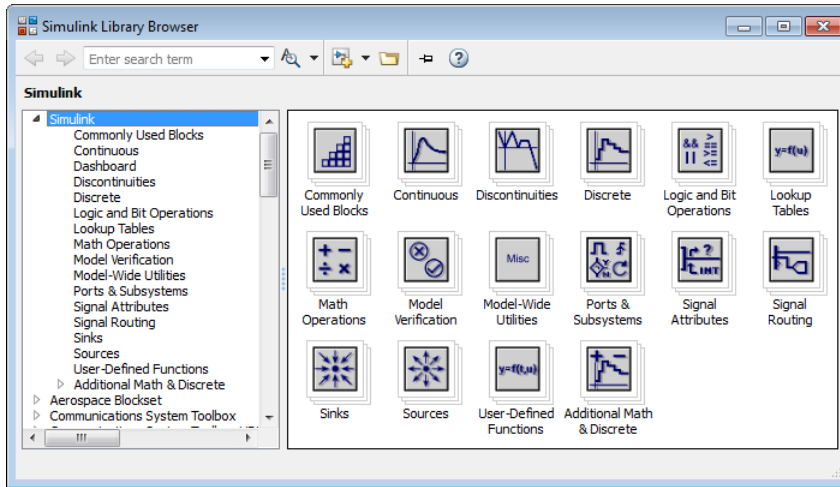

---

**Note:** Simulink comes with block libraries in addition to the Simulink library. These libraries support simulating supplied example models that contain blocks from those libraries. However, you can generate code or modify these blocks only with the relevant product licenses.

---

## Related Examples

- “Create Models and Open Existing Models” on page 1-5
- “Build and Edit a Model in the Simulink Editor” on page 1-24

## More About

- “Model Editing Environment” on page 1-46

## Create Models and Open Existing Models

### In this section...

“Create a Model” on page 1-5

“Use Customized Settings When Creating New Models” on page 1-8

“Open a Model” on page 1-10

“Load Variables When Opening a Model” on page 1-11

“Open a Model with Different Character Encoding” on page 1-12

“Simulink Model File Types” on page 1-12

### Create a Model

- 1 On the MATLAB **Home** tab, click **Simulink**.
- 2 In the Simulink start page, choose a template or search the templates.

Model templates are starting points to apply common modeling approaches. They help you reuse settings and block configurations and share knowledge. Use model and project templates to apply best practices and take advantage of previous modeling solutions.

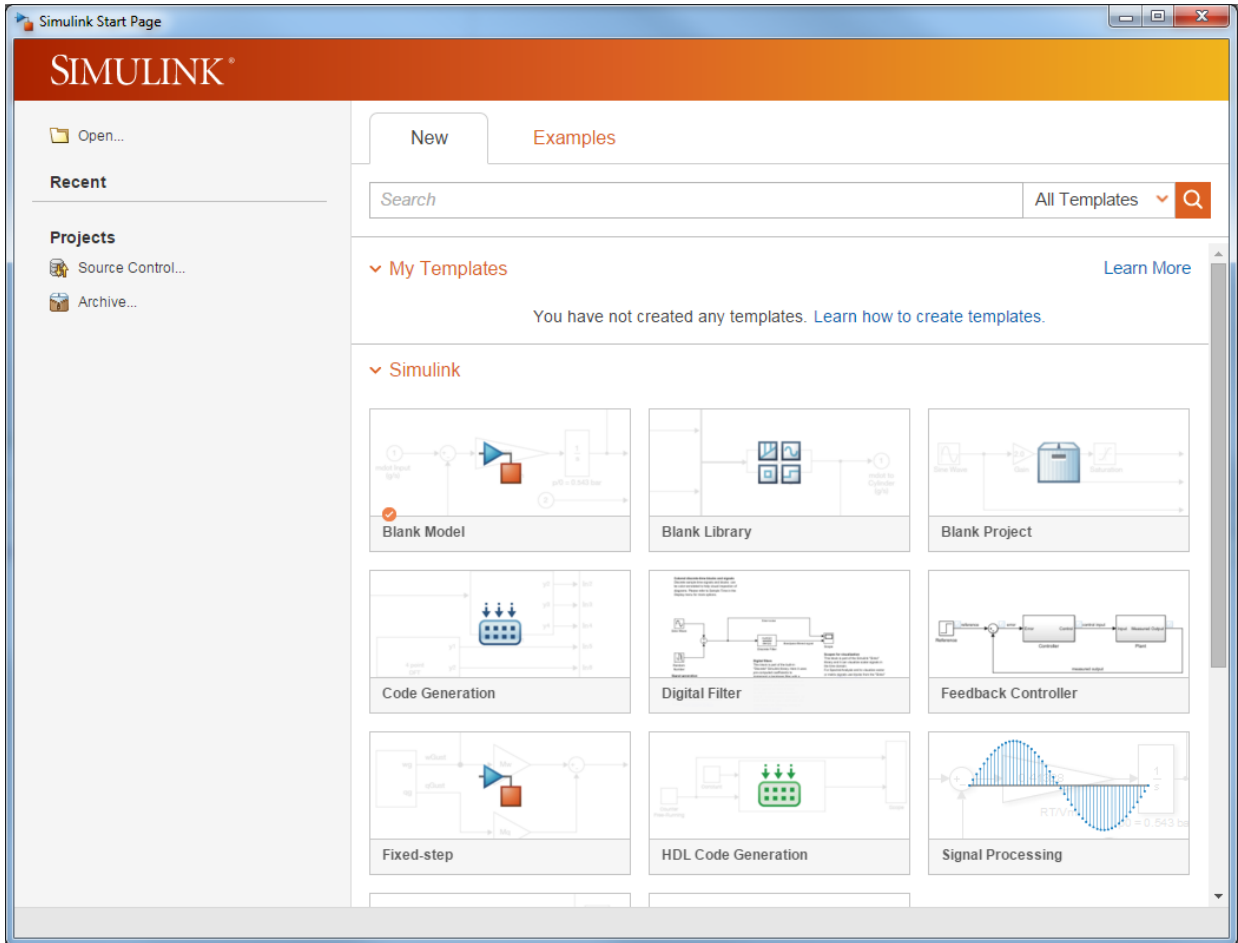

Click the title of a template to read the description.

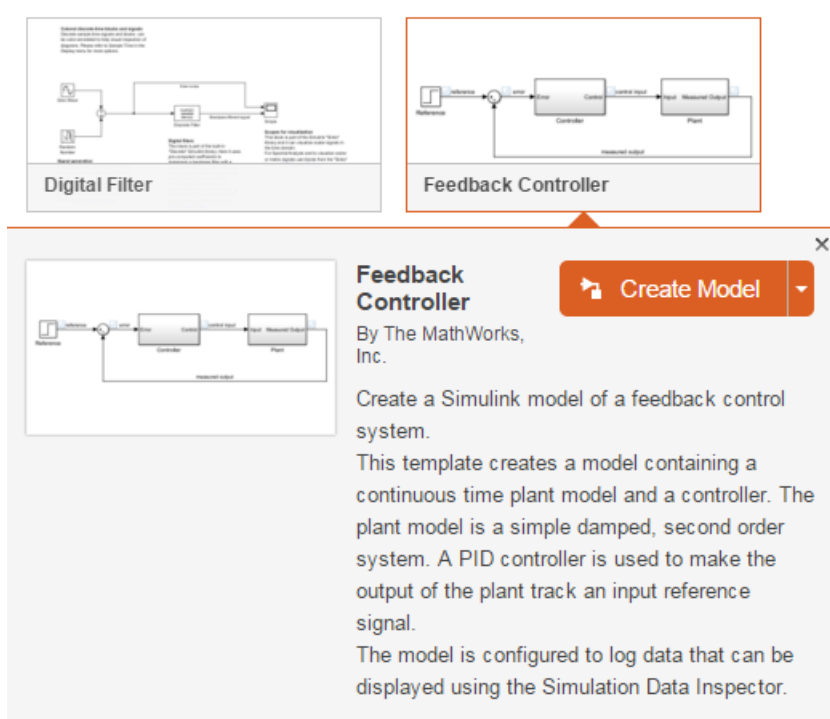

To locate templates that are not on the MATLAB search path, click **Open**. Model templates have the extension `.sltx`.

- 3 After selecting the template you want, click **Create Model**.

To use a template without reading the description, click the template image. Alternatively, press **Ctrl+N** to use your default template. To set a default template, see “Use Customized Settings When Creating New Models” on page 1-8.

A new model using the template settings and contents opens in the Simulink Editor. For next steps, see “Build and Edit a Model in the Simulink Editor” on page 1-24.

If the built-in templates do not meet your needs, try searching on the **Examples** tab, or you can create your own templates. See “Create a Template from a Model” on page 4-2. On the **Examples** tab, enter search terms to find examples titles and descriptions of interest, or open further examples on the web by clicking **View All** next to a product name.



Search 

Explore featured modeling and simulation examples for a head start solving your problem using Simulink.

- > Simulink Documentation
- > Getting Started
- > Blocks and Other Referenc
- > Release Notes

Simulink

View All

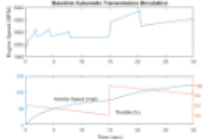

Modeling an Automatic Transmis...



Aircraft Longitudinal Flight Control

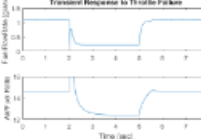

Modeling a Fault-Tolerant Fuel C...

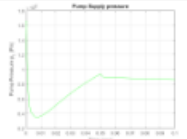

Four Hydraulic Cylinder Simulation

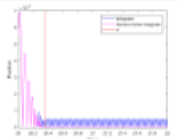

Simulation of a Bouncing Ball

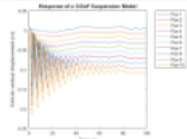

Parallel Simulations Using Parfo...



P14 Longitudinal Flight Control

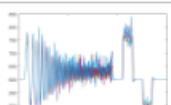

## Use Customized Settings When Creating New Models

You can specify a model template to use for all new models.



- 1 Create a model with the configuration settings and blocks you want, then export the model to a template. See “Create a Template from a Model” on page 4-2.
- 2 To reuse these settings in every new model, make the new template your default model template using the Simulink start page or the `Simulink.defaultModelTemplate` function.

In the start page, click the title of a template to expand the description, then click the down arrow next to **Create Model** and select **Set As Default**.

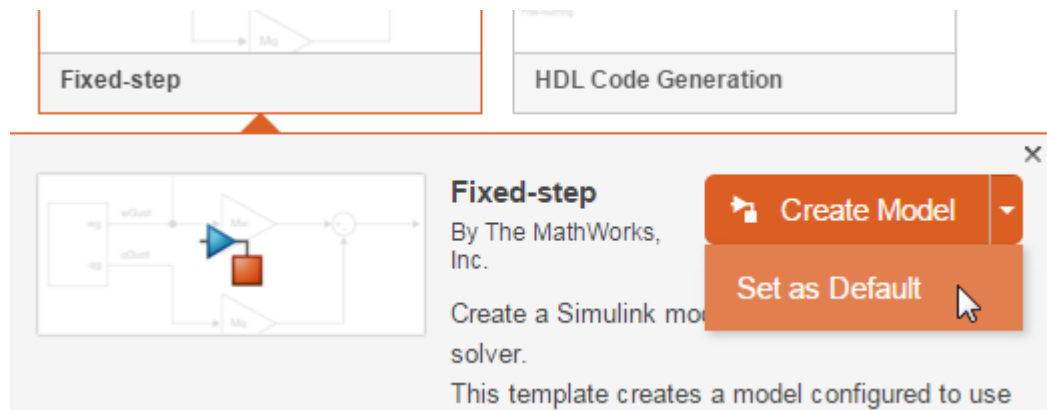

After you set a default model template, every new model uses that template, for example, when you press **Ctrl+N**, when you use new model buttons, or when you use `new_system`. In the Simulink Editor, your default template name is at the top of the list when you select **File > New > MyDefaultTemplateName**.

The default template shows a tick mark in the start page.

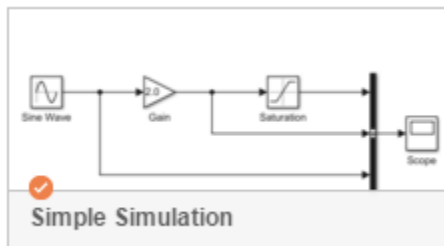

## Open a Model

Opening a model loads the model into memory and displays it in the Simulink Editor. Use any of these techniques:

- On the MATLAB **Home** tab, click **Simulink**. In the Simulink Start Page, select a recent model or project from the list, or click **Open**.
- In the Simulink Editor, select **File > Open Recent** and choose a recent model.
- At the MATLAB command prompt, enter the name of the model without a file extension, for example, `vdp`. The model must be in the current folder or on the MATLAB search path.
- In the Simulink Library Browser, click the **Open model or library** button .
- Open the model using the Current Folder browser or your operating system file browser.

---

**Tip:** Set favorites to easily get back to your favorite models and projects in the start page.

---

In the Simulink start page recent files list, you can add files to favorites. The Favorites list then appears above recent files in the start page, so that you can easily reopen your favorite models and projects.

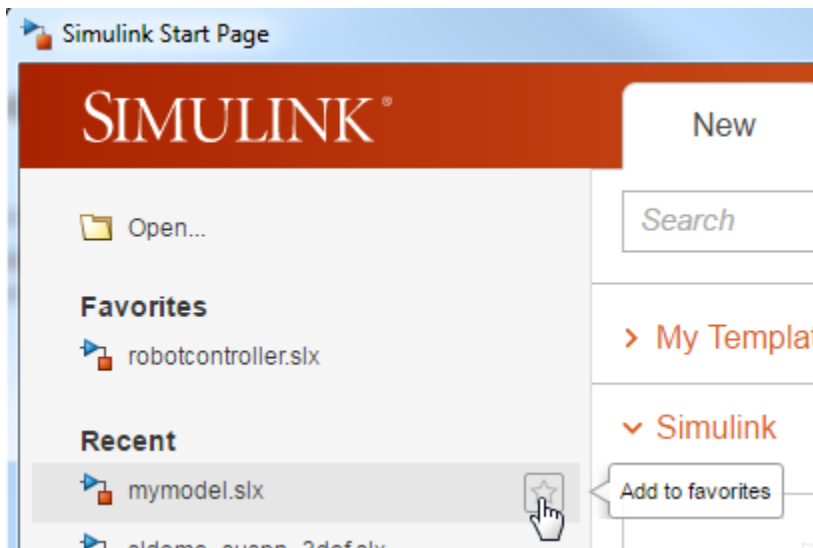

To clear the list of recent files in the start page, in MATLAB, enter:

```
slhistory.clear
```

---

**Note:** To open a model created in a later version of Simulink software in an earlier version, first export the model to the earlier version. See “Export a Model to a Previous Simulink Version” on page 1-44.

---

## Load Variables When Opening a Model

As you build models, you sometimes define variables for a model. For example, suppose that you have a model that contains a Gain block. You can specify the variable **K** as the gain rather than setting the value on the block. When you use this approach, you must define the variable **K** for the model to simulate.

You can use a model callback to load variables when you open a model.

- 1 In a model that uses the Gain block, set the block **Gain** value to **K**.
- 2 Define the variable in a MATLAB script. In MATLAB, select **New > Script**. In the script, enter your variable definitions:  
  

```
K=27
```
- 3 Save the script as `loadvar.m`.
- 4 In the model, open the Property Inspector. Select **View > Property Inspector**. With no selection at the top level of a model, you can use the Property Inspector to set model properties. Otherwise, use **File > Model Properties**.
- 5 In the **Callbacks** section of the model properties, select **PreLoadFcn** as the callback that you want to define. In the pane, enter `loadvar`.
- 6 Save the model.

The next time that you open the model, the `PreloadFcn` callback loads the variables into the MATLAB workspace.

To learn about callbacks, see “Callbacks for Customized Model Behavior” on page 4-46. To define a callback for loading variables programmatically, see “Programmatically Load Variables When Opening a Model” on page 1-15.

## Open a Model with Different Character Encoding

If you open an MDL file that uses a particular character set encoding in a MATLAB session that uses a different encoding, a warning appears. For example, suppose that you create an MDL file in a MATLAB session configured for `Shift_JIS` and open it in a session configured for `US_ASCII`. The warning message shows the encoding of the current session and the encoding used to create the model.

SLX files do not warn because they can store characters from any encoding.

If you encounter any problems with corrupted characters, for example when using MATLAB files associated with the model, then try using the `slCharacterEncoding` function to change the character encoding of the current MATLAB session to match the model character encoding.

Simulink can check if models contain characters unsupported in the current locale. For more details, see “Check model for foreign characters” and “Save Models with Different Character Encodings” on page 1-42.

## Simulink Model File Types

New models that you create have the `.slx` extension by default. Models created before R2012b have the extension `.mdl`. Models you can edit can have the `.slx` or `.mdl` extension, depending on when they were created or whether you converted them. See “Save Models in the SLX File Format” on page 1-40.

`.slxp` and `.mdlp` extensions denote protected models that you cannot open and edit. See “Protected Model” on page 8-90. Model templates have the extension `.sltx`.

Simulink libraries also use the `.slx` extension, but you cannot simulate them. To learn more, see “Create a Custom Library” on page 39-4.

## See Also

`open_system` | `simulink` | `Simulink.createFromTemplate` | `Simulink.defaultModelTemplate` | `Simulink.findTemplates`

## Related Examples

- “Build and Edit a Model in the Simulink Editor” on page 1-24
- “Create a Template from a Model” on page 4-2

- “Create a Project from a Model” on page 16-16
- “Open the Same Model in Multiple Windows” on page 1-18
- “Save a Model” on page 1-38
- “Create a New Project to Manage Existing Files” on page 16-18
- “Retrieve a Working Copy of a Project from Source Control” on page 19-29
- “Using Templates to Create Standard Project Settings” on page 16-41

## **More About**

- “Search Path” (MATLAB)

## Programmatic Modeling Basics

### In this section...

“Load a Model” on page 1-14

“Create a Model and Specify Parameter Settings” on page 1-14

“Programmatically Load Variables When Opening a Model” on page 1-15

“Programmatically Add and Connect Blocks” on page 1-16

“Name a Signal Programmatically” on page 1-18

“Open the Same Model in Multiple Windows” on page 1-18

“Get a Simulink Identifier” on page 1-18

“Specify Colors Programmatically” on page 1-22

You can perform most Simulink modeling basics programmatically at the MATLAB command prompt. The commands that correspond to basic modeling operations, such as creating models, adding blocks to models, and setting parameters, are listed in the Functions section of “Model Editing Fundamentals”. These examples show some of these commands and how you can use them.

### Load a Model

Loading a model brings it into memory but does not open it in the Simulink Editor for editing. After you load a model, you can work with it programmatically. You can use the Simulink Editor to edit the model only if you open the model.

To load a system, use the `load_system` command. For example, to load the `vdp` model, at the MATLAB command prompt, enter:

```
load_system('vdp')
```

### Create a Model and Specify Parameter Settings

You can write a function that creates a model and uses the settings that you prefer. For example, this function creates a model that has a green background and uses the `ode3` solver:

```
function new_model(modelname)
% NEW_MODEL Create a new, empty Simulink model
```

```
% NEW_MODEL('MODELNAME') creates a new model with
% the name 'MODELNAME'. Without the 'MODELNAME'
% argument, the new model is named 'my_untitled'.

if nargin == 0
    modelname = 'my_untitled';
end

% create and open the model
open_system(new_system(modelname));

% set default screen color
set_param(modelname, 'ScreenColor', 'green');

% set default solver
set_param(modelname, 'Solver', 'ode3');

% save the model
save_system(modelname);
```

## Programmatically Load Variables When Opening a Model

If you assign a variable as a block parameter value, you must define the value of the variable in the model. See “Load Variables When Opening a Model” on page 1-11. You can define the variable programmatically using the `PreloadFcn` callback with the `set_param` function. Use the function in this form:

```
set_param('mymodel', 'PreloadFcn', 'expression')
```

`expression` is a MATLAB command or a MATLAB script on your MATLAB search path. This command sets the model `PreloadFcn` callback to the value that you specify. Save the model to save the setting.

For example, when you define the variables in a MATLAB script `loadvar.m` for the model `modelname.slx`, use this command:

```
set_param('modelname', 'PreloadFcn', 'loadvar')
```

To assign the variable `K` the value 15, use this command:

```
set_param('modelname', 'PreloadFcn', 'K=15')
```

After you save the model, the `PreloadFcn` callback executes when you next open the model.

## Programmatically Add and Connect Blocks

This example shows how to use functions to add blocks and connect the blocks programmatically. Once you have added blocks to the model, you use three different approaches to connect them: routed lines, port handles, and port IDs. Routed lines allow you to specify the exact (x,y) coordinates of all connecting line segment endpoints. Port handles and port IDs allow connecting lines to block ports without having to know the port location coordinates.

Create and open a blank model named 'mymodel'.

Add blocks, including a subsystem block. Use the `position` array in the `set_param` function to set the size and position of the blocks. Set the upper left and lower right block corners using (x,y) coordinates.

```
add_block('simulink/Sources/Sine Wave','mymodel/Sine1');
set_param('mymodel/Sine1','position',[140,80,180,120]);
add_block('simulink/Sources/Pulse Generator','mymodel/Pulse1');
set_param('mymodel/Pulse1','position',[140,200,180,240]);
add_block('simulink/Ports & Subsystems/Subsystem','mymodel/Subsystem1');
set_param('mymodel/Subsystem1','position',[315,120,395,200]);
add_block('simulink/Sinks/Scope','mymodel/Scope1');
set_param('mymodel/Scope1','position',[535,140,575,180]);
```

Inside `Subsystem1`, delete the default connection between `In1` and `Out1`. Also, add a second input port by copying and renaming `In1` from the block library.

```
delete_line('mymodel/Subsystem1','In1/1','Out1/1');
add_block('simulink/Sources/In1','mymodel/Subsystem1/In2');
```

Reposition the internal input and output port blocks inside `Subsystem1`.

```
set_param('mymodel/Subsystem1/In1','position',[50,50,90,70]);
set_param('mymodel/Subsystem1/In2','position',[50,130,90,150]);
set_param('mymodel/Subsystem1/Out1','position',[500,80,540,100]);
```

Insert and position an `Add` block inside `Subsystem1`.

```
add_block('simulink/Math Operations/Add','mymodel/Subsystem1/Add1');
set_param('mymodel/Subsystem1/Add1','position',[250,80,290,120]);
```

Next, add lines to connect all the blocks in the model. Start by connecting the `Sine1` and `Pulse1` blocks using routed lines.

Find the (x,y) coordinates of the `Sine1` output port.



```
Sine1_Port = get_param('mymodel/Sine1','PortConnectivity')
```

```
Sine1_Port =
```

```
struct with fields:
```

```
    Type: '1'  
    Position: [185 100]  
    SrcBlock: []  
    SrcPort: []  
    DstBlock: [1x0 double]  
    DstPort: [1x0 double]
```

`get_param` shows that the port Position is [185 100].

Find the (x,y) coordinates of the Pulse1 output port.

```
Pulse1_Port = get_param('mymodel/Pulse1','PortConnectivity')
```

```
Pulse1_Port =
```

```
struct with fields:
```

```
    Type: '1'  
    Position: [185 220]  
    SrcBlock: []  
    SrcPort: []  
    DstBlock: [1x0 double]  
    DstPort: [1x0 double]
```

`get_param` shows that the port position is [185 220].

Connect the output of Sine1 to the first input of Subsystem1 using three segments of routed line.

```
add_line('mymodel', [185 100; 275 100]);  
add_line('mymodel', [275 100; 275 140]);  
add_line('mymodel', [275 140; 310 140]);
```

Connect the output of Pulse1 to the second input of Subsystem1 using three segments of routed line.

```
add_line('mymodel', [185 220; 275 220]);  
add_line('mymodel', [275 220; 275 180]);  
add_line('mymodel', [275 180; 310 180]);
```

Use `get_param` to get the port handles of the blocks being connected. Then use the block port handles to connect the output of `Subsystem1` to the input of `Scope1`.

```
SubsysPortHandles = get_param('mymodel/Subsystem1','PortHandles');
ScopePortHandles = get_param('mymodel/Scope1','PortHandles');
add_line('mymodel',SubsysPortHandles.Output(1),ScopePortHandles.Inport(1));
```

Use port names and IDs to connect the `Add1` block inside `Subsystem1` to the subsystem inputs and outputs. Simulink uses the most direct path to connect the ports.

```
add_line('mymodel/Subsystem1','In1/1','Add1/1');
add_line('mymodel/Subsystem1','In2/1','Add1/2');
add_line('mymodel/Subsystem1','Add1/1','Out1/1');
```

## Name a Signal Programmatically

- 1 Select the block that is the source for the signal line.
- 2 Use `get_param` to assign the port handle of the currently selected block to the variable `p`. Use `get_param` to assign the name of the signal line from that port to the variable `l`. Then set the name of the signal line to `'s9'`.

```
p = get_param(gcf,'PortHandles')
l = get_param(p.Output,'Line')
set_param(l,'Name','s9')
```

## Open the Same Model in Multiple Windows

When you open a model, the model appears in a Simulink Editor window. For example, if you have one model open and then you open a second model, the second model appears in a second window.

To open the same model in two Simulink Editor windows, at the MATLAB command prompt, enter the `open_system` command and use the `window` argument. For example, if you have the `vdp` model open, to open another instance of the `vdp` model, enter:

```
open_system('vdp','window')
```

## Get a Simulink Identifier

Every block in your model has a Simulink Identifier (SID), a unique and unmodifiable identifier. The SID persists for the lifetime of the object and is saved with a model.

If the name of the object changes, the SID stays the same. The SID has the form `model_name:number`. For details, see “Locate Diagram Components Using Simulink Identifiers” on page 1-19.

### Locate Diagram Components Using Simulink Identifiers

A Simulink Identifier (SID) is a unique designation automatically assigned to a Simulink block, model annotation, or Stateflow<sup>®</sup> object within a Stateflow chart. The SID helps to identify specific instances of these components in your diagram, especially when sharing models between people within a team.

To highlight a component visually within the model, get the SID and use it with the `Simulink.ID.hilite` function.

The SID has these characteristics:

- Persistent within the lifetime of a Simulink block, model annotation, or Stateflow object
- Saved in the model file
- Remains the same if the block or object name changes
- Cannot be modified

The SID format is:

`model_name:sid_number`

- `model_name` is the name of the model where the block, annotation, or Stateflow object resides.
- `sid_number` is a unique number within the model, assigned by Simulink.

### Highlight Block

- 1 To open the model `vdp`, enter `vdp` at the MATLAB command prompt.
- 2 Get the SID of the Mu block.

```
Simulink.ID.getSID('vdp/Mu')
```

```
ans =
```

vdp:4

- 3 Use the SID to highlight the block.

```
Simulink.ID.hilite('vdp:4')
```

The block appears highlighted in the model:

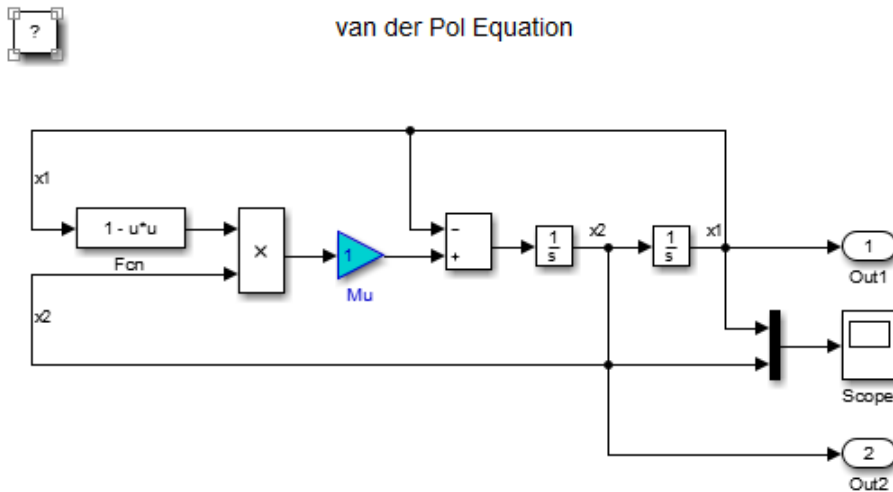

### Highlight Annotation

- 1 Open the model vdp.
- 2 Select the annotation at the top of the diagram.
- 3 Get the annotation object for the selected annotation.

```
ann = getSelectedAnnotations('vdp')
```

```
ann =
```

```
Simulink.Annotation
```

- 4 Get the SID of the annotation.

```
ann.SIDFullString
```

```
ans =
vdp:13
```

- 5 Use the SID to highlight the annotation.

```
Simulink.ID.hilite('vdp:13')
```

The annotation appears highlighted in the model:

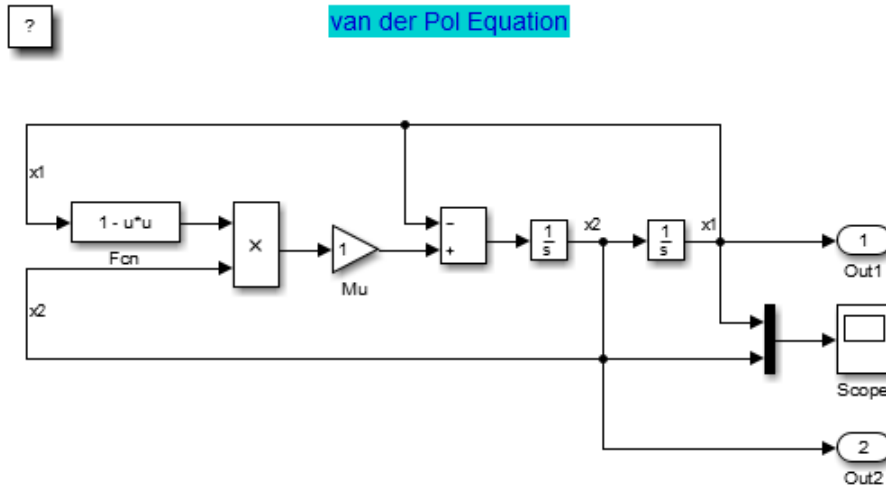

### Highlight Stateflow Object

- 1 Open the model `sf_resolve_signal_object`.
- 2 Get the SID of the Signal Object Chart Stateflow object:

```
Simulink.ID.getSID('sf_resolve_signal_object/Signal Object Chart')
```

```
ans =
sf_resolve_signal_object:1
```

- 3 Use the SID to highlight the object.

```
Simulink.ID.hilite('sf_resolve_signal_object:1')
```

The object appears highlighted in the model.

## Resolve Signal Object

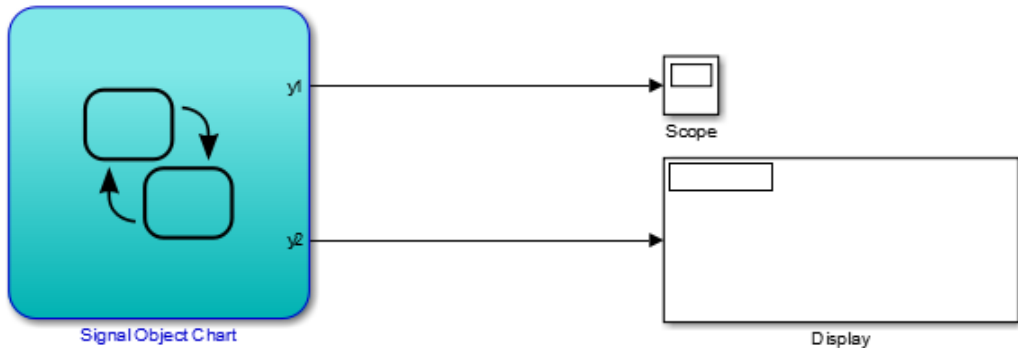

## Specify Colors Programmatically

You can use the `set_param` command at the MATLAB command line or in a MATLAB program to set parameters that determine the background color of a diagram and the background color and foreground color of diagram elements. The following table summarizes the parameters that control block diagram colors.

Parameter	Determines
ScreenColor	Block diagram background
BackgroundColor	Block and annotation background
ForegroundColor	Block and annotation foreground

Set the color parameter to either a named color or an RGB value.

- Named color: 'black', 'white', 'red', 'green', 'blue', 'cyan', 'magenta', 'yellow', 'gray', 'lightBlue', 'orange', 'darkGreen'
- RGB value: '[r,g,b]'

where **r**, **g**, and **b** are the red, green, and blue components of the color normalized to the range 0.0 to 1.0.

For example, the following command sets the background color of the currently selected system or subsystem to a light green color:

```
set_param(gcs, 'ScreenColor', '[0.3, 0.9, 0.5]')
```

### **See Also**

`add_block` | `add_line` | `delete_block` | `delete_line` | `gcb` | `get_param` |  
`load_system` | `new_system` | `open_system` | `save_system` | `set_param`

### **More About**

- “Common Block Properties”
- “Specify Model Colors” on page 34-10

## Build and Edit a Model in the Simulink Editor

### In this section...

- “Start Simulink and Create a New Model” on page 1-24
- “Add Blocks to the Model” on page 1-24
- “Align and Connect Blocks” on page 1-25
- “Set Block Parameters” on page 1-26
- “Add More Blocks” on page 1-27
- “Branch a Connection” on page 1-28
- “Organize Your Model” on page 1-31
- “Simulate Model and View Results” on page 1-33
- “Modify the Model” on page 1-34

This example shows the basics of how to create a model, add blocks to it, connect blocks, and simulate the model. You also learn how to organize your model with subsystems, name parts of a model, and modify a model.

### Start Simulink and Create a New Model

- 1 On the MATLAB **Home** tab, click **Simulink**.
- 2 In the Simulink Start Page, click the **Blank Model** template.

A new model based on the **Blank Model** template opens in the Simulink Editor.

- 3 Open the Library Browser so that you can access the blocks you need to create your model. In the Simulink Editor, click the **Library Browser** button .

### Add Blocks to the Model

A minimal model takes an input signal, operates on it, and outputs the result. In the Library Browser, the Sources library contains blocks that represent input signals. The Sinks library has blocks that you can use to capture and display outputs. The other libraries contain blocks you can use for a variety of purposes, such as math operations.

In this basic model, the input is a sine wave, the operation is a gain (which increases the signal value by multiplying), and you output the result to a scope. Try different techniques to explore the library and to add blocks to your model.



- 1 Open the Sources library. In the tree view of the Library Browser, click the **Sources** library.
- 2 In the right pane, hover over the Sine Wave block to see a tooltip describing its purpose.
- 3 Add a block to your model using a context menu. Right-click the block and select **Add block to model untitled**. (To learn more about the block, select **Help** from the context menu.)
- 4 Add a block to your model by dragging. In the library tree view, click **Math Operations**. In the Math Operations library, locate the Gain block and drag it to your model to the right of the Sine Wave block.
- 5 In the library tree view, click **Simulink** to view the sublibraries as icons in the right pane. This view is an alternative way to navigate the library structure. Double-click the **Sinks** library icon.
- 6 In the Sinks library, locate the Scope block and add it to your model using the context menu or by dragging it.

The figure shows your model so far.



## Align and Connect Blocks

Connect the blocks to create the relationships between model elements that you need to make the model operate. Reading the model is easier when you line up the blocks according to how they interact with each other. Shortcuts help you to align and connect the blocks.

- 1 Drag the Gain block so it lines up with the Sine Wave block. An alignment guide appears when the blocks line up horizontally. Release the block, and a blue arrow appears as a preview of the suggested connection.



- 2 To make the connection, click the end of the arrow. A solid line appears in place of the guide.
- 3 Line up and connect the Scope block to the Gain block using the same technique.

---

**Tip:** Use the **Diagram > Arrange** menu for additional alignment options.

---

## Set Block Parameters

You can set parameters on most blocks. Parameters help you to specify how a block operates in your model. You can use the default values or you can set values as needed. Use the Property Inspector to set parameters. Alternatively, you can double-click most blocks to set the parameters using a block dialog box. To understand when to use each approach, see “Setting Properties and Parameters” on page 1-51.

In your model, set the amplitude in the Sine Wave block and the value of the gain in the Gain block.

- 1 Display the Property Inspector. Select **View > Property Inspector**.
- 2 Select the Sine Wave block.
- 3 In the Property Inspector, set the **Amplitude** parameter to 2.
- 4 Select the Gain block and set the **Gain** parameter to 3. The value appears on the block.



## Add More Blocks

Suppose that you want to perform another gain but on the absolute value of the output from the Sine Wave block. Add blocks for this purpose, trying different techniques for locating blocks in the library and adding them to your model.

- 1 If you know the name of the block that you want to add, you can use a shortcut. Click in the model where you want to add the block, and type the block name, in this case Gain. A list of possible blocks appears.

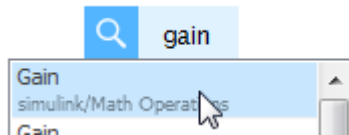

- 2 Click the block name or, with the block name highlighted, press **Enter**. You can use the arrow keys to highlight the block name if it is not first in the list. You can use this technique to add blocks anywhere the blue magnifying glass appears, for example, when you draw a signal line.
- 3 Many blocks display a prompt for you to enter a value for one of the block parameters. The Gain block prompts you to enter the **Gain** value. Type **3** and press **Enter**.

The name of each additional instance of a block adds a number that increments by 1, for example, Gain1, Gain2, and so on.

- 4 Add an Abs block to the model. Suppose you do not know the library a block is in or the full name of the block. In this case, you can search for it using the search box in the Library Browser. Enter **abs** in the search box and press **Enter**. When you find the Abs block, add it to the left of the Gain1 block.
- 5 Add another Scope block. You can right-click the existing Scope block and drag to create the copy or use **Edit > Copy** and **Edit > Paste**.

The figure shows the current state of your model.

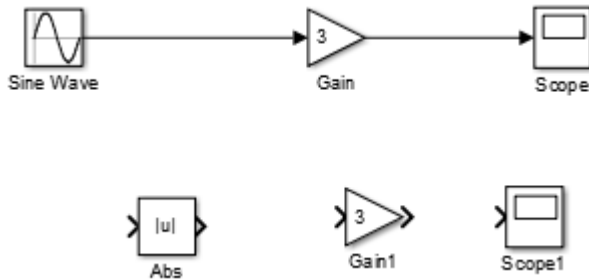

---

**Note:** When you name blocks in a model in numerical order (for example Gain1, Gain2, and so on), copying and pasting them creates names that follow standard sorting order conventions for ASCII characters. This sorting order can result in a sequence of numbers on the block names that is hard to understand. If the numbering scheme is important to you, number blocks so that copying and pasting them creates names that follow a typical reading order. To do so, use a leading zero in the block names, for example Gain001, Gain002, and so on.

---

## Branch a Connection

The input to the second gain is the absolute value of the sine wave. To use a single Sine Wave block as the input to both gain operations, create a branch from the Sine Wave block output signal.

- 1 For the first set of blocks in your model, you used the horizontal alignment guides to help you align and connect blocks. You can also use guides to align blocks vertically. Drag the Scope1 block so that it lines up under the Scope block. Release it when the vertical alignment guide shows that the blocks are aligned.

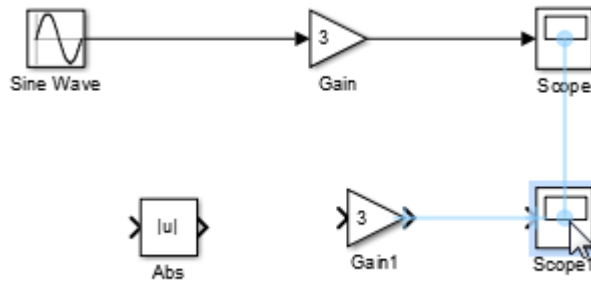

- 2 Align and connect the Abs and Gain1 blocks as shown.

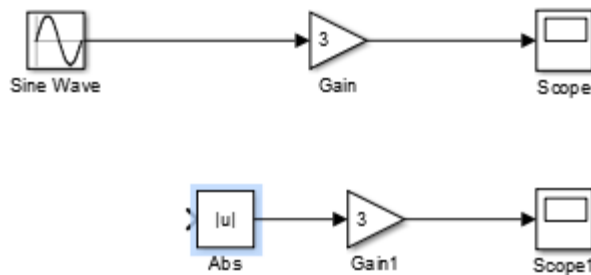

- 3 Create a branch from the Sine Wave block output to the Abs block. With your cursor over the output signal line from the Sine Wave block, press **Ctrl** and drag down. Drag the branch until the end is to next to the Abs block.

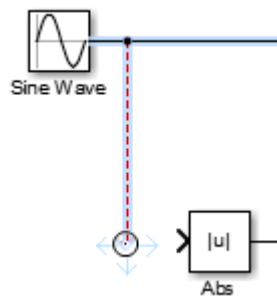

- 4 Drag toward the Abs block until the line connects to it. Move the vertex as needed to straighten the line. (A circle appears over the vertex.)

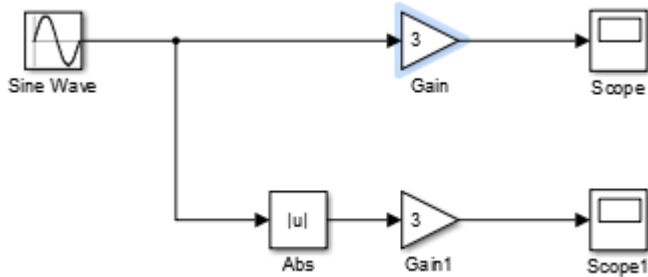

Try these other methods to connect blocks:

- Drag a connection from the output of one block to the input of the other block. Use this technique when your blocks are already aligned, that is, no guideline appears.
- Select the first block and **Ctrl**+click the block you want to connect it to. This technique is useful when you do not want the blocks to align. The connection line bends as needed to make the connection, as shown in the figure.

---

**Note:** You can select multiple blocks to connect them to a block that has multiple inputs, such as a bus.

---

To approximate a diagonal line from line segments, press **Shift** and drag a vertex.

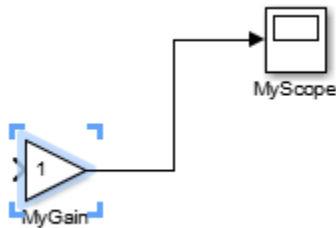

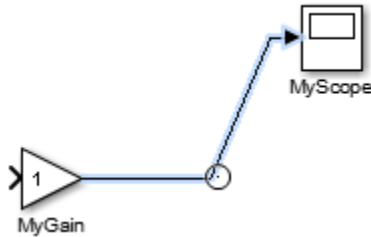

---

**Tip:** To improve the shape of a signal line, select the line and, from the ellipsis menu, select **Autoroute Line**. The line redraws if a better route between model elements is possible.

---

## Organize Your Model

You can group blocks in subsystems and label blocks, subsystems, and signals. For more information about subsystems, see “Create a Subsystem” on page 4-18.

- 1 Drag a selection box around the Abs and Gain1 blocks.
- 2 Move the cursor over the ellipses that appear at the lower-right corner of the selection box. From the bar, select **Create Subsystem**.

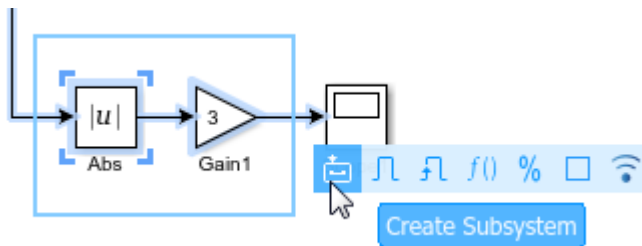

A subsystem block appears in the model in place of the Abs and Gain1 blocks. To resize the subsystem block for the best fit in your model, drag the block handles.

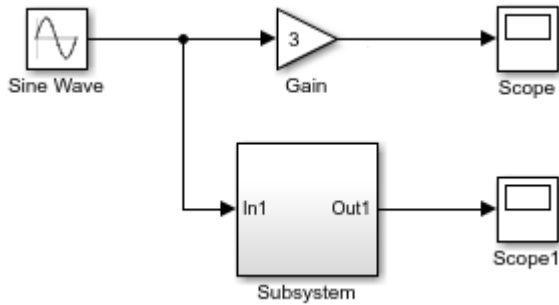

- 3 Give the subsystem a meaningful name. Double-click the block name and type **Absolute Value**.
- 4 Open the Absolute Value subsystem by double-clicking it.

---

**Tip:** To use the Explorer Bar to navigate the model hierarchy, right-click the block and select **Open in New Tab**.

---

The subsystem contains the Abs and Gain1 blocks that you selected as the basis of the subsystem. They are connected in sequence to two new blocks: In1 (an Inport block) and Out1 (an Outport block). Inport and Outport blocks correspond to the input and output ports on the subsystem.

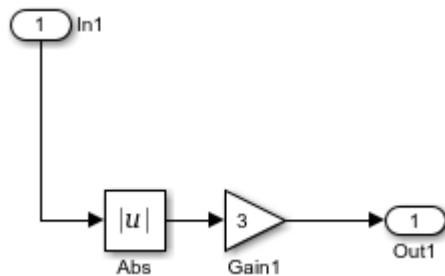

- 5 Click the Simulink Editor **Up to Parent** button  to return to the top level of the model.



- 6 You can name any signal. Double-click a signal and type the name. For example, double-click the signal from the Gain block and type **My Signal**. Double-click the line and not a blank area of the canvas, which instead creates a separate text element (annotation). For other techniques that you can use with signal names, see “Signal Name and Label Actions” on page 1-92.

The figure shows the model after you create the subsystem, name it, and name a signal.

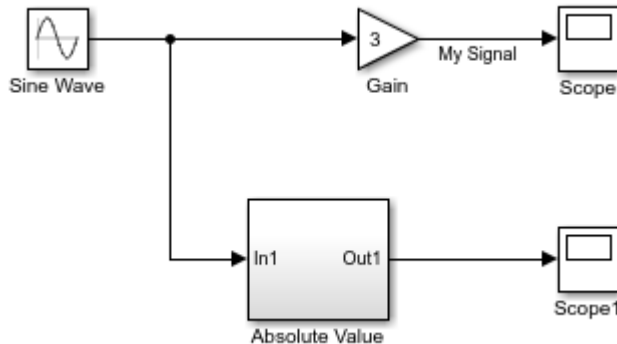



---

**Tip:** For additional resizing and alignment options, use the **Diagram > Arrange** menu.

---

## Simulate Model and View Results

- 1 You can simulate a model using the **Simulation > Run** command (**Ctrl+T**) or the **Run** button . Simulate the model using the technique that you prefer.  
  
In this example, simulation runs for 10 seconds, the default setting.
- 2 Double-click both scope blocks to open them and view the results. In each scope, click the **Autoscale** button  to view the entire signal.

The figure shows the two results. In the second plot, as expected, the absolute value of the sine wave is always positive.

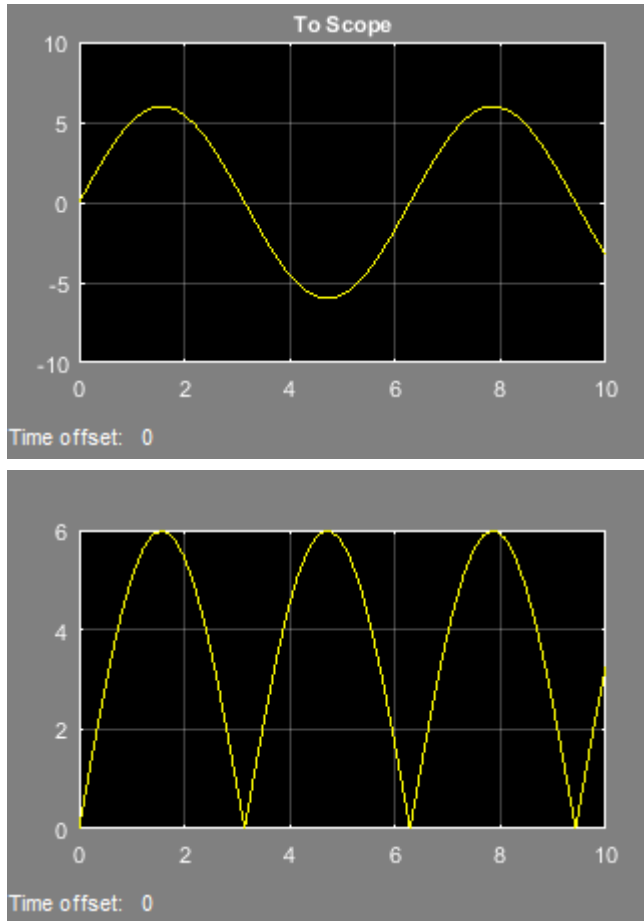

## Modify the Model

You can add blocks on an existing signal, remove blocks from models, and redraw connections. To modify this model, add a bias to the input to both branches of your model. Also, replace one of the scopes with a different sink.

For some blocks, connecting a line from another block adds an input port or output port to the block. For example, a port appears on a subsystem when you add a connection to it. Additional blocks that create ports include the Bus Creator, Scope, and Add, Sum, and

Product blocks. For more information, see “Automatic Port Creation: Add inports and outports to blocks when routing signals”.

- 1 Add a Bias block to the model and set the **Bias** parameter to 2.
- 2 Drag the block onto the signal line after the Sine Wave block but before the branch. If you need to make room for the block, drag the Sine Wave block to the left or move the end of the branch by dragging it to the right.

When you drag the block onto the signal line, the block connects to the signal line at both ends. Release the block when you are satisfied with the position.

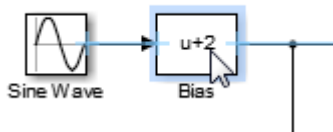

- 3 Remove the Scope block. Press **Shift** and drag the Scope block if you want to disconnect it from the model but do not want to delete it. Cut or delete it using the **Edit** menu commands or a keystroke. The broken connection appears as a red dotted line.

---

**Tip:** When you delete a block that has one input and one output, a prompt appears between the broken connection lines. Click the prompt to connect the signals.

---

- 4 Add a To Workspace block to the model and place it at the end of the broken connection. The To Workspace block outputs the results to a variable in the MATLAB workspace.
- 5 Add another input to the subsystem. Add a Sine Wave block to the model and set the amplitude to 5. Place it to the left of the subsystem block.
- 6 Drag a line from the new Sine Wave block to the left side of the subsystem. A new port, In2, appears on the block.
- 7 Add another output to the subsystem. Add a To Workspace block to the model and place it to the right of the subsystem. Drag a line from the input port to the right side of the subsystem. A new port, Out2, appears on the block.
- 8 Open the subsystem and rename the Out1 block to Scope. Rename the Out2 block to Workspace. Add a Manual Switch block to the model. Resize it and connect it as shown. Branch the signal after the Gain block to direct the output to the To Workspace block.

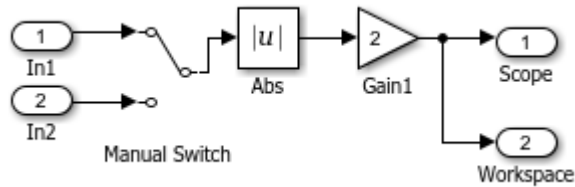

Then, return to the top level of the model. The figure shows the current model.

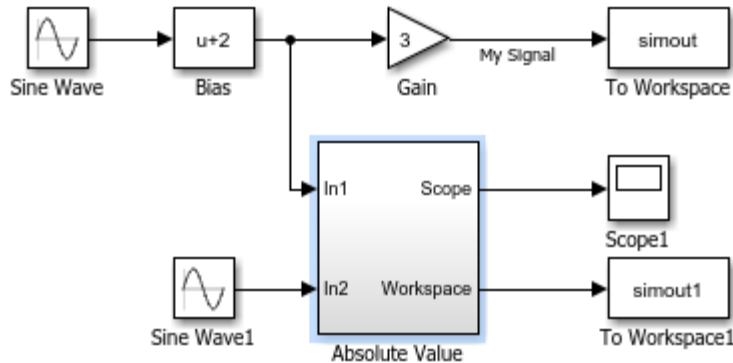

9 Simulate the model.

- The `simout` and `simout1` variables appear in the MATLAB workspace. You can double-click each variable to explore the results.
- If you want to use the second sine wave as input to the subsystem algorithm, open the subsystem and double-click the switch. The input changes to `In2`. Simulate again.

---

**Tip:** To toggle between simulating the model with and without the effects of the Bias block, right-click the Bias block and select **Comment Through**. The block stays in the model but does not affect the operation. Right-click the Bias block and select **Uncomment** to enable the block. The **Comment Out** command comments out the block's output signal, so signal data does not pass through. Try each of these commands to better understand their effects.

---

## **Related Examples**

- “Describe Models Using Annotations” on page 4-3
- “Create Models and Open Existing Models” on page 1-5
- “Keyboard and Mouse Actions for Simulink Modeling” on page 1-90
- “Signal Basics” on page 62-2

## Save a Model

### In this section...

“How to Tell If a Model Needs Saving” on page 1-38

“Save a Model” on page 1-38

“What Happens When You Save a Model?” on page 1-39

“Save Models in the SLX File Format” on page 1-40

“Save Models with Different Character Encodings” on page 1-42

“Export a Model to a Previous Simulink Version” on page 1-44

“Save from One Earlier Simulink Version to Another” on page 1-44

### How to Tell If a Model Needs Saving

To tell whether a model needs saving, look at the title bar in the Simulink Editor. If the model needs saving, an asterisk appears next to the model name in the title bar (known as the dirty flag: \*).

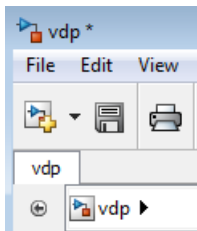

To determine programmatically whether a model needs saving, use the model parameter `Dirty`. For example:

```
if strcmp(get_param(gcs,'Dirty'),'on')
    save_system;
end
```

### Save a Model

To save a model for the first time, in the Simulink Editor, select **File > Save**. Provide a location and name for the model file. For name requirements, see “Model Names” on page 1-39.

To save a previously saved model:

- To replace the file contents, in the Simulink Editor, select **File > Save**.
- To save the model with a new name or location, or to change from MDL to SLX format, in the Simulink Editor, select **File > Save As**.

---

**Note:** For details about the SLX format, see “Upgrade Models to SLX” on page 1-40.

---

- To save the model in a format compatible with the earlier version, select **File > Export Model to > Previous Version**. See “Export a Model to a Previous Simulink Version” on page 1-44.

## Model Names

Model file names must start with a letter and can contain letters, numbers, and underscores. The file name must not be:

- A language keyword (e.g., `if`, `for`, `end`)
- A reserved name: `'simulink'`, `'sl'`, `'sf'`
- A MATLAB software command

The total number of characters in the model name must not be greater than a certain maximum, usually 63 characters. To find out whether the maximum for your system is greater than 63 characters, use the MATLAB `namelengthmax` command.

To understand how MATLAB determines which function to call when you specify a model name, see “Function Precedence Order” (MATLAB).

## What Happens When You Save a Model?

Simulink saves the model (block diagram) and block properties in the model file.

If you have any pre- or post-save functions, they execute in this order:

- 1 All block `PreSaveFcn` callback routines execute first, then the model `PreSaveFcn` callback routine executes.
- 2 Simulink writes the model file.
- 3 All block `PostSaveFcn` callback routines execute, then the model `PostSaveFcn` executes.

During the save process, Simulink maintains a temporary backup copy (named *modelName.bak*) for restoring in case of an error. If an error occurs during saving or during any callback during the save process, Simulink:

- Restores the original file
- Writes any content saved before the error occurred in a file named *modelName.err*
- Issues an error message

When saving a model loaded from an SLX file, the original SLX file must still be present. Simulink performs incremental loading and saving of SLX files, so if the original file is missing at save-time, Simulink warns that it cannot reconstruct the file fully.

## Save Models in the SLX File Format

### Save New Models as SLX

Simulink saves new models and libraries in the SLX format by default, with file extension `.slx`. SLX is a compressed package that conforms to the Open Packaging Conventions (OPC) interoperability standard. SLX stores model information using Unicode® UTF-8 in XML and other international formats. Saving Simulink models in the SLX format:

- Typically reduces file size compared to MDL. The file size reduction between MDL and SLX varies depending on the model.
- Solves some problems in previous releases with loading and saving MDL files containing Korean and Chinese characters.
- Enables incremental loading and saving. Simulink optimizes performance and memory usage by loading only required parts of the model and saving only modified parts of the model.

You can specify your file format for saving new models and libraries with the Simulink preference “File format for new models and libraries”.

### Upgrade Models to SLX

If you upgrade an MDL file to SLX file format, the file contains the same information as the MDL file, and you always have a backup file. All functionality and APIs that currently exist for working with models, such as the `get_param` and `set_param`



commands, are also available when using the SLX file format. If you upgrade an MDL file to SLX file format without changing the model name or location, then Simulink creates a backup file by renaming the MDL (if writable).

If you save an existing MDL file using **File > Save**, Simulink respects the file's current format and saves your model in MDL format.

To save an existing MDL file in the SLX file format:

- 1 Select **File > Save As**.
- 2 Leave the default **Save as type** as SLX, and click **Save**.

Simulink saves your model in SLX format, and creates a backup file by renaming the MDL (if writable) to `mymodel.mdl.releaseName`, e.g., `mymodel.mdl.R2010b`.

Alternatively, use `save_system`:

```
save_system mymodel mymodel.slx
```

This command creates `mymodel.slx`, and if the existing file `mymodel.mdl` is writable it is renamed `mymodel.mdl.releaseName`.

SLX files take precedence over MDL files, so if both exist with the same name and you do not specify a file extension, you load the SLX file.

Simulink Projects can help you migrate files to SLX. For an example, see “Upgrade Model Files to SLX and Preserve Revision History” on page 17-18.

---

**Caution:** If you use third-party source control tools, be sure to register the model file extension `.slx` as a binary file format. If you do not, these third-party tools might corrupt SLX files when you submit them.

---

Operations with Possible Compatibility Considerations when using SLX	What Happens	Action
Hard-coded references to file names with extension <code>.mdl</code> .	Scripts cannot find or process models saved with new file extension <code>.slx</code> .	Make your code work with both the <code>.mdl</code> and <code>.slx</code> extension. Use functions like <code>which</code> and <code>what</code> instead of file names.

Operations with Possible Compatibility Considerations when using SLX	What Happens	Action
Third-party source control tools that assume a text format by default.	Binary format of SLX files can cause third-party tools to corrupt the files when you submit them.	Register <code>.slx</code> as a binary file format with third-party source control tools. Also recommended for <code>.mdl</code> files. See “Register Model Files with Source Control Tools” on page 19-10.
Changing character encoding.	Some cases are improved, e.g., SLX solves some problems in previous releases with loading and saving MDL files containing Korean and Chinese characters. However, sharing models between different locales remains problematic.	See “SLX Files and Character Encodings” on page 1-43.

The format of content within MDL and SLX files is subject to change. To operate on model data, use documented APIs (such as `get_param`, `find_system`, and `Simulink.MDLInfo` class).

## Save Models with Different Character Encodings

- “MDL Files and Character Encodings” on page 1-42
- “SLX Files and Character Encodings” on page 1-43

### MDL Files and Character Encodings

When you save a model, the current character encoding is used to encode the text stored in the model file. With MDL files, this can lead to model corruption if you save a model whose original encoding differs from current encoding.

If you change character encoding, it is possible to introduce characters that cannot be represented in the current encoding. If this is the case, the model is saved as `model.mdl.err`, where `model` is the model name, leaving the original model file

unchanged. Simulink also displays an error message that specifies the line and column number of the first character which cannot be represented.

To recover from this error, either:

- Save the model in SLX format (see “Save Models in the SLX File Format” on page 1-40).
- Locate and remove characters one by one.
  - 1 Use a text editor to find the character in the `.err` file at the position specified by the save error message.
  - 2 Find and delete the corresponding character in the open model and resave the model.
  - 3 Repeat this process until you are able to save the model without error.

It’s possible that your model’s original encoding can represent all the text changes made in the current session, albeit incorrectly. For example, suppose you open a model whose original encoding is A in a session whose current encoding is B. Further suppose that you edit the model to include a character that has different encodings in A and B and then save the model. If in addition the encoding for x in B is the same as the encoding for y in A, and if you insert x in the model while B is in effect, save the model, and then reopen the model with A in effect the Simulink software will display x as y. To alert you to the possibility of such corruptions, a warning message appears whenever you save a model in which the current and original encoding differ but the original encoding can encode, possibly incorrectly, all of the characters to be saved in the model file.

### **SLX Files and Character Encodings**

Saving Simulink models in the SLX format typically reduces file size and solves some problems in previous releases with loading and saving MDL files containing Korean and Chinese characters.

Considerations for choosing a model file format:

- Use SLX if you are loading and saving models with Korean or Chinese characters
- Use SLX if you would benefit from a compressed model file
- Whether you use SLX or MDL, Simulink can detect and warn if models contain characters unsupported in the current locale. For SLX, you can use the Model Advisor to help you, see “Check model for foreign characters”.

## Export a Model to a Previous Simulink Version

You can export (save) a model created with the latest version of the Simulink software in a format used by an earlier version. For example, to share a model with colleagues who only have access to a previous version of the Simulink product.

To export a model in an earlier format:

- 1 In the Simulink Editor, select **File > Save**. This saves a copy in the latest version of Simulink. This step avoids compatibility problems.
- 2 Simulink Editor, select **File > Export Model to > Previous Version**.

The Export to Previous Version dialog box appears.

- 3 In the dialog box, from the **Save as type** list, select the previous version to which to export the model. The list supports 7 years of previous releases.
- 4 Click the **Save** button.

When you export a model to a previous version's format, the model is saved in the earlier format, regardless of whether the model contains blocks and features that were introduced after that version. If the model does contain blocks or use features that postdate the earlier version, the model might not give correct results when you run it in the earlier version of Simulink software. In addition, Simulink converts blocks that postdate an earlier version into yellow empty masked Subsystem blocks. For example, if you use `save_system` to export a model to Release R2007b, and the model contains Polynomial blocks, Simulink converts the Polynomial blocks into yellow empty masked Subsystem blocks. Simulink also removes any unsupported functionality from the model. See `save_system`.

## Save from One Earlier Simulink Version to Another

You can open a model created in an earlier version of Simulink and export that model to a different earlier version. To prevent compatibility problems, use the following procedure if you need to save a model from one earlier version to another earlier version.

- 1 Use the current version of Simulink to open the model created with the earlier version.
- 2 Before you make any changes, save the model in the current version by selecting **File > Save**.

After saving the model in the current version, you can change and resave it as needed.

- 3** Save the model in the earlier version of Simulink by selecting **File > Export Model to > Previous Version**.
- 4** Start the earlier Simulink version and use it to open the model that you exported to that earlier version.
- 5** Save the model in the earlier version by selecting **File > Save**.

You can now use the model in the earlier version of Simulink exactly as you could if it had been created in that version.

See also the Simulink preferences that can help you work with models from earlier versions:

- “Do not load models created with a newer version of Simulink”
- “Save backup when overwriting a file created in an older version of Simulink”

## See Also

`save_system`

## Related Examples

- “Create a Template from a Model” on page 4-2
- “Check model for foreign characters”

## Model Editing Environment

In this section...
“Simulink Editor” on page 1-46
“Interactive Model Building” on page 1-48
“Model Design Error Detection” on page 1-49
“Library Browser” on page 1-49
“Setting Properties and Parameters” on page 1-51

The Simulink model editing environment consists of two main tools: the Simulink Editor and the Library Browser. You find the blocks for your model in the Library Browser and build the model by adding and connecting the blocks in the Simulink Editor.

### Simulink Editor

The Simulink Editor is an intuitive tool for building models. In addition to providing standard methods for working with diagrams in a vector graphics editor, the editor provides shortcuts that help you to add and connect blocks. The Simulink Editor also gives you access to the tools you need for technical operations such as importing data, simulating your model, and analyzing model performance.

The figure shows the Simulink Editor with the example model vdp open.

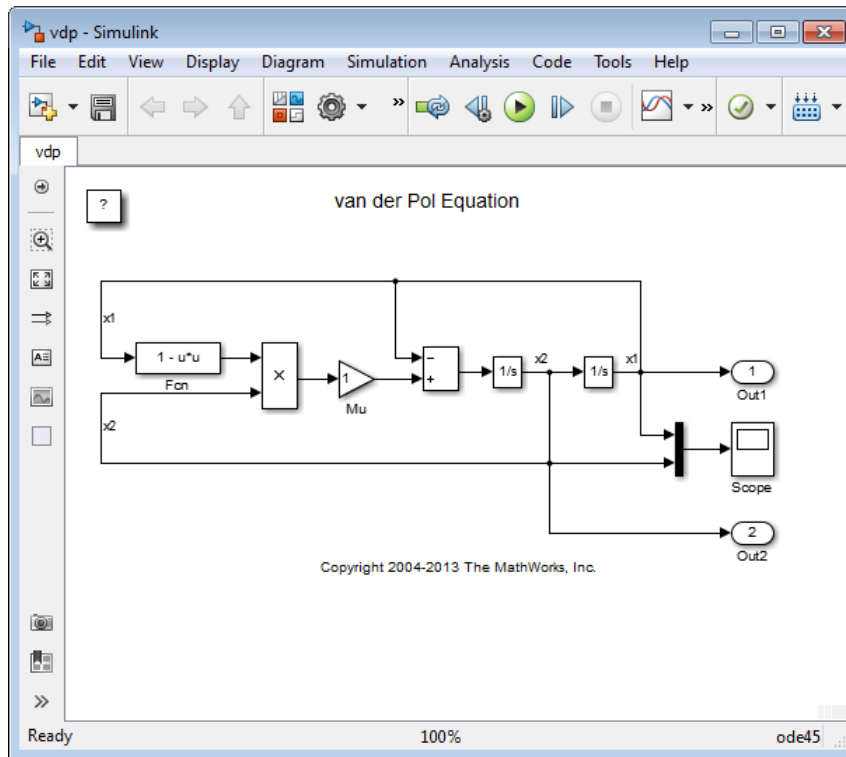

The Simulink Editor has menus of commands and a toolbar of shortcuts for performing frequent operations or opening tools. Tooltips appear when you hover over the toolbar buttons. Commands also appear on *context menus*. Context menus appear when you right-click a model element or a blank area of the editor. For example, right-click a block, and the menu displays the commands relevant for working on blocks, such as clipboard and alignment operations. Some commands appear only on a context menu.

## Palette

The palette along the left side of the editor provides more shortcuts. The palette shortcuts have to do with the model appearance and how you navigate the model rather than how you build and operate it. For example, the palette includes a shortcut for adding annotations and other visuals, like boxed-in areas for labeling the model. It also provides a zoom button for zooming on a particular part of the model.

The **Hide/Show Explorer Bar** button displays a bar that shows where you are in the model hierarchy as you navigate. The **Hide/Show Model Browser** button displays a hierarchical view of the model that you can use to navigate. See “Explore the Model Hierarchy Using the Model Browser” on page 12-48.

## Additional Model Views

The control in the lower-right corner opens additional views of the model. One such view is the interface view, which helps you to trace model interfaces. Click the control to see these views.

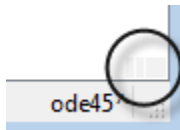

## Interactive Model Building

When you build a model in the Simulink Editor, you use common techniques for working with graphics objects. Some of these actions include:

- Selection using click, shift-click, and dragging
- Resizing objects using handles and moving objects by dragging
- Clipboard operations, that is, cut, copy, and paste
- Undo/redo (up to 101 operations)

---

**Note:** After you undo or redo block parameter changes, a visual cue appears that shows the current values of the affected parameters. Some parameter changes are not affected by the Undo or Redo commands. After you undo or redo changes to block parameters, use the cue to see the parameters affected.

A small subset of parameters do not support Undo. Changing these parameters clears the Undo history, whether you make the change in the Property Inspector or in the block dialog box.

---

You zoom and scroll the editing area using familiar methods, such as the commands on the **View > Zoom** menu. If you are using a supported touch display platform, you can pinch to zoom and swipe to scroll. The supported touch display devices include Microsoft Windows platforms with a Windows 7 certified or Windows 8 certified touch display and Macintosh platforms with an Apple Magic Trackpad.



The editor supports additional shortcuts for scrolling that are unique to Simulink. Shortcuts and the other interactive model building techniques are summarized in “Keyboard and Mouse Actions for Simulink Modeling” on page 1-90. For a tutorial, see “Build and Edit a Model in the Simulink Editor” on page 1-24.

## Model Design Error Detection

The Simulink Editor can provide you with visual cues for some model design issues. In the model editor, highlighted blocks alert you to issues while you edit. To see a description of the issue, hover over a highlighted block and click the error or warning symbol.

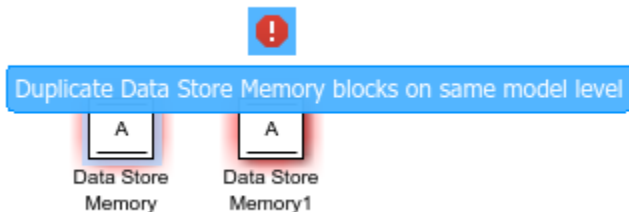

Simulink can detect block errors and warnings, such as:

- Goto and From block mismatches.
- Duplicate data store blocks. The value of the Duplicate data store names parameter determines if there is a visual cue, and if the cue is an error or warning.

The **Errors and Warnings** option is enabled by default. To turn off this option, deselect **Display > Errors & Warnings**.

## Library Browser

Use the Library Browser to locate blocks and visuals (annotations) to add to your model. Navigate the libraries using the tree structure in the left pane or by double-clicking sublibraries in the right pane. Sublibraries, blocks, and text and image annotations can appear in the right pane. Hover over any item to see a description.

When you find the item you are looking for, you can drag it into your model, or you can select it and use the context menu to add it.

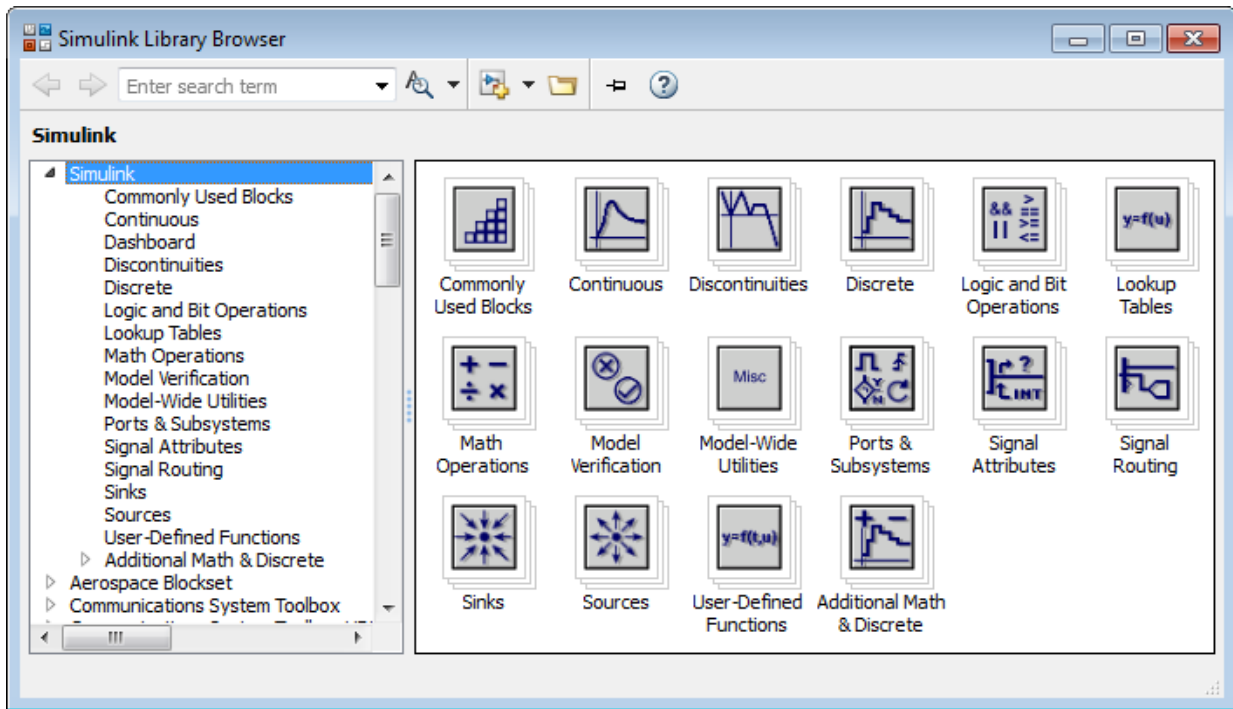

**Tip:** The Recently Used Blocks structure at the bottom of the tree contains the blocks and libraries from the supplied libraries that you used most recently.

You can search for blocks and annotations using the search controls. To use regular expressions, whole word search, or case-sensitive search, use the **Search for subsystems, blocks, and annotations** button arrow . For annotations, you can search for any of the text in the annotation or any part of its description.

By default, library contents appear in alphabetical order. Subsystems appear first, then blocks, and then annotations. If you prefer to view the contents of the libraries in the order set by the developer of the library, right-click the right pane and select **Sort in library model order**. This setting stays in effect from session to session.

To return to the alphabetical order, right-click and select **Sort in alphabetical order**. Depending on how the library designer set up the library, some items might not appear

in alphabetical order. For example, in the **Simulink** library, the Additional Math & Discrete library appears as the last item regardless of the sorting option you choose.

You can create your own libraries and, optionally, have them appear in the Library Browser. See “Create a Custom Library” on page 39-4.

## Setting Properties and Parameters

As you build a model, you can set parameters and properties on model elements. For example, you can set parameters and properties for blocks that affect how the block functions. You can also set properties on Stateflow charts, signal lines, visual elements such as annotations, and on the model.

Based on your workflow and goals, set parameters and properties using:

- The Property Inspector, which stays open in the editor as you work and updates based on the current selection
- A dialog box that is associated with an element, such as a specific block

When you select **View > Property Inspector**, the interface appears in the Simulink Editor on the right. You can drag it from the default location and dock it in another location in the editor. The figure shows a block selected with the Property Inspector displayed.

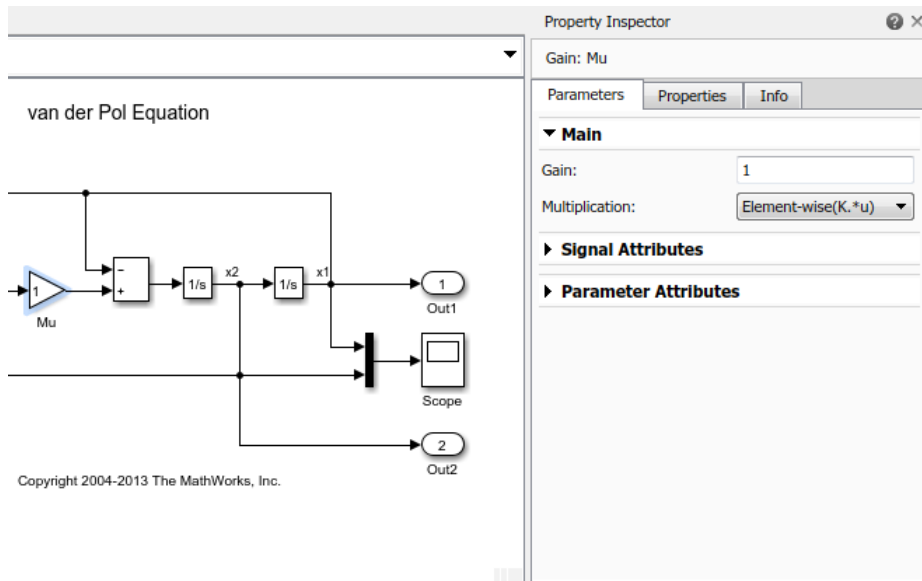

The Property Inspector is useful when you are setting parameters and properties as you work, because it is always open and available for setting values for the current selection. Values take effect as soon as you set them. This workflow simplifies your interaction with the interface.

You can alternatively open a dialog box for a selected model element using an item on the **Diagram** menu, such as **Properties** and, for blocks, **Block Parameters**. You can also use the context menu. Double-clicking a block generally opens a block dialog box. (You must use one of the menu commands on Subsystem and Model blocks.) For more information on setting block properties and parameters, see “Block Parameters and Properties in Simulink” on page 1-55.

The Property Inspector and the dialog boxes operate on a single selection. The main difference is that the Property Inspector updates with each selection and the dialog box shows the settings only for the element you opened it from. For this reason, the dialog box is useful if:

- You are moving through the model hierarchy and want to see or set an element’s parameters or properties as you navigate the model.
- You want to compare the parameters or properties of similar elements.
- The settings are advanced and appear only in the dialog box.

## **Related Examples**

- “Build and Edit a Model in the Simulink Editor” on page 1-24
- “Trace Connections Using Interface Display” on page 12-69

## **More About**

- “Keyboard and Mouse Actions for Simulink Modeling” on page 1-90

## Parts of a Model

In this section...
“About Blocks” on page 1-54
“Block Parameters and Properties in Simulink” on page 1-55
“Signals” on page 1-57

You create a Simulink model by adding blocks, specifying block behavior, and using signal lines to connect the blocks to each other according to the dynamics of the system that you want to simulate.

### About Blocks

Blocks are the main elements that you use to build models in Simulink. Generally, you add blocks from the supplied Simulink libraries to perform specific operations, such as math, as shown in “Build and Edit a Model in the Simulink Editor” on page 1-24.

You can further classify blocks in Simulink.

- Virtual blocks — These blocks help to organize a model and do not affect simulation. See “Nonvirtual and Virtual Blocks” on page 34-2.
- Subsystem blocks — Subsystems help you to organize your models hierarchically. You use a Subsystem block to encapsulate related parts of a model, that is, a representation of a system within the larger system that you are modeling. See “Model Hierarchy”.
- Masked blocks — You can add a mask to any block in a model. A mask is a custom interface that enables you to show only the block parameters and settings that you want the user of the block to have access to. A mask also provides an interface for setting parameters on blocks inside a subsystem without having to navigate the hierarchy. You can change the block appearance using a mask. See “Block Masks”.
- Referenced models — A model reference is a way to include a model in another model. You use a Model block to reference a model. See “Model Referencing”.
- Linked blocks — A linked block is an instance of a block from a custom library that links to the library block. You can create a library of blocks that you configure for your specific purposes. For example, you can create subsystems and masked blocks and store them in a library for reuse. When you add a block to a model from a library that you created, the block keeps a link to the library version, called a *library link*. You can modify a linked block only by disabling the link. See “Libraries”.

## Block Parameters and Properties in Simulink

For most blocks, you can specify parameters that determine how the block works. For example, in the Trigonometric Function block, you specify the trigonometry function that you want the block to perform. For some blocks, you can specify the number of inputs or outputs. Whether the block has parameters that you can set and the nature of those parameters is specific to each block. For detailed information on parameter values, see “Set Block Parameter Values” on page 35-2.

You set block parameters in the Property Inspector or in a block dialog box.

- To open the Property Inspector, select **View > Property Inspector**. Select the block whose parameters you want to view or set. The parameters appear in the **Parameters** tab.
- To open the block dialog box, select **Diagram > Block Parameters** or, for most blocks, double-click the block. You can also use the context menu.

To understand the differences between these approaches, see “Setting Properties and Parameters” on page 1-51.

Some block parameters do not appear in the Property Inspector. For example, some advanced parameters do not appear in the Property Inspector. To open the block dialog box instead, in the Property Inspector, click **Open**. See the documentation for your product to learn more about setting block parameters in the Property Inspector.

Blocks also have properties which are not specific to the block. Block properties enable you to configure the block to execute code when you perform actions such as opening the block or starting simulation. For example, you can set up a MATLAB script to perform tasks such as loading or defining variables for a block or any other callback functions. See “Callbacks for Customized Model Behavior” on page 4-46. Block properties also enable you to annotate the block and define callback functions. See “Specify Block Properties” on page 34-4.

You can set block properties on the **Properties** tab of the Property Inspector. Alternatively, you can use the Block Properties dialog box.

### Additional Parameters and Properties

Simulink has these additional types of parameters and properties.

- Programmatically accessible parameters — Blocks and models have parameters whose value you do not set explicitly in the editor. For example, each block has

a position parameter that is based on where you place the block in the model. There is no single interface to these parameters, but you can query and set any of them programmatically. You can also set any of the block-specific parameters programmatically. See “Common Block Properties” and “Model Parameters”.

- Model configuration parameters — Use configuration parameters (**Simulation > Model Configuration Parameters**) to specify simulation conditions, such as the solver to use, the types of errors and warnings to display, and how you want to store simulation data. See “Configuration Parameters Dialog Box Overview”.
- Model properties — Model properties help you to define callbacks for the model. They also enable you to add a description and specify data to load or scripts to run, along with other settings. You can view and set model properties in the Property Inspector when there is no selection in the top level of a model. Otherwise, use **File > Model Properties**. See “Manage Model Properties” on page 4-62.

---

**Note:** Simulink preferences (**File > Simulink Preferences**) help you to customize your model editing environment, such as how your scroll wheel functions and saving options. See “Set Simulink Preferences”.

---

### Setting Parameter Values in Workspaces

Simulink gives you access to two workspaces where you can set values for parameters. Workspaces enable you to set parameters by using variables rather than setting every value on every block in a model. This approach is especially useful when your model is large and complex because you do not need to locate every block whose parameter value you want to set or change. Instead, assign a variable as the value of a parameter and define the variable in a workspace. This mechanism also allows you to use different sets of parameter values for the same model.

In the *MATLAB base workspace*, you can define parameters using any MATLAB mechanism for defining a variable. For example, you can use a MAT-file and load the variables when you open the model (see “Load Variables When Opening a Model” on page 1-11). Using the MATLAB base workspace to define variables is useful when you are using the same set of parameters for more than one model.

You can also define parameters by assigning values to variables in a *model workspace*. You define a set of parameters that are specific to the model and save them with the model. See “Model Workspaces” on page 57-106.



## Signals

As you can see in “Build and Edit a Model in the Simulink Editor” on page 1-24, you use signal lines to connect blocks in a model. At a minimum, a model takes an input signal, operates on it, and outputs the result. In the Library Browser, the Sources library contains blocks that represent input signals. The Sinks library contains blocks for capturing and displaying outputs.

Simulink represents signals as lines. The line style varies with the type of signal. You create signals between the output port of one block and the input port of another block by drawing or using shortcuts.

For more on signals, see “Signals” and “Block and Signal Line Shortcuts and Actions” on page 1-91.

## Related Examples

- “Build and Edit a Model in the Simulink Editor” on page 1-24

## More About

- “Edit and Manage Workspace Variables Used by Models” on page 57-92
- “Maximum Size Limits of Simulink Models”
- “Blocks”

## Preview Content of Hierarchical Items

### In this section...

“What Is Content Preview?” on page 1-58

“Enable Content Preview” on page 1-59

“What Content Preview Displays” on page 1-59

### What Is Content Preview?

Content preview displays a representation of the contents of a hierarchical item, such as a subsystem, on the block. Content preview helps you to understand at a glance the kind of processing performed by the hierarchical item.

Hierarchical items that support content preview are:

- Subsystem blocks (but not masked subsystems)
- Model blocks (for referenced models)
- Stateflow charts, subcharts, and graphical functions

By default, the Simulink Editor displays models without content preview. Enable or disable content preview for each block or subsystem. For example, in this model, the Throttle & Manifold subsystem has content preview enabled, and the Compression subsystem does not.

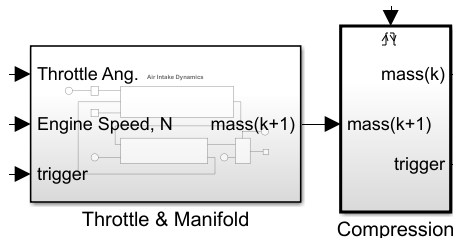

Content preview displays a representation of the contents of a hierarchical item. For details, see “What Content Preview Displays” on page 1-59.

A slight delay can occur in drawing models that contain many hierarchical items that enable content preview if those items contain many blocks.

## Enable Content Preview

Content preview settings apply across Simulink sessions.

- 1 In the Simulink or Stateflow Editor, select the Subsystem or Model blocks or charts whose content you want to preview. To enable content preview for multiple instances of the same referenced model, select each Model block.
- 2 From the context menu, select **Format > Content Preview**.
- 3 To see the content preview for a Model block, open the block.

---

**Tip:** To apply content preview to the whole model, use **Edit > Select All** before enabling content preview.

---

### Enable for Model Blocks

Enabling content preview for Model blocks requires opening the referenced model.

- 1 In the Simulink Editor, right-click the Model block.
- 2 Select **Format > Content Preview**.
- 3 Open the Model block.

## What Content Preview Displays

Simulink scales the content preview to fit the size of the block. To improve the readability of the content preview, you can:

- Zoom.
- Resize the block.

In addition to block icons and signals, content preview displays the following, if present in the system:

- Block labels
- Signal labels
- Highlighted blocks for signals with **Highlight Signal to Source** or **Highlight Signal to Destination** enabled
- Sample time color coding

- Stateflow animation

Simulink does not display content preview for:

- Masked blocks
- Hierarchical block icons when they are smaller than their default size in the Library Browser
- Subsystem blocks when they have the **Read/Write permissions** block parameter set to **NoReadOrWrite**.
- Protected Model blocks
- Model blocks whose referenced models are not loaded
- Models that have **Simulink Preferences > Editor Preferences > Use classic diagram theme** enabled.

The content preview image does not show:

- Block icon graphics, including masked block images
- The content of other hierarchical items contained in the content preview
- Signal line styles (for example, for buses)
- Port information such as port values

## See Also

Model | Subsystem

## Use Viewmarks to Save Views of Models

In this section...
“What Are Viewmarks?” on page 1-61
“Create a Viewmark” on page 1-62
“Open and Navigate Viewmarks” on page 1-63
“Manage Viewmarks” on page 1-63
“Refresh a Viewmark” on page 1-64

### What Are Viewmarks?

Viewmarks are bookmarks to parts of a model. Use viewmarks to capture graphical views of a model so you can navigate directly to that view. You can capture viewmarks for specific levels in a model hierarchy. You can also pan and zoom to capture a point of interest.

Some examples of ways you can use viewmarks include:

- Navigate to specific locations in complex models without opening multiple Simulink Editor tabs or windows.
- Review model designs.
- Visually compare versions of a model.
- Share views of a model by storing viewmarks within the model.

You manage viewmarks in the viewmarks gallery. By default, viewmarks are stored locally on your computer. If you want to include a viewmark to share with a model, see “Save a Viewmark with the Model” on page 1-64. The figure shows the viewmark gallery.

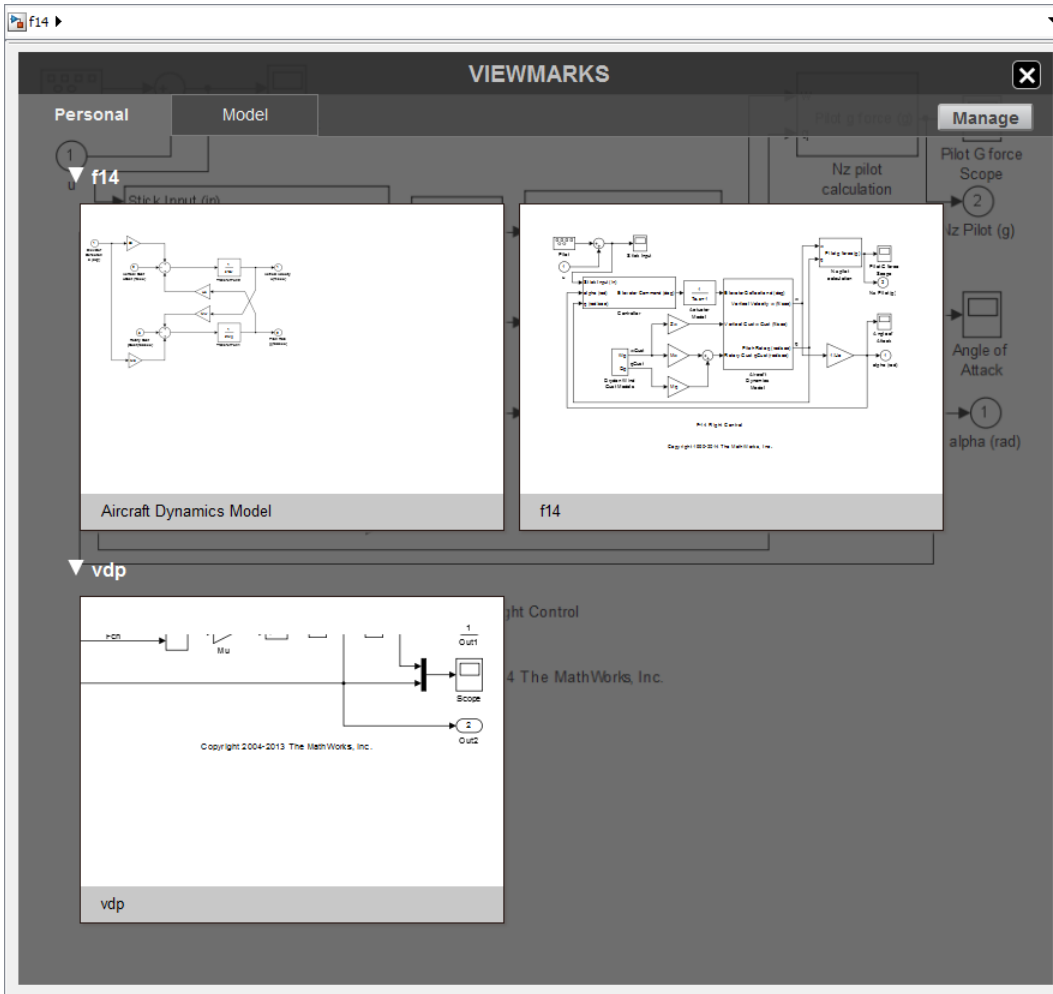

## Create a Viewmark

- 1 Navigate to the part of the model that you want to capture in a viewmark.
- 2 Pan and zoom to the part of the system that you want to capture.
- 3 Resize the Simulink Editor window so that it frames the part of the model you want to capture.

- 4 In the palette, click the **Viewmark This View** button .

The viewmark displays briefly and becomes part of the viewmarks gallery.

## Open and Navigate Viewmarks



The viewmarks gallery has two tabs. The **Personal** tab consists of viewmarks that you created in a model and are stored locally on your computer. The **Model** tab consists of viewmarks that are saved in the Simulink model file.

- 1 In the Simulink Editor palette, click the **Viewmarks** button .
- 2 Select the tab (**Personal** or **Model**) that contains your viewmark, and then click the viewmark.

The Simulink Editor opens the model, if necessary, and displays the part of the model captured in the viewmark.

## Manage Viewmarks

In the viewmarks gallery, you can rename viewmarks, add or edit a description for viewmark, and delete viewmarks. You also use the viewmarks gallery to save viewmarks with the model. You can manage viewmarks only in models saved in SLX format. In models saved in MDL format, the **Manage** button appears dimmed.

- To rename a viewmark, click the name and edit it.
- To add a description, click the viewmark Description button  and enter a description.
- To delete a viewmark, click the **Delete** button  on the viewmark. To delete all the viewmarks for a model, hover over the model name and click **Delete**.



You can replace the generated viewmark name.

- 1 Place the cursor in the viewmark name edit box.
- 2 Enter the new name.

You can also add a viewmark description. For example, you can add a description of the part of the model in the viewmark or add review comments.

- 1 Hover over the viewmark.
- 2 Click the **Description** button .
- 3 In the description edit box, enter the description.

### Save a Viewmark with the Model

- 1 In the Simulink Editor palette, click the **Viewmarks** button .
- 2 In the viewmarks gallery, click **Manage**.
- 3 Select the check box in the viewmarks you want to copy to the model.
- 4 Click the **Add viewmarks to model** button .

These viewmarks become part of the model and are saved with the model.

### Refresh a Viewmark

A viewmark is a static view of a part of a model. For currently loaded models, you can refresh a viewmark so that it reflects the current model. Open the viewmark gallery and click the **Refresh** button  on the viewmark.

If the viewmark shows a subsystem that has been removed, then the viewmark appears dimmed.

### See Also

“Print to a PDF” on page 1-85



# Update Diagram and Run Simulation

## Updating the Diagram

You can leave many attributes of a block diagram, such as signal data types and sample times, unspecified. The Simulink software then infers the values of block diagram attributes, based on the block connectivity and attributes that you specify. The process that Simulink uses is known as *updating the diagram*.

Simulink attempts to infer the most appropriate values for attributes that you do not specify. If Simulink cannot infer an attribute, it halts the update and displays an error.

## Simulation Updates the Diagram

Simulink updates the diagram at the start of a simulation. The updated diagram provides the simulation with the results of the latest changes that you have made to a model.

## Update Diagram While Editing

As you create a model, at any point you can update the diagram. Updating the diagram periodically can help you to identify and fix potential simulation issues as you develop the model. This approach can make it easier to identify the sources of problems by focusing on a set of recent changes. Also, the update diagram processing takes less time than performing a simulation, so you can identify issues more efficiently.

To update the diagram select **Simulation > Update Diagram**, or press **Ctrl+D**.

This example shows the effects of updating the diagram.

- 1 Create the following model.

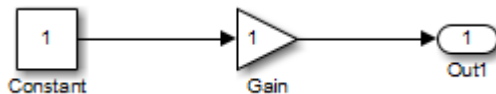

- 2 Select **Display > Signals & Ports > Port Data Types**.

The data types of the output ports of the Constant and Gain blocks appear. The data type of both ports is **double**, the default value.

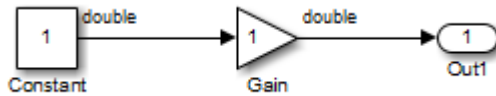

- 3 In the Constant block dialog box, set **Output data type** to `single`.

The output port data type displays on the block diagram do not show this change.

- 4 Select **Simulation > Update Diagram**.

The updated block diagram shows the changes to the output data types of the Constant and Gain blocks.

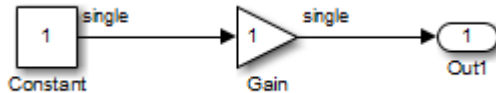

When you update a block diagram, by default, a Gain block chooses an output data type based on the data types of the input signal and the **Gain** parameter. In this example, the block chooses the same data type as the input signal.

## Simulate a Model

For any type of model you build in Simulink, you need to know how to simulate. Simulating performs the operations specified by the blocks in the model and its specific configuration and produces results. See “Simulation” for complete information, such as how to configure your model for simulation.

Use any of these methods to simulate a model:

- Select **Simulation > Run**.
- Press **Ctrl+T**.
- Click the **Run** button .

## Related Examples

- “Simulate a Model Interactively” on page 23-2
- “Control Simulations Programmatically” on page 24-8

- “Run Multiple Simulations” on page 25-2
- “Run Simulations Programmatically” on page 24-2

## Print Model Diagrams

In this section...
“Print Interactively or Programmatically” on page 1-68
“Printing Options” on page 1-68
“Canvas Color” on page 1-68

### Print Interactively or Programmatically

You can print a block diagram:

- Interactively in the Simulink Editor, by selecting **File > Print**
- Programmatically, by using the MATLAB `print` command

To control some additional aspects of printing a block diagram, use the `set_param` command with model parameters. You can use `set_param` with the interactive and programmatic printing interface.

### Printing Options

In addition to printing a model using default settings, you can:

- “Select the Systems to Print” on page 1-74.
- “Specify the Page Layout and Print Job” on page 1-76
- “Print Multiple Pages for Large Models” on page 1-78
- “Print Using Print Frames” on page 66-13
- “Print to a PDF” on page 1-85
- “Add a Log of Printed Models” on page 1-79
- “Add a Sample Time Legend” on page 1-80
- “Print Models to Image File Formats” on page 1-89

### Canvas Color

By default, the canvas (background) of the printed model is white. To match the color of the model, set the **Simulink Preferences > General > Print** preference.

**See Also**

print

**Related Examples**

- “Basic Printing” on page 1-70
- “Print from the MATLAB Command Line” on page 1-81
- “Print Model Reports” on page 1-86

**More About**

- “Tiled Printing” on page 1-77
- “Print Frames” on page 66-2

## Basic Printing

**In this section...**

“Print the vdp Model Using Default Settings” on page 1-70

“Print a Subsystem Hierarchy” on page 1-72

### Print the vdp Model Using Default Settings

The default print settings produce good quality printed output for quickly capturing a model in printed form.

- 1 Open the vdp model.

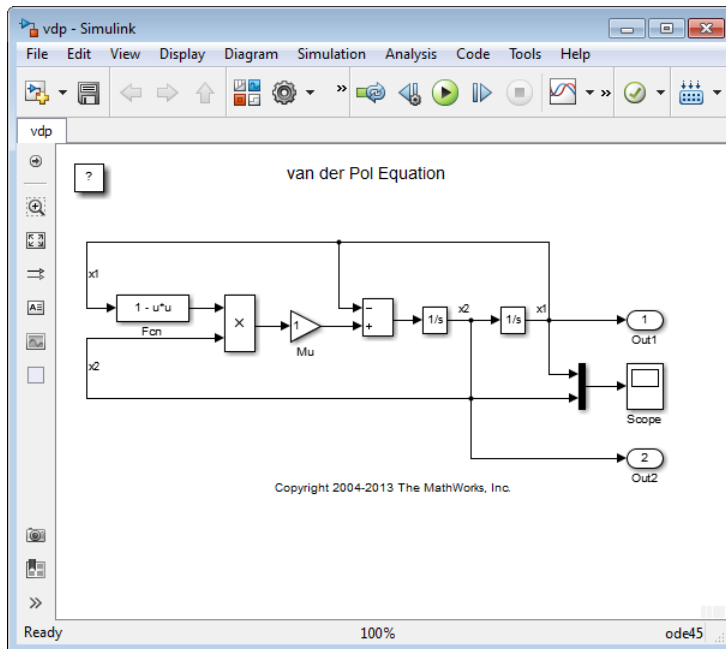

- 2 In the Simulink Editor, select **File > Print > Print**.
- 3 In the Print Model dialog box, use the default settings. Click **Print**.

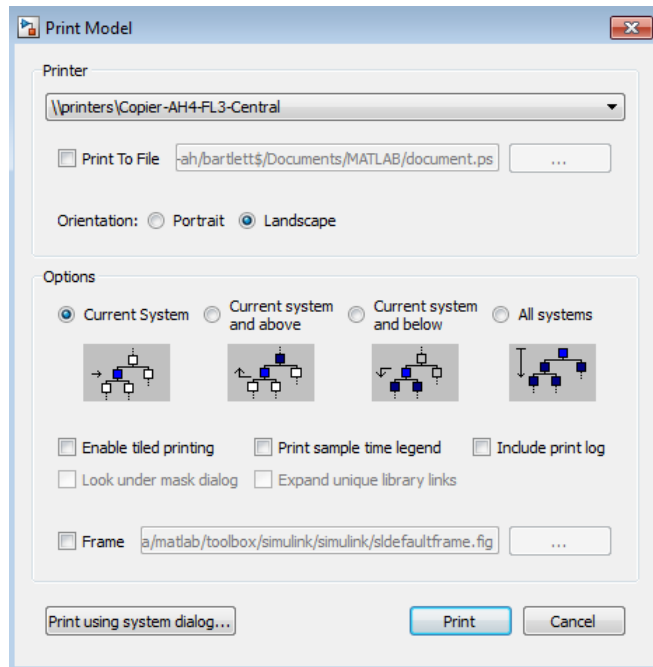

The output looks like this. The model, as it appears in the Simulink Editor, prints on a single page, using portrait orientation and not using a print frame.

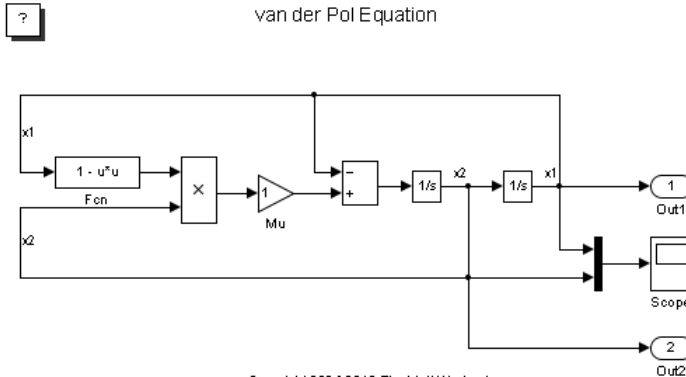

## Print a Subsystem Hierarchy

You can print levels in nested subsystems.

- 1 Open the `sldemo_enginewc` model.

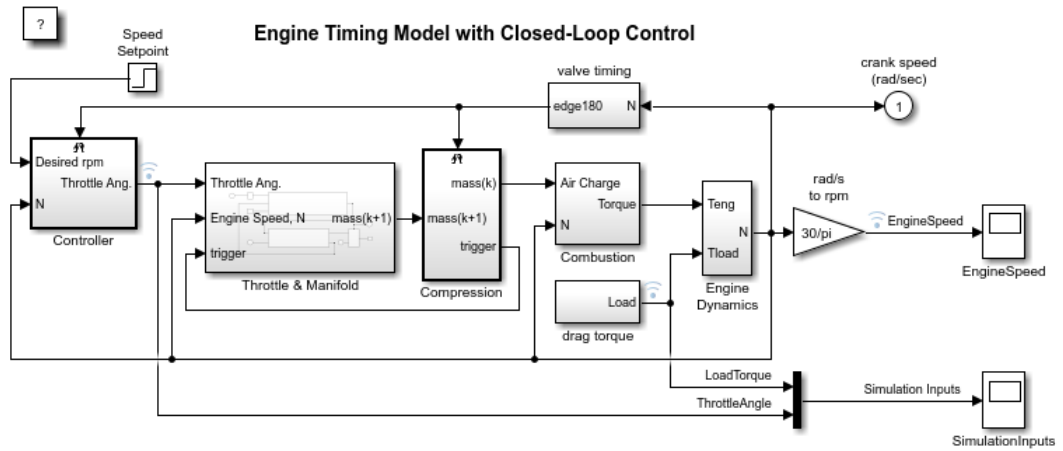

- 2 Open the Throttle & Manifold subsystem.

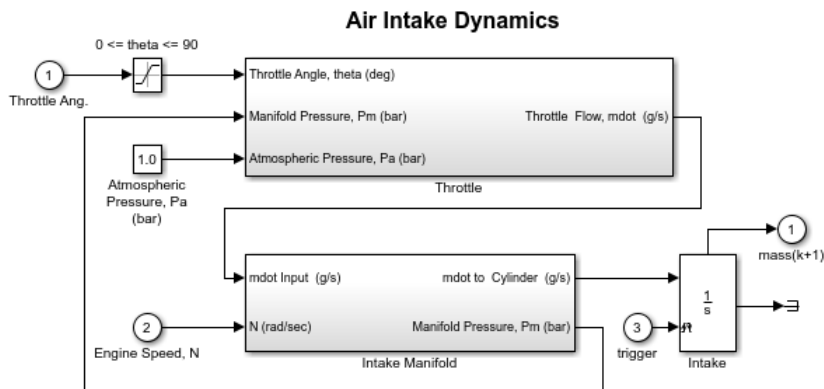

- 3 Open the Throttle subsystem.



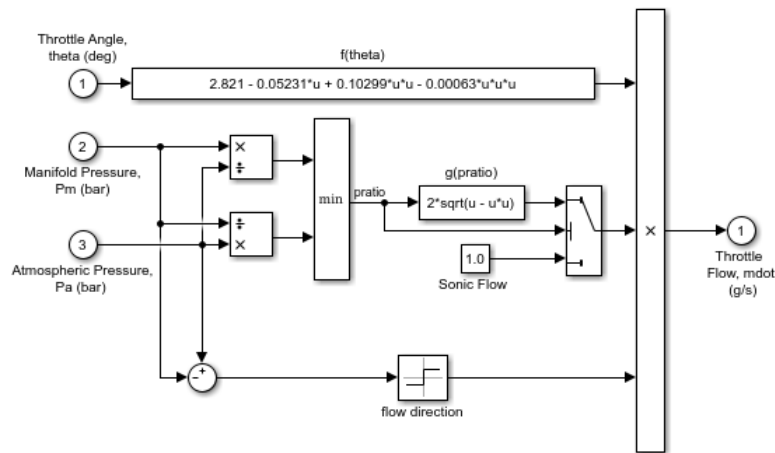

4 In the Simulink Editor, select **File > Print > Print**.

5 In the Print Model dialog box, click **Current system and above** and click **Print**.

The printed output shows the Throttle subsystem (the current system) and the two levels above it in the subsystem hierarchy.

## Related Examples

- “Print from the MATLAB Command Line” on page 1-81
- “Specify the Page Layout and Print Job” on page 1-76
- “Print Subsystems” on page 1-74

## More About

- “Print Model Diagrams” on page 1-68

## Select the Systems to Print

In this section...
“Print Current System” on page 1-74
“Print Subsystems” on page 1-74
“Print a Model Referencing Hierarchy” on page 1-75

### Print Current System

To select a specific system in a model to print, display that system in the currently open Simulink Editor tab and select **File > Print > Print**.

### Print Subsystems

For models with subsystems, use the Simulink Editor and the Print Model dialog box to specify the systems in the model to print.

By default, Simulink does not print masked subsystems or library links. For information about masked subsystem and library link printing, see “Print Masked Subsystems and Library Links” on page 1-75.

### Print All Subsystems in a Model

Use this procedure to print all of the subsystems in a model, including hierarchies of subsystems.

- 1 Display the top-level model in the currently open Simulink Editor tab.
- 2 In the Simulink Editor, select **File > Print > Print**.
- 3 In the Print Model dialog box, select **All systems**.
- 4 Click **Print**.

### Print the Contents of a Specific Subsystem

In the currently open Simulink Editor tab, display the subsystem that you want to print and click **Print**.

### Print a Subsystem Hierarchy

Use this procedure to print nested subsystems.

- 1 In the current tab of the Simulink Editor, display the subsystem level that you want to use as the starting point for printing the subsystem hierarchy.
- 2 In the Print Model dialog box, select one of the following:
  - **Current system and below**
  - **Current system and above**
- 3 Click **Print**.

Simulink prints the hierarchy for all of the subsystems in the current tab.

### **Print Masked Subsystems and Library Links**

To print the contents of masked subsystems, in the Print Model dialog box, click **Look under mask dialog**.

To print the contents of library links, in the Print Model dialog box, click **Expand unique library links**. Simulink prints one copy, regardless of how many copies of the block the model contains.

If a subsystem is both a masked subsystem and a library link, Simulink uses the **Look under mask dialog** setting and ignores the **Expand unique library links** setting.

### **Print a Model Referencing Hierarchy**

To print a model referencing hierarchy, open each level of the hierarchy and print that level.

Clicking **All systems** does not print different levels in the model referencing hierarchy.

You cannot print the contents of protected models.

### **More About**

- “Model Hierarchy”

## Specify the Page Layout and Print Job

<b>In this section...</b>
“Page and Print Job Setup” on page 1-76
“Set Paper Size and Orientation Without Printing” on page 1-76

### Page and Print Job Setup

Use the Print Model dialog box to specify the page orientation (portrait or landscape) for the current printing session.

To open the print dialog box for your operating system, in the Print Model dialog box, click **Print using system dialog**. The operating system print dialog box provides additional printing options for models, such as page range, copies, double-sided printing, printing in color (if your print driver supports color printing), and nonstandard paper sizes.

### Set Paper Size and Orientation Without Printing

To specify paper size and orientation without printing, use the Page Setup dialog box. To open the dialog box, select **File > Print > Page Setup**.

Only the paper size and orientation are used.

### Related Examples

- “Basic Printing” on page 1-70

### More About

- “Print Model Diagrams” on page 1-68

## Tiled Printing

By default, each block diagram is scaled during the printing process so that it fits on a single page. In the case of a large diagram, this automatic scaling can make the printed image difficult to read.

Tiled printing enables you to print even the largest block diagrams without sacrificing clarity and detail. Tiled printing allows you to distribute a block diagram over multiple pages. For example, you can use tiling to divide a model as shown in the figure, with each white box and each gray box representing a separate printed page.

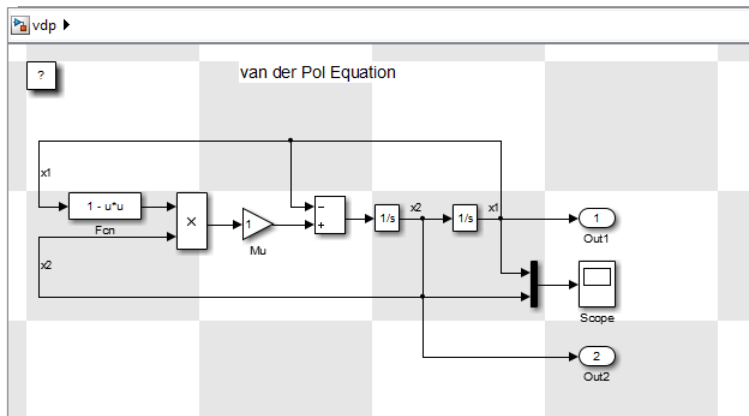

You can control the number of pages over which Simulink prints the block diagram.

Also, you can set different tiled-print settings for each of the systems in your model.

---

**Note:** If you enable the print frame option, then Simulink does not use tiled printing.

---

### Related Examples

- “Print Using Print Frames” on page 66-13
- “Print Multiple Pages for Large Models” on page 1-78

## Print Multiple Pages for Large Models

- 1 In the Simulink Editor, open the model in the current tab.
- 2 Select **File > Print > Print**.
- 3 In the Print Model dialog box, click **Enable tile printing**.

The default Enable tile printing setting in the Print Model dialog box is the same as the **File > Print > Enable Tiled Printing** setting. If you change the Print Model dialog box **Enable tile printing** setting, the Print Model dialog box setting takes precedence.

- 4 Confirm that tiling divides the model into separate pages the way you want it to appear in the printed pages. In the Simulink Editor, select **File > Print > Show Page Boundaries**. The gray and white squares indicate the page boundaries.
- 5 Optionally, from the MATLAB command line, specify the model scaling, tile margins, or both. See “Set Tiled Page Scaling and Margins” on page 1-83.
- 6 Optionally, specify a subset of pages to print. In the Print Model dialog box, specify the **Page Range**.
- 7 Click **Print**.

### Related Examples

- “Use Tiled Printing” on page 1-83

### More About

- “Tiled Printing” on page 1-77

## Add a Log of Printed Models

A print log lists the blocks and systems printed. To print the print log when you print a model:

- 1 In the Simulink Editor, open the model whose print job you want to log.
- 2 Select **File > Print > Print**.
- 3 In the Print Model dialog box, click **Include print log**.
- 4 Click **Print**.

The print log appears on the last page.

For example, here is the print log for the `sldemo_enginewc` model, with **All systems** enabled and **Enable tiled printing** cleared.

Page	System Name
1	<code>sldemo_enginewc</code>
2	<code>sldemo_enginewc/Combustion</code>
3	<code>sldemo_enginewc/Compression</code>
4	<code>sldemo_enginewc/Controller</code>
5	<code>sldemo_enginewc/Engine Dynamics</code>
6	<code>sldemo_enginewc/More Info</code>
7	<code>sldemo_enginewc/Throttle &amp; Manifold</code>
8	<code>sldemo_enginewc/Throttle &amp; Manifold/Intake Manifold</code>
9	<code>sldemo_enginewc/Throttle &amp; Manifold/Throttle</code>
10	<code>sldemo_enginewc/drag torque</code>
11	<code>sldemo_enginewc/valve timing</code>
12	<code>sldemo_enginewc/valve timing/TDC and BDC detection</code>
13	<code>sldemo_enginewc/valve timing/positive edge to dual edge conversion</code>

### More About

- “Print Model Diagrams” on page 1-68





## Add a Sample Time Legend

You can print a legend that contains sample time information for your entire system, including any subsystems. The legend appears on a separate page from the model. To print a sample time legend:

- 1 In the Simulink Editor, select **Simulation > Update diagram**.
- 2 Select **File > Print > Print**.
- 3 In the Print Model dialog box, click **Print sample time legend**.
- 4 Click **Print**.

A sample time legend appears on the last page. For example, here is the sample time legend for the `sldemo_enginewc` model, with **All systems** enabled.

### Sample Times for 'sldemo\_enginewc'

Color	Description	Value
	Continuous	0
	Fixed in Minor Step	[0,1]
	Constant	Inf
	Triggered	Source: FiM

## Related Examples

- “View Sample Time Information” on page 7-9

## More About

- “Print Model Diagrams” on page 1-68



## Print from the MATLAB Command Line

### In this section...

“Printing Commands” on page 1-81

“Print Systems with Multiline Names or Names with Spaces” on page 1-81

“Set Paper Orientation and Type” on page 1-82

“Position and Size a System” on page 1-82

“Use Tiled Printing” on page 1-83

### Printing Commands

The MATLAB `print` command provides several options for printing Simulink models. For example, print the `Compression` subsystem in the `sldemo_enginewc` model to your default printer:

```
open_system('sldemo_enginewc');  
print -sCompression
```

---

**Tip:** When you use the `print` command, you can print only one system. To print multiple levels in a model, use multiple `print` commands, one for each system that you want to print. To print multiple systems in a model, consider using the Print Model dialog box in the Simulink Editor. For details, see “Select the Systems to Print” on page 1-74.

---

You can use `set_param` to specify printing options for models. For details, see “Model Parameters”.

You can use `orient` to control the paper orientation.

### Print Systems with Multiline Names or Names with Spaces

To print a system whose name appears on multiple lines, assign the newline character to a variable and use that variable in the `print` command. This example shows how to print a subsystem whose name, `Aircraft Dynamics Model`, appears on three lines.

```
open_system('f14');  
open_system('f14/Aircraft Dynamics Model');
```

```
sys = sprintf('f14/Aircraft\nDynamics\nModel');  
print (['-s' sys])
```

To print a system whose name includes one or more spaces, specify the name as a character vector. For example, to print the Throttle & Manifold subsystem, enter:

```
open_system('sldemo_enginewc');  
open_system('sldemo_enginewc/Throttle & Manifold');  
print (['-sThrottle & Manifold'])
```

## Set Paper Orientation and Type

To set just the paper orientation, use the MATLAB `orient` command.

You can also set the paper orientation by using `set_param` with the `PaperOrientation` model parameter. Set the paper type with the `PaperType` model parameter.

## Position and Size a System

To position and size the model diagram on the printed page, use `set_param` command with the `PaperPositionMode` and `PaperPosition` model parameters.

The value of the `PaperPosition` parameter is a vector of form `[left bottom width height]`. The first two elements specify the bottom-left corner of a rectangular area on the page, measured from the bottom-left corner. The last two elements specify the width and height of the rectangle.

If you set the `PaperPositionMode` parameter to `manual`, Simulink positions (and scales, if necessary) the model to fit inside the specified print rectangle. If `PaperPositionMode` is `auto`, Simulink centers the model on the printed page, scaling the model, if necessary, to fit the page.

For example, to print the `vdp` model in the lower-left corner of a U.S. letter-size page in landscape orientation:

```
open_system('vdp');  
set_param('vdp', 'PaperType', 'usletter');  
set_param('vdp', 'PaperOrientation', 'landscape');  
set_param('vdp', 'PaperPositionMode', 'manual');  
set_param('vdp', 'PaperPosition', [0.5 0.5 4 4]);
```

```
print -svdp
```

## Use Tiled Printing

### Enable Tiled Printing

- 1 Use `set_param` to set the `PaperPositionMode` parameter to `tiled`.
- 2 Use the `print` command with the `-tileall` argument.

For example, to enable tiled printing for the `Compression` subsystem in the `sldemo_enginewc` model:

```
open_system('sldemo_enginewc');  
set_param('sldemo_enginewc/Compression', 'PaperPositionMode', ...  
    'tiled');  
print('-ssldemo_enginewc/Compression', '-tileall')
```

### Display Tiled Page Boundaries

To display the page boundaries programmatically, use the `set_param` command, with the model parameter `ShowPageBoundaries` set to `on`. For example:

```
open_system('sldemo_enginewc');  
set_param('sldemo_enginewc', 'ShowPageBoundaries', 'on')
```

### Set Tiled Page Scaling and Margins

To scale the block diagram so that more or less of it appears on a single tiled page, use `set_param` with the `TiledPageScale` parameter. By default, the value is 1. Values greater than 1 proportionally scale the model to use a smaller percentage of the tiled page, while values between 0 and 1 proportionally scale the model to use a larger percentage of the tiled page. For example, a `TiledPageScale` of 0.5 makes the printed diagram appear twice its size on a tiled page, while a `TiledPageScale` value of 2 makes the printed diagram appear half its size on a tiled page.

By decreasing the margin sizes, you can increase the printable area of the tiled pages. To specify the margin sizes associated with tiled pages, use `set_param` with the `TiledPaperMargins` parameter. Each margin is 0.5 inches by default. The value of `TiledPaperMargins` is a vector that specifies margins in this order: `[left top right bottom]`. Each element specifies the size of the margin at a particular edge of the page. The value of the `PaperUnits` parameter determines the units of measurement for the margins.

## Specify Range of Tiled Pages to Print

To specify a range of tiled page numbers programmatically, use `print` with the `-tileall` argument and the `-pages` argument. Append to `-pages` a two-element vector that specifies the range.

---

**Note:** Simulink uses a row-major scheme to number tiled pages. For example, the first page of the first row is 1, the second page of the first row is 2, and so on.

---

For example, to print the second, third, and fourth pages:

```
open_system('vdp');  
print('-svdp','-tileall','-pages[2 4]')
```

## See Also

`orient` | `print`

## Related Examples

- “Select the Systems to Print” on page 1-74

## Print to a PDF

You can print a model to a `.pdf` file. Simulink creates one file for all of the systems in the model.

- 1 In the Simulink Editor, select **File > Print > Print**.
- 2 Select the **Print to File** check box.
- 3 Specify a location and file name to save the new `.pdf` file. Include the extension `.pdf` in the file name.
- 4 Click **Print**.

### More About

- “Print Model Diagrams” on page 1-68

## Print Model Reports

A model report is an HTML document that describes the structure and content of a model. The report includes block diagrams of the model and its subsystems and the settings of its block parameters.

---

**Tip:** If you have the Simulink Report Generator™ installed, you can generate a detailed report about a system. To do so, in the Simulink Editor, select **File > Reports > System Design Description**. For more information, see “System Design Description” (Simulink Report Generator).

---

To generate a model report for the current model:

- 1 In the Simulink Editor, select **File > Print > Print Details**.
- 2 In the Print Details dialog box, select report options. For details, see “Model Report Options” on page 1-87.
- 3 Select **Print**.

The Simulink software generates the HTML report and displays the report in your default HTML browser.

While generating the report, Simulink displays status messages on a messages pane that replaces the options pane on the Print Details dialog box.

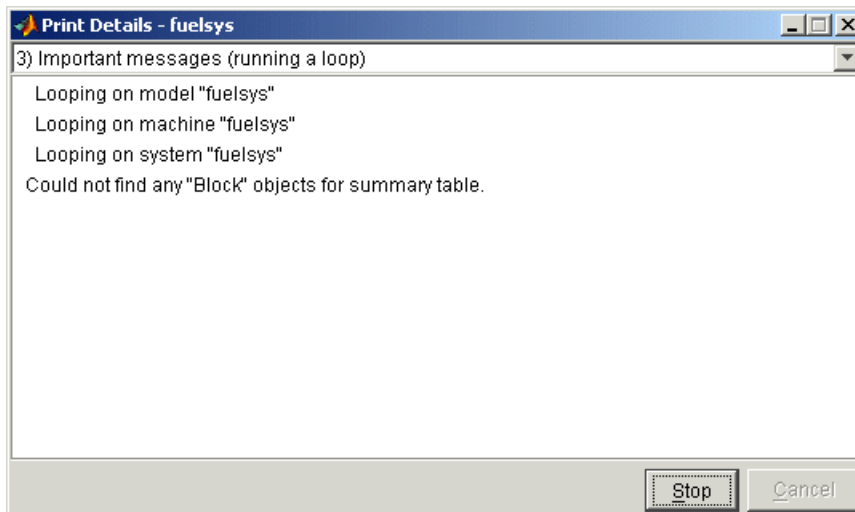

Select the detail level of the messages from the list at the top of the messages pane. When the report generation process begins, the **Print** button changes to a **Stop** button. To stop the report generation, click **Stop**. When the report generation process finishes, the **Stop** button changes to an **Options** button. Clicking this button redisplay the report generation options, allowing you to generate another report without having to reopen the Print Details dialog box.

## Model Report Options

Use the Print Details dialog box allows you to specify the following report options.

### Directory

The folder where the HTML report is stored. The options include your system's temporary folder (the default), your system's current folder, or another folder whose path you specify in the adjacent edit field.

### Increment filename to prevent overwriting old files

Creates a unique report file name each time you generate a report for the same model in the current session. This preserves each report.

### Current object

Include only the currently selected object in the report.

## **Current and above**

Include the current object and all levels of the model above the current object in the report.

## **Current and below**

Include the current object and all levels below the current object in the report.

## **Entire model**

Include the entire model in the report.

## **Look under mask dialog**

Include the contents of masked subsystems in the report.

## **Expand unique library links**

Include the contents of library blocks that are subsystems. The report includes a library subsystem only once even if it occurs in more than one place in the model.

## **More About**

- “Print Model Diagrams” on page 1-68
- “Masking Fundamentals” on page 37-2



## Print Models to Image File Formats

To print the current view of your model to an image file format such as `.png` or `.jpeg`, use the `-device` argument with the MATLAB `print` command. For example, to print the `vdp` model to a `.png` format, use this command:

```
print -dpng -svdp vdp_model.png
```

By default, the canvas (background) of the exported model matches the color of the model. To use a white or transparent canvas for model files that you export to another file format, set the **Simulink Preferences > Export** preference.

## Copy Model Views to Third-Party Applications

On Microsoft Windows platforms, you can copy the current view of your model in either bitmap or metafile format. You can then paste the clipboard image to a third-party application such as word processing software.

On Macintosh platforms, when you copy a model view to the clipboard, Simulink saves the model in a scalable format, in addition to a bitmap format. When you paste from the clipboard to an application, the application selects the format that best meets its requirements.

By default, the canvas (background) of the copied model matches the color of the model. To use a white or transparent canvas for model files that you copy to another application, set the **Simulink Preferences > Clipboard** preference.

- 1 To copy a Simulink model to the operating system clipboard, in the Simulink Editor select **Edit > Copy Current View to Clipboard**.
- 2 Paste the model from the clipboard to a third-party application.

## Related Examples

- “Set Simulink Preferences”

## Keyboard and Mouse Actions for Simulink Modeling

In this section...
“Object Selection and Clipboard Operations” on page 1-90
“Block and Signal Line Shortcuts and Actions” on page 1-91
“Signal Name and Label Actions” on page 1-92
“Simulation Keyboard Shortcuts” on page 1-93
“Debugging and Breakpoints Keyboard Shortcuts” on page 1-93
“Zooming and Scrolling Shortcuts” on page 1-93
“Library Browser Shortcuts” on page 1-94
“File Operations” on page 1-95

---

**Note:** On Macintosh platforms, use the **command** key instead of **Ctrl**.

---

### Object Selection and Clipboard Operations

Objects include blocks, signal lines, signal labels, and annotations.

Task	Action
Select an object	Click
Select additional objects	<b>Shift</b> +click
Select all objects	<b>Ctrl</b> + <b>A</b>
Copy object	Drag with right mouse button  <b>Ctrl</b> +drag
Move any object, including signal labels	Drag
Delete selected object	<b>Delete</b> or <b>Backspace</b>  <b>Edit &gt; Clear</b>
Cut	<b>Ctrl</b> + <b>X</b>
Paste	<b>Ctrl</b> + <b>V</b>

<b>Task</b>	<b>Action</b>
Duplicate object	<b>Ctrl+C, Ctrl+V</b>
Undo	<b>Ctrl+Z</b>
Redo	<b>Ctrl+Y</b>

## Block and Signal Line Shortcuts and Actions

<b>Task</b>	<b>Action</b>
Set the main parameter for selected block	<b>Alt+Enter</b>
Open or hide the Property Inspector	<b>Ctrl+Shift+I</b>
Copy block or model from another Simulink Editor window	Drag between windows
Move block	Arrow keys
Resize block, keeping same ratio of width and height	<b>Shift</b> +drag handle
Resize block from the center	<b>Ctrl</b> +drag handle
Rotate block clockwise	<b>Ctrl+R</b>
Rotate block counterclockwise	<b>Ctrl+Shift+R</b>
Flip block	<b>Ctrl+I</b>
Connect blocks	Select first block, <b>Ctrl</b> +click second block Drag from port to port
Draw branch line	<b>Ctrl</b> +drag line Right-mouse button+drag
Route lines around blocks	<b>Shift</b> +drag while drawing
Disconnect block	<b>Shift</b> +drag block
Create subsystem from selected blocks	<b>Ctrl+G</b>
Open selected subsystem	<b>Enter</b>

Task	Action
Go to parent of selected subsystem	<b>Esc</b>
Find block	<b>Ctrl+F</b>
Mask subsystem	<b>Ctrl+M</b>
Look under block mask	<b>Ctrl+U</b>
Comment through a block	<b>Ctrl+Shift+Y</b>
Comment out/uncomment a block	<b>Ctrl+Shift+X</b>
Refresh Model blocks	<b>Ctrl+K</b>
For a linked block, go to the library of the parent block	<b>Ctrl+L</b>
Open Model Explorer	<b>Ctrl+H</b>

## Signal Name and Label Actions

The signal name appears in a label on the signal line.

Task	Action
Name a signal line	Double-click signal and type name
Name a branch of a named signal line	Double-click the branch
Name every branch of a signal	Right-click the signal, select <b>Properties</b> , and use the dialog box
Delete signal label and name	Delete characters in label or delete name in Signal Properties dialog box.
Delete signal label only	Right-click label and select <b>Delete Label</b> .
Open signal label text box for edit	Double-click signal line Click label
Move signal label	Drag label to a new location on same signal line
Copy signal label	<b>Ctrl</b> +drag signal label

<b>Task</b>	<b>Action</b>
Change the label font	Select the signal line (not the label) and use <b>Diagram &gt; Format &gt; Font Style</b>

## Simulation Keyboard Shortcuts

<b>Task</b>	<b>Action</b>
Open Configuration Parameters dialog box	<b>Ctrl+E</b>
Update diagram	<b>Ctrl+D</b>
Start simulation	<b>Ctrl+T</b>
Stop simulation	<b>Ctrl+Shift+T</b>
Build model (for code generation)	<b>Ctrl+B</b>

## Debugging and Breakpoints Keyboard Shortcuts

<b>Task</b>	<b>Action</b>
Step	<b>F10</b>
Step in	<b>F11</b>
Step out	<b>Shift + F11</b>
Run	<b>F5</b>
Set/Clear breakpoint	<b>F12</b>

## Zooming and Scrolling Shortcuts

<b>Task</b>	<b>Action</b>
Zoom in	<b>Ctrl++</b>
Zoom out	<b>Ctrl+-</b>
Zoom to normal (100%)	<b>Ctrl+0 or Alt+1</b>
Zoom with mouse	<b>Ctrl+scroll wheel</b>

Task	Action
	Select the <b>File &gt; Simulink Preferences &gt; Editor Preferences &gt; Scroll wheel controls zooming</b> preference to zoom using just the scroll wheel.
Zoom in on object	Drag the <b>Zoom</b> button  from the palette to the object
Fit diagram to screen	<b>Spacebar</b>
Scroll view	Arrow keys <b>Shift</b> +arrow for larger pans
Scroll with mouse	<b>Spacebar</b> +drag Hold the scroll wheel down and drag the mouse

## Library Browser Shortcuts

Task	Shortcut
Open a model	<b>Ctrl+O</b>
Open Library Browser from a model	<b>Ctrl+Shift+L</b>
Move selection down in the Blocks or Libraries pane	<b>Down arrow</b>
Move selection up in the Blocks or Libraries pane	<b>Up arrow</b>
Expand a node in the Libraries pane	<b>Right arrow</b>
Collapse a node in the Libraries pane	<b>Left arrow</b>
Refresh Libraries pane	<b>F5</b>
Show parent library in Blocks pane	<b>Esc</b>
Select a block found with the search tool in the Blocks pane	<b>Ctrl+R</b>

<b>Task</b>	<b>Shortcut</b>
Insert the selected block in a new model	<b>Ctrl+I</b>
Increase zoom in the Blocks pane	<b>Ctrl++</b>
Decrease zoom in the Blocks pane	<b>Ctrl+-</b>
Reset zoom to default in the Blocks pane	<b>Alt+1</b>
Find a block	<b>Ctrl+F</b>
Close	<b>Ctrl+W</b>

## File Operations

<b>Task</b>	<b>Action</b>
Open model	<b>Ctrl+O</b>
Create a model	<b>Ctrl+N</b>
Print	<b>Ctrl+P</b>
Save	<b>Ctrl+S</b>
Close model	<b>Ctrl+W</b>

## Related Examples

- “Build and Edit a Model in the Simulink Editor” on page 1-24





# Simulation Stepping

---

- “How Simulation Stepper Helps With Model Analysis” on page 2-2
- “How Stepping Through a Simulation Works” on page 2-3
- “Use Simulation Stepper” on page 2-8
- “Simulation Stepper Limitations” on page 2-12
- “Step Through a Simulation” on page 2-15
- “Set Conditional Breakpoints for Stepping a Simulation” on page 2-18

# How Simulation Stepper Helps With Model Analysis

Simulation Stepper enables you to step through major time steps of a simulation. Using discrete time steps, you can step forward or back to a particular instant in simulation time. At each time step, Stepper displays all of the simulation data the model produces.

Use Simulation Stepper to analyze your model in these ways:

- Step forward and back through a simulation.
- Pause a simulation in progress and step back.
- Continue running a simulation after stepping back.
- Analyze plotted data in your model at a particular moment in simulation time.
- Set conditions before and during simulation to pause a simulation.

## Related Examples

- “Step Through a Simulation” on page 2-15

## More About

- “How Stepping Through a Simulation Works” on page 2-3
- “How Simulation Stepper Differs from Simulink Debugger” on page 2-5

# How Stepping Through a Simulation Works

**In this section...**

“Simulation Snapshots” on page 2-3

“How Simulation Stepper Uses Snapshots” on page 2-4

“How Simulation Stepper Differs from Simulink Debugger” on page 2-5

These topics explain how Simulation Stepper steps through a simulation.

## Simulation Snapshots

When you set up Simulation Stepper, you specify:

- The number of time steps where Stepper creates ‘snapshots’
- The number of steps to skip between snapshots
- The total number of snapshots stored

A simulation snapshot contains simulation state (SimState) and information related to logged data and visualization blocks. Simulation Stepper stores simulation states in snapshots at the specified interval of time steps when it steps forward through a simulation.

It is important to understand the difference between a Simulation Stepper step and a simulation time step. A simulation time step is the fixed amount of time by which the simulation advances. A Simulation Stepper step is where Simulation Stepper creates a snapshot. Each step (that Simulation Stepper takes) consists of one or more simulation time steps (that you specify).

When you step back through a simulation, the software uses simulation snapshots, stored as SimStates, to display previous states of the simulation. The model does not simulate in reverse when stepping back. Therefore, to enable the step back capability, you must first simulate the model or step it forward to save snapshots.

Keep in mind that snapshots for stepping back are available only during a single simulation. The Simulation Stepper does not save the steps from one simulation to the next.

## How Simulation Stepper Uses Snapshots

A simulation snapshot captures all the information required to continue a simulation from that point. When you set up simulation stepping, you specify:

- The maximum number of snapshots to capture while simulating forward. The greater the number, the more memory the simulation uses and the longer the simulation takes to run.
- The number of time steps to skip between snapshots. This setting enables you to save snapshots of simulation state when stepping forward at periodic intervals, such as every three steps. This interval is independent of the number of forward or backward time steps taken. Because taking simulation snapshots affects simulation speed, saving snapshots less frequently can improve simulation speed.

The figure shows how you can step through a simulation depending on how you set the parameters in the Simulation Stepping Options dialog box. Because you can change the stepping parameters as you step through the simulation, you can step through a simulation as shown in this figure: sometimes by single steps and sometimes by two or more steps.

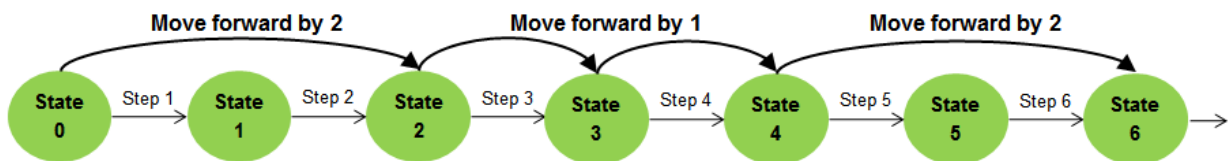

In the figure, the interval for snapshot captures is three.

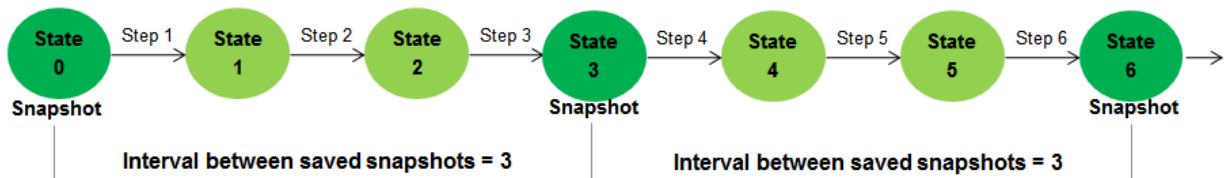

This next figure shows the advantage of changing the stepping options while stepping forward. At the fourth step, the interval between stored steps changed the snapshot steps from three to one. This enables you to capture more snapshots around a simulation time of interest.

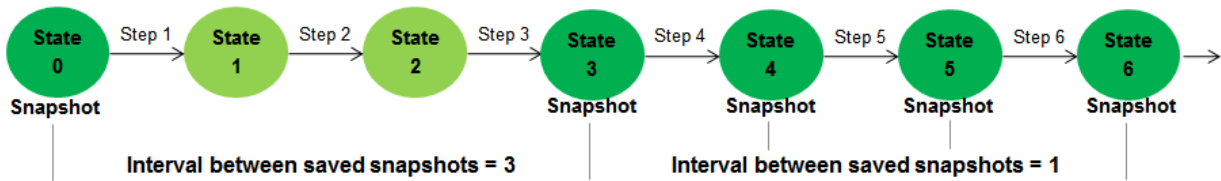

The next figure shows how the snapshot settings of Simulation Stepper can change what happens when stepping back. Suppose that the interval between snapshots is set to three, and starting at state six, the stepper **Move back/forward by** setting is set to one. The stepper first restores the simulation state to the last saved snapshot (state three), and then simulates two major time steps to arrive at the desired state (state five).

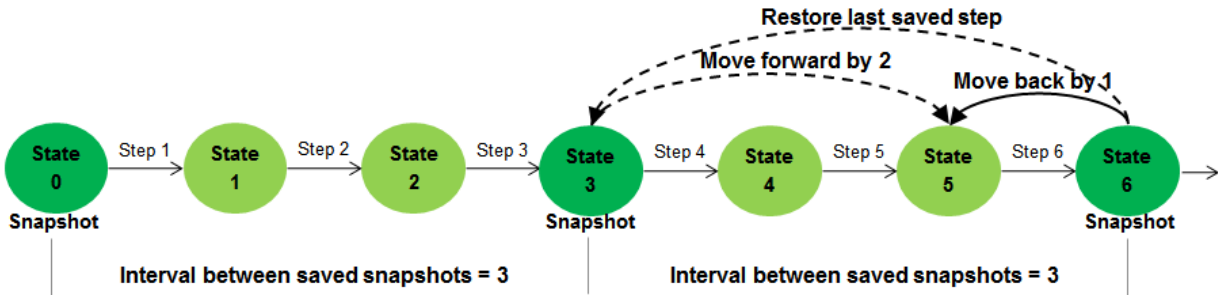

Thus, when you step back to a particular time step in a simulation, Simulation Stepper restores the last saved snapshot before that time step. Then, it steps forward to the time step you specify. This capability is helpful for memory usage and simulation performance.

## How Simulation Stepper Differs from Simulink Debugger

Simulation Stepper and Simulink Debugger both enable you to start, stop, and step through a model simulation. Both tools allow you to use breakpoints as part of a debugging session. However, you use Simulation Stepper and Simulink Debugger for different purposes. The table shows the actions you can perform with each tool.

Action	Simulation Stepper	Simulink Debugger
Look at state of system after executing a major time step.	✓	✓

Action	Simulation Stepper	Simulink Debugger
Observe dynamics of the entire model from step to step.	✓	
Step simulation back.	✓	
Pause across major steps.	✓	
Control a Stateflow debugging session.	✓	
Step through simulation by major steps.	✓	
Monitor single block dynamics (for example, output and update) during a single major time step.		✓
Look at state of system while executing a major time step.		✓
Observe solver dynamics during a single major step.		✓
Show various stages of Simulink simulation.		✓
Pause within a major step.		✓
Step through a simulation block by block.		✓
Access via a command-line interface.		✓

Understanding the simulation process can help you to better understand the differences between Simulation Stepper and Simulink Debugger.

### Related Examples

- “Step Through a Simulation” on page 2-15

## **More About**

- “Use Simulation Stepper” on page 2-8

# Use Simulation Stepper

### In this section...

“Simulation Stepper Access” on page 2-8

“Simulation Stepper Pause Status” on page 2-8

“Tune Parameters” on page 2-9

“Referenced Models” on page 2-10

“Simulation Stepper and Interval Logging” on page 2-10

“Simulation Stepper and Stateflow Debugger” on page 2-10

## Simulation Stepper Access

You run Simulation Stepper and access the settings from the Simulink Editor toolbar .



Click the Stepping Options button  to open the Simulation Stepping Options dialog box.

Use the dialog box to enable stepping back through a simulation. When stepping back is enabled, after you start the simulation, the Stepping Options button changes to , and then you can use it to step back. In that case, you can access the dialog box again only by using **Simulation > Stepping Options**.

If you clear the **Enable previous stepping** check box, the software clears the stored snapshot cache.

## Simulation Stepper Pause Status

The status bar at the bottom of the Simulink Editor displays the simulation time of the last completed simulation step. While a simulation is running, the editor updates the



time display to indicate the simulation progress. This display is approximate because the status bar updates only at every major time step and not at every simulation time step. When you pause a simulation, the status bar display time catches up to the actual time of the last completed step.

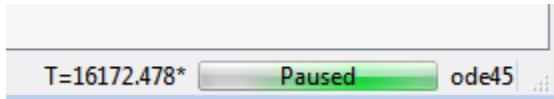

The value (the time of the last completed step) that is displayed on the status bar is not always the same as the time of the solver. This happens because different solvers use different ways to propagate the simulation time in a single iteration of the simulation loop. Simulation Stepper pauses at a single position within the simulation loop. Some solvers perform their time advance before Simulation Stepper pauses. However, other solvers perform their time advance after Simulation Stepper pauses, and the time advance then becomes part of the next step. As a result, for continuous and discrete solvers, the solver time is always one major step ahead of the time of the last model output.

When this condition occurs, and the simulation is paused, the status bar time displays an asterisk. The asterisk indicates that the solver in this simulation has already advanced past the displayed time (which is the time of the last completed simulation step).

## Tune Parameters

While using Simulation Stepper, when the simulation is paused, you can change tunable parameters, including some solver settings. However, changes to the solver step size take effect when the solver advances the simulation time. For some solvers, this occurs after the next simulation step is taken.

Simulation Stepper takes into account the size of a movement (**Move back/forward by**) and the frequency of saving steps (**Interval between stored back steps**). If you specify a frequency that is larger than the step size, Simulation Stepper first steps back to the last saved step and then simulates forward until the total step count difference reaches the size of the desired movement. Simulation Stepper applies values for tunable parameters when simulating forward. For this reason, if you change any tunable parameter before stepping back, the resulting simulation output might not match the previous simulation output at that step before the parameter change. This can cause unexpected results when stepping forward from the snapshot to the chosen time step.

For example, assume a snapshot save frequency of three and a step size of one. The stepper first steps back to the last saved step, up to three steps, and then simulates forward until the total step count difference reaches one. If you change tunable parameters before stepping back, the resulting simulation output might not match the previous simulation output at that step.

### Referenced Models

When using Simulation Stepper and the Model block, the referenced model shares the stepping options of the top model throughout a simulation. As a result, changing Simulation Stepper settings for the referenced model during simulation changes the Simulation Stepper settings of the top model. When the simulation ends, the settings of the referenced model revert to the original values; the Stepper settings of the top model stay at the changed settings.

- When the model is not simulating, the top model and referenced model retain their own independent stepping options.
- When the model is simulating and you change a referenced model stepping option, the top model stepping option changes to the same value.
- When the model is simulating and you change a top model stepping option, the referenced model stepping option changes to the same value.
- When the model stops simulating, the referenced model stepping options revert to how they were set before simulation started; the top model keeps the values set during simulation.

### Simulation Stepper and Interval Logging

When you change the logging interval of a simulation before rolling back, Simulink does not log data for time steps that were outside the original logging interval until the first forward step after a rollback operation. For more information, see “Logging intervals”.

### Simulation Stepper and Stateflow Debugger

When you debug a Stateflow chart (for example, when the simulation stops at a Stateflow breakpoint), Simulation Stepper adds buttons to control the Stateflow debugging session. When the Stateflow debugging session ends, the Simulation Stepper interface returns to the default. For more information about controlling the Stateflow debugger using the Simulink Editor toolbar, see “Control Chart Execution from the Stateflow Editor” (Stateflow).

## **Related Examples**

- “Step Through a Simulation” on page 2-15
- “Set Conditional Breakpoints for Stepping a Simulation” on page 2-18

## **More About**

- “How Stepping Through a Simulation Works” on page 2-3
- “Simulation Stepping Options”
- “Simulation Stepper Limitations” on page 2-12

# Simulation Stepper Limitations

In this section...
“Interface” on page 2-12
“Model Configuration” on page 2-12
“Blocks” on page 2-12

## Interface

- There is no command-line interface for Simulation Stepper.

## Model Configuration

- Simulation stepping (forward and backward) is available only for Normal and Accelerator modes.
- The step back capability relies on SimState technology for saving and restoring the state of a simulation. As a result, the step back capability is available only for models that support SimState. For more information, see “Save and Restore Simulation State as SimState” on page 23-37.
- Simulation Stepper steps through the major time steps of a simulation without changing the course of a simulation. Choosing a refine factor greater than unity produces loggable outputs at times between the major time steps of the solver. These times are not major time steps, and you cannot step to a model state at those times.
- If you run a simulation with stepping back enabled, the Simulink software checks whether the model can step back. If it cannot, a warning appears at the MATLAB command prompt. For some simulations, Simulink cannot step back. The step back capability is then disabled until the end of that simulation. Then the setting resets to the value you requested.
- When you place custom code in **Configuration Parameters > Simulation Target > Custom Code > Initialize function** in the **Model Configuration Parameters** dialog box, this gets called only during the first simulation in Simulation Stepper.

## Blocks

- Some blocks do not support stepping back for reasons other than SimState support. These blocks are:

- S-functions that have P-work vectors but do not declare their SimState compliance level or declare it to be unknown or disallowed (see “S-Function Compliance with the SimState”)
- Simscape™ Multibody™ First Generation blocks
- Model blocks configured for Accelerator mode
- Legacy (pre-R2016a) SimEvents® blocks
- MATLAB Function blocks generally support stepping back. However, the use of certain constructs in the MATLAB code of these blocks can prevent the block from supporting stepping back. These scenarios prevent the MATLAB Function blocks from stepping back:
  - Persistent variables of opaque data type. Attempts to step back under this condition cause an error message based on the specific variable type.
  - Extrinsic functions calls that can contain state (such as properties of objects or persistent data of functions). No warnings or error messages appear, but the result likely will be incorrect.
  - Calls to custom C code (through MEX function calls) that do not contain static variables. No warnings or error messages appear, but the result likely will be incorrect.
- Some visualization blocks do not support stepping back. Because these blocks are not critical to the state of the simulation, no errors or warnings appear when you step back in a model that contains these blocks:
  - XY Graph
  - Auto Correlator
  - Cross Correlator
  - Spectrum Analyzer
  - Averaging Spectrum Analyzer
  - Power Spectral Density
  - Averaging Power Spectral Density
  - Floating Bar Plot
  - 3Dof Animation
  - MATLAB Animation

- VR Sink
- Any blocks that implement custom visualization in their output method (for example, an S-function that outputs to a MATLAB figure) are not fully supported for stepping back because the block method `Output` does not execute while stepping back. While the state of such blocks remains consistent with the simulation time (if the blocks comply with `SimState`), the visualization component is inconsistent until the next step forward in the simulation.

Because these blocks do not affect the numerical result of a simulation, stepping back is not disabled for these blocks. However, the values these blocks output are inaccurate until the simulation steps forward again.

### Related Examples

- “Step Through a Simulation” on page 2-15



### More About

- “How Simulation Stepper Helps With Model Analysis” on page 2-2

# Step Through a Simulation

## Step Forward and Back

This example shows how to step forward and back through a simulation.

- 1 At the MATLAB prompt, type  
`vdp`
- 2 In the Simulink Editor for the `vdp` model, click  to open the Simulation Stepping Options dialog box.
- 3 In the dialog box, select the **Enable stepping back** check box, and then click **OK**.
- 4 In the Simulation toolbar, click the **Step Forward** button  one time.

The simulation simulates one step, and the software stores a simulation snapshot for that step.

- 5 Click the Step Forward button again to step forward again and store simulation data. A total of 25 forward steps produces these simulation results:

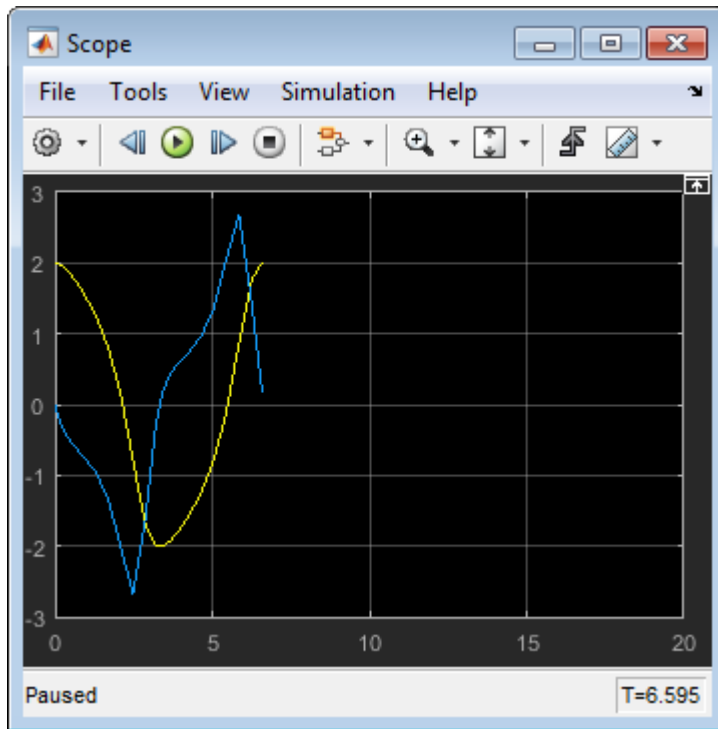

- 6 You must step forward to create the simulation state that the step backward operation requires. This means you must first step forward before you can step backward through the same steps.

In the Simulation toolbar, click the **Step Back** button  four times to step backward to the simulation snapshot shown below.



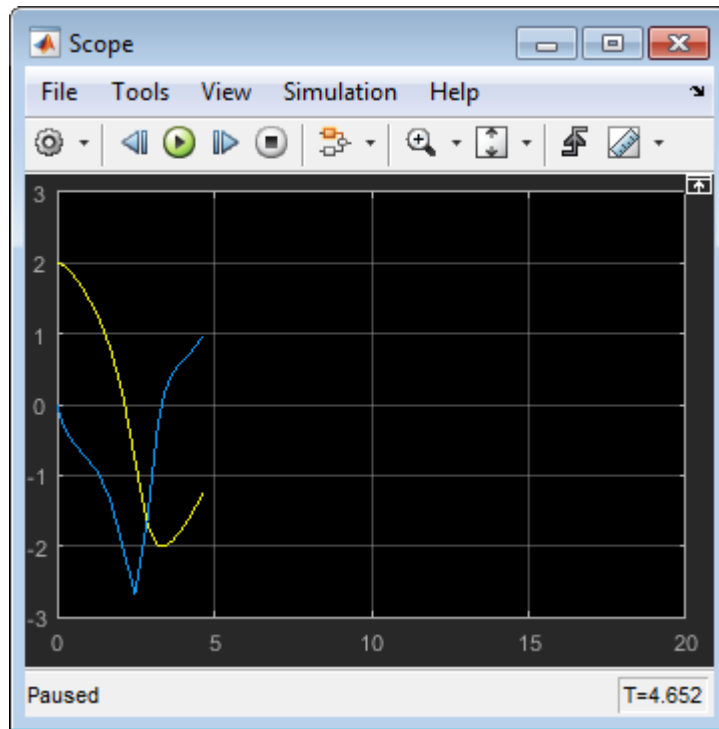

## Related Examples

- “Set Conditional Breakpoints for Stepping a Simulation” on page 2-18

## More About





- “How Simulation Stepper Helps With Model Analysis” on page 2-2
- “How Stepping Through a Simulation Works” on page 2-3

# Set Conditional Breakpoints for Stepping a Simulation

A conditional breakpoint is triggered based on a specified expression evaluated on a signal. When the breakpoint is triggered, the simulation pauses.

Set conditional breakpoints to stop Simulation Stepper when a specified condition is met. One example of a use for conditional breakpoints is when you want to examine results after a certain number of iterations in a loop.

Simulation Stepper allows you to set conditional breakpoints for scalar signals. These breakpoints appear for signals:

Breakpoint	Description
	Enabled breakpoint. Appears when you add the conditional breakpoint.
	Enabled breakpoint hit. Appears when the simulation reaches the condition specified and triggers the breakpoint.
	Disabled breakpoint. Appears when you disable a conditional breakpoint.
	Invalid breakpoint. Appears when the software determines that a breakpoint is invalid for the signal. An enabled breakpoint image changes to this one when, during simulation, the software determines that the conditional breakpoint is invalid.

When setting conditional breakpoints, keep in mind that:

- When simulation arrives at a conditional breakpoint, simulation does not stop when the block is executed. Instead, simulation stops after the current simulation step completes.
- You can add multiple conditional breakpoints to a signal line.

## Add and Edit Conditional Breakpoints

- 1 In a model, right-click a signal and select **Add Conditional Breakpoint**.
- 2 In the **Add Conditional Breakpoint** dialog box, from the drop-down list, select the condition for the signal. For example, select greater than or less than.
- 3 Enter the signal value where you want simulation to pause and click **OK**. For the condition values:
  - Use numeric values. Do not use expressions.

- Do not use NaN.

The affected signal line displays a conditional breakpoint icon: .

- 4 Click the breakpoint to view and edit all conditions set for the signal.

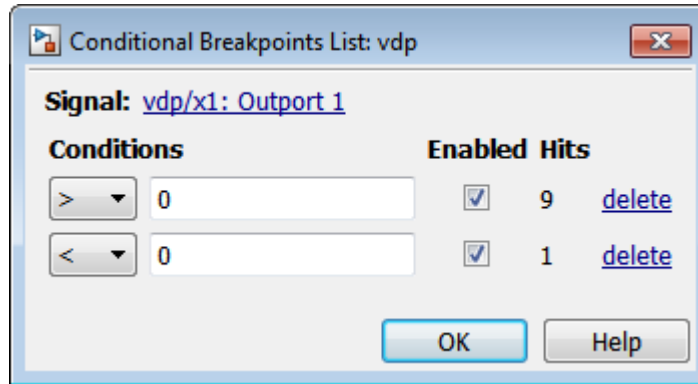

- 5 Simulate the model and notice that the model pauses as simulation steps through the conditional breakpoints.

### Conditional Breakpoints Limitations

- You can set conditional breakpoints only on real scalar signals of these data types:
  - double
  - single
  - int
  - bool
  - fixed point (based on the converted double value)
- You cannot set conditional breakpoints (or port value display labels) on non-Simulink signals, such as Simscape or SimEvents signals.
- Conditional breakpoints also have the limitations that port value display have (“Port Value Display Limitations” on page 34-24).

### Observe Conditional Breakpoint Values

To observe a conditional breakpoint value of a block signal, use data tips to display block port values. You can add data tips before or after you add conditional breakpoints.

- 1 Enable the value display for a signal. Right-click the signal line that has a conditional breakpoint and select **Show Value Label of Selected Port**.

The data tip for the value display appears.

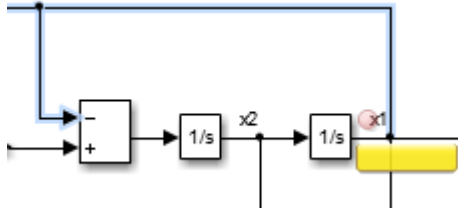

- 2 Simulate the model and observe the conditional breakpoint and data tip when the simulation triggers the breakpoint.

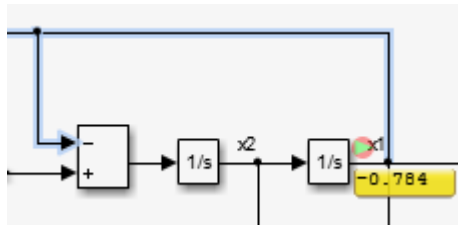

### Related Examples

- “Step Through a Simulation” on page 2-15

### More About

- “How Stepping Through a Simulation Works” on page 2-3

# How Simulink Works

---

- “How Simulink Works” on page 3-2
- “Modeling Dynamic Systems” on page 3-3
- “Simulation Phases in Dynamic Systems” on page 3-17
- “Solvers” on page 3-21
- “Zero-Crossing Detection” on page 3-24
- “Algebraic Loops” on page 3-38

# How Simulink Works

Simulink is a software package that enables you to model, simulate, and analyze systems whose outputs change over time. Such systems are often referred to as dynamic systems. The Simulink software can be used to explore the behavior of a wide range of real-world dynamic systems, including electrical circuits, shock absorbers, braking systems, and many other electrical, mechanical, and thermodynamic systems. This section explains how Simulink works.

Simulating a dynamic system is a two-step process. First, a user creates a block diagram, using the Simulink model editor, that graphically depicts time-dependent mathematical relationships among the system's inputs, states, and outputs. The user then commands the Simulink software to simulate the system represented by the model from a specified start time to a specified stop time.

### More About

- “Modeling Dynamic Systems” on page 3-3
- “Parts of a Model” on page 1-54
- “Simulation Phases in Dynamic Systems” on page 3-17
- “Solvers” on page 3-21

# Modeling Dynamic Systems

**In this section...**

“Block Diagram Semantics” on page 3-3

“Creating Models” on page 3-4

“Time” on page 3-4

“States” on page 3-5

“Block Parameters” on page 3-8

“Tunable Parameters” on page 3-8

“Block Sample Times” on page 3-9

“Custom Blocks” on page 3-9

“Systems and Subsystems” on page 3-10

“Signals” on page 3-14

“Block Methods” on page 3-15

“Model Methods” on page 3-16

## Block Diagram Semantics

A classic block diagram model of a dynamic system graphically consists of blocks and lines (signals). The history of these block diagram models is derived from engineering areas such as Feedback Control Theory and Signal Processing. A block within a block diagram defines a dynamic system in itself. The relationships between each elementary dynamic system in a block diagram are illustrated by the use of signals connecting the blocks. Collectively the blocks and lines in a block diagram describe an overall dynamic system.

The Simulink product extends these classic block diagram models by introducing the notion of two classes of blocks, nonvirtual blocks and virtual blocks. Nonvirtual blocks represent elementary systems. Virtual blocks exist for graphical and organizational convenience only: they have no effect on the system of equations described by the block diagram model. You can use virtual blocks to improve the readability of your models.

In general, blocks and lines can be used to describe many “models of computations.” One example would be a flow chart. A flow chart consists of blocks and lines, but one cannot describe general dynamic systems using flow chart semantics.

The term “time-based block diagram” is used to distinguish block diagrams that describe dynamic systems from that of other forms of block diagrams, and the term block diagram (or model) is used to refer to a time-based block diagram unless the context requires explicit distinction.

To summarize the meaning of time-based block diagrams:

- Simulink block diagrams define time-based relationships between signals and state variables. The solution of a block diagram is obtained by evaluating these relationships over time, where time starts at a user specified “start time” and ends at a user specified “stop time.” Each evaluation of these relationships is referred to as a time step.
- Signals represent quantities that change over time and are defined for all points in time between the block diagram's start and stop time.
- The relationships between signals and state variables are defined by a set of equations represented by blocks. Each block consists of a set of equations (block methods). These equations define a relationship between the input signals, output signals and the state variables. Inherent in the definition of an equation is the notion of parameters, which are the coefficients found within the equation.

## Creating Models

The Simulink product provides a graphical editor that allows you to create and connect instances of block types selected from libraries of block types (see “Block Libraries”) via a library browser. Libraries of blocks are provided representing elementary systems that can be used as building blocks. The blocks supplied with Simulink are called built-in blocks. Users can also create their own block types and use the Simulink editor to create instances of them in a diagram. User-defined blocks are called custom blocks.

## Time

Time is an inherent component of block diagrams in that the results of a block diagram simulation change with time. Put another way, a block diagram represents the instantaneous behavior of a dynamic system. Determining a system's behavior over time thus entails repeatedly solving the model at intervals, called time steps, from the start of the time span to the end of the time span. The process of solving a model at successive time steps is referred to as *simulating* the system that the model represents.



## States

Typically the current values of some system, and hence model, outputs are functions of the previous values of temporal variables. Such variables are called states. Computing a model's outputs from a block diagram hence entails saving the value of states at the current time step for use in computing the outputs at a subsequent time step. This task is performed during simulation for models that define states.

Two types of states can occur in a Simulink model: discrete and continuous states. A continuous state changes continuously. Examples of continuous states are the position and speed of a car. A discrete state is an approximation of a continuous state where the state is updated (recomputed) using finite (periodic or aperiodic) intervals. An example of a discrete state would be the position of a car shown on a digital odometer where it is updated every second as opposed to continuously. In the limit, as the discrete state time interval approaches zero, a discrete state becomes equivalent to a continuous state.

Blocks implicitly define a model's states. In particular, a block that needs some or all of its previous outputs to compute its current outputs implicitly defines a set of states that need to be saved between time steps. Such a block is said to have states.

The following is a graphical representation of a block that has states:

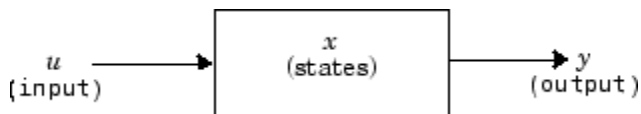

Blocks that define continuous states include the following standard Simulink blocks:

- Integrator
- State-Space
- Transfer Fcn
- Variable Transport Delay
- Zero-Pole

The total number of a model's states is the sum of all the states defined by all its blocks. Determining the number of states in a diagram requires parsing the diagram to determine the types of blocks that it contains and then aggregating the number of states defined by each instance of a block type that defines states. This task is performed during the Compilation phase of a simulation.

### Working with States

The following facilities are provided for determining, initializing, and logging a model's states during simulation:

- The `model` command displays information about the states defined by a model, including the total number of states defined by the model, the block that defines each state, and the initial value of each state.
- The Simulink debugger displays the value of a state at each time step during a simulation, and the Simulink debugger's `states` command displays information about the model's current states (see “Simulink Debugger”).
- The **Data Import/Export** pane of a model's Configuration Parameters dialog box (see “State Information” on page 59-261) allows you to specify initial values for a model's states, and to record the values of the states at each time step during simulation as an array or structure variable in the MATLAB workspace.
- The Block Parameters dialog box (and the `ContinuousStateAttributes` parameter) allows you to give names to states for those blocks (such as the Integrator) that employ continuous states. This can simplify analyzing data logged for states, especially when a block has multiple states.

The Two Cylinder Model with Load Constraints model illustrates the logging of continuous states.

### Continuous States

Computing a continuous state entails knowing its rate of change, or derivative. Since the rate of change of a continuous state typically itself changes continuously (i.e., is itself a state), computing the value of a continuous state at the current time step entails integration of its derivative from the start of a simulation. Thus modeling a continuous state entails representing the operation of integration and the process of computing the state's derivative at each point in time. Simulink block diagrams use Integrator blocks to indicate integration and a chain of blocks connected to an integrator block's input to represent the method for computing the state's derivative. The chain of blocks connected to the integrator block's input is the graphical counterpart to an ordinary differential equation (ODE).

In general, excluding simple dynamic systems, analytical methods do not exist for integrating the states of real-world dynamic systems represented by ordinary differential equations. Integrating the states requires the use of numerical methods called ODE solvers. These various methods trade computational accuracy for computational workload. The Simulink product comes with computerized implementations of the most

common ODE integration methods and allows a user to determine which it uses to integrate states represented by Integrator blocks when simulating a system.

Computing the value of a continuous state at the current time step entails integrating its values from the start of the simulation. The accuracy of numerical integration in turn depends on the size of the intervals between time steps. In general, the smaller the time step, the more accurate the simulation. Some ODE solvers, called variable time step solvers, can automatically vary the size of the time step, based on the rate of change of the state, to achieve a specified level of accuracy over the course of a simulation. The user can specify the size of the time step in the case of fixed-step solvers, or the solver can automatically determine the step size in the case of variable-step solvers. To minimize the computation workload, the variable-step solver chooses the largest step size consistent with achieving an overall level of precision specified by the user for the most rapidly changing model state. This ensures that all model states are computed to the accuracy specified by the user.

### **Discrete States**

Computing a discrete state requires knowing the relationship between its value at the current time step and its value at the previous time step. This is referred to this relationship as the state's update function. A discrete state depends not only on its value at the previous time step but also on the values of a model's inputs. Modeling a discrete state thus entails modeling the state's dependency on the systems' inputs at the previous time step. Simulink block diagrams use specific types of blocks, called discrete blocks, to specify update functions and chains of blocks connected to the inputs of discrete blocks to model the dependency of a system's discrete states on its inputs.

As with continuous states, discrete states set a constraint on the simulation time step size. Specifically, the step size must ensure that all the sample times of the model's states are hit. This task is assigned to a component of the Simulink system called a discrete solver. Two discrete solvers are provided: a fixed-step discrete solver and a variable-step discrete solver. The fixed-step discrete solver determines a fixed step size that hits all the sample times of all the model's discrete states, regardless of whether the states actually change value at the sample time hits. By contrast, the variable-step discrete solver varies the step size to ensure that sample time hits occur only at times when the states change value.

### **Modeling Hybrid Systems**

A hybrid system is a system that has both discrete and continuous states. Strictly speaking, any model that has both continuous and discrete sample times is treated as a

hybrid model, presuming that the model has both continuous and discrete states. Solving such a model entails choosing a step size that satisfies both the precision constraint on the continuous state integration and the sample time hit constraint on the discrete states. The Simulink software meets this requirement by passing the next sample time hit, as determined by the discrete solver, as an additional constraint on the continuous solver. The continuous solver must choose a step size that advances the simulation up to but not beyond the time of the next sample time hit. The continuous solver can take a time step short of the next sample time hit to meet its accuracy constraint but it cannot take a step beyond the next sample time hit even if its accuracy constraint allows it to.

You can simulate hybrid systems using any one of the integration methods, but certain methods are more effective than others. For most hybrid systems, `ode23` and `ode45` are superior to the other solvers in terms of efficiency. Because of discontinuities associated with the sample and hold of the discrete blocks, do not use the `ode15s` and `ode113` solvers for hybrid systems.

### Block Parameters

Key properties of many standard blocks are parameterized. For example, the Constant value of the Simulink Constant block is a parameter. Each parameterized block has a block dialog that lets you set the values of the parameters. You can use MATLAB expressions to specify parameter values. Simulink evaluates the expressions before running a simulation. You can change the values of parameters during a simulation. This allows you to determine interactively the most suitable value for a parameter.

A parameterized block effectively represents a family of similar blocks. For example, when creating a model, you can set the Constant value parameter of each instance of the Constant block separately so that each instance behaves differently. Because it allows each standard block to represent a family of blocks, block parameterization greatly increases the modeling power of the standard Simulink libraries. See “Block Parameters” on page 3-8 and “Block Libraries” for more information.

### Tunable Parameters

Many block parameters are tunable. A *tunable parameter* is a parameter whose value can be changed without recompiling the model (see “Model Compilation” on page 3-17 for more information on compiling a model). For example, the gain parameter of the Gain block is tunable. You can alter the block's gain while a simulation is running. If a parameter is not tunable and the simulation is running, the dialog box control that sets the parameter is disabled.

When you change the value of a tunable parameter, the change takes effect at the start of the next time step. See “Block Parameters” on page 3-8 and “Tune and Experiment with Block Parameter Values” on page 35-38 for more information.

## Block Sample Times

Every Simulink block has a sample time which defines when the block will execute. Most blocks allow you to specify the sample time via a `SampleTime` parameter. Common choices include discrete, continuous, and inherited sample times.

Common Sample Time Types	Sample Time	Examples
Discrete	$[T_s, T_o]$	Unit Delay, Digital Filter
Continuous	$[0, 0]$	Integrator, Derivative
Inherited	$[-1, 0]$	Gain, Sum

For discrete blocks, the sample time is a vector  $[T_s, T_o]$  where  $T_s$  is the time interval or period between consecutive sample times and  $T_o$  is an initial offset to the sample time. In contrast, the sample times for nondiscrete blocks are represented by ordered pairs that use zero, a negative integer, or infinity to represent a specific type of sample time (see “View Sample Time Information” on page 7-9). For example, continuous blocks have a nominal sample time of  $[0, 0]$  and are used to model systems in which the states change continuously (e.g., a car accelerating). Whereas you indicate the sample time type of an inherited block symbolically as  $[-1, 0]$  and Simulink then determines the actual value based upon the context of the inherited block within the model.

Note that not all blocks accept all types of sample times. For example, a discrete block cannot accept a continuous sample time.

For a visual aid, Simulink allows the optional color-coding and annotation of any block diagram to indicate the type and speed of the block sample times. You can capture all of the colors and the annotations within a legend (see “View Sample Time Information” on page 7-9).

For a more detailed discussion of sample times, see “Sample Time”

## Custom Blocks

You can create libraries of custom blocks that you can then use in your models. You can create a custom block either graphically or programmatically. To create a custom block graphically, you draw a block diagram representing the block's behavior, wrap

this diagram in an instance of the Simulink Subsystem block, and provide the block with a parameter dialog, using the Simulink block mask facility. To create a block programmatically, you create a MATLAB file or a MEX-file that contains the block's system functions (see “S-Function Basics”). The resulting file is called an S-function. You then associate the S-function with instances of the Simulink S-Function block in your model. You can add a parameter dialog to your S-Function block by wrapping it in a Subsystem block and adding the parameter dialog to the Subsystem block. See “Block Creation” for more information.

### Systems and Subsystems

A Simulink block diagram can consist of layers. Each layer is defined by a subsystem. A subsystem is part of the overall block diagram and ideally has no impact on the meaning of the block diagram. Subsystems are provided primarily to help with the organizational aspects of a block diagram. Subsystems do not define a separate block diagram.

The Simulink software differentiates between two different types of subsystems: virtual and nonvirtual. The primary difference is that nonvirtual subsystems provide the ability to control when the contents of the subsystem are evaluated.

#### Virtual Subsystems

Virtual subsystems provide graphical hierarchy in models. Virtual subsystems do not impact execution. During model execution, the Simulink engine flattens all virtual subsystems, i.e., Simulink expands the subsystem in place before execution. This expansion is very similar to the way macros work in a programming language such as C or C++. Roughly speaking, there will be one system for the top-level block diagram which is referred to as the root system, and several lower-level systems derived from nonvirtual subsystems and other elements in the block diagram. You will see these systems in the Simulink Debugger. The act of creating these internal systems is often referred to as *flattening the model hierarchy*.

#### Nonvirtual Subsystems

Nonvirtual subsystems, which are drawn with a bold border, provide execution and graphical hierarchy in models. Nonvirtual subsystems are executed as a single unit (atomic execution) by the Simulink engine. You can create conditionally executed subsystems that are executed only when a precondition—such as a trigger, an enable, a function-call, or an action—occurs (see “Conditionally Executed Subsystems”). Simulink always computes all inputs used during the execution of a nonvirtual subsystem before executing the subsystem. Simulink defines the following nonvirtual subsystems.

### Atomic subsystems

The primary characteristic of an atomic subsystem is that blocks in an atomic subsystem execute as a single unit. This provides the advantage of grouping functional aspects of models at the execution level. Any Simulink block can be placed in an atomic subsystem, including blocks with different execution rates. You can create an atomic subsystem by selecting the **Treat as atomic unit** option on a virtual subsystem (see the Atomic Subsystem block for more information).

### Enabled subsystems

An enabled subsystem behaves similarly to an atomic subsystem, except that it executes only when the signal driving the subsystem enable port is greater than zero. To create an enabled subsystem, place an Enable Port block within a Subsystem block. You can configure an enabled subsystem to hold or reset the states of blocks within the enabled subsystem prior to a subsystem enabling action. Simply select the **States when enabling** parameter of the Enable Port block. Similarly, you can configure each output port of an enabled subsystem to hold or reset its output prior to the subsystem disabling action. Select the **Output when disabled** parameter in the Output block.

### Triggered subsystems

You create a triggered subsystem by placing a trigger port block within a subsystem. The resulting subsystem executes when a rising or falling edge with respect to zero is seen on the signal driving the subsystem trigger port. The direction of the triggering edge is defined by the **Trigger type** parameter on the trigger port block. Simulink limits the type of blocks placed in a triggered subsystem to blocks that do not have explicit sample times (i.e., blocks within the subsystem must have a sample time of -1) because the contents of a triggered subsystem execute in an aperiodic fashion. A Stateflow chart can also have a trigger port which is defined by using the Stateflow editor. Simulink does not distinguish between a triggered subsystem and a triggered chart.

### Function-call subsystems

A function-call subsystem is a subsystem that another block can invoke directly during a simulation. It is analogous to a function in a procedural programming language. Invoking a function-call subsystem is equivalent to invoking the output and update methods of the blocks that the subsystem contains in sorted order. The block that invokes a function-call subsystem is called the function-call initiator. Stateflow, Function-Call Generator, and S-function blocks can all serve as function-call initiators. To create a function-call subsystem, drag a Function-Call Subsystem block from the Ports & Subsystems library into your model and connect a function-call initiator to the function-call port displayed on top of the subsystem. You can also create a function-call subsystem from scratch by

first creating a Subsystem block in your model and then creating a Trigger block in the subsystem and setting the Trigger block `Trigger type` to `function-call`.

You can configure a function-call subsystem to be triggered (the default) or periodic by setting its `Sample time type` to be `triggered` or `periodic`, respectively. A function-call initiator can invoke a triggered function-call subsystem zero, once, or multiple times per time step. The sample times of all the blocks in a triggered function-call subsystem must be set to `inherited (-1)`.

A function-call initiator can invoke a periodic function-call subsystem only once per time step and must invoke the subsystem periodically. If the initiator invokes a periodic function-call subsystem aperiodically, Simulink halts the simulation and displays an error message. The blocks in a periodic function-call subsystem can specify a noninherited sample time or `inherited (-1)` sample time. All blocks that specify a noninherited sample time must specify the same sample time, that is, if one block specifies `.1` as its sample time, all other blocks must specify a sample time of `.1` or `-1`. If a function-call initiator invokes a periodic function-call subsystem at a rate that differs from the sample time specified by the blocks in the subsystem, Simulink halts the simulation and displays an error message.

### **Enabled and triggered subsystems**

You can create an enabled and triggered subsystem by placing a Trigger Port block and an Enable Port block within a Subsystem block. The resulting subsystem is essentially a triggered subsystem that executes when the subsystem is enabled and a rising or falling edge with respect to zero is seen on the signal driving the subsystem trigger port. The direction of the triggering edge is defined by the `Trigger type` parameter on the trigger port block. Because the contents of a triggered subsystem execute in an aperiodic fashion, Simulink limits the types of blocks placed in an enabled and triggered subsystem to blocks that do not have explicit sample times. In other words, blocks within the subsystem must have a sample time of `-1`.

### **Resettable subsystems**

A resettable subsystem computes its outputs at every sample time hit but also resets the states of the subsystem on triggering. The resettable subsystem resets the states of all blocks within it, triggered by a rising or falling edge with respect to zero. On triggering, the resettable subsystem resets its states and also computes the outputs.

The resettable subsystem supports only single sample time for all the blocks it contains. Different sample times for different blocks within the subsystem result in an error. For more information, see [Resettable Subsystem](#).



### Action subsystems

Action subsystems can be thought of as an intersection of the properties of enabled subsystems and function-call subsystems. Action subsystems are restricted to a single sample time (e.g., a continuous, discrete, or inherited sample time). Action subsystems must be executed by an action subsystem initiator. This is either an If block or a Switch Case block. All action subsystems connected to a given action subsystem initiator must have the same sample time. An action subsystem is created by placing an Action Port block within a Subsystem block. The subsystem icon will automatically adapt to the type of block (i.e., If or Switch Case block) that is executing the action subsystem.

Action subsystems can be executed at most once by the action subsystem initiator. Action subsystems give you control over when the states reset via the **States when execution is resumed** parameter on the Action Port block. Action subsystems also give you control over whether or not to hold the output values via the **Output when disabled** parameter on the output block. This is analogous to enabled subsystems.

Action subsystems behave very similarly to function-call subsystems because they must be executed by an initiator block. *Function-call subsystems can be executed more than once at any given time step whereas action subsystems can be executed at most once.* This restriction means that a larger set of blocks (e.g., periodic blocks) can be placed in action subsystems as compared to function-call subsystems. This restriction also means that you can control how the states and outputs behave.

### While iterator subsystems

A while iterator subsystem will run multiple iterations on each model time step. The number of iterations is controlled by the While Iterator block condition. A while iterator subsystem is created by placing a While Iterator block within a subsystem block.

A while iterator subsystem is very similar to a function-call subsystem in that it can run for any number of iterations at a given time step. The while iterator subsystem differs from a function-call subsystem in that there is no separate initiator (e.g., a Stateflow Chart). In addition, a while iterator subsystem has access to the current iteration number optionally produced by the While Iterator block. A while iterator subsystem also gives you control over whether or not to reset states when starting via the **States when starting** parameter on the While Iterator block.

### For iterator subsystems

A for iterator subsystem will run a fixed number of iterations at each model time step. The number of iterations can be an external input to the for iterator subsystem or

specified internally on the For Iterator block. A for iterator subsystem is created by placing a For Iterator block within a subsystem block.

A for iterator subsystem has access to the current iteration number that is optionally produced by the For Iterator block. A for iterator subsystem also gives you control over whether or not to reset states when starting via the **States when starting** parameter on the For Iterator block. A for iterator subsystem is very similar to a while iterator subsystem with the restriction that the number of iterations during any given time step is fixed.

### **For each subsystems**

The for each subsystem allows you to repeat an algorithm for individual elements (or subarrays) of an input signal. Here, the algorithm is represented by the set of blocks in the subsystem and is applied to a single element (or subarray) of the signal. You can configure the decomposition of the subsystem inputs into elements (or subarrays) using the For Each block, which resides in the subsystem. The For Each block also allows you to configure the concatenation of individual results into output signals. An advantage of this subsystem is that it maintains separate sets of states for each element or subarray that it processes. In addition, for certain models, the for each subsystem improves the code reuse of the code generated by Simulink Coder™.

## **Signals**

The term *signal* refers to a time varying quantity that has values at all points in time. You can specify a wide range of signal attributes, including signal name, data type (e.g., 8-bit, 16-bit, or 32-bit integer), numeric type (real or complex), and dimensionality (one-dimensional, two-dimensional, or multidimensional array). Many blocks can accept or output signals of any data or numeric type and dimensionality. Others impose restrictions on the attributes of the signals they can handle.

On the block diagram, signals are represented with lines that have an arrowhead. The source of the signal corresponds to the block that writes to the signal during evaluation of its block methods (equations). The destinations of the signal are blocks that read the signal during the evaluation of the block's methods (equations).

A good way to understand the definition of a signal is to consider a classroom. The teacher is the one responsible for writing on the white board and the students read what is written on the white board when they choose to. This is also true of Simulink signals: a reader of the signal (a block method) can choose to read the signal as frequently or infrequently as so desired.

For more information about signals, see “Signals”.

## Block Methods

Blocks represent multiple equations. These equations are represented as block methods. These block methods are evaluated (executed) during the execution of a block diagram. The evaluation of these block methods is performed within a simulation loop, where each cycle through the simulation loop represents the evaluation of the block diagram at a given point in time.

### Method Types

Names are assigned to the types of functions performed by block methods. Common method types include:

- Outputs

Computes the outputs of a block given its inputs at the current time step and its states at the previous time step.

- Update

Computes the value of the block's discrete states at the current time step, given its inputs at the current time step and its discrete states at the previous time step.

- Derivatives

Computes the derivatives of the block's continuous states at the current time step, given the block's inputs and the values of the states at the previous time step.

### Method Naming Convention

Block methods perform the same types of operations in different ways for different types of blocks. The Simulink user interface and documentation uses dot notation to indicate the specific function performed by a block method:

`BlockType.MethodType`

For example, the method that computes the outputs of a Gain block is referred to as

`Gain.Outputs`

The Simulink debugger takes the naming convention one step further and uses the instance name of a block to specify both the method type and the block instance on which the method is being invoked during simulation, e.g.,

g1.Outputs

### Model Methods

In addition to block methods, a set of methods is provided that compute the model properties and its outputs. The Simulink software similarly invokes these methods during simulation to determine a model's properties and its outputs. The model methods generally perform their tasks by invoking block methods of the same type. For example, the model Outputs method invokes the Outputs methods of the blocks that it contains in the order specified by the model to compute its outputs. The model Derivatives method similarly invokes the Derivatives methods of the blocks that it contains to determine the derivatives of its states.

### See Also

Model | Subsystem

### Related Examples

- “Model a Continuous System” on page 15-8
- “Create a Subsystem” on page 4-18
- “Create a Referenced Model” on page 8-9

### More About

- “Parts of a Model” on page 1-54
- “Simulation Phases in Dynamic Systems” on page 3-17
- “Solvers” on page 3-21
- “What Is Sample Time?” on page 7-2

# Simulation Phases in Dynamic Systems

**In this section...**

“Model Compilation” on page 3-17

“Link Phase” on page 3-18

“Simulation Loop Phase” on page 3-18

## Model Compilation

The first phase of simulation occurs when the system’s model is open and you simulate the model. In the Simulink Editor, select **Simulation > Run**. Running the simulation causes the Simulink engine to invoke the model compiler. The model compiler converts the model to an executable form, a process called compilation. In particular, the compiler:

- Evaluates the model's block parameter expressions to determine their values.
- Determines signal attributes, e.g., name, data type, numeric type, and dimensionality, not explicitly specified by the model and checks that each block can accept the signals connected to its inputs.
- A process called attribute propagation is used to determine unspecified attributes. This process entails propagating the attributes of a source signal to the inputs of the blocks that it drives.
- Performs block reduction optimizations.
- Flattens the model hierarchy by replacing virtual subsystems with the blocks that they contain (see “Solvers” on page 3-21).
- Determines the block sorted order (see “Control and Display the Sorted Order” on page 34-27 for more information).
- Determines the sample times of all blocks in the model whose sample times you did not explicitly specify (see “How Propagation Affects Inherited Sample Times” on page 7-38).

These events are essentially the same as what occurs when you update a diagram (“Update Diagram and Run Simulation” on page 1-65). The difference is that the Simulink software starts model compilation as part of model simulation, where compilation leads directly into the linking phase, as described in “Link Phase” on page 3-18. In contrast, you start an explicit model update as a standalone operation on a model.

### Link Phase

In this phase, the Simulink engine allocates memory needed for working areas (signals, states, and run-time parameters) for execution of the block diagram. It also allocates and initializes memory for data structures that store run-time information for each block. For built-in blocks, the principal run-time data structure for a block is called the SimBlock. It stores pointers to a block's input and output buffers and state and work vectors.

#### Method Execution Lists

In the Link phase, the Simulink engine also creates method execution lists. These lists list the most efficient order in which to invoke a model's block methods to compute its outputs. The block sorted order lists generated during the model compilation phase is used to construct the method execution lists.

#### Block Priorities

You can assign update priorities to blocks (see “Assign Block Priorities” on page 34-41). The output methods of higher priority blocks are executed before those of lower priority blocks. The priorities are honored only if they are consistent with its block sorting rules.

### Simulation Loop Phase

Once the Link Phase completes, the simulation enters the simulation loop phase. In this phase, the Simulink engine successively computes the states and outputs of the system at intervals from the simulation start time to the finish time, using information provided by the model. The successive time points at which the states and outputs are computed are called time steps. The length of time between steps is called the step size. The step size depends on the type of solver (see “Solvers” on page 3-21) used to compute the system's continuous states, the system's fundamental sample time (see “Sample Times in Systems” on page 7-28), and whether the system's continuous states have discontinuities (see “Zero-Crossing Detection” on page 3-24).

The Simulation Loop phase has two subphases: the Loop Initialization phase and the Loop Iteration phase. The initialization phase occurs once, at the start of the loop. The iteration phase is repeated once per time step from the simulation start time to the simulation stop time.

At the start of the simulation, the model specifies the initial states and outputs of the system to be simulated. At each step, new values for the system's inputs, states, and

outputs are computed, and the model is updated to reflect the computed values. At the end of the simulation, the model reflects the final values of the system's inputs, states, and outputs. The Simulink software provides data display and logging blocks. You can display and/or log intermediate results by including these blocks in your model.

### **Loop Iteration**

At each time step, the Simulink engine:

- 1** Computes the model's outputs.

The Simulink engine initiates this step by invoking the Simulink model Outputs method. The model Outputs method in turn invokes the model system Outputs method, which invokes the Outputs methods of the blocks that the model contains in the order specified by the Outputs method execution lists generated in the Link phase of the simulation (see “Solvers” on page 3-21).

The system Outputs method passes the following arguments to each block Outputs method: a pointer to the block's data structure and to its SimBlock structure. The SimBlock data structures point to information that the Outputs method needs to compute the block's outputs, including the location of its input buffers and its output buffers.

- 2** Computes the model's states.

The Simulink engine computes a model's states by invoking a solver. Which solver it invokes depends on whether the model has no states, only discrete states, only continuous states, or both continuous and discrete states.

If the model has only discrete states, the Simulink engine invokes the discrete solver selected by the user. The solver computes the size of the time step needed to hit the model's sample times. It then invokes the Update method of the model. The model Update method invokes the Update method of its system, which invokes the Update methods of each of the blocks that the system contains in the order specified by the Update method lists generated in the Link phase.

If the model has only continuous states, the Simulink engine invokes the continuous solver specified by the model. Depending on the solver, the solver either in turn calls the Derivatives method of the model once or enters a subcycle of minor time steps where the solver repeatedly calls the model's Outputs methods and Derivatives methods to compute the model's outputs and derivatives at successive intervals within the major time step. This is done to increase the accuracy of the

state computation. The model Outputs method and Derivatives methods in turn invoke their corresponding system methods, which invoke the block Outputs and Derivatives in the order specified by the Outputs and Derivatives methods execution lists generated in the Link phase.

- 3 Optionally checks for discontinuities in the continuous states of blocks.

A technique called zero-crossing detection is used to detect discontinuities in continuous states. See “Zero-Crossing Detection” on page 3-24 for more information.

- 4 Computes the time for the next time step.

Steps 1 through 4 are repeated until the simulation stop time is reached.

### More About

- “Solvers” on page 3-21
- “Simulate a Model Interactively” on page 23-2



## Solvers

A dynamic system is simulated by computing its states at successive time steps over a specified time span, using information provided by the model. The process of computing the successive states of a system from its model is known as solving the model. No single method of solving a model suffices for all systems. Accordingly, a set of programs, known as *solvers*, are provided that each embody a particular approach to solving a model. The Configuration Parameters dialog box allows you to choose the solver most suitable for your model (see “Solver Classification Criteria” on page 23-11).

### Fixed-Step Solvers Versus Variable-Step Solvers

The solvers provided in the Simulink software fall into two basic categories: fixed-step and variable-step.

*Fixed-step solvers* solve the model at regular time intervals from the beginning to the end of the simulation. The size of the interval is known as the step size. You can specify the step size or let the solver choose the step size. Generally, decreasing the step size increases the accuracy of the results while increasing the time required to simulate the system.

*Variable-step solvers* vary the step size during the simulation, reducing the step size to increase accuracy when a model's states are changing rapidly and increasing the step size to avoid taking unnecessary steps when the model's states are changing slowly. Computing the step size adds to the computational overhead at each step but can reduce the total number of steps, and hence simulation time, required to maintain a specified level of accuracy for models with rapidly changing or piecewise continuous states.

### Continuous Versus Discrete Solvers

The Simulink product provides both continuous and discrete solvers.

*Continuous solvers* use numerical integration to compute a model's continuous states at the current time step based on the states at previous time steps and the state derivatives. Continuous solvers rely on the individual blocks to compute the values of the model's discrete states at each time step.

Mathematicians have developed a wide variety of numerical integration techniques for solving the ordinary differential equations (ODEs) that represent the continuous states

of dynamic systems. An extensive set of fixed-step and variable-step continuous solvers are provided, each of which implements a specific ODE solution method (see “Solver Classification Criteria” on page 23-11).

*Discrete solvers* exist primarily to solve purely discrete models. They compute the next simulation time step for a model and nothing else. In performing these computations, they rely on each block in the model to update its individual discrete states. They do not compute continuous states.

---

**Note** You must use a continuous solver to solve a model that contains both continuous and discrete states. You cannot use a discrete solver because discrete solvers cannot handle continuous states. If, on the other hand, you select a continuous solver for a model with no states or discrete states only, Simulink software uses a discrete solver.

---

Two discrete solvers are provided: A fixed-step discrete solver and a variable-step discrete solver. The fixed-step solver by default chooses a step size and hence simulation rate fast enough to track state changes in the fastest block in your model. The variable-step solver adjusts the simulation step size to keep pace with the actual rate of discrete state changes in your model. This can avoid unnecessary steps and hence shorten simulation time for multirate models (see “Sample Times in Systems” on page 7-28 for more information).

### Minor Time Steps

Some continuous solvers subdivide the simulation time span into major and minor time steps, where a minor time step represents a subdivision of the major time step. The solver produces a result at each major time step. It uses results at the minor time steps to improve the accuracy of the result at the major time step.

### Shape Preservation

Usually the integration step size is only related to the current step size and the current integration error. However, for signals whose derivative changes rapidly, you can obtain a more accurate integration results by including the derivative input information at each time step. To do so, enable the **Model Configuration Parameters > Solver > Shape Preservation** option.

**See Also**

“Zero-Crossing Detection” on page 3-24 | “Modeling Dynamic Systems” on page 3-3 |  
“Simulation Phases in Dynamic Systems” on page 3-17

# Zero-Crossing Detection

A variable-step solver dynamically adjusts the time step size, causing it to increase when a variable is changing slowly and to decrease when the variable changes rapidly. This behavior causes the solver to take many small steps in the vicinity of a discontinuity because the variable is rapidly changing in this region. This improves accuracy but can lead to excessive simulation times.

The Simulink software uses a technique known as *zero-crossing detection* to accurately locate a discontinuity without resorting to excessively small time steps. Usually this technique improves simulation run time, but it can cause some simulations to halt before the intended completion time.

Two algorithms are provided in the Simulink software: Nonadaptive and Adaptive. For information about these techniques, see “Zero-Crossing Algorithms” on page 3-32.

## Demonstrating Effects of Excessive Zero-Crossing Detection

The Simulink software comes with three models that illustrate zero-crossing behavior: `sldemo_bounce_two_integrators`, `sldemo_doublebounce`, and `sldemo_bounce`.

- The `sldemo_bounce_two_integrators` model demonstrates how excessive zero crossings can cause a simulation to halt before the intended completion time unless you use the adaptive algorithm.
- The `sldemo_bounce` model uses a better model design than `sldemo_bounce_two_integrators`.
- The `sldemo_doublebounce` model demonstrates how the adaptive algorithm successfully solves a complex system with two distinct zero-crossing requirements.

## The Bounce Model with Two Integrators



### Bouncing Ball Model

Two separate Integrators are less efficient than a single Second-Order Integrator for simulating a bouncing ball.  
 Click here to see [sldemo\\_bounce](#) for the recommended modeling approach.

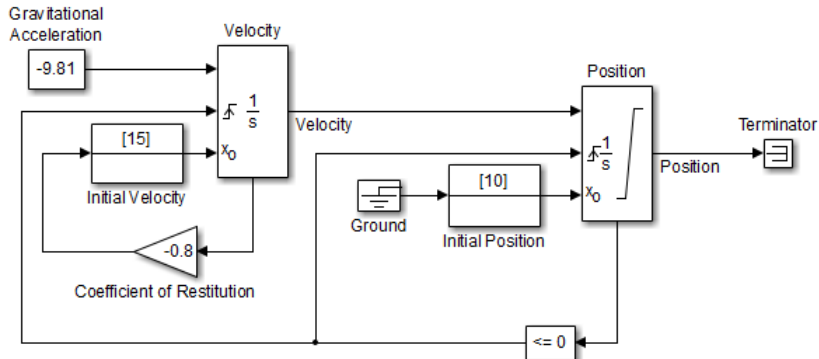

- 1 At the MATLAB command prompt, type `sldemo_bounce_two_integrators` to load the example.
- 2 Once the block diagram appears, set the **Model Configuration Parameters** > **Solver** > **Algorithm** parameter to **Nonadaptive**.
- 3 Also in the **Solver** pane, set the **Stop time** parameter to 20 s.
- 4 Run the model. In the Simulink Editor, select **Simulation** > **Run**.
- 5 After the simulation completes, click the Scope block window to see the results.

You may need to click on **Autoscale** to view the results in their entirety.

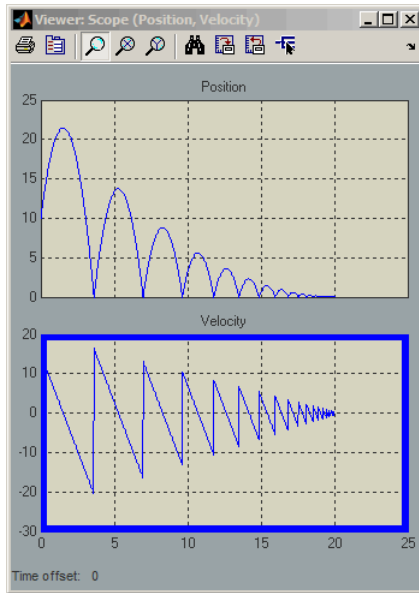

- 6 Use the scope zoom controls to closely examine the last portion of the simulation. You can see that the velocity is hovering just above zero at the last time point.

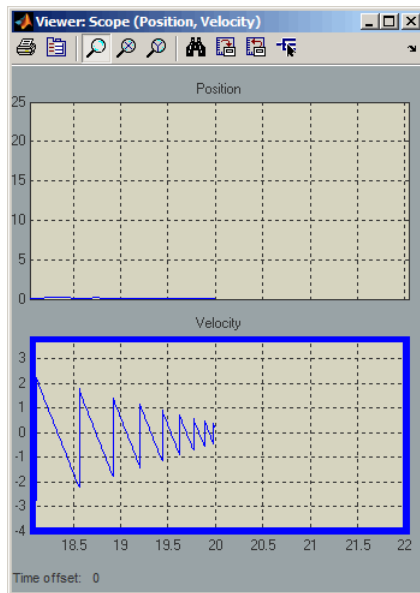

- 7 Change the simulation **Stop time** edit box in the Simulink Editor toolbar to 25 seconds, and run the simulation again.
- 8 This time the simulation halts with an error shortly after it passes the simulated 20 second time point.

Excessive chattering as the ball repeatedly approaches zero velocity has caused the simulation to exceed the default limit of 1000 for the number of consecutive zero crossings allowed. Although you can increase this limit by adjusting the **Model Configuration Parameters > Solver > Number of consecutive zero crossings** parameter. In this case, making that change does not allow the simulation to simulate for 25 seconds.

- 9 Also in the **Solver** pane, from the **Algorithm** pull down menu, select the **Adaptive** algorithm.
- 10 Run the simulation again.
- 11 This time the simulation runs to completion because the adaptive algorithm prevented an excessive number of zero crossings from occurring.

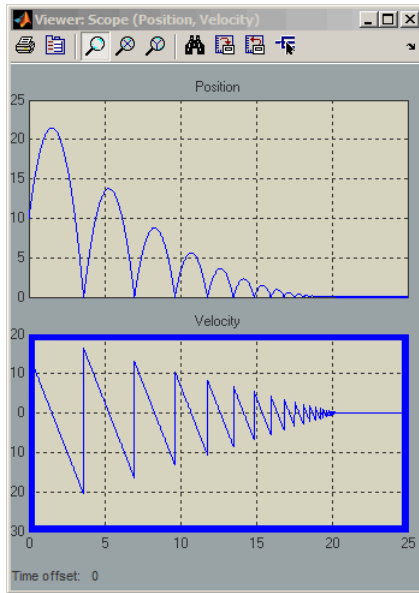

**Bounce Model with a Second-Order Integrator**

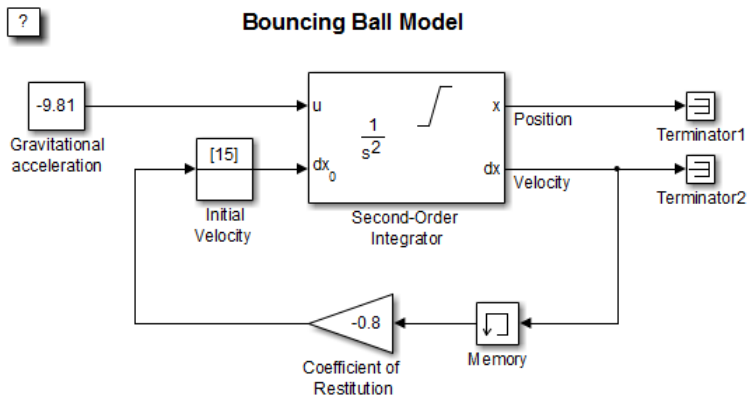



## The Double-Bounce Model

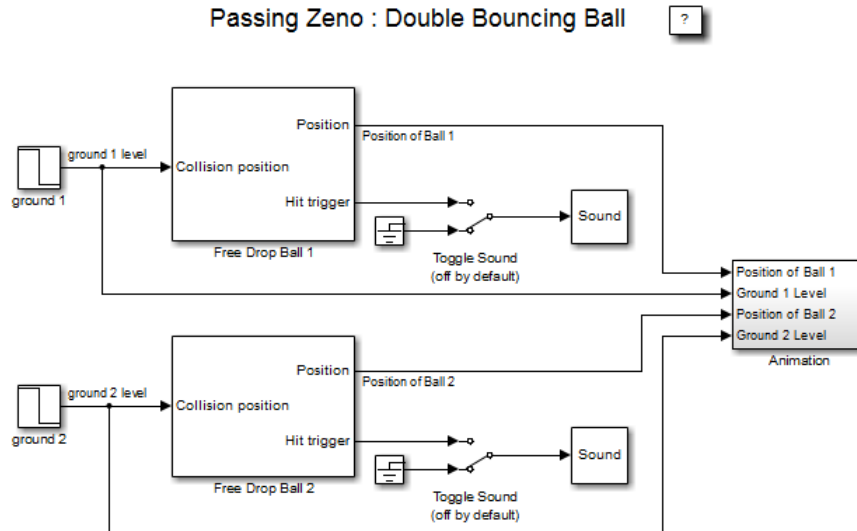

- 1 At the MATLAB command prompt, type `sldemo_doublebounce` to load the example. The model and an animation window open. In the animation window, two balls are resting on two platforms.
- 2 In the animation window, click the **Nonadaptive** button to run the example using the nonadaptive algorithm. This is the default setting used by the Simulink software for all models.
- 3 The ball on the right is given a larger initial velocity. Consequently, the two balls hit the ground and recoil at different times.
- 4 The simulation halts after 14 seconds because the ball on the left exceeded the number of zero crossings limit. The ball on the right is left hanging in mid air.
- 5 An error message dialog opens. Click **OK** to close it.
- 6 Click on the **Adaptive** button to run the simulation with the adaptive algorithm.
- 7 Notice that this time the simulation runs to completion, even after the ground shifts out from underneath the ball on the left at 20 seconds.

## How the Simulator Can Miss Zero-Crossing Events

The bounce and double-bounce models show that high-frequency fluctuations about a discontinuity ('chattering') can cause a simulation to prematurely halt.

It is also possible for the solver to entirely miss zero crossings if the solver error tolerances are too large. This is possible because the zero-crossing detection technique checks to see if the value of a signal has changed sign after a major time step. A sign change indicates that a zero crossing has occurred, and the zero-crossing algorithm will then hunt for the precise crossing time. However, if a zero crossing occurs within a time step, but the values at the beginning and end of the step do not indicate a sign change, the solver steps over the crossing without detecting it.

The following figure shows a signal that crosses zero. In the first instance, the integrator steps over the event because the sign has not changed between time steps. In the second, the solver detects change in sign and so detects the zero-crossing event.

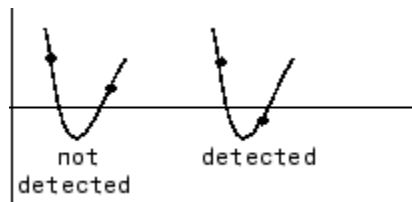

### Preventing Excessive Zero Crossings

Use the following table to prevent excessive zero-crossing errors in your model.

Make this change...	How to make this change...	Rationale for making this change...
Increase the number of allowed zero crossings	Increase the value of the <b>Number of consecutive zero crossings</b> option on the <b>Solver</b> pane in the Configuration Parameters dialog box.	This may give your model enough time to resolve the zero crossing.
Relax the <b>Signal threshold</b>	Select <b>Adaptive</b> from the <b>Algorithm</b> pull down and increase the value of the <b>Signal threshold</b> option on the <b>Solver</b> pane in the Configuration Parameters dialog box.	The solver requires less time to precisely locate the zero crossing. This can reduce simulation time and eliminate an excessive number of consecutive zero-crossing errors. However, relaxing the <b>Signal threshold</b> may reduce accuracy.
Use the <b>Adaptive</b> Algorithm	Select <b>Adaptive</b> from the <b>Algorithm</b> pull down on	This algorithm dynamically adjusts the zero-crossing

Make this change...	How to make this change...	Rationale for making this change...
	the <b>Solver</b> pane in the Configuration Parameters dialog box.	threshold, which improves accuracy and reduces the number of consecutive zero crossings detected. With this algorithm you have the option of specifying both the <b>Time tolerance</b> and the <b>Signal threshold</b> .
Disable zero-crossing detection for a specific block	<ol style="list-style-type: none"> <li><b>1</b> Clear the <b>Enable zero-crossing detection</b> check box on the block's parameter dialog box.</li> <li><b>2</b> Select <b>Use local settings</b> from the <b>Zero-crossing control</b> pull down on the <b>Solver</b> pane of the Configuration Parameters dialog box.</li> </ol>	Locally disabling zero-crossing detection prevents a specific block from stopping the simulation because of excessive consecutive zero crossings. All other blocks continue to benefit from the increased accuracy that zero-crossing detection provides.
Disable zero-crossing detection for the entire model	Select <b>Disable all</b> from the <b>Zero-crossing control</b> pull down on the <b>Solver</b> pane of the Configuration Parameters dialog box.	This prevents zero crossings from being detected anywhere in your model. A consequence is that your model no longer benefits from the increased accuracy that zero-crossing detection provides.
If using the <code>ode15s</code> solver, consider adjusting the order of the numerical differentiation formulas	Select a value from the <b>Maximum order</b> pull down on the <b>Solver</b> pane of the Configuration Parameters dialog box.	For more information, see “Maximum order”.

Make this change...	How to make this change...	Rationale for making this change...
Reduce the maximum step size	Enter a value for the <b>Max step size</b> option on the <b>Solver</b> pane of the Configuration Parameters dialog box.	This can insure the solver takes steps small enough to resolve the zero crossing. However, reducing the step size can increase simulation time, and is seldom necessary when using the Adaptive algorithm.

## Zero-Crossing Algorithms

The Simulink software includes two zero-crossing detection algorithms: Nonadaptive and Adaptive.

To choose the algorithm, either use the **Algorithm** option in the Solver pane of the Configuration Parameter dialog box, or use the `ZeroCrossAlgorithm` command. The command can either be set to 'Nonadaptive' or 'Adaptive'.

The Nonadaptive algorithm is provided for backwards compatibility with older versions of Simulink and is the default. It brackets the zero-crossing event and uses increasingly smaller time steps to pinpoint when the zero crossing has occurred. Although adequate for many types of simulations, the Nonadaptive algorithm can result in very long simulation times when a high degree of 'chattering' (high frequency oscillation around the zero-crossing point) is present.

The Adaptive algorithm dynamically turns the bracketing on and off, and is a good choice when:

- The system contains a large amount of chattering.
- You wish to specify a guard band (tolerance) around which the zero crossing is detected.

The Adaptive algorithm turns off zero-crossing bracketing (stops iterating) if either of the following are satisfied:

- The zero crossing error is exceeded. This is determined by the value specified in the **Signal threshold** option in the Solver pane of the Configuration Parameters dialog box. This can also be set with the `ZCThreshold` command. The default is `Auto`, but you can enter any real number greater than zero for the tolerance.

- The system has exceeded the number of consecutive zero crossings specified in the **Number of consecutive zero crossings** option in the Solver pane of the Configuration Parameters dialog box. Alternatively, this can be set with the `MaxConsecutiveZCs` command.

## Understanding Signal Threshold

The Adaptive algorithm automatically sets a tolerance for zero-crossing detection. Alternatively, you can set the tolerance by entering a real number greater than or equal to zero in the Configuration Parameters Solver pane, **Signal threshold** pull down. This option only becomes active when the zero-crossing algorithm is set to **Adaptive**.

This graphic shows how the Signal threshold sets a window region around the zero-crossing point. Signals falling within this window are considered as being at zero.

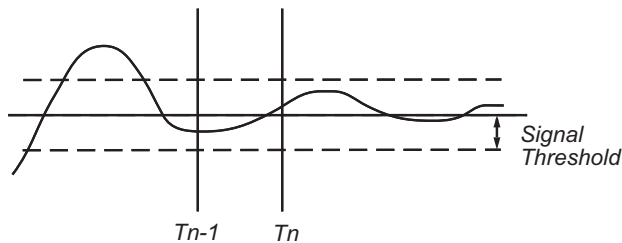

The zero-crossing event is bracketed by time steps  $T_{n-1}$  and  $T_n$ . The solver iteratively reduces the time steps until the state variable lies within the band defined by the signal threshold, or until the number of consecutive zero crossings equals or exceeds the value in the Configuration Parameters Solver pane, **Number of consecutive zero crossings** pull down.

It is evident from the figure that increasing the signal threshold increases the distance between the time steps which will be executed. This often results in faster simulation times, but might reduce accuracy.

## How Blocks Work with Zero-Crossing Detection

A block can register a set of zero-crossing variables, each of which is a function of a state variable that can have a discontinuity. The zero-crossing function passes through zero from a positive or negative value when the corresponding discontinuity occurs. The registered zero-crossing variables are updated at the end of each simulation step, and any variable that has changed sign is identified as having had a zero-crossing event.

If any zero crossings are detected, the Simulink software interpolates between the previous and current values of each variable that changed sign to estimate the times of the zero crossings (that is, the discontinuities).

---

**Note:** The Zero-Crossing detection algorithm can bracket zero-crossing events only for signals of data type double

---

### Blocks That Register Zero Crossings

The following table lists blocks that register zero crossings and explains how the blocks use the zero crossings:

Block	Description of Zero Crossing
Abs	One: to detect when the input signal crosses zero in either the rising or falling direction.
Backlash	Two: one to detect when the upper threshold is engaged, and one to detect when the lower threshold is engaged.
Compare To Constant	One: to detect when the signal equals a constant.
Compare To Zero	One: to detect when the signal equals zero.
Dead Zone	Two: one to detect when the dead zone is entered (the input signal minus the lower limit), and one to detect when the dead zone is exited (the input signal minus the upper limit).
Enable	One: If an Enable port is inside of a Subsystem block, it provides the capability to detect zero crossings. See the Enable Subsystem block for details “Enabled Subsystems” on page 10-4.
From File	One: to detect when the input signal has a discontinuity in either the rising or falling direction

Block	Description of Zero Crossing
From Workspace	One: to detect when the input signal has a discontinuity in either the rising or falling direction
Hit Crossing	One or two. If there is no output port, there is only one zero crossing to detect when the input signal hit the threshold value. If there is an output port, the second zero crossing is used to bring the output back to 0 from 1 to create an impulse-like output.
If	One: to detect when the If condition is met.
Integrator	If the reset port is present, to detect when a reset occurs.  If the output is limited, there are three zero crossings: one to detect when the upper saturation limit is reached, one to detect when the lower saturation limit is reached, and one to detect when saturation is left.
MinMax	One: for each element of the output vector, to detect when an input signal is the new minimum or maximum.
Relational Operator	One: to detect when the specified relation is true.
Relay	One: if the relay is off, to detect the switch-on point. If the relay is on, to detect the switch-off point.
Saturation	Two: one to detect when the upper limit is reached or left, and one to detect when the lower limit is reached or left.
Second-Order Integrator	Five: two to detect when the state $x$ upper or lower limit is reached; two to detect when the state $dx/dt$ upper or lower limit is reached; and one to detect when a state leaves saturation.
Sign	One: to detect when the input crosses through zero.
Signal Builder	One: to detect when the input signal has a discontinuity in either the rising or falling direction
Step	One: to detect the step time.
Switch	One: to detect when the switch condition occurs.
Switch Case	One: to detect when the case condition is met.

Block	Description of Zero Crossing
Trigger	One: If a Triggered port is inside of a Subsystem block, it provides the capability to detect zero crossings. See the Triggered Subsystem block for details: “Triggered Subsystems” on page 10-14.
Enabled and Triggered Subsystem	Two: one for the enable port and one for the trigger port. See the Enabled and Triggered Subsystem block for details: “Enabled and Triggered Subsystems” on page 10-19

---

**Note:** Zero-crossing detection is also available for a Stateflow chart that uses continuous-time mode. See “Configure a Stateflow Chart to Update in Continuous Time” (Stateflow) in the Stateflow documentation for more information.

---

#### Implementation Example: Saturation Block

An example of a Simulink block that registers zero crossings is the Saturation block. Zero-crossing detection identifies these state events in the Saturation block:

- The input signal reaches the upper limit.
- The input signal leaves the upper limit.
- The input signal reaches the lower limit.
- The input signal leaves the lower limit.

Simulink blocks that define their own state events are considered to have *intrinsic zero crossings*. Use the Hit Crossing block to receive explicit notification of a zero-crossing event. See “Blocks That Register Zero Crossings” on page 3-34 for a list of blocks that incorporate zero crossings.

The detection of a state event depends on the construction of an internal zero-crossing signal. This signal is not accessible by the block diagram. For the Saturation block, the signal that is used to detect zero crossings for the upper limit is `zcSignal = UpperLimit - u`, where `u` is the input signal.

Zero-crossing signals have a direction attribute, which can have these values:

- *rising* — A zero crossing occurs when a signal rises to or through zero, or when a signal leaves zero and becomes positive.



- *falling* — A zero crossing occurs when a signal falls to or through zero, or when a signal leaves zero and becomes negative.
- *either* — A zero crossing occurs if either a rising or falling condition occurs.

For the Saturation block's upper limit, the direction of the zero crossing is *either*. This enables the entering and leaving saturation events to be detected using the same zero-crossing signal.

### **See Also**

“Modeling Dynamic Systems” on page 3-3 | “Algebraic Loops” on page 3-38 |  
“Solvers” on page 3-21

## Algebraic Loops

### In this section...

“What Is an Algebraic Loop?” on page 3-38

“Interpretations of Algebraic Loops” on page 3-39

“What is an Artificial Algebraic Loop?” on page 3-42

“Why Algebraic Loops Are Undesirable” on page 3-43

“Identify Algebraic Loops in Your Model” on page 3-44

“How to Handle Algebraic Loops in a Model” on page 3-47

“How the Algebraic Loop Solver Works” on page 3-49

“Remove Algebraic Loops” on page 3-51

“Remove Artificial Algebraic Loops” on page 3-54

“How Simulink Eliminates Artificial Algebraic Loops” on page 3-65

“When Simulink Cannot Eliminate Artificial Algebraic Loops” on page 3-71

“Managing Large Models with Artificial Algebraic Loops” on page 3-73

“Changing Block Priorities When Using Algebraic Loop Solver” on page 3-74

### What Is an Algebraic Loop?

In a Simulink model, an *algebraic loop* occurs when a signal loop exists with only direct feedthrough blocks within the loop. *Direct feedthrough* means that the block output depends on the value of an input port; the value of the input directly controls the value of the output.

Some blocks have input ports with direct feedthrough. Simulink cannot compute the output of these blocks without knowing the values of the signals entering the blocks at these input ports at the current time step.

Some examples of blocks with direct feedthrough inputs are:

- Math Function
- Gain
- Product

- State-Space, when the D matrix coefficient is nonzero
- Sum
- Transfer Fcn, when the numerator and denominator are of the same order
- Zero-Pole, when the block has as many zeros as poles

*Nondirect feedthrough* blocks maintain a State variable. Two examples are Integrator and Unit Delay.

---

**Tip:** To determine if a block has direct feedthrough, read the **Characteristics** section of the block reference page.

---

The figure shows an example of an algebraic loop (for demonstration only, not a recommended modeling pattern). The Sum block is an algebraic variable  $x_a$  that is constrained to equal the first input  $u$  minus  $x_a$  (for example,  $x_a = u - x_a$ ).

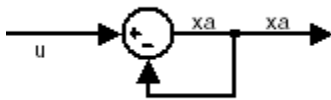

The solution of this simple loop is  $x_a = u/2$ .

## Interpretations of Algebraic Loops

### Mathematical Interpretation

Simulink contains a suite of numerical solvers for simulating *ordinary differential equations (ODEs)*, which are systems of equations that you can write as

$$\dot{x} = f(x, t),$$

where:

- $x$  is the state vector.

- $t$  is the independent time variable.

Some systems of equations contain additional constraints that involve the independent variable and the state vector, but not the derivative of the state vector. Such systems are *differential algebraic equations (DAEs)*, not ODEs.

The term *algebraic* refers to equations that do not involve any derivatives. You can express DAEs that arise in engineering in the semi-explicit form

$$\begin{aligned}\dot{\mathbf{x}} &= \mathbf{f}(\mathbf{x}, \mathbf{x}_a, t) \\ 0 &= \mathbf{g}(\mathbf{x}, \mathbf{x}_a, t),\end{aligned}$$

where:

- $\mathbf{f}$  and  $\mathbf{g}$  can be vector functions.
- The first equation is the differential equation.
- The second equation is the algebraic equation.
- The vector of differential variables is  $\mathbf{x}$ .
- The vector of algebraic variables is  $\mathbf{x}_a$ .

In Simulink models, algebraic loops are algebraic constraints. Models with algebraic loops define a system of differential algebraic equations. Simulink does not solve DAEs directly. Simulink solves the algebraic equations (the algebraic loop) numerically for  $x_a$  at each step of the ODE solver.

The model in the figure is equivalent to this system of equations in semi-explicit form:

$$\begin{aligned}\dot{x} &= f(x, x_a, t) = x_a \\ 0 &= g(x, x_a, t) = -x + u - 2x_a.\end{aligned}$$

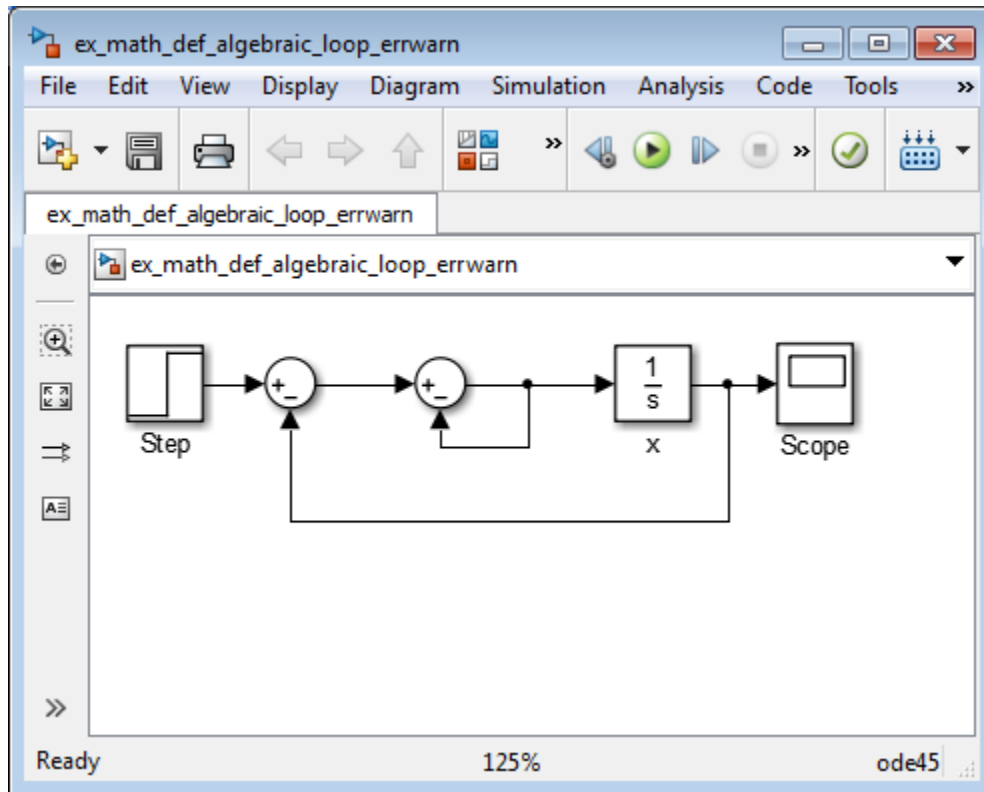

At each step of the ODE solver, the algebraic loop solver must solve the algebraic constraint for  $x_a$  before calculating the derivative  $\dot{x}$ .

### Physical Interpretation

Algebraic constraints:

- Occur when modeling physical systems, often due to conservation laws, such as conservation of mass and energy
- Occur when you choose a particular coordinate system for a model
- Help impose design constraints on system responses in a dynamic system

Use Simscape to model systems that span mechanical, electrical, hydraulic, and other physical domains as physical networks. Simscape constructs the DAEs that characterize

the behavior of a model. The software integrates these equations with the rest of the model and then solves the DAEs directly. Simulink solves the variables for the components in the different physical domains simultaneously, avoiding problems with algebraic loops.

## What is an Artificial Algebraic Loop?

An *artificial algebraic loop* occurs when an atomic subsystem or Model block causes Simulink to detect an algebraic loop, even though the contents of the subsystem do not contain an algebraic constraint. When you create an atomic subsystem, all Inport blocks are direct feedthrough, resulting in an algebraic loop.

### Example of an Artificial Algebraic Loop

Start with this model, which does not contain an algebraic loop. It simulates without error.

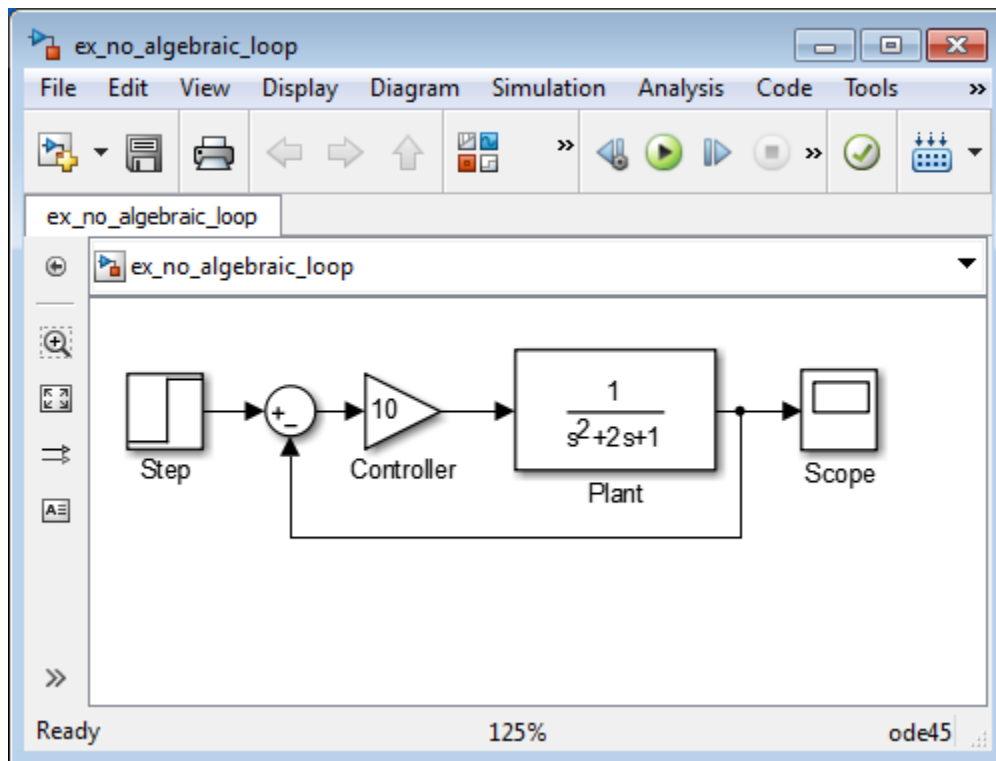

- 1 Enclose the Controller and Plant blocks in a subsystem.
- 2 In the subsystem block dialog box, select **Treat as atomic unit** to make the subsystem atomic.
- 3 In the **Diagnostics** pane of Model Configuration Parameters, set the **Algebraic loop** parameter to error.

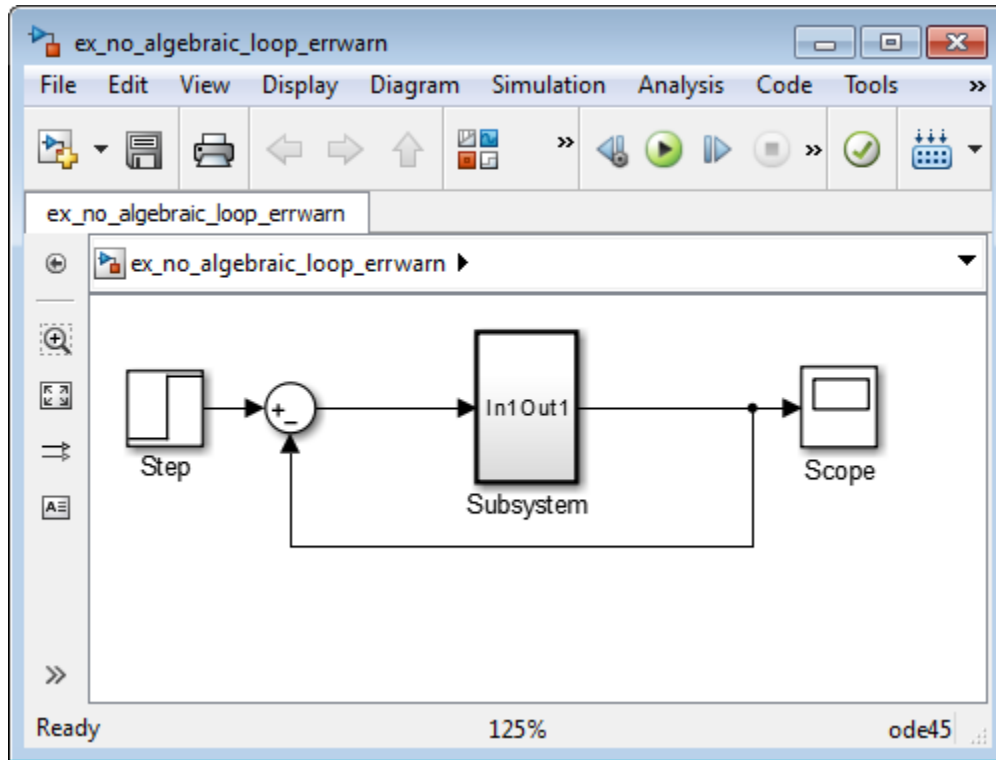

When simulating this model, an algebraic loop occurs because the subsystem is direct feedthrough, even though the path within the atomic subsystem is not direct feedthrough. Simulation stops with an algebraic loop error.

## Why Algebraic Loops Are Undesirable

If your model contains an algebraic loop:

- You cannot generate code for the model.

- The Simulink algebraic loop solver might not be able to solve the algebraic loop.
- While Simulink is trying to solve the algebraic loop, the simulation can execute slowly.

For most models, the algebraic loop solver is computationally expensive for the first time step. Simulink solves subsequent time steps rapidly because a good starting point for  $x_a$  is available from the previous time step.

### Identify Algebraic Loops in Your Model

Use these techniques to search for algebraic loops in your model:

- “Highlight Algebraic Loops in the Model” on page 3-44
- “Use The Algebraic Loop Diagnostic” on page 3-45
- “Use The ashow Debugger Command” on page 3-46

### Highlight Algebraic Loops in the Model

Use `getAlgebraicLoops` to identify algebraic loops in a model and highlight them in the Simulink Editor. With this approach:

- You can traverse multiple layers of model hierarchy to locate algebraic loops.
- You can identify real and artificial algebraic loops.
- You can visualize all loops in your model simultaneously.
- You do not need to drill in and out of the model, across boundaries.
- You do not need to detect loops in serial order. Also, you do not need to compile the model every time you detect and solve a loop. Therefore you can solve loops quickly.

You perform algebraic loop highlighting on an entire model, not on specific subsystems.

- 1 Open the model.
- 2 In the **Diagnostics** pane of Model Configuration Parameters, set **Algebraic loop** to **none** or **warning**. Setting this parameter to **error** prevents the model from compiling.
- 3 Compile the model without any errors. The model must compile before you can highlight any algebraic loops.
- 4 At the MATLAB command prompt, enter:

```
Simulink.BlockDiagram.getAlgebraicLoops(bdroot)
```



The `getAlgebraicLoops` function highlights algebraic loops in the model, including algebraic loops in subsystems. It also creates a report with information about each loop:

- Solid lines represent real algebraic loops.
- Dotted lines represent artificial algebraic loops.
- A red highlight appears around a block assigned with an algebraic variable.
- The **Loop ID** helps you identify the system that contains a particular loop.

Customize the report by selecting or clearing the **Visible** checkbox for a loop.

Once you have identified algebraic loops in a model, you can remove them by editing the model. Close the highlight report and make changes to the model. You can edit the model only after you close the report. For information on removing real algebraic loops, see “Remove Algebraic Loops” on page 3-51.

Simulink does not save loop highlighting. Closing the model or exiting the display removes the loop highlighting.

### Use The Algebraic Loop Diagnostic

Simulink detects algebraic loops during simulation initialization, for example, when you update your diagram. You can set the **Algebraic loop** diagnostic to report an error or warning if the software detects any algebraic loops in your model.

In the **Diagnostics** pane of the Model Configuration Parameters, set the **Algebraic loop** parameter.

Setting	Simulation Response
none	Simulink tries to solve the algebraic loop; reports an error only if the algebraic loop cannot be solved.
warning	Algebraic loops result in warnings. Simulink tries to solve the algebraic loop; reports an error only if the algebraic loop cannot be solved.
error	Algebraic loops stop the initialization. Review the loop manually before Simulink tries to solve the loop.

This example shows how to use the algebraic loop diagnostic to highlight algebraic loops in the `sldemo_hydcyl` model.

- 1 Open the `sldemo_hydcyl` model.

- 2 In the **Diagnostics** pane of the Model Configuration Parameters, set the **Algebraic loop** parameter to **error**.
- 3 Simulate the model.

When Simulink detects an algebraic loop during initialization, the simulation stops. The Diagnostic Viewer displays an error message and lists all the blocks in the model that are part of that algebraic loop.

In the model, red highlights show the blocks and signals that make up the loop.

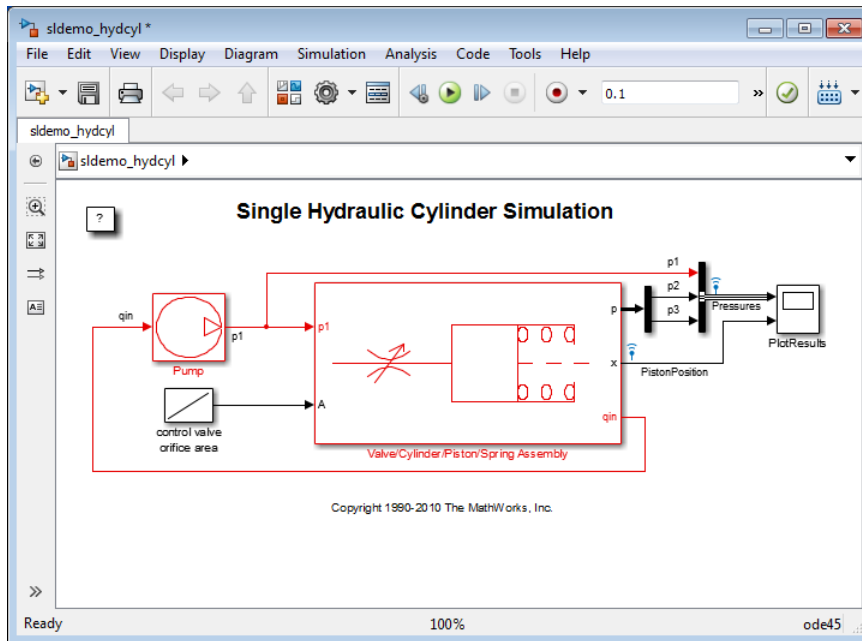

- 4 Close the Diagnostic Viewer to remove the highlights.
- 5 Close sldemo\_hydcyl model. Do not save the changes.

#### Use The **ashow Debugger Command**

Use the **ashow** command in the Simulink debugger to highlight algebraic loops and step through a simulation.

- 1 Open the sldemo\_hydcyl model.

By default, the **Algebraic loop** parameter for this model is set to `none`.

- 2 Start the Simulink debugger. Select **Simulation > Debug > Debug Model**.

Run the debugger.

- 3 In the MATLAB command prompt, enter:

```
ashow
```

The command returns the algebraic loop in `sldemo_hydcyl` and the number of blocks in the loop.

```
Found 1 Algebraic loop(s):
System#Algebraic loop id, number of blocks in loop
- 0#1, 9 blocks in loop
```

- 4 To list the blocks in this algebraic loop, at the MATLAB command prompt, enter:

```
ashow 0#1
```

The Control Valve Flow subsystem in the Valve/Cylinder/Piston/Spring Assembly subsystem opens with the algebraic loop in the model highlighted. The function lists the nine blocks in the algebraic loop:

```
- sldemo_hydcyl/Valve//Cylinder//Piston//Spring Assembly/Control Valve Flow/IC
- sldemo_hydcyl/Valve//Cylinder//Piston//Spring Assembly/Control Valve Flow/signed sqrt
- sldemo_hydcyl/Valve//Cylinder//Piston//Spring Assembly/Control Valve Flow/Product
- sldemo_hydcyl/Valve//Cylinder//Piston//Spring Assembly/laminar flow pressure drop
- sldemo_hydcyl/Valve//Cylinder//Piston//Spring Assembly/Sum7
- sldemo_hydcyl/Pump/IC
- sldemo_hydcyl/Valve//Cylinder//Piston//Spring Assembly/Control Valve Flow/
Sum1 (algebraic variable)
- sldemo_hydcyl/Pump/Sum1
- sldemo_hydcyl/Pump/leakage (algebraic variable)
```

## How to Handle Algebraic Loops in a Model

If Simulink reports an algebraic loop in your model, the algebraic loop solver may be able to solve the loop. If Simulink cannot solve the loop, there are several techniques to eliminate the loop.

Use this workflow to decide how you want to eliminate an algebraic loop.

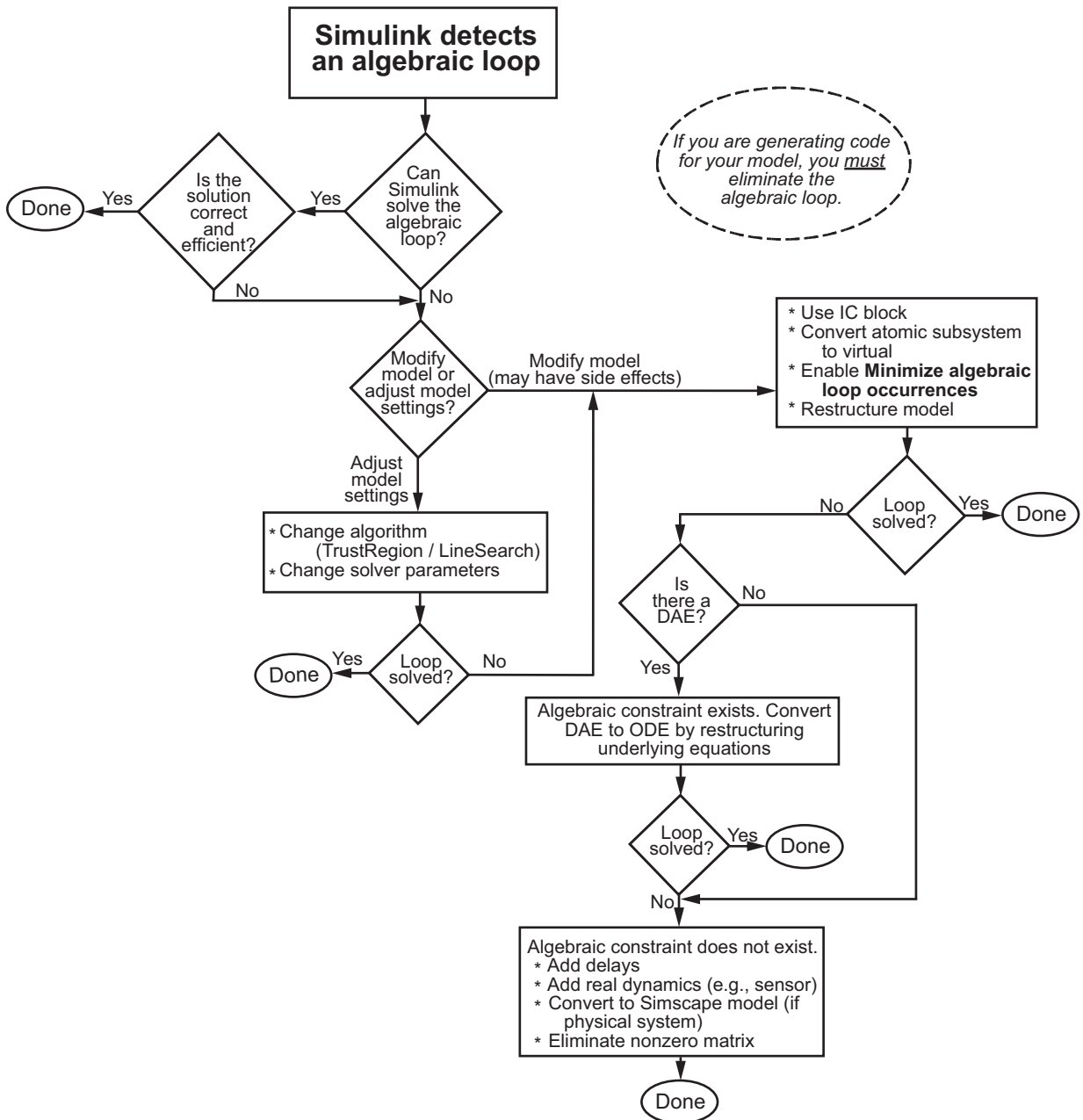

## How the Algebraic Loop Solver Works

When a model contains an algebraic loop, Simulink uses a nonlinear solver at each time step to solve the algebraic loop. The solver performs iterations to determine the solution to the algebraic constraint, if there is one. As a result, models with algebraic loops can run more slowly than models without algebraic loops.

Simulink uses a dogleg trust region algorithm to solve algebraic loops. The tolerance used is smaller than the ODE solver `RelTol` and `Abstol`. This is because Simulink uses the “explicit ODE method” to solve Index-1 differential algebraic equations (DAEs).

For the algebraic loop solver to work,

- There must be one block where the loop solver can break the loop and attempt to solve the loop.
- The model should have real double signals.
- The underlying algebraic constraint must be a smooth function

For example, suppose your model has a Sum block with two inputs—one additive, the other subtractive. If you feed the output of the Sum block to one of the inputs, you create an algebraic loop where all of the blocks include direct feedthrough.



The Sum block cannot compute the output without knowing the input. Simulink detects the algebraic loop, and the algebraic loop solver solves the loop using an iterative loop. In the Sum block example, the software computes the correct result this way:

$$x_a(t) = u(t) / 2.$$

The algebraic loop solver uses a gradient-based search method, which requires continuous first derivatives of the algebraic constraint that correspond to the algebraic loop. As a result, if the algebraic loop contains discontinuities, the algebraic loop solver can fail.

For more information, see Solving Index-1 DAEs in MATLAB and Simulink <sup>1</sup>

#### **Trust-Region and Line-Search Algorithms in the Algebraic Loop Solver**

The Simulink algebraic loop solver uses one of two algorithms to solve algebraic loops:

- Trust-Region
- Line-Search

By default, the algebraic loop solver uses the trust-region algorithm.

If the algebraic loop solver cannot solve the algebraic loop with the trust-region algorithm, try simulating the model using the line-search algorithm.

To switch to the line-search algorithm, at the MATLAB command line, enter:

```
set_param(model_name, 'AlgebraicLoopSolver', 'LineSearch');
```

To switch back to the trust-region algorithm, at the MATLAB command line, enter:

```
set_param(model_name, 'AlgebraicLoopSolver', 'TrustRegion');
```

For more information, see:

- Shampine and Reichelt's `nleqn.m` code
- The Fortran program HYBRD1 in the User Guide for MINPACK-1 <sup>2</sup>
- Powell's "A Fortran subroutine for solving systems in nonlinear equations," in *Numerical Methods for Nonlinear Algebraic Equations*<sup>3</sup>
- "Trust-Region Methods for Nonlinear Minimization" (Optimization Toolbox) in the Optimization Toolbox™ documentation.
- "Line Search" (Optimization Toolbox) in the Optimization Toolbox documentation.

#### **Limitations of the Algebraic Loop Solver**

Algebraic loop solving is an iterative process. The Simulink algebraic loop solver is successful only if the algebraic loop converges to a definite answer. When the loop fails to converge, or converges too slowly, the simulation exits with an error.

1. Shampine, Lawrence F., M.W.Reichelt, and J.A.Kierzenka. "Solving Index-1 DAEs in MATLAB and Simulink." *Siam Review*. Vol.18, No.3, 1999, pp.538–552.
2. More, J.J., B.S.Garbow, and K.E.Hillstom. *User guide for MINPACK-1*. Argonne, IL: Argonne National Laboratory, 1980.
3. Rabinowitz, Philip, ed. *Numerical Methods for Nonlinear Algebraic Equations*, New York: Gordon and Breach Science Publishers, 1970.

The algebraic loop solver cannot solve algebraic loops that contain any of the following:

- Blocks with discrete-valued outputs
- Blocks with nondouble or complex outputs
- Discontinuities
- Stateflow charts

## Remove Algebraic Loops

Use these techniques to remove algebraic loops in a model.

- “Introduce a Delay” on page 3-51
- “Solve Algebraic Loops Manually” on page 3-53
- “Create Initial Guesses Using the IC and Algebraic Constraint Blocks” on page 3-54

### Introduce a Delay

Algebraic loops can occur in large models when atomic subsystems create feedback loops.

In the generic model here, there are two algebraic loops that involve subsystems.

- BlackBox\_A  $\rightarrow$  BlackBox\_B  $\rightarrow$  BlackBox\_C  $\rightarrow$  BlackBox\_A
- BlackBox\_B  $\rightarrow$  BlackBox\_C  $\rightarrow$  BlackBox\_B

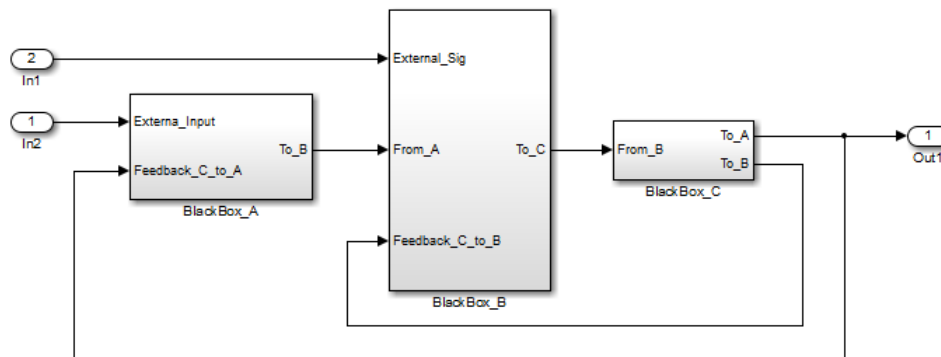

When you update this model, Simulink detects the loop BlackBox\_A → BlackBox\_B → BlackBox\_C → BlackBox\_A.

Since you do not know the contents of these subsystems, break the loops by adding a Unit Delay block outside the subsystems. There are three ways to use the Unit Delay to break these loops:

- Add a unit delay between BlackBox\_A and BlackBox\_C
- Add a unit delay between BlackBox\_B and BlackBox\_C
- Add unit delays to both algebraic loops

#### Add a unit delay between BlackBox\_A and BlackBox\_C

If you add a unit delay on the feedback signal between the subsystems BlackBox\_A and BlackBox\_C, you introduce the minimum number of unit delays (1) to the system. By introducing the delay before BlackBox\_A, BlackBox\_B and BlackBox\_C use data from the current time step.

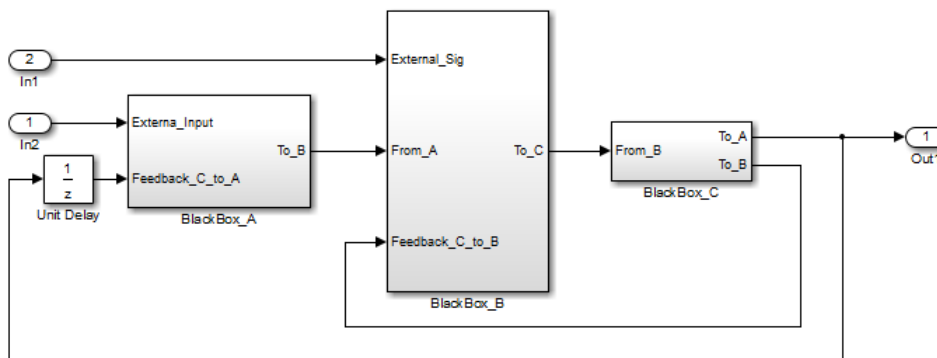

#### Add a unit delay between BlackBox\_B and BlackBox\_C

If you add a unit delay between the subsystems BlackBox\_B and BlackBox\_C, you break the algebraic loop between BlackBox\_B and BlackBox\_C. In addition, you break the loop between BlackBox\_A and BlackBox\_C, because that signal completes the algebraic loop. By inserting the Unit Delay block before BlackBox\_C, BlackBox\_C now works with data from the previous time step only.



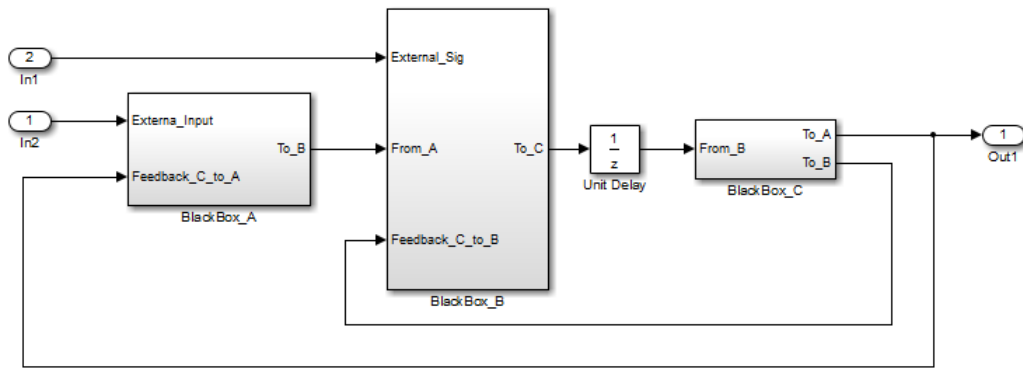

### Add unit delays to both algebraic loops

In the example here, you insert Unit Delay blocks to break both algebraic loops. In this model, BlackBox\_A and BlackBox\_B use data from the previous time step. BlackBox\_C uses data from the current time step.

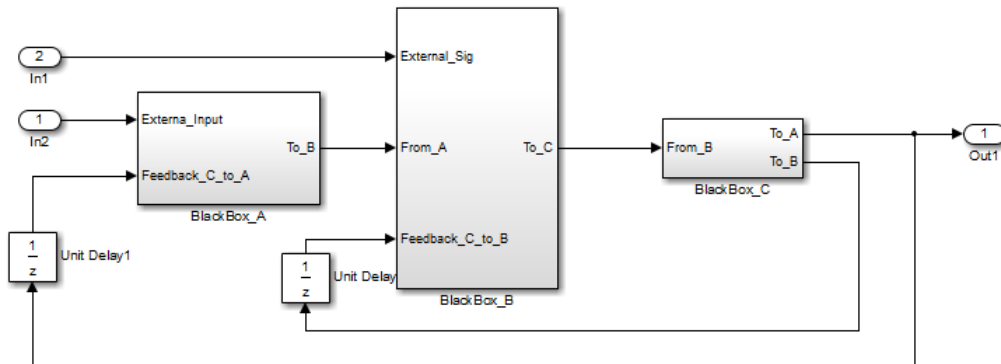

### Solve Algebraic Loops Manually

If Simulink cannot solve the algebraic loop, the software reports an error. Use one of these techniques to solve the loop manually:

- Restructure the underlying DAEs using techniques such as differentiation or change of coordinates. These techniques put the DAEs in a form that is easier for the algebraic loop solver to solve.
- Convert the DAEs to ODEs, which eliminates any algebraic loops.

- “Create Initial Guesses Using the IC and Algebraic Constraint Blocks” on page 3-54

### Create Initial Guesses Using the IC and Algebraic Constraint Blocks

Your model might contain loops for which the loop solver cannot converge without a good, initial guess for the algebraic states. You can specify an initial guess for the algebraic state variables, but use this technique only when you think the loop is legitimate.

There are two ways to specify an initial guess:

- Place an IC block in the algebraic loop.
- Specify an initial guess for a signal in an algebraic loop using an Algebraic Constraint block.

### Remove Artificial Algebraic Loops

Use these techniques to remove artificial algebraic loops in a model:

- “Eliminate Artificial Algebraic Loops Caused by Atomic Subsystems” on page 3-54
- “Bundled Signals That Create Artificial Algebraic Loops” on page 3-55
- “Model and Block Parameters to Diagnose and Eliminate Artificial Algebraic Loops” on page 3-59
- “Block Reduction and Artificial Algebraic Loops” on page 3-60

### Eliminate Artificial Algebraic Loops Caused by Atomic Subsystems

If an atomic subsystem causes an artificial algebraic loop, convert the atomic subsystem to a virtual subsystem. This change has no effect on the behavior of the model. When the subsystem is atomic and you simulate the model, Simulink invokes the algebraic loop solver. The solver terminates after one iteration. The algebraic loop is automatically solved because there is no algebraic constant. After you make the subsystem virtual, Simulink does not invoke the algebraic loop solver during simulation.

To convert an atomic subsystem to a virtual subsystem:

- 1 Open the model that contains the atomic subsystem.
- 2 Right-click the atomic subsystem and select **Subsystem Parameters**.
- 3 Clear the **Treat as atomic unit** parameter.
- 4 Save the changes.

If you replace the atomic subsystem with a virtual subsystem and the simulation still fails with an algebraic loop error, examine the model for one of these:

- An algebraic constraint
- An artificial algebraic loop that was not caused by this atomic subsystem

### Bundled Signals That Create Artificial Algebraic Loops

Some models bundle signals together. This bundling can cause Simulink to detect an algebraic loop, even when an algebraic constraint does not exist. If you redirect one or more signals, you may be able to remove the artificial algebraic loop.

In this example, a linearized model simulates the dynamics of a two-tank system fed by a single pump. In this model:

- Output  $q_1$  is the rate of the fluid flow into the tank from the pump.
- Output  $h_2$  is the height of the fluid in the second tank.
- The State-Space block defines the dynamic response of the tank system to the pump operation:

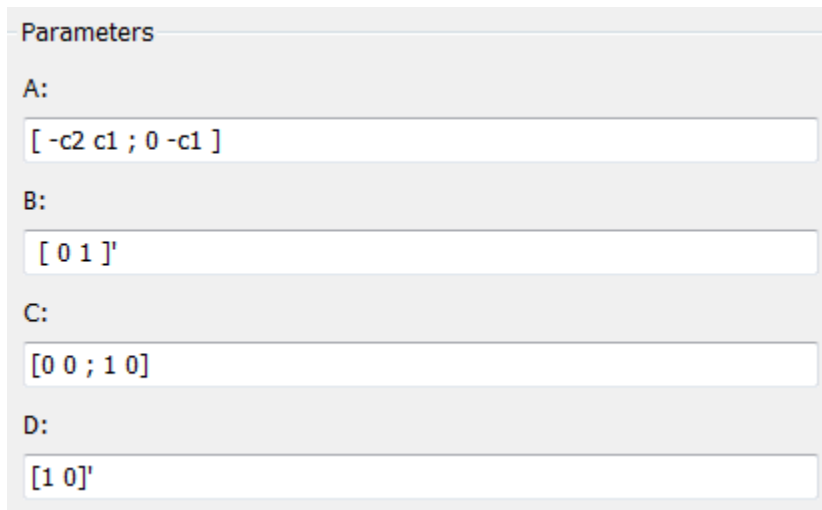

Parameters

A:  
 $[-c_2 \ c_1 ; 0 \ -c_1]$

B:  
 $[0 \ 1]'$

C:  
 $[0 \ 0 ; 1 \ 0]$

D:  
 $[1 \ 0]'$

- The output from the State-Space block is a vector that contains  $q_1$  and  $h_2$ .

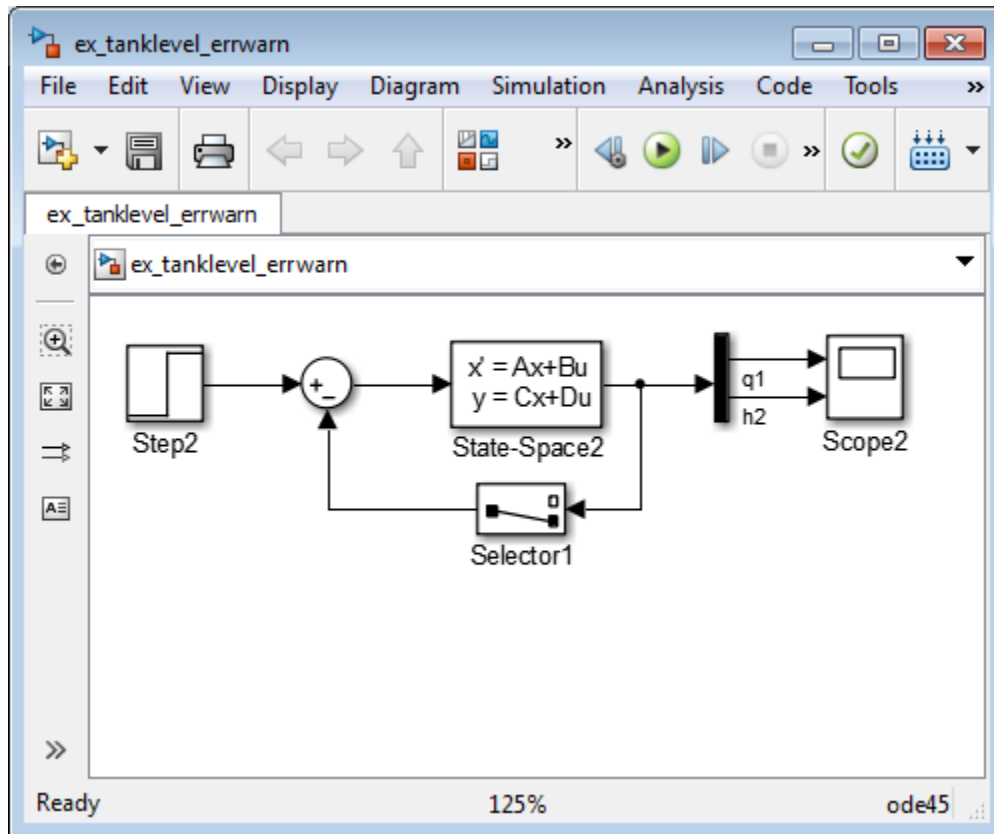

If you simulate this model with the **Algebraic loop** parameter set to warn or error, Simulink identifies the algebraic loop.

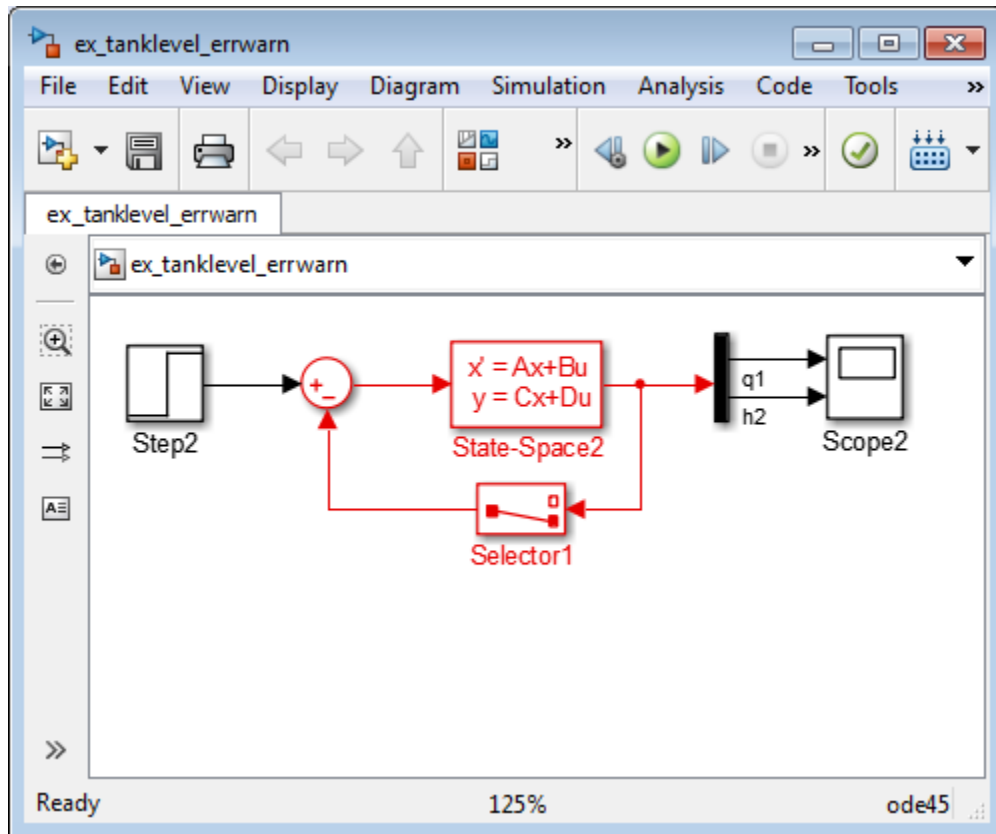

To eliminate this algebraic loop:

- 1 Change the C and D matrices as follows:

Parameters

A:  
[ -c2 c1 ; 0 -c1 ]

B:  
[ 0 1 ]'

C:  
[1 0]

D:  
0

- 2 Pass q1 directly to the Scope instead of through the State-Space block.

Now, the input (q1) does not pass directly to the output (the D matrix is 0), so the State-Space block no longer has direct feedthrough. The feedback signal has only one element now, so the Selector block is no longer necessary, as you can see in the following model.

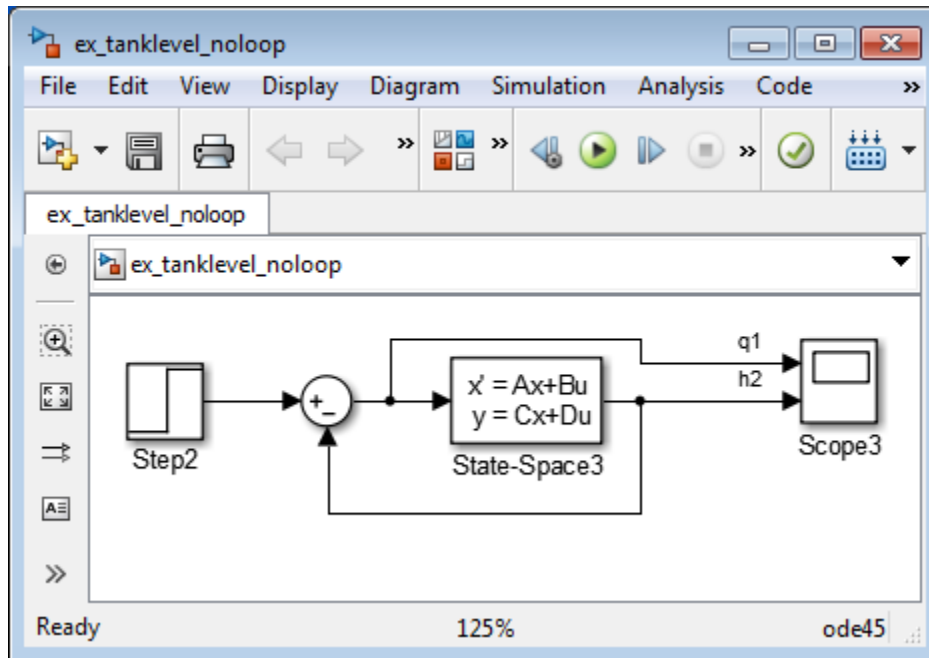

### Model and Block Parameters to Diagnose and Eliminate Artificial Algebraic Loops

There are two parameters to consider when you think that your model has an artificial algebraic loop:

- **Minimize algebraic loop occurrences** parameter — Specify that Simulink try to eliminate any artificial algebraic loops for:
  - Atomic subsystems — In the Subsystem Parameters dialog box, select **Minimize algebraic loop occurrences**.
  - Model blocks — For the referenced model, in the **Model Referencing** pane of Configuration Parameters, select **Minimize algebraic loop occurrences**.
- **Minimize algebraic loop** parameter — Specifies what diagnostic action Simulink takes if the **Minimize algebraic loop occurrences** parameter has no effect.

The **Minimize algebraic loop** parameter is in the **Diagnostics** pane of Configuration Parameters. The diagnostic actions for this parameter are:

Setting	Simulation Response
none	Simulink takes no action.
warning	Simulink displays a warning that the <b>Minimize algebraic loop occurrences</b> parameter has no effect.
error	Simulink terminates the simulation and displays an error that the <b>Minimize algebraic loop occurrences</b> parameter has no effect.

#### Block Reduction and Artificial Algebraic Loops

When you enable the **Block reduction** optimization in Model Configuration Parameters, Simulink collapses certain groups of blocks into a single, more efficient block, or removes them entirely. Enabling block reduction results in faster execution during model simulation and in generating code.

Enabling block reduction can also help Simulink solve artificial algebraic loops.

Consider the following example model.



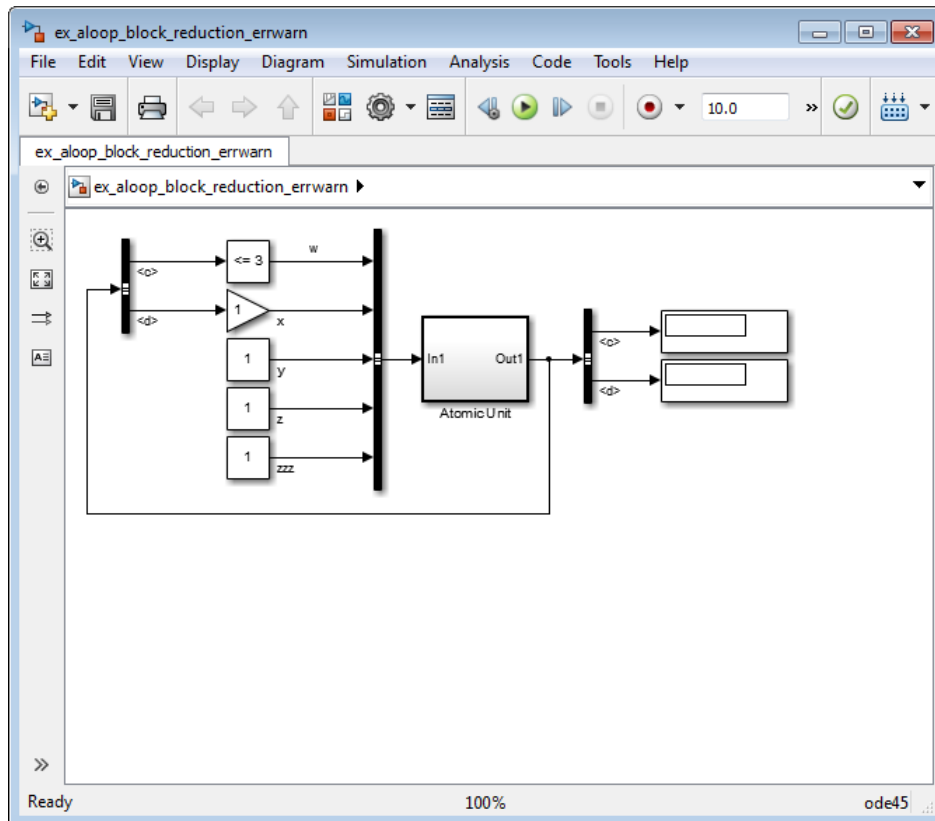

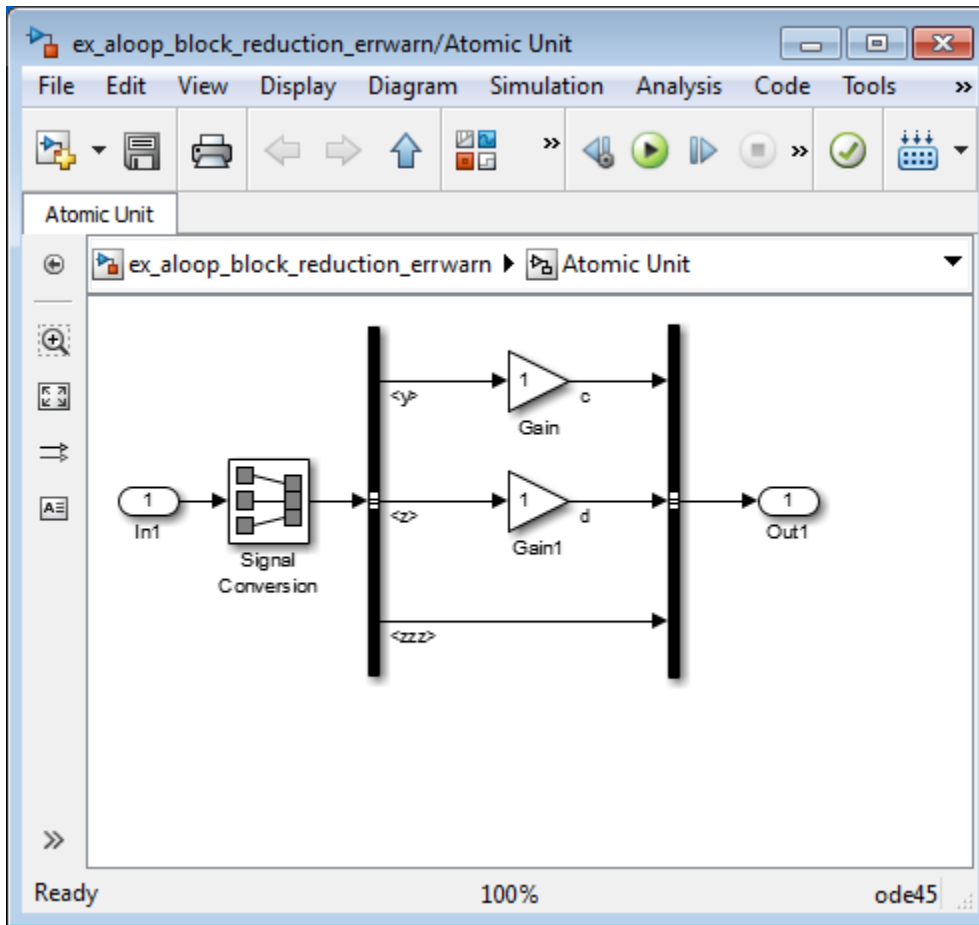

Initially, block reduction is turned off. When you simulate this model, the Atomic Unit subsystem and Gain and Compare to Constant blocks are part of an algebraic loop that Simulink cannot solve.

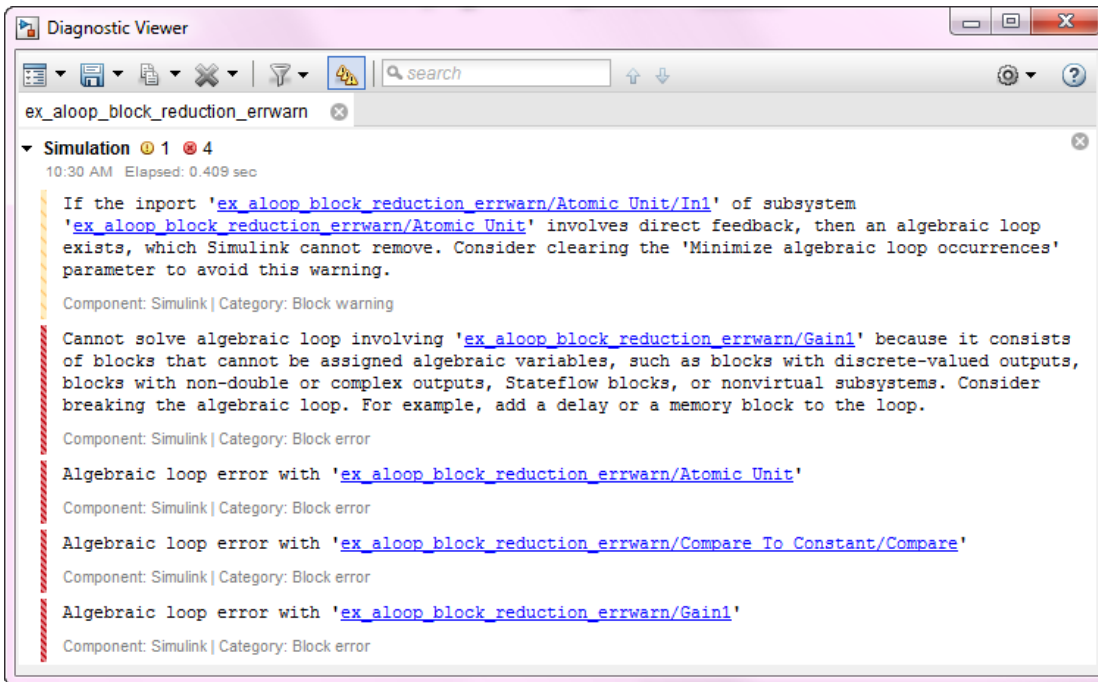

If you enable block reduction and sorted order, and resimulate the model, Simulink does not display the sorted order for blocks that have been reduced. You can now quickly see which blocks have been reduced.

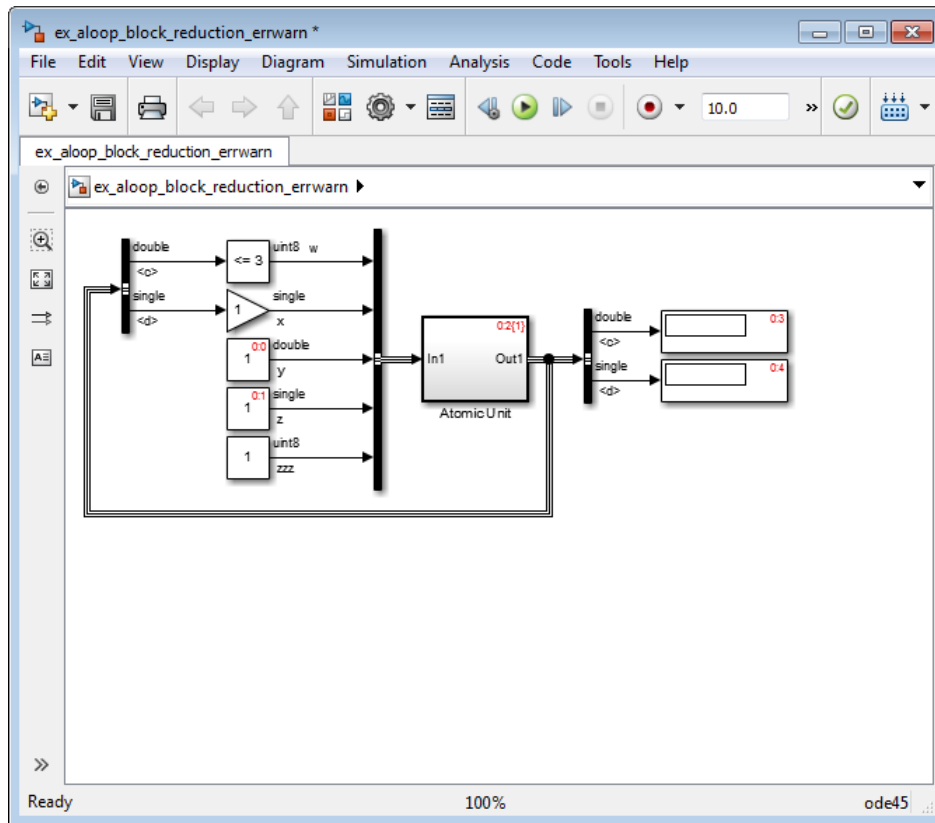

The Compare to Constant and Gain blocks have been eliminated from the model, so they no longer generate an algebraic loop error. The Atomic Unit subsystem generates a warning:

```
Warning: If the inport 'ex_aloop_block_reduction_errwarn/
Atomic Unit/In1' of subsystem 'ex_aloop_block_reduction_errwarn/
Atomic Unit' involves direct feedback, then an algebraic loop
exists, which Simulink cannot remove. Consider clearing the
'Minimize algebraic loop occurrences' parameter to avoid this
warning.
```

---

**Tip:** Use Bus Selector blocks to pass only the required signals into atomic subsystems.

---

## How Simulink Eliminates Artificial Algebraic Loops

When you enable **Minimize algebraic loop occurrences**, Simulink tries to eliminate artificial algebraic loops. In this example, the model contains an atomic subsystem that causes an artificial algebraic loop.

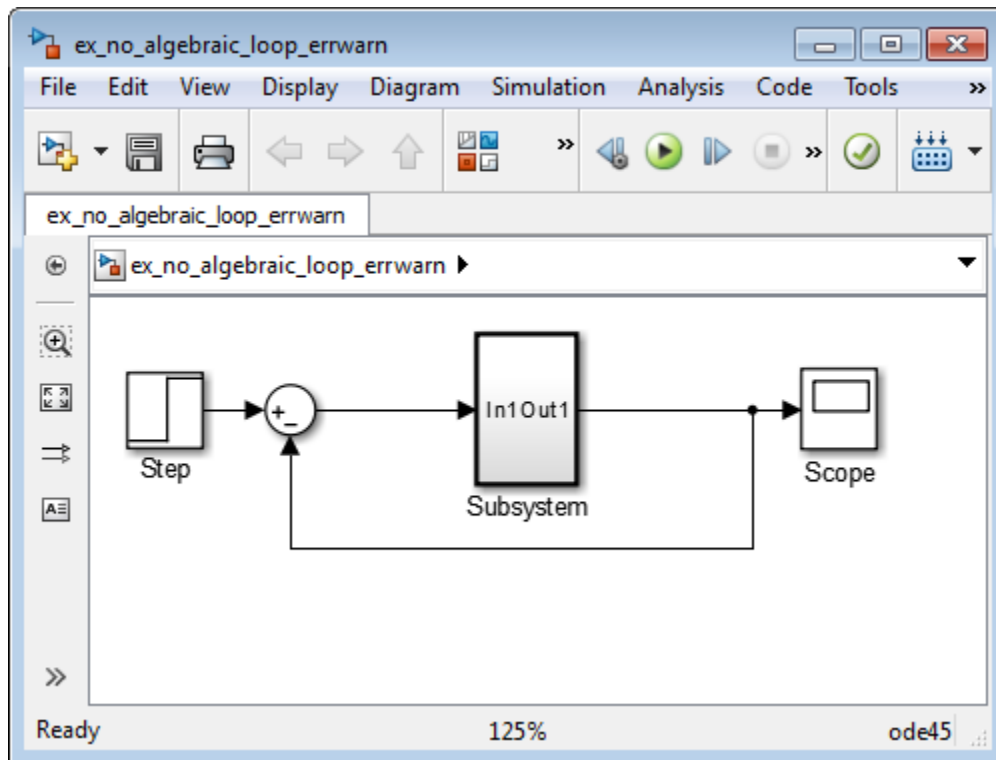

The contents of the atomic subsystem are not direct feedthrough, but Simulink identifies the atomic subsystem as direct feedthrough.

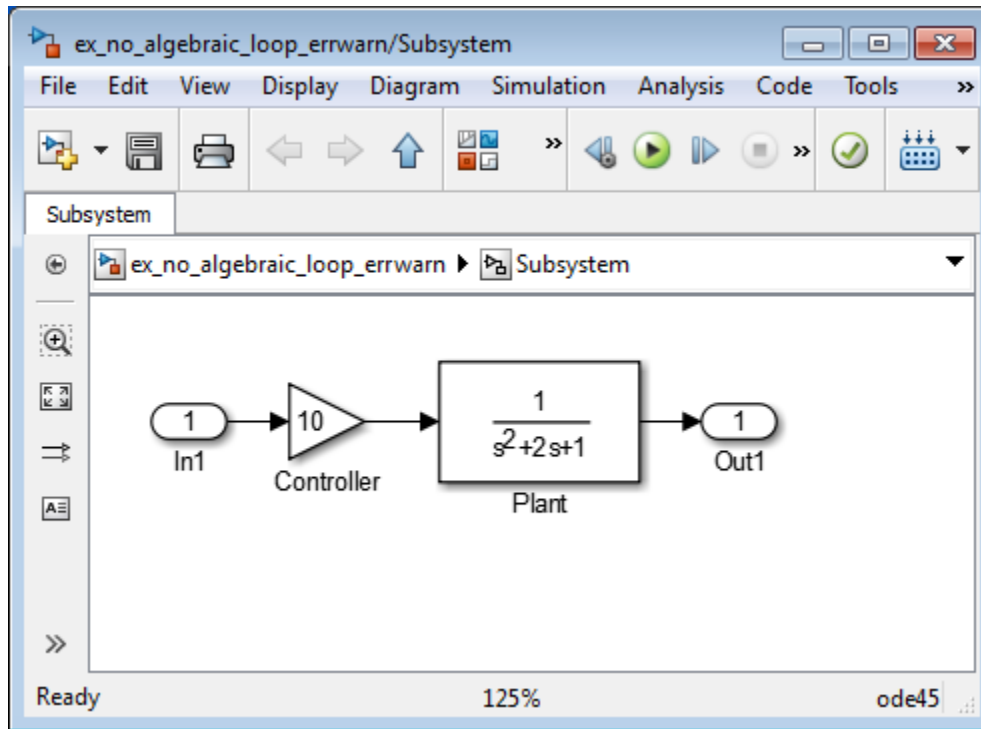

If the **Algebraic loop** diagnostic is set to error, simulating the model results in an error because the model contains an artificial algebraic loop involving its atomic subsystem.

To eliminate this algebraic loop,

- 1 Create the model from the preceding graphics, with the atomic subsystem that causes the artificial algebraic loop.
- 2 In the **Diagnostics** pane of Model Configuration Parameters, set the **Algebraic loop** parameter to warning or none.
- 3 In the **Data Import/Export** pane, make sure the **Signal logging** parameter is disabled. If signal logging is enabled, Simulink cannot eliminate artificial algebraic loops.
- 4 To display the sorted order for this model and the atomic subsystem, select **Display > Blocks > Sorted Execution Order**.

Reviewing the sorted order can help you understand how to eliminate the artificial algebraic loop.

All the blocks in the subsystem execute at the same level: 1. (0 is the lowest level, indicating the first blocks to execute.)

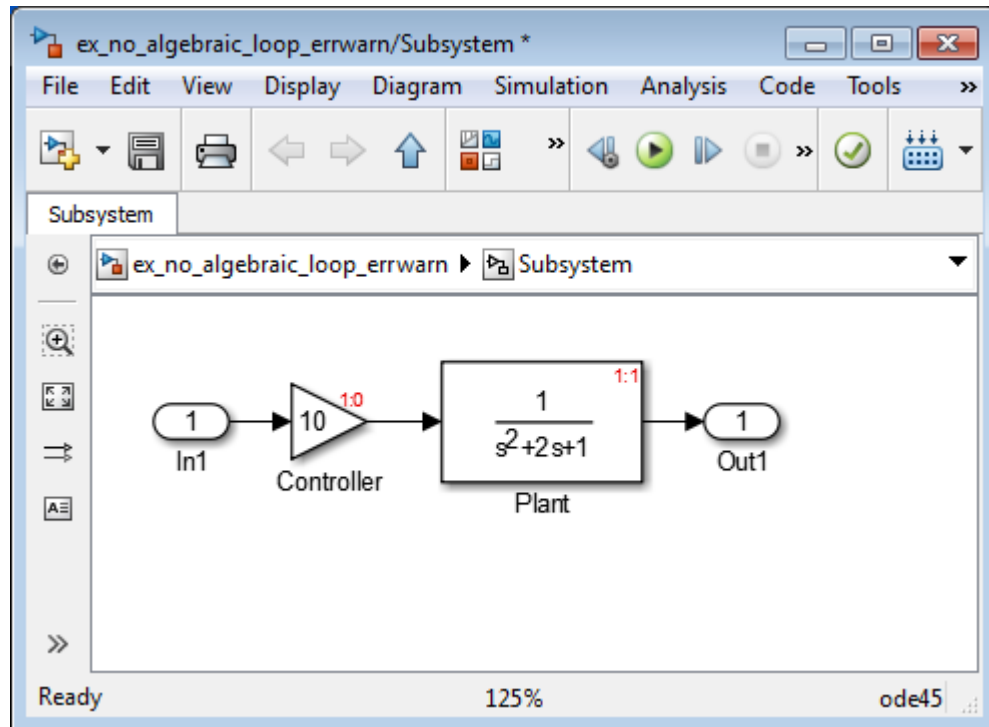

**Note:** For more information about sorted order, see “Control and Display the Sorted Order” on page 34-27.

- 5 In the top-level model’s **Subsystem Parameters** dialog box, select **Minimize algebraic loop occurrences**. This parameter directs Simulink to try to eliminate the algebraic loop that contains the atomic subsystem, when it simulates the model. Save the changes.
- 6 Click **Simulation > Update Diagram** to recalculate the sorted order.

Now there are two levels of sorted order inside the subsystem: 1 and 2.

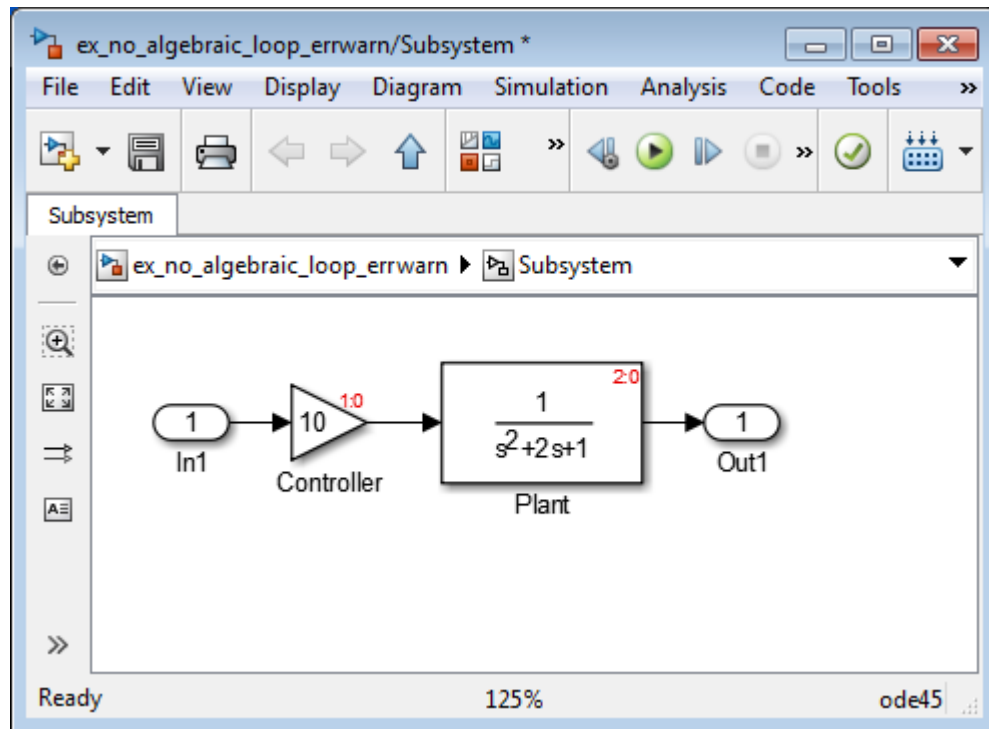

To eliminate the artificial algebraic loop, Simulink tries to make the input of the subsystem or referenced model non-direct feedthrough.

When you simulate a model, all blocks execute methods in this order:

- 1 mdlOutputs
- 2 mdlDerivatives
- 3 mdlUpdate

In the original version of this model, the execution of the `mdlOutputs` method starts with the Plant block because the Plant block is non-direct feedthrough. The execution finishes with the Controller block.



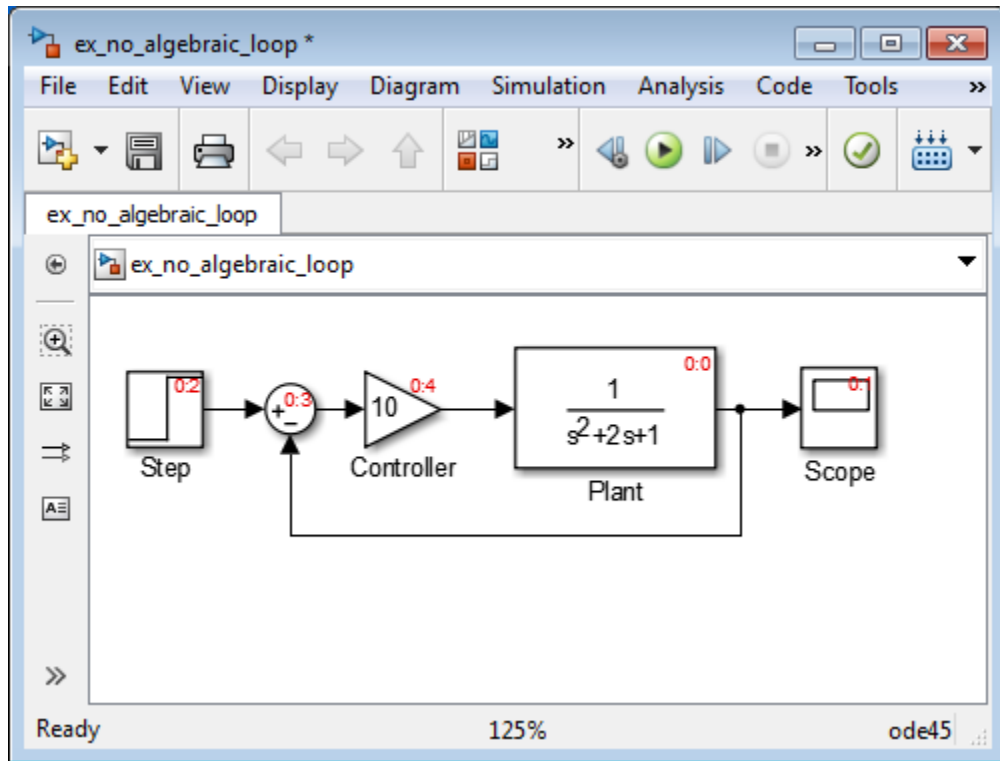

---

**Note:** For more information about these methods, see “Block Methods” on page 3-15.

---

If you enable the **Minimize algebraic loop occurrences** parameter for the atomic subsystem, Simulink divides the subsystem into two atomic units.

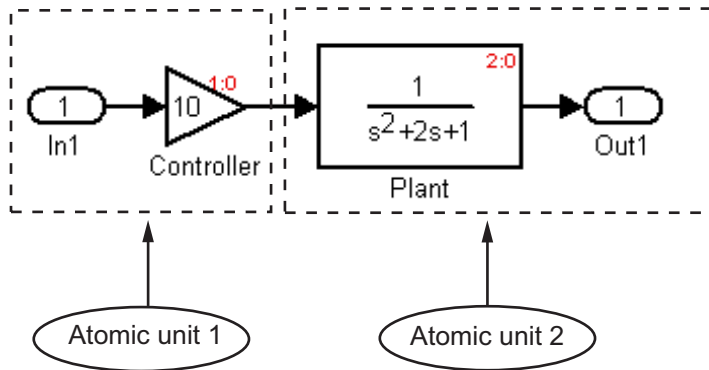

These conditions are true:

- Atomic unit 2 is not direct feedthrough.
- Atomic unit 1 has only a `mdlOutputs` method.

Only the `mdlDerivatives` or `mdlUpdate` methods of Atomic unit 2 need the output of Atomic unit 1. Simulink can execute what normally would have been executed during the `mdlOutput` method of Atomic unit 1 in the `mdlDerivatives` methods of Atomic unit 2.

The new execution order for the model is:

- 1 `mdlOutputs` method of model
  - a `mdlOutputs` method of Atomic unit 2
  - b `mdlOutputs` methods of other blocks
- 2 `mdlDerivatives` method of model
  - a `mdlOutputs` method of Atomic unit 1
  - b `mdlDerivatives` method of Atomic unit 2
  - c `mdlDerivatives` method of other blocks

For the **Minimize algebraic loop occurrences** technique to be successful, the subsystem or referenced model must have a non-direct-feedthrough block connected directly to an Inport. Simulink can then set the `DirectFeedthrough` property of the block Inport to `false` to indicate that the input port does not have direct feedthrough.

## When Simulink Cannot Eliminate Artificial Algebraic Loops

Setting the **Minimize algebraic loop occurrences** parameter does not always work. Simulink cannot change the `DirectFeedthrough` property of an Inport for an atomic subsystem if the Inport is connected to an Outport only through direct-feedthrough blocks.

In this model, the subsystem `Plant+Controller` causes an algebraic loop, but it has an extra Gain block and an extra output.

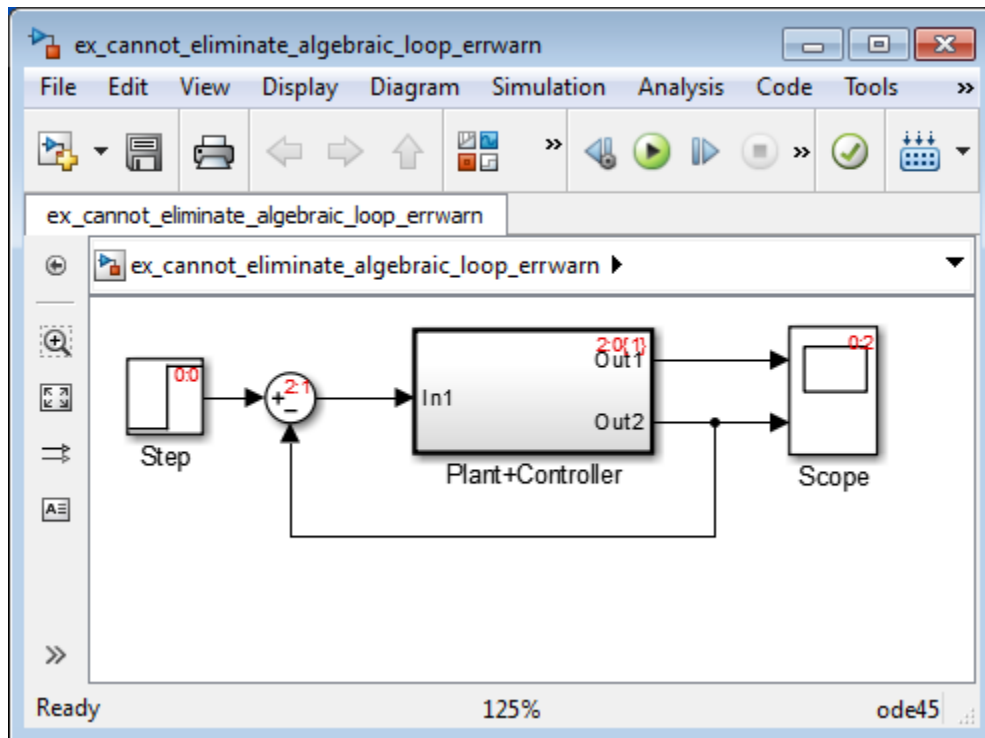

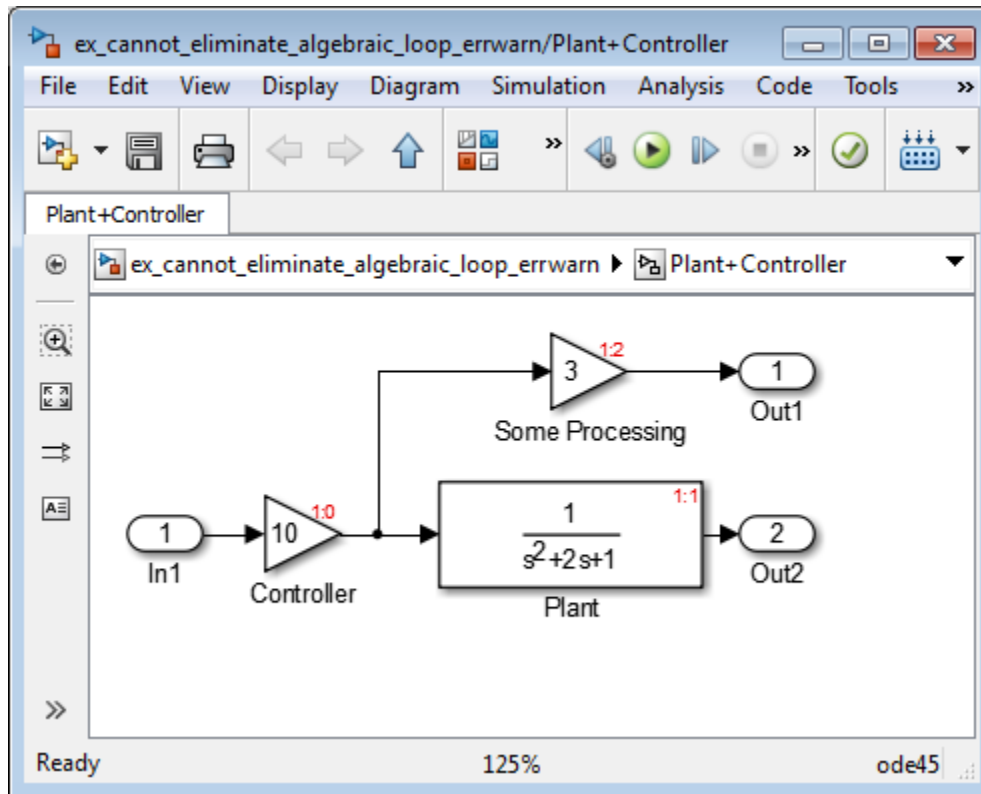

Simulink cannot move the `mdlOutputs` method of the Controller block to the `mdlDerivative` method of an Atomic unit 1 because the output of the atomic subsystem depends on the output of the Controller block. You cannot make the subsystem non-direct-feedthrough.

You can modify this model to eliminate the artificial algebraic loop by redefining the atomic subsystem by adding additional Inport and Gain blocks, as you can see in the model here. Doing so makes In1 non-direct-feedthrough and In2 direct feedthrough, thus breaking the algebraic loop.

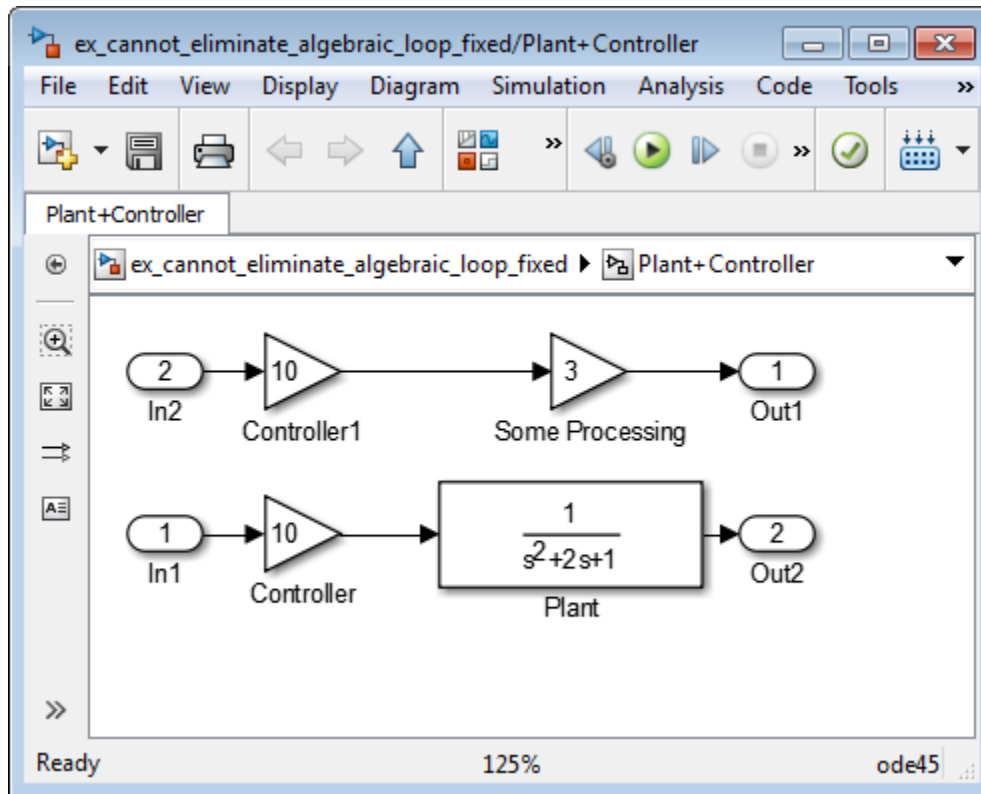

## Managing Large Models with Artificial Algebraic Loops

Adopt these design techniques for large models with algebraic loops:

- Avoid creating loops that contain discontinuities or nondouble data types. The Simulink algebraic loop solver is gradient-based and must solve algebraic constraints to high precision.
- Develop a scheme for clearly identifying atomic subsystems as direct feedthrough or not direct feedthrough. Use a visual scheme such as coloring the blocks or defining a block-naming convention.
- If you plan to generate code for your model, enable the **Minimize algebraic loop occurrences** parameter for all atomic subsystems. When possible, make sure that

the input ports for the atomic subsystems are connected directly to non-direct-feedthrough blocks.

- Avoid combining non-direct-feedthrough and direct-feedthrough paths using the Bus Creator or Mux blocks. Simulink may not be able to eliminate any resulting artificial algebraic loops. Instead, consider clustering the non-direct-feedthrough and direct-feedthrough objects in separate subsystems.

Use Bus Selector blocks to pass only the required signals into atomic subsystems.

### Changing Block Priorities When Using Algebraic Loop Solver

During the updating phase of simulation, Simulink determines the simulation execution order of block methods. This block invocation ordering is the *sorted order*.

If you assign priorities to nonvirtual blocks to indicate to Simulink their execution order relative to other blocks, the algebraic loop solver does not honor these priorities when attempting to solve any algebraic loops.

### See Also

“Solvers” on page 3-21 | “Zero-Crossing Detection” on page 3-24

# Modeling Dynamic Systems





# Creating a Model

---

- “Create a Template from a Model” on page 4-2
- “Describe Models Using Annotations” on page 4-3
- “Create an Annotation” on page 4-7
- “Show or Hide Annotations” on page 4-10
- “Add an Annotation Callback” on page 4-11
- “Create an Annotation Programmatically” on page 4-13
- “TeX for Simulink Model Annotations” on page 4-16
- “Create a Subsystem” on page 4-18
- “Configure a Subsystem” on page 4-23
- “Navigate Subsystems in the Model Hierarchy” on page 4-26
- “Subsystem Expansion” on page 4-30
- “Expand Subsystem Contents” on page 4-35
- “Use Control Flow Logic” on page 4-37
- “Callbacks for Customized Model Behavior” on page 4-46
- “Model Callbacks” on page 4-48
- “Block Callbacks” on page 4-52
- “Port Callbacks” on page 4-59
- “Callback Tracing” on page 4-60
- “Manage Model Versions and Specify Model Properties” on page 4-61
- “Model Discretizer” on page 4-68

# Create a Template from a Model

Create a Simulink template from a model to reuse or share the settings and contents of the model without copying the model each time. Create templates only from models that do not have external file dependencies (for example, model references, data dictionary, scripts, S-functions, or other file dependencies). If you want to include other dependent files, use a project template instead. See “Using Templates to Create Standard Project Settings” on page 16-41.

- 1 In the model, select **File > Export Model to > Template**.
- 2 In the Export *modelName* to Model Template dialog box, edit the template title and enter a description of the template.

When you use the template, the Simulink start page displays this title and description.

- 3 In the **Template file** box, select a file name and location for the template SLTX file.

---

**Tip:** Save the template on the MATLAB path to make it visible in the Simulink start page. If you save in a location that is not on the path, the new template is visible in the start page only in the current MATLAB session. Saving the template does not add the destination folder to the path.

---

- 4 (Optional) Specify a thumbnail image for the template by clicking **Change** and selecting an image file.
- 5 Click **Export**.

## See Also

`Simulink.exportToTemplate`

## Related Examples

- “Create a Model” on page 1-5
- “Use Customized Settings When Creating New Models” on page 1-8
- “Using Templates to Create Standard Project Settings” on page 16-41

## Describe Models Using Annotations

Annotations are visual elements that you can use to add descriptive notes and callouts to your model. You can also add annotations that perform an action when you click them. Shortcuts on the Simulink Editor palette help you to create annotations.

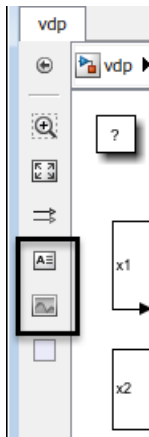

Text annotations can contain any combination of:

- Text
- Images
- Equations using TeX commands
- Hyperlinks that open a website or perform MATLAB functions

Also, you can create an annotation that can hold only an image.

### Add a Text Annotation

To create a text annotation, use one of these options:

- Double-click the canvas where you want to create the annotation.
- Click the annotation box  on the palette and then click the canvas.
- Drag the annotation box to the canvas.

After you add the text annotation, you can:

- Apply formatting changes to text or insert an image or a table using the formatting toolbar.
- Apply additional formatting, using the **Paragraph** menu on the context menu. For example, you can create bullet and numbered lists from this menu.
- Add hyperlinks using the context menu. You can use hyperlinks to open a website or make an annotation interactive using MATLAB commands.
- Apply properties using the Property Inspector. To view the Property Inspector, select **View > Property Inspector**.

### Resize an Annotation

An annotation resizes as you enter content. You can also resize an annotation by dragging the corners. For example, you can hold **Shift** as you drag to resize proportionally.

After you resize an annotation, the annotation stays that size until you resize it again, regardless of the content size. To revert to the original height or width of the annotation, in the Property Inspector, under **Appearance**, clear the **Fixed height** or **Fixed width** check box.

### Make an Annotation Interactive

To make the annotation interactive, use a hyperlink on any content of a text annotation.

- 1 In the annotation, select the content that you want to make interactive. To make the entire annotation interactive, select all the content.
- 2 Right-click and select **Hyperlink** from the context menu.
- 3 In the Hyperlink dialog box, either:
  - Select **URL Address** as the target and enter the web address in the **Code** box.
  - Select **MATLAB Code** as the target and enter MATLAB functions in the **Code** box.
- 4 Click **OK**.

For an alternative approach, see “Add an Annotation Callback” on page 4-11

## Add an Image Annotation

You can add an annotation that contains only an image. Add an image annotation when you want to be able to resize or move the image independently of text. For example, you can put your company logo in an image and size and position it at a particular location in the model. You can also associate MATLAB functions with a click on the image.

---

**Tip:** To include an image such as a logo in every new model, add the image to your default template. See “Create a Template from a Model” on page 4-2.

---

- 1 From the Simulink Editor palette, drag an **Image** box  into the model.
- 2 Add an image to the box. You can either:
  - Double-click the image box and browse to an image.
  - Paste an image from the clipboard. Right-click the image box and select **Paste Image**.

---

**Tip:** If you resize the image, you can reset it to its original size. Right-click the image and select **Format > Restore Size**.

---

To associate an action with an image:

- 1 Select the image.
- 2 In the Property Inspector, under **ClickFcn**, add the MATLAB functions that you want to invoke with a click on the image.

## Use TeX Commands in an Annotation

You can add TeX formatting commands to your annotation for mathematical and other symbols and Greek letters. For the supported TeX commands, see “TeX for Simulink Model Annotations” on page 4-16

- 1 Add supported TeX commands to your annotation. For example, add this text:  
`\sigma \kappa \mu`
- 2 With the annotation selected, or with the text cursor in the annotation, in the Property Inspector, under **Appearance**, select **Enable TeX commands**.

When you click outside the annotation, the TeX commands appear as symbols in the annotation.

### Add Lines to Connect Annotations to Blocks

You can add connector lines between an annotation and a block in the model. The connector is similar to a callout, identifying the block that an annotation applies to. If you move the annotation or block, the connector moves or resizes to keep the connection.

- 1 Place the cursor over the annotation outline where you want the connector to start.
- 2 When the cursor is a cross hair, drag the connector line to the block you want to connect to.

---

**Tip:** To specify the color or width of the connector, right-click it and use the **Format** menu.

---

### Select Font Dialog Box on Linux Machines

On Linux machines configured for English, the **Font style** list in the Select Font dialog box can appear out of order and in another language in some fonts. If the characters in your **Font style** list appear in another language, set the `LANG` environment variable to `en_US.utf-8` before you start MATLAB. For example, at a Linux terminal, enter:

```
setenv LANG en_US.utf-8
matlab
```

### Related Examples

- “Create an Annotation” on page 4-7
- “Show or Hide Annotations” on page 4-10
- “Add an Annotation Callback” on page 4-11
- “Create an Annotation Programmatically” on page 4-13

## Create an Annotation

In this example, you create this annotation:

### Foucault Pendulums

This model represents a [Foucault pendulum](#).

The pendulum can be modeled as a point mass suspended on a wire of length  $L$ . The pendulum is located at the geographical latitude  $\lambda$ . It is convenient to use these reference frames:

- The inertial frame I (relative to the center of the Earth).
- The non-inertial frame N (relative to an observer on Earth's surface). The non-inertial frame accelerates as a result of rotation.

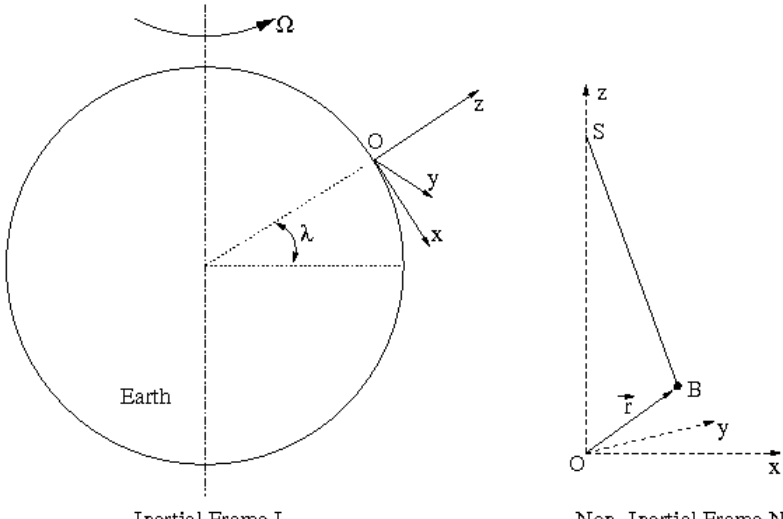

Inertial Frame I Non-Inertial Frame N

### Interact with the Model

1. Open the model.
2. Use MATLAB workspace variables to examine and modify initial conditions ( $g$ ,  $L$ , initial conditons,  $\Omega$ , and  $\lambda$ ).
3. Simulate the model.

## Add and Lay Out an Annotation

- 1 Open the `sldemo_foucault` model.
- 2 Open the Property Inspector if it is not open. Select **View** > **Property Inspector**.
- 3 Delete the two annotations below the model.

- 4 Double-click to add an annotation, and type **Background**.
- 5 Drag a corner to resize the annotation so that it is about the width of the model and about twice as tall.
- 6 In the Property Inspector, under **Appearance**, select **Shadow**. Under **Internal Margin**, set each of the margins to 10.

### Add a Hyperlink and Format Text

- 1 To create a blank line and a new paragraph, place the cursor after the word **Background** and press **Enter** twice.
- 2 Enter this text: This model represents a Foucault pendulum.
- 3 Select the text **Foucault pendulum** and select **Hyperlink** from the context menu.
- 4 In the Hyperlink dialog box, in the **Code** box, enter `en.wikipedia/wiki/Foucault_pendulum` and click **OK**.
- 5 Select the text **Background**. Using the formatting toolbar, make the text bold and font size 12.

### Add a Bullet List

- 1 Place the cursor at the end of the paragraph with the hyperlink and press **Enter** twice.
- 2 In the new paragraph, add this text:

The pendulum can be modeled as a point mass suspended on a wire of length  $L$ . The pendulum is located at the geographical latitude  $\lambda$ . It is convenient to use these reference frames:
- 3 Press **Enter**. Type **\*** and press the spacebar to start a bullet list.
- 4 In the bullet item, enter:

The inertial frame  $I$  (relative to the center of the Earth).
- 5 Press **Enter**. For the second bullet, enter this text and press **Enter**.

The non-inertial frame  $N$  (relative to an observer on Earth's surface). The non-inertial frame accelerates as a result of rotation.
- 6 Delete the empty bullet.



## Copy and Paste a Web Image

- 1 In an SVG-enabled browser (such as Google<sup>®</sup> Chrome), open the Foucault pendulum example.

`http://www.mathworks.com/help/simulink/examples/modeling-a-foucault-pendulum.html`

- 2 In the Analysis and Physics section, copy the image of the two frames.
- 3 In the annotation, place the cursor in a new paragraph below the second bullet. Paste the image.

## Add a Numbered List

- 1 Place the cursor after the image and press **Enter** twice.
- 2 In the new paragraph, enter `Interact with the Model`. Press **Enter** twice.
- 3 In the new paragraph, right-click and select **Paragraph > Numbering > Decimal Dot**.
- 4 For the first step, enter `Open the model`.
- 5 For the second step, enter:

`Use MATLAB workspace variables to examine and modify initial conditions (g, L, init`

- 6 For the third step, enter `Simulate the model`.
- 7 Select the text `Interact with the Model`. Using the formatting toolbar, make the text bold and set the size to 12.

## Related Examples

- “Describe Models Using Annotations” on page 4-3
- “Show or Hide Annotations” on page 4-10
- “Add an Annotation Callback” on page 4-11
- “Create an Annotation Programmatically” on page 4-13

# Show or Hide Annotations

<b>In this section...</b>
“Configure an Annotation for Hiding” on page 4-10
“Hide Markup Annotations” on page 4-10

By default, all annotations appear in the model. To hide an annotation, first configure it for hiding by converting it to markup. Then select **Display > Hide Markup**.

## Configure an Annotation for Hiding

You can configure an annotation so that you can hide or display it.

- 1 Right-click the annotation.
- 2 From the context menu, select **Convert to Markup**.

A markup annotation has a light-blue background, regardless of the background color you set. If you change a markup annotation back to a regular annotation, the annotation returns to the background color you set.

To change a markup annotation to a regular annotation (one that you cannot hide), from the annotation context menu, select **Convert to Annotation**.

## Hide Markup Annotations

To hide all markup annotations, select **Display > Hide Markup**.

To display hidden markup annotations, select **Display > Show Markup**.

---

**Note:** In a model reference hierarchy, **Show Markup** and **Hide Markup** apply only to the current model reference level.

---

## Related Examples

- “Describe Models Using Annotations” on page 4-3

# Add an Annotation Callback

**In this section...**

“Annotation Callback Functions” on page 4-11

“Associate a Click Function with an Annotation” on page 4-11

“Select and Edit Click-Function Annotations” on page 4-12

## Annotation Callback Functions

You can associate these callback functions with annotations.

### Click Function

You can make an annotation interactive using a link. Alternatively, you can make an annotation interactive by adding a click function callback. A click function is a MATLAB function that Simulink invokes when you click an annotation.

You can add a click function callback programmatically or interactively. To create this association programmatically, see “Annotations API” on page 4-13. To create one interactively, see “Associate a Click Function with an Annotation” on page 4-11.

The text for annotations associated with a click function appears in blue.

### Load Function

Simulink invokes a load function when you load the model that contains the associated annotation. To associate a load function with an annotation, set the `LoadFcn` property of the annotation to the desired function (see “Annotations API” on page 4-13).

### Delete Function

A delete function is invoked before you delete an annotation. To associate a delete function with an annotation, set the `DeleteFcn` property of the annotation to the desired function (see “Annotations API” on page 4-13).

## Associate a Click Function with an Annotation

You can interactively associate a click function with an annotation.

- 1 Add an annotation.
- 2 Open the Annotation Properties dialog box. Right-click the annotation and select **Properties**.
- 3 Open the **ClickFcn** tab. In the text box under **ClickFcn**, enter the MATLAB code that defines the click function, and click **OK**.

---

**Tip:** Alternatively, you can use the annotation text as the click function. Then, in the Annotation Properties dialog box, select the **Use annotation text as click callback** check box.

---

### Select and Edit Click-Function Annotations

If you associate an annotation with a click function, clicking invokes the function rather than selecting the annotation. To select it instead, drag a selection box around it. To edit it, right-click it and select **Edit Text** or **Properties**.

### More About

- “Describe Models Using Annotations” on page 4-3

## Create an Annotation Programmatically

### In this section...

“Annotations API” on page 4-13

“Create Annotations Programmatically” on page 4-13

“Delete an Annotation Programmatically” on page 4-14

“Find Annotations in a Model” on page 4-14

“Show or Hide Annotations Programmatically” on page 4-14

### Annotations API

Use MATLAB code to get and set the properties of annotations.

- `Simulink.Annotation` class

Set the properties of annotations.

- `getCallbackAnnotation` function

Get the `Simulink.Annotation` object for the annotation associated with the currently executing annotation callback function. Use this function to determine which annotation invoked the current callback. This function is also useful if you write a callback function in a separate MATLAB file that contains multiple callback calls.

### Create Annotations Programmatically

To create annotations at the command line or in a MATLAB program, use the `add_block` command. For example:

```
open_system('vdp');
block = add_block('built-in/Note', ...
    'vdp/This simulates a nonlinear second order system', ...
    'Position', [200 250])
```

Alternatively, you can use a `Simulink.Annotation` object to create an annotation. For example:

```
open_system('vdp')
```

```
note = Simulink.Annotation('vdp/This is an annotation');  
note.position = [10,50]
```

### Delete an Annotation Programmatically

To delete an annotation programmatically, use the `find_system` function to get the annotation handle. Then use the `delete` function to delete the annotation. For example:

```
delete(find_system(gcs, 'FindAll', 'on', 'type', 'annotation',...  
'text', 'programmatically created'));
```

### Find Annotations in a Model

Use command such as this to find all of the annotations in a model.

```
open_system('vdp')  
annotations = find_system(gcs, 'FindAll', 'on', 'Type', 'annotation')  
  
annotations =  
  
    34.0004  
    33.0009
```

See the `find_system` documentation for specifying levels of the model to search.

To identify the annotation handle of annotations, enter:

```
get_param(annotations, 'Name')  
  
ans =  
  
    'Copyright 2004-2014 The MathWorks, Inc.'  
    'van der Pol Equation'
```

### Show or Hide Annotations Programmatically

When you create an annotation, by default it appears in the model. You can configure an annotation to be a markup annotation, which you can hide.

To find out whether the first annotation is a markup annotation, use commands such as this:

```
open_system('vdp')
```

```
annotations = find_system(gcs, 'FindAll', 'on', 'Type', 'annotation')
get_param(annotations(1), 'MarkupType')
```

To configure the first annotation in a model so that it can be hidden, use a commands such as this:

```
set_param(annotations(1), 'MarkupType', 'markup')
```

To reconfigure that annotation to always appear, use this command:

```
set_param(annotations(1), 'MarkupType', 'model')
```

To find out whether a model is configured to show or hide markup annotations, use a command such as this for the `vdp` model:

```
get_param(vdp, 'ShowMarkup')
```

To configure a model to hide markup annotations, use a command such as this for the `vdp` model:

```
set_param(vdp, 'ShowMarkup', 'off')
```

## Related Examples

- “Describe Models Using Annotations” on page 4-3
- “Create an Annotation” on page 4-7
- “Add an Annotation Callback” on page 4-11

## TeX for Simulink Model Annotations

The table shows the TeX characters supported in Simulink annotations.

Supported TeX Characters		
alpha	forall	supseteq
beta	exists	supset
gamma	ast	subseteq
delta	cong	subset
epsilon	sim	int
zeta	leq	in
eta	infty	o
theta	clubsuit	copyright
vartheta	diamondsuit	0
iota	heartsuit	ldots
kappa	spadesuit	varpi
lambda	leftarrow	times
mu	uparrow	cdot
nu	rightarrow	vee
xi	downarrow	wedge
pi	circ	perp
rho	pm	mid
sigma	geq	Leftarrow
varsigma	propto	Rightarrow



Supported TeX Characters		
tau	partial	Uparrow
upsilon	bullet	Downarrow
phi	div	prime
chi	neq	nabla
psi	equiv	surd
omega	approx	angle
Gamma	aleph	neg
Delta	Im	lceil
Theta	Re	rceil
Lambda	otimes	lfloor
Xi	oplus	rfloor
Pi	oslash	langle
Sigma	cap	rangle
Upsilon	cup	
Phi		
Psi		
Omega		

# Create a Subsystem

### In this section...

“Subsystem Advantages” on page 4-18

“Ways to Create a Subsystem” on page 4-18

“Create a Subsystem in a Subsystem Block” on page 4-19

“Create a Subsystem from Selected Blocks” on page 4-20

“Create a Subsystem Using Context Options” on page 4-21

## Subsystem Advantages

Subsystems allow you to create a hierarchical model comprising many layers. A subsystem is a set of blocks that you replace with a single Subsystem block. As your model increases in size and complexity, you can simplify it by grouping blocks into subsystems. Using subsystems:

- Establishes a hierarchical block diagram, where a Subsystem block is on one layer and the blocks that make up the subsystem are on another
- Keeps functionally related blocks together
- Helps reduce the number of blocks displayed in your model window

When you make a copy of a subsystem, that copy is independent of the source subsystem. To reuse the contents of a subsystem across a model or across models, use either model referencing or a library.

## Ways to Create a Subsystem

You can create a subsystem using these approaches:

- Add a Subsystem block to your model, and then open the block and add blocks to the subsystem window. “Create a Subsystem in a Subsystem Block” on page 4-19.
- Select the blocks that you want in the subsystem, and from the right-click context menu, select **Create Subsystem from Selection**. “Create a Subsystem from Selected Blocks” on page 4-20.
- Copy a model to a subsystem. In the Simulink Editor, copy and paste the model into a subsystem window, or use `Simulink.BlockDiagram.copyContentsToSubsystem`.
- Copy an existing Subsystem block to a model.

- Drag a box around the blocks you want in a subsystem, and select the type of subsystem you want from the context options. “Create a Subsystem Using Context Options” on page 4-21.

## Create a Subsystem in a Subsystem Block

Add a Subsystem block to the model, and then add the blocks that make up the subsystem.

- 1 Copy the Subsystem block from the Ports & Subsystems library into your model.
- 2 Open the Subsystem block by double-clicking it.
- 3 In the empty subsystem window, create the subsystem contents. Use Inport blocks to represent input from outside the subsystem and Output blocks to represent external output.

For example, this subsystem includes a Sum block and Inport and Output blocks to represent input to and output from the subsystem.

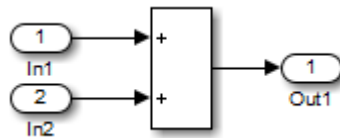

When you close the subsystem window, the Subsystem block includes a port for each Inport and Output block.

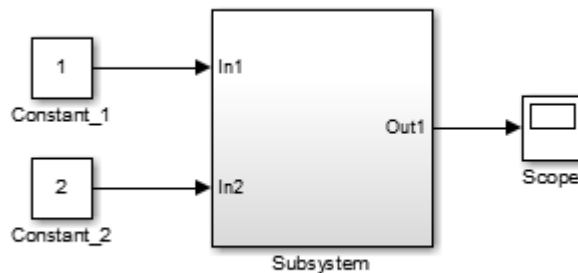

## Create a Subsystem from Selected Blocks

- 1 Select the blocks that you want to include in a subsystem. To select multiple blocks in one area of the model, drag a bounding box that encloses the blocks and connecting lines that you want to include in the subsystem.

The figure shows a model that represents a counter. The bounding box selects the Sum and Unit Delay blocks.

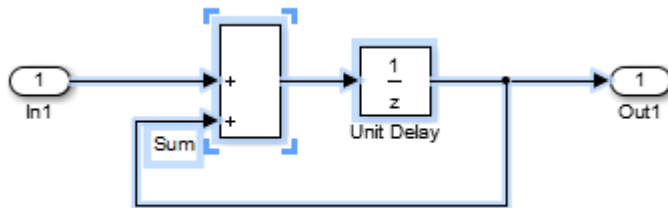

- 2 Select **Diagram > Subsystems & Model Reference > Create Subsystem from Selection**.

A Subsystem block appears, which encloses the selected blocks.

---

**Tip:** Resize the Subsystem block so the port labels are readable.

---

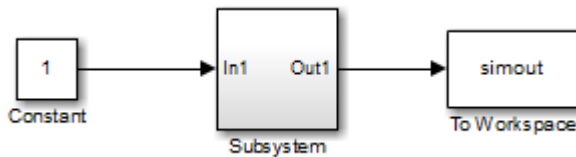

To edit the subsystem contents, open the Subsystem block. For example:

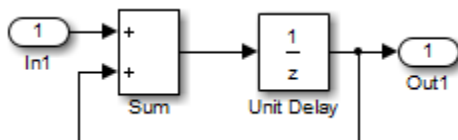

adds Inport and Outport blocks to represent input from and output to blocks outside the subsystem.

You can change the name of the Subsystem block and modify the block the way that you do with any other block (for example, you can mask the subsystem).

## Create a Subsystem Using Context Options

- 1 Drag a box around the blocks you want in your subsystem.

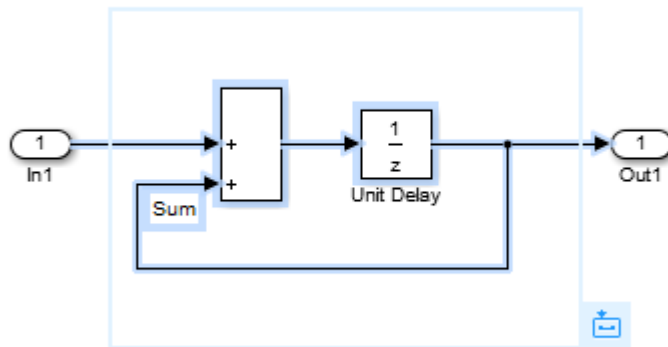

- 2 View the subsystems you can create with these blocks by hovering over the first context option that appears.

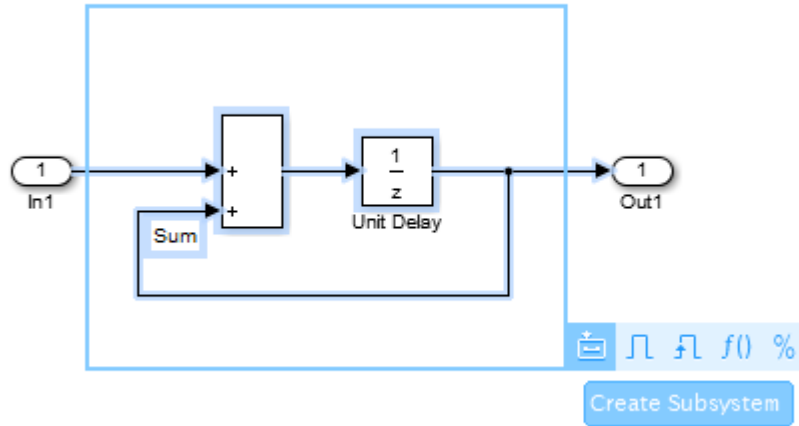

3 Select the type of subsystem you want to create from these options.

A Subsystem block appears, which encloses the selected blocks.

---

**Note:** You can create only enabled, triggered, virtual, and function-call subsystems using this method.

---

### Related Examples

- “Configure a Subsystem” on page 4-23
- “Navigate Subsystems in the Model Hierarchy” on page 4-26

### More About

- “Componentization Guidelines” on page 15-29
- “Subsystem Expansion” on page 4-30
- “Conditionally Executed Subsystems”

# Configure a Subsystem

## In this section...

“Subsystem Execution” on page 4-23

“Label Subsystem Ports” on page 4-23

“Control Access to Subsystems” on page 4-23

“Control Subsystem Behavior with Callbacks” on page 4-24

## Subsystem Execution

You can configure a subsystem to execute either conditionally or unconditionally.

- An unconditionally executed subsystem always executes.
- A conditionally executed subsystem executes based on the value of an input signal. For details, see “Conditionally Executed Subsystems”.

## Label Subsystem Ports

By default, Simulink labels ports on a Subsystem block. The labels are the names of the Inport and Outport blocks that connect the subsystem to blocks outside of the subsystem.

You can specify how Simulink labels the ports of a subsystem.

- 1 Select the Subsystem block.
- 2 Select one of the labeling options from **Diagram > Format > Port Labels** menu (for example, From Port Block Name).

## Control Access to Subsystems

You can control user access to subsystems. For example, you can prevent a user from viewing or modifying the contents of a library subsystem while still allowing the user to employ the subsystem in a model.

---

**Note:** This method does not necessarily prevent a user from changing the access restrictions. To hide proprietary information that is in a subsystem, consider using protected model referencing models (see “Protected Model” on page 8-90).

---

To restrict access to a library subsystem, open the subsystem parameter dialog box and set **Read/Write permissions** to one of these values:

- **ReadOnly**: A user can view the contents of the library subsystem but cannot modify the reference subsystem without disabling its library link or changing its **Read/Write permissions** to **ReadWrite**.
- **NoReadOrWrite**: A user cannot view the contents of the library subsystem, modify the reference subsystem, or change reference subsystem permissions.

Both options allow a user to use the library subsystem in models by creating links (see “Libraries”). For more information about subsystem access options, see the Subsystem block.

---

**Note:** You do not receive a response if you attempt to view the contents of a subsystem whose **Read/Write permissions** parameter is set to **NoReadOrWrite**. For example, when double-clicking such a subsystem, Simulink does not open the subsystem and does not display any messages.

---

## Control Subsystem Behavior with Callbacks

You can use block callbacks to perform actions in response to subsystem modeling actions such as:

- Handling an error
- Deleting a block or line in a subsystem
- Closing a subsystem

For details, see “Specify Block Callbacks” on page 34-5.

## See Also

Subsystem

## Related Examples

- “Create a Subsystem” on page 4-18
- “Protected Model” on page 8-90



## **More About**

- “Conditionally Executed Subsystems”
- “Specify Block Callbacks” on page 34-5
- “Libraries”

## Navigate Subsystems in the Model Hierarchy

### Open a Subsystem

Subsystems allow you to create a hierarchical model comprising many layers. You can navigate this hierarchy using the “Explore the Model Hierarchy Using the Model Browser” on page 12-48 or with Simulink Editor model navigation commands.

To open a subsystem using the Simulink Editor context menu for the Subsystem block:

- 1 In the Simulink Editor, right-click the Subsystem block.

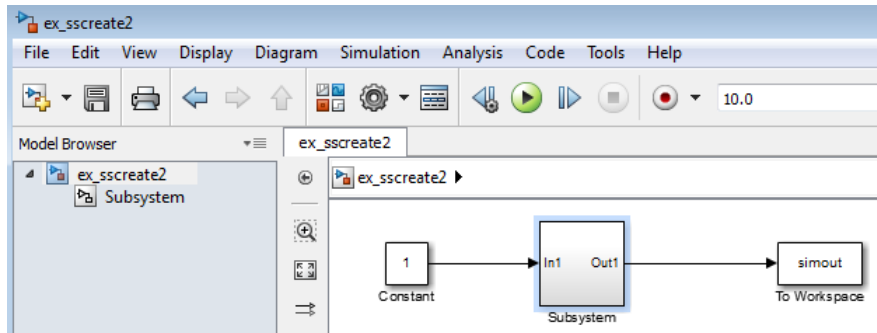

- 2 From the context menu, select one of these options:
  - **Open** — Open the subsystem, in the same window and tab as used for the top model.

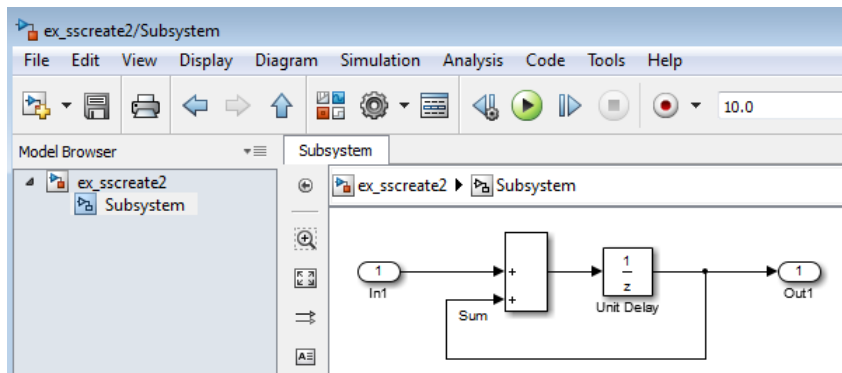

- **Open In New Tab** — Open the subsystem, creating an additional tab for the subsystem.

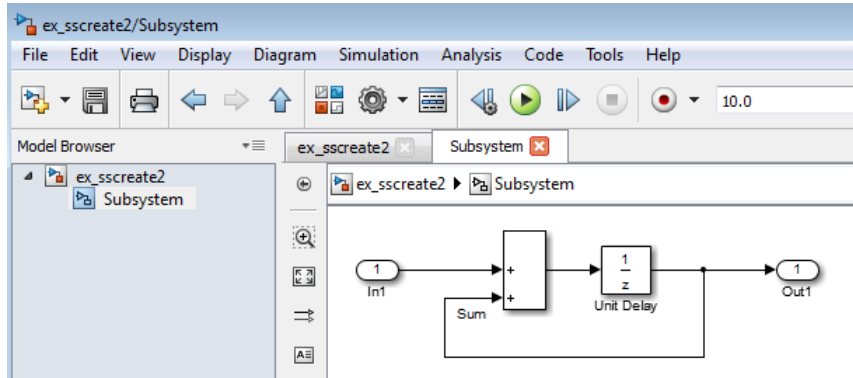

- **Open In New Window** — Open the subsystem, opening a new Simulink Editor window.

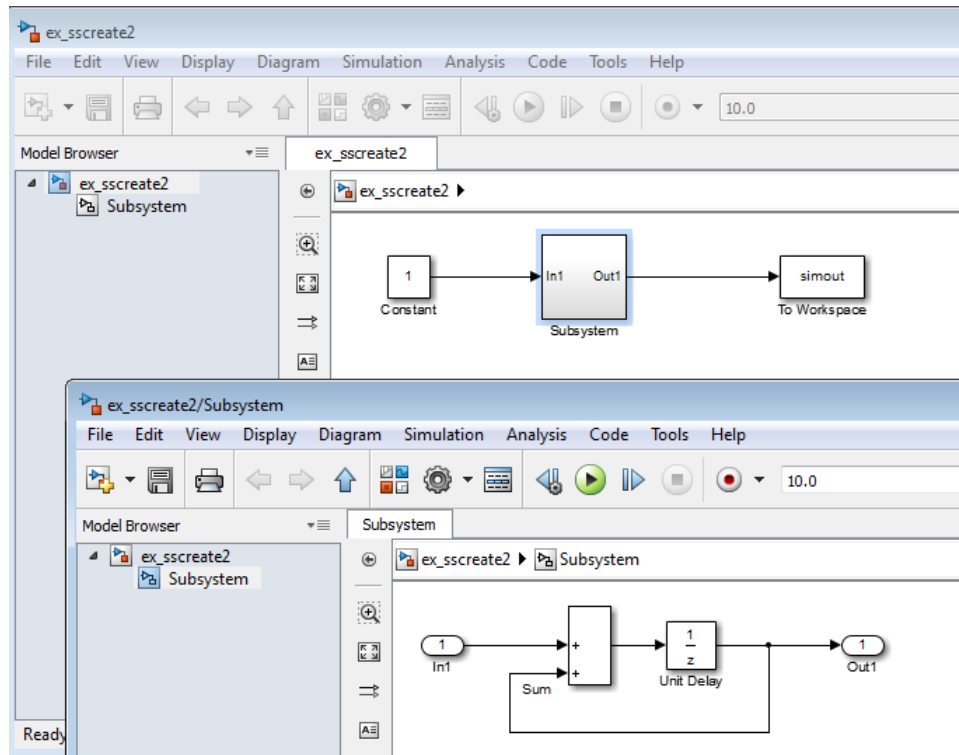

For any operation to open a subsystem, you can use a keyboard shortcut to have the subsystem open in a new tab or window:

Where to Open the Subsystem	Keyboard Shortcut
In a new tab	Hold the <b>CTRL</b> key while opening the subsystem.
In a new window	Hold the <b>SHIFT</b> key while opening the subsystem.

**Tip:** To navigate up and out of a subsystem, select **View > Navigate > Up to Parent**. The subsystem you navigated from appears highlighted so you can identify where you came from.

## **Related Examples**

- “Preview Content of Hierarchical Items” on page 1-58

## Subsystem Expansion

### In this section...

“What Is Subsystem Expansion?” on page 4-30

“Why Expand a Subsystem?” on page 4-31

“Subsystems That You Can Expand” on page 4-32

“Results of Expanding a Subsystem” on page 4-32

“Data Stores” on page 4-33

### What Is Subsystem Expansion?

Subsystem expansion involves moving the contents of a virtual subsystem into the system that contains that subsystem.

For example, the `sldemo_enginewc` model includes the Combustion subsystem.

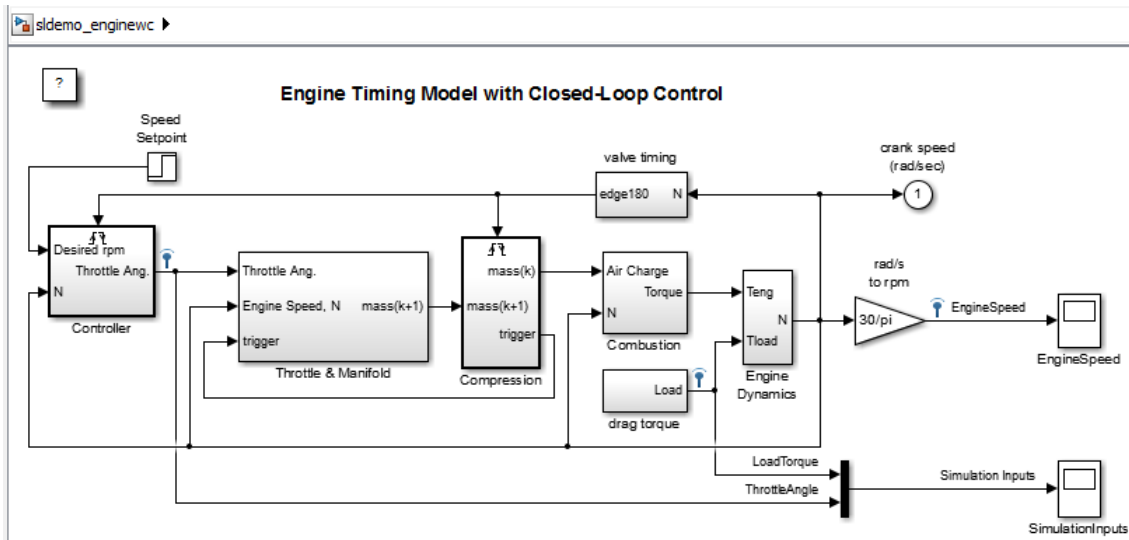

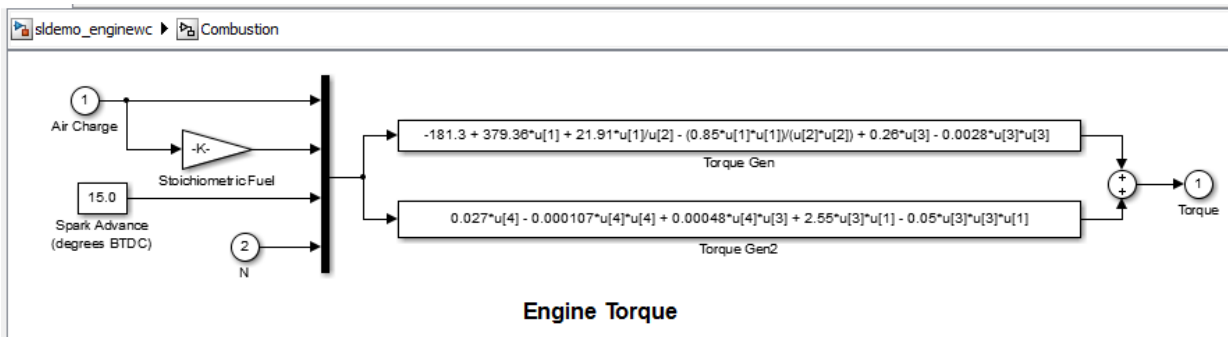

After you expand the Combustion subsystem, the top level of the `sldemo_enginewc` model includes the blocks and signals of the Combustion subsystem. The expansion removes the Subsystem block and the Inport and Outport blocks.

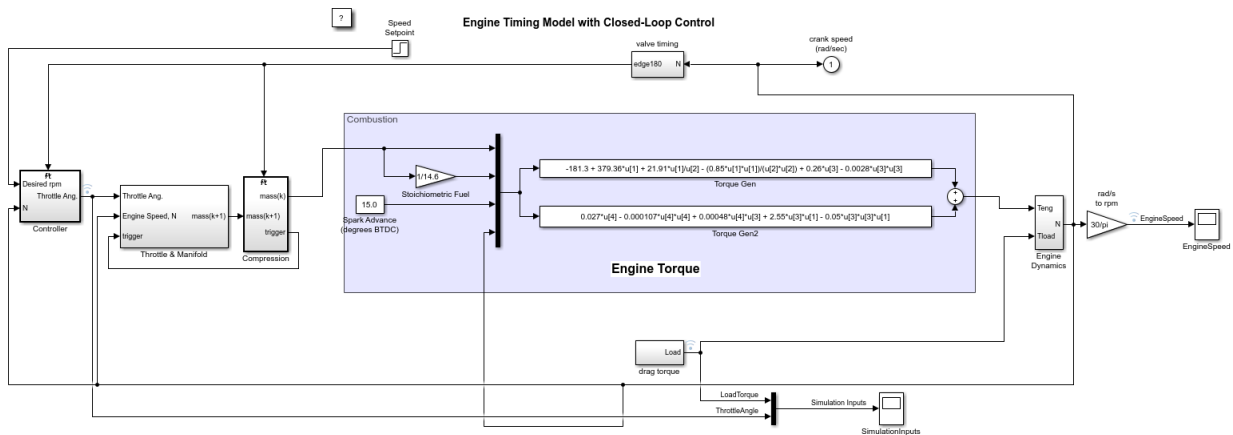

## Why Expand a Subsystem?

Expand a subsystem if you want to flatten a model hierarchy by bringing the contents of a subsystem up one level.

Expanding a subsystem is useful when refactoring a model. Flattening a model hierarchy can be the end result, or just one step in refactoring. For example, you could pull a set of blocks up to the parent system by expanding the subsystem, deselect the blocks that you want to leave in the parent, and then create a subsystem from the remaining selected blocks.

## Subsystems That You Can Expand

You can expand virtual subsystems that are not masked, linked, or commented.

### Subsystems That You Can Automatically Modify to Enable Expansion

If you try to expand one of these subsystems using the Simulink Editor, a message gives you the option of having Simulink modify the subsystem so that you can then expand it.

Kind of Subsystem	Modification
Masked subsystem	Removes all masking information
Library links	Breaks the link
Commented-out subsystem	Removes the comment-out setting

### Subsystems That You Cannot Expand

You cannot expand these subsystems:

- Atomic subsystems
- Conditional subsystems
- Configurable subsystems
- Variant subsystems
- Subsystems in a referenced model
- Subsystems with the **Read/Write permissions** parameter set to `ReadOnly` or `NoReadWrite`
- Subsystems with an `InitFcn`, `StartFcn`, `PauseFcn`, `ContinueFcn`, or `StopFcn` callback
- Subsystems with linked requirements (using Simulink Verification and Validation™ software)

## Results of Expanding a Subsystem

When you expand a subsystem, Simulink:

- Removes the Subsystem block
- Removes the root Inport, root Outport, and Simscape Connection Port blocks that were in the subsystem



- Connects the signal lines that went to the input and output ports of the subsystem directly to the ports of the blocks in the model that connected to the subsystem

### **Block Paths**

The paths for blocks that were in the subsystem that you expanded change. After expansion, update scripts and test harnesses that rely on the hierarchical paths to blocks that were in the subsystem that you expanded.

### **Signal Names and Properties**

If you expand a subsystem with a missing connection on the outside or inside of the subsystem, Simulink keeps the line labels, but uses the signal name and properties from just one of the lines. For lines corresponding to:

- A subsystem input port, Simulink uses the signal name and properties from the signal in the system in which the subsystem exists
- A subsystem output port, Simulink uses the signal name and properties from the subsystem

### **Display Layers**

The display layers of blocks (in other words, which blocks appear in front or in back for overlapping blocks) does not change after expansion. Blocks in front of the Subsystem block remain above the expanded contents, and blocks below the Subsystem block remain under the expanded contents.

### **Sorted Order and Block Priorities**

When you compile a model, Simulink sorts the blocks in terms of the order of block execution. Expanding a subsystem can change block path names, which, in rare cases, can impact the block execution order.

If you explicitly set block execution order by setting block priorities within a subsystem, Simulink removes those block priority settings when you expand that subsystem.

### **Data Stores**

Expanding a subsystem that contains a Data Store Memory block that other subsystems read from or write to can change the required data store write and read sequence. You may need to restructure your model. For details, see “Order Data Store Access” on page 60-24.

## **Related Examples**

- “Expand Subsystem Contents” on page 4-35

# Expand Subsystem Contents

## In this section...

“Expand a Subsystem” on page 4-35

“Expand a Subsystem from the Command Line” on page 4-36

Expand a subsystem to flatten a model hierarchy by bringing the contents of a subsystem up one level.

## Expand a Subsystem

- 1 In the Simulink Editor, right-click the Subsystem block for the subsystem that you want to expand.
- 2 From the context menu, select **Subsystem & Model Reference > Expand Subsystem**.

**Expand Subsystem** is disabled for subsystems that you cannot convert. For some kinds of subsystems, you have the option of having Simulink modify the subsystem so that you can then expand it. For details, see “Subsystems That You Can Automatically Modify to Enable Expansion” on page 4-32.

- 3 If necessary, modify the model layout for readability.

Simulink distributes blocks and routes signals for readability, but you can refine the model layout to enhance readability. Also, you may want to modify the model to adjust for how the subsystem expansion handles aspects of the model such as signal naming. For details, see “Results of Expanding a Subsystem” on page 4-32.

- 4 Update scripts and test harnesses that rely on the hierarchical paths to blocks that were in the subsystem that you expanded.

## Nested Subsystems

Subsystem expansion applies to the currently selected subsystem level. Simulink does not expand other subsystems in a nested subsystem hierarchy.

To improve readability when you expand nested subsystems, start by expanding the highest-level subsystem that you want to expand, and then work your way down the hierarchy as far as you want to expand.

### **Expand a Subsystem from the Command Line**

To expand a subsystem programmatically, use the `Simulink.BlockDiagram.expandSubsystem` function.

### **More About**

- “Subsystem Expansion” on page 4-30

## Use Control Flow Logic

### In this section...

“What is a Control Flow Subsystem” on page 4-37  
 “Equivalent C Language Statements” on page 4-37  
 “Conditional Control Flow Logic” on page 4-37  
 “While and For Loops” on page 4-40

### What is a Control Flow Subsystem

A *control flow subsystem* executes one or more times at the current time step when enabled by a control flow block. A control flow block implements control logic similar to that expressed by control flow statements of programming languages (e.g., `if-then`, `while-do`, `switch`, and `for`).

### Equivalent C Language Statements

You can use block diagrams to model control flow logic equivalent to the following C programming language statements:

- `for`
- `if-else`
- `switch`
- `while`

### Conditional Control Flow Logic

You can use the following blocks to perform conditional control flow logic.

C Statement	Equivalent Blocks
<code>if-else</code>	If, If Action Subsystem
<code>switch</code>	Switch Case, Switch Case Action Subsystem

#### If-Else Control Flow

The following diagram represents `if-else` control flow.

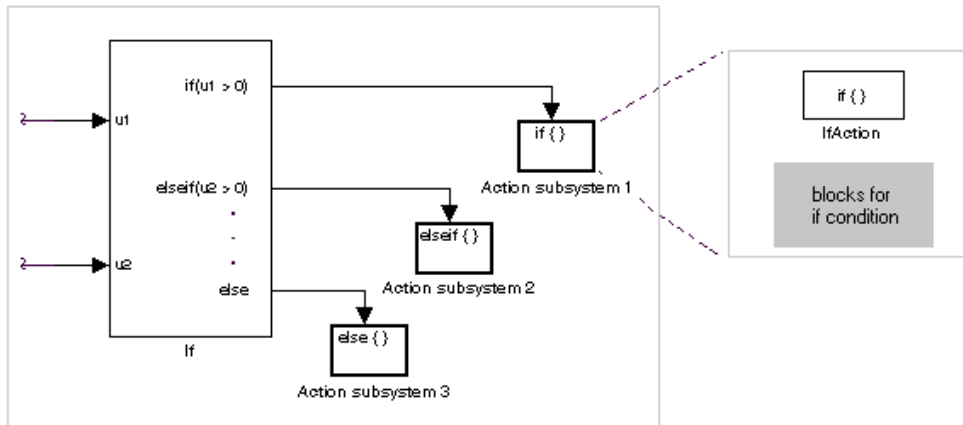

Construct an **if-else** control flow diagram as follows:

- 1 Provide data inputs to the If block for constructing if-else conditions.

In the If block parameters dialog box, set inputs to the If block. Internally, the inputs are designated as  $u_1$ ,  $u_2$ , ...,  $u_n$  and are used to construct output conditions.

- 2 In the If block parameters dialog box, set output port if-else conditions for the If block.

In the If block parameters dialog box, set Output ports. Use the input values  $u_1$ ,  $u_2$ , ...,  $u_n$  to express conditions for the if, elseif, and else condition fields in the dialog box. Of these, only the if field is required. You can enter multiple elseif conditions and select a check box to enable the else condition.

- 3 Connect each condition output port to an Action subsystem.

Connect each if, elseif, and else condition output port on the If block to a subsystem to be executed if the port's case is true.

Create these subsystems by placing an Action Port block in a subsystem. This creates an atomic Action subsystem with a port named Action, which you then connect to a condition on the If block.

Once connected, the subsystem takes on the identity of the condition it is connected to and behaves like an enabled subsystem.

For more detailed information, see the If and Action Port blocks.

---

**Note** All blocks in an Action subsystem driven by an If or Switch Case block must run at the same rate as the driving block.

---

## Switch Control Flow

The following diagram represents switch control flow.

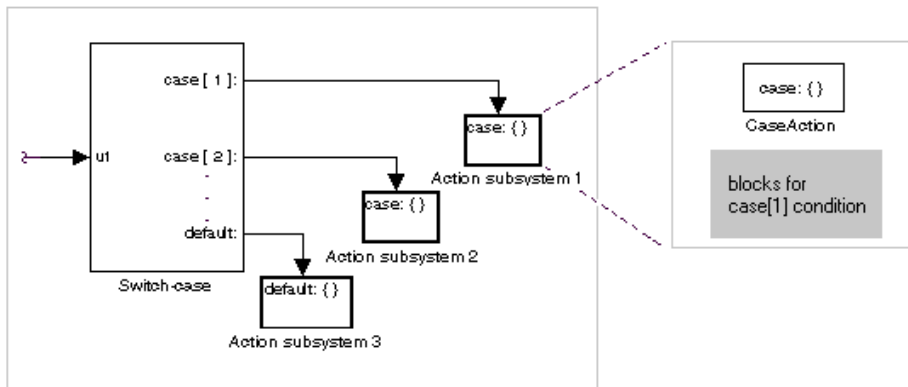

Construct a **switch** control flow statement as follows:

- 1 Provide a data input to the argument input of the Switch Case block.

The input to the Switch Case block is the argument to the **switch** control flow statement. This value determines the appropriate case to execute. Noninteger inputs to this port are truncated.

- 2 Add cases to the Switch Case block based on the numeric value of the argument input.

Using the parameters dialog box of the Switch Case block, add cases to the Switch Case block. Cases can be single or multivalued. You can also add an optional default case, which is true if no other cases are true. Once added, these cases appear as output ports on the Switch Case block.

- 3 Connect each Switch Case block case output port to an Action subsystem.

Each case output of the Switch Case block is connected to a subsystem to be executed if the port's case is true. You create these subsystems by placing an Action Port block in a subsystem. This creates an atomic subsystem with a port named Action, which you then connect to a condition on the Switch Case block. Once

connected, the subsystem takes on the identity of the condition and behaves like an enabled subsystem. Place all the block programming executed for that case in this subsystem.

For more detailed information, see documentation for the Switch Case and Action Port blocks.

---

**Note** After the subsystem for a particular case executes, an implied break executes, which exits the switch control flow statement altogether. Simulink switch control flow statement implementations do not exhibit the “fall through” behavior of C switch statements.

---

## While and For Loops

Use the following blocks to perform while and for loops.

C Statement	Equivalent Blocks
do-while	While Iterator Subsystem
for	For Iterator Subsystem
while	While Iterator Subsystem

### While Loops

The following diagram illustrates a while loop.

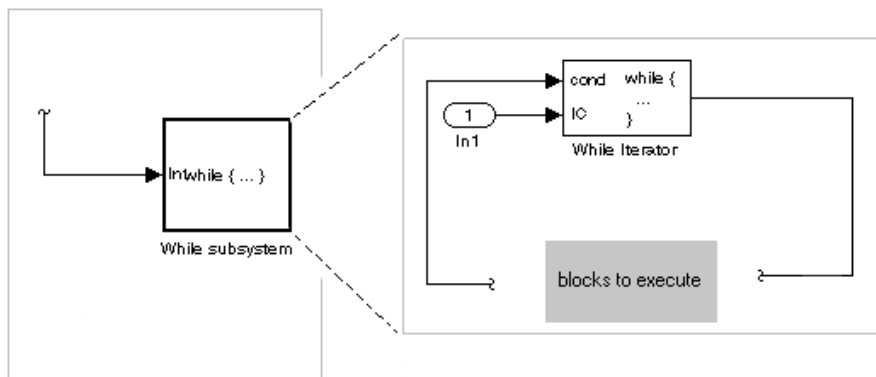



In this example, Simulink repeatedly executes the contents of the While subsystem at each time step until a condition specified by the While Iterator block is satisfied. In particular, for each iteration of the loop specified by the While Iterator block, Simulink invokes the update and output methods of all the blocks in the While subsystem in the same order that the methods would be invoked if they were in a noniterated atomic subsystem.

---

**Note:** Simulation time does not advance during execution of a While subsystem's iterations. Nevertheless, blocks in a While subsystem treat each iteration as a time step. As a result, in a While subsystem, the output of a block with states (that is, a block whose output depends on its previous input), reflects the value of its input at the previous iteration of the `while` loop. The output does *not* reflect that block's input at the previous simulation time step. For example, a Unit Delay block in a While subsystem outputs the value of its input at the previous iteration of the `while` loop, not the value at the previous simulation time step.

---

Construct a `while` loop as follows:

- 1 Place a While Iterator block in a subsystem.

The host subsystem label changes to `while {...}`, to indicate that it is modeling a while loop. These subsystems behave like triggered subsystems. This subsystem is host to the block programming that you want to iterate with the While Iterator block.

- 2 Provide a data input for the initial condition data input port of the While Iterator block.

The While Iterator block requires an initial condition data input (labeled `IC`) for its first iteration. This must originate outside the While subsystem. If this value is nonzero, the first iteration takes place.

- 3 Provide data input for the conditions port of the While Iterator block.

Conditions for the remaining iterations are passed to the data input port labeled `cond`. Input for this port must originate inside the While subsystem.

- 4 (Optional) Set the While Iterator block to output its iterator value through its properties dialog.

The iterator value is 1 for the first iteration and is incremented by 1 for each succeeding iteration.

- (Optional) Change the iteration of the While Iterator block to **do-while** through its properties dialog.

This changes the label of the host subsystem to **do { ... } while**. With a **do-while** iteration, the While Iteration block no longer has an initial condition (IC) port, because all blocks in the subsystem are executed once before the condition port (labeled **cond**) is checked.

- Create a block diagram in the subsystem that defines the subsystem's outputs.

---

**Note:** The diagram must not contain blocks with continuous states (for example, blocks from the Continuous block library). The sample times of all the blocks must be either inherited (**-1**) or constant (**inf**).

---

For more information, see the While Iterator block.

### Modeling For Loops

The following diagram represents a **for** loop:

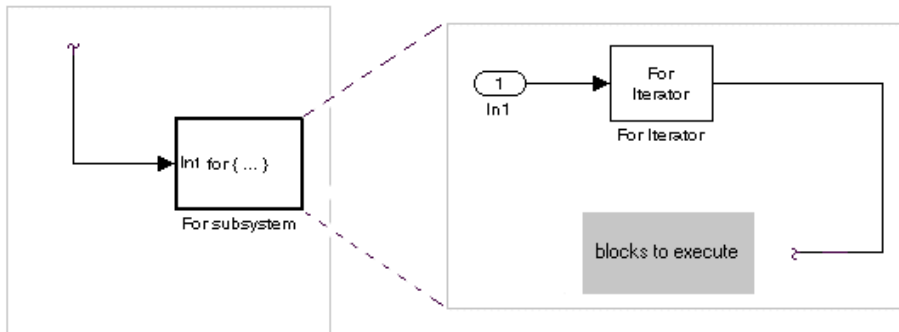

In this example, Simulink executes the contents of the For subsystem multiples times at each time step. The input to the For Iterator block specifies the number of iterations . For each iteration of the **for** loop, Simulink invokes the update and output methods of all the

blocks in the For subsystem in the same order that it invokes the methods if they are in a noniterated atomic subsystem.

---

**Note:** Simulation time does not advance during execution of a For subsystem's iterations. Nevertheless, blocks in a For subsystem treat each iteration as a time step. As a result, in a For subsystem, the output of a block with states (that is, a block whose output depends on its previous input) reflects the value of its input at the previous iteration of the `for` loop. The output does *not* reflect that block's input at the previous simulation time step. For example, a Unit Delay block in a For subsystem outputs the value of its input at the previous iteration of the `for` loop, not the value at the previous simulation time step.

---

Construct a `for` loop as follows:

- 1 Drag a For Iterator Subsystem block from the Library Browser or Library window into your model.
- 2 (Optional) Set the For Iterator block to take external or internal input for the number of iterations it executes.

Through the properties dialog of the For Iterator block you can set it to take input for the number of iterations through the port labeled `N`. This input must come from outside the For Iterator Subsystem.

You can also set the number of iterations directly in the properties dialog.

- 3 (Optional) Set the For Iterator block to output its iterator value for use in the block programming of the For Iterator Subsystem.

The iterator value is 1 for the first iteration and is incremented by 1 for each succeeding iteration.

- 4 Create a block diagram in the subsystem that defines the subsystem's outputs.

---

**Note:** The diagram must not contain blocks with continuous states (for example, blocks from the Continuous block library). The sample times of all the blocks must be either inherited (`-1`) or constant (`inf`).

---

The For Iterator block works well with the Assignment block to reassign values in a vector or matrix. The following example shows the use of a For Iterator block. Note the matrix dimensions in the data being passed.

## 4 Creating a Model

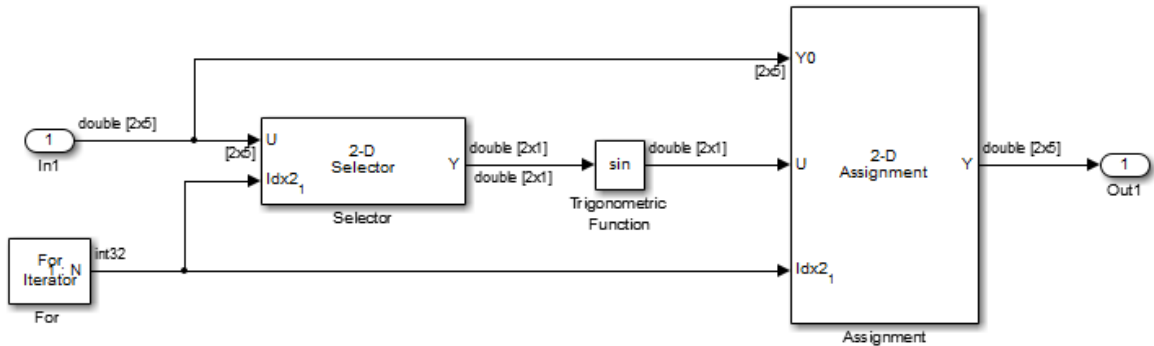
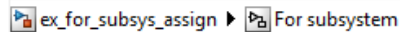

The above example outputs the sine value of an input 2-by-5 matrix (2 rows, 5 columns) using a For subsystem containing an Assignment block. The process is as follows.

- 1 A 2-by-5 matrix is input to the Selector block and the Assignment block.
- 2 The Selector block strips off a 2-by-1 matrix from the input matrix at the column value indicated by the current iteration value of the For Iterator block.
- 3 The sine of the 2-by-1 matrix is taken.
- 4 The sine value 2-by-1 matrix is passed to an Assignment block.
- 5 The Assignment block, which takes the original 2-by-5 matrix as one of its inputs, assigns the 2-by-1 matrix back into the original matrix at the column location indicated by the iteration value.

The rows specified for reassignment in the property dialog for the Assignment block in the above example are [1,2]. Because there are only two rows in the original matrix, you could also have specified -1 for the rows, (that is, all rows).

---

**Note** The Trigonometric Function block is already capable of taking the sine of a matrix. The above example uses the Trigonometric Function block only as an example of changing each element of a matrix with the collaboration of an Assignment block and a For Iterator block.

---

### **See Also**

Assignment | For Iterator | For Iterator Subsystem | While Iterator | While Iterator Subsystem | While Iterator Subsystem

## Callbacks for Customized Model Behavior

### In this section...

“Model, Block, and Port Callbacks” on page 4-46

“What You Can Do with Callbacks” on page 4-46

“Avoid run Commands in Callback Code” on page 4-46

### Model, Block, and Port Callbacks

Callbacks are commands you can define that execute in response to a specific modeling action, such as opening a model or stopping a simulation. Callbacks define MATLAB expressions that execute when the block diagram or a block is acted upon in a particular way.

Simulink provides model, block, and port callback parameters that identify specific kinds of model actions. You provide the code for a callback parameter. Simulink executes the callback code when the associated modeling action occurs.

For example, the code that you specify for the `PreLoadFcn` model callback parameter executes before the model loads. You can provide code for `PreLoadFcn` that loads the variables that model uses into the MATLAB workspace.

### What You Can Do with Callbacks

Callbacks are a powerful way to customize your Simulink model. A callback executes when you perform actions on your model, such as double-clicking a block or starting a simulation. You can use callbacks to execute MATLAB code. You can use model, block, or port callbacks to perform common tasks, such as:

- “Load Variables When Opening a Model” on page 1-11
- “Specify Block Callbacks” on page 4-52
- “Automate Simulation Tasks Using Block Callbacks” on page 24-9

### Avoid run Commands in Callback Code

Do not call the `run` command from within model or block callback code. Doing so can result in unexpected behavior (such as errors or incorrect results) if you load, compile, or simulate a Simulink model.

## **Related Examples**

- “Model Callbacks” on page 4-48
- “Block Callbacks” on page 4-52
- “Port Callbacks” on page 4-59
- “Callback Tracing” on page 4-60
- “Model Methods and Callbacks in Fast Restart” on page 68-11

# Model Callbacks

<b>In this section...</b>
“Create Model Callbacks” on page 4-48
“Model Callback Parameters” on page 4-49

## Create Model Callbacks

- 1 In the Simulink Editor, open the Property Inspector. Select **View > Property Inspector**.
- 2 With no selection at the top level of your model, in the **Properties** tab, in the **Callbacks** section, select the callback you want to set.
- 3 In the box, enter the functions you want the callback to perform.

To create a model callback programmatically, use the `set_param` function to assign MATLAB code to a model callback parameter. See “Model Callback Parameters” on page 4-49

The execution of callbacks for model referencing reflects the order in which the top model and the model it references execute their callbacks. For example, suppose:

- Model A references model B.
- Model A has a `PostLoadFcn` callback that creates variables in the MATLAB workspace.
- Model B has a `CloseFcn` callback that clears the MATLAB workspace.

Simulating model A triggers rebuilding the referenced model B.

When Simulink rebuilds model B, it opens and closes model B and invokes the model B `CloseFcn` callback. `CloseFcn` clears the MATLAB workspace, including the variables created by the model A `OpenFcn` callback.

Instead of using a `CloseFcn` callback for model B, you can use a `StopFcn` callback in model A to clear the variables used by the model from the MATLAB workspace.



## Model Callback Parameters

### Model Loading and Closing Callback Parameters

Model Callback Parameter	When Executed
PreLoadFcn	<p>This callback is executed before the model is loaded.</p> <p>Do not use model parameters in a <code>PreLoadFcn</code> model callback because parameters are loaded after the model is loaded. Instead, use a <code>PostLoadFcn</code> callback to work with model parameters when the model is loaded.</p> <p>Defining a callback code for this parameter is useful for loading variables that the model uses.</p> <p>If you want to call your model from a MATLAB file without opening your model, use the <code>load_system</code> function so that the <code>PreLoadFcn</code> executes.</p> <p>For examples, see:</p> <ul style="list-style-type: none"> <li>• “Load Variables When Opening a Model” on page 1-11</li> <li>• “Introduction to Managing Data with Model Reference”</li> <li>• “Model Referencing Simulation Targets” on page 8-46</li> </ul> <p>Limitations include:</p> <ul style="list-style-type: none"> <li>• For the <code>PreLoadFcn</code> callback, <code>get_param</code> does not return the model parameter values because the model is not yet loaded. Instead, <code>get_param</code> returns: <ul style="list-style-type: none"> <li>• The default value for a standard model parameter such as <code>solver</code></li> <li>• An error message for a model parameter added with <code>add_param</code></li> </ul> </li> <li>• Programmatic access to Scopes is not supported.</li> </ul>
PostLoadFcn	<p>After the model is loaded.</p> <p>Defining callback code for this parameter may be useful for generating an interface requiring a loaded model.</p>

Model Callback Parameter	When Executed
	<p>Limitations include:</p> <ul style="list-style-type: none"> <li>• If you make structural changes with <code>PostLoadFcn</code>, the function does not set the model <code>Dirty</code> flag to indicate unsaved changes. When you close the model, Simulink does not prompt you to save.</li> <li>• Programmatic access to <code>Scopes</code> is not supported.</li> </ul>
<code>CloseFcn</code>	<p>Before the block diagram is closed.</p> <p>Any <code>ModelCloseFcn</code> and <code>DeleteFcn</code> callbacks set on blocks in the model are called prior to the model <code>CloseFcn</code> callback. The <code>DestroyFcn</code> callback of any blocks in the model is called after the model <code>CloseFcn</code> callback.</p>

#### Model Saving Callback Parameters

Model Callback Parameter	When Executed
<code>PreSaveFcn</code>	Before the model is saved.
<code>PostSaveFcn</code>	<p>After the model is saved.</p> <hr/> <p><b>Note:</b> If you make structural changes with <code>PostSaveFcn</code>, the function does not set the model <code>Dirty</code> flag to indicate unsaved changes. When you close the model, Simulink does not prompt you to save.</p>

#### Model Simulation Callback Parameters

Model Callback Parameter	When Executed
<code>InitFcn</code>	<p>Called during update phase before block parameters are evaluated. This is called during model update and simulation.</p> <p>For examples, see:</p> <ul style="list-style-type: none"> <li>• “Create Programmatic Hyperlinks” on page 23-66</li> <li>• “Track Object Using MATLAB Code” on page 40-167</li> </ul>

Model Callback Parameter	When Executed
	<p><b>Note:</b></p> <ul style="list-style-type: none"> <li>• An <code>InitFcn</code> callback in a top model cannot change parameters used by referenced models.</li> <li>• During model compilation, Simulink evaluates variant objects before calling the model <code>InitFcn</code> callback. Do not modify the condition of the variant object in the <code>InitFcn</code> callback. For more information, see “Define, Configure, and Activate Variants” on page 11-31.</li> </ul>
<code>StartFcn</code>	<p>Called before the simulation phase. This is not called during model update.</p> <p>For an example, see “Automate Simulation Tasks Using Block Callbacks” on page 24-9.</p>
<code>PauseFcn</code>	<p>After the simulation pauses.</p>
<code>ContinueFcn</code>	<p>Before the simulation continues.</p>
<code>StopFcn</code>	<p>After the simulation stops.</p> <p>Output is written to workspace variables and files before the <code>StopFcn</code> is executed.</p>

## Related Examples

- “Callbacks for Customized Model Behavior” on page 4-46
- “Block Callbacks” on page 4-52
- “Port Callbacks” on page 4-59
- “Callback Tracing” on page 4-60
- “Model Methods and Callbacks in Fast Restart” on page 68-11

## Block Callbacks

### In this section...

“Specify Block Callbacks” on page 4-52

“Block Callback Parameters” on page 4-52

### Specify Block Callbacks

- 1 Open the Property Inspector. Select **View > Property Inspector**.
- 2 Select the block whose callback you want to specify. In the **Properties** tab of the Property Inspector, in the **Callbacks** section, select the callback you want to define.
- 3 In the box, enter the functions you want the callback to perform.

To specify a block callback programmatically, use `set_param` to assign MATLAB code to the block callback parameter.

### Block Callback Parameters

If a block callback executes before or after a modeling action takes place, that callback occurs immediately before or after the action.

#### Block Opening Callback Parameters

Block Callback Parameter	When Executed
OpenFcn	<p>When the block is opened.</p> <p>Generally, use this parameter with Subsystem blocks.</p> <p>The callback executes when you double-click the block or when you use <code>open_system</code> with the block as an argument. The <code>OpenFcn</code> parameter overrides the normal behavior associated with opening a block, which is to display the block dialog box or to open the subsystem. Examples of tasks that you can use <code>OpenFcn</code> for include defining variables for a block, making a call to MATLAB to produce a plot of simulated data, or generating a graphical user interface.</p> <p>For examples of using <code>OpenFcn</code> with model referencing, see:</p>

Block Callback Parameter	When Executed
	<ul style="list-style-type: none"> <li>In the Introduction to Managing Data with Model Reference example, click the question mark block at the top and then select <b>Detailed Workflow for Managing Data with Model Reference</b>.</li> <li>“Model Referencing Simulation Targets” on page 8-46</li> </ul>
LoadFcn	<p>After the block diagram is loaded.</p> <p>For Subsystem blocks, the LoadFcn callback is performed for any blocks in the subsystem (including other Subsystem blocks) that have a LoadFcn callback defined.</p>

### Block Editing Callback Parameters

Block Callback Parameter	When Executed
MoveFcn	When the block is moved or resized.
NameChangeFcn	<p>After a block name or path changes.</p> <p>When a Subsystem block path changes, the Subsystem block calls the NameChangeFcn callback of its descendant blocks and then calls the NameChangeFcn callback on itself.</p>
PreCopyFcn	<p>Before a block is copied. The PreCopyFcn is also executed if add_block is used to copy the block.</p> <p>If you copy a Subsystem block that contains a block for which the PreCopyFcn callback is defined, that callback executes also.</p> <p>The block CopyFcn callback is called after all PreCopyFcn callbacks are executed, unless PreCopyFcn invokes the error command, either explicitly or via a command used in any PreCopyFcn.</p>
CopyFcn	<p>After a block is copied. The callback is also executed if add_block is used to copy the block.</p> <p>If you copy a Subsystem block that contains a block for which the CopyFcn parameter is defined, the callback is also executed.</p>

Block Callback Parameter	When Executed
ClipboardFcn	When the block is copied or cut to the system clipboard.
PreDeleteFcn	<p>Before a block is graphically deleted (for example, when you graphically delete the block or invoke <code>delete_block</code> on the block).</p> <p>The <code>PreDeleteFcn</code> is not called when the model containing the block is closed. The block's <code>DeleteFcn</code> is called after the <code>PreDeleteFcn</code>, unless the <code>PreDeleteFcn</code> invokes the <code>error</code> command, either explicitly or via a command used in the <code>PreDeleteFcn</code>.</p>
DeleteFcn	<p>After a block is graphically deleted (for example, when you graphically delete the block, invoke <code>delete_block</code> on the block, or close the model containing the block).</p> <p>When the <code>DeleteFcn</code> is called, the block handle is still valid and can be accessed using <code>get_param</code>. If the block is graphically deleted by invoking <code>delete_block</code> or by closing the model, after deletion the block is destroyed from memory and the block's <code>DestroyFcn</code> is called.</p> <p>For Subsystem blocks, the <code>DeleteFcn</code> callback is performed for any blocks in the subsystem (including other Subsystem blocks) that have a <code>DeleteFcn</code> callback defined.</p>
DestroyFcn	<p>When the block has been destroyed from memory (for example, when you invoke <code>delete_block</code> on either the block or a subsystem containing the block or close the model containing the block).</p> <p>If the block was not previously graphically deleted, the <code>blockDeleteFcn</code> callback is called prior to the <code>DestroyFcn</code>. When the <code>DestroyFcn</code> is called, the block handle is no longer valid.</p>
UndoDeleteFcn	When a block deletion is undone.

### Block Compilation and Simulation Callback Parameters

Block Callback Parameter	When Executed
InitFcn	Before the block diagram is compiled and before block parameters are evaluated.
StartFcn	After the block diagram is compiled and before the simulation starts.  In the case of an S-Function block, <b>StartFcn</b> executes immediately before the first execution of the block's <b>mdlProcessParameters</b> function. For more information, see "S-Function Callback Methods".
ContinueFcn	Before the simulation continues.
PauseFcn	After the simulation pauses.
StopFcn	At any termination of the simulation.  In the case of an S-Function block, <b>StopFcn</b> executes after the block's <b>mdlTerminate</b> function executes. For more information, see "S-Function Callback Methods".

### Block Saving and Closing Callback Parameters

Block Callback Parameter	When Executed
PreSaveFcn	Before the block diagram is saved.  For Subsystem blocks, the <b>PreSaveFcn</b> callback is performed for any blocks in the subsystem (including other Subsystem blocks) that have a <b>PreSaveFcn</b> callback defined.
PostSaveFcn	After the block diagram is saved.  For Subsystem blocks, the <b>PostSaveFcn</b> callback is performed for any blocks in the subsystem (including other Subsystem blocks) that have a <b>PostSaveFcn</b> callback defined.
CloseFcn	When the block is closed using <code>close_system</code> .  The <b>CloseFcn</b> is not called when you interactively close the block parameters dialog box, when you interactively

Block Callback Parameter	When Executed
	<p>close the subsystem or model containing the block, or when you close the subsystem or model containing a block using <code>close_system</code>.</p> <p>For example, to close all open MATLAB windows, use a command such as:</p> <pre>set_param('my_model', 'CloseFcn', 'close all')</pre>
ModelCloseFcn	<p>Before the block diagram is closed.</p> <p>When the model is closed, the block's <code>ModelCloseFcn</code> is called prior to its <code>DeleteFcn</code>.</p> <p>For Subsystem blocks, the <code>ModelCloseFcn</code> callback is performed for any blocks in the subsystem (including other Subsystem blocks) that have a <code>ModelCloseFcn</code> callback defined.</p>

### Subsystem Block Callback Parameters

You can use the other block callback parameters with Subsystem blocks, but the callback parameters in this table are specific to Subsystem blocks.

---

**Note:** A callback for a masked subsystem cannot directly reference the parameters of the masked subsystem (see “Block Masks”). Simulink evaluates block callbacks in the MATLAB base workspace, whereas the mask parameters reside in the masked subsystem’s private workspace. A block callback, however, can use `get_param` to obtain the value of a mask parameter. For example, here `gain` is the name of a mask parameter of the current block:

```
get_param(gcb, 'gain')
```

---

Block Callback Parameter	When Executed
DeleteChildFcn	<p>After a block or line is deleted in a subsystem.</p> <p>If the block has a <code>DeleteFcn</code> or <code>DestroyFcn</code> callback, those callbacks execute prior to the <code>DeleteChildFcn</code> callback.</p>



Block Callback Parameter	When Executed
ErrorFcn	<p>When an error has occurred in a subsystem.</p> <p>Use the following form for the callback code for the <code>ErrorFcn</code> parameter:</p> <pre>newException = errorHandler(subsys, ... errorType, originalException)</pre> <p>where</p> <ul style="list-style-type: none"> <li>• <code>errorHandler</code> is the name of the function.</li> <li>• <code>subsys</code> is a handle to the subsystem in which the error occurred.</li> <li>• <code>errorType</code> is a character vector indicating the type of error that occurred.</li> <li>• <code>originalException</code> is an <code>MSLException</code> (see “Error Handling in Simulink Using <code>MSLException</code>” on page 24-28).</li> <li>• <code>newException</code> is an <code>MSLException</code> specifying the error message to be displayed to the user.</li> </ul> <p>If you provide the original exception, then you do not need to specify the subsystem and the error type.</p> <p>The following command sets the <code>ErrorFcn</code> of the subsystem <code>subsys</code> to call the <code>errorHandler</code> callback:</p> <pre>set_param(subsys, 'ErrorFcn', 'errorHandler')</pre> <p>In such calls to <code>set_param</code>, do not include the input arguments of the callback code. Simulink displays the error message returned by the callback.</p>

Block Callback Parameter	When Executed
ParentCloseFcn	<p>Before closing a subsystem containing the block or when the block is made part of a new subsystem using either:</p> <ul style="list-style-type: none"><li>• The <code>new_system</code> function</li><li>• In the Simulink Editor, the <b>Diagram &gt; Subsystem &amp; Model Reference &gt; Create Subsystem from Selection</b> option</li></ul> <p>When you close the model, Simulink does not call the <code>ParentCloseFcn</code> callbacks of blocks at the root model level.</p>

### Related Examples

- “Callbacks for Customized Model Behavior” on page 4-46
- “Model Callbacks” on page 4-48
- “Port Callbacks” on page 4-59
- “Callback Tracing” on page 4-60
- “Model Methods and Callbacks in Fast Restart” on page 68-11

## Port Callbacks

Block input and output ports have a single callback parameter, `ConnectionCallback`. This parameter allows you to set callbacks on ports that are triggered every time the connectivity of these ports changes. Examples of connectivity changes include adding a connection from the port to a block, deleting a block connected to the port, and deleting, disconnecting, or connecting branches or lines to the port.

Use `get_param` to get the port handle of a port and `set_param` to set the callback on the port. The callback code must have one input argument that represents the port handle. The input argument is not included in the call to `set_param`.

For example, suppose the currently selected block has a single input port. The following code sets `foo` as the connection callback on the input port:

```
phs = get_param(gcf, 'PortHandles');  
set_param(phs.Inport, 'ConnectionCallback', 'foo');
```

where, `foo` is defined as:

```
function foo(portHandle)
```

### Related Examples

- “Callbacks for Customized Model Behavior” on page 4-46
- “Model Callbacks” on page 4-48
- “Block Callbacks” on page 4-52
- “Callback Tracing” on page 4-60
- “Model Methods and Callbacks in Fast Restart” on page 68-11

# Callback Tracing

Use callback tracing to determine the callbacks that Simulink invokes and the order that it invokes them when you open, edit, or simulate a model.

To enable callback tracing, do one of the following:

- In the Simulink Preferences dialog box, select the **Callback tracing** preference.
- Execute `set_param(0, 'CallbackTracing', 'on')`.

The `CallbackTracing` parameter causes the callbacks to appear in the MATLAB Command Window as they are invoked. This option applies to all Simulink models, not just models that are open when you enable the preference.

## Related Examples

- “Callbacks for Customized Model Behavior” on page 4-46
- “Model Callbacks” on page 4-48
- “Block Callbacks” on page 4-52
- “Port Callbacks” on page 4-59
- “Model Methods and Callbacks in Fast Restart” on page 68-11

## Manage Model Versions and Specify Model Properties

### In this section...

“How Simulink Helps You Manage Model Versions” on page 4-61

“Model File Change Notification” on page 4-61

“Manage Model Properties” on page 4-62

“Log Comments History” on page 4-64

“Version Information Properties” on page 4-65

### How Simulink Helps You Manage Model Versions

In Simulink, you can manage multiple versions of a model using these techniques:

- Use Simulink Projects to manage your project files, connect to source control, review modified files, and compare revisions. See “Project Management”.
- Use model file change notification to manage work with source control operations and multiple users. See “Model File Change Notification” on page 4-61.
- As you edit a model, Simulink generates version information about the model, including a version number, who created and last updated the model, and an optional comments history log. Simulink saves these version properties with the model.
  - View and edit some of the version information stored in the model and specify history logging in the model properties.
  - The Model Info block lets you display version information as an annotation block in a model diagram.
  - You can access Simulink version parameters programmatically.
- See Simulink.MDLInfo class to extract information from a model file without loading the block diagram into memory. You can use MDLInfo to query model version and Simulink version, find the names of referenced models without loading the model into memory, and attach arbitrary metadata to your model file.

### Model File Change Notification

You can use a Simulink preference to specify whether to notify you if the model has changed on disk. You can receive this notification when updating or simulating the model, first editing the model, or saving the model. The model can change on disk, for example, with source control operations and multiple users.

In the Simulink Editor, select **File > Simulink Preferences**. In the **Model File** pane, under **Change Notification**, select the appropriate action.

- If you select **First editing the model**, the file has changed on disk, and the block diagram is unmodified in Simulink:
  - Any interactive operation that modifies the block diagram (e.g., adding a block) causes a warning to appear.
  - Any command-line operation that modifies the block diagram (such as a call to `set_param`) causes a warning to appear.
- If you select **Saving the model**, and the file has changed on disk:
  - Saving the model in the Simulink Editor causes a message to appear.
  - The `save_system` function reports an error, unless you use the `OverwriteIfChangedOnDisk` option.

To programmatically check whether the model has changed on disk since it was loaded, use the function `slIsFileChangedOnDisk`.

For more options that help you work with source control and multiple users, see “Project Management”.

### Manage Model Properties

You can use the Property Inspector to view and edit model version properties, description history, and callback functions. To open the Property Inspector, select **View > Property Inspector**. Model properties or, if you are in a library model, library properties, appear in the Property Inspector when nothing is selected at the top level of a model.

#### Specify the Current User

When you create or update a model, your name is logged in the model for version control purposes. Simulink assumes that your name is specified by at least one of the `USER`, `USERNAME`, `LOGIN`, or `LOGNAME` environment variables. If your system does not define any of these variables, Simulink does not update the user name in the model.

UNIX<sup>®</sup> systems define the `USER` environment variable and set its value to the name you use to log in to your system. Thus, if you are using a UNIX system, you do not have to take further action for Simulink to identify you as the current user.

Windows systems can define environment variables for user name that Simulink expects, depending on the version of Windows installed on your system and whether it is connected to a network. Use the MATLAB function `getenv` to determine which of the environment variables is defined. For example, at MATLAB command prompt, enter:

```
getenv('user')
```

This function determines whether the `USER` environment variable exists on your Windows system. If it does not, set it.

### **Model Information and History**

The **Info** tab summarizes information about the current version of the model, such as modifications, version, and last saved date. You can view and edit model information and enable, view, and edit the model's change history.

Use the **Description** section to enter a description of the model. You can then view the model description by entering `help` followed by the model name at the MATLAB command prompt.

The **History** section displays model history information.

- **Model version**

Version number for this model, incremented by 1 each time you save the model.

- **Created by**

Name of the person who created this model based on the value of the `USER` environment variable when the model is created.

- **Created on**

Date and time this model was created. Do not change this value.

- **Last saved by**

Name of the person who last saved this model based on the value of the `USER` environment variable when the model is saved.

- **Last saved on**

Date that this model was last saved, based on the system date and time.

The **Model history** box displays the history of the model. For more information on updating model history, see “Log Comments History” on page 4-64.

### Properties

You can view the source file location, specify where to save model design data, and define callbacks in the **Properties** tab of the model properties.

---

**Note:** Library properties also enable you to specify the mapping from old library blocks to new library blocks. For information on using forwarding tables for this purpose, see “Forwarding Tables” on page 39-40.

---

### Define Location of Design Data

Use the **Design Data** section to specify the location of the design data that your model uses. You can define design data in the base workspace or in a data dictionary. See “Migrate Single Model to Use Dictionary” on page 61-6.

### Callbacks

Use the **Callbacks** section to specify functions to invoke at specific points in the simulation of the model. Select the callback from the list. In the box, enter the function you want to invoke for the selected callback. For information on these callbacks, see “Create Model Callbacks” on page 4-48.

## Log Comments History

You can create and store a record of changes with the model. Simulink compiles the history from comments that you or other users enter when saving changes to a model. For more flexibility adding labels and comments to models and submissions, see “Project Management”.

### Logging Changes

To enable comment logging, in the **Info** tab of the model properties, in the **History** section, set **Prompt to update model history** to **When saving model**.

The next time you save the model, the Add Comment to Model History dialog box prompts you to enter a comment.



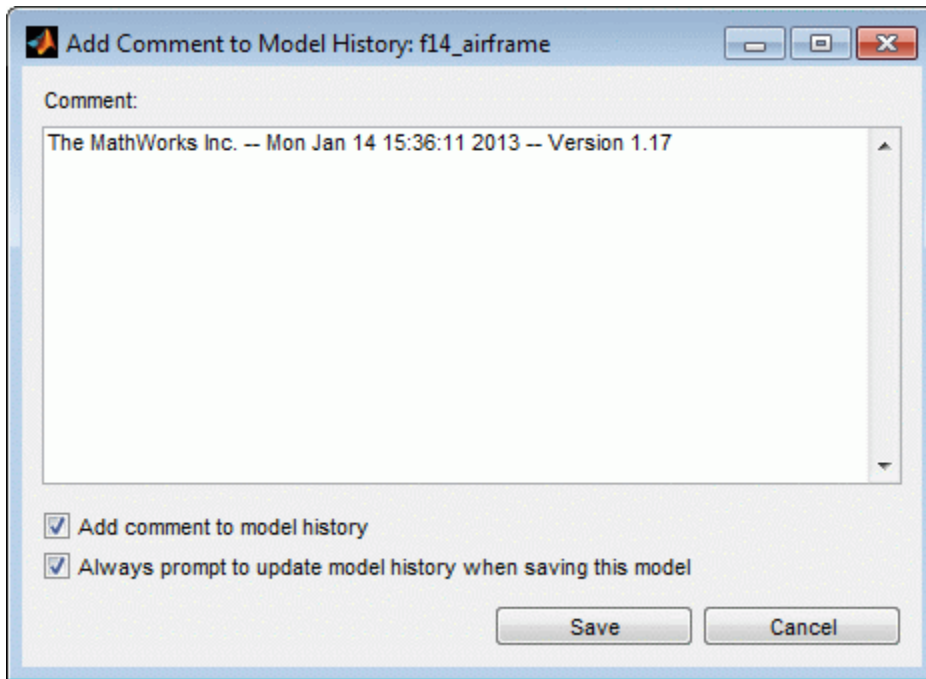

For example, describe the changes you have made to the model since the last time you saved it. To add an item to the model's change history, enter it in the **Comment** box and click **Save**. The information is stored in the model's change history log.

If you do not want to enter an item for this session, clear the **Add comment to model history** check box.

To discontinue change logging, you can either:

- Clear the **Always prompt to update model history when saving this model** check box.
- Change the **Prompt to update model history** model property to Never.

## Version Information Properties

Some version information is stored as model parameters in a model. You can access this information programmatically using the Simulink `get_param` function.

The table describes the model parameters used by Simulink to store version information.

Property	Description
Created	Date created.
Creator	Name of the person who created this model.
Description	User-entered description of this model. Enter or edit a description on the Description tab of the Model Properties dialog box. You can view the model description by typing  <code>help 'mymodelName'</code> at the MATLAB command prompt.
LastModifiedBy	Name of the user who last saved the model.
LastModifiedDate	Date when the model was last saved.
ModifiedByFormat	Format of the <code>ModifiedBy</code> parameter. The value can include the tag <code>%&lt;Auto&gt;</code> . The Simulink software replaces the tag with the current value of the <code>USER</code> environment variable.
ModifiedDateFormat	Format used to generate the value of the <code>LastModifiedDate</code> parameter. The value can include the tag <code>%&lt;Auto&gt;</code> . Simulink replaces the tag with the current date and time when saving the model.
ModifiedComment	Comment entered by user who last updated this model.
ModifiedHistory	History of changes to this model.
ModelVersion	Version number.
ModelVersionFormat	Format of model version number. The value can contain the tag <code>%&lt;AutoIncrement:#&gt;</code> where <code>#</code> is an integer. Simulink replaces the tag with <code>#</code> when displaying the version number. It increments <code>#</code> when saving the model.

`LibraryVersion` is a block parameter for a linked block. `LibraryVersion` is the `ModelVersion` of the library at the time the link was created.

For source control version information, see instead “Project Management”.

## **See Also**

Model Info

## **Related Examples**

- “Project Management”
- “Model File Change Notification” on page 4-61
- Simulink.MDLInfo class

# Model Discretizer

### In this section...

“What Is the Model Discretizer?” on page 4-68

“Requirements” on page 4-68

“Discretize a Model with the Model Discretizer” on page 4-69

“View the Discretized Model” on page 4-77

“Discretize Blocks from the Simulink Model” on page 4-80

“Discretize a Model with the `sldiscmdl` Function” on page 4-90

## What Is the Model Discretizer?

Model Discretizer selectively replaces continuous Simulink blocks with discrete equivalents. Discretization is a critical step in digital controller design and for hardware in-the-loop simulations.

You can use the Model Discretizer to:

- Identify a model's continuous blocks
- Change a block's parameters from continuous to discrete
- Apply discretization settings to all continuous blocks in the model or selected blocks
- Create configurable subsystems that contain multiple discretization candidates along with the original continuous block(s)
- Switch among the different discretization candidates and evaluate the resulting model simulations

## Requirements

To use Model Discretizer

- You must have a Control System Toolbox™ license, Version 5.2 or later.
- Make sure your model does not contain any obsolete blocks and is upgraded to the current Simulink version. For more information, see “Model Upgrades”
- Make sure your model does not contain any masked subsystems. For more information, see “Block Masks”.

## Discretize a Model with the Model Discretizer

To discretize a model:

- Start the Model Discretizer
- Specify the Transform Method
- Specify the Sample Time
- Specify the Discretization Method
- Discretize the Blocks

The f14 model shows the steps in discretizing a model.

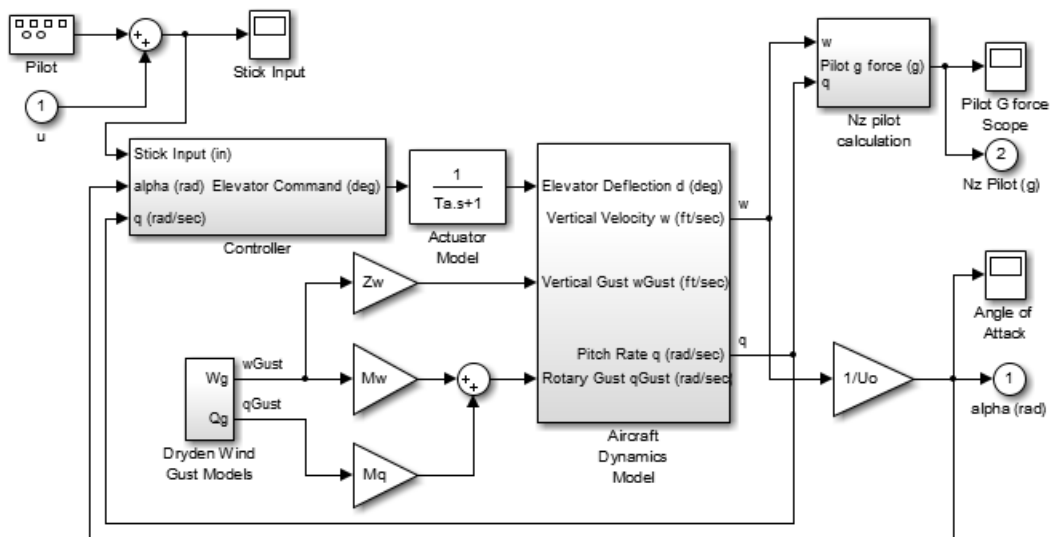

### Start Model Discretizer

To open the tool, in the Simulink Editor, select **Analysis > Control Design > Model Discretizer**.

The **Simulink Model Discretizer** opens.

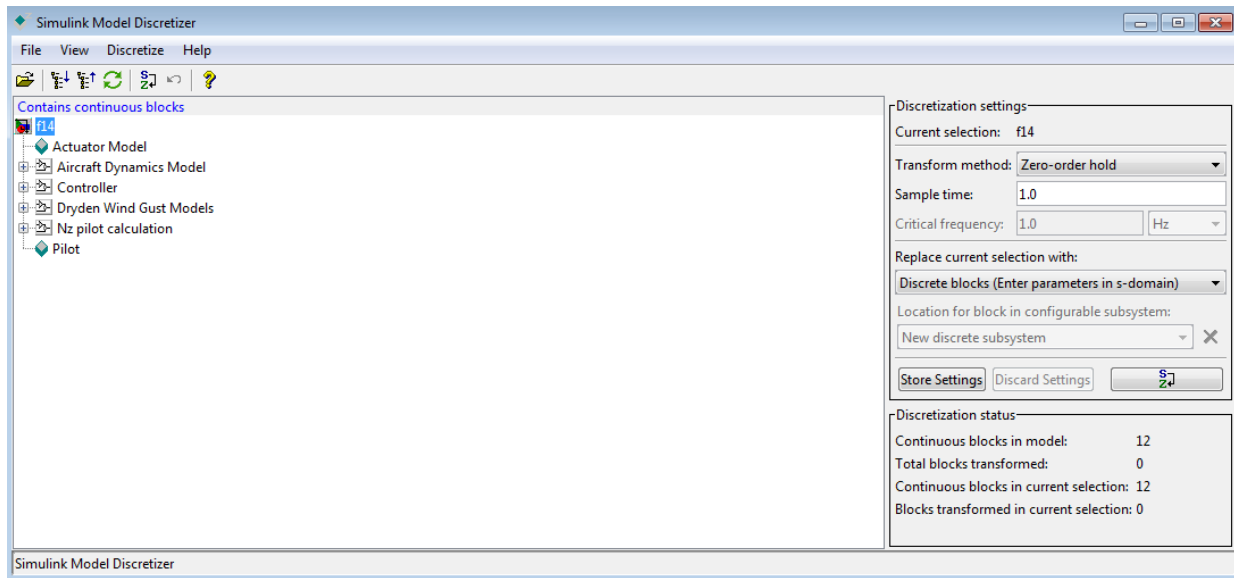

Alternatively, you can open Model Discretizer from the MATLAB Command Window using the `slmdliscui` function.

The following command opens the **Simulink Model Discretizer** window with the `f14` model:

```
slmdliscui('f14')
```

To open a new model or library from Model Discretizer, select **File > Load model**.

### Specify the Transform Method

The transform method specifies the type of algorithms used in the discretization. For more information on the different transform methods, see the Control System Toolbox.

The **Transform method** list contains the following options:

- **Zero-order hold**  
Zero-order hold on the inputs.
- **First-order hold**  
Linear interpolation of inputs.

- Tustin

Bilinear (Tustin) approximation.

- Tustin with prewarping

Tustin approximation with frequency prewarping.

- Matched pole-zero

Matched pole-zero method (for SISO systems only).

### Specify the Sample Time

Enter the sample time in the **Sample time** field.

You can specify an offset time by entering a two-element vector for discrete blocks or configurable subsystems. The first element is the sample time and the second element is the offset time. For example, an entry of [1.0 0.1] would specify a 1.0 second sample time with a 0.1 second offset. If no offset is specified, the default is zero.

You can enter workspace variables when discretizing blocks in the s-domain. See “Discrete blocks (Enter parameters in s-domain)” on page 4-72.

### Specify the Discretization Method

Specify the discretization method in the **Replace current selection with** field. The options are

- “Discrete blocks (Enter parameters in s-domain)” on page 4-72

Creates a discrete block whose parameters are retained from the corresponding continuous block.

- “Discrete blocks (Enter parameters in z-domain)” on page 4-73

Creates a discrete block whose parameters are “hard-coded“ values placed directly into the block’s dialog.

- “Configurable subsystem (Enter parameters in s-domain)” on page 4-74

Create multiple discretization candidates using s-domain values for the current selection. A configurable subsystem can consist of one or more blocks.

- “Configurable subsystem (Enter parameters in z-domain)” on page 4-75

Create multiple discretization candidates in z-domain for the current selection. A configurable subsystem can consist of one or more blocks.

### **Discrete blocks (Enter parameters in s-domain)**

Creates a discrete block whose parameters are retained from the corresponding continuous block. The sample time and the discretization parameters are also on the block's parameter dialog box.

The block is implemented as a masked discrete block that uses `c2d` to transform the continuous parameters to discrete parameters in the mask initialization code.

These blocks have the unique capability of reverting to continuous behavior if the sample time is changed to zero. Entering the sample time as a workspace variable ('`TS`', for example) allows for easy changeover from continuous to discrete and back again. See "Specify the Sample Time" on page 4-71.

---

**Note** If you generated code from a model, parameters are not tunable when **Default parameter behavior** is set to `Inlined` in the model's Configuration Parameters dialog box.

---

The following figure shows a continuous Transfer Function block next to a Transfer Function block that has been discretized in the s-domain. The block parameters dialog box for each block appears below the block.



$$\frac{1}{s+1}$$

$$\frac{\text{tustin}}{s+1}$$

Block Parameters: Transfer Fcn

Transfer Fcn

The numerator coefficient can be a vector or matrix expression. The denominator coefficient must be a vector. The output width equals the number of rows in the numerator coefficient. You should specify the coefficients in descending order of powers of s.

Parameters

Numerator coefficients:

[1]

Denominator coefficients:

[1 1]

Absolute tolerance:

auto

State Name: (e.g., 'position')

"

OK Cancel Help Apply

Block Parameters: Discretized Transfer Fcn

DiscretizedTransferFcn (mask) (link)

Continuous mask uses c2d to transform parameters onto the Discrete Transfer function block inside.

Parameters

Numerator (enter in s-domain:)

[1]

Denominator (enter in s-domain:)

[1 1]

Absolute tolerance:

auto

Sample time:

1.0

Method: tustin

OK Cancel Help Apply

### Discrete blocks (Enter parameters in z-domain)

Creates a discrete block whose parameters are “hard-coded” values placed directly into the block’s dialog box. Model Discretizer uses the `c2d` function to obtain the discretized parameters, if needed.

For more help on the `c2d` function, type the following in the Command Window:

```
help c2d
```

The following figure shows a continuous Transfer Function block next to a Transfer Function block that has been discretized in the z-domain. The block parameters dialog box for each block appears below the block.

$$\frac{1}{s+1}$$

$$\frac{1}{z+0.5}$$

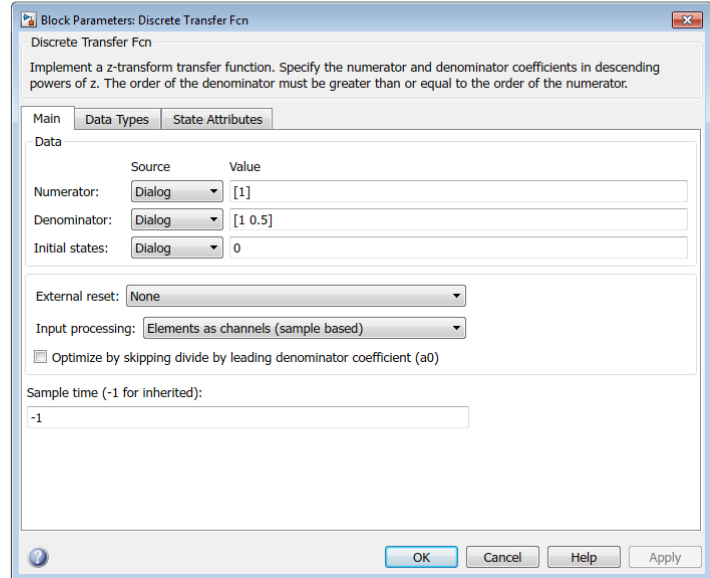
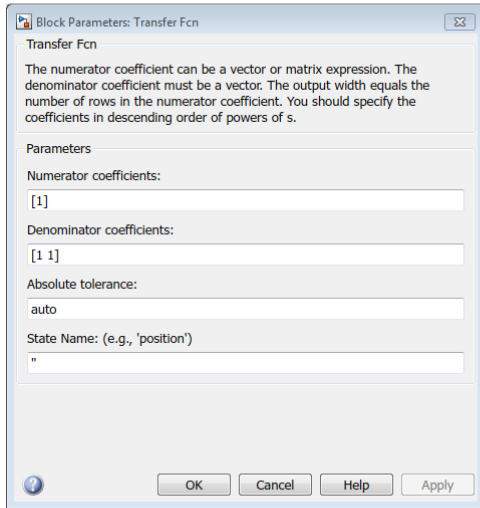

---

**Note** If you want to recover exactly the original continuous parameter values after the Model Discretization session, you should enter parameters in the s-domain.

---

### Configurable subsystem (Enter parameters in s-domain)

Create multiple discretization candidates using s-domain values for the current selection. A configurable subsystem can consist of one or more blocks.

The **Location for block in configurable subsystem** field becomes active when this option is selected. This option allows you to either create a new configurable subsystem or overwrite an existing one.

---

**Note** The current folder must be writable in order to save the library or libraries for the configurable subsystem option.

---

### Configurable subsystem (Enter parameters in z-domain)

Create multiple discretization candidates in z-domain for the current selection. A configurable subsystem can consist of one or more blocks.

The **Location for block in configurable subsystem** field becomes active when this option is selected. This option allows you to either create a new configurable subsystem or overwrite an existing one.

---

**Note** The current folder must be writable in order to save the library or libraries for the configurable subsystem option.

---

Configurable subsystems are stored in a library containing the discretization candidates and the original continuous block. The library will be named `<model name>_disc_lib` and it will be stored in the current . For example a library containing a configurable subsystem created from the `f14` model will be named `f14_disc_lib`.

If multiple libraries are created from the same model, then the filenames will increment accordingly. For example, the second configurable subsystem library created from the `f14` model will be named `f14_disc_lib2`.

You can open a configurable subsystem library by right-clicking on the subsystem in the model and selecting **Library Link > Go to library block** from the context menu.

### Discretize the Blocks

To discretize blocks that are linked to a library, you must either discretize the blocks in the library itself or disable the library links in the model window.

You can open the library from Model Discretizer by selecting **Load model** from the **File** menu.

You can disable the library links by right-clicking on the block and selecting **Library Link > Disable Link** from the context menu.

There are two methods for discretizing blocks.

#### Select Blocks and Discretize

- 1 Select a block or blocks in the Model Discretizer tree view pane.

To choose multiple blocks, press and hold the **Ctrl** button on the keyboard while selecting the blocks.

---

**Note** You must select blocks from the Model Discretizer tree view. Clicking blocks in the editor does not select them for discretization.

---

- 2 Select **Discretize current block** from the **Discretize** menu if a single block is selected or select **Discretize selected blocks** from the **Discretize** menu if multiple blocks are selected.

You can also discretize the current block by clicking the **Discretize** button, shown below.



### Store the Discretization Settings and Apply Them to Selected Blocks in the Model

- 1 Enter the discretization settings for the current block.
- 2 Click **Store Settings**.

This adds the current block with its discretization settings to the group of preset blocks.

- 3 Repeat steps 1 and 2, as necessary.
- 4 Select **Discretize preset blocks** from the **Discretize** menu.

### Deleting a Discretization Candidate from a Configurable Subsystem

You can delete a discretization candidate from a configurable subsystem by selecting it in the **Location for block in configurable subsystem** field and clicking the **Delete** button.

### Undoing a Discretization

To undo a discretization, click the **Undo** discretization button.

Alternatively, you can select **Undo discretization** from the **Discretize** menu.

This operation undoes discretizations in the current selection and its children. For example, performing the undo operation on a subsystem will remove discretization from all blocks in all levels of the subsystem's hierarchy.

## View the Discretized Model

Model Discretizer displays the model in a hierarchical tree view.

### Viewing Discretized Blocks

The block's icon in the tree view becomes highlighted with a “z” when the block has been discretized.

The following figure shows that the Aircraft Dynamics Model subsystem has been discretized into a configurable subsystem with three discretization candidates.

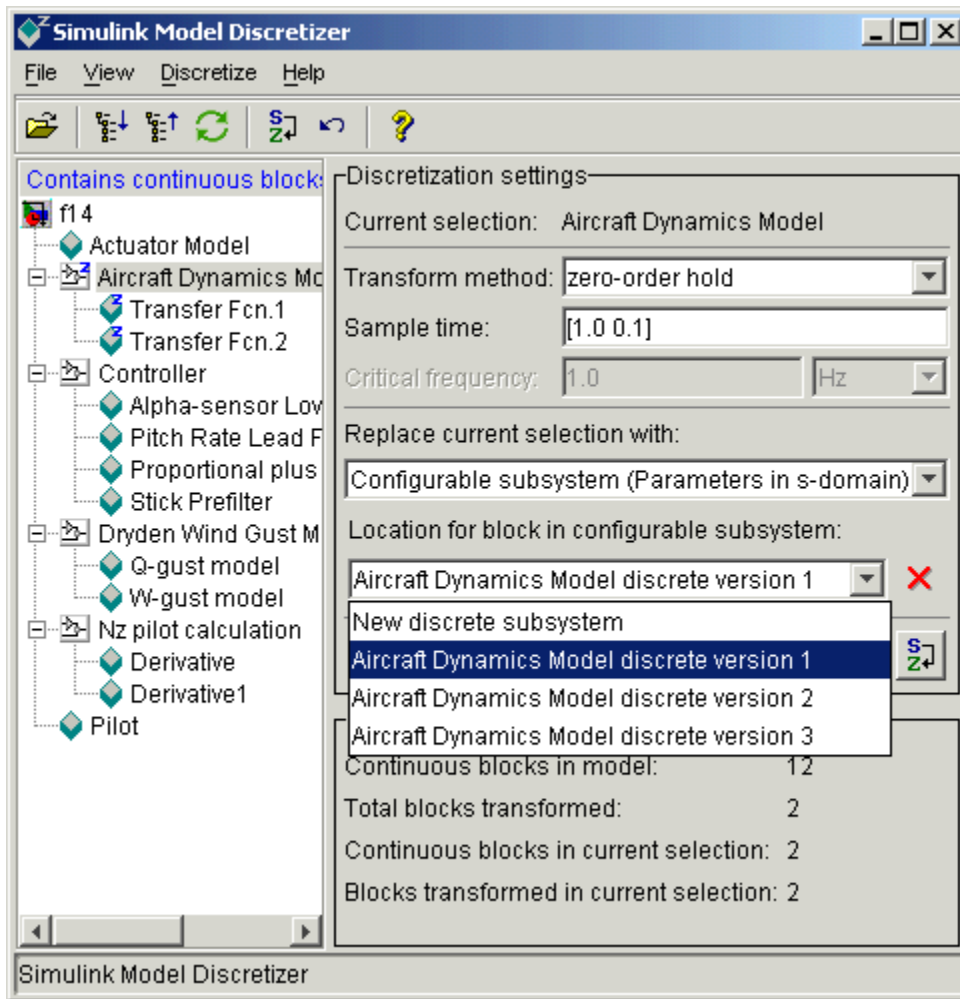

The other blocks in this f14 model have not been discretized.

The following figure shows the Aircraft Dynamics Model subsystem of the f14 example model after discretization into a configurable subsystem containing the original continuous model and three discretization candidates.

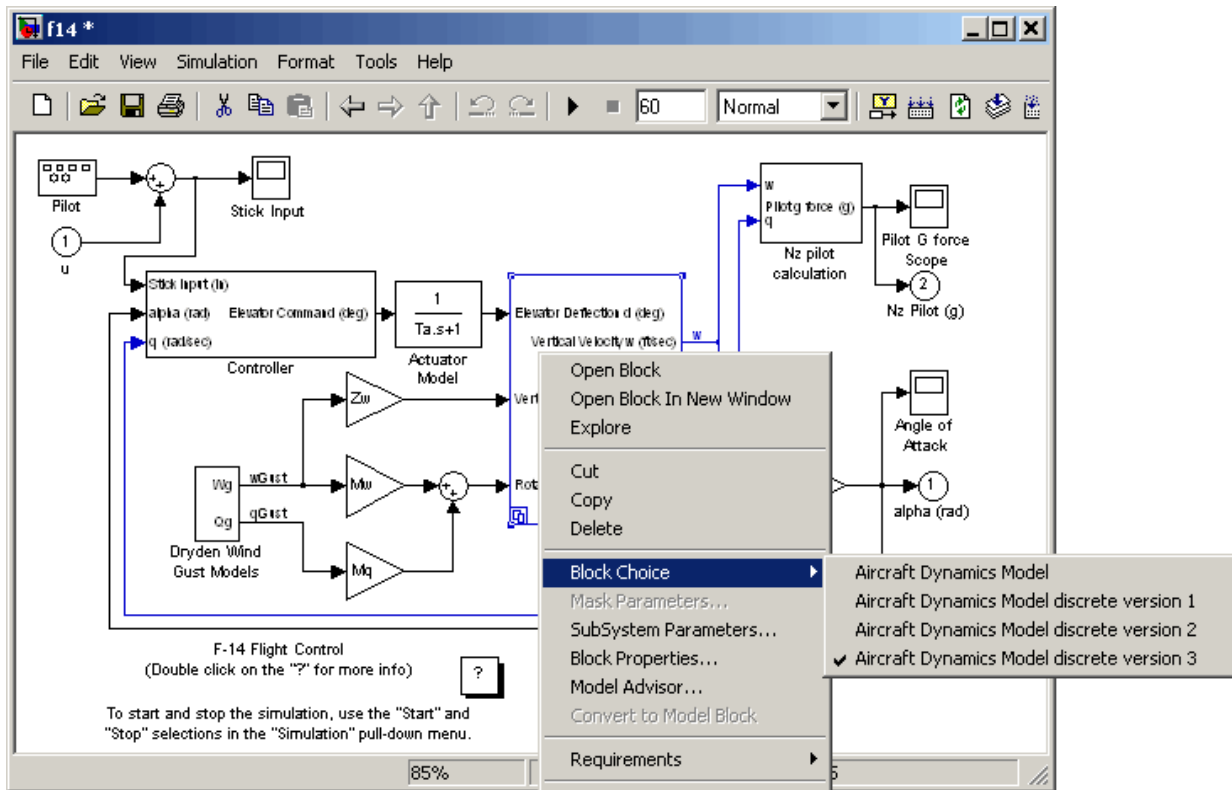

The following figure shows the library containing the Aircraft Dynamics Model configurable subsystem with the original continuous model and three discretization candidates.

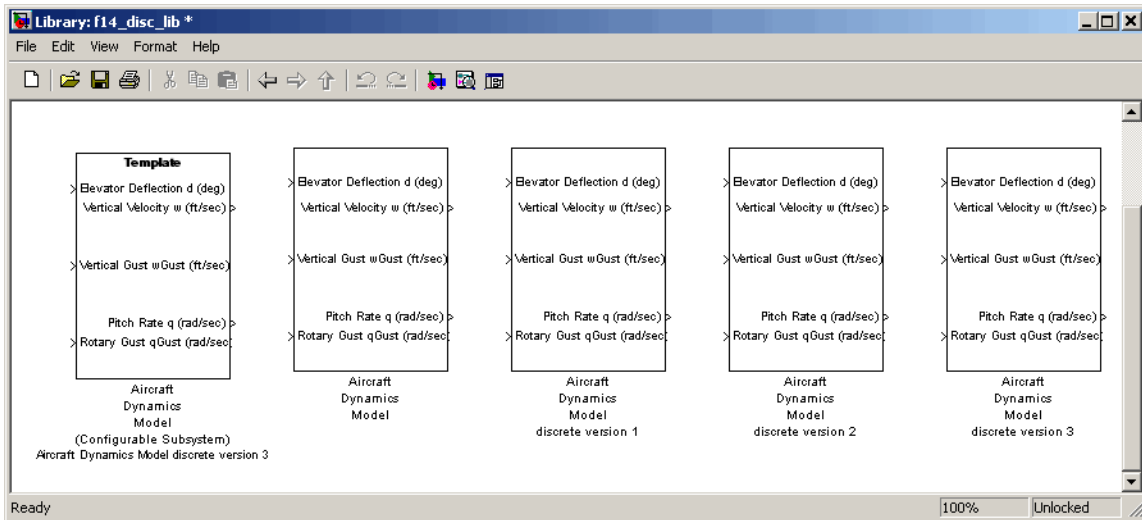

### Refreshing Model Discretizer View of the Model

To refresh Model Discretizer's tree view of the model when the model has been changed, click the **Refresh** button.

Alternatively, you can select **Refresh** from the **View** menu.

### Discretize Blocks from the Simulink Model

You can replace continuous blocks in a Simulink software model with the equivalent blocks discretized in the s-domain using the Discretizing library.

The procedure below shows how to replace a continuous Transfer Fcn block in the Aircraft Dynamics Model subsystem of the f14 model with a discretized Transfer Fcn block from the Discretizing Library. The block is discretized in the s-domain with a zero-order hold transform method and a two second sample time.

- 1 Open the f14 model.
- 2 Open the Aircraft Dynamics Model subsystem in the f14 model.



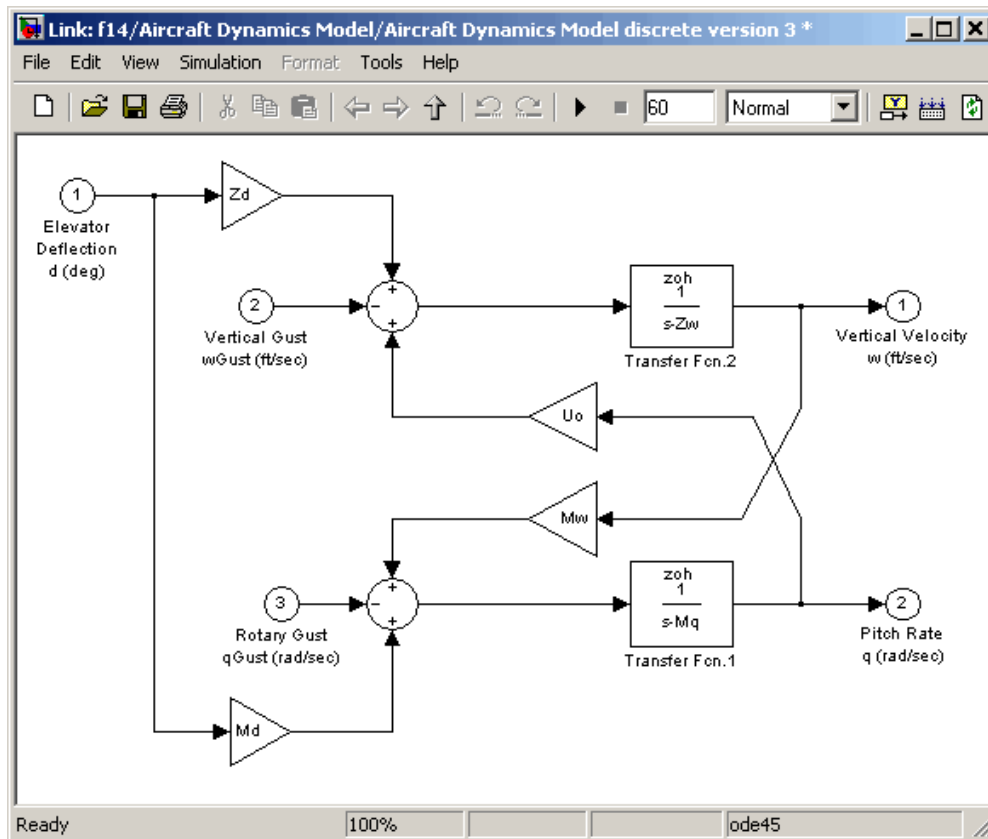

3 Open the Discretizing library window.

Enter discretizing at the MATLAB command prompt.

The **Library: discretizing** window opens.

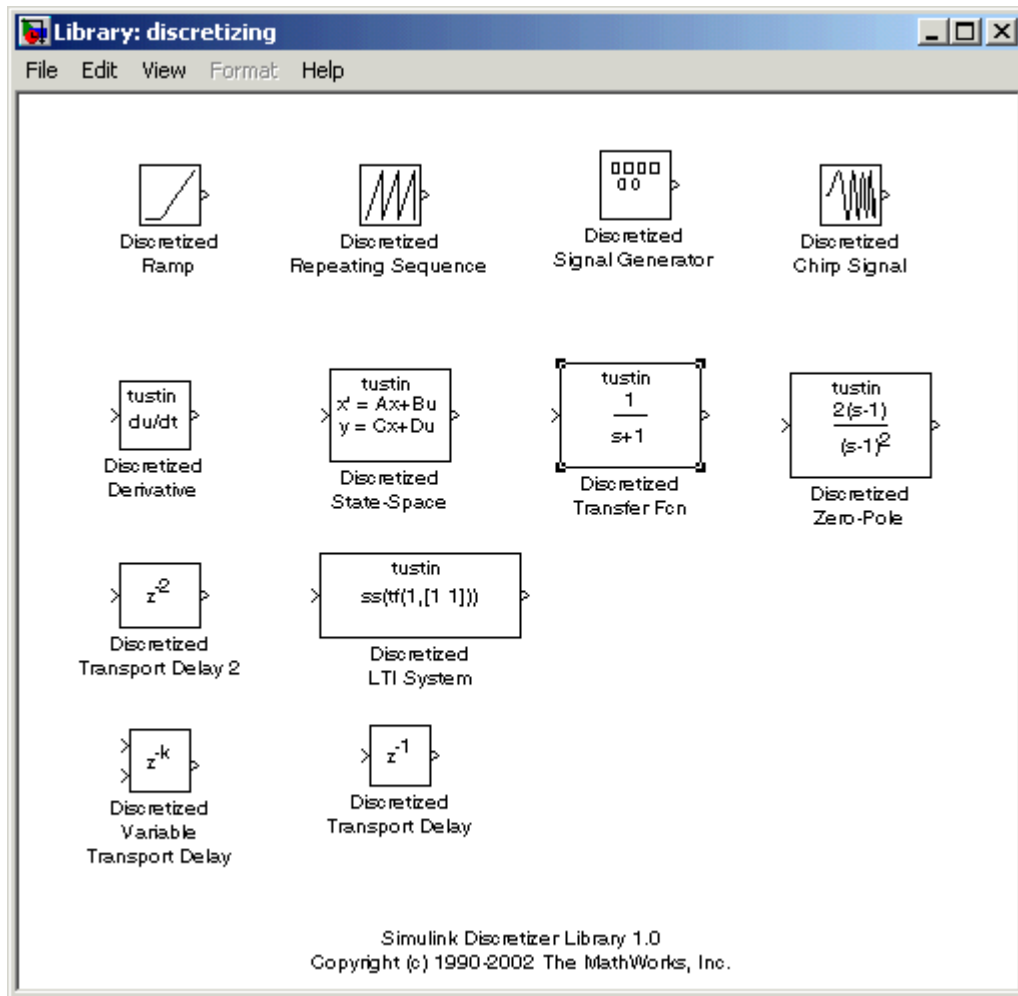

This library contains s-domain discretized blocks.

- 4 Add the Discretized Transfer Fcn (with initial states) block to the **f14/Aircraft Dynamics Model** window.
  - a Click the Discretized Transfer Fcn block in the **Library: discretizing** window.
  - b Drag it into the **f14/Aircraft Dynamics Model** window.

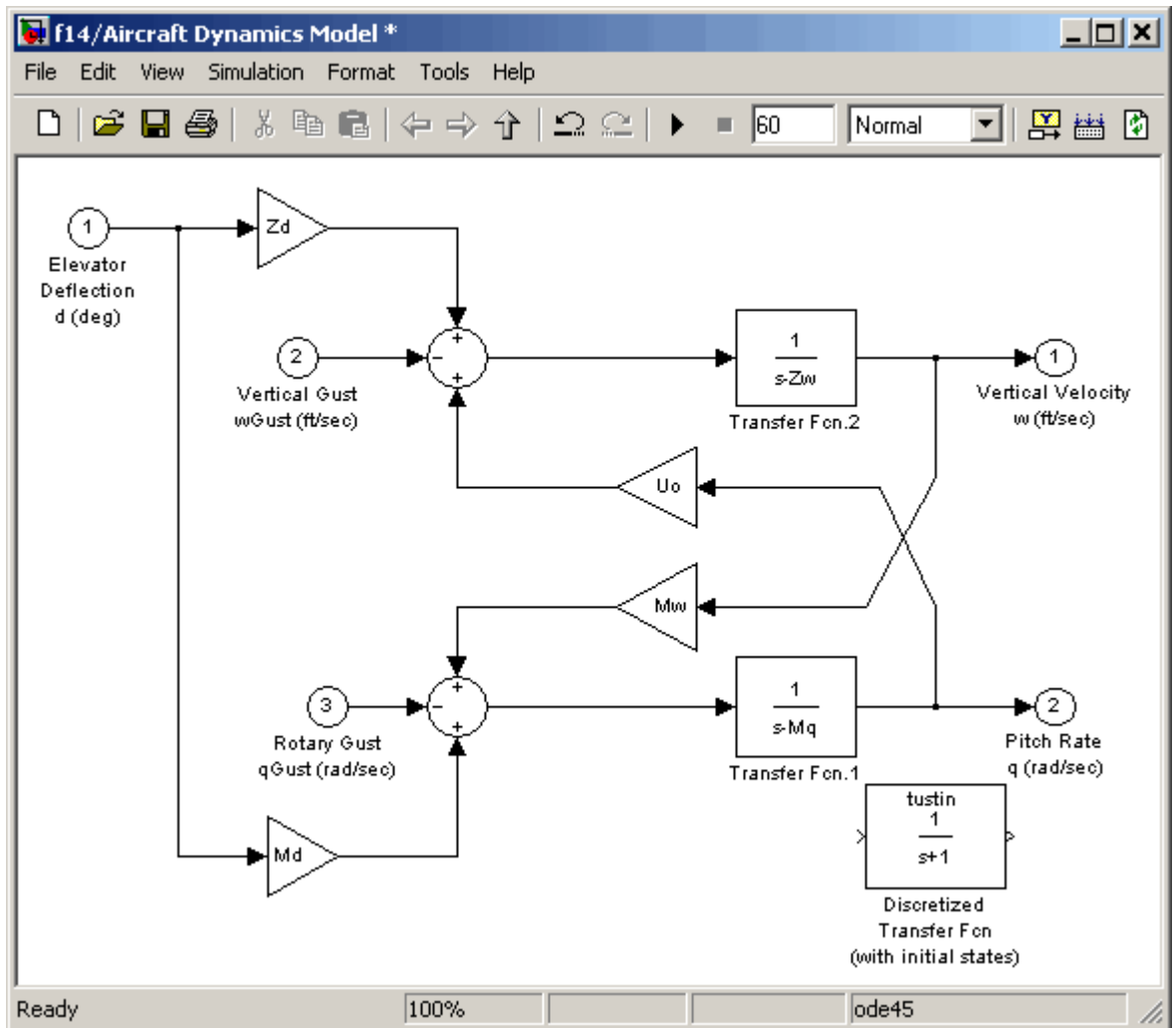

- 5 Open the parameter dialog box for the Transfer Fcn.1 block.

Double-click the Transfer Fcn.1 block in the **f14/Aircraft Dynamics Model** window.

The Block Parameters: Transfer Fcn.1 dialog box opens.

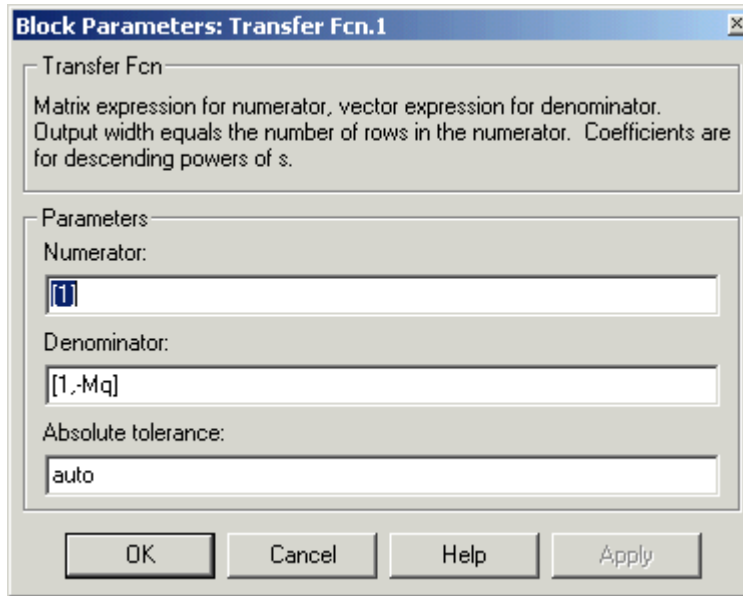

- 6 Open the parameter dialog box for the Discretized Transfer Fcn block.

Double-click the Discretized Transfer Fcn block in the **f14/Aircraft Dynamics Model** window.

The Block Parameters: Discretized Transfer Fcn dialog box opens.

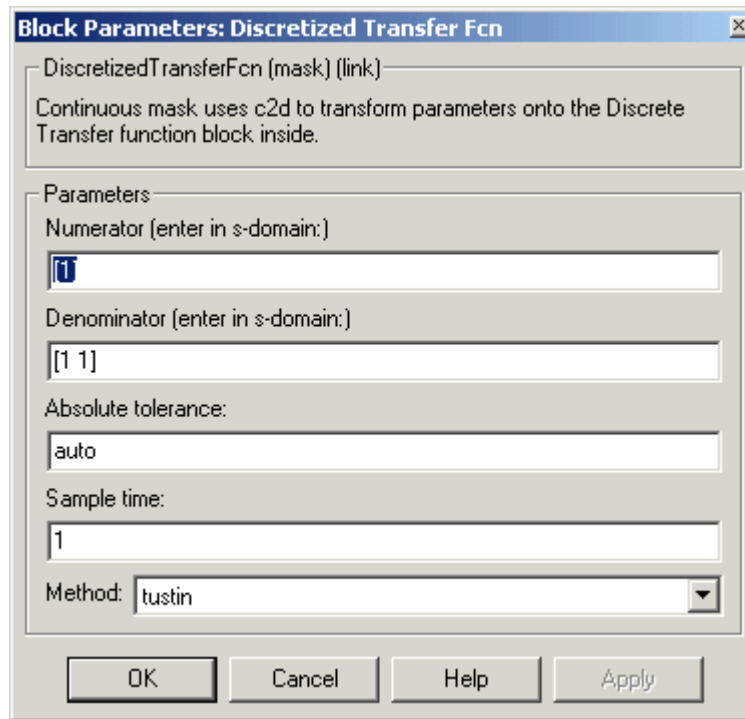

Copy the parameter information from the Transfer Fcn.1 block's dialog box to the Discretized Transfer Fcn block's dialog box.

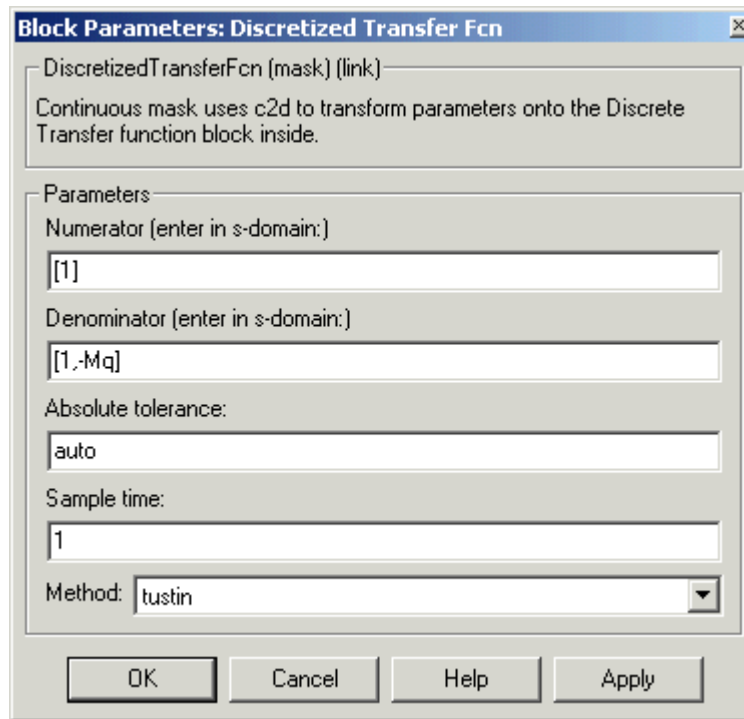

- 7 Enter 2 in the **Sample time** field.
- 8 Select zoh from the **Method** drop-down list.

The parameter dialog box for the Discretized Transfer Fcn now looks like this.

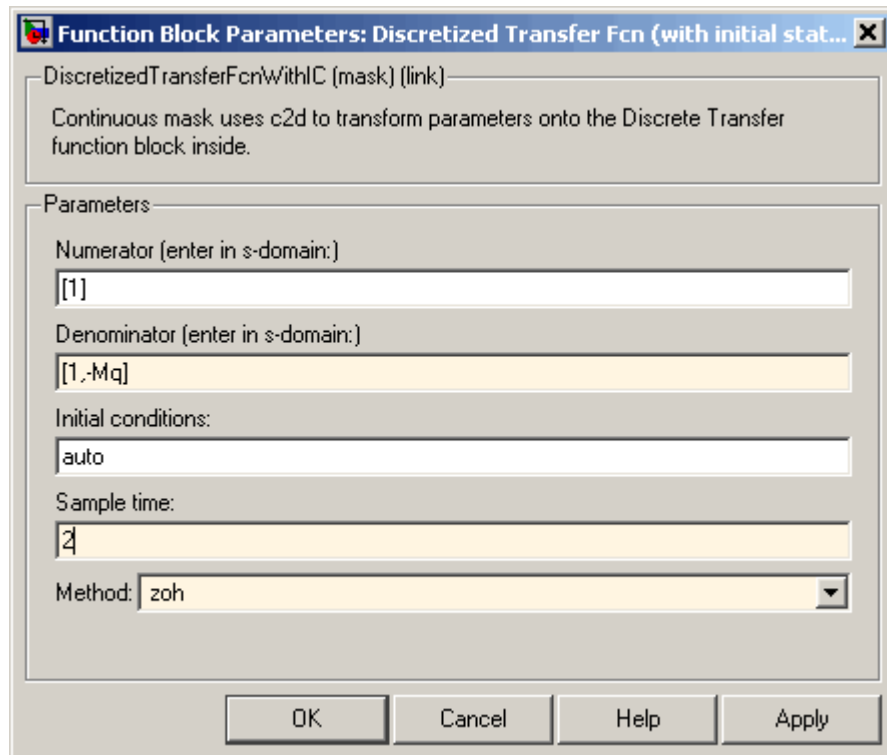

- 9 Click **OK**.

The **f14/Aircraft Dynamics Model** window now looks like this.

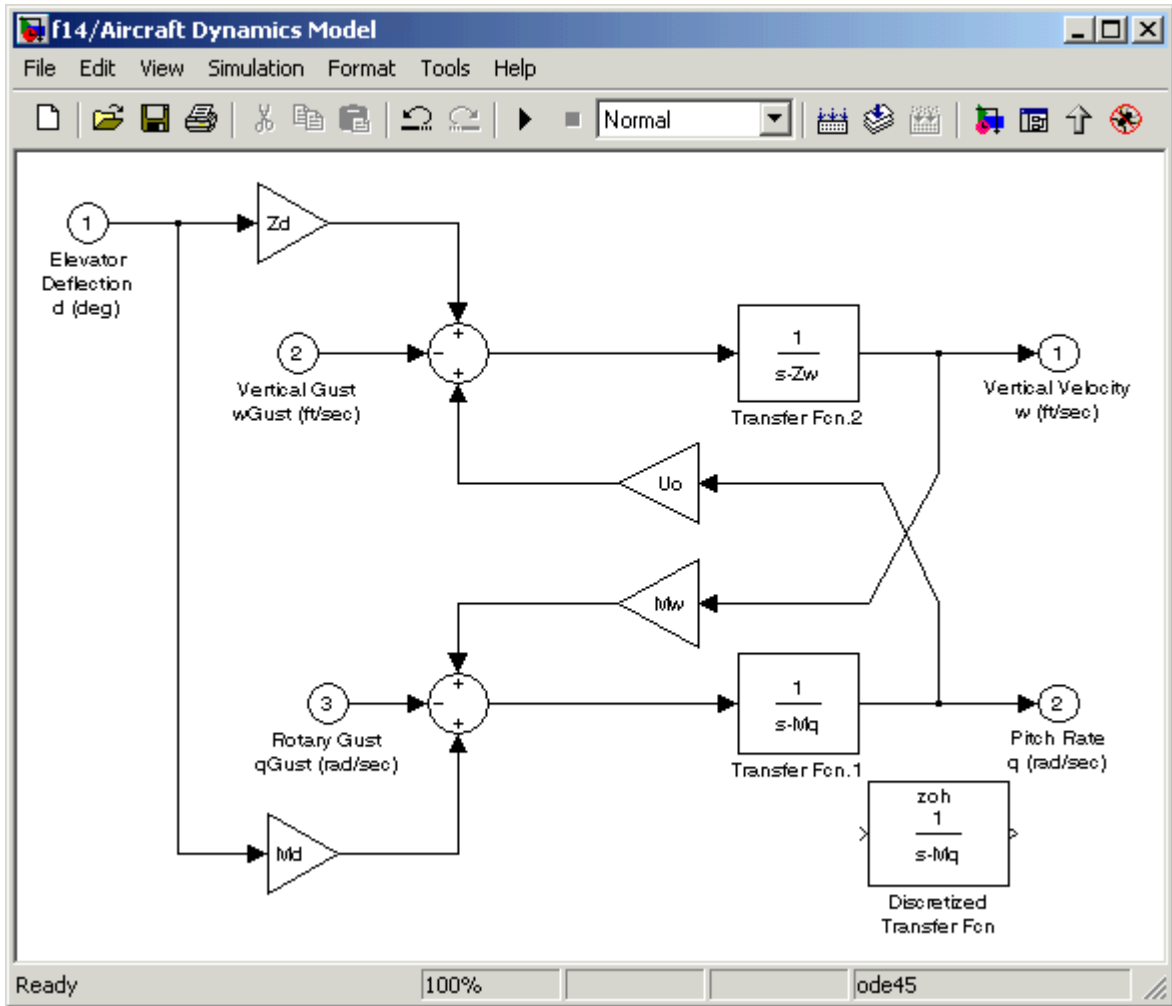

10 Delete the original Transfer Fcn.1 block.

- a Click the Transfer Fcn.1 block.
- b Press the **Delete** key.

The **f14/Aircraft Dynamics Model** window now looks like this.



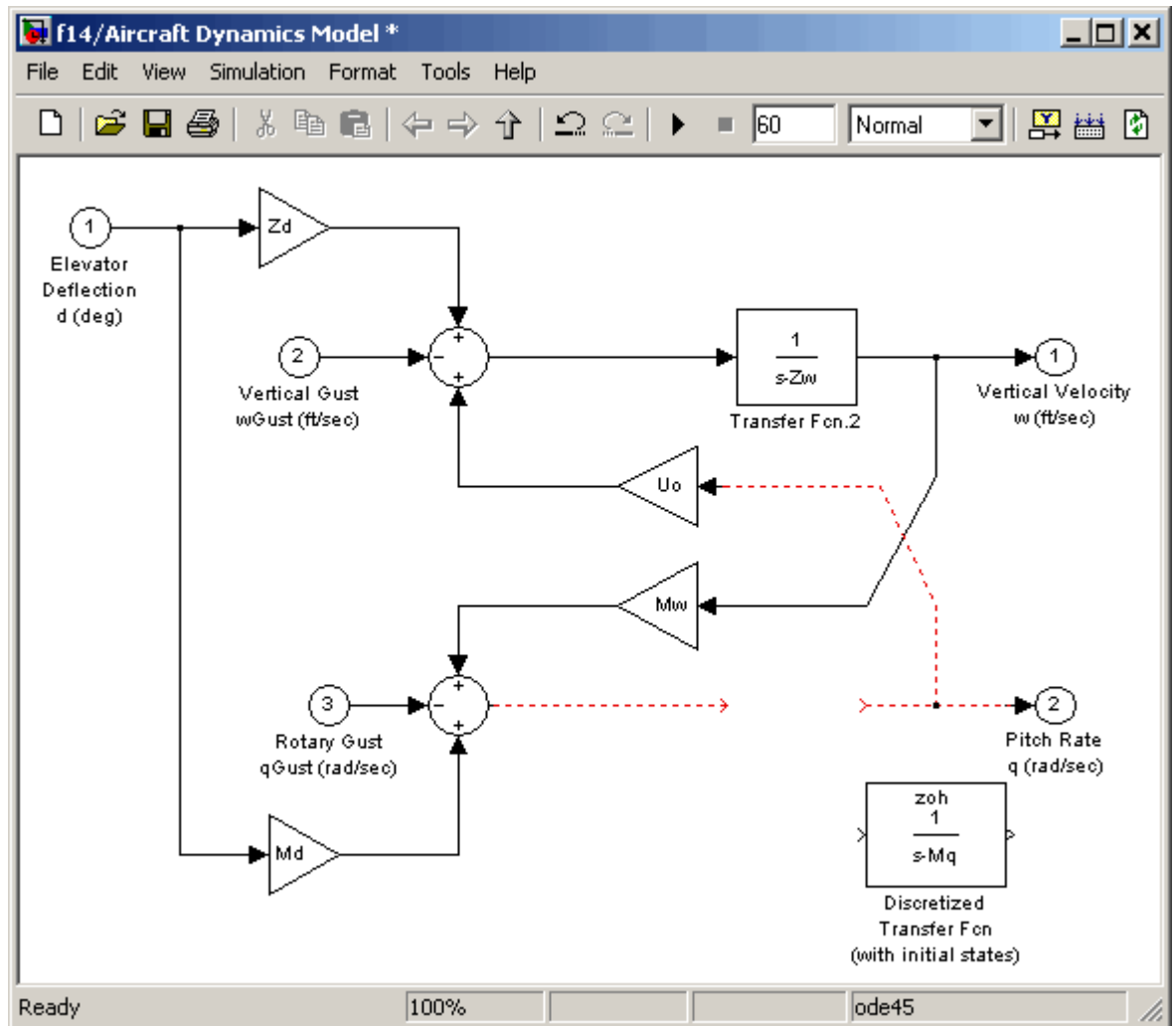

11 Add the Discretized Transfer Fcn block to the model.

- a Click the Discretized Transfer Fcn block.
- b Drag the Discretized Transfer Fcn block into position to complete the model.

The **f14/Aircraft Dynamics Model** window now looks like this.

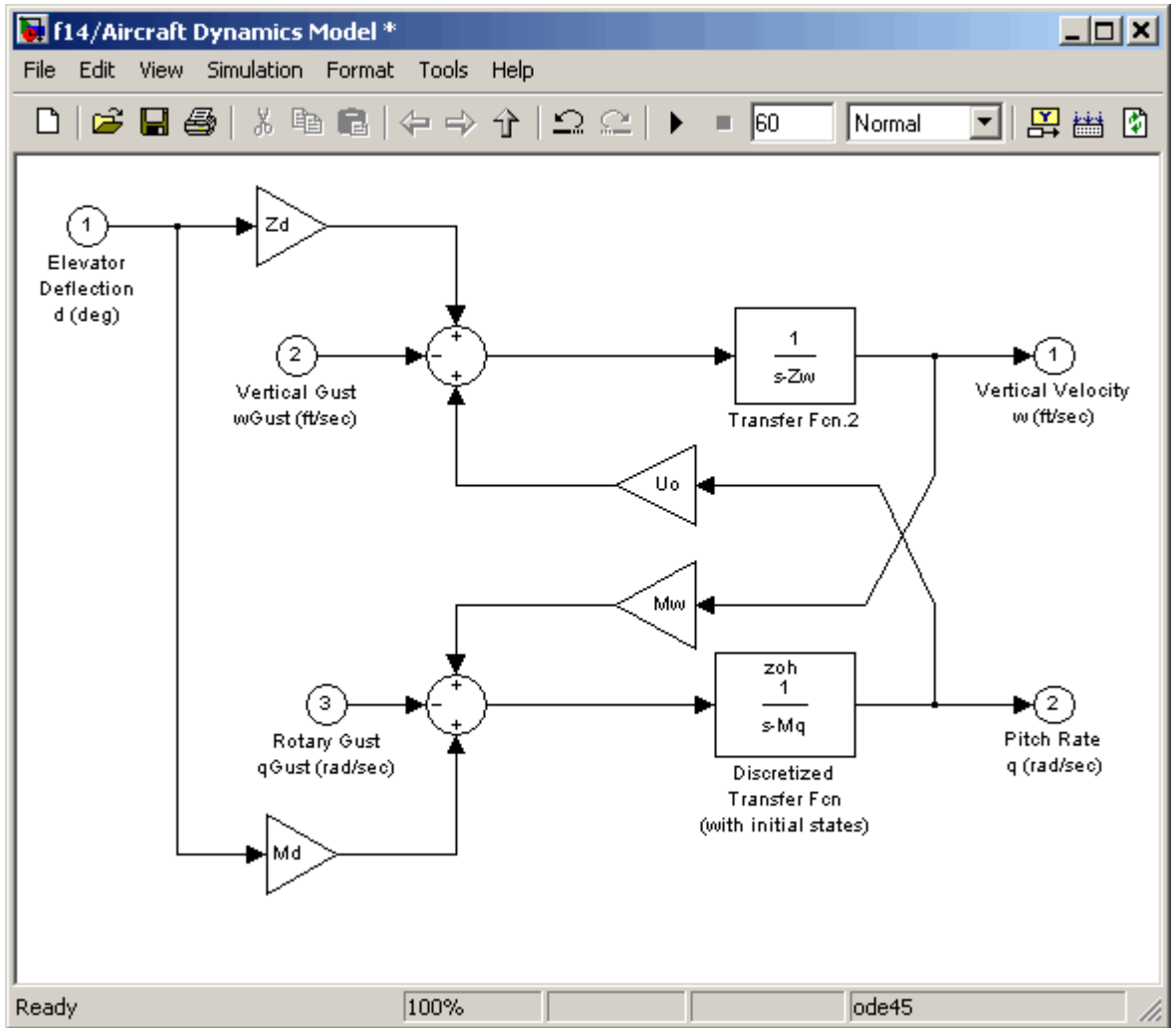

### Discretize a Model with the sldiscmdl Function

Use the `sldiscmdl` function to discretize Simulink software models from the MATLAB Command Window. You can specify the transform method, the sample time, and the discretization method with the `sldiscmdl` function.

For example, the following command discretizes the `f14` model in the s-domain with a 1-second sample time using a zero-order hold transform method:

```
sldiscmdl('f14',1.0,'zoh')
```

## See Also

`sldiscmdl`

## Related Examples

- “Discrete blocks (Enter parameters in s-domain)” on page 4-72
- “Discrete blocks (Enter parameters in z-domain)” on page 4-73
- “Configurable subsystem (Enter parameters in s-domain)” on page 4-74
- “Configurable subsystem (Enter parameters in z-domain)” on page 4-75



# Model Advisor

---

## Select and Run Model Advisor Checks

### Model Advisor Overview

The Model Advisor checks a model or subsystem for conditions and configuration settings including conditions that cause inaccurate or inefficient simulation of the system that the model represents. If you have Simulink Coder or Simulink Verification and Validation, the Model Advisor can check for model settings that cause generation of inefficient code or code unsuitable for safety-critical applications. If you have a Simulink Design Verifier™ license, the Model Advisor can check for design errors. If an error is reported, you can view a test case that reproduces the error.

The Model Advisor produces a report that lists the suboptimal conditions or settings that it finds, and proposes better model configuration settings where appropriate.

Software is inherently complex and may not be completely free of errors. Model Advisor checks might contain bugs. MathWorks® reports known bugs brought to its attention on its Bug Report system at <http://www.mathworks.com/support/bugreports/>. The bug reports are an integral part of the documentation for each release. Examine periodically all bug reports for a release as such reports may identify inconsistencies between the actual behavior of a release you are using and the behavior described in this documentation.

While applying Model Advisor checks to your model will increase the likelihood that your model does not violate certain modeling standards or guidelines, their application cannot guarantee that the system being developed will be safe or error-free. It is ultimately your responsibility to verify, using multiple methods, that the system being developed provides its intended functionality and does not include any unintended functionality.

### To Run Model Advisor Checks:

- 1 Open the Model Advisor example model `sldemo_mdladv`.
- 2 Start the Model Advisor. In the Model Editor, select **Analysis > Model Advisor > Model Advisor** or **Model Advisor Dashboard**. The dashboard preserves the checks used in the previous analysis and allows you to run these same checks without reloading them, saving analysis time.
- 3 In the Model Explorer, in the **Contents** pane, select **Advice for *model*.*model*** is the name of the model that you want to check.

- 4 In the Model Editor, right-click the subsystem that you want to check, and in the context menu select **Model Advisor**.
- 5 At the command prompt, enter `modeladvisor('sldemo_mdladv')`.
- 6 In the System Selector dialog box, select the model or system that you want to analyze, for example, `sldemo_mdladv`. Click **OK**.
- 7 In the left pane of the Model Advisor, expand the **By Product** and **By Task** folders to display the subfolders. The **By Task** folders display checks related to specific tasks. For example, to run checks to determine if your model is configured for simulation accuracy, select checks in the **Simulation Accuracy** folder.

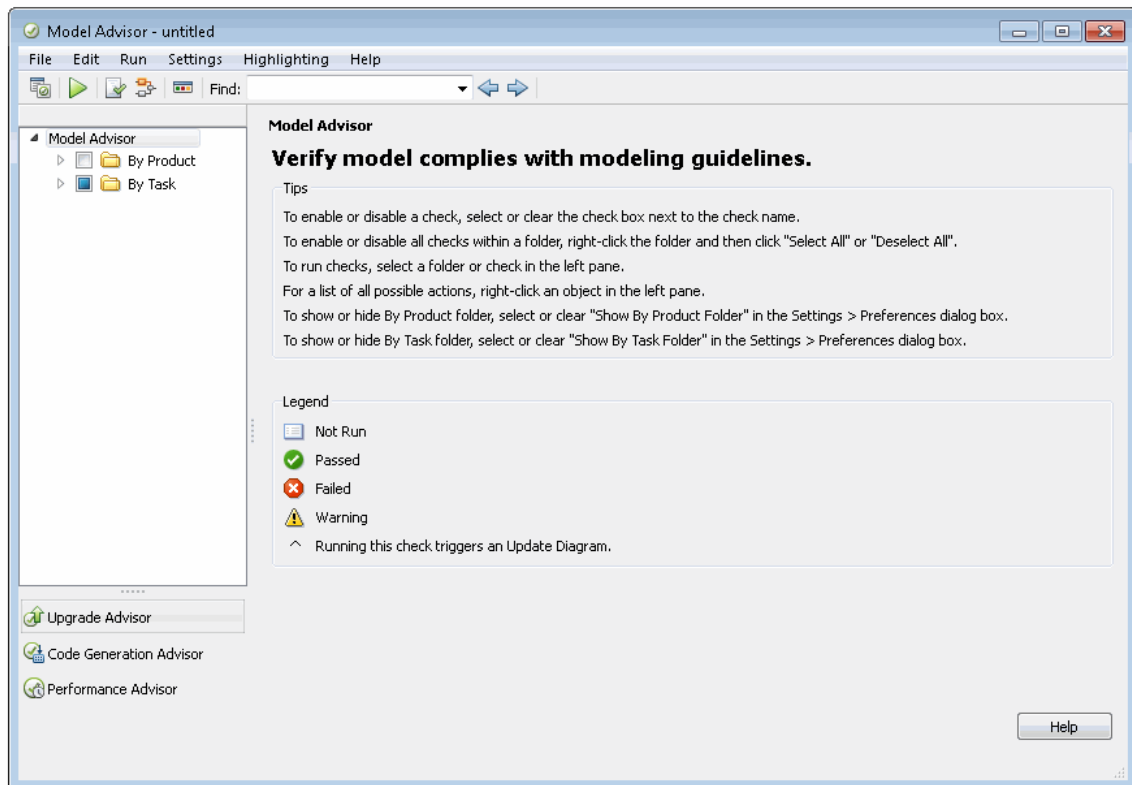

- 8 The **By Product** folders display checks available with specific products.
- 9 Select **Settings > Preferences** to control the folders that display.

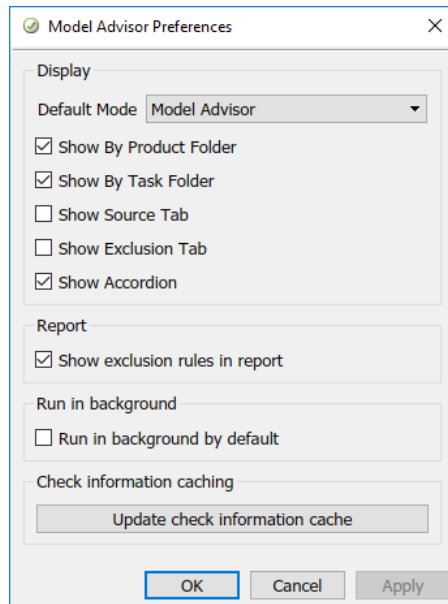

- 10 In the left pane, select the checks to run on your model. For example, select the checks in the **By Product > Simulink** folder.

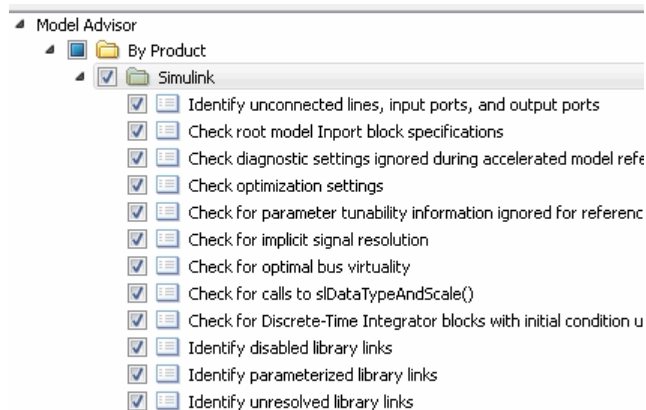



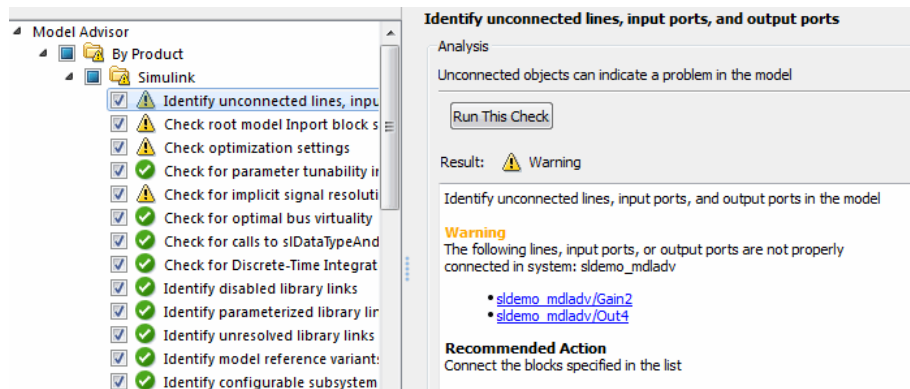

## To display an HTML report of check results:

- 1 In the right pane of the Model Advisor, select **Show report after run**.
- 2 In the menu bar, click **Run Selected Checks** or . After the Model Advisor runs the checks, the results appear in a browser if you selected the option to show the report.
- 3 In the Model Advisor Report window, reset the status of the checks to **Not Run** by highlighting **Model Advisor** in the tree. In the Model Advisor window, right-click the left pane and select **Reset**.
- 4 Exclude the **Gain3** block from Model Advisor Analysis. In the Simulink Model Editor window, right-click the **Gain3** block. From the context menu, select **Model Advisor > Exclude block only > All checks**. **Gain3** is no longer analyzed. For more information, see “Limit Model Checks” (Simulink Verification and Validation).
- 5 In the Model Advisor, expand the Simulink folder. Select **Identify unconnected lines, input ports, and output ports**. To examine and execute a check individually, use this view.



- 6 In the Model Advisor, click the **Enable highlighting** button . You can highlight the results of checks that display the  icon. In the model, the blocks causing the warning appear highlighted. The Model Advisor Highlighting dialog box also opens, and you can click the link to view the results in a browser.

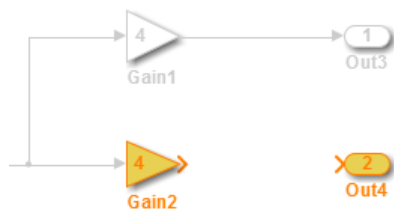

After reviewing the check results in the Model Advisor window, you can choose to fix warnings or failures. See “Address Model Check Results” on page 5-14 for more information.



Several limitations apply to Model Advisor analysis. See “Model Advisor Limitations” on page 5-9 for more information.

## Set Model Advisor Window Preferences

To open the Model Advisor Preferences dialog box, on the toolbar, select **Settings > Preferences**.

Action	Select
Display the check available for each product.	<b>Show By Product Folder</b>
Display checks related to specific tasks.	<b>Show By Task Folder</b>
Display the check Title, TitleId, and location of the MATLAB source code for the check.	<b>Show Source Tab.</b> The <b>Source</b> tab displays check source information.
Display checks that are excluded from the Model Advisor analysis.	<b>Show Exclusion tab.</b> The <b>Exclusions</b> tab displays checks that are excluded from the Model Advisor analysis.



## Display and Run Checks

Action	Model Advisor Options
Display checks related to specific tasks.	Select <b>By Task</b> .
Display the check available for each product.	Select <b>By Product</b> .
Find checks and folders.	Enter text in the <b>Find:</b> field and click the <b>Find Next</b> button (  ). The Model Advisor searches in check names, folder names, and analysis descriptions.
Reset the status of the checks to not run.	Right-click <b>Model Advisor</b> in the left pane and select <b>Reset</b> from the context menu.
Select some or all of the checks.	Select the check and folder check boxes.
Run the selected checks.	On the toolbar of the Model Advisor window, click <b>Run selected checks</b> (  ).

## Run the Same Set of Checks Consistently

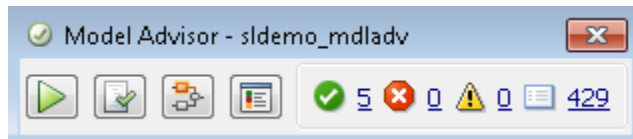
To consistently run the same set of checks on your model, use the Model Advisor dashboard.



Action	Option
Select and view checks.	In the Model Advisor window, click the <b>Switch to standard view</b> toggle (  .
Run checks.	Click <b>Run checks</b> (  .
View the report in a separate browser window.	Click <b>Open Report</b> .

Action	Option
View highlighted results.	Click the <b>Enable highlighting</b> toggle (  ).

## Run Model Checks Programmatically

If you have a license for Simulink Verification and Validation, you can create MATLAB scripts and functions that run the Model Advisor programmatically. For example, you can create a function to check whether your model passes a specified set of the Model Advisor checks every time that you open the model and start a simulation. If you have Simulink Coder, the function can generate code from the model. For more information, see `ModelAdvisor.run`.

## Access Other Advisors

You can use the Model Advisor window to access other Advisors.

Action	Select
Configure your model to meet code generation objectives.	<b>Code Generation Advisor.</b> See “Application Objectives Using Code Generation Advisor” (Simulink Coder).
Upgrade and improve models with the current release.	<b>Upgrade Advisor.</b> See “Consult the Upgrade Advisor” on page 6-2.
Improve the simulation performance of your model.	<b>Performance Advisor.</b> See “Improve Simulation Performance Using Performance Advisor” on page 30-2.

## See Also

“Simulink Checks” | “Optimization Tools and Techniques” (Simulink Coder) | “Simulink Coder Checks” (Simulink Coder) | “Create Model Advisor Checks” (Simulink Verification and Validation) | “Model Guidelines Compliance” (Simulink Verification and Validation) | “Design Error Detection” (Simulink Design Verifier) | “Limit Model Checks” (Simulink Verification and Validation)

## Model Advisor Limitations

When you use the Model Advisor to check systems, the following limitations apply:

- If you rename a system, you must restart the Model Advisor to check that system.
- In systems that contain a variant subsystem, the Model Advisor checks only the active subsystem.
- Model Advisor does not analyze commented blocks.
- Checks do not search in Model blocks or Subsystem blocks with the block parameter **Read/Write** set to **NoReadorWrite**. However, on a check-by-check basis, Model Advisor checks do search in library blocks and masked subsystems.

For limitations that apply to specific checks, see the “Capabilities and Limitations” section in the check documentation. For example, for capabilities that apply to the **Identify unconnected lines, input ports, and output ports** check, see “Capabilities and Limitations”.

## Save Model Analysis Time

You can save analysis time by consistently run the same set of checks on your model using the Model Advisor dashboard. When you use the dashboard, the Model Advisor does not reload the checks before executing them, saving analysis time.

To run checks on your model using the Model Advisor dashboard:

- 1 Open your model. For example, open the Model Advisor model, `sldemo_md1adv`.
- 2 Start the Model Advisor dashboard.
  - a From the Simulink Editor, select **Analysis > Model Advisor > Model Advisor Dashboard**.



Alternatively, from the Simulink Editor toolbar  drop-down list, select **Model Advisor Dashboard**.

- b In the System Selector window, select the model or system that you want to review. For example, `sldemo_md1adv`. Click **OK**.

The Model Advisor dashboard opens.

- 3 Optionally, to select or view checks to run on your model, click the **Switch to standard view** toggle (). The Model Advisor window opens.
  - a For example, in the Model Advisor window, open the **By Product** folder and select checks:
    - Identify unconnected lines, input ports, and output ports**
    - Check root model Inport block specifications**

If the **By Product** folder is not displayed in the Model Advisor window, select **Show By Product Folder** from the **Settings > Preferences** dialog box.

- b Return to the Model Advisor dashboard by clicking the **Switch to Model Advisor Dashboard** toggle ().
- 4 On the Model Advisor dashboard, click **Run checks** ().
- 5 Click the **Enable Highlighting** toggle () to view highlighted results.

- The model window opens. The blocks causing the **Identify unconnected lines, input ports, and output ports** check warning are highlighted in yellow.

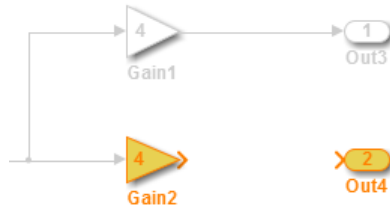

- The Model Advisor Highlighting information window opens with a link to the Model Advisor window. In the Model Advisor window, you can find more information about the check results and how to fix the warning condition.

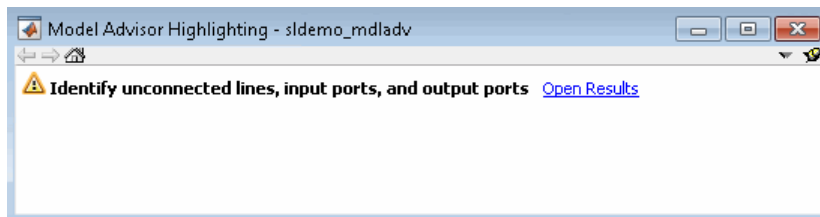

- 6 After reviewing the check results, you can choose to fix warnings or failures. For example, to fix the **Identify unconnected lines, input ports, and output ports** check warning:
  - a Connect model blocks Gain2 and Out4.
  - b On the Model Advisor dashboard, click **Run checks** (▶) to rerun the checks.

The **Identify unconnected lines, input ports, and output ports** check passes.

## Related Examples



- “Address Model Check Results” on page 5-14
- “Select and Run Model Advisor Checks” on page 5-2



## More About

- “Select and Run Model Advisor Checks” on page 5-2

## Run Model Checks in Background

If you have a Parallel Computing Toolbox license, you can run the Model Advisor in the background, allowing you to continue working on your model during analysis. When you start a Model Advisor analysis run in the background, Model Advisor takes a snapshot of your model. The analysis does not reflect changes that you make to your model while Model Advisor is running in the background.

- 1 Open your model.
- 2 Start the Model Advisor.
  - a From the Simulink Editor, select **Analysis > Model Advisor > Model Advisor**.
  - b In the System Selector window, select the model or system that you want to review.
- 3 In the Model Advisor window, click the **Run checks in background** toggle ()
- 4 In the left pane of the Model Advisor window, select the checks that you want to run.
- 5 In the Model Advisor window, select **Run selected checks** ().

Alternatively, you can use the Model Advisor dashboard to run the checks. In the Model Advisor window, switch to the Model Advisor dashboard by clicking the **Switch to Model Advisor Dashboard** toggle (). On the Model Advisor dashboard, click **Run selected checks** ().

The Model Advisor starts an analysis on a parallel processor.

- 6 To stop running checks in the background, in the Model Advisor window, click **Stop background run** (). In the lower-left pane, you see a status of the analysis.

The **Explore Result** option is not available for checks that are run in the background.

### Related Examples

- “Address Model Check Results” on page 5-14
- “Select and Run Model Advisor Checks” on page 5-2



## **More About**

- “Select and Run Model Advisor Checks” on page 5-2

## Address Model Check Results

To run the Model Advisor to find warnings or failures in your model:



- Open the model `sldemo_md1adv`. From the toolbar, select **Analysis > Model Advisor > Model Advisor**. Select checks **By Product > Simulink**.
- On the toolbar of the Model Advisor window, click **Run selected checks** (). The Model Advisor will run and will find warnings or failures in the model. For more information, see “Select and Run Model Advisor Checks” on page 5-2.

To address checks and fix errors and warnings after running the Model Advisor, first optionally highlight the check results, then make modifications to your model to comply with check criteria. See “Address Model Check Results with Highlighting” on page 5-14.

### Address Model Check Results with Highlighting

To indicate the analysis results for individual Model Advisor checks, use color highlighting on the model diagram. Highlighting is available for Simulink blocks and Stateflow charts. Blocks that pass a check, fail a check, or cause a check warning are highlighted in color in the model window. On the toolbar of the Model Advisor window, click **Enable highlighting** () , select **Highlighting > Enable Highlighting**.

After selecting the highlighting feature, the model window and a Model Advisor Highlighting information window open. The Model Advisor Highlighting information window provides a link to the Model Advisor window where you can review the check results.

Yellow with orange border		Blocks that cause the check failure or warning.
White with orange border		Subsystem with blocks that cause the check warning or failure.

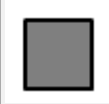
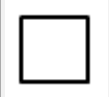
White with gray border		Blocks or subsystems without highlighting.
Gray with black border		Blocks that are excluded from the check.
White with black border		Subsystems that are excluded from the check.

If a check warns or fails, and the model window highlights blocks in gray, closely examine the results in the Model Advisor window. A Model Advisor check can fail or warn due to your parameter or diagnostic settings.

After you run a Model Advisor analysis and select the highlighting feature, checks with highlighted results are indicated with an  icon in the Model Advisor window. Highlighting is not available for some checks. Selecting **By Product > Simulink** displays Model Advisor checks in the Model Advisor Highlighting window that do not highlight results.

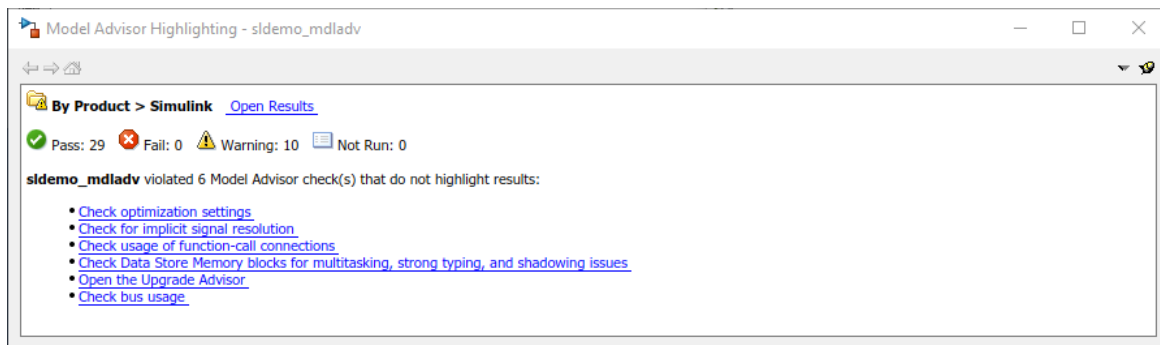

In the left pane of the Model Advisor window, select the highlighted check **Identify unconnected lines, input ports, and output ports**. In the model editor window, the Model Advisor highlights the blocks or components related to the warning. In this case, the Model Advisor finds a **Gain** block and an **Output** block not properly connected to the model.

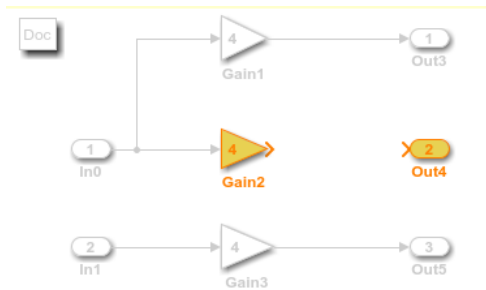

The right pane of the Model Advisor window provides further information about the warning.

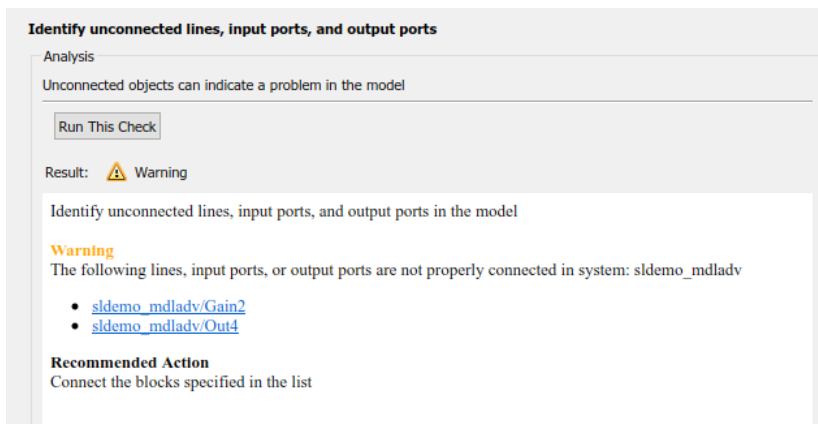

The **Recommended Action** suggests how to fix the warning or error. In this case connect the disconnected blocks.

In the left pane of the Model Advisor window, select the highlighted check **Identify questionable operations for strict single-precision design**. In the model editor window, the Model Advisor highlights the blocks or components related to the warning. In this case, the Model Advisor finds an output block that uses double precision due to a setting of the **Configuration Parameter Default for underspecified data type**.



The right pane of the Model Advisor window gives further detail on the single-precision warning.

**Identify questionable operations for strict single-precision design**

Analysis (^ Triggers Update Diagram)

This check helps enforce a strict single-precision design by identifying double-precision operations and non-optimal model settings.

Result: Warning

**Check model settings related to single-precision design**  
This check verifies the status of model settings that will help you achieve a strict single-precision design.

**Warning**  
The following model settings are non-optimal to a single-precision design:

Model Name	Configuration Parameter	Current Value	Recommended Value
<a href="#">sldemo_mdldv</a>	<a href="#">Implement logical signals as Boolean data (vs. double)</a>	off	on
	<a href="#">Default for underspecified data type</a>	double	single
	<a href="#">Standard math library</a>	C89/C90 (ANSI)	C99 (ISO)

**Check for double precision operations**  
This check identifies blocks that introduce double-precision operations. For each block that the check identifies, make sure that its port data types and intermediate settings are set correctly.

**Warning**  
The following blocks use double-precision floating-point operations:

- [sldemo\\_mdldv/Out4](#)

The default input of the output block is set to **double** and Model Advisor gives a warning because the **output** block is not connected. After reviewing the check results in the model window and the Model Advisor window, you can choose to fix warnings or failures. See “Fix a Model Check Warning or Failure” on page 5-18.

To view model blocks that are excluded from the Model Advisor checks, on the Model Advisor window toolbar, select **Highlighting > Highlight Exclusions**. If you have Simulink Verification and Validation, you can create or modify exclusions to the Model Advisor checks.

### Fix a Model Check Warning or Failure

When a model or referenced model has a suboptimal condition, checks may fail. A warning result is informational. You can fix the reported issue, or move on to the next task. For more information on why a specific check does not pass, see the documentation for that check. See “Check Your Model Interactively” (Simulink Verification and Validation).

#### Manually Fix Warnings or Failures

To manually fix warnings or failures, checks have an Analysis Result box that describes the recommended actions.

- 1 Optionally, save a model and data restore point so that you can undo your changes. See “Save Model Advisor Reports” on page 5-22.
- 2 In the Analysis Result box, review the recommended actions to make changes to your model.
- 3 To verify that the check passes, rerun the check. See “Run the Same Set of Checks Consistently” on page 5-7.

When you fix a warning or failure, rerun all checks to update the results of all checks. If you do not rerun all checks, the Model Advisor can report an invalid check result.

#### Automatically Fix Warnings or Failures

Some checks have an Action box that you can use to automatically fix failures. The action box applies all of the recommended actions listed in the Analysis Result box.

- 1 Optionally, save a model and data restore point so that you can undo your changes. See “Save Model Advisor Reports” on page 5-22.
- 2 In the Action box, click **Modify All** or **Modify**.

The Action Result box displays a table of changes.

- 3 To verify that the check passes, rerun the check.

When you fix a warning or failure, rerun all checks to update the results of all checks. If you do not rerun all checks, the Model Advisor can report an invalid check result.

### Batch-Fix Warnings or Failures

Some checks have an **Explore Result** button that opens the Model Advisor Result Explorer. With the Model Advisor Result Explorer, you can quickly locate, view, and change elements of a model.

The Model Advisor Result Explorer helps you to modify only the items that the Model Advisor is checking.

If a check does not pass, and you want to explore the results and make batch changes:

- 1 Optionally, save a model and data restore point so that you can undo your changes. See “Save Model Advisor Reports” on page 5-22.
- 2 In the Analysis box, click **Explore Result**.
- 3 In the Model Advisor Result Explorer, you can modify block parameters.
- 4 In the Model Advisor window, rerun the check to verify that it passes.

When you fix a warning or failure, rerun all checks to update the results of all checks. If you do not rerun all checks, the Model Advisor can report an invalid check result.

### Revert Changes

The Model Advisor provides a model and a data restore point capability for reverting changes that you made in response to recommendations from the Model Advisor. You can also restore the default configuration of the Model Advisor. A *restore point* is a snapshot in time of the model, base workspace, and Model Advisor. The Model Advisor maintains restore points for the model or subsystem through multiple sessions of MATLAB.

---

**Note:** A restore point saves only the current working model, base workspace variables, and Model Advisor tree. It does not save other items, such as libraries and referenced models.

---

### Restore Default Configuration

In the Model Advisor window, select **Settings > Restore Default Configuration**.

### Save a Restore Point

You can save a restore point and give it a name and description. Or, the Model Advisor can name the restore point.

- 1 In the Model Advisor window, select **File > Save Restore Point As**.
- 2 In the **Name** field, enter a name for the restore point.
- 3 In the **Description** field, you can optionally add a description to help identify the restore point.
- 4 Click **Save**.

The Model Advisor saves a restore point of the current model, base workspace, and Model Advisor status.

To quickly save a restore point, in the Model Advisor window, select **File > Save Restore Point**. The Model Advisor saves a restore point with the name **autosaven.n**. *n* is the sequential number of the restore point. If you use this method, you cannot change the name of, or add a description to, the restore point.

### Load a Restore Point

- 1 Optionally, save a model and data restore point so that you can undo your changes.
- 2 Select **File > Load Restore Point**.
- 3 In the Load Model and Data Restore Point dialog box, select the restore point that you want.
- 4 Click **Load**.

The Model Advisor issues a warning that the restoration removes changes that you made after saving the restore point.

- 5 Click **Load** to load the restore point that you selected.

The Model Advisor reverts the model, base workspace, and Model Advisor status.

### Related Examples

- “Select and Run Model Advisor Checks” on page 5-2



## **More About**

- “Select and Run Model Advisor Checks” on page 5-2

# Save and View Model Advisor Reports

When the Model Advisor runs checks, it generates an HTML report of check results. By default, the HTML report is in the `slprj/modeladvisor/model_name` folder.

If you have a Simulink Verification and Validation license, you can generate reports in Adobe® PDF and Microsoft Word .docx formats.

## Save Model Advisor Reports

The Model Advisor uses the `slprj` folder in the code generation folder to store reports and other information. If the `slprj` folder does not exist in the code generation folder, the Model Advisor creates it.

You can save a Model Advisor report to a new location.

- 1 In the Model Advisor window, navigate to the folder with the checks that you ran.
- 2 Select the folder. The right pane of the Model Advisor window displays information about that folder. The pane includes a **Report** box.
- 3 In the Report box, click **Generate Report**.
- 4 In the Generate Model Advisor Report dialog box, enter the path to the folder where you want to generate the report. Provide a file name.
- 5 Click **OK**. The Model Advisor saves the report in HTML format to the location that you specified.

If you rerun the Model Advisor, the report is updated in the working folder, not in the location where you archived the original report.

The full path to the report is in the title bar of the report window.

## View Model Advisor Reports

Access a report by selecting a folder and clicking the link in the **Report** box. Or, before a Model Advisor analysis, in the right pane of the Model Advisor window, select **Show report after run**.

---

**Tip:** Use the Model Advisor window to interactively fix warnings and failures. Model Advisor reports are best for viewing a summary of checks.

---

As you run checks, the Model Advisor updates the reports with the latest information for each check in the folder. When you run the checks at different times, an informational message appears in the report. Time stamps indicate when checks have been run. The time of the current run appears at the top right of the report. Checks that occurred during previous runs have a time stamp following the check name.

To	Action
Display results for checks that pass, warn, or fail.	Use the <b>Filter checks</b> check boxes. For example, to display results for only checks that warn, in the left pane of the report, select the Warning check box. Clear the <b>Passed</b> , <b>Failed</b> , and <b>Not Run</b> check boxes.
Display results for checks with keywords or phrases in the check title.	Use the <b>Keywords</b> field. Results for checks without the keyword in the check title are not displayed in the report. For example, to display results for only checks with “setting” in the check title, in the <b>Keywords</b> field, enter “setting”.
Quickly navigate to sections of the report.	Select the links in the table-of-contents navigation pane.
Expand and collapse content in the check results.	Click <b>Show/Hide check details</b> .
Scroll to the top of the report.	Click <b>Scroll to top</b> .
Minimize folder results in the report.	Click the minus sign next to the folder name.

Printed versions of the report do not contain:

- Filtering checks, Navigation, or View panes.
- Content hidden due to filtering or keyword searching.

Some checks have input parameters specified in the right pane of the Model Advisor. For example, **Check Merge block usage** has an input parameter for **Maximum analysis time (seconds)**. When you run checks with input parameters, the Model Advisor displays the values of the input parameters in the HTML report. For more information, see the `EmitInputParametersToReport` property of the `Simulink.ModelAdvisor` class.

### **See Also**

`Simulink.ModelAdvisor`

### **Related Examples**

- “Address Model Check Results” on page 5-14
- “Generate Model Advisor Reports in Adobe PDF and Microsoft Word Formats” (Simulink Verification and Validation)
- “Select and Run Model Advisor Checks” on page 5-2

### **More About**

- “Select and Run Model Advisor Checks” on page 5-2

# Upgrade Advisor

---

## Consult the Upgrade Advisor

Use the Upgrade Advisor to help you upgrade and improve models with the current release. The Upgrade Advisor can identify cases where you can benefit by changing your model to use new features and settings in Simulink. The Advisor provides advice for transitioning to new technologies, and upgrading a model hierarchy.

The Upgrade Advisor can also help identify cases when a model will not work because changes and improvements in Simulink require changes to a model.

The Upgrade Advisor offers options to perform recommended actions automatically or instructions for manual fixes.

You can open the Upgrade Advisor in the following ways:

- From the Model Editor, select **Analysis > Model Advisor > Upgrade Advisor**
- From the MATLAB command line, use the `upgradeadvisor` function:  

```
upgradeadvisor modelName
```
- Alternatively, from the Model Advisor, click **Upgrade Advisor**. This action closes the Model Advisor and opens the Upgrade Advisor.

In the Upgrade Advisor, you create reports and run checks in the same way as when using the Model Advisor.

- Select the top Upgrade Advisor node in the left pane to run all selected checks and create a report.
- Select each individual check to open a detailed view of the results in the right pane. View the analysis results for recommended actions to manually fix warnings or failures. In some cases, the Upgrade Advisor provides mechanisms for automatically fixing warnings and failures.

---

**Caution:** When you fix a warning or failure, rerun all checks to update the results of all checks. If you do not rerun all checks, the Upgrade Advisor might report an invalid check result.

---

You must run upgrade checks in this order: first the checks that do not require compile time information and do not trigger an Update Diagram, then the compile checks. To guide you through upgrade checks to run both non-compile and compile checks, run the

check **Analyze model hierarchy and continue upgrade sequence**. See “Analyze model hierarchy and continue upgrade sequence”.

For more information on individual checks, see

- “Model Upgrades” for upgrade checks only
- “Simulink Checks” for all upgrade and advisor checks

## Upgrade Programmatically

To analyze and upgrade models programmatically, use the `upgradeadvisor` function.

---

**Tip:** For an example showing how to upgrade a whole project programmatically, see “Upgrade Simulink Models Using a Simulink Project”.

---

## Upgrade Advisor Checks

For advice on upgrading and improving models with the current release, use the following Model Advisor checks in the Upgrade Advisor.

- “Check model for block upgrade issues”
- “Check usage of function-call connections”
- “Identify Model Info blocks that can interact with external source control tools”
- “Check for calls to `slDataTypeAndScale`”
- “Identify masked blocks that specify tabs in mask dialog using `MaskTabNames` parameter”
- “Check that the model is saved in SLX format”
- “Check model for SB2SL blocks”
- “Check Model History properties”
- “Identify Model Info blocks that use the Configuration Manager”
- “Identify configurable subsystem blocks for converting to variant subsystem blocks”
- “Check and update masked blocks in library to use promoted parameters”
- “Check and update mask image display commands with unnecessary `imread()` function calls”

- “Check Rapid accelerator signal logging”“Check get\_param calls for block CompiledSampleTime”
- “Check model for parameter initialization and tuning issues”
- “Check model for block upgrade issues requiring compile time information”
- “Check usage of Merge blocks”
- “Check usage of Outport blocks”
- “Check Delay, Unit Delay and Zero-Order Hold blocks for rate transition”
- “Check usage of Discrete-Time Integrator blocks”
- “Check model settings for migration to simplified initialization mode”
- “Check model for legacy 3DoF or 6DoF blocks”
- “Check model and local libraries for legacy Aerospace Blockset blocks”
- “Check for root outports with constant sample time”
- “Analyze model hierarchy and continue upgrade sequence”
- “Check model for upgradable Simulink Scope blocks”

### See Also

upgradeadvisor

### Related Examples

- “Select and Run Model Advisor Checks” on page 5-2
- “Address Model Check Results” on page 5-14



# Working with Sample Times

---

- “What Is Sample Time?” on page 7-2
- “Specify Sample Time” on page 7-3
- “View Sample Time Information” on page 7-9
- “Print Sample Time Information” on page 7-14
- “Types of Sample Time” on page 7-15
- “Blocks for Which Sample Time Is Not Recommended” on page 7-20
- “Block Compiled Sample Time” on page 7-23
- “Sample Times in Subsystems” on page 7-26
- “Sample Times in Systems” on page 7-28
- “Resolve Rate Transitions” on page 7-34
- “How Propagation Affects Inherited Sample Times” on page 7-38
- “Backpropagation in Sample Times” on page 7-40

# What Is Sample Time?

The *sample time* of a block is a parameter that indicates when, during simulation, the block produces outputs and if appropriate, updates its internal state. The internal state includes but is not limited to continuous and discrete states that are logged.

---

**Note:** Do not confuse the Simulink usage of the term sample time with the engineering sense of the term. In engineering, sample time refers to the rate at which a discrete system samples its inputs. Simulink allows you to model single-rate and multirate discrete systems and hybrid continuous-discrete systems through the appropriate setting of block sample times that control the rate of block execution (calculations).

---

For many engineering applications, you need to control the rate of block execution. In general, Simulink provides this capability by allowing you to specify an explicit `SampleTime` parameter in the block dialog or at the command line. Blocks that do not have a `SampleTime` parameter have an implicit sample time. You cannot specify implicit sample times. Simulink determines them based upon the context of the block in the system. The Integrator block is an example of a block that has an implicit sample time. Simulink automatically sets its sample time to 0.

Sample times can be port based or block based. For block-based sample times, all of the inputs and outputs of the block run at the same rate. For port-based sample times, the input and output ports can run at different rates. To learn more about rates of execution, see “Types of Sample Time” on page 7-15.

## See Also

“Specify Sample Time” on page 7-3 | “Types of Sample Time” on page 7-15 |  
“Sample Times in Systems” on page 7-28 | “Sample Times in Subsystems” on page 7-26

## Specify Sample Time

### In this section...

“Designate Sample Times” on page 7-3

“Specify Block-Based Sample Times Interactively” on page 7-5

“Specify Port-Based Sample Times Interactively” on page 7-6

“Specify Block-Based Sample Times Programmatically” on page 7-7

“Specify Port-Based Sample Times Programmatically” on page 7-7

“Access Sample Time Information Programmatically” on page 7-8

“Specify Sample Times for a Custom Block” on page 7-8

“Determining Sample Time Units” on page 7-8

“Change the Sample Time After Simulation Start Time” on page 7-8

## Designate Sample Times

Simulink allows you to specify a block sample time directly as a numerical value or symbolically by defining a sample time vector. In the case of a discrete sample time, the vector is  $[T_s, T_o]$  where  $T_s$  is the sampling period and  $T_o$  is the initial time offset. For example, consider a discrete model that produces its outputs every two seconds. If your base time unit is seconds, you can directly set the discrete sample time by specifying the numerical value of 2 as the `SampleTime` parameter. Because the offset value is zero, you do not need to specify it; however, you can enter  $[2, 0]$  in the **Sample time** field.

For nondiscrete blocks, the components of the vector are symbolic values that represent one of the types in “Types of Sample Time” on page 7-15. The following table summarizes these types and the corresponding sample time values. The table also defines the explicit nature of each sample time type and designates the associated color and annotation. Because an *inherited sample time* is explicit, you can specify it as  $[-1, 0]$  or as  $-1$ . Whereas, a triggered sample time is implicit; only Simulink can assign the sample time of  $[-1, -1]$ . (For more information about colors and annotations, see “View Sample Time Information” on page 7-9.)

### Designations of Sample Time Information

Sample Time Type	Sample Time	Color	Annotation	Explicit
Discrete	$[T_s, T_o]$	In descending order of speed:	D1, D2, D3, D4, D5, D6, D7,... Di	Yes

Sample Time Type	Sample Time	Color	Annotation	Explicit
		red, green, blue, light blue, dark green, orange		
Continuous	[0, 0]	black	Cont	Yes
Fixed in minor step	[0, 1]	gray	FiM	Yes
Inherited	[-1, 0]	N/A	N/A	Yes
Constant	[Inf, 0]	magenta	Inf	Yes
Variable	[-2, T <sub>vo</sub> ]	brown	V1, V2,... Vi	No
Hybrid	N/A	yellow	N/A	No
Triggered	<b>Source:</b> D1, <b>Source:</b> D2, ... <b>Source:</b> Di	cyan	T1, T2,... Ti	No
Asynchronous	[-1, -n]	purple	A1, A2,... Ai	No

The color that is assigned to each block depends on its sample time relative to other sample times in the model. This means that the same sample time may be assigned different colors in a parent model and in models that it references. (See “Model Referencing”.)

For example, suppose that a model defines three sample times: 1, 2, and 3. Further, suppose that it references a model that defines two sample times: 2 and 3. In this case, blocks operating at the 2 sample rate appear as green in the parent model and as red in the referenced model.

It is important to note that Mux and Demux blocks are simply grouping operators; signals passing through them retain their timing information. For this reason, the lines emanating from a Demux block can have different colors if they are driven by sources having different sample times. In this case, the Mux and Demux blocks are color coded as hybrids (yellow) to indicate that they handle signals with multiple rates.

Similarly, Subsystem blocks that contain blocks with differing sample times are also colored as hybrids, because there is no single rate associated with them. If all the blocks within a subsystem run at a single rate, the Subsystem block is colored according to that rate.

You can use the explicit sample time values in this table to specify sample times interactively or programmatically for either block-based or port-based sample times.

The following model, `ex_specify_sample_time`, serves as a reference for this section.

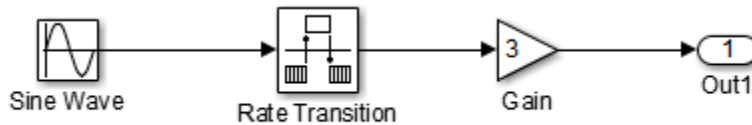

### `ex_specify_sample_time`

In this example, set the sample time of the input sine wave signal to `0.1`. The goal is to achieve an output sample time of `0.2`. The Rate Transition block serves as a zero-order hold. The resulting block diagram after setting the sample times and simulating the model is shown in the following figure. (The colors and annotations indicate that this is a discrete model.)

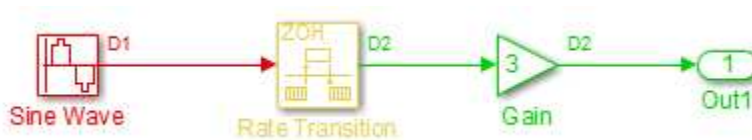

Sample Time 0.1      Sample Time 0.2

### `ex_specify_sample_time` after Setting Sample Times

## Specify Block-Based Sample Times Interactively

To set the sample time of a block interactively:

- 1 In the Simulink model window, double-click the block. The block parameter dialog box opens.
- 2 Enter the sample time in the **Sample time** field.
- 3 Click **OK**.

Following is a figure of a parameters dialog box for the Sine Wave block after entering 0.1 in the **Sample time** field.

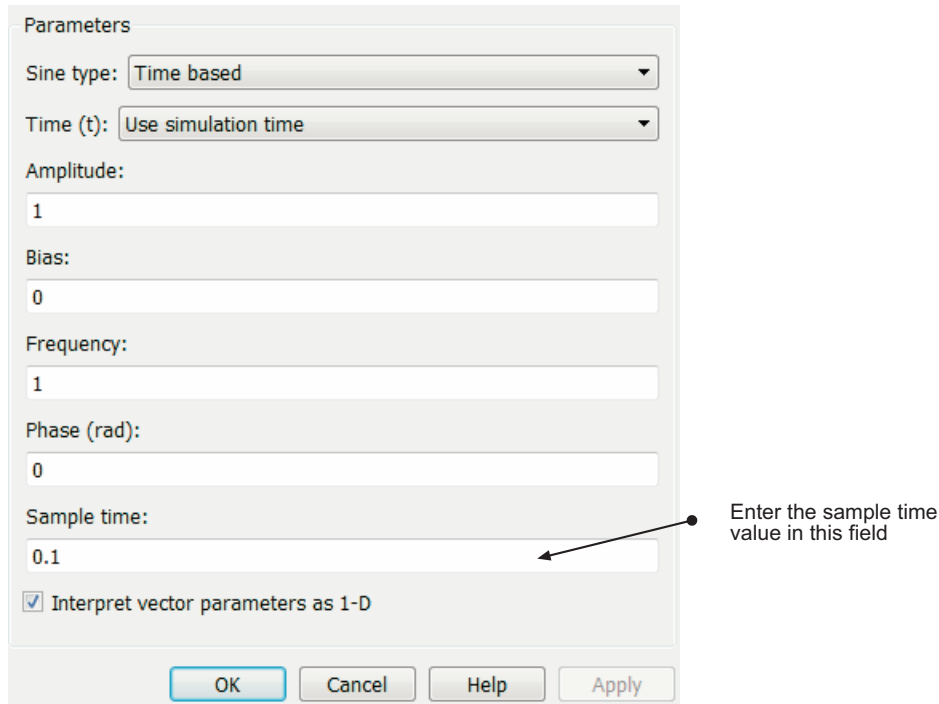

### Specify Port-Based Sample Times Interactively

The Rate Transition block has port-based sample times. You can set the output port sample time interactively by completing the following steps:

- 1 Double-click the Rate Transition block. The parameters dialog box opens.
- 2 Leave the drop-down menu choice of the **Output port sample time options** as **Specify**.
- 3 Replace the -1 in the **Output port sample time** field with 0.2.

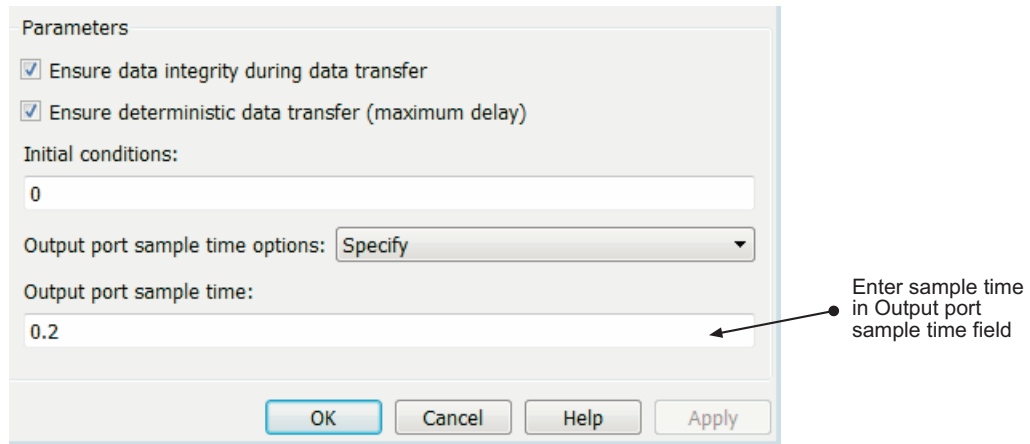

#### 4 Click **OK**.

For more information about the sample time options in the Rate Transition parameters dialog box, see the Rate Transition reference page.

## Specify Block-Based Sample Times Programmatically

To set a block sample time programmatically, set its `SampleTime` parameter to the desired sample time using the `set_param` command. For example, to set the sample time of the Gain block in the “Specify\_Sample\_Time” model to inherited (-1), enter the following command:

```
set_param('Specify_Sample_Time/Gain','SampleTime','[-1, 0]')
```

As with interactive specification, you can enter just the first vector component if the second component is zero.

```
set_param('Specify_Sample_Time/Gain','SampleTime','-1')
```

## Specify Port-Based Sample Times Programmatically

To set the output port sample time of the Rate Transition block to 0.2, use the `set_param` command with the parameter `OutPortSampleTime`:

```
set_param('Specify_Sample_Time/Rate Transition',...
```

```
'OutPortSampleTime', '0.2')
```

### Access Sample Time Information Programmatically

To access all sample times associated with a model, use the API `Simulink.BlockDiagram.getSampleTimes`.

To access the sample time of a single block, use the API `Simulink.Block.getSampleTimes`.

### Specify Sample Times for a Custom Block

You can design custom blocks so that the input and output ports operate at different sample time rates. For information on specifying block-based and port-based sample times for S-functions, see “Sample Times” in *Writing S-Functions* of the Simulink documentation.

### Determining Sample Time Units

Since the execution of a Simulink model is not dependent on a specific set of units, you must determine the appropriate base time unit for your application and set the sample time values accordingly. For example, if your base time unit is second, then you would represent a sample time of 0.5 second by setting the sample time to 0.5.

### Change the Sample Time After Simulation Start Time

To change a sample time after simulation begins, you must stop the simulation, reset the `SampleTime` parameter, and then restart execution.

### See Also

“What Is Sample Time?” on page 7-2 | “Types of Sample Time” on page 7-15



## View Sample Time Information

In this section...
“View Sample Time Display” on page 7-9
“Sample Time Legend” on page 7-10

### View Sample Time Display

Simulink models can display color coding and annotations that represent specific sample times. As shown in the table Designations of Sample Time Information, each sample time type has one or more colors associated with it. You can display the blocks and signal lines in color, the annotations in black, or both the colors and the annotations. To choose one of these options:

- 1 In the Simulink model window, select **Display > Sample Time**.
- 2 Select **Colors, Annotations, or All**.

Selecting **All** results in the display of both the colors and the annotations. Regardless of your choice, Simulink performs an **Update Diagram** automatically. To turn off the colors and annotations:

- 1 Select **Display > Sample Time**.
- 2 Select **Off**.

Simulink performs another **Update Diagram** automatically.

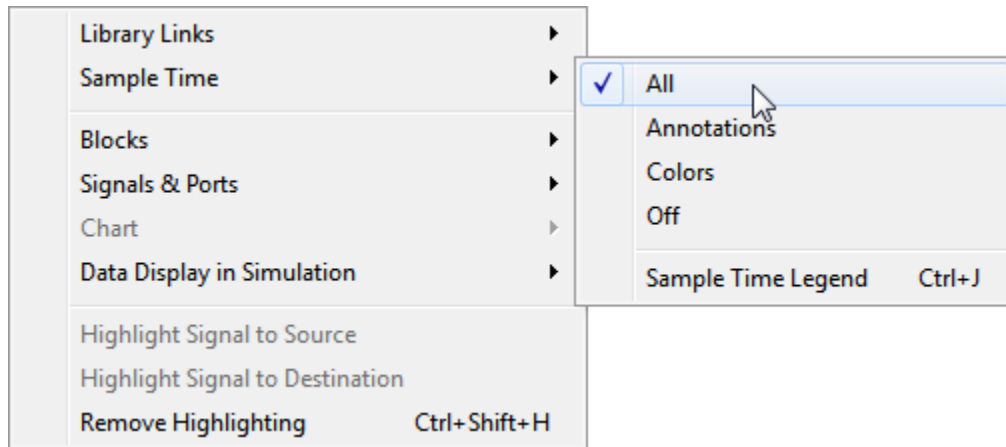

Your Sample Time Display choices directly control the information that the Sample Time Legend displays.

---

**Note:** The discrete sample times in the table Designations of Sample Time Information represent a special case. Five colors indicate the fastest through the fifth fastest discrete rate. A sixth color, orange, represents all rates that are slower than the fifth discrete rate. You can distinguish between these slower rates by looking at the annotations on their respective signal lines.

---

## Sample Time Legend

You can view the Sample Time Legend for an individual model or for multiple models. Additionally, you can prevent the legend from automatically opening when you select options on the **Sample Time** menu.

### Viewing the Legend

To assist you with interpreting your block diagram, a **Sample Time Legend** is available that contains the sample time color, annotation, description, and value for each sample time in the model. You can use one of three methods to view the legend, but upon first opening the model, you must first perform an **Update Diagram**.

- 1 In the Simulink model window, select **Simulation > Update Diagram**.
- 2 Select **Display > Sample Time > Sample Time Legend** or press **Ctrl +J**.

In addition, whenever you select **Colors**, **Annotations**, or **All** from the **Sample Time** menu, Simulink updates the model diagram and opens the legend by default. The legend contents reflect your **Sample Time Display** choices. By default or if you have selected **Off**, the legend contains a description of the sample time and the sample time value. If you turn colors on, the legend displays the appropriate color beside each description. Similarly, if you turn annotations on, the annotations appear in the legend.

The legend does not provide a discrete rate for all types of sample times. For asynchronous and variable sample times, the legend displays a link to the block that controls the sample time in place of the sample time value. Clicking one of these links highlights the corresponding block in the block diagram. For variable sample times, the legend uses >> to indicate that the controller block of the sample time is in a model reference hierarchy. Click >> to drill down to that block, for example:

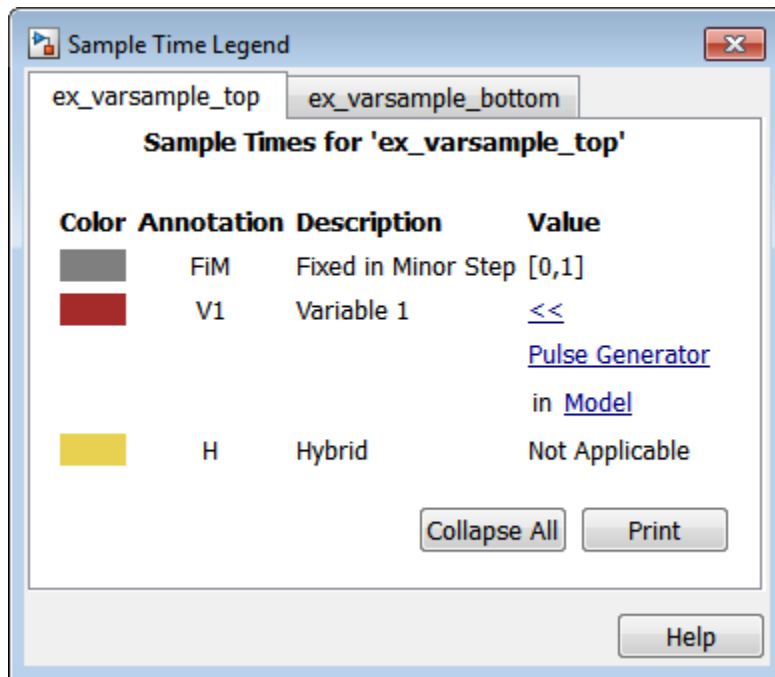

The rate listed under hybrid and asynchronous hybrid models is “Not Applicable” because these blocks do not have a single representative sample time.

---

**Note:** The Sample Time Legend displays all of the sample times in the model, including those that are not associated with any block. For example, if the fixed step size is 0.1 and all of the blocks have a sample time of 0.2, then both rates (i.e., 0.1 and 0.2) appear in the legend.

---

For subsequent viewings of the legend, repeat the **Update Diagram** to access the latest known information.

### Turning the Legend Off

If you do not want to view the legend upon selecting **Sample Time Display**:

- 1 In the Simulink Editor, select **File > Simulink Preferences**.
- 2 In the **General** pane, clear **Open the sample time legend when the sample time display is changed** and click **Apply**.

### Viewing Multiple Legends

If you have more than one model open and you view the **Sample Time Legend** for each one, a single legend window appears with multiple tabs. Each tab contains the name of the model and the respective legend information. The following figure shows the tabbed legends for the **f14** and **vdp** models.

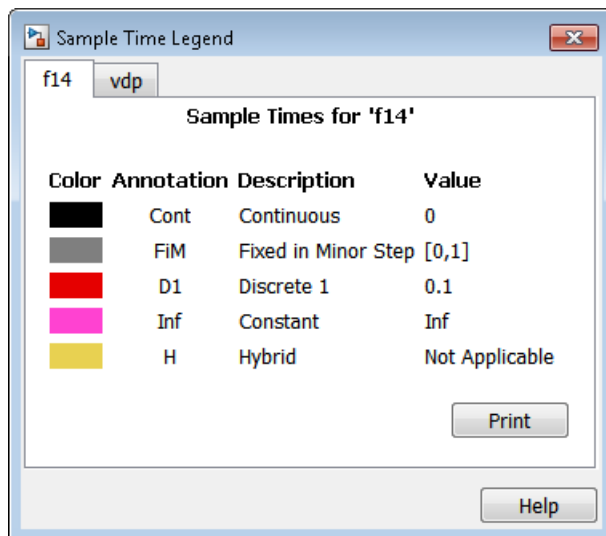

**See Also**

“What Is Sample Time?” on page 7-2 | “Specify Sample Time” on page 7-3 | “Print Sample Time Information” on page 7-14

## Print Sample Time Information

You can print the sample time information in the Sample Time Legend by using either of these methods:

- In the Sample Time Legend window, click **Print**.
- Print the legend from the **Print Model** dialog box:
  - 1** In the model window, select **File > Print**.
  - 2** Under **Options**, select the check box beside **Print Sample Time Legend**.
  - 3** Click **OK**.

### See Also

“What Is Sample Time?” on page 7-2 | “View Sample Time Information” on page 7-9

## Types of Sample Time

### In this section...

“Discrete Sample Time” on page 7-15  
 “Continuous Sample Time” on page 7-16  
 “Fixed-in-Minor-Step” on page 7-16  
 “Inherited Sample Time” on page 7-16  
 “Constant Sample Time” on page 7-17  
 “Variable Sample Time” on page 7-17  
 “Triggered Sample Time” on page 7-18  
 “Asynchronous Sample Time” on page 7-18

### Discrete Sample Time

Given a block with a discrete sample time, Simulink executes the block output or update method at times

$$t_n = nT_s + |T_o|$$

where the sample time period  $T_s$  is always greater than zero and less than the simulation time,  $T_{sim}$ . The number of periods ( $n$ ) is an integer that must satisfy:

$$0 \leq n \leq \frac{T_{sim}}{T_s}$$

As simulation progresses, Simulink computes block outputs only once at each of these fixed time intervals of  $t_n$ . These simulation times, at which Simulink executes the output method of a block for a given sample time, are referred to as *sample time hits*. Discrete sample times are the only type for which sample time hits are known *a priori*.

If you need to delay the initial sample hit time, you can define an offset,  $T_o$ .

The Unit Delay block is an example of a block with a discrete sample time.

### Continuous Sample Time

Unlike the discrete sample time, continuous sample hit times are divided into major time steps and minor time steps, where the minor steps represent subdivisions of the major steps (see “Minor Time Steps” on page 3-22). The ODE solver you choose integrates all continuous states from the simulation start time to a given major or minor time step. The solver determines the times of the minor steps and uses the results at the minor time steps to improve the accuracy of the results at the major time steps. However, you see the block output only at the major time steps.

To specify that a block, such as the Derivative block, is continuous, enter  $[0, 0]$  or  $0$  in the **Sample time** field of the block dialog.

### Fixed-in-Minor-Step

If the sample time of a block is set to  $[0, 1]$ , the block becomes *fixed-in-minor-step*. For this setting, Simulink does not execute the block at the minor time steps; updates occur only at the major time steps. This process eliminates unnecessary computations of blocks whose output cannot change between major steps.

While you can explicitly set a block to be fixed-in-minor-step, more typically Simulink sets this condition as either an inherited sample time or as an alteration to a user specification of  $0$  (continuous). This setting is equivalent to, and therefore converted to, the fastest discrete rate when you use a fixed-step solver.

### Inherited Sample Time

If a block sample time is set to  $[-1, 0]$  or  $-1$ , the sample time is *inherited* and Simulink determines the best sample time for the block based on the block context within the model. Simulink performs this task during the compilation stage; the original inherited setting never appears in a compiled model. Therefore, you never see inherited ( $[-1, 0]$ ) in the Sample Time Legend. (See “View Sample Time Information” on page 7-9.)

There are some blocks in which the sample time is inherited (-1) by default. For these blocks, the parameter is not visible on the block dialog box unless it is set to a noninherited value. Examples of these blocks include the Gain and Rounding Function blocks. As a good modeling practice, do not change the **Sample time** parameter for these



blocks. For more information, see “Blocks for Which Sample Time Is Not Recommended” on page 7-20.

All inherited blocks are subject to the process of sample time propagation, as discussed in “How Propagation Affects Inherited Sample Times” on page 7-38

## Constant Sample Time

In Simulink, a constant is a symbolic name or expression whose value you can change only outside the algorithm or through supervisory control. Blocks, like the constant block, whose outputs do not change during normal execution of the model, are always considered to be constant.

Simulink assigns constant sample time to these blocks. They run their block output method:

- At the start of a simulation.
- In response to runtime changes in the environment, such as tuning a parameter.

For constant sample time, the block sample time assignment is `[inf,0]` or `[inf]`.

For a block to allow constant sample time, these conditions hold:

- The block has no continuous or discrete states.
- The block does not drive an output port of a conditionally executed subsystem (see “Enabled Subsystems” on page 10-4).

## S-Function Blocks

The Simulink block library includes several blocks, such as the MATLAB S-Function block, the Level-2 MATLAB S-Function block, and the C S-Function block, whose ports can produce outputs at different sample rates. It is possible for some of the ports of these blocks to have a constant sample time.

## Variable Sample Time

Blocks that use a variable sample time have an implicit `SampleTime` parameter that the block specifies; the block tells Simulink when to run it. The compiled sample time is `[-2,  $T_{vo}$ ]` where  $T_{vo}$  is a unique variable offset.

The Pulse Generator block is an example of a block that has a variable sample time. Since Simulink supports variable sample times for variable-step solvers only, the Pulse Generator block specifies a discrete sample time if you use a fixed-step solver.

To learn how to write your own block that uses a variable sample time, see “C MEX S-Function Examples”.

## Triggered Sample Time

If a block is inside of a triggered-type (e.g., function-call, enabled and triggered, or iterator) subsystem, the block may be constant or have a triggered sample time. You cannot specify the triggered sample time type explicitly. However, to achieve a triggered type during compilation, you must set the block sample time to inherited (–1). Simulink then determines the specific times at which the block computes its output during simulation. One exception is if the subsystem is an asynchronous function call, as discussed in the following section.

## Asynchronous Sample Time

An asynchronous sample time is similar to a triggered sample time. In both cases, it is necessary to specify an inherited sample time because the Simulink engine does not regularly execute the block. Instead, a run-time condition determines when the block executes. For the case of an asynchronous sample time, an S-function makes an asynchronous function call.

The differences between these sample time types are:

- Only a function-call subsystem can have an asynchronous sample time. (See “Function-Call Subsystems” on page 10-23.)
- The source of the function-call signal is an S-function having the option `SS_OPTION_ASYNCHRONOUS`.
- The asynchronous sample time can also occur when a virtual block is connected to an asynchronous S-function or an asynchronous function-call subsystem.
- The asynchronous sample time is important to certain code-generation applications. (See “Asynchronous Events” (Simulink Coder) in the *Simulink Coder User's Guide*.)
- The sample time is  $[-1, -n]$ .

For an explanation of how to use blocks to model and generate code for asynchronous event handling, see “Rate Transitions and Asynchronous Blocks” (Simulink Coder) in the *Simulink Coder User's Guide*.

**See Also**

“What Is Sample Time?” on page 7-2 | “View Sample Time Information” on page 7-9 |  
“Specify Sample Time” on page 7-3 | “Print Sample Time Information” on page 7-14

## Blocks for Which Sample Time Is Not Recommended

### In this section...

“Best Practice to Model Sample Times” on page 7-20  
“Appropriate Blocks for the Sample Time Parameter” on page 7-21  
“Specify Sample Time in Blocks Where Hidden” on page 7-21

Some blocks do not enable you to set the **Sample Time** parameter by default. However, you can see and set the **Sample Time** parameter for these blocks in an existing model if the sample time is set to a value other than the default of -1 (inherited sample time). The **Sample Time** parameter is not available on certain blocks because specifying a sample time that is not -1 on blocks such as the Gain, Sum, and n-D Lookup Table causes sample rate transition to be implicitly mixed with block algorithms. This mixing can often lead to ambiguity and confusion in Simulink models.

In most modeling applications, you specify rates for a model on the boundary of your system instead of on a block within the subsystem. You specify the system rate from incoming signals or the rate of sampling the output. You can also decide rates for events you are modeling that enter the subsystem as trigger, function-call, or enable/disable signals. Some global variables (such as Data Store Memory blocks) might need additional sample time specification. If you want to change rate within a system, use a Rate Transition block, which is designed specifically to model rate transitions.

In a future release, you might not be able see or set this parameter on blocks where it is not appropriate.

### Best Practice to Model Sample Times

Use these approaches instead of setting the **Sample Time** parameter in the blocks where it is not appropriate:

- Adjust your model by specifying **Sample Time** only in the blocks listed in “Appropriate Blocks for the Sample Time Parameter” on page 7-21, and set **Sample Time** to -1 for all other blocks. To change the sample time for multiple blocks simultaneously, use Model Explorer. For more information, see “Editing Object Properties” on page 12-22.
- Use the Rate Transition block to model rate transitions in your model.

- Use the Signal Specification block to specify sample time in models that don't have source blocks, such as algebraic loops.
- Specify the simulation rate independently from the block sample times, using the Model Parameter dialog box.

Once you have completed these changes, verify whether your model gives the same outputs as before.

## Appropriate Blocks for the Sample Time Parameter

Specify sample time on the boundary of a model or subsystem, or in blocks designed to model rate transitions. Examples include:

- Blocks in the Sources library
- Blocks in the Sinks library
- Trigger ports (if **Trigger type** is set to **function-call**) and Enable ports
- Data Store Read and Data Store Write blocks, as the Data Store Memory block they link to might be outside the boundary of the subsystem
- Rate Transition block
- Signal Specification block
- Blocks in the Discrete library
- Message Receive block
- Function Caller block

## Specify Sample Time in Blocks Where Hidden

You can specify sample time in the blocks that do not display the parameter on the block dialog box. If you specify value other than -1 in these blocks, no error occurs when you simulate the model. However, a message appears on the block dialog box advising to set this parameter to -1 (inherited sample time). If you promote the sample time block parameter to a mask, this parameter is always visible on the mask dialog box.

To change the sample time in this case, use the `set_param` command. For example, select a block in the Simulink Editor and, at the command prompt, enter:

```
set_param(gcf, 'SampleTime', '2');
```

**See Also**

“Resolve Rate Transitions” on page 7-34 | “What Is Sample Time?” on page 7-2 |  
“Sample Times in Subsystems” on page 7-26 | “Sample Times in Systems” on page  
7-28

## Block Compiled Sample Time

During the compilation phase of a simulation, Simulink determines the sample time of a block from the `SampleTime` parameter (if the block has an explicit sample time), the block type (if it has an implicit sample time), or by the model content. This compiled sample time determines the sample rate of a block during simulation. You can determine the compiled sample time of any block in a model by first updating the model and then getting the block `CompiledSampleTime` parameter, using the `get_param` command.

For example, consider the model `ex_compiled_sample_new`.

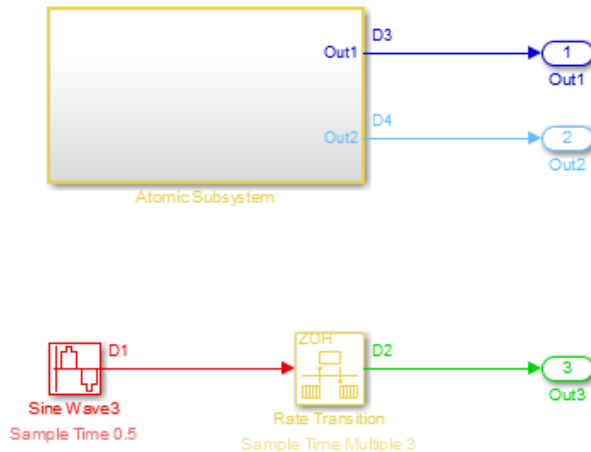

Use `get_param` to obtain the block `CompiledSampleTime` parameter for each of the blocks in this example.

```
get_param('model_name/block_name','CompiledSampleTime');
For the Sine Wave3 block,
```

```
get_param('ex_compiled_sample_new/Sine Wave3','CompiledSampleTime');
displays
```

```
0.5000 0
```

The atomic subsystem contains sine wave blocks with sample times of 3 and 4.

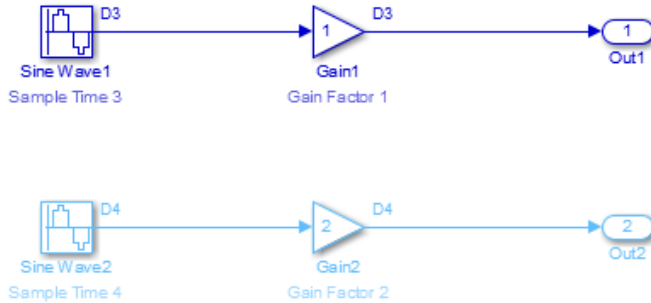

When calculating the block `CompiledSampleTime` for this subsystem, Simulink returns a cell array of the sample times present in the subsystem.

```
3  0
4  0
```

The greatest common divisor (GCD) of the two rates is 1. However, this is not necessarily one of the rates in the model.

The Rate Transition block in this model serves as a Zero-Order Hold. Since the `Sample Time Multiple` parameter is set to 3, the input to the rate transition block has a sample rate of 0.5 while the output has a rate of 1.5.

```
rt=get_param('ex_compiled_sample_new/Rate Transition','CompiledSampleTime');
rt{:}
```

```
0.5000  0
1.5000  0
```

The Sample Time Legend shows all of the sample rates present in the model.



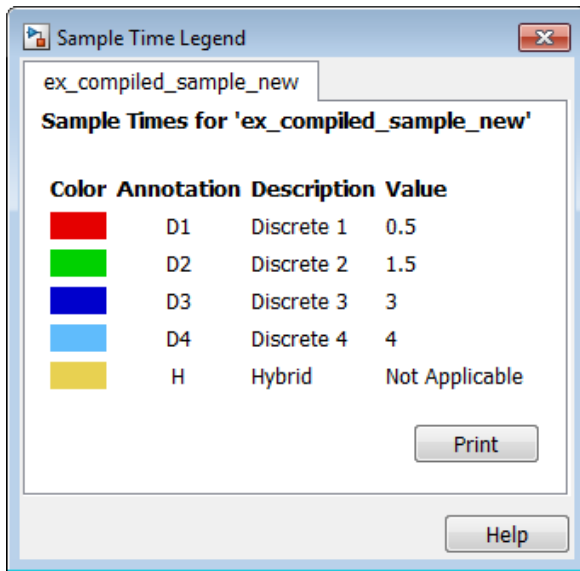

## Related Examples

- “Sample Times in Subsystems” on page 7-26
- “View Sample Time Information” on page 7-9

## Sample Times in Subsystems

Subsystems fall into two categories: triggered and non-triggered. For triggered subsystems, in general, the subsystem gets its sample time from the triggering signal. One exception occurs when you use a Trigger block to create a triggered subsystem. If you set the block **Trigger type** to **function-call** and the **Sample time type** to **periodic**, the `SampleTime` parameter becomes active. In this case, *you* specify the sample time of the Trigger block, which in turn, establishes the sample time of the subsystem.

There are four non-triggered subsystems:

- Virtual
- Enabled
- Atomic
- Action

Simulink calculates the sample times of virtual and enabled subsystems based on the respective sample times of their contents.

The atomic subsystem is a special case in that the subsystem block has a `SystemSampleTime` parameter. Moreover, for a sample time other than the default value of `-1`, the blocks inside the atomic subsystem can have only a value of `Inf`, `-1`, or the identical (discrete) value of the subsystem `SampleTime` parameter. If the atomic subsystem is left as inherited, Simulink calculates the block sample time in the same manner as the virtual and enabled subsystems. However, the main purpose of the subsystem `SampleTime` parameter is to allow for the simultaneous specification of a large number of blocks, within an atomic subsystem, that are all set to inherited. To obtain the sample time set on an atomic subsystem, use this command at the command prompt:

```
get_param(AtomicSubsystemBlock, 'SystemSampleTime');
```

Finally, the sample time of the action subsystem is set by the If block or the Switch Case block.

For non-triggered subsystems where blocks have different sample rates, Simulink returns the Compiled Sample Time for the subsystem as a cell array of all the sample rates present in the subsystem. To see this, use the `get_param` command at MATLAB prompt.

```
get_param(subsystemBlock, 'CompiledSampleTime')
```

### **More About**

- “Block Compiled Sample Time” on page 7-23
- “Sample Times in Systems” on page 7-28

## Sample Times in Systems

In this section...
“Purely Discrete Systems” on page 7-28
“Hybrid Systems” on page 7-30

### Purely Discrete Systems

A purely discrete system is composed solely of discrete blocks and can be modeled using either a fixed-step or a variable-step solver. Simulating a discrete system requires that the simulator take a simulation step at every sample time hit. For a *multirate discrete system*—a system whose blocks Simulink samples at different rates—the steps must occur at integer multiples of each of the system sample times. Otherwise, the simulator might miss key transitions in the states of the system. The step size that the Simulink software chooses depends on the type of solver you use to simulate the multirate system and on the fundamental sample time.

The *fundamental sample time* of a multirate discrete system is the largest double that is an integer divisor of the actual sample times of the system. For example, suppose that a system has sample times of 0.25 and 0.50 seconds. The fundamental sample time in this case is 0.25 seconds. Suppose, instead, the sample times are 0.50 and 0.75 seconds. The fundamental sample time is again 0.25 seconds.

The importance of the fundamental sample time directly relates to whether you direct the Simulink software to use a fixed-step or a variable-step discrete solver to solve your multirate discrete system. A fixed-step solver sets the simulation step size equal to the fundamental sample time of the discrete system. In contrast, a variable-step solver varies the step size to equal the distance between actual sample time hits.

The following diagram illustrates the difference between a fixed-step and a variable-step solver.



Fixed-Step Solver



Variable-Step Solver

In the diagram, the arrows indicate simulation steps and circles represent sample time hits. As the diagram illustrates, a variable-step solver requires fewer simulation steps to simulate a system, if the fundamental sample time is less than any of the actual sample times of the system being simulated. On the other hand, a fixed-step solver requires less memory to implement and is faster if one of the system sample times is fundamental. This can be an advantage in applications that entail generating code from a Simulink model (using Simulink Coder). In either case, the discrete solver provided by Simulink is optimized for discrete systems; however, you can simulate a purely discrete system with any one of the solvers and obtain equivalent results.

Consider the following example of a simple multirate system. For this example, the DTF1 Discrete Transfer Fcn block's **Sample time** is set to  $[1 \ 0.1]$ , which gives it an offset of  $0.1$ . The **Sample time** of the DTF2 Discrete Transfer Fcn block is set to  $0.7$ , with no offset. The solver is set to a variable-step discrete solver.

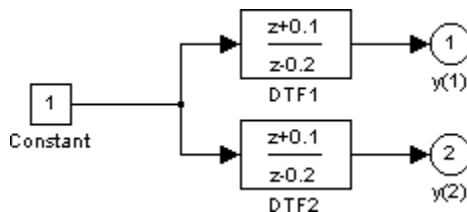

Running the simulation and plotting the outputs using the `stairs` function

```
simOut = sim('ex_dtf','StopTime', '3');
t = simOut.find('tout')
```

```
y = simOut.find('yout')
stairs(t,y, '-*')
```

produces the following plot.

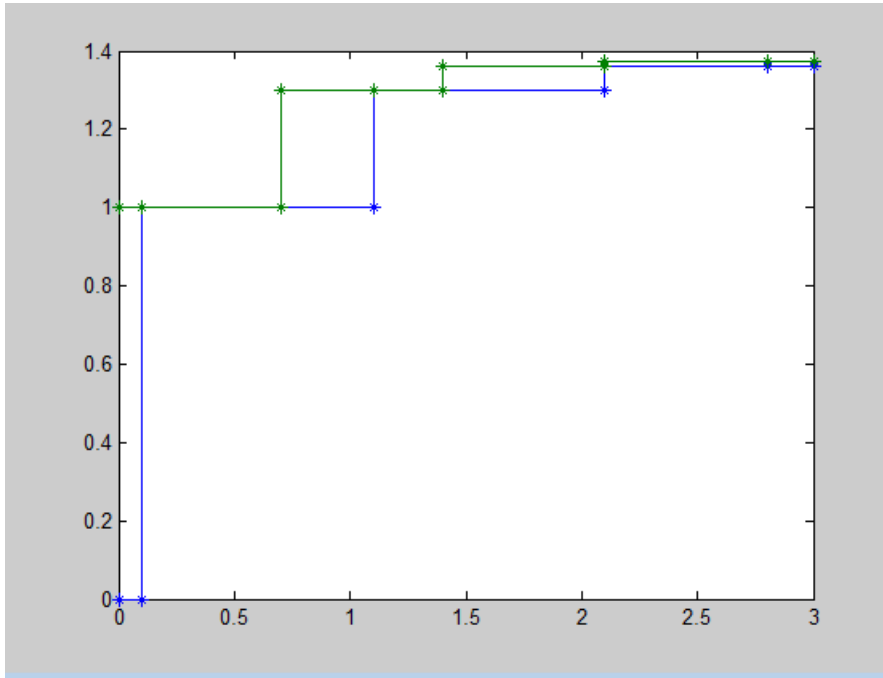

(For information on the `sim` command, see “Run Simulations Programmatically” on page 24-2.)

As the figure demonstrates, because the DTF1 block has a 0.1 offset, the DTF1 block has no output until  $t = 0.1$ . Similarly, the initial conditions of the transfer functions are zero; therefore, the output of DTF1,  $y(1)$ , is zero before this time.

## Hybrid Systems

*Hybrid systems* contain both discrete and continuous blocks and thus have both discrete and continuous states. However, Simulink solvers treat any system that has both

continuous and discrete sample times as a hybrid system. For information on modeling hybrid systems, see “Modeling Hybrid Systems” on page 3-7.

In block diagrams, the term hybrid applies to both hybrid systems (mixed continuous-discrete systems) and systems with multiple sample times (multirate systems). Such systems turn yellow in color when you perform an **Update Diagram** with **Sample Time Display Colors** turned 'on'. As an example, consider the following model that contains an atomic subsystem, “Discrete Cruise Controller”, and a virtual subsystem, “Car Dynamics”. (See `ex_execution_order`.)

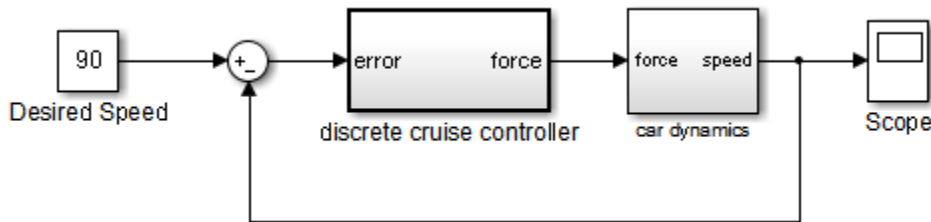

### Car Model

With the **Sample Time** option set to **All**, an **Update Diagram** turns the virtual subsystem yellow, indicating that it is a hybrid subsystem. In this case, the subsystem is a true hybrid system since it has both continuous and discrete sample times. As shown below, the discrete input signal, D1, combines with the continuous velocity signal, v, to produce a continuous input to the integrator.

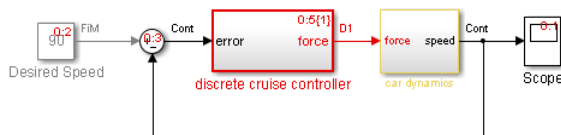

### Car Model after an Update Diagram

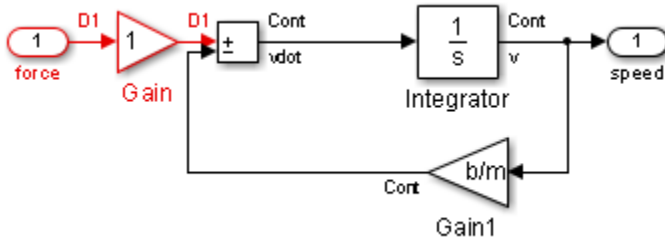

### Car Dynamics Subsystem after an Update Diagram

Now consider a multirate subsystem that contains three Sine Wave source blocks, each of which has a unique sample time — 0.2, 0.3, and 0.4, respectively.

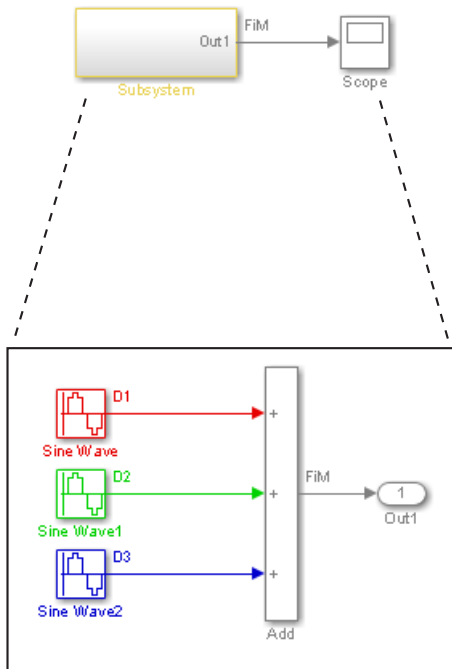

### Multirate Subsystem after an Update Diagram



An **Update Diagram** turns the subsystem yellow because the subsystem contains more than one sample time. As shown in the block diagram, the Sine Wave blocks have discrete sample times D1, D2, and D3 and the output signal is fixed in minor step.

In assessing a system for multiple sample times, Simulink does not consider either constant  $[\text{inf}, 0]$  or asynchronous  $[-1, -n]$  sample times. Thus a subsystem consisting of one block that outputs constant value and one block with a discrete sample time will not be designated as hybrid.

The hybrid annotation and coloring are very useful for evaluating whether or not the subsystems in your model have inherited the correct or expected sample times.

### **See Also**

“Blocks for Which Sample Time Is Not Recommended” on page 7-20 | “View Sample Time Information” on page 7-9

## Resolve Rate Transitions

In general, a rate transition exists between two blocks if their sample times differ, that is, if either of their sample-time vector components are different. The exceptions are:

- Blocks that output constant value never have a rate transition with any other rate.
- A continuous sample time (black) and the fastest discrete rate (red) never has a rate transition if you use a fixed-step solver.
- A variable sample time and fixed in minor step do not have a rate transition.

You can resolve rate transitions manually by inserting rate transition blocks and by using two diagnostic tools. For the single-tasking execution mode, the **Single task rate transition** diagnostic allows you to set the level of Simulink rate transition messages. The **Multitask rate transition** diagnostic serves the same function for multitasking execution mode. These execution modes directly relate to the type of solver in use: Variable-step solvers are always single-tasking; fixed-step solvers may be explicitly set as single-tasking or multitasking.

## Automatic Rate Transition

Simulink can detect mismatched rate transitions in a multitasking model during an update diagram and automatically insert Rate Transition blocks to handle them. To enable this, in the **Solver** pane of model configuration parameters, select **Automatically handle rate transition for data transfer**. The default setting for this option is off. When you select this option:

- Simulink handles transitions between periodic sample times and asynchronous tasks.
- Simulink inserts hidden Rate Transition blocks in the block diagram.
- Automatically inserted Rate Transition blocks operate in protected mode for periodic tasks and asynchronous tasks. You cannot alter this behavior. For periodic tasks, automatically inserted Rate Transition blocks operate with the level of determinism specified by the **Deterministic data transfer** parameter in the **Solver** pane. The default setting is **Whenever possible**, which enables determinism for data transfers between periodic sample-times that are related by an integer multiple. For more information, see “Deterministic data transfer”. To use other modes, you must insert Rate Transition blocks and set their modes manually.

## Visualize Inserted Rate Transition Blocks

When you select the **Automatically handle rate transition for data transfer** option, Simulink inserts Rate Transition blocks in the paths that have mismatched transition rates. These blocks are hidden by default. To visualize the inserted blocks, update the diagram. Badge labels appear in the model and indicate where Simulink inserted Rate Transition blocks during the compilation phase. For example, in this model, three Rate Transition blocks were inserted between the two Sine Wave blocks and the Multiplexer and Integrator when the model compiled. The ZOH and DbBuf badge labels indicate these blocks.

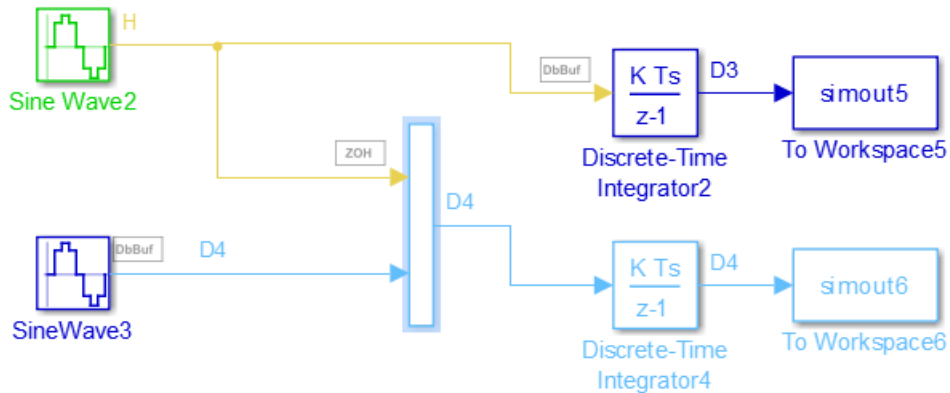

You can show or hide badge labels using the **Display > Signals and Ports > Hidden Rate Transition Block Indicators** setting.

To configure the hidden Rate Transition blocks, right click on a badge label and click on **Insert rate transition block** to make the block visible.

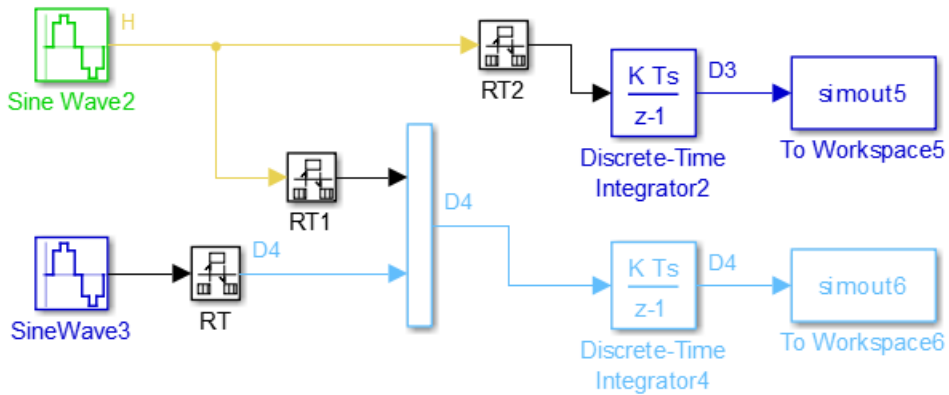

When you make hidden Rate Transition blocks visible:

- You can see the type of Rate Transition block inserted as well as the location in the model.
- You can set the **Initial Conditions** of these blocks.
- You can change data transfer and sample time block parameters.

Validate the changes to your model by updating your diagram.

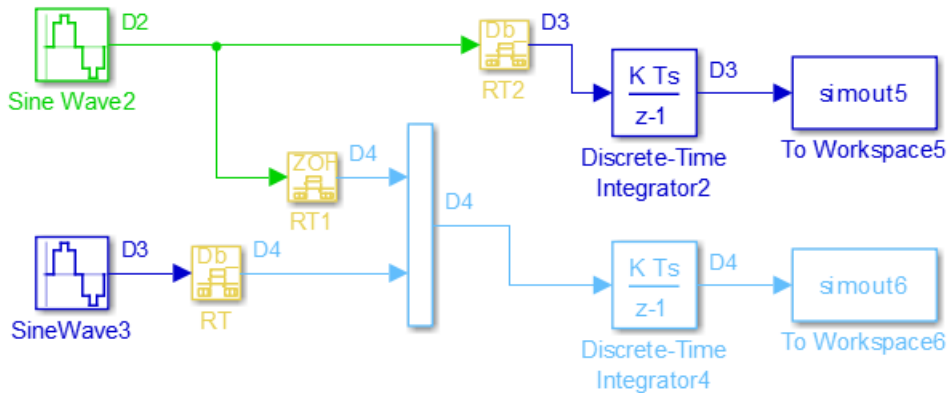

Displaying inserted Rate Transition blocks is not compatible with:

- Concurrent execution environment
- Export-function models

To learn more about the types of Rate Transition blocks, see [Rate Transition](#).

---

**Note:** Suppose you automatically insert rate transition blocks and there is a virtual block specifying sample time upstream of the block you insert. You cannot click the badge of the inserted block to configure the block and make it visible because the sample time on the virtual block causes a rate transition as well. In this case, manually insert a rate transition block before the virtual block. To learn more about virtual blocks, see “Nonvirtual and Virtual Blocks” on page 34-2.

---

## Related Examples

- “Handle Rate Transitions” (Simulink Coder)

## More About

- “Time-Based Scheduling and Code Generation” (Simulink Coder)

## How Propagation Affects Inherited Sample Times

During a model update, for example at the beginning of a simulation, Simulink uses a process called sample time propagation to determine the sample times of blocks that inherit their sample times. The figure below illustrates a Discrete Filter block with a sample time period  $T_s$  driving a Gain block.

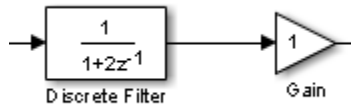

Because the output of the Gain block is the input multiplied by a constant, its output changes at the same rate as the filter. In other words, the Gain block has an effective sample rate equal to the sample rate of the filter. The establishment of such effective rates is the fundamental mechanism behind sample time propagation in Simulink.

### Process for Sample Time Propagation

Simulink uses the following basic process to assign sample times to blocks that inherit their sample times:

- 1 Propagate known sample time information forward.
- 2 Propagate known sample time information backward.
- 3 Apply a set of heuristics to determine additional sample times.
- 4 Repeat until all sample times are known.

### Simulink Rules for Assigning Sample Times

A block having a block-based sample time inherits a sample time based on the sample times of the blocks connected to its inputs, and in accordance with the following rules:

Rule	Action
All of the inputs have the same sample time and the block can accept that sample time	Simulink assigns the sample time to the block

Rule	Action
The inputs have different discrete sample times and all of the input sample times are integer multiples of the fastest input sample time	Simulink assigns the sample time of the fastest input to the block . (This assignment assumes that the block can accept the fastest sample time.)
The inputs have different discrete sample times, some of the input sample times are not integer multiples of the fastest sample time, and the model uses a variable-step solver	Simulink assigns a fixed-in-minor-step sample time to the block.
The inputs have different discrete sample times, some of the input sample times are not integer multiples of the fastest sample time, the model uses a fixed-step solver, and Simulink can compute the greatest common integer divisor (GCD) of the sample times coming into the block	Simulink assigns the GCD sample time to the block. Otherwise, Simulink assigns the fixed step size of the model to the block.
The sample times of some of the inputs are unknown, or if the block cannot accept the sample time	Simulink determines a sample time for the block based on a set of heuristics.

## See Also

“Blocks for Which Sample Time Is Not Recommended” on page 7-20

## More About

- “Backpropagation in Sample Times” on page 7-40

## Backpropagation in Sample Times

When you update or simulate a model that specifies the sample time of a source block as inherited (–1), the sample time of the source block may be backpropagated; Simulink may set the sample time of the source block to be identical to the sample time specified by or inherited by the block connected to the source block. For example, in the model below, the Simulink software recognizes that the Sine Wave block is driving a Discrete-Time Integrator block whose sample time is 1; so it assigns the Sine Wave block a sample time of 1.

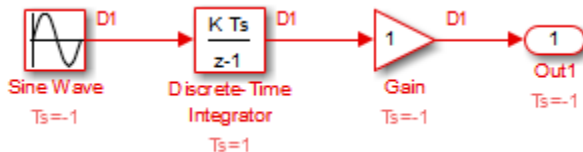

You can verify this sample time setting by selecting **Sample Time > Colors** from the Simulink **Display** menu and noting that both blocks are red. Because the Discrete-Time Integrator block looks at its input only during its sample hit times, this change does not affect the results of the simulation, but does improve the simulation performance.

Now replacing the Discrete-Time Integrator block with a continuous Integrator block, as shown in the model below, causes the Sine Wave and Gain blocks to change to continuous blocks. You can test this change by selecting **Simulation > Update Diagram** to update the colors; both blocks now appear black.

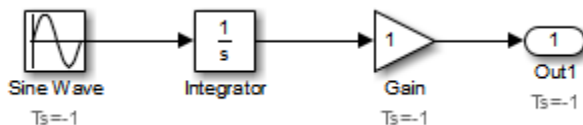

---

**Note:** Backpropagation makes the sample times of model sources dependent on block connectivity. If you change the connectivity of a model whose sources inherit sample times, you can inadvertently change the source sample times. For this reason, when you update or simulate a model, by default, Simulink displays warnings at the command line if the model contains sources that inherit their sample times.

---



**See Also**

“View Sample Time Information” on page 7-9 | “How Propagation Affects Inherited Sample Times” on page 7-38



# Referencing a Model

---

- “Overview of Model Referencing” on page 8-2
- “When to Use Model Referencing” on page 8-7
- “Create a Referenced Model” on page 8-9
- “Subsystem to Referenced Model Conversion” on page 8-13
- “Convert a Subsystem to a Referenced Model” on page 8-17
- “Sample Times for Model Referencing” on page 8-26
- “Simulate Model Referencing Models” on page 8-31
- “Simulate Models with Multiple Referenced Model Instances” on page 8-37
- “View a Model Referencing Hierarchy” on page 8-44
- “Model Referencing Simulation Targets” on page 8-46
- “Reuse Simulation Builds for Faster Simulations” on page 8-55
- “Simulink Model Referencing Requirements” on page 8-59
- “Parameterize Instances of a Reusable Referenced Model” on page 8-65
- “Model Arguments for Model Variants Blocks” on page 8-78
- “Create and Reference Conditional Referenced Models” on page 8-82
- “Simulate Conditional Referenced Models” on page 8-88
- “Protected Model” on page 8-90
- “Use Protected Model in Simulation” on page 8-92
- “Refresh Model Blocks” on page 8-94
- “S-Functions with Referenced Models” on page 8-95
- “Buses in Referenced Models” on page 8-98
- “Signal Logging in Referenced Models” on page 8-99
- “Model Referencing Limitations” on page 8-100

## Overview of Model Referencing

### In this section...

- “Reference One Model From Another Model” on page 8-2
- “Model Reference Hierarchies” on page 8-3
- “Model Block and Referenced Model Ports” on page 8-4
- “Using Referenced Models as Standalone Models” on page 8-5
- “Examples of Models That Use Model Referencing” on page 8-5
- “Simulation of Model Referencing Models” on page 8-6
- “Code Generation for Referenced Models” on page 8-6

### Reference One Model From Another Model

You can include one model in another by using Model blocks. Each instance of a Model block represents a reference to another model, called a *referenced model*. For simulation and code generation, the referenced model effectively replaces the Model block that references it. The model that contains a referenced model is its *parent model*. A collection of parent and referenced models constitute a *model reference hierarchy*.

The interface of a referenced model consists of its:

- Input and output ports (and control ports, in the case of a conditional referenced model)
- Parameter arguments

A Model block displays inputs and outputs corresponding to the root-level inputs and outputs of the model it references. These ports enable you to incorporate the referenced model into the block diagram of the parent model. The interface of the referenced model, not the context from which the model is referenced, defines the attributes of blocks in the referenced model. For example, attributes such as dimensions and data types do not propagate across Model block boundaries. Use the root Inport of the referenced model to set the interface attributes.

For example, the `sldemo_mdhref_basic` model includes Model blocks that reference three instances of the same referenced model, `sldemo_mdhref_counter`.

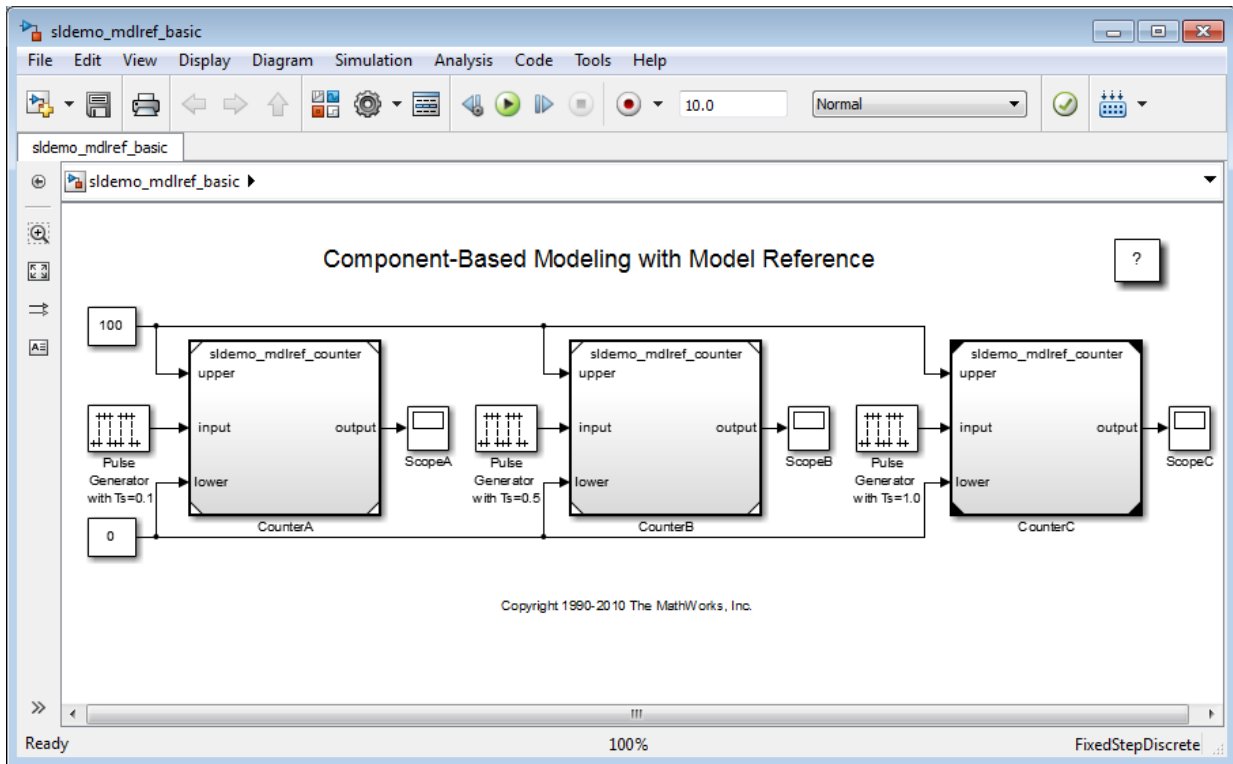

## Model Reference Hierarchies

A referenced model can itself contain Model blocks and thus reference lower-level models, to any depth. The *top model* is the topmost model in a hierarchy of referenced models. Where only one level of model reference exists, the parent model and top model are the same. To prevent cyclic inheritance, a Model block cannot refer directly or indirectly to a model that is superior to it in the model reference hierarchy. This figure shows cyclic inheritance.

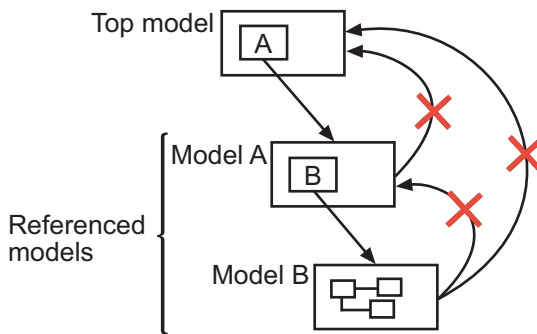

A parent model can contain multiple Model blocks that reference the same referenced model as long as the referenced model does not define global data. The referenced model can also appear in other parent models at any level. You can parameterize a referenced model to provide tunability for all instances of the model. Also, you can parameterize a referenced model to let different Model blocks specify different values for variables that define the behavior of the referenced model. See “Parameterize Instances of a Reusable Referenced Model” on page 8-65 for details.

## Model Block and Referenced Model Ports

Use the ports on a Model block to connect the referenced model to other elements of the parent model. Connecting a signal to a Model block port has the same effect as connecting the signal to the corresponding port in the referenced model. For example, the Model block CounterA has three inputs: two Constant blocks and a Pulse Generator block with a sample time of .1. The Model block CounterB also has three inputs: the same two Constant blocks, and a Pulse Generator block with a sample time of .5. Each Model block has an output to a separate Scope block.

The referenced model includes Inport and Outport blocks (and possibly Trigger or Enable blocks) to connect to the parent model. The `sldemo_md1ref_counter` model has three Inport blocks (upper, input, and lower) and one Outport block (output).

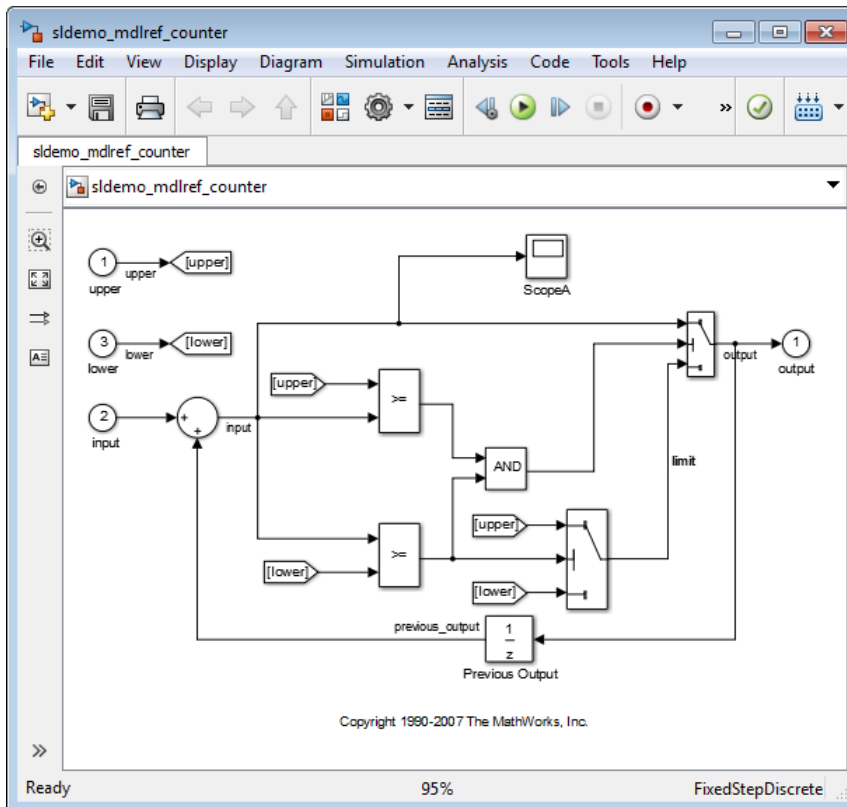

## Using Referenced Models as Standalone Models

If a referenced model does not depend on data that is available only from a higher-level model, you can use a referenced model as a standalone model. An appropriately configured model can function as both a standalone model and a referenced model, without changing the model or any entities derived from it.

## Examples of Models That Use Model Referencing

Simulink includes several models that illustrate model referencing.

The [Introduction to Managing Data with Model Reference](#) example introduces the basic concepts and workflow related to managing data with model

referencing. To explore these topics in more detail, select the **Detailed Workflow for Managing Data with Model Reference** example.

In addition, the `sldemo_absbrake` model represents a wheel speed calculation as a Model block within the context of an anti-lock braking system (ABS).

### Simulation of Model Referencing Models

You can simulate a referenced model either interpretively (in normal mode) or by compiling the referenced model to code and executing the code (in accelerator mode). For details, see “Simulate Model Referencing Models” on page 8-31.

### Code Generation for Referenced Models

To learn about considerations when generating code for a referenced model, see “Referenced Models” (Simulink Coder).

### See Also

**Blocks**  
Model

### Related Examples

- “When to Use Model Referencing” on page 8-7
- “Create a Referenced Model” on page 8-9
- “Convert a Subsystem to a Referenced Model” on page 8-17

### More About

- “Componentization Guidelines” on page 15-29
- “Subsystem to Referenced Model Conversion” on page 8-13
- “Simulink Model Referencing Requirements” on page 8-59
- “Model Referencing Limitations” on page 8-100
- “Model Configuration Parameters: Model Referencing”
- “Model Configuration Parameters: Model Referencing Diagnostics”



## When to Use Model Referencing

### In this section...

“Referenced Model Advantages” on page 8-7

“Compare Model Referencing to Other Componentization Techniques” on page 8-8

### Referenced Model Advantages

Like subsystems, referenced models allow you to organize large models hierarchically. Model blocks can represent major subsystems. Like libraries, referenced models allow you to use the same capability repeatedly without having to redefine it. Referenced models provide several advantages that are unavailable with subsystems and/or library blocks. Several of these advantages result from Simulink compiling a referenced model independent of the context of the referenced model.

- **Modular development**

You can develop a referenced model independently from the models that use it.

- **Model Protection**

You can obscure the contents of a referenced model, allowing you to distribute it without revealing the intellectual property that it embodies.

- **Inclusion by reference**

You can reference a model multiple times without having to make redundant copies, and multiple models can reference the same model.

- **Incremental loading**

Simulink loads a referenced model at the point it needs to use the model, which speeds up model loading.

- **Accelerated simulation**

Simulink can convert a referenced model to code and simulate the model by running the code, which is faster than interactive simulation.

- **Incremental code generation**

Accelerated simulation requires code generation only if the model has changed since the code was previously generated.

- **Independent configuration sets**

The configuration set used by a referenced model can differ from the configuration set of its parent or other referenced models.

For a video summarizing advantages of model referencing, see [Modular Design Using Model Referencing](#).

### **Compare Model Referencing to Other Componentization Techniques**

Model referencing provides many benefits for componentization of a model. However, using subsystems or libraries can meet some modeling requirements better than model referencing. You can use all three componentization techniques in the same model.

For additional information about how model referencing compares to other Simulink componentization techniques, see “Componentization Guidelines” on page 15-29.

### **Related Examples**

- “Create a Referenced Model” on page 8-9
- “Convert a Subsystem to a Referenced Model” on page 8-17
- “Parameterize Instances of a Reusable Referenced Model” on page 8-65

### **More About**

- “Componentization Guidelines” on page 15-29
- “Subsystem to Referenced Model Conversion” on page 8-13
- “Simulink Model Referencing Requirements” on page 8-59
- “Model Referencing Limitations” on page 8-100

## Create a Referenced Model

A model becomes a referenced model when a Model block in some other model references it. Any model can function as a referenced model, and such use does not preclude using it as a separate model also.

For a video introducing how to create model references, see [Getting Started with Model Referencing](#).

To create a reference to a model (referenced model) in another model (parent model):

- 1 If the folder containing the referenced model you want to reference is not on the MATLAB path, add the folder to the MATLAB path.
- 2 In the referenced model:
  - Set **Configuration Parameters > Model Referencing > Total number of instances allowed per top model** to:
    - **One**, if the hierarchy uses the model at most once
    - **Multiple**, to use the model more than once per top model. To reduce overhead, specify **Multiple** only when necessary.
    - **Zero**, which precludes referencing the model
- 3 Create an instance of the Model block in the parent model by dragging a Model block instance from the Ports & Subsystems library to the parent model. The new block is initially unresolved (specifies no referenced model) and has the following appearance:

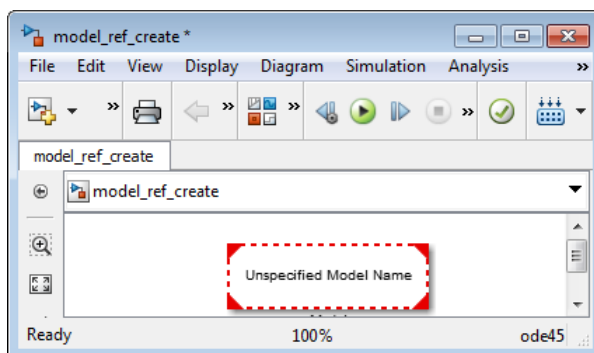

- 4 Open the new Model block's parameter dialog box by double-clicking the Model block. See “Navigating a Model Block” for more about accessing Model block parameters.

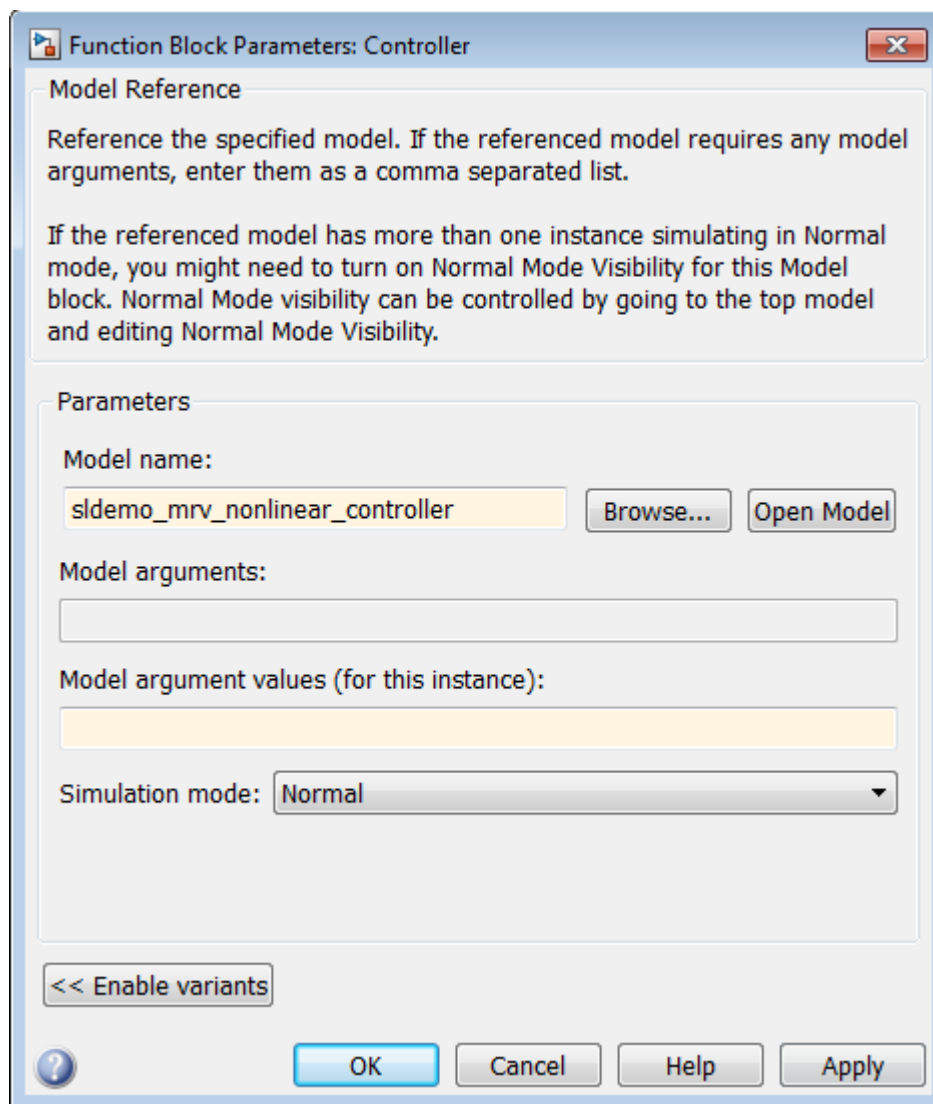

- 5 Enter the name of the referenced model in the **Model name** field. This name must contain fewer than 60 characters. (See “Name Length Requirement” on page 8-59.)
  - For information about **Model Arguments**, see “Specify Different Value for Each Instance of Reusable Model” on page 8-65.
  - For information about the **Simulation mode**, see “Simulate Model Referencing Models” on page 8-31.
- 6 Click **OK** or **Apply**.

If the referenced model contains any root-level inputs or outputs, Simulink displays corresponding input and output ports on the Model block instance that you have created. Use these ports to connect the referenced model to other ports in the parent model.

A signal that connects to a Model block is functionally the same signal outside and inside the block. Therefore that signal is subject to the restriction that a given signal can have at most one associated signal object. See `Simulink.Signal` for more information. For information about connecting a bus signal to a referenced model, see “Bus Usage Requirements” on page 8-63.

## Masking Model Blocks

You can use the masking facility to create custom dialog boxes and icons for Model blocks. Masked dialog boxes can make it easier to specify additional parameters for Model blocks. For information about block masks, see “Block Masks”.

## See Also

### Blocks

Model

## Related Examples

- “Convert a Subsystem to a Referenced Model” on page 8-17
- “Sample Times for Model Referencing” on page 8-26
- “Sample Times for Model Referencing” on page 8-26
- “Create and Reference Conditional Referenced Models” on page 8-82
- “View a Model Referencing Hierarchy” on page 8-44

### **More About**

- “Subsystem to Referenced Model Conversion” on page 8-13
- “Simulink Model Referencing Requirements” on page 8-59
- “Model Referencing Limitations” on page 8-100

## Subsystem to Referenced Model Conversion

### In this section...

“When to Convert to Model Referencing” on page 8-13

“Limitations on Subsystems That You Can Convert” on page 8-13

“Conversion Process” on page 8-13

“Conversion Checking” on page 8-15

“Conversion Results” on page 8-15

“Conversion Report” on page 8-16

### When to Convert to Model Referencing

Before you convert a subsystem to model referencing, consider whether model referencing is the approach to use to meet your modeling requirements.

Model referencing offers several benefits for modeling large, complex systems and for team-based development. However, subsystems or libraries are better suited for some modeling goals than model referencing. Many large models involve using a combination of subsystems and referenced models. For information to help you to decide whether to convert a subsystem to a referenced model, see “Componentization Guidelines” on page 15-29.

### Limitations on Subsystems That You Can Convert

You cannot convert to a referenced model Subsystems with Simscape Multibody components.

To convert a masked subsystem, use the `Simulink.SubSystem.convertToModelReference` function.

To create a referenced model that accepts asynchronous function calls, see “Asynchronous Support Limitations” (Simulink Coder).

### Conversion Process

The general process for converting a subsystem to a referenced model involves the following tasks. For details, see “Convert a Subsystem to a Referenced Model” on page 8-17.

- 1 Determine whether converting the subsystem to a referenced model meets your modeling requirements.
- 2 Optionally, prepare the model before converting the subsystem.
- 3 To create a referenced model, run the Model Reference Conversion Advisor. Address any issues that the advisor reports and continue the conversion until the advisor reports no issues.

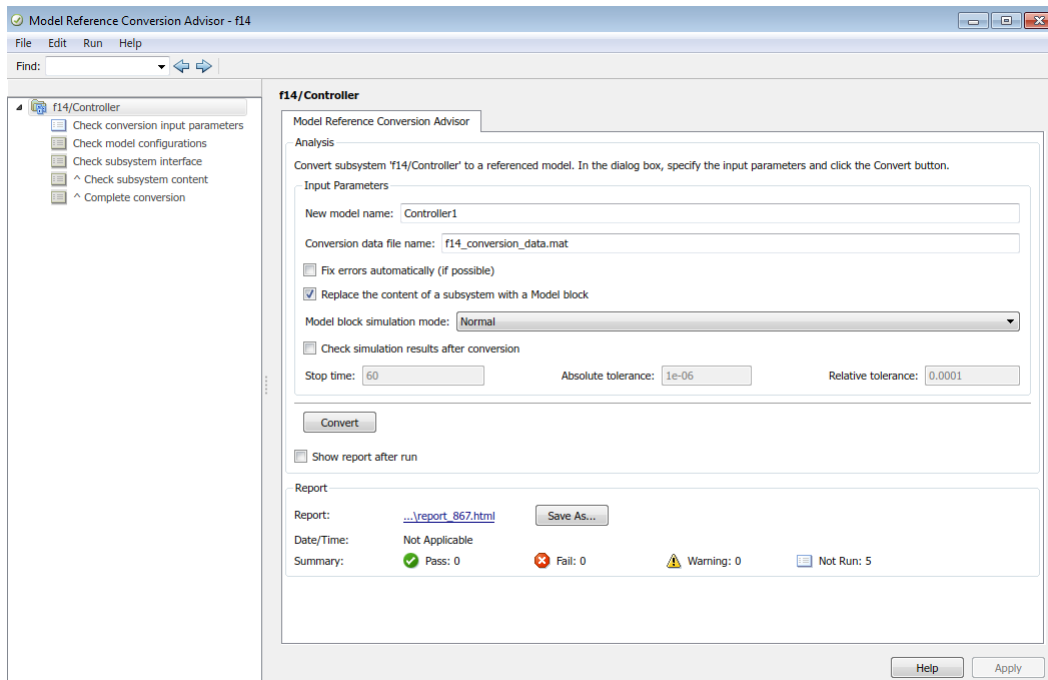

- 4 Optionally, have the advisor compare the results of simulating the model before and after the conversion. Set up signal logging for key signals. Check the consistency of the top model simulation results.
- 5 After you complete the conversion, update the model as necessary.

### Command-Line Interface

As an alternative to using the Model Reference Conversion Advisor, you can use the `Simulink.SubSystem.convertToModelReference` function to convert a subsystem to a referenced model. You can convert multiple subsystems using one `Simulink.SubSystem.convertToModelReference` command.



## Conversion Checking

The Model Reference Conversion Advisor includes a set of conversion checks and parameters for configuring the advisor.

The advisor runs through the series of checks that help you to prepare the subsystem for successful conversion. If an advisor check reports an issue, before continuing the conversion process, either:

- Allow the advisor to fix the issue.
- Change the model based on the modifications the advisor suggests.

You can have the advisor fix all conversion issues that it can fix. In the **Check Conversion Input Parameters** check, select **Fix errors automatically (if possible)**. This option can make the conversion process faster, but you do not control the fixes that the advisor makes.

## Conversion Results

After the advisor runs all the checks successfully, it:

- Creates a referenced model from the subsystem
- Creates the bus objects, signal objects, and tunable parameters that the referenced model requires
- Adds a Model block (by default)
- Inserts the Model block in a wrapper subsystem when the automatic fixes modify the Model block interface by adding ports.
- Creates a conversion summary report
- Checks the consistency of simulation results before and after conversion (if you select that option)

The advisor copies the following elements from the original model to the new referenced model.

- **Configuration set** — If the referencing model uses:
  - A configuration set that is not a referenced configuration set, the advisor copies the entire configuration set to the referenced model.

- A referenced configuration set, then both the referencing and referenced models use the same referenced configuration set.
- **Variables** — The advisor copies into the model workspace of the referenced model only the model workspace variables that the subsystem used in the original model.

If the model that contains the subsystem uses a data dictionary, then the referenced model uses the same data dictionary.

- **Requirements links** — Requirements links created with the Simulink Verification and Validation software (for example, requirements links to blocks and signals) are copied. The advisor transfers the requirements links from the subsystem to the new Model block.

The conversion summary report describes the elements that it copies.

### Conversion Report

The advisor creates an HTML report in the `slprj` folder that it uses while performing the conversion. The report summarizes the results of the conversion process, including the results of the fixes that the advisor performed.

### Related Examples

- “Convert a Subsystem to a Referenced Model” on page 8-17

### More About

- “Componentization Guidelines” on page 15-29

## Convert a Subsystem to a Referenced Model

### In this section...

“Determine Whether to Convert the Subsystem” on page 8-17

“Update the Model Before Converting the Subsystem” on page 8-17

“Run the Model Reference Conversion Advisor” on page 8-21

“Compare Simulation Results Before and After Conversion” on page 8-22

“Revert the Conversion Results” on page 8-23

“Integrate the Referenced Model into the Parent Model” on page 8-23

### Determine Whether to Convert the Subsystem

Before you convert a subsystem to model referencing, consider whether model referencing is the approach to use to meet your modeling requirements.

Model referencing offers several benefits for modeling large, complex systems and for team-based development. However, subsystems or libraries are better suited for some modeling goals than model referencing. Many large models involve using a combination of subsystems and referenced models. For information to help you to decide whether to convert a subsystem to a referenced model, see “Componentization Guidelines” on page 15-29.

Confirm that the subsystem you want to convert is a type of subsystem that you can convert. See “Limitations on Subsystems That You Can Convert” on page 8-13.

### Update the Model Before Converting the Subsystem

---

**Tip:** Before you perform the conversion, make sure that the model containing the subsystem that you want to convert compiles successfully.

---

The advisor fixes or guides you through fixing issues. However, if you are converting a large, complex subsystem, consider taking steps before you convert the model. Preparing the model and subsystem can eliminate or reduce the number of issues the advisor identifies. It can be more efficient to address issues in the model editing environment than to switch repeatedly between the advisor and the Simulink Editor.

---

**Note:** You can use Model Reference Conversion Advisor **Fix** option to have the advisor fix some conversion issues.

---

- 1 Set the **Configuration Parameters > Diagnostics > Data Validity > Signal resolution** parameter to **Explicit only** or **None**.

You can use the Model Reference Conversion Advisor **Fix** option to address this issue automatically.

- 2 Configure these subsystem interfaces to the model.

Subsystem Interface	What to Look For	Model Modification
Goto or From blocks	Crossing of subsystem boundaries	<p>Use an Inport block to replace From blocks that have a corresponding GoTo block that crosses the subsystem boundary.</p> <p>Use an Outport block to replace each GoTo block that has corresponding From blocks that cross the subsystem boundary.</p> <p>Connect the Inport and Outport blocks to the corresponding subsystem ports.</p> <p>You can use the Model Reference Conversion Advisor <b>Fix</b> option to address this issue.</p>
Data stores	Data Store Memory blocks accessed by Data Store Read or Data Store Write blocks from outside of the subsystem	<p>Replace the Data Store Memory block with a global data store. Define a global data store using a <code>Simulink.Signal</code> object. For details, see “Data Stores with Signal Objects” on page 60-20.</p> <p>You can use the Model Reference Conversion Advisor <b>Fix</b> option to address this issue.</p>

Subsystem Interface	What to Look For	Model Modification
Tunable parameters	Global tunable parameters in the dialog box opened using the <b>Configuration Parameters &gt; Optimization &gt; Signals and Parameters &gt; Configure</b> button	<p>Use <code>tunablevars2parameterobjects</code> to create a <code>Simulink.Parameter</code> object for each tunable parameter.</p> <p>The <code>Simulink.Parameter</code> objects must have a storage class other than <code>Auto</code>.</p> <p>For more information, see “Parameterize Instances of a Reusable Referenced Model” on page 8-65 and “Tunable Parameters” on page 3-8.</p> <p>You can use the Model Reference Conversion Advisor <b>Fix</b> option to address this issue.</p>

### 3 Configure the subsystem and its contents.

Subsystem Configuration	What to Look For	Model Modification
Inactive subsystem variants	Variant Subsystem blocks.	<p>Make the subsystem variant that you want to convert active. The advisor does not convert inactive subsystem variants.</p> <p>To have the new Model block behave similar to the subsystem variant, convert each variant subsystem separately and then use a Model Variants block. For more information, see “Set up Model Variants” on page 11-45.</p>
Function calls	Function-call signals that cross virtual subsystem boundaries.	<p>Move the Function-Call Generator block into the subsystem that you want to convert.</p> <hr/> <p><b>Note:</b> If you convert an export-function subsystem, then you do</p>

Subsystem Configuration	What to Look For	Model Modification
		not need to move the Function-Call Generator block.
	Function-call outputs.	Change the function-call outputs to data triggers.
	Wide function-call ports.	Eliminate wide signals for function-call subsystems.
Sample times	Sample time of an Inport block that does not match the sample time of the block driving the Inport.	Insert Rate Transition blocks where appropriate.
Inport blocks	Merged Inport blocks.	Configure the model to avoid merged Inport blocks. See the Merge block documentation.
Constant blocks	Constant blocks that input to subsystems.	Consider moving the Constant blocks into the subsystem.
Buses	Bus signals that enter and exit a subsystem.	Match signal names and bus element names for blocks inside the subsystem.  Consider using the <b>Configuration Parameters &gt; Diagnostics &gt; Connectivity &gt; Signal label mismatch</b> diagnostic.
	Duplicate signal names in buses.	Make signal names of the bus elements unique.

Subsystem Configuration	What to Look For	Model Modification
	<p>Signal names that are not valid MATLAB identifiers. A valid identifier is a character vector that meets these conditions:</p> <ul style="list-style-type: none"> <li>• The name contains letters, digits, or underscores.</li> <li>• The first character is a letter.</li> <li>• The length of the name is less than or equal to the value returned by the <code>namelengthmax</code> function.</li> </ul>	<p>Change any invalid signal names to be valid MATLAB identifiers.</p>

## Run the Model Reference Conversion Advisor

**Note:** As an alternative to running the Model Reference Conversion Advisor, you can use the `Simulink.SubSystem.convertToModelReference` function.

Before you run the advisor, make sure that the model containing the subsystem that you want to convert compiles successfully.

- 1 Open the model and locate the subsystem that you want to convert.
- 2 For improved conversion performance, close any open Scope block windows.
- 3 Start the Model Reference Conversion Advisor. In the Simulink Editor, right-click the subsystem that you want to convert. Select **Subsystem & Model Reference > Convert Subsystem to > Referenced Model**.
- 4 In the Model Reference Conversion Advisor dialog box, review the default settings under **Input Parameters**. Modify the parameters for running the advisor as needed and click **Apply**.

---

**Tip:** The advisor provides context-sensitive help for checks. In the advisor, right-click the check (such as **Check conversion input parameters**) and select **What's This?**.

---

---

**Note:** The advisor can compare simulation results for the top model for the referenced model to the results for the baseline model containing the subsystem. Select **Check simulation results after conversion**. For details, see “Compare Simulation Results Before and After Conversion” on page 8-22.

---

- 5 Click **Convert**.
- 6 Address any issues that the advisor reports. For some issues, the advisor provides a **Fix** button to address an issue.
- 7 After you address each issue, click **Continue** until all the checks pass.

### Compare Simulation Results Before and After Conversion

The advisor can compare simulation results before and after the conversion.

Before you convert the subsystem:

- In the Model Reference Conversion Advisor, under **Input Parameters**, select **Replace subsystem with a Model block** and **Check simulation results after conversion**.
- Set these options:
  - **Stop time**
  - **Absolute tolerance**
  - **Relative tolerance**
- Enable signal logging for the subsystem output signals of interest.
- Set the **Model block simulation mode** option in the advisor to the same simulation mode as the original model.

After you convert the model, select **View comparison results**. The results display in the Simulation Data Inspector. A green check mark indicates that the simulation results are the same for the baseline model and the model with the referenced model.



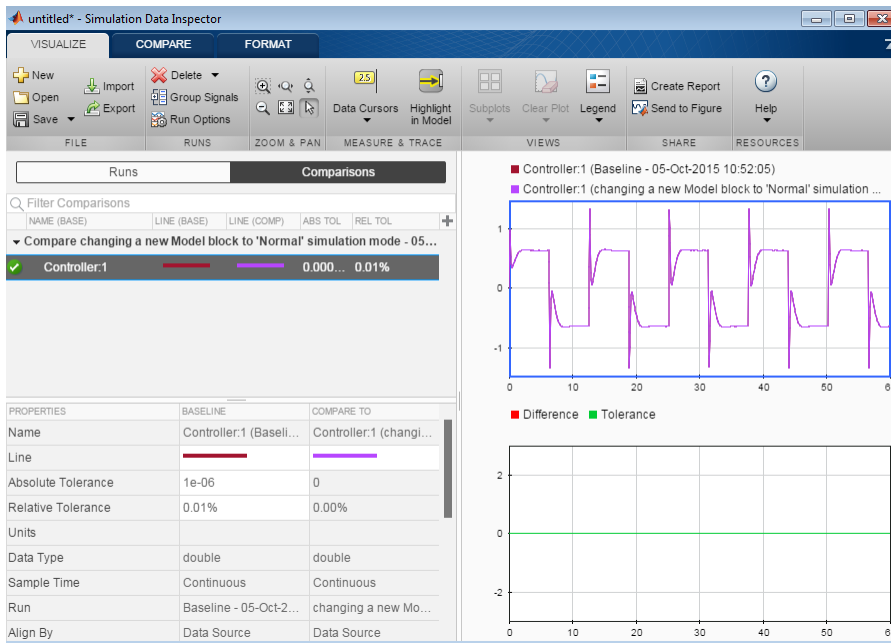

For more information about the Simulation Data Inspector, see “View and Analyze Simulation Results”.

## Revert the Conversion Results

If you are not satisfied with the conversion results, you can restore the model to its initial state. Use one of these approaches:

- At any point during the conversion, select **File > Load Restore Point**.
- After you successfully run the **Complete conversion** check, select **Click here to restore the original model**.

## Integrate the Referenced Model into the Parent Model

After you complete the conversion, update the model as necessary to meet your modeling requirements.

### Add a Model Block, If Necessary

If, before the conversion, you cleared the **Replace the content of a subsystem with a Model block** option, then add a Model block to the parent model manually.

- 1 Delete the Subsystem block.
- 2 Copy the new Model block into the model, where the subsystem was.

---

**Note:** If you enable the **Replace the content of a subsystem with a Model block** option, the advisor action depends on whether you use the automatic fix options.

- If you use the automatic fixes, then the advisor replaces the Subsystem block with a Model block unless the automatic fixes change the input or output ports. If the ports change, then the advisor includes the contents of the subsystem in a Model block that is inserted in the Subsystem block.
  - If you do not use the automatic fixes, then the advisor replaces the Subsystem block with a Model block.
- 

### Inspect Root Inport Blocks in the Referenced Model

If you want to simulate the model with external data, check that the root Inport blocks in the new referenced model have the appropriate **Interpolate data** parameter setting. For details, see the documentation for the **Interpolate data** parameter of the Inport block.

### Convert Each Variant Subsystem

If you convert an active variant subsystem, convert each of the variant subsystems to referenced model. Converting each variant subsystem to a referenced model produces similar results to using the Variant Subsystem block.

### Related Examples

- “Create a Referenced Model” on page 8-9

### More About

- “Subsystem to Referenced Model Conversion” on page 8-13
- “Componentization Guidelines” on page 15-29

- “Overview of Model Referencing” on page 8-2
- “Model Referencing Limitations” on page 8-100

## Sample Times for Model Referencing

### In this section...

“How Sample-Time Inheritance Works for Model Blocks” on page 8-26

“Conditions for Inheriting Sample Times” on page 8-26

“Determining Sample Time of a Referenced Model” on page 8-27

“Blocks That Depend on Absolute Time” on page 8-27

“Blocks Whose Outputs Depend on Inherited Sample Time” on page 8-28

“Sample Time Consistency” on page 8-29

### How Sample-Time Inheritance Works for Model Blocks

The sample times of a Model block are the sample times of the model that it references. If the referenced model must run at specific rates, the model specifies the required rates. Otherwise, the referenced model inherits its sample time from the parent model.

Placing a Model block in a triggered, function call, or iterator subsystem relies on the ability to inherit sample times. Additionally, allowing a Model block to inherit sample time maximizes its reuse potential. For example, a model can fix the data types and dimensions of all its input and output signals. You could reuse the model with different sample times (for example, discrete at 0.1 or discrete at 0.2, triggered).

### Conditions for Inheriting Sample Times

A referenced model inherits its sample time if the model:

- Does not have any continuous states
- Specifies a fixed-step solver and the **Fixed-step size** is **auto**
- Contains no blocks that specify sample times (other than inherited or constant)
- Does not contain any S-functions that use their specific sample time internally
- Has only one sample time (not counting constant and triggered sample time) after sample time propagation
- Does not contain any blocks, including Stateflow charts, that use absolute time, as listed in “Blocks That Depend on Absolute Time” on page 8-27
- Does not contain any blocks whose outputs depend on inherited sample time, as listed in “Blocks Whose Outputs Depend on Inherited Sample Time” on page 8-28.

You can use a referenced model that inherits its sample time anywhere in a parent model. By contrast, you cannot use a referenced model that has intrinsic sample times in a triggered, function call, or iterator subsystem. To avoid rate transition errors, ensure that blocks connected to a referenced model with intrinsic samples times operate at the same rates as the referenced model.

For more information, see “Blocks Whose Outputs Depend on Inherited Sample Time” on page 8-28.

## Determining Sample Time of a Referenced Model

To determine whether a referenced model can inherit its sample time, set the **Periodic sample time constraint** on the **Solver** configuration parameters dialog pane to **Ensure sample time independent**. If the model is unable to inherit sample times, this setting causes Simulink to display an error message when building the model. See “Periodic sample time constraint” for more about this option.

To determine the intrinsic sample time of a referenced model, or the fastest intrinsic sample time for multirate referenced models:

- 1 Update the model that references the model
- 2 Select a Model block within the parent model
- 3 Enter the following at the MATLAB command line:

```
get_param(gcf, 'CompiledSampleTime')
```

## Blocks That Depend on Absolute Time

The following Simulink blocks depend on absolute time, and therefore preclude a referenced model from inheriting sample time:

- Backlash (only when the model uses a variable-step solver and the block uses a continuous sample time)
- Chirp Signal
- Clock
- Derivative
- Digital Clock
- Discrete-Time Integrator (only when used in triggered subsystems)
- From File

- From Workspace
- Pulse Generator
- Ramp
- Rate Limiter
- Repeating Sequence
- Signal Generator
- Sine Wave (only when the **Sine type** parameter is **Time -based**)
- Stateflow (when the chart uses absolute-time temporal logic, or the reserved word **t** to reference time)
- Step
- To File
- To Workspace (only when logging to **Timeseries** or **Structure With Time** format)
- Transport Delay
- Variable Time Delay
- Variable Transport Delay

Some blocks other than Simulink blocks depend on absolute time. See the documentation for the blocksets that you use.

### Blocks Whose Outputs Depend on Inherited Sample Time

Using a block whose output depends on an inherited sample time in a referenced model can cause simulation to produce unexpected or erroneous results. When building a referenced model that does not need a specified rate, Simulink checks for blocks whose outputs are functions of the inherited sample time. This checking includes examining S-Function blocks. If Simulink finds any such blocks, it specifies a default sample time. Simulink displays an error if you have set the **Configuration Parameters > Solver > Periodic sample time constraint** to **Ensure sample time independent**. See “Periodic sample time constraint” for more about this option.

The outputs of the following built-in blocks depend on inherited sample time. The outputs of these blocks preclude a referenced model from inheriting its sample time from the parent model:

- Discrete-Time Integrator
- From Workspace (if it has input data that contains time)

- Probe (if probing sample time)
- Rate Limiter
- Sine Wave

Simulink assumes that the output of an S-function does not depend on inherited sample time unless the S-function explicitly declares the contrary. See “Sample Times” for information on how to create S-functions that declare whether their output depends on their inherited sample time.

In referenced models that inherit their sample time, avoid S-functions in referenced models that fail to declare whether output depends on inherited sample time. Excluding those kinds of S-functions helps to avoid simulation errors. By default, Simulink warns you if your model contains such blocks when you update or simulate the model. See “Unspecified inheritability of sample time” for details.

## Sample Time Consistency

Use consistent sample time rates to promote the reliable use of a model referenced by another model. Make the rates of root Inport and Outport blocks in a referenced model consistent with the rates of blocks reading from and writing to those blocks. Simulink generates an error when there are sample time mismatches between:

- The sample times of root Inport blocks and the sample times of blocks to which the Inport block inputs.
- The sample times of root Outport blocks and the sample times of blocks that input to the Outport block.

To address an error that flags a sample time inconsistency in a referenced model, you can use one of these approaches.

Root Inport or Output Block Sample Time is Different From	Possible Solution
All of the blocks to which it connects, and those blocks all have the same sample time as each other	Set the sample time of the Inport or Output block to match the sample time of the block to which it connects.
One or more blocks and the same as one or more blocks	For blocks that do not match the Inport or Output block, insert Rate Transition blocks on the signal that connects to the Inport or Output block.

### **Related Examples**

- “Specify Sample Time” on page 7-3
- “View Sample Time Information” on page 7-9

### **More About**

- “What Is Sample Time?” on page 7-2
- “Types of Sample Time” on page 7-15



## Simulate Model Referencing Models

### In this section...

“Simulate a Top Model” on page 8-31

“Referenced Model Simulation” on page 8-31

“Faster Simulations Using Simulink Cache Files” on page 8-36

Simulating a model that uses model referencing differs in some ways from simulating a standalone model that does not use model referencing.

### Simulate a Top Model

Simulink executes the top model in a model reference hierarchy the same way that it executes models without model referencing. All the Simulink simulation modes are available to the top model. To achieve faster execution of a top model in a model reference hierarchy, you can use Simulink accelerator mode or rapid accelerator mode. For details about accelerator mode, see the “Acceleration” documentation. For information about rapid accelerator mode, see “Accelerate, Refine, and Test Hybrid Dynamic System on Host Computer by Using RSim System Target File” (Simulink Coder).

When you execute a top model in Simulink accelerator mode or rapid accelerator mode, all referenced models execute in accelerator mode.

### Referenced Model Simulation

You can simulate a referenced model in one of these modes:

- Normal
- Accelerator
- Software-in-the-loop (SIL)
- Processor-in-the-loop (PIL)

For more information about using these simulation modes for referenced models, see “Comparison of Simulation Modes for Referenced Models” on page 8-32.

The simulation modes used for referenced models depend on the simulation mode of the parent model. For details, see “Parent and Referenced Model Simulation Modes” on page 8-35.

### Specify the Simulation Mode for Referenced Models

The Model block for each instance of a referenced model controls the simulation mode of the instance. To set or change the simulation mode for a referenced model:

- 1 Access the block parameter dialog box for the Model block. (See “Navigating a Model Block”.)
- 2 Set the **Simulation mode** parameter.
- 3 Click **OK** or **Apply**.

### Comparison of Simulation Modes for Referenced Models

You can use rapid accelerator mode for the top model in a model reference hierarchy, but not for referenced models.

The different simulation modes for referenced models share many capabilities and techniques, but they have different implementations, requirements, and limitations.

---

**Tip:** Accelerator mode execution of a referenced model is different than:

- Accelerator mode execution of a freestanding or top model, as described in “Acceleration”.
- Rapid accelerator mode execution of a freestanding or top model, as described in “Accelerate, Refine, and Test Hybrid Dynamic System on Host Computer by Using RSim System Target File” (Simulink Coder).

For more information about accelerator mode execution of a referenced model, see “Model Referencing Simulation Targets” on page 8-46.

---

Simulation Mode	Description	When to Use
Normal	Executes referenced model interpretively.	Simulink executes a normal mode referenced model interpretively. Compared to other simulation modes, normal mode: <ul style="list-style-type: none"><li>• Executes more slowly.</li><li>• Requires no delay for code generation or compilation.</li></ul>

Simulation Mode	Description	When to Use
		<ul style="list-style-type: none"> <li>• Works with more Simulink and Stateflow tools, supporting tools such as:               <ul style="list-style-type: none"> <li>• Scopes, port value display, and other output viewing tools.</li> <li>• Model coverage analysis.</li> <li>• Stateflow debugging and animation.</li> </ul> </li> <li>• Provides more accurate linearization analysis.</li> <li>• Supports more S-functions than accelerator mode does.</li> </ul> <p>You can use normal mode with multiple instances of a referenced model. For details, see “Simulate Models with Multiple Referenced Model Instances” on page 8-37.</p>
Accelerator	<p>Executes the referenced model by creating a MEX-file (a simulation target) for the referenced model, then running the MEX-file.</p> <p>For more information, see “Model Referencing Simulation Targets” on page 8-46.</p>	<ul style="list-style-type: none"> <li>• Executes faster than normal mode.</li> <li>• Takes time for code generation and code compilation.</li> <li>• Does not fully support some Simulink tools, such as Model Coverage and the Simulink Debugger.</li> <li>• Supports Scope blocks, but requires using the Signal &amp; Scope Manager and adding test points to signals. Adding or removing a test point requires rebuilding the SIM target for a model.</li> </ul>

Simulation Mode	Description	When to Use
SIL	<p>Executes referenced model by generating production code. This code is compiled for, and executed on, the host platform.</p> <p>Requires Embedded Coder<sup>®</sup> software. For more information, see “SIL and PIL Limitations” (Embedded Coder) and “Numerical Equivalence Testing” (Embedded Coder).</p>	<ul style="list-style-type: none"> <li>• Verifies generated source code without modifying the original model.</li> <li>• Supports the reuse of test harnesses for the original model with the generated source code.</li> </ul> <p>SIL mode provides a convenient alternative to PIL simulation when the target hardware is not available.</p>
PIL	<p>Executes referenced model by generating production code. This code is cross-compiled for, and executed on, a target processor or an equivalent instruction set simulator.</p> <p>Requires Embedded Coder software. For more information, see “SIL and PIL Limitations” (Embedded Coder) and “Numerical Equivalence Testing” (Embedded Coder).</p>	<ul style="list-style-type: none"> <li>• Verifies deployment object code on target processors without modifying the original model.</li> <li>• Supports the reuse of test harnesses for the original model with the generated source code.</li> </ul>

**Note:** Simulation results for a given model are nearly identical in normal and accelerator modes. Trivial differences can occur, depending on differences in the optimizations and libraries that you use.

## Parent and Referenced Model Simulation Modes

The simulation modes you can use for a referenced model depends on the simulation mode of its parent model.

Parent Model Simulation Mode	Referenced Model Simulation Modes
Normal	<ul style="list-style-type: none"> <li>• Referenced models can use normal, accelerator, SIL, or PIL mode.</li> <li>• If every model that is superior to a referenced model in the model reference hierarchy also executes in normal mode, that referenced model can execute in normal mode.</li> </ul>
Accelerator	<ul style="list-style-type: none"> <li>• All subordinate models must also execute in accelerator mode.</li> <li>• When a normal mode model is subordinate to an accelerator mode model, Simulink returns a warning and temporarily overrides the normal mode specification.</li> <li>• When a SIL-mode or PIL-mode model is subordinate to an accelerator mode model, an error occurs.</li> </ul>
SIL	<ul style="list-style-type: none"> <li>• If their simulation modes are normal, accelerator, or SIL, all subordinate models also execute in SIL mode. Otherwise, an error occurs. See “Simulation Mode Override Behavior in Model Reference Hierarchy” (Embedded Coder).</li> <li>• Multiple Model blocks, starting at the top of a model reference hierarchy, can execute in SIL mode. However, during code coverage or code execution profile, only one Model block can execute at a time in SIL mode.</li> </ul>
PIL	<ul style="list-style-type: none"> <li>• If their simulation modes are normal, accelerator, or PIL, all subordinate models also execute in PIL mode. Otherwise, an error occurs. See “Simulation Mode Override Behavior in Model Reference Hierarchy” (Embedded Coder).</li> <li>• Only one Model block, starting at the top of a model reference hierarchy, can execute in PIL mode.</li> </ul>

## Faster Simulations Using Simulink Cache Files

The first time that you simulate or perform an update diagram for a referenced model that builds a rapid accelerator target for a top model or a simulation (SIM) target, the build process creates a Simulink cache file to store the build artifacts. Use the cache files to:

- Speed up first-time builds for later use by yourself or others.
- Avoid rebuild costs for a subset of referenced models without using variants that enable placeholder models.
- Speed up parallel simulations.
- Use the same cache file on different platforms (for example, UNIX and Windows), after creating the cache file on each platform.
- Avoid manual updates associated with setting the **Rebuild** configuration parameter to `Never rebuild`. That setting prevents building of SIM target and updating the cache files.

For details, see “Reuse Simulation Builds for Faster Simulations” on page 8-55.

## Related Examples

- “Simulate Models with Multiple Referenced Model Instances” on page 8-37
- “Model Referencing Simulation Targets” on page 8-46
- “Choosing a Simulation Mode” on page 33-12
- “Reduce Update Time for Referenced Models” on page 8-50

## More About

- “Overview of Model Referencing” on page 8-2

## Simulate Models with Multiple Referenced Model Instances

### In this section...

“Normal Mode Visibility” on page 8-37

“Example Models with Multiple Referenced Model Instances” on page 8-37

“Configure Models with Multiple Referenced Model Instances” on page 8-39

“Specify the Instance Having Normal Mode Visibility” on page 8-40

### Normal Mode Visibility

All instances of a normal mode referenced model are part of the simulation. However, Simulink displays only one instance in a model window. Normal mode visibility includes the display of Scope blocks and data port values.

You set normal mode visibility by selecting in the top model the **Diagram > Subsystem & Model Reference > Model Block Normal Mode Visibility**. The normal mode visibility setting determines the instance that is displayed. If you do not specify normal mode visibility for a specific instance of a referenced model, Simulink picks one instance of the referenced model to display.

After a simulation, if you try to open a referenced model from a Model block that does not have normal mode visibility, Simulink displays a warning.

To set up your model to control which instance of a referenced model in normal mode has visibility and to ensure proper simulation of the model, see “Specify the Instance Having Normal Mode Visibility” on page 8-40.

### Example Models with Multiple Referenced Model Instances

The `sldemo_mdhref_basic` model and the “Visualizing Model Reference Architectures” featured example show the use of models containing multiple instances of a referenced model.

#### `sldemo_mdhref_basic`

The `sldemo_mdhref_basic` model has three Model blocks (CounterA, CounterB, and CounterC) that each reference the `sldemo_mdhref_counter` model.

If you update the diagram, the `sldemo_md1ref_basic` displays different icons for each of the three Model blocks that reference `sldemo_md1ref_counter`.

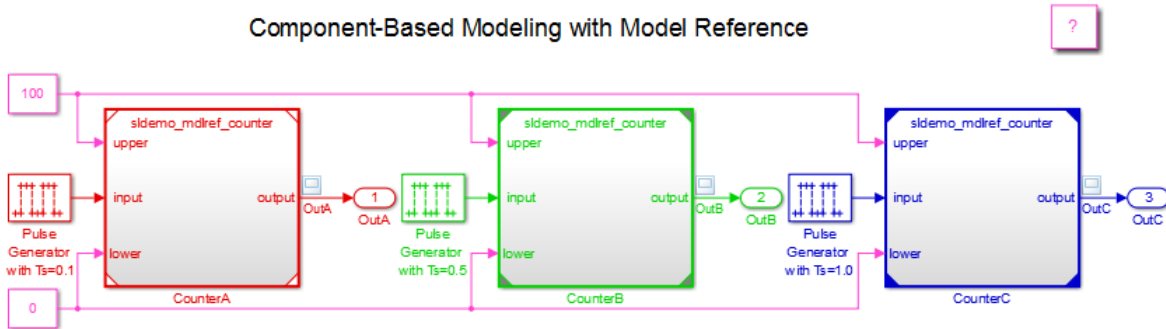

Copyright 1990-2014 The MathWorks, Inc.

Model Block	Icon Corners	Simulation Mode and Normal Mode Visibility Setting
CounterA	White	Normal mode, with normal mode visibility enabled
CounterB	Gray corners	Normal mode, with normal mode visibility disabled
CounterC	Black corner	Accelerator mode (normal mode visibility is not applicable)

Open and simulate `sldemo_md1ref_basic`. Double-click the CounterA model and open the ScopeA block.



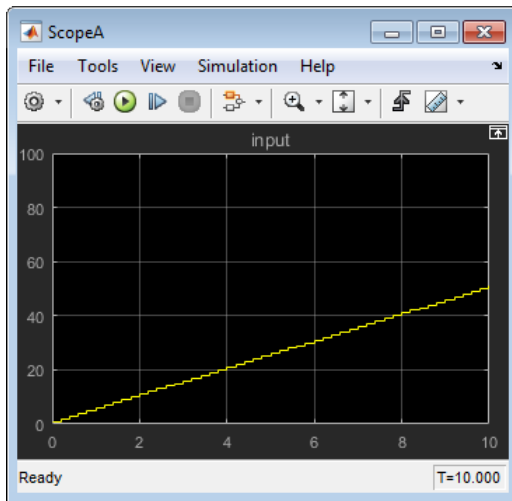

That ScopeA block reflects the results of simulating the CounterA Model block, which has normal mode visibility enabled.

If you try to open mdlref\_counter model by double-clicking the CounterB Model block, ScopeA in mdlref\_counter still shows the results of the CounterA Model block because that block has normal mode visibility enabled.

### Visualizing Model Reference Architectures

The featured example Visualizing Model Reference Architectures shows the use of the Model Dependency Viewer for a model (sldemo\_mdref\_depgraph) that references multiple instances of a referenced model in normal mode. The example shows how to set up a model with multiple referenced instances in normal mode.

## Configure Models with Multiple Referenced Model Instances

- 1 Set the **Configuration Parameters > Model Referencing > Total number of instances allowed per top model** parameter to **Multiple**.
- 2 Set each instance of the referenced model to use normal mode. In the block parameters dialog box for the Model block that references the instance, set the **Simulation Mode** parameter to **Normal**. Ensure that all the ancestors in the hierarchy for that Model block are in normal mode.

The corners of icons for Model blocks that are in normal mode can be white (empty). The corners turn gray after you update the diagram or simulate the model.

- 3 If necessary, modify S-functions used by the model so that they work with multiple instances of referenced models in normal mode. For details, see “Supporting the Use of Multiple Instances of Referenced Models That Are in Normal Mode”.

By default, Simulink assigns normal mode visibility to one of the instances. After you complete the configuration steps, you can specify a non-default instance to have normal mode visibility.

## Specify the Instance Having Normal Mode Visibility

### Determine Which Instance Has Normal Mode Visibility

To determine which instance currently has normal mode visibility:

- 1 To apply the normal mode visibility setting, update the diagram and make no other changes to the model.
- 2 Examine the Model blocks that reference the model that you are interested in. The Model block that has white corners has normal mode visibility enabled, navigate through the model hierarchy.

When you are editing a model or during compilation, after updating the diagram, use the `ModelReferenceNormalModeVisibilityBlockPath` parameter. The result is a `Simulink.BlockPath` object that is the block path for the Model block that references the model that has normal mode visibility enabled. For example:

```
get_param('sldemo_mdhref_basic',...
'ModelReferenceNormalModeVisibilityBlockPath')

ans =

    Simulink.BlockPath
    Package: Simulink

    Block Path:
        'sldemo_mdhref_basic/CounterA'
```

For a top model that you are simulating or that is in a compiled state, you can use the `CompiledModelBlockInstancesBlockPath` parameter. For example:

```

a = get_param('sldemo_md1ref_depgraph',...
    'CompiledModelBlockInstancesBlockPath')

a =

    sldemo_md1ref_F2C: [1x1 Simulink.BlockPath]
    sldemo_md1ref_heater: [1x1 Simulink.BlockPath]
    sldemo_md1ref_outdoor_temp: [1x1 Simulink.BlockPath]

```

## Enable Normal Mode Visibility for an Instance

---

**Note:** You cannot change normal mode visibility during simulation.

---

To enable normal mode visibility for a different instance of the referenced model than the instance that currently has normal mode visibility:

- 1 Navigate to the top model.
- 2 In the Simulink Editor, select the **Diagram > Subsystem & Model Reference > Model Block Normal Mode Visibility**.

The Model Block Normal Mode Visibility dialog box appears. For example, the dialog box for the `sldemo_md1ref_basic` model, with the hierarchy pane expanded, looks like this:

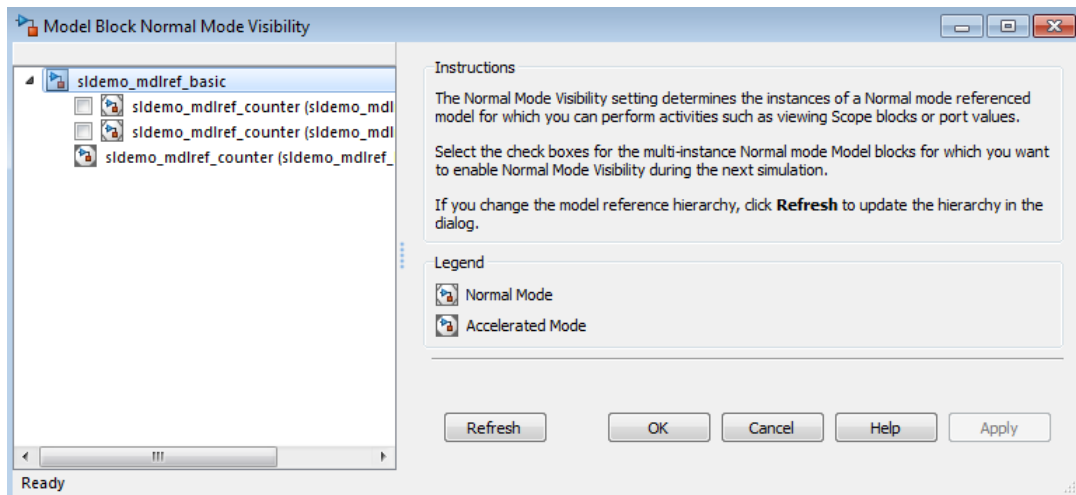

The model hierarchy pane shows a partial model hierarchy for the model from which you opened the dialog box. The hierarchy stops at the first Model block that is not in normal mode. The model hierarchy pane does not display Model blocks that reference protected models.

The dialog box shows the complete model block hierarchy for the top model. The normal mode instances of referenced models have check boxes.

---

**Tip:** To have the model hierarchy pane of the Model Block Normal Mode Visibility dialog box reflect the current model hierarchy, click **Refresh**.

---

- 3 Select the instance of the model that you want to have normal mode visibility.

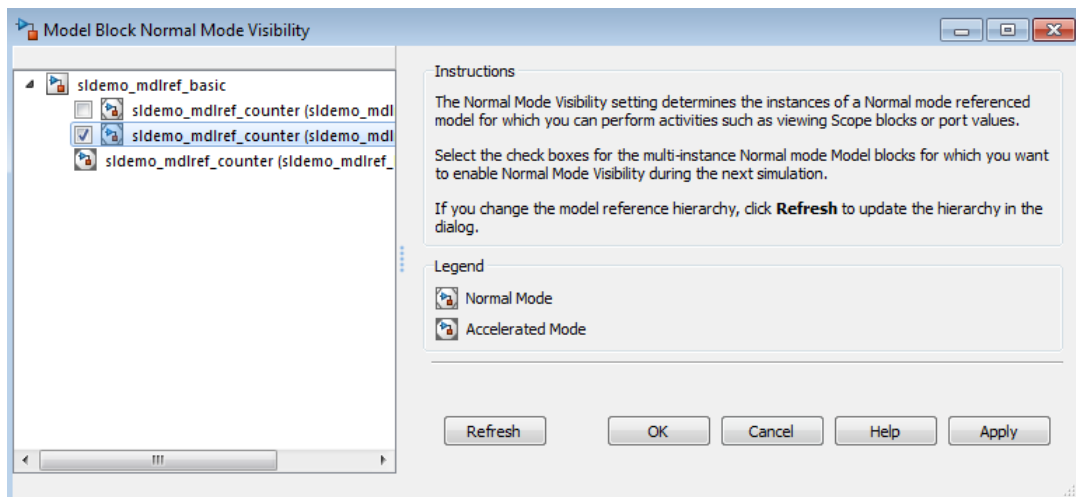

Simulink selects all ancestors of the model and clears all other instances of that model. When a model is cleared, Simulink clears all children of that model.

---

**Tip:** To open a model from the Model Block Normal Mode Visibility dialog box, right-click the model in the model hierarchy pane and then click **Open**.

---

- 4 To apply the normal mode visibility setting, simulate the top model in the model reference hierarchy.

As an alternative to using the Model Block Normal Mode Visibility dialog box, at the MATLAB command line you can use the `ModelReferenceNormalModeVisibility` parameter. For input, you can specify one of these values:

- An array of `Simulink.BlockPath` objects. For example:

```
bp1 = Simulink.BlockPath({'mVisibility_top/Model', ...
    'mVisibility_mid_A/Model'});
bp2 = Simulink.BlockPath({'mVisibility_top/Model1', ...
    'mVisibility_mid_B/Model1'});
bps = [bp1, bp2];
set_param(topMdl, 'ModelBlockNormalModeVisibility', bps);
```

- A cell array of cell arrays of character vectors, with the character vectors being paths to individual blocks and models. This example produces the same effect as the object array example:

```
p1 = {'mVisibility_top/Model', 'mVisibility_mid_A/Model'};
p2 = {'mVisibility_top/Model1', 'mVisibility_mid_B/Model1'};
set_param(topMdl, 'ModelBlockNormalModeVisibility', {p1, p2});
```

- An empty array, to specify the use of the Simulink default selection of the instance that has normal mode visibility. For example:

```
set_param(topMdl, 'ModelBlockNormalModeVisibility', []);
```

Using an empty array is equivalent to clearing all the check boxes in the Model Block Normal Mode Visibility dialog box.

## Related Examples

- “Simulate Model Referencing Models” on page 8-31
- “Choosing a Simulation Mode” on page 33-12
- “Reduce Update Time for Referenced Models” on page 8-50

## More About

- “Model Referencing Simulation Targets” on page 8-46

## View a Model Referencing Hierarchy

Simulink provides tools and functions that you can use to examine a model reference hierarchy:

- Content preview displays a representation of the contents of a referenced model, without opening the Model block. Content preview helps the user of a model understand at a glance the kind of processing performed by the referenced model. For details, see “Preview Content of Hierarchical Items” on page 1-58.
- **Model Dependency Viewer** — Shows the structure the hierarchy lets you open constituent models. The Referenced Model Instances view displays Model blocks differently to indicate normal, accelerator, and PIL modes. See “Model Dependency Viewer” on page 12-56 for more information.
- **view\_mdhrefs function** — Invokes the Model Dependency Viewer to display a graph of model reference dependencies.
- **find\_mdhrefs function** — Finds all models directly or indirectly referenced by a given model.

## Display Version Numbers

To display the version numbers of the models referenced by a model, for the parent model, choose **Display > Blocks > Block Version for Referenced Models**. Simulink displays the version numbers in the icons of the corresponding Model block instances.

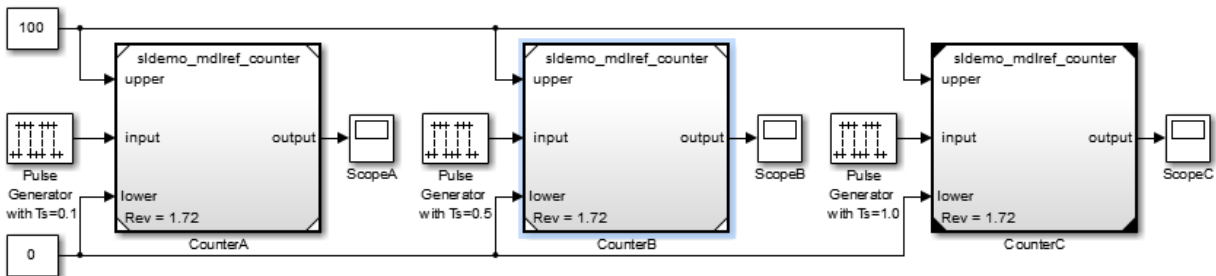

The version number displayed on a Model block icon refers to the version of the model used to either:

- Create the block

- Refresh the block most recently changed

See “Manage Model Versions and Specify Model Properties” on page 4-61 and “Refresh Model Blocks” on page 8-94 for more information.

### **Related Examples**

- “Refresh Model Blocks” on page 8-94
- “Manage Model Versions and Specify Model Properties” on page 4-61

### **More About**

- “Model Dependency Viewer” on page 12-56

## Model Referencing Simulation Targets

In this section...
“Simulation Targets” on page 8-46
“Build Simulation Targets” on page 8-47
“Simulation Target Output File Control” on page 8-48
“Reduce Update Time for Referenced Models” on page 8-50

### Simulation Targets

A *simulation target*, or *SIM target*, is a MEX-file that implements a referenced model that executes in accelerator mode. Simulink invokes the simulation target as needed during simulation to compute the behavior and outputs of the referenced model. Simulink uses the same simulation target for all accelerator mode instances of a given referenced model anywhere in a reference hierarchy.

If you have a Simulink Coder license, be careful not to confuse the simulation target of a referenced model with any of these other types of target:

- Hardware target — A platform for which Simulink Coder generates code
- System target — A file that tells Simulink Coder how to generate code for particular purpose
- Rapid Simulation target (RSim) — A system target file supplied with Simulink Coder
- Model reference target — A library module that contains Simulink Coder code for a referenced model

Simulink creates a simulation target only for a referenced model that has one or more accelerator mode instances in a reference hierarchy. A referenced model that executes only in normal mode always executes interpretively and does not use a simulation target. When one or more instance of a referenced model executes in normal mode, and one or more instance executes in accelerator mode:

- Simulink creates a simulation target for the accelerator mode instances.
- The normal mode instances do not use that simulation target.

Because accelerator mode requires code generation, it imposes some requirements and limitations that do not apply to normal mode. Aside from these constraints, you can



generally ignore simulation targets and their details when you execute a referenced model in accelerator mode. See “Limitations on Accelerator Mode Referenced Models” on page 8-103 for details.

## Build Simulation Targets

Simulink by default generates the needed target from the referenced model:

- If a simulation target does not exist at the beginning of a simulation
- When you perform an update diagram for a parent model

If the simulation target already exists, then by default Simulink checks whether the referenced model has structural changes since the target was last generated. If so, Simulink regenerates the target to reflect changes in the model. For details about how Simulink detects whether to rebuild a model reference target, see the “Rebuild” parameter documentation.

You can change this default behavior to modify the rebuild criteria or specify that Simulink always or never rebuilds targets. See “Rebuild” for details.

To generate simulation targets interactively for accelerator mode referenced models, do one of these steps:

- Update the diagram on a model that directly or indirectly references the model that is in accelerator mode
- Execute the `slbuild` command with appropriate arguments at the MATLAB command line

While generating a simulation target, Simulink displays status messages at the MATLAB command line to enable you to monitor the target generation process. Target generation entails generating and compiling code and linking the compiled target code with compiled code from standard code libraries to create an executable file.

## Reduce Change Checking Time

You can reduce the time that Simulink spends checking whether any or all simulation targets require rebuilding by setting configuration parameter values as follows:

- In all referenced models throughout the hierarchy, set **Configuration Parameters > Diagnostics > Data Validity > Signal resolution** to `Explicit only` or `None`. (See “Signal resolution”.)

- To minimize change detection time, consider setting **Configuration Parameters > Model Referencing > Rebuild options** to **If any changes in known dependencies detected on the top model**. See “Rebuild”.

These parameter values exist in the configuration set of a referenced model, not in the individual Model block, so setting either value for any instance of a referenced model sets it for all instances of that model.

### Simulation Target Output File Control

Simulink creates simulation targets in the `slprj` subfolder of the working folder. If `slprj` does not exist, Simulink creates it.

---

**Note:** Simulink Coder code generation also uses the `slprj` folder. Subdirectories in `slprj` provide separate places for simulation code, Simulink Coder code, and other files. For details, see “Manage Build Process Folders” (Simulink Coder).

---

By default, the files generated by Simulink diagram updates and model builds are placed in a build folder, the root of which is the current working folder (`pwd`). However, in some situations, you might want the generated files to go to a root folder outside the current working folder. For example:

- You need to keep generated files separate from the models and other source materials used to generate them.
- You want to reuse or share previously-built simulation targets without having to set the current working folder back to a previous working folder.

You might also want to separate generated simulation artifacts from generated production code.

To allow you to control the output locations for the files generated by diagram updates and model builds, the software allows you to separately specify the *simulation cache folder* build folder. The simulation cache folder is the root folder in which to place artifacts used for simulation.

To specify the simulation cache folder, use *one* of these approaches:

- Use the `CacheFolder` MATLAB session parameter.

- In the **Simulink Preferences > General** dialog box, use the **Simulation cache folder** preference. This preference provides the initial defaults for the MATLAB session parameters.

### Control Output Location for Model Build Artifacts Used for Simulation

To control the output location for files generated by Simulink diagram updates, in the **Simulink Preferences > General** dialog box, use the **Simulation cache folder** preference. To specify the root folder location for files generated by Simulink diagram updates, set the preference value by entering or browsing to a folder path, for example:

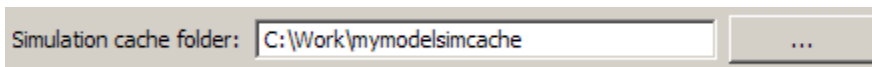

The folder path that you specify provides the initial default for the MATLAB session parameter `CacheFolder`. When you initiate a Simulink diagram update, any files generated are placed in a build folder at the root location specified by `CacheFolder` (if any), rather than in the current working folder (`pwd`).

For example, using a 32-bit Windows host platform, if you set the **Simulation cache folder** to 'C:\Work\mymodelsimcache' and then simulate the model `rtwdemo_capi`, files are generated into the specified folder as follows:

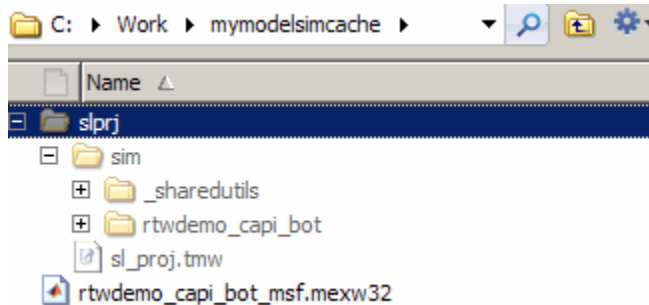

As an alternative to using the Simulink preferences to set **Simulation cache folder**, you also can get and set the preference value from the command line using `get_param` and `set_param`. For example,

```
>> get_param(0, 'CacheFolder')
```

```
ans =
```

```
''  
>> set_param(0, 'CacheFolder', fullfile('C:', 'Work', 'mymodelsimcache'))  
>> get_param(0, 'CacheFolder')  
  
ans =  
  
C:\Work\mymodelsimcache
```

Also, you can choose to override the **Simulation cache folder** preference value for the current MATLAB session.

### Override Build Folder Settings for the Current MATLAB Session

The Simulink preferences **Simulation cache folder** and **Code generation folder** provide the initial defaults for the MATLAB session parameters `CacheFolder` and `CodeGenFolder`, which determine where files generated by Simulink diagram updates and model builds are placed. However, you can override these build folder settings during the current MATLAB session, using the `Simulink.fileGenControl` function. This function allows you to directly manipulate the MATLAB session parameters, for example, overriding or restoring the initial default values. The values you set using `Simulink.fileGenControl` expire at the end of the current MATLAB session. For more information and detailed examples, see the `Simulink.fileGenControl` function reference page.

## Reduce Update Time for Referenced Models

- “Parallel Building for Large Model Reference Hierarchies” on page 8-50
- “Parallel Building Configuration Requirements” on page 8-51
- “Update Models in a Parallel Computing Environment” on page 8-51
- “Locate Parallel Build Logs” on page 8-53

### Parallel Building for Large Model Reference Hierarchies

In a parallel computing environment, you can increase the speed of diagram updates for models containing large model reference hierarchies by building referenced models that are configured in Accelerator mode in parallel whenever conditions allow. For example, if you have Parallel Computing Toolbox software, updating of each referenced model can be distributed across the cores of a multicore host computer. If you additionally have MATLAB Distributed Computing Server™ software, updating of each referenced model can be distributed across remote workers in your MATLAB Distributed Computing Server configuration.

The performance gain realized by using parallel builds for updating referenced models depends on several factors, including how many models can be built in parallel for a given model referencing hierarchy, the size of the referenced models, and parallel computing resources such as number of local and/or remote workers available and the hardware attributes of the local and remote machines (amount of RAM, number of cores, and so on).

For configuration requirements that might apply to your parallel computing environment, see “Parallel Building Configuration Requirements” on page 8-51.

For a description of the general workflow for building referenced models in parallel whenever conditions allow, see “Update Models in a Parallel Computing Environment” on page 8-51.

### **Parallel Building Configuration Requirements**

The following requirements apply to using parallel builds for updating model reference hierarchies:

- For local pools, the host machine should have an appropriate amount of RAM available for supporting the number of local workers (MATLAB sessions) that you plan to use. For example, using `parpool(4)` to create a parallel pool with four workers results in five MATLAB sessions on your machine, each using approximately 120 MB of memory at startup.
- Remote MATLAB Distributed Computing Server workers participating in a parallel build must use a common platform and compiler.
- A consistent MATLAB environment must be set up in each MATLAB worker session as in the MATLAB client session — for example, shared base workspace variables, MATLAB path settings, and so forth. One approach is to use the `PreLoadFcn` callback of the top model. If you configure your model to load the top model with each MATLAB worker session, its preload function can be used for any MATLAB worker session setup.

### **Update Models in a Parallel Computing Environment**

To take advantage of parallel building for a model reference hierarchy:

- 1 Set up a pool of local and/or remote MATLAB workers in your parallel computing environment.
  - a Make sure that Parallel Computing Toolbox software is licensed and installed.

- b To use remote workers, make sure that MATLAB Distributed Computing Server software is licensed and installed.
  - c Issue MATLAB commands to set up the worker pool, for example, `parpool(4)`.
- 2 From the top model of the model reference hierarchy, open the Configuration Parameters dialog box. Go to the **Model Referencing** pane and select the **Enable parallel model reference builds** option. This selection enables the parameter **MATLAB worker initialization for builds**.

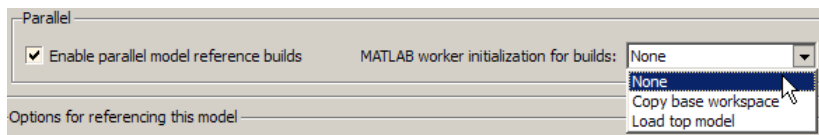

For **MATLAB worker initialization for builds**, select one of the following values:

- **None** if the software should perform no special worker initialization. Specify this value if the child models in the model reference hierarchy do not rely on anything in the base workspace beyond what they explicitly set up (for example, with a model load function).
- **Copy base workspace** if the software should attempt to copy the base workspace to each worker. Specify this value if you use a setup script to prepare the base workspace for multiple models to use.
- **Load top model** if the software should load the top model on each worker. Specify this value if the top model in the model reference hierarchy handles all of the base workspace setup (for example, with a model load function).

---

**Note:** You only need to set **Enable parallel model reference builds** for the top model of the model reference hierarchy to which it applies.

---

- 3 Optionally, turn on verbose messages for simulation builds. If you select verbose builds, the build messages report the progress of each parallel build with the name of the model.

To turn on verbose messages for simulation target builds, go to the **All Parameters** tab of the Configuration Parameters dialog box and select **Verbose accelerator builds**.

The **Verbose accelerator builds** option controls the verbosity of build messages both in the MATLAB Command Window and in parallel build log files.

- 4 Optionally, inspect the model reference hierarchy to determine, based on model dependencies, which models will be built in parallel. For example, you can use the Model Dependency Viewer from the Simulink **Analysis > Model Dependencies** menu.
- 5 Update your model. Messages in the MATLAB command window record when each parallel or serial build starts and finishes.

If you need more information about a parallel build, for example, if a build fails, see “Locate Parallel Build Logs” on page 8-53.

### Locate Parallel Build Logs

When you update a model for which referenced models are built in parallel, if verbose builds are turned on, messages in the MATLAB Command Window record when each parallel or serial build starts and finishes. For example,

```
### Initializing parallel workers for parallel model reference build.
### Parallel worker initialization complete.
### Starting parallel model reference SIM build for 'bot_model1001'
### Starting parallel model reference SIM build for 'bot_model1002'
### Starting parallel model reference SIM build for 'bot_model1003'
### Starting parallel model reference SIM build for 'bot_model1004'
### Finished parallel model reference SIM build for 'bot_model1001'
### Finished parallel model reference SIM build for 'bot_model1002'
### Finished parallel model reference SIM build for 'bot_model1003'
### Finished parallel model reference SIM build for 'bot_model1004'
```

To obtain more detailed information about a parallel build, you can examine the parallel build log. For each referenced model built in parallel, the build process generates a file named *model\_buildlog.txt*, where *model* is the name of the referenced model. This file contains the full build log for that model.

If a parallel build completes, you can find the build log file in the build subfolder corresponding to the referenced model. For example, for a build of referenced model *bot\_model1004*, look for the build log file *bot\_model1004\_buildlog.txt* in the referenced model subfolder *build\_folder/slprj/sim/bot\_model1004*.

If a parallel builds fails, you might see output similar to the following:

```
### Initializing parallel workers for parallel model reference build.
### Parallel worker initialization complete.
### Starting parallel model reference SIM build for 'bot_model1002'
### Starting parallel model reference SIM build for 'bot_model1003'
```

```
### Finished parallel model reference SIM build for 'bot_model1002'  
### Finished parallel model reference SIM build for 'bot_model1003'  
### Starting parallel model reference SIM build for 'bot_model1001'  
### Starting parallel model reference SIM build for 'bot_model1004'  
### Finished parallel model reference SIM build for 'bot_model1004'  
### The following error occurred during the parallel model reference SIM build for  
'bot_model1001':  
  
Error(s) encountered while building model "bot_model1001"  
  
### Cleaning up parallel workers.
```

If a parallel build fails, you can find the build log file in a referenced model subfolder under the build subfolder `/par_md1_ref/model`. For example, for a failed parallel build of model `bot_model1001`, look for the build log file `bot_model1001_buildlog.txt` in the subfolder `build_folder/par_md1_ref/bot_model1001/slprj/sim/bot_model1001`.

### More About

- “Simulate Model Referencing Models” on page 8-31
- “Choosing a Simulation Mode” on page 33-12
- “Simulink Model Referencing Requirements” on page 8-59
- “Model Referencing Limitations” on page 8-100



## Reuse Simulation Builds for Faster Simulations

### In this section...

“Examples of Using Simulink Cache Files” on page 8-55

“Simulink Cache Files” on page 8-56

“Share Simulink Cache Files” on page 8-57

The first time that you simulate or perform an update diagram for a referenced model that builds a rapid accelerator target for a top model or a simulation (SIM) target, the build process creates a Simulink cache file to store the build artifacts. Simulink creates:

- A SIM target for a referenced model that has one or more accelerator mode instances in a reference hierarchy
- A rapid accelerator target for the top model

The first time that you simulate or perform an update diagram for a referenced model that builds a rapid accelerator target for a top model or a SIM target, the build process creates a Simulink cache file to store the build artifacts. Use the cache files to:

- Speed up first-time build for later use by yourself or others.
- Speed up parallel simulations.
- Use the same cache file on different platforms (for example, UNIX and Windows), after creating the cache file on each platform.
- Avoid manual updates associated with setting the **Rebuild** configuration parameter to `Never rebuild`. That setting prevents building of SIM target and updating the cache files.

### Examples of Using Simulink Cache Files

For team development of large models that use model referencing, Simulink cache files are useful for a sync and design workflow. For example, suppose this model development environment:

- A team of 20 people is working on a model hierarchy containing 100 models.
- All the referenced models simulate in accelerator mode.
- The team uses Linux for development.
- The team uses a source control system for their models.

The team workflow involves using Simulink cache files:

- 1 The team has a pool of parallel worker machines (Linux) that does an update diagram on the model hierarchy every night based on the latest version of the models in the source control system and Simulink cache files in a location available to all team members.
- 2 After the update diagram is complete, the updated models and Simulink cache files are committed into the repository
- 3 The next morning, a developer named Tom gets the latest version of all models and the Simulink cache files for the complete model hierarchy from the repository into his desktop.
- 4 Tom opens the top model of the hierarchy and clicks **Run**. During simulation, the necessary files are extracted from the cache files and then the simulation begins without any builds.
- 5 Tom makes changes to some models in the hierarchy and simulates, which rebuilds models as needed. During the update diagram, Simulink updates the cache files for those models as needed.
- 6 At the end of the day, Tom commits his changes to the repository by submitting the changed models.
- 7 At night, the latest version of the model hierarchy in the repository is built with Tom's changes.
- 8 The next day, another developer, Edna, gets the latest version of all models and the corresponding cache files into her work area.
- 9 Edna simulates the top model. The necessary artifacts are extracted from the cache files without a build.

Another example of using Simulink cache files is for parallel simulations.

### Simulink Cache Files

Simulink cache files are container files that include the build artifacts for SIM targets and rapid accelerator targets. For a model reference hierarchy, there is a cache file for each referenced model that generates those targets. The cache file name is the name of the model plus the file extension `.slxc`.

The cache files are stored in the folder specified by the **Simulation cache folder** preference. You can change the default location, but it must be on the MATLAB path to

use the cache file with the model. To preserve a version of a cache file, use one of these approaches:

- Use a version control system such as Git.
- Manually move the cache file outside of the folder specified with the **Simulation cache folder** preference.
- Specify a different folder with the **Simulation cache folder** preference before doing a rebuild.

Simulink creates a cache file the first time you perform an update model or simulate a model that produces the targets. When you modify a model and perform an update diagram or simulate the model, Simulink determines whether a rebuild is needed, based on the **Rebuild** configuration parameter setting for the model. For a rebuild, Simulink updates the build artifacts on disk and updates the cache file.

## Share Simulink Cache Files

If your referenced model is part of a large model developed by a team, sharing Simulink cache files with team members saves them the first-time build overhead when they use your model.

When your model is ready to share, consider including its cache files in a Simulink project. When you create a new project from a top model, the project includes associated cache files for the model and its referenced models.

- To include cache files in the share operation, use the **Simulink Project** tab **Share** button.
- To display cache files and highlight missing cache files, in the project tree, click the **Dependency Analysis** node.
- To identify out-of-date targets, use the **Simulink Project** tab **Share** button.

If you do not use a Simulink project, save the cache files in a location that is accessible to the people who are sharing the files. Alternatively, you can attach the cache files to an email.

If you send an out-of-date cache file to someone, when that person simulates the model, Simulink detects that it needs to perform a build.

## Related Examples

- “Simulate Model Referencing Models” on page 8-31

- “Model Referencing Simulation Targets” on page 8-46

# Simulink Model Referencing Requirements

**In this section...**

“About Model Referencing Requirements” on page 8-59

“Name Length Requirement” on page 8-59

“Configuration Parameter Requirements” on page 8-59

“Model Structure Requirements” on page 8-63

## About Model Referencing Requirements

A model reference hierarchy must satisfy various Simulink requirements, as described in this section. Some limitations also apply, as described in “Model Referencing Limitations” on page 8-100.

### Name Length Requirement

The name of a referenced model must contain fewer than 60 characters, exclusive of the .slx or .mdl suffix. An error occurs if the name of a referenced model is too long.

### Configuration Parameter Requirements

A referenced model uses a configuration set in the same way that any other model does, as described in “Manage a Configuration Set” on page 13-11. By default, every model in a hierarchy has its own configuration set. Each model uses its configuration set the same way that it would if the model executed independently.

Because each model can have its own configuration set, configuration parameter values can be different in different models. Furthermore, some parameter values are intrinsically incompatible with model referencing. The Simulink response to an inconsistent or unusable configuration parameter depends on the parameter:

- Where an inconsistency has no significance, or a trivial resolution exists that carries no risk, Simulink ignores or resolves the inconsistency without posting a warning.
- Where a nontrivial and possibly acceptable solution exists, Simulink resolves the conflict silently, resolves it with a warning, or generates an error. See “Diagnostic Configuration Parameter Changes” on page 8-104 for details.

- Where no acceptable resolution is possible, Simulink generates an error. Change some or all parameter values to eliminate the problem.

Manually eliminating all configuration parameter incompatibilities can be tedious when:

- A model reference hierarchy contains many referenced models that have incompatible parameter values
- A changed parameter value must propagate to many referenced models

You can control or eliminate such overhead by using configuration references to assign an externally stored configuration set to multiple models. See “Manage a Configuration Reference” on page 13-18 for details.

---

**Note:** Configuration parameters on the **Code Generation** pane of the Configuration Parameters dialog box do not affect simulation in either normal or accelerator mode. **Code Generation** parameters affect only code generation by Simulink Coder itself. Accelerated mode simulation requires code generation to create a simulation target. Simulink uses default values for all **Code Generation** parameters when generating the target, and restores the original parameter values after code generation is complete.

---

The tables in the following sections list Configuration parameter options that can cause problems if set:

- In certain ways, as indicated in the table
- Differently in a referenced model than in a parent model

Where possible, Simulink resolves violations of these requirements automatically, but most cases require changes to the parameters in some or all models.

### **Configuration Parameters Changed During Accelerated Simulation and Code Generation**

During model referencing simulation in accelerator and rapid accelerator mode, Simulink temporarily sets several **Configuration Parameters > Diagnostics > Data Validity** parameter settings to **None**, if they are set to **Warning** or **Error**. You can use the Model Advisor to check for parameters that change. For details, see “Certain Diagnostic Configuration Parameters Ignored for Models Referenced in Accelerator Mode” on page 8-106.

If the **Configuration Parameters > Code Generation > Symbols** parameters hold identifier information about the name of a referenced model and do not use a\$R token,

code generation prepends the \$R token to the name of the model. You can use the Model Advisor to check for changed model names. See “Configuration Parameters Changed During Code Generation” on page 8-107.

### Configuration Requirements for All Referenced Model Simulation

Dialog Box Pane	Option	Requirement
Solver	Start time	The start time of the top model and all referenced models must be the same, but need not be zero.
	Stop time	Simulink uses <b>Stop time</b> of the top model for simulation, overriding any differing <b>Stop time</b> in a referenced model.
	Type Solver	The <b>Type</b> and <b>Solver</b> of the top model apply throughout the hierarchy. See “Solver Requirements” on page 8-62.
Data Import/Export	Initial state	Can be <b>on</b> for the top model, but must be <b>off</b> for a referenced model.
Optimization	Default parameter behavior	If the parent model has this set to <b>Inlined</b> , then the referenced model cannot have this set to <b>Tunable</b> .
	Application lifespan (days)	For code generation, must be the same for parent and referenced models. For simulation, the setting can be different for the parent and referenced models.
Model Referencing	Total number of instances allowed per top model	Must not be <b>Zero</b> in a referenced model. Specifying

Dialog Box Pane	Option	Requirement
		One rather than Multiple is preferable or required in some cases. See “Model Instance Requirements” on page 8-62.

### Solver Requirements

Model referencing works with both fixed-step and variable-step solvers. All models in a model reference hierarchy use the same solver, which is always the solver specified by the top model. An error occurs if the solver type specified by the top model is incompatible with the solver type specified by any referenced model.

Top Model Solver Type	referenced model Solver Type	Compatibility
Fixed Step	Fixed Step	Allowed
Variable Step	Variable Step	Allowed
Variable Step	Fixed-step	Allowed unless the referenced model is multi-rate and specifies both a discrete sample time and a continuous sample time
Fixed Step	Variable Step	Error

If an incompatibility exists between the top model solver and any referenced model solver, one or both models must change to use compatible solvers. For information about solvers, see “Solvers” on page 3-21 and “About Solvers” on page 23-7.

### Model Instance Requirements

A referenced model must specify that it is available to be referenced, and whether it can be referenced at most once or can have multiple instances. The **Configuration Parameters > Model Referencing > Total number of instances allowed per top model** parameter provides this specification. See “Total number of instances allowed per top model” for more information. The possible values for this parameter are:

- **Zero** — A model cannot reference this model. An error occurs if a reference to the model occurs in another model.



- **One** — A model reference hierarchy can reference the model at most once. An error occurs if more than one instance of the model exists. This value is sometimes preferable or required.
- **Multiple** — A model hierarchy can reference the model more than once, if it contains no constructs that preclude multiple reference. An error occurs if the model cannot be multiply referenced, even if only one reference exists.

Setting **Total number of instances allowed per top model** to **Multiple** for a model that is referenced only once can reduce execution efficiency slightly. However, this setting does not affect data values that result from simulation or from executing code Simulink Coder generates. Specifying **Multiple** when only one model instance exists avoids having to change or rebuild the model when reusing the model:

- In the same hierarchy
- Multiple times in a different hierarchy

Some model properties and constructs require setting **Total number of instances allowed per top model** to **One**. For details, see “General Reusability Limitations” on page 8-101 and “Accelerator Mode Reusability Limitations” on page 8-104.

## Model Structure Requirements

The following requirements relate to the structure of a model reference hierarchy.

### Signal Propagation Requirements

The signal name must explicitly appear on any signal line connected to an Output block of a referenced model. A signal connected to an unlabeled line of an Output block of a referenced model cannot propagate out of the Model block to the parent model.

### Bus Usage Requirements

For bus signals that cross model reference boundaries, use the same bus object to specify the properties of the bus in both the parent and the referenced model. For details, see “Bus Data Crossing Model Reference Boundaries” on page 63-142.

### Sample Time Requirements

The first nonvirtual block connected to a root-level Inport or Output block of a referenced model must have the same sample time as the port to which it connects. Use

Rate Transition blocks to match input and output sample times, as illustrated in the following diagram.

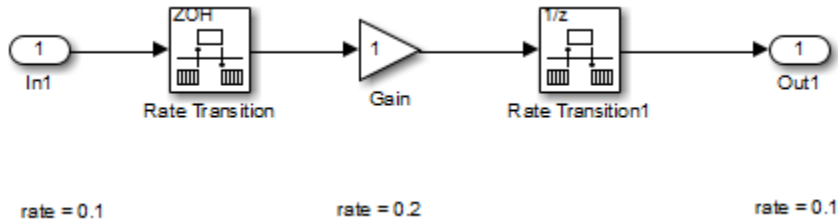

### Related Examples

- “Bus Data Crossing Model Reference Boundaries” on page 63-142

### More About

- “Model Referencing Limitations” on page 8-100
- “Componentization Guidelines” on page 15-29

## Parameterize Instances of a Reusable Referenced Model

When you use model referencing to break a large system into components, each component is a separate model. You can reuse a component by referring to it with multiple Model blocks. Each Model block is an instance of the component. You can then configure a block parameter (such as the **Gain** parameter of a Gain block) to use either the same value or a different value for each instance of the component. To use different values, create and use a model argument to set the value of the block parameter.

For information about setting block parameter values in reusable components, see “Parameter Interfaces for Reusable Components” on page 35-20.

### Specify Different Value for Each Instance of Reusable Model

For a block parameter in a reusable referenced model, to specify a different value for each instance of the model:

- 1 Create a MATLAB variable or `Simulink.Parameter` object in the model workspace of the referenced model.

Use a MATLAB variable for ease of maintenance. Use a `Simulink.Parameter` object for greater control over the minimum and maximum value, the data type, and other properties of the model argument.

- 2 Set the block parameter value in the model by using the variable or parameter object. Optionally, use the same variable or object to set other block parameter values.

When you simulate this model directly, the block parameters use the value that the variable or object stores in the model workspace. Otherwise, including when you simulate a parent model, the value in the model workspace has no significance.

- 3 Configure the variable or object as a model argument. In the Model Explorer **Model Hierarchy** pane, select the node that corresponds to the referenced model workspace. In the **Contents** pane (the middle pane), for the variable or object, select the check box in the **Argument** column.
- 4 In each Model block that refers to the reusable model, specify an instance-specific value for the model argument. To set the value, you can use the common techniques for setting block parameter values (see “Set Block Parameter Values” on page 35-2).

## Combine Multiple Arguments into a Structure

When you configure a model to use multiple model arguments, consider using a structure instead of separate variables in the model workspace. This technique reduces the effort of maintenance when you want to add, rename, or delete arguments. Instead of manually synchronizing the arguments in the model workspace with the argument values in Model blocks, you modify structures by using the Variable Editor or the command prompt.

If you have Simulink Coder, this technique can also reduce the ROM consumed by the formal parameters of the referenced model functions, such as the output (`step`) function.

For basic information about creating and using structures to set block parameter values, see “Organize Related Block Parameter Definitions in Structures” on page 35-22.

## Parameterize a Referenced Model

This example shows how to configure multiple instances of a referenced model to use different values for the same block parameter.

For an example that involves code generation, see “Specify Instance-Specific Parameter Values for Reusable Referenced Model” (Simulink Coder).

### Configure Referenced Model to Use Model Arguments

Create the model `ex_model_arg_ref`. This model represents a reusable algorithm.

```
open_system('ex_model_arg_ref')
```

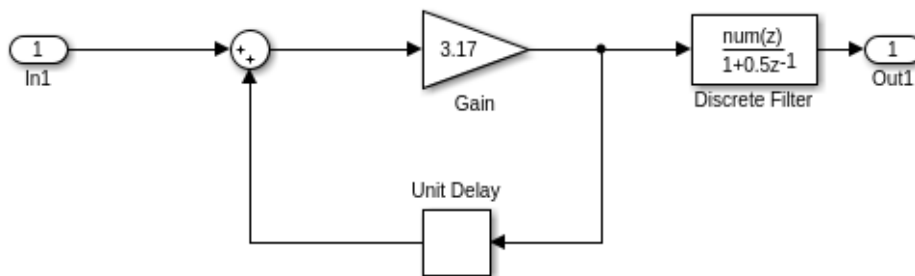

In the Model Explorer **Model Hierarchy** pane, expand the node `ex_model_arg_ref` and select **Model Workspace**.

Select **Add > Simulink Parameter** twice. Two `Simulink.Parameter` objects appear in the **Contents** pane.

Rename the objects as `gainArg` and `coeffArg`.

Set the **Value** property of the objects. For example, set them to `3.17` and `1.05`, respectively.

```
modelWorkspace = get_param('ex_model_arg_ref','ModelWorkspace');
assignin(modelWorkspace,'gainArg',Simulink.Parameter(3.17));
assignin(modelWorkspace,'coeffArg',Simulink.Parameter(1.05));
```

In the **Contents** pane, for `gainArg` and `coeffArg`, select the check box in the **Argument** column.

```
set_param('ex_model_arg_ref','ParameterArgumentNames','coeffArg,gainArg')
```

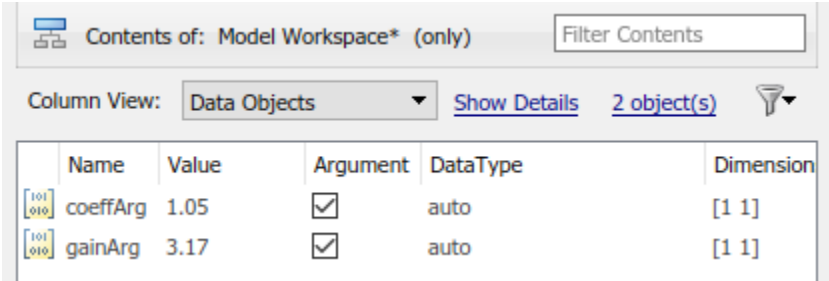

The screenshot shows the 'Contents of: Model Workspace\* (only)' pane. It displays a table with the following data:

	Name	Value	Argument	DataType	Dimension
<input type="checkbox"/>	coeffArg	1.05	<input checked="" type="checkbox"/>	auto	[1 1]
<input type="checkbox"/>	gainArg	3.17	<input checked="" type="checkbox"/>	auto	[1 1]

In the `ex_model_arg_ref` model, in the Gain block dialog box, set **Gain** to `gainArg`.

```
set_param('ex_model_arg_ref/Gain','Gain','gainArg')
```

In the Discrete Filter block dialog box, set **Numerator** to `coeffArg`.

```
set_param('ex_model_arg_ref/Discrete Filter','Numerator','coeffArg')
```

Save the `ex_model_arg_ref` model.

When you simulate the `ex_model_arg_ref` model by itself, the parameter objects in the model workspace use the values that you specified in the **Value** property. The block parameters also use these values.

### Set Model Argument Values in Parent Model

Create the model `ex_model_arg`. This model represents a system model that uses multiple instances of the reusable algorithm.

```
open_system('ex_model_arg')
```

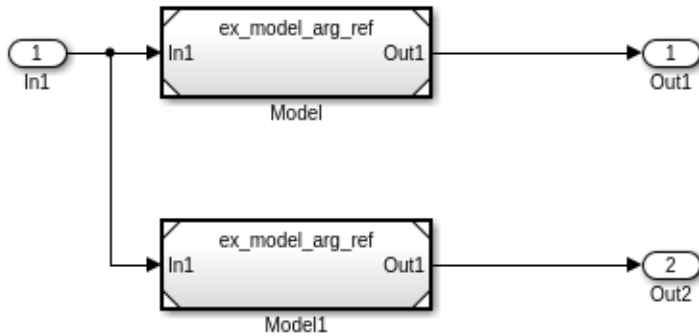

Right-click the upper Model block and select **Block Parameters**.

Under **Model arguments**, set **coeffArg** and **gainArg** to literal numeric values. For example, use 0.98 and 2.98.

```
set_param('ex_model_arg/Model1','ParameterArgumentValues',...
    struct('coeffArg','0.98','gainArg','2.98'))
```

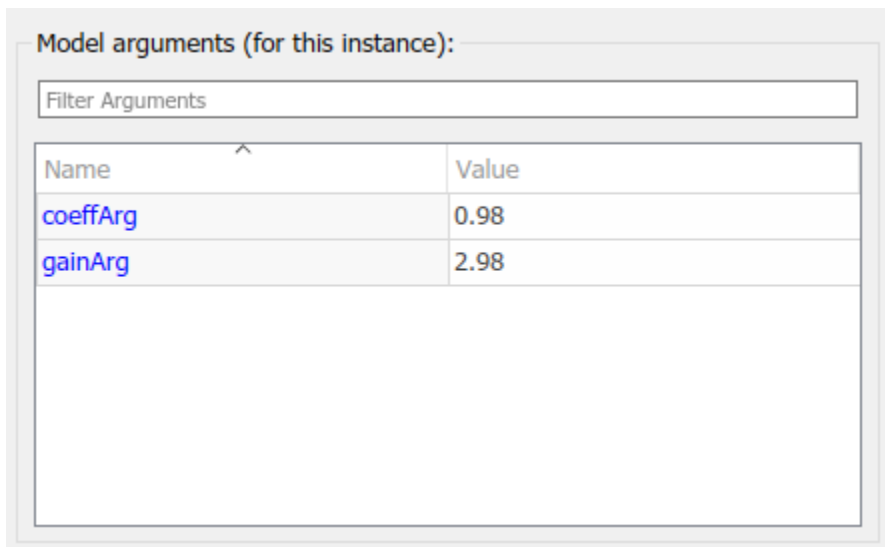

In the other Model block dialog box, set **coeffArg** and **gainArg** to two different numbers, for example 1.11 and 3.34.

```
set_param('ex_model_arg/Model1', 'ParameterArgumentValues', ...
    struct('coeffArg', '1.11', 'gainArg', '3.34'))
```

When you simulate the **ex\_model\_arg** model, each instance of **ex\_model\_arg\_ref** (each Model block) passes the argument values that you specified to the parameter objects in the **ex\_model\_arg\_ref** model workspace. For example, in the upper instance of **ex\_model\_arg\_ref**, the parameter object **gainArg** uses the value 2.98.

### Group Multiple Model Arguments into Single Structure

At the command prompt, create a structure. Add one field for each of the parameter objects in the **ex\_model\_arg\_ref** workspace.

```
structForInst1.gain = 3.17;
structForInst1.coeff = 1.05;
```

Store the structure in a **Simulink.Parameter** object.

```
structForInst1 = Simulink.Parameter(structForInst1);
```

Use the Model Explorer to copy the parameter object into the **ex\_model\_arg\_ref** model workspace.

In the model workspace, rename **structForInst1** as **structArg**.

```
assignin(modelWorkspace, 'structArg', copy(structForInst1));
```

In the **Contents** pane, configure **structArg** as the only model argument.

```
set_param('ex_model_arg_ref', 'ParameterArgumentNames', 'structArg')
```

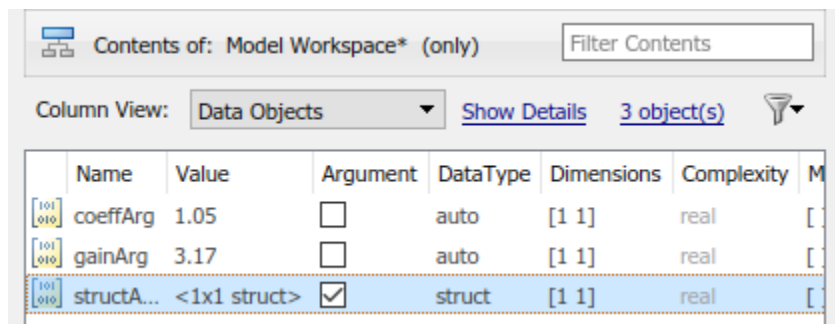

In the `ex_model_arg_ref` model, set the **Gain** parameter of the Gain block to `structArg.gain`.

```
set_param('ex_model_arg_ref/Gain', 'Gain', 'structArg.gain')
```

In the Discrete Filter block dialog box, set **Numerator** to `structArg.coeff`.

```
set_param('ex_model_arg_ref/Discrete Filter', ...  
          'Numerator', 'structArg.coeff')
```

Save the `ex_model_arg_ref` model.

At the command prompt, copy the existing structure as `structForInst2`.

```
structForInst2 = copy(structForInst1);
```

Set the field values in the two structures by using the same numbers that you used to set the model argument values in the Model blocks.

```
structForInst1.Value.gain = 2.98;  
structForInst1.Value.coeff = 0.98;
```

```
structForInst2.Value.gain = 3.34;  
structForInst2.Value.coeff = 1.11;
```

In the upper Model block dialog box, set **structArg** to `structForInst1`.

```
set_param('ex_model_arg/Model', 'ParameterArgumentValues', ...  
          struct('structArg', 'structForInst1'))
```



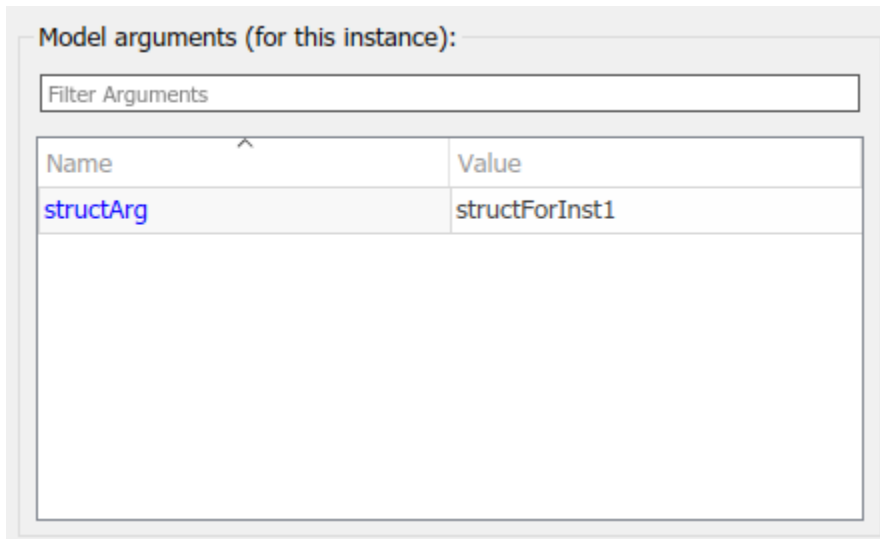

In the other Model block dialog box, set **structArg** to **structForInst2**.

```
set_param('ex_model_arg/Model1', 'ParameterArgumentValues', ...
    struct('structArg', 'structForInst1'))
```

With the structures, the mathematical functionality of the models is the same.

### Use Bus Object as Data Type of Structures

Optionally, use a `Simulink.Bus` object as the data type of the structures.

Use the function `Simulink.Bus.createObject` to create the bus object. The hierarchy of elements in the object matches the hierarchy of the structure fields. The default name of the object is `s1Bus1`.

```
Simulink.Bus.createObject(structForInst1.Value);
```

Rename the bus object by copying it.

```
myParamStructType = copy(s1Bus1);
```

Set the data type of the parameter objects in the base workspace by using the bus object.

```
structForInst1.DataType = 'Bus: myParamStructType';
```

```
structForInst2.DataType = 'Bus: myParamStructType';
```

Use the Model Explorer to view the contents of the `ex_model_arg_ref` model workspace.

For the parameter object `structArg`, set `DataType` to `Bus: myParamStructType`.

```
temp = getVariable(modelWorkspace, 'structArg');
temp = copy(temp);
temp.DataType = 'Bus: myParamStructType';
assignin(modelWorkspace, 'structArg', copy(temp));
```

	Name	Value	Argument	DataType	Dimension
<input type="checkbox"/>	coeffArg	1.05	<input type="checkbox"/>	auto	[1 1]
<input type="checkbox"/>	gainArg	3.17	<input type="checkbox"/>	auto	[1 1]
<input checked="" type="checkbox"/>	structA...	<1x1 struct>	<input checked="" type="checkbox"/>	Bus: myParamStructType	[1 1]

## Rename Model Argument

To rename a model argument in the context of the referenced model:

- Find all Model blocks that refer to the model and save the argument values that each block specifies. Use the `get_param` function to query the `ParameterArgumentValues` parameter of each block, which is a structure with a field that corresponds to the argument that you want to rename.

You must save the argument values because the renaming operation discards the values in the Model blocks.

- In the Model Explorer, right-click the variable or object in the model workspace of the referenced model and select **Rename All**. The renaming operation changes the name of the variable or object and changes references to it throughout the model. For more information, see “Manage Variables from Block Parameters” on page 35-47.
- Reapply the argument values to the Model blocks by using the new name of the argument. See “Programmatically Change Specific Argument Value in a Model Block” on page 8-73.

## Programmatically Change Specific Argument Value in a Model Block

To programmatically set argument values in a Model block, you set the value of the programmatic block parameter `ParameterArgumentValues` by using a structure. To modify an argument value or values that you already set, consider setting `ParameterArgumentValues` by using a partial structure, which has fields that correspond only to the arguments whose values you want to set.

In the example “Parameterize a Referenced Model” on page 8-66, for the model `ex_model_arg_ref`, you define two model arguments named `coeffArg` and `gainArg`. In a Model block that refers to `ex_model_arg_ref`, you set values for both arguments by using `ParameterArgumentValues`. Later, to change the value of `coeffArg` from 0.98 to 1.15 for that Model block, you can use a partial structure that targets only `coeffArg`:

```
set_param('ex_model_arg/Model', 'ParameterArgumentValues', struct('coeffArg', '1.15'))
```

The other argument, `gainArg`, retains its value.

## Customize User Interface for Reusable Component

When you design a reusable referenced model for use by other members of a team, you can apply a mask to the entire referenced model. You can then customize the way that your users interact with Model blocks, including setting model argument values

Using this technique also makes it easier to programmatically specify argument values. If you create and use a mask parameter named `gainMask`, to programmatically set the argument value to 0.98 for an instance of the block named `myModelBlock`, your users can use this command at the command prompt:

```
set_param('myModelBlock', 'gainMask', '0.98')
```

If you do not mask the block, to set the argument value, your users must locate the value in the table of argument values in the Model block.

For information about masking models, see “Introduction to Model Mask” on page 37-63.

## Specify Argument Values for a Model Variants Block

When you refer to a model through a Model Variants block instead of a regular Model block, you must specify argument values by using a different technique. See “Model Arguments for Model Variants Blocks” on page 8-78.

## Configure Instance-Specific Data for Lookup Tables

When you use `Simulink.LookupTable` objects to store and configure lookup table data for ASAP2 or AUTOSAR code generation (for example, `STD_AXIS` or `CURVE`), you can configure the objects as model arguments. You can then specify unique table data and breakpoint data for each instance of a component.

- 1 In the referenced model workspace, create `Simulink.LookupTable` objects. In lookup table blocks that are in the model, use the objects to set the table and breakpoint data.
- 2 Configure the objects as model arguments by using the **Argument** check box in the Model Explorer.
- 3 Create `Simulink.LookupTable` objects to store the instance-specific data. For example, if you configure a single `Simulink.LookupTable` object in the referenced model workspace as a model argument, to store instance-specific data for two instances of the referenced model (Model blocks in the parent model), create two `Simulink.LookupTable` objects in the base workspace.
- 4 Configure all of the `Simulink.LookupTable` objects to use the same structure type name. In the property dialog box, under **Struct Type definition**, set **Name** to the same value.
- 5 Use the instance-specific objects to set argument values in Model blocks. For example, in each Model block, use one of the instance-specific `Simulink.LookupTable` objects from the base workspace.

You cannot use `Simulink.Breakpoint` objects or `Simulink.LookupTable` objects that refer to `Simulink.Breakpoint` objects as model arguments.

### Create Example Models

Create the example model `ex_arg_LUT_ref`, which represents a reusable algorithm.

```
open_system('ex_arg_LUT_ref')
```

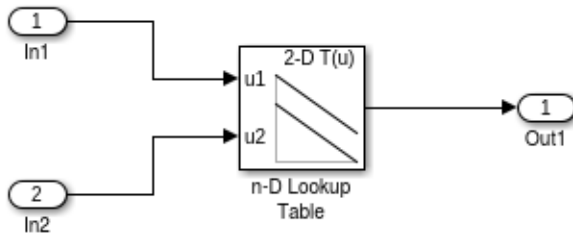

Create the example model `ex_arg_LUT`, which uses the reusable algorithm twice.

```
open_system('ex_arg_LUT')
```

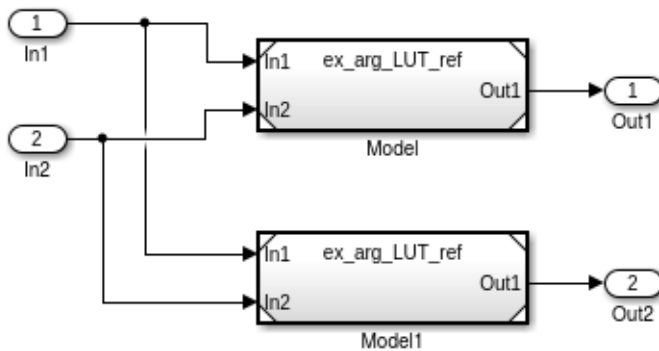

### Configure Model Arguments in Referenced Model

Use the Model Explorer to create a `Simulink.LookupTable` object in the referenced model workspace (`ex_arg_LUT_ref`). Name the object `LUT_arg`.

In the Dialog pane (the right pane) of the Model Explorer, set **Number of table dimensions** to 2. Under **Table** and **Breakpoints**, specify values for the table and breakpoint data. When you simulate or generate code directly from `ex_arg_LUT_ref`, the model uses these values.

Under **Struct Type definition**, set **Name** to `LUT_arg_Type`.

Click **Apply**.

In the **Contents** pane, for `LUT_arg`, select the check box in the **Argument** column.

In the referenced model, in the n-D Lookup Table block, set **Data specification** to `Lookup table object`. Set **Name** to `LUT_arg`.

Save the referenced model.

At the command prompt, you can use these commands to create and configure the object.

```
temp = Simulink.LookupTable;
temp.Table.Value = [3 4; 1 2];
temp.Breakpoints(1).Value = [1 2];
temp.Breakpoints(2).Value = [3 4];
temp.StructTypeInfo.Name = 'LUT_arg_Type';
mdlwks = get_param('ex_arg_LUT_ref', 'ModelWorkspace');
assignin(mdlwks, 'LUT_arg', copy(temp))
set_param('ex_arg_LUT_ref', 'ParameterArgumentNames', 'LUT_arg')
set_param('ex_arg_LUT_ref/n-D Lookup Table', ...
    'DataSpecification', 'Lookup table object', 'LookupTableObject', 'LUT_arg')
save_system('ex_arg_LUT_ref')
```

### Create Instance-Specific Argument Values

At the command prompt, create two `Simulink.LookupTable` objects in the base workspace.

```
LUTForInst1 = Simulink.LookupTable;
LUTForInst2 = Simulink.LookupTable;
```

Specify breakpoint and table data for each object.

```
LUTForInst1.Table.Value = [8 7; 6 5];
LUTForInst1.Breakpoints(1).Value = [5 6];
LUTForInst1.Breakpoints(2).Value = [3 4];
```

```
LUTForInst2.Table.Value = [9 8; 7 7];
LUTForInst2.Breakpoints(1).Value = [3 4];
LUTForInst2.Breakpoints(2).Value = [5 6];
```

Specify a structure type name. Match this name with the name specified by the object in the referenced model workspace.

```
LUTForInst1.StructTypeInfo.Name = 'LUT_arg_Type';
LUTForInst2.StructTypeInfo.Name = 'LUT_arg_Type';
```

In the `ex_arg_LUT` model, in the top Model block, under **Model arguments**, set the value of `LUT_arg` to `LUTForInst1`.

In the bottom Model block, set **LUT\_arg** to LUTForInst2.

At the command prompt, you can use these commands to configure the Model blocks.

```
set_param('ex_arg_LUT/Model', 'ParameterArgumentValues', ...  
    struct('LUT_arg', 'LUTForInst1'))  
set_param('ex_arg_LUT/Model1', 'ParameterArgumentValues', ...  
    struct('LUT_arg', 'LUTForInst2'))
```

Each instance of `ex_arg_LUT_ref` uses the table and breakpoint data stored in one of the `Simulink.LookupTable` objects in the base workspace.

## See Also

[Simulink.Parameter](#) | [Simulink.LookupTable](#) | [Simulink.Breakpoint](#)

## Related Examples

- “Componentization Guidelines” on page 15-29
- “Organize Related Block Parameter Definitions in Structures” on page 35-22
- “Parameter Interfaces for Reusable Components” on page 35-20
- “Tune and Experiment with Block Parameter Values” on page 35-38
- “Specify Instance-Specific Parameter Values for Reusable Referenced Model” (Simulink Coder)

## Model Arguments for Model Variants Blocks

Model arguments let you parameterize references to the same model so that each instance of the model behaves differently. Without model arguments, a block parameter or variable in a referenced model has the same value in every instance of the model.

When you use a Model Variants block, you specify argument values by using a different technique than for Model blocks. In the Model Variants block, you specify a comma-separated list of argument values instead of using a table to specify the values.

However, if you mask the referenced model, you do not need to use a comma-separated list to specify the argument values. When you mask the referenced model, whether you refer to the model through Model blocks or Model Variants blocks, you specify argument values by using the same technique. For more information, see “Introduction to Model Mask” on page 37-63.

For basic information about model arguments, see “Parameterize Instances of a Reusable Referenced Model” on page 8-65.

### Configure Model Arguments in Referenced Model

Whether you use a Model Variants block or a Model block, you configure model arguments for the referenced model by using the same technique.

- 1 Open the `sldemo_mrv_nonlinear_controller` model.
- 2 Open the Model Explorer. In the Simulink Editor, select **View > Model Explorer > Model Explorer**.
- 3 In the Model Explorer **Model Hierarchy** pane, select the **Model Workspace** node for the model.

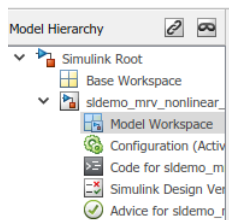

- 4 From Model Explorer **Add** menu, select **MATLAB Variable** twice.



Two new MATLAB variables appear in the **Contents** pane with a default name and value.

- 5 In the **Contents** pane change the name of the two variables. Change **Var** to **int\_value** and **Var1** to **incr**.
- 6 For each variable, select the check box in the **Argument** column.

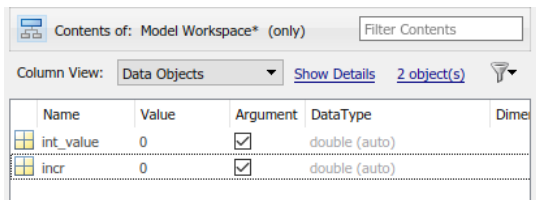

## Assign Model Argument Values

If a model declares model arguments, assign values to those arguments in each Model Variants block that references the model. Failing to assign a value to a model argument causes an error. The value of the model argument does *not* default to the value of the corresponding MATLAB variable. That value is available only to a standalone or top model.

- 1 Open the `sldemo_mdhref_variants` model.
- 2 Select the Model and open its block parameters dialog box.

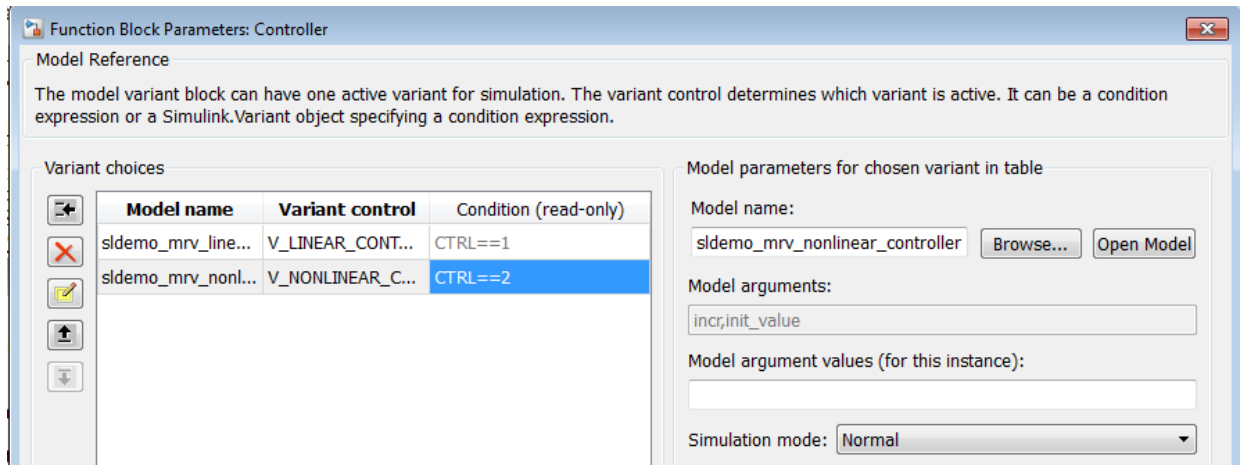

The **Model arguments** field displays the same MATLAB variables that you configured as model arguments in the referenced model. The Model Variants block field **Model arguments** is not editable. It indicates the model arguments that you need to assign values to, and the order of the arguments.

- 3 In the **Model argument values** field, enter a comma-delimited list of values for the model arguments that appear in the **Model arguments** field. Simulink assigns the values to arguments in positional order, so they must appear in the same order as the corresponding arguments.

You can enter literal values, variable names, MATLAB expressions, or `Simulink.Parameter` objects. Any symbols used resolve to values as described in “Symbol Resolution Process” on page 57-118. All values must be numeric (including objects with numeric values).

The value for each argument must have the same dimensions and complexity as the MATLAB variable that defines the model argument in the model workspace. The data types need not match. If necessary, the Simulink software casts a model argument value to the data type of the corresponding variable.

- 4 Click **OK** or **Apply** to confirm the values for the Model Variants block.

When the model executes in the context of that Model Variants block, the model arguments have the values specified in the **Model argument values** field of the Model Variants block.

## **See Also**

Model

## **Related Examples**

- “Parameterize Instances of a Reusable Referenced Model” on page 8-65
- “Set up Model Variants” on page 11-45

## Create and Reference Conditional Referenced Models

### In this section...

“Conditional Referenced Models” on page 8-82

“Create Conditional Models” on page 8-83

“Requirements for Conditional Models” on page 8-85

“Reference Conditional Models” on page 8-86

### Conditional Referenced Models

You can set up referenced models so that they execute conditionally, similar to conditional subsystems. For information about conditional subsystems, see “Conditional Subsystems” on page 10-2.

You can use these conditionally executed referenced models.

Conditional Referenced Model	Description
Enabled	<p>Use an Enable block to insert an enable port in a model. Add an enable port to a model if you want a referenced model to execute at each simulation step for which the control signal has a positive value.</p> <p>To see an example of an enabled <i>subsystem</i>, see <code>enablesub</code>. A corresponding enabled referenced model uses the same blocks as are in the enabled subsystem.</p>
Triggered	<p>Use a Trigger block to insert a trigger port in a model. To use an external signal to trigger the execution of a model, add a trigger port to the model. You can add a trigger port to a root-level model or to a subsystem.</p> <p>To view a model that illustrates how you can use trigger ports in referenced models, see the Introduction to Managing Data with Model Reference example. In that example, see the “Top Model: Scheduling Calls to the Referenced Model” section.</p>

Conditional Referenced Model	Description
Triggered and Enabled	A triggered and enabled model executes once at the time step for which a trigger event occurs, if the enable control signal has a positive value at that step.
Function-Call	<p>Simulink allows certain blocks to control execution of a referenced model during a time step, using a function-call signal. Examples of such blocks are a Function-Call Generator or an appropriately configured custom S-function. See “Function-Call Subsystems” on page 10-23 for more information.</p> <p>For an example of a function-call model, see the <code>sldemo_mdref_fncall</code> model.</p>

Each kind of conditionally executed model has some model creating requirements. For details, see “Requirements for Conditional Models” on page 8-85.

## Create Conditional Models

- 1 At the root level of the referenced model, insert one of the following blocks:

Kind of Model	Blocks to Insert
Enabled	Enable
Triggered	Trigger
Triggered and Enabled	Trigger and Enable
Function-Call	Trigger

For an enabled model, go on to Step 3.

- 2 For the Trigger block, set the **Trigger type** parameter, based on the kind of model:

Kind of Model	Trigger Type Parameter Setting
Triggered	One of the following:
Triggered and enabled	<ul style="list-style-type: none"> <li>• rising</li> <li>• falling</li> <li>• either</li> </ul>

Kind of Model	Trigger Type Parameter Setting
Function-Call	function-call

- 3 Create and connect other blocks to implement the model.

**Enabled** model example:

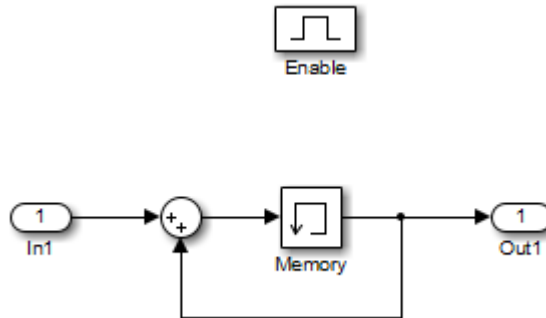

**Triggered** model example:

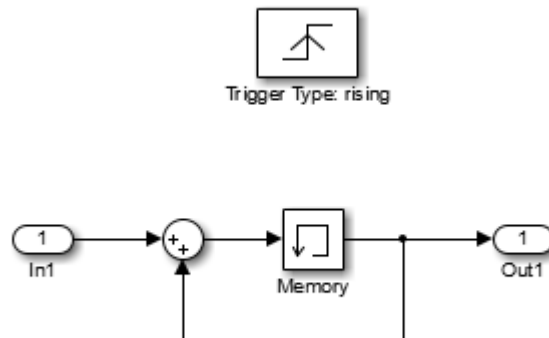

**Function-call** model example:

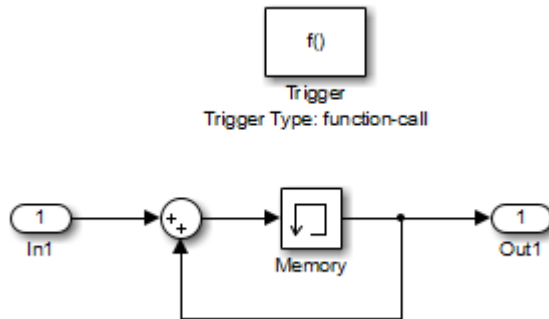

- 4 Ensure that the model satisfies the requirements for a conditional model. See the appropriate section:
- “Enabled Model Requirements” on page 8-85
  - “Triggered Model Requirements” on page 8-85
  - “Function-Call Model Requirements” on page 8-86

## Requirements for Conditional Models

Conditional models must meet the requirements for:

- Conditional subsystems (see “Conditionally Executed Subsystems”)
- Referenced models (see “Simulink Model Referencing Requirements” on page 8-59)

In addition, conditional models must meet the requirements described below.

### Enabled Model Requirements

- Multi-rate enabled models cannot use multi-tasking solvers. You must use single-tasking.
- For models with enable ports at the root, if the model uses a fixed-step solver, the fixed-step size of the model must not exceed the rate for any block in the model.
- The signal attributes of the enable port in the referenced model must be consistent with the input that the Model block provides to that enable port.

### Triggered Model Requirements

The signal attributes of the trigger port in the referenced model must be consistent with the input that the Model block provides to that trigger port.

### Function-Call Model Requirements

- A function-call model cannot have an output driven only by Ground blocks, including hidden Ground blocks inserted by Simulink. To meet this requirement, do the following:
  - 1 Insert a Signal Conversion block into the signal connected to the output.
  - 2 Enable the **Exclude this block from 'Block reduction' optimization** option of the inserted block.
- The referencing model must trigger the function-call model at the rate specified by the **Configuration Parameters > Solver 'Fixed-step size'** option if the function-call model meets both these conditions:
  - It specifies a fixed-step solver
  - It contains one or more blocks that use absolute or elapsed time

Otherwise, the referencing model can trigger the function-call model at any rate.

- A function-call model must not have direct internal connections between its root-level input and output ports. Simulink does not honor the **None** and **Warning** settings for the **Invalid root Inport/Output block connection** diagnostic for a referenced function-call model. It reports all invalid root port connections as errors.
- If the **Sample time type** is **periodic**, the sample-time period must not contain an offset.
- The signal connected to a function-call port of a Model block must be scalar.

### Reference Conditional Models

To create a reference to a conditional model:

- 1 Add a Model block to the model that you want to reference the triggered model. See “Create a Referenced Model” on page 8-9 for details.

The top of the Model block displays an icon that corresponds to the kind of port used in the referenced model. For example, for a triggered model, the top of the Model block displays the following icon.



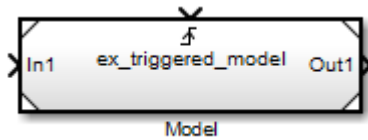

For enabled, triggered, and triggered and enabled models, go to Step 3.

- 2 For a function-call model, connect a Stateflow chart, Function-Call Generator block, or other function-call-generating block to the function-call port of the Model block. The signal connected to the port must be scalar.
- 3 Create and connect other blocks to implement the parent model.
- 4 Ensure that the referencing model satisfies the conditions for model referencing. See “Simulink Model Referencing Requirements” on page 8-59 and “Model Referencing Limitations” on page 8-100 for details.

## See Also

### Blocks

Enable | Function-Call Subsystem | Trigger

## More About

- “Simulate Conditional Referenced Models” on page 8-88
- “Conditional Subsystems” on page 10-2
- “Conditionally Executed Subsystems”
- Atomic Subsystems
- Triggered Subsystems on page 10-14
- Enabled Subsystems on page 10-4
- Triggered and Enabled Subsystems on page 10-19
- Function-Call Subsystem on page 10-23
- Export-Function Models on page 10-52

## Simulate Conditional Referenced Models

### In this section...

“Triggered, Enabled, and Triggered and Enabled Models” on page 8-88

“Function-Call Models” on page 8-88

You can run a standalone simulation of a conditional referenced model. A standalone simulation is useful for unit testing, because it provides consistent data across simulations in terms of data type, dimension, and sample time. Use normal, accelerator, or rapid accelerator mode to simulate a conditional model.

### Triggered, Enabled, and Triggered and Enabled Models

Triggered, enabled, and triggered and enabled models require an external input to drive the Trigger or Enable blocks. In the **Signal Attributes** pane of the Trigger or Enable block dialog box, specify values for the signal data type, dimension, and sample time.

To run a standalone simulation, specify the inputs using the **Configuration Parameters > Data Import/Export > Input** parameter. For details about how to specify the input, see “Comparison of Signal Loading Techniques” on page 59-124. The following conditions apply when you use the “Input” parameter for trigger and enable block inputs:

- Use the last data input for the trigger or enable input. For a triggered and enabled model, use the last data input for the trigger input.
- If you do not provide any input values, the simulation uses zero as the default values.

You can log data to determine which signal caused the model to run. For the Trigger or Enable block, in the **Main** pane of the Block Parameters dialog box, select **Show output port**.

### Function-Call Models

When you simulate a function-call model, it simulates as if the function-call block were driven by a function call at the fastest rate for the system. You can also configure the model to calculate output at specific times using a variable-step solver (see “Samples to Export for Variable-Step Solvers” on page 59-66).

## See Also

### Blocks

Enable | Function-Call Subsystem | Trigger

## More About

- “Create and Reference Conditional Referenced Models” on page 8-82
- “Conditional Subsystems” on page 10-2
- “Conditionally Executed Subsystems”
- Atomic Subsystems
- Triggered Subsystems on page 10-14
- Enabled Subsystems on page 10-4
- Triggered and Enabled Subsystems on page 10-19
- Function-Call Subsystem on page 10-23
- Export-Function Models on page 10-52

## Protected Model

A protected model provides the ability to deliver a model without revealing the intellectual property of the model. A protected model is a referenced model that hides all block and line information. It does not use encryption technology unless you use the optional password protection available for read-only view, simulation, and code generation. If you choose password protection for one of these options, the software protects the supporting files using AES-256 encryption. Creating a protected model requires a Simulink Coder license. A third party that receives a protected model must match the platform and the version of Simulink for which the protected model was generated.

Simulating a protected model requires that the protected model:

- Be available somewhere on the MATLAB path.
- Be referenced by a Model block in a model that executes in normal, accelerator, or rapid accelerator mode.
- Receives from the Model block the values needed by any defined model arguments.
- Connects via the Model block to input and output signals that match the input and output signals of the protected model.

To locate protected models in your model:

- The MATLAB Folder Browser shows a small image of a lock on the node for the protected model file.
- A Model block that references a protected model shows a small image of a shield in the lower left corner of the Model block.

---

**Note:** Protected models do not appear in the model hierarchy in the Model Explorer.

---

If you use a protected model for operations like viewing a Web view, simulation, or code generation, then the licenses used in the protected model will be checked out before those operations begin. The creator of the protected model can view the licenses of a protected model that will be checked out by looking at the protected model report. To open the report, right-click the protected-model badge icon and select **Display Report**. In the **Summary** of the report, the **Licenses** table lists the licenses required to use the protected model.

For more information, see “Use Protected Model in Simulation” on page 8-92. For more information about creating protected referenced models, see “Protect a Referenced Model” (Simulink Coder).

## **Related Examples**

- “Use Protected Model in Simulation” on page 8-92

## Use Protected Model in Simulation

When you receive a protected model, it might be included in a protected model package. The package could include additional files, such as a harness model and a MAT-file. A protected model file has an `.slxp` extension. A typical workflow for using a protected model in a simulation is:

- 1 If necessary, unpack the files according to any accompanying directions.
- 2 If there is a MAT-file containing workspace definitions, load that MAT-file.
- 3 If there is a harness model, copy the Model block referencing the protected model into your model.
- 4 If the protected model is password protected, then right-click the protected-model badge icon and select **Authorize**. Enter the required passwords, and then click **OK**.
- 5 If a protected model report was generated when the protected model was created, right-click the protected-model badge icon and select **Display Report** to open it. In the **Summary** of the report, check that your Simulink version and platform match the software and platform used to create the protected model.
- 6 Connect signals to the Model block that match its input and output port requirements.
- 7 Provide any needed model argument values. See “Parameterize a Referenced Model” on page 8-66.

There are also other ways to include the protected model into your model:

- Use your own Model block rather than the Model block in the harness model.

---

**Note:** When you change a Model block to reference a protected model, the **Simulation mode** of the block is set to **Accelerator**. You cannot change this mode. Furthermore, you cannot use the protected reference model block in **External mode**.

---

- Start with the harness model, add more constructs to it, and use it in your model.
- Use the protected model as a variant in a Model Variant block, as described in “Set up Model Variants” on page 11-45.
- Apply a mask to the Model block that references the protected model. See “Block Masks”.
- Configure a callback function, such as **LoadFcn**, to load the MAT-file automatically. See “Callbacks for Customized Model Behavior” on page 4-46.

Now you can simulate the model that includes the protected model. Because the protected model is set to accelerator mode, the simulation produces the same outputs that it did when used in accelerator mode in the source model.

## Protected Model Web View

The Web view is a read-only reference of the protected model. If the Web view functionality is enabled during creation, you can see this read-only view of a protected model. It is platform independent so you can view it on platforms other than the platform for which you created the protected model. To open the Web view of a protected model, use one of the following methods:

- Right-click the protected-model badge icon and select **Show Web view**.
- Use the `Simulink.ProtectedModel.open` function. For example, to display the Web view for protected model `sldemo_md1ref_counter`, you can call:

```
Simulink.ProtectedModel.open('sldemo_md1ref_counter', 'webview');
```

- Double-click the `.slxp` protected model file in the Current Folder browser.
- In the Block Parameter dialog box for the protected model, click **Open Model**.

Hover over a block in the model Web view to show the parameter values.

If the Web view is password protected, then right-click the protected-model badge icon and select **Authorize**. In the **Model view** box, enter the password, and then click **OK**.

## More About

- “Protected Model” on page 8-90

# Refresh Model Blocks

Refreshing a Model block updates its internal representation to reflect changes in the interface of the model that it references.

Examples of when to refresh a Model block include:

- Refresh a Model block that references model that has gained or lost a port.
- Refresh all the Model blocks that reference a model whose interface has changed.

You do not need to refresh a Model block if the changes to the interface of the referenced model do not affect how the referenced model interfaces to its parent.

To update a specific Model block, from the context menu of the Model block, select **Subsystem & Model Reference > Refresh Selected Model Block**.

To refresh all Model blocks in a model (as well as linked blocks in a library or model), in the Simulink Editor select **Diagram > Refresh Blocks**. You can also refresh a model by starting a simulation or generating code.

You can use Simulink diagnostics to detect changes in the interfaces of referenced models that could require refreshing the Model blocks that reference them. The diagnostics include:

- **Model block version mismatch**
- **Port and parameter mismatch**

## See Also

**Blocks**  
Model

## Related Examples

- “Create a Referenced Model” on page 8-9



## S-Functions with Referenced Models

In this section...
“S-Function Support for Model Referencing” on page 8-95
“Sample Times” on page 8-95
“S-Functions with Accelerator Mode Referenced Models” on page 8-96
“Using C S-Functions in Normal Mode Referenced Models” on page 8-96
“Protected Models” on page 8-97
“Simulink Coder Considerations” on page 8-97

### S-Function Support for Model Referencing

Each kind of S-function provides its own level of support for model referencing.

Type of S-Function	Support for Model Referencing
Level-1 MATLAB S-function	Not supported
Level-2 MATLAB S-function	<ul style="list-style-type: none"> <li>• Supports normal and accelerator mode</li> <li>• Accelerator mode requires a TLC file</li> </ul>
Handwritten C MEX S-function	<ul style="list-style-type: none"> <li>• Supports normal and accelerator mode</li> <li>• May be inlined with TLC file</li> </ul>
S-Function Builder	Supports normal and accelerator mode
Legacy Code Tool	Supports normal and accelerator mode

### Sample Times

Simulink software assumes that the output of an S-function does not depend on an inherited sample time unless the S-function explicitly declares a dependence on an inherited sample time.

You can control inheriting sample time by using `ssSetModelReferenceSampleTimeInheritanceRule` in different ways, depending on whether an S-function permits or precludes inheritance. For details, see “Inherited Sample Time for Referenced Models” (Simulink Coder).

## S-Functions with Accelerator Mode Referenced Models

For a referenced model that executes in accelerator mode, set the **Configuration Parameters > Model Referencing > Total number of instances allowed per top model** to **One** if the model contains an S-function that is either:

- Inlined, but has not set the `SS_OPTION_WORKS_WITH_CODE_REUSE` flag
- Not inlined

### Inlined S-Functions with Accelerator Mode Referenced Models

For accelerator mode referenced models, if the referenced model contains an S-function that should be inlined using a Target Language Compiler file, the S-function must use the `ssSetOptions` macro to set the `SS_OPTION_USE_TLC_WITH_ACCELERATOR` option in its `mdlInitializeSizes` method. The simulation target does not inline the S-function unless the S-function sets this option.

A referenced model cannot use noninlined S-functions in the following cases:

- The model uses a variable-step solver.
- Simulink Coder generated the S-function.
- The S-function supports use of fixed-point numbers as inputs, outputs, or parameters.
- The model is referenced more than once in the model reference hierarchy. To work around this limitation, use normal mode.
- The S-function uses character vector parameters.

## Using C S-Functions in Normal Mode Referenced Models

Under certain conditions, when a C S-function appears in a referenced model that executes in normal mode, successful execution is impossible. For details, see “S-Functions in Normal Mode Referenced Models”.

Use the `ssSetModelReferenceNormalModeSupport` SimStruct function to specify whether an S-function can be used in a normal mode referenced model.

You may need to modify S-functions that are used by a model so that the S-functions work with multiple instances of referenced models in normal mode. The S-functions must indicate explicitly that they support multiple `exec` instances. For details, see “Supporting the Use of Multiple Instances of Referenced Models That Are in Normal Mode”.

## Protected Models

A protected model cannot use noninlined S-functions directly or indirectly.

## Simulink Coder Considerations

A referenced model in accelerator mode cannot use S-functions generated by the Simulink Coder software.

Noninlined S-functions in referenced models are supported when generating Simulink Coder code.

The Simulink Coder S-function target does not support model referencing.

For general information about using Simulink Coder and model referencing, see “Referenced Models” (Simulink Coder).

## More About

- “S-Function Basics”
- “Simulink Model Referencing Requirements” on page 8-59
- “Model Referencing Limitations” on page 8-100

## Buses in Referenced Models

To have bus data cross model reference boundaries, use a bus object (`Simulink.Bus`) to define the bus.

For more information, see “Bus Data Crossing Model Reference Boundaries” on page 63-142. For an example of a model referencing model that uses buses, see `sldemo_mdref_bus`.

### More About

- “Bus Data Crossing Model Reference Boundaries” on page 63-142
- “Simulink Model Referencing Requirements” on page 8-59
- “Model Referencing Limitations” on page 8-100
- “Buses”

## Signal Logging in Referenced Models

In a referenced model, you can log any signal configured for signal logging. Use the Signal Logging Selector to select a subset or all of the signals configured for signal logging for a model reference hierarchy. For details, see “Models with Model Referencing: Overriding Signal Logging Settings” on page 59-96.

For additional information, see “Export Signal Data Using Signal Logging” on page 59-70.

### Related Examples

- “Models with Model Referencing: Overriding Signal Logging Settings” on page 59-96
- “Export Signal Data Using Signal Logging” on page 59-70

## Model Referencing Limitations

### In this section...

“Introduction” on page 8-100

“Limitations on All Model Referencing” on page 8-100

“Limitations on Normal Mode Referenced Models” on page 8-103

“Limitations on Accelerator Mode Referenced Models” on page 8-103

“Limitations on Rapid Accelerator Mode Referenced Models” on page 8-106

“Certain Diagnostic Configuration Parameters Ignored for Models Referenced in Accelerator Mode” on page 8-106

“Limitations on SIL and PIL Mode Referenced Models” on page 8-107

“Configuration Parameters Changed During Code Generation” on page 8-107

### Introduction

The following limitations apply to model referencing. In addition, a model reference hierarchy must satisfy all the requirements listed in “Simulink Model Referencing Requirements” on page 8-59.

### Limitations on All Model Referencing

#### Index Base Limitations

In two cases, Simulink does not propagate 0-based or 1-based indexing information to referenced-model root-level ports connected to blocks that:

- Accept indexes (such as the Assignment block)
- Produce indexes (such as the For Iterator block)

An example of a block that accepts indexes is the Assignment block. An example of a block that produces indexes is the For Iterator block.

The two cases result in a lack of propagation that can cause Simulink to fail to detect incompatible index connections. These two cases are:

- If a root-level input port of the referenced model connects to index inputs in the model that have different 0-based or 1-based indexing settings, Simulink does not set the 0-based or 1-based indexing property of the root-level Inport block.

- If a root-level output port of the referenced model connects to index outputs in the model that have different 0-based or 1-based indexing settings, Simulink does not set the 0-based or 1-based indexing property of the root-level Output block.

### General Reusability Limitations

If a referenced model has any of the following characteristics, the model must specify **Configuration Parameters > Model Referencing > Total number of instances allowed per top model** as **One**. No other instances of the model can exist in the hierarchy. An error occurs if you do not set the parameter correctly, or if more than one instance of the model exists in the hierarchy. The model characteristics that require that the **Total number of instances allowed per top model** setting be **One** are:

- The model contains any To File blocks
- The model references another model which is set to single instance
- The model contains a state or signal with non-auto storage class
- The model uses any of the following Stateflow constructs:
  - Stateflow graphical functions
  - Machine-parented data

### Block Mask Limitations

- Mask callbacks cannot add Model blocks. Also, mask callbacks cannot change the Model block name or simulation mode. These invalid callbacks generate an error.
- If a mask specifies the name of the model that a Model block references, the mask must provide the name of the referenced model directly. You cannot use a workspace variable to provide the name.
- The mask workspace of a Model block is not available to the model that the Mask block references. Any variable that the referenced model uses must resolve to either of these workspaces:
  - A workspace that the referenced model defines
  - The MATLAB base workspace

For information about creating and using block masks, see “Block Masks”.

### Simulink Tool Limitations

Working with the Simulink Debugger in a parent model, you can set breakpoints at Model block boundaries. Setting those breakpoints allows you to look at the input and

output values of the Model block. However, you cannot set a breakpoint inside the model that the Model block references. See “Simulink Debugger” for more information.

### Stateflow Limitations

You cannot reference a model multiple times in the same model reference hierarchy if that model that contains a Stateflow chart that:

- Contains exported graphical functions
- Is part of a Stateflow model that contains machine-parented data

### Subsystem Limitations

- You cannot place a Model block in an iterator subsystem, if the Model block references a model that contains Assignment blocks that are not in an iterator subsystem.
- In a configurable subsystem with a Model block, during model update, do not change the subsystem that the configurable subsystem selects.

### S-Function Target Limitation

The Simulink Coder S-function target does not support model referencing.

### Other Limitations

- Referenced models can only use asynchronous rates if the model meets *both* of these conditions:
  - An external source drives the asynchronous rate through a root-level Inport block.
  - The root-level Inport block outputs a function-call signal. See Asynchronous Task Specification.
- A referenced model can input or output only those user-defined data types that are fixed-point or that `Simulink.DataType` or `Simulink.Bus` objects define.
- To initialize the states of a model that references other models with states, specify the initial states in structure or structure with time format. For more information, see “State Information for Referenced Models” on page 59-265.
- A referenced model cannot directly access the signals in a multirate bus. To overcoming this limitation, see “Connect Multi-Rate Buses to Referenced Models” on page 63-142.
- A continuous sample time cannot be propagated to a Model block that is sample-time independent.
- Goto and From blocks cannot cross model reference boundaries.



- You cannot print a referenced model from a top model.
- To use a masked subsystem in a referenced model that uses model arguments, do not create in the mask workspace a variable that derives its value from a mask parameter. Instead, use blocks under the masked subsystem to perform the calculations for the mask workspace variable.
- An `InitFcn` callback in a top model cannot change parameters used by referenced models.

## Limitations on Normal Mode Referenced Models

### Normal Mode Visibility for Multiple Instances of a Referenced Model

You can simulate a model that has multiple instances of a referenced model that are in normal mode. All of the instances of the referenced model are part of the simulation. However, Simulink displays only one of the instances in a model window. The normal mode visibility setting determines which instance Simulink displays. Normal mode visibility includes the display of Scope blocks and data port values.

To set up your model to control which instance of a referenced model in normal mode has visibility and to ensure proper simulation of the model, see “Configure Models with Multiple Referenced Model Instances” on page 8-39.

### Simulink Profiler

In normal mode, enabling the Simulink Profiler on a parent model does not enable profiling for referenced models. You must enable profiling separately for each referenced model. See “How Profiler Captures Performance Data” on page 29-5.

## Limitations on Accelerator Mode Referenced Models

### Subsystem Limitations

If you generate code for an atomic subsystem as a reusable function, when you use accelerator mode, the inputs or outputs that connect the subsystem to a referenced model can affect code reuse. See “Reusable Code and Referenced Models” (Simulink Coder) for details.

### Simulink Tool Limitations

Simulink tools that require access to the internal data or the configuration of a model have no effect on referenced models executing in accelerator mode. Specifications made

and actions taken by such tools are ignored and effectively do not exist. Examples of tools that require access to model internal data or configuration include:

- Model Coverage
- Simulink Report Generator
- Simulink Debugger
- Simulink Profiler

### Runtime Checks

Some blocks include runtime checks that are disabled when you include the block in a referenced model in accelerator mode. Examples of these blocks include Assignment, Selector, and MATLAB Function blocks).

### Diagnostic Configuration Parameter Changes

For models referenced in accelerator mode, Simulink ignores certain runtime diagnostics that you set to a value other than `none` or `Disable all`. For details, see “Certain Diagnostic Configuration Parameters Ignored for Models Referenced in Accelerator Mode” on page 8-106.

### Data Logging and Visualization Limitations

These logging methods have limitations when specified for referenced models executing in accelerator mode.

- To Workspace blocks — Logs data only if you use `Timeseries` format
- Scope, Floating Scope, and Scope Viewer blocks — No data is displayed.
- Runtime display — Simulation data values, such as port values, do not display.

### Accelerator Mode Reusability Limitations

You must set **Configuration Parameters > Model Referencing > Total number of instances allowed per top model** to `One` for a referenced model that executes in accelerator mode and has any of the following characteristics:

- A subsystem that is marked as function
- An S-function that is:
  - Inlined but has not set the option `SS_OPTION_WORKS_WITH_CODE_REUSE`
  - Not inlined

- A function-call subsystem that:
  - Has been forced by Simulink to be a function
  - Is called by a wide signal

An error occurs in either of these cases:

- You do not set the parameter correctly.
- Another instances of the model exists in the hierarchy, in either normal mode or accelerator mode

### Customization Limitations

Simulation target code generation for referenced models in accelerator mode does not support data type replacement.

### S-Function Limitations

- If a referenced model in accelerator mode contains an S-function that should be inlined using a Target Language Compiler file, the S-function must use the `ssSetOptions` macro to set the `SS_OPTION_USE_TLC_WITH_ACCELERATOR` option in its `mdlInitializeSizes` method. The simulation target does not inline the S-function unless the S-function sets this option.
- You cannot use the Simulink Coder S-function target in a referenced model in accelerator mode.
- A referenced model in accelerator mode cannot use noninlined S-functions in the following cases:
  - The model uses a variable-step solver.
  - Simulink Coder generated the S-function.
  - The S-function supports use of fixed-point numbers as inputs, outputs, or parameters.
  - The S-function uses character vector parameters.
  - The model is referenced more than once in the model reference hierarchy. To work around this limitation:
    - 1 Make copies of the referenced model.
    - 2 Assign different names to the copies.
    - 3 Reference a different copy at each location that needs the model.

### **MATLAB Function Block Limitation**

A MATLAB Function block in a referenced model that executes in accelerator mode cannot call MATLAB functions.

### **Other Limitations**

- When you create a model, you cannot use that model as an accelerator mode referenced model until you have saved the model to disk. You can work around this limitation by setting the model to normal mode. See “Simulate Model Referencing Models” on page 8-31.
- When the `sim` command executes a referenced model in accelerator mode, the source workspace is always the MATLAB base workspace.
- Accelerator mode does not support the **External mode** option. If you enable the **External mode** option, accelerator mode ignores it.
- In accelerator mode, discrete states of model references are not exposed to linearization. These discrete states are not perturbed during linearization and therefore, they are not truly free in the trimming process.
- The outputs of random blocks are not kept constant during trimming. This can affect the optimization process.

### **Limitations on Rapid Accelerator Mode Referenced Models**

Simulink does not update a Model block with a sim viewing device.

### **Certain Diagnostic Configuration Parameters Ignored for Models Referenced in Accelerator Mode**

For models referenced in accelerator mode, Simulink ignores the values of these configuration parameter settings if you set them to a value other than `None`:

- **All Parameters > Array bounds exceeded** (`ArrayBoundsChecking`)
- **Diagnostics > Data Validity > Inf or NaN block output** (`SignalInfNanChecking`)
- **Diagnostics > Data Validity > Simulation range checking** (`SignalRangeChecking`)
- **Diagnostics > Data Validity > Division by singular matrix** (`CheckMatrixSingularityMsg`)

- **Diagnostics > Data Validity > Wrap on overflow** (IntegerOverflowMsg)

Also, for models referenced in accelerator mode, Simulink ignores these **Configuration Parameters > Diagnostics > Data Validity > Data Store Memory block** parameters if you set them to a value other than **Disable all**. For details, see “Data Store Diagnostics” on page 60-3.

- **Detect read before write** (ReadBeforeWriteMsg)
- **Detect write after read** (WriteAfterReadMsg)
- **Detect write after write** (WriteAfterWriteMsg)

You can use the Model Advisor to identify models referenced in accelerator mode for which Simulink ignores the configuration parameters listed above.

- 1 In the Simulink Editor, select **Analysis > Model Advisor**.
- 2 Select **By Task**.
- 3 Run the **Check diagnostic settings ignored during accelerated model reference simulation** check.

To see the results of running the identified diagnostics with settings to produce warnings or errors, simulate the model in normal mode. Inspect the diagnostic warnings and then simulate in accelerator mode.

## Limitations on SIL and PIL Mode Referenced Models

See:

- “Simulation Mode Override Behavior in Model Reference Hierarchy” (Embedded Coder)
- “SIL and PIL Limitations” (Embedded Coder)

## Configuration Parameters Changed During Code Generation

For referenced models, if these **Configuration Parameters > Code Generation > Symbols** parameters have settings that do not contain a \$R token (which represents the name of the reference model), code generation prepends the \$R token to the identifier format:

- **Global variables** (CustomSymbolStrGlobalVar)

- **Global types** (CustomSymbolStrType)
- **Subsystem methods** (CustomSymbolStrFcn)
- **Constant macros** (CustomSymbolStrMacro)

You can use the Model Advisor to identify models in a model referencing hierarchy for which code generation changes configuration parameter settings.

- 1** In the Simulink Editor, select **Analysis > Model Advisor**.
- 2** Select **By Task**.
- 3** Run the **Check code generation identifier formats used for model reference** check.

If a script that operates on generated code uses identifier formats that code generation changes, then update the script to use the updated identifier format (which includes an appended \$R token).

For more information about identifiers, see “Identifier Format Control” (Embedded Coder).

### More About

- “Simulink Model Referencing Requirements” on page 8-59
- “Componentization Guidelines” on page 15-29

# Simulink Units

---

## Unit Specification in Simulink Models

Simulink enables you to specify physical units as attributes on signals at the boundaries of model components. Such components can be:

- Subsystems
- Referenced Simulink models
- Simulink-PS Converter and PS-Simulink Converter blocks that interface between Simulink and components developed in Simscape and its associated physical modeling products
- Stateflow charts, state transition tables, or truth tables
- MATLAB Function blocks

By specifying, controlling, and visualizing signal units, you can ensure the consistency of calculations across the various components of your model. For example, this added degree of consistency checking is useful if you are integrating many separately developed components into a large, overall system model.

In Simulink models, you specify units from a *unit database*. The unit database comprises units from the following unit systems:

- **SI** — International System of Units
- **SI (extended)** — International System of Units (extended)
- **English** — English System of Units
- **CGS** — Centimetre-gram-second System of Units

Based on the type of system you are modeling, you can use any combination of units from these supported unit systems. For more information about supported unit systems and the units they contain, see [Allowed Units](#).

You can assign units to signals through these blocks:

- Inport
- Outport
- Signal Specification
- MATLAB Function



- Stateflow Chart

and these objects:

- Simulink.Signal
- Simulink.BusElement
- Simulink.Parameter

When you add a supported block to your model, the **Unit** parameter on the block is set to `inherit` by default. This setting means that the block inherits the unit from a connecting signal that has an explicitly specified unit.

You can explicitly specify units for signals using the **Unit** parameter of a supported block. For this parameter, the dialog box provides matching suggestions to help you:

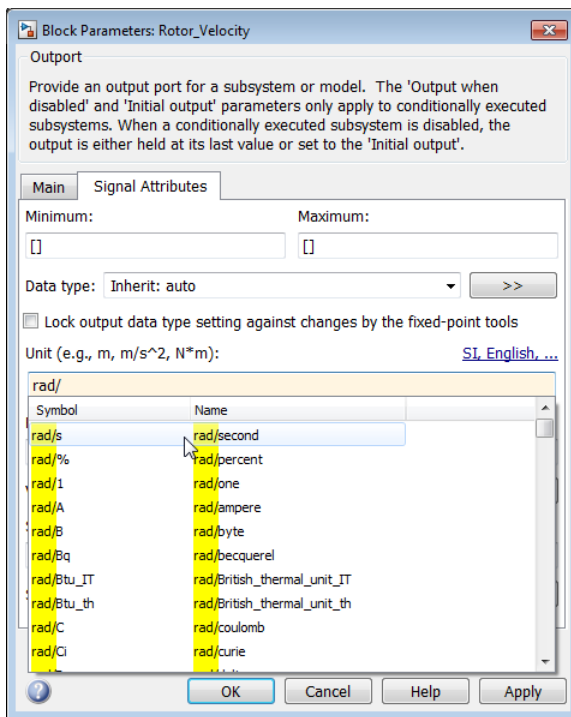

If you do not provide a correctly formed unit expression, you get an error. Correctly formed unit expressions are a combination of unit names or symbols with properly

balanced parentheses and `*`, `/`, and `^` characters. Special characters such as `[`, `]`, `{`, `}`, `<`, `>`, `\`, `"`, `&`, and so forth are not supported.

By default, a block port has an *empty* (that is, unspecified) unit and the **Unit** parameter is set to `inherit`. When you specify a unit for one port, Simulink checks the unit setting of any port connected to it. If a port has an empty unit, you can connect it to another port that has any supported unit. If a port unit parameter is set to `inherit`, it inherits the unit from a connected port that has a specified unit.

## Specify Physical Quantities

When you model a physical system, it is possible to use the same unit expression for two or more signals that represent different physical quantities. For example, a unit expression of `N*m` can represent either torque or energy. To prevent mistaken connection of two ports with the same unit but representing different physical quantities, you can add a physical quantity to the unit expression. For example, for the same unit of `N*m`, you can specify different physical quantities of `N*m@torque` and `N*m@energy`. Similar to units, the dialog box provides suggestions as you type the names of physical quantities.

Physical quantities help you to enforce an extra degree of unit consistency checking between connected ports. When you attempt to connect ports with different physical quantities, the model displays a warning.

## Specify Units in Objects

By default, `Simulink.Signal`, `Simulink.BusElement`, and `Simulink.Parameter` objects have empty units. In the case of a:

- `Simulink.Signal` object, the empty unit means that the corresponding signal can inherit a unit from an upstream or downstream port.
- `Simulink.BusElement` object, the empty unit means that the corresponding bus element signal also has an empty unit. You can connect the signal to a port with any unit, but the signal does not inherit a unit from the port.
- `Simulink.Parameter` object, the object does not attach a unit to the corresponding parameter value.

If you specify a unit in a `Simulink.Signal` or `Simulink.BusElement` object, Simulink applies the attribute to the corresponding signal line when:

- The `Simulink.Signal` object resolves to a signal in the model

- You use a bus element signal that is associated with a `Simulink.Bus` object with a Bus Creator, Bus Selector, or Bus Assignment block.

If you use either of these objects with a Data Store block, Simulink does not display any unit attribute.

For the `Simulink.Parameter` object, Simulink does not apply any attribute. For all objects, if the **Unit** parameter has a value that is not formed correctly, you see an error. If the unit is formed correctly but is undefined, you see a warning when you compile the model. If the unit expression contains special characters such as `[, ], {, }, <, >, \, ", &`, and so forth, Simulink replaces them with underscores (`_`).

### Custom Unit Properties

Notes on the `Unit` and `DocUnits` properties starting in R2016a:

- The `DocUnits` property is now `Unit` for `Simulink.Parameter` or `Simulink.Signal` objects. If, in a previous release, you used the `DocUnits` parameter of a `Simulink.Parameter` or `Simulink.Signal` object to contain text that does not now comply with units specifications, simulation returns a warning when the model simulates.

To suppress these warnings, set the configuration parameter “Units inconsistency messages” to `none`. This setting suppresses all units inconsistency check warnings.

- If you have a class that derives from `Simulink.Parameter`, `Simulink.Signal`, or `Simulink.BusElement` with a previously defined `Unit` property, Simulink returns an error like the following:

```
Cannot define property 'Unit' in class 'classname' because the property has already been defined in the superclass 'superclass'.
```

If you use this property to represent the physical unit of the signal, delete the `Unit` property from the derived class in the R2016a or later release. Existing scripts continue to work, unless you are assigning incorrectly formed unit expressions to the `Unit` field. In this case, replace the use of `Unit` with `DocUnits` to continue to be able to assign the unit expression.

---

**Note:** If you store existing data in a MAT- or `.sldd` file, in a release prior to R2016a, copy the contents of the `Unit` property to the `DocUnits` first. Then, save the file in the earlier release before loading the model in R2016a or later release.

---

## Specify Units for Temperature Signals

When modeling absolute temperature quantities, use units such as K, degC, degF, and degR. When modeling temperature *difference* quantities, use units such as deltaK, deltadegC, deltadegF, and deltadegR. If you connect a signal that has a temperature difference unit to a block that specifies an *absolute* temperature unit, Simulink detects the mismatch.

## Specify Units in MATLAB Function Blocks

You can specify units for input and output data of MATLAB Function blocks by using the **Unit** parameter on the Ports and Data Manager.

During model update, Simulink checks for inconsistencies in units between input or output data ports and the corresponding signals.

## Specify Units for Logging and Loading Signal Data

You can include units in signal data that you log or load.

You specify units for logging and loading using `Simulink.SimulationData.Unit` objects. When you log using `Dataset` or `Timeseries` format, Simulink stores the unit information using `Simulink.SimulationData.Unit` objects. If you create MATLAB timeseries data to load, you can specify `Simulink.SimulationData.Unit` object for the `Units` property of the `timeseries` object.

For details, see “Log Signal Data That Uses Units” on page 59-40 and “Load Signal Data That Uses Units” on page 59-237.

## Restricting Unit Systems

By default, you can specify units from any of the supported unit systems. However, in large modeling projects, to enforce consistency, you might want to restrict the unit systems that certain components of your model can use. To specify available unit systems for a model, in the configuration parameter **Allowed unit systems**, enter **all** or a comma-separated list containing one or more of **SI**, **SI (extended)**, **CGS**, and **English**. Do not use quotation marks. If your model contains referenced models, you can use the **Allowed unit systems** to restrict units in each of those referenced models. If your

model contains subsystems, you can use the Unit System Configuration block to restrict units in the subsystems. You can also optionally use a Unit System Configuration block in a model. In this case, the settings in the Unit System Configuration block override whatever you specify in **Allowed unit systems**.

To restrict unit systems in a model:

- 1 In the **Unit** parameter of the Inport, Outport, or Signal Specification block, click the link.



If a Unit System Configuration block exists in your model, this link opens the block dialog box. Otherwise, the link opens the **Allowed unit systems** configuration parameter.

- 2 Specify one or more the desired unit systems, **SI**, **SI (extended)**, **English**, or **CGS**, in a comma-delimited list, or **all**, without quotation marks.

In a parent-child relationship (for example, a top model with a referenced model or subsystem), you can specify different unit systems for each component. However, if a child propagates a unit into a parent that is not in the unit systems specified for the parent, you get a warning.

To check whether there are unit mismatches caused by restricted unit systems in your model hierarchy:

- Press **Ctrl+D** and visually inspect the model for warning badges.
- Use the Model Advisor check **Identify disallowed unit systems**.

## See Also

Simulink.Parameter | Inport | MATLAB Function | Outport | Signal Specification | Simulink.BusElement | Simulink.Signal | Unit Conversion | Unit System Configuration

## Related Examples

- “Update an Existing Model to Use Units” on page 9-18

## **More About**

- “Displaying Units” on page 9-9
- “Unit Consistency Checking and Propagation” on page 9-11
- “Converting Units” on page 9-16
- “Troubleshooting Units” on page 9-26

## Displaying Units

To display signal units in your model, select **Display > Signals & Ports > Port Units**. To select this option programmatically, use the command-line property `ShowPortUnits`.

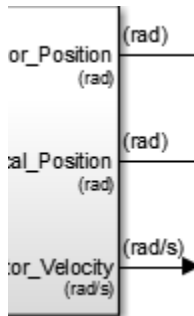

With this option selected, the model dynamically updates port and signal labels to show any changes that you make to units. You do not need to press **Ctrl+D** to update the model. When you simulate your model, the Scope block displays units for connected signals as *y*-axis labels.

---

**Note:** When you explicitly specify units on inport or outport blocks, block port labels and signal lines display those units. If a port is set to inherit units or has empty units, port labels and signal lines do not show labels.

---

---

**Note:** With the option to display units cleared, you do not see port and signal labels, even when you press **Ctrl+D** to update your model. However, you do see warning or error badges for any unit inconsistency problems that exist in the model.

---

You can also see units in the interface view of your model. Select **Display > Interface**.

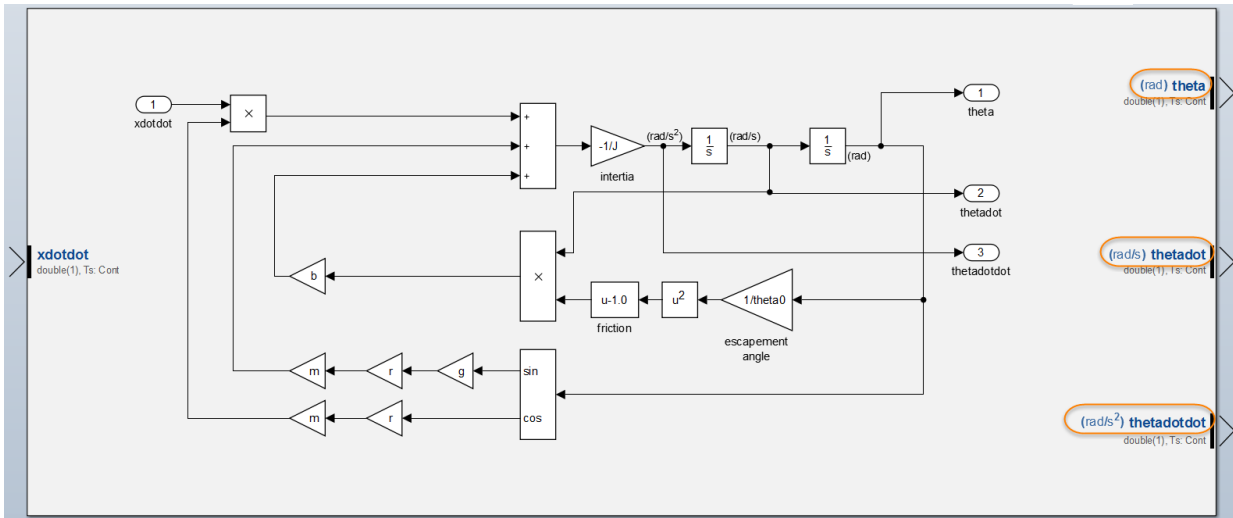

## See Also

Simulink.Parameter | Inport | MATLAB Function | Outport | Signal Specification | Simulink.BusElement | Simulink.Signal | Unit Conversion | Unit System Configuration

## Related Examples

- “Update an Existing Model to Use Units” on page 9-18

## More About

- “Unit Specification in Simulink Models” on page 9-2
- “Unit Consistency Checking and Propagation” on page 9-11
- “Converting Units” on page 9-16
- “Troubleshooting Units” on page 9-26



## Unit Consistency Checking and Propagation

Simulink performs unit consistency checking between components. Ports that you connect together — sometimes via intermediate blocks that propagate units — must have the same units. For example, you cannot connect a port with unit  $\text{ft/s}$  to a port with unit  $\text{m/s}^2$ .

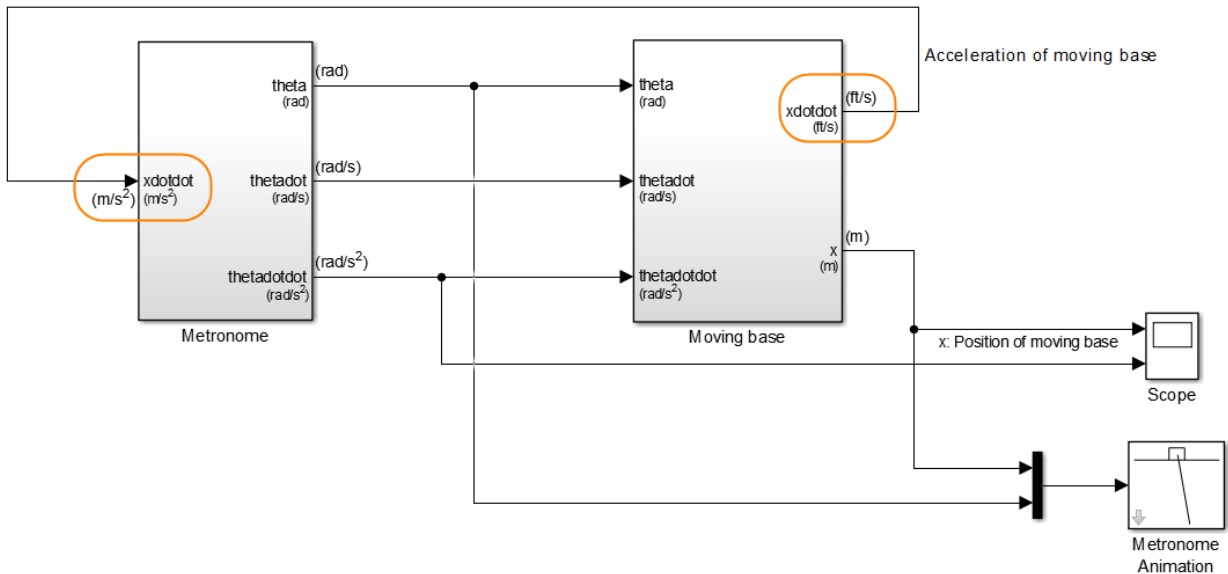

By default, Simulink shows the mismatch warning  when it detects a mismatch in units between two connected ports. You can press **Ctrl+D** to show mismatched units in your model.

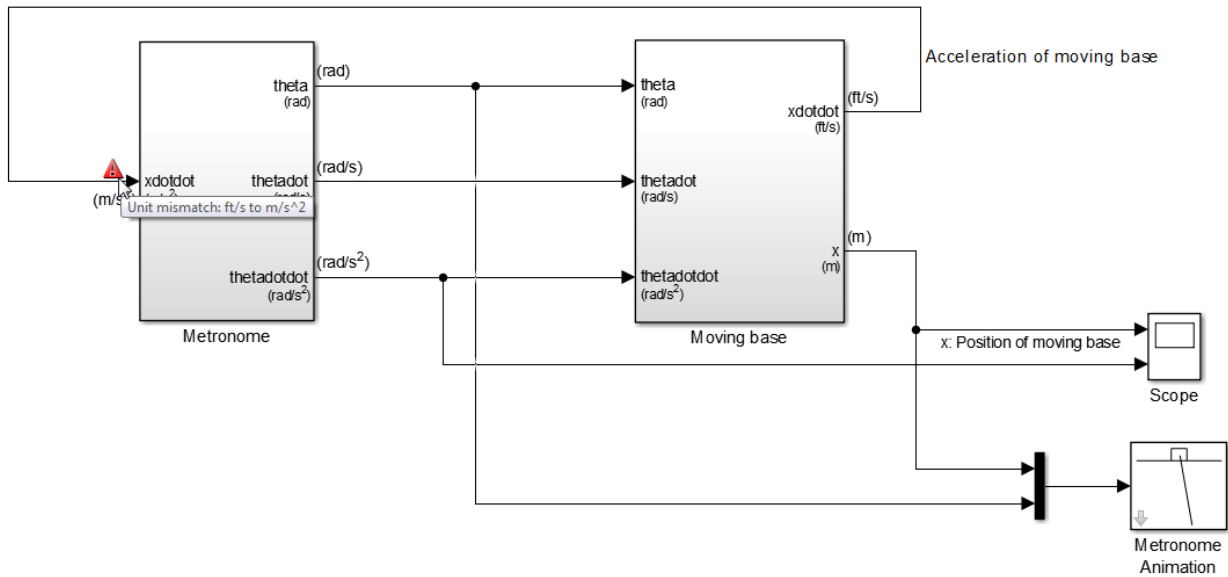

To make this connection valid, you can:

- Explicitly set both port units to the same unit.
- Set the **Unit** parameter of one of the connecting ports to `inherit`.
- Insert a Unit Conversion block between the mismatched units if they are separated by a scaling factor or offset, or if they are inverse units. These units are *convertible*. For more information, see “Converting Units” on page 9-16.
- Select the **Allow automatic unit conversions** configuration parameter. For more information, see “Converting Units” on page 9-16.

---

**Note:** Simulink supports variations on unit expressions. For example, one port can have a unit of  $m/s^2$  and a connected port can have a unit of  $m/s/s$ . In these cases, Simulink does not display a warning for mismatched units.

---

When Simulink detects one of these conditions, it displays the inconsistency warning :

- Disallowed unit system
- Undefined unit

Simulink checks the consistency of unit settings and propagates units across component boundaries. In a model that contains a referenced model, Simulink compiles the referenced model independently of the top model. This independent compilation means that the referenced model cannot inherit units from the top model.

If a port in a referenced model has **Unit** set to `inherit`, it can inherit a unit from any upstream or downstream block in the referenced model. If the port does not inherit a unit from an upstream or downstream block, you can connect it to a port in the top model with any unit.

Simulink passes units through the following blocks that do not change data, known as *noncomputation* blocks:

- Bus Creator
- Bus Selector
- Bus to Vector
- Data Type Conversion
- Demux
- From
- Goto
- Inport
- Merge
- Model
- Mux
- Outport
- Rate Transition
- Signal Conversion
- Signal Specification
- Subsystem
- Variant Sink
- Variant Source

---

**Note:** If you supply two or more signals with different units to a Mux block, Simulink applies empty units to the vector signal that the Mux block outputs. Vector signals must have a common unit.

---

---

**Note:** If you have a nonvirtual bus in your model (see “Virtual and Nonvirtual Buses” on page 63-4), Simulink sets the unit of the bus to empty. A nonvirtual bus cannot have a unit. However, if the bus element signals themselves have units, Simulink does not change these.

---

Simulink does not propagate units through blocks that produce new data as output. When signals with units pass through these blocks, the units of these signals become empty. Examples of blocks that do not preserve units because they produce new data as an output include:

- Sum
- Gain
- Filter
- Product

### Unit Propagation Between Simulink and Simscape

When modeling physical systems, you might want to integrate components developed in Simulink with components developed in Simscape and its associated physical modeling products. Simscape components use physical signals instead of regular Simulink signals. Therefore, you need Simulink-PS Converter and PS-Simulink Converter converter blocks to connect signals between Simulink and Simscape components.

To specify units for the input and output signals of your Simscape component, you can explicitly specify the units on the converter blocks. When you specify units on a PS-Simulink Converter block that converts a signal from Simscape to Simulink, Simulink propagates the unit settings to the connected Simulink port. However, Simulink cannot propagate a signal unit from Simulink into your Simscape component. To do that, you must explicitly specify the unit on the Simulink-PS Converter block. For more information, see “Physical Units” (Simscape) in the Simscape documentation.

### See Also

Simulink.Parameter | Inport | MATLAB Function | Outport | Signal Specification  
| Simulink.BusElement | Simulink.Signal | Unit Conversion | Unit System  
Configuration

### Related Examples

- “Update an Existing Model to Use Units” on page 9-18

## **More About**

- “Unit Specification in Simulink Models” on page 9-2
- “Displaying Units” on page 9-9
- “Converting Units” on page 9-16
- “Troubleshooting Units” on page 9-26



## Converting Units

Simulink can convert units between ports when it detects discrepancies that have known mathematical relationships such as:

- Scaling factors
- Conversion factors and offsets, such as F (Fahrenheit) to C (Celsius)
- Scaled, inverse units, such as mpg (miles per gallon) and L/km (liters per kilometer).

For example, if you connect one port with a unit of cm to one with a unit of mm, Simulink can automatically scale one unit to work with the other.

To enable Simulink to convert unit mismatches in your model automatically, select the **Allow automatic unit conversions** configuration parameter.

- When Simulink successfully converts signal units at a block port, it displays .
- When Simulink detects that an automatic conversion is not possible, it displays .

To manually convert units separated by a conversion factor or offset:

- 1 Clear the **Allow automatic unit conversions** configuration parameter.
- 2 Insert a Unit Conversion block between the ports whose units you want to convert.

---

**Tip:** Automatic conversion of units is a convenience. For better control of units, when Simulink detects a mismatch, consider modifying the units specified at one or the other of the two connected ports.

---

## Automatic Unit Conversion Limitations

Simulink does not support automatic conversion:

- At the boundaries of virtual subsystems. Virtual subsystems have the **Treat as atomic unit** parameter cleared. For more information, see “Nonvirtual and Virtual Blocks” on page 34-2.
- At the root level of models configured for concurrent execution or export-function models. For more information, see “Configure Your Model for Concurrent Execution” on page 14-24 and “Export-Function Models” on page 10-52.

- For fixed-point and integer signals.
- At an input port of a Merge block.
- At any port of an asynchronous Rate Transition block.
- At an input port of a function-call subsystem.
- For bus signals.

## See Also

[Simulink.Parameter](#) | [Inport](#) | [MATLAB Function](#) | [Outport](#) | [Signal Specification](#)  
| [Simulink.BusElement](#) | [Simulink.Signal](#) | [Unit Conversion](#) | [Unit System Configuration](#)

## Related Examples

- “Update an Existing Model to Use Units” on page 9-18

## More About

- “Unit Specification in Simulink Models” on page 9-2
- “Displaying Units” on page 9-9
- “Unit Consistency Checking and Propagation” on page 9-11
- “Troubleshooting Units” on page 9-26

## Update an Existing Model to Use Units

This example shows how to add units to an existing model. You see how to:

- Use an incremental workflow to add units to components in your model
- Integrate components that use different unit systems
- Specify units for individual elements of a bus object
- Troubleshoot unit mismatch problems

The model in the example is a fuel control system. The controller (Fuel Rate Controller) and plant (Engine Gas Dynamics) components of the model are nonvirtual subsystems. Nonvirtual subsystems have the **Treat as atomic unit** parameter selected. You introduce units to the plant before introducing units to the controller and connecting signals. You also specify units for the individual elements of a bus object in the model.

Open the `ex_units_fuelsys` example model.

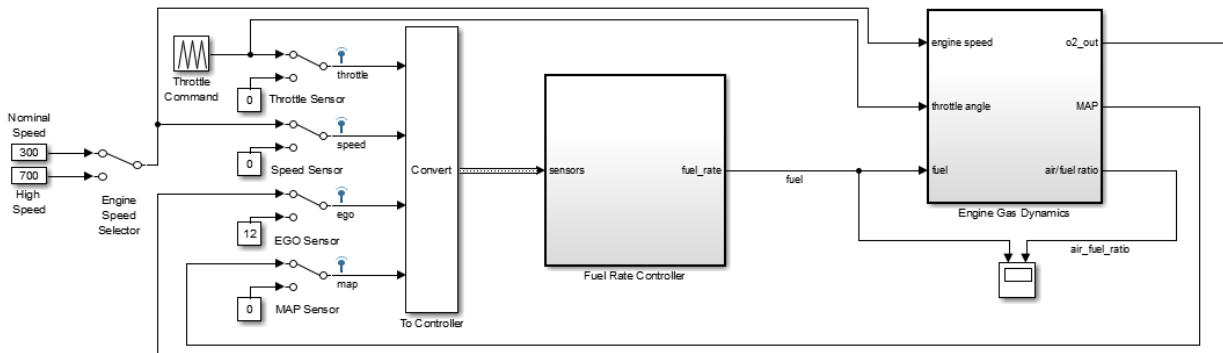

For the top model, the **Allowed unit systems** configuration parameter determines the unit systems the model can use. For each of the plant and controller subsystems, a Unit System Configuration block determines the allowed unit systems.

Component	Allowed Unit Systems
Top model	SI
Fuel Rate Controller subsystem (controller)	all
Engine Gas Dynamics subsystem (plant)	all



In the plant subsystem, on the **Signal Attributes** tab of each inport block dialog box, set the **Unit** parameter to a value appropriate for the connected physical signal.

Block	Physical Signal	Unit Parameter Setting
1	engine speed	rad/s (radians per second)
2	throttle angle	deg (degrees)
3	fuel rate	g/s (grams per second)

To display units on ports and signals in the model, select **Display > Signals & Ports > Port Units**.

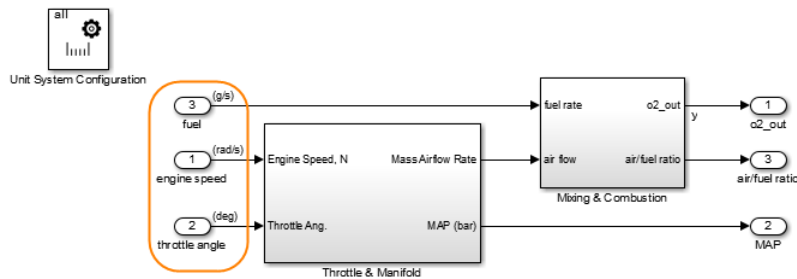

In the plant subsystem, you see units on the inport blocks and connected signals.

Navigate back to the top model. To compile the model, press **Ctrl+D**, which also performs unit consistency checking.

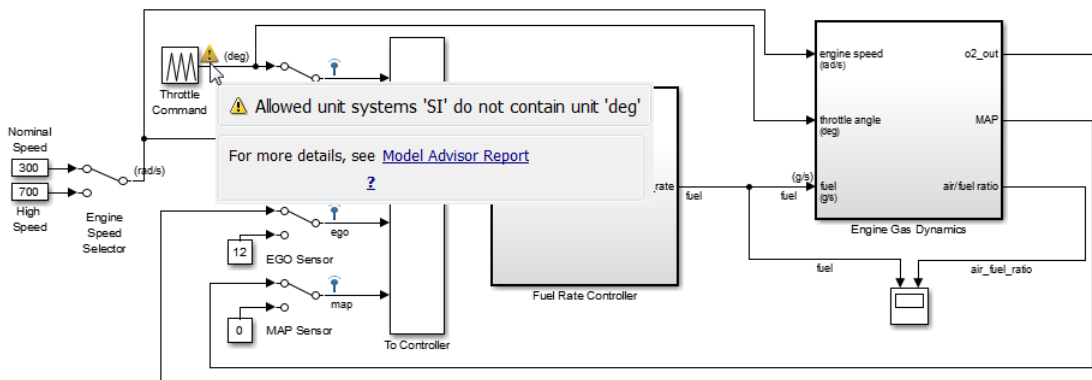

The model displays a warning to indicate that there is a disallowed unit for the throttle angle signal. Clicking the warning icon displays a link to a Model Advisor report that gives you more detail.

The model also displays the warning at the bottom of the model editing window.

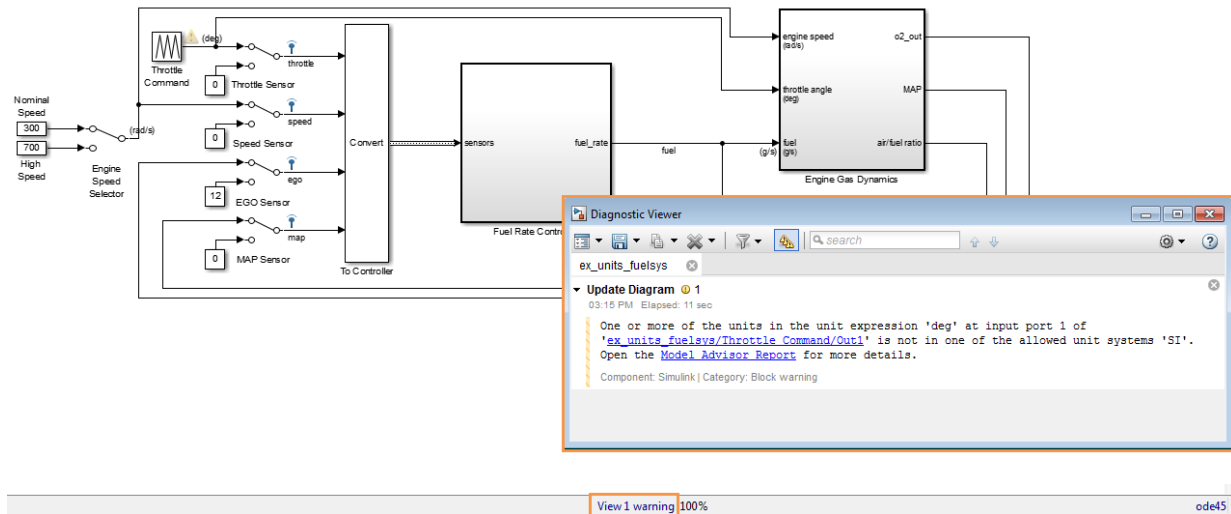

In the plant subsystem, you specified a unit of `deg` (degrees) for the throttle angle signal. However, the warning message indicates that degrees are not in the SI unit system. As determined by the **Allowed unit systems** configuration parameter, SI is the only unit system that the top model currently allows. To resolve this warning, you have two options:

- In the plant subsystem, specify a unit for the throttle angle signal that the SI unit system supports. For more information about supported unit systems and the units they contain, see Allowed Units.
- In the top model, change the **Allowed unit systems** configuration parameter to expand the set of allowed unit systems.

In this case, a unit of `deg` for the throttle angle signal is appropriate. Instead, to resolve the warning, expand the set of allowed unit systems for the top model. Set the **Allowed unit systems** configuration parameter of the top model to `all`. To recompile the model, press **Ctrl+D**.

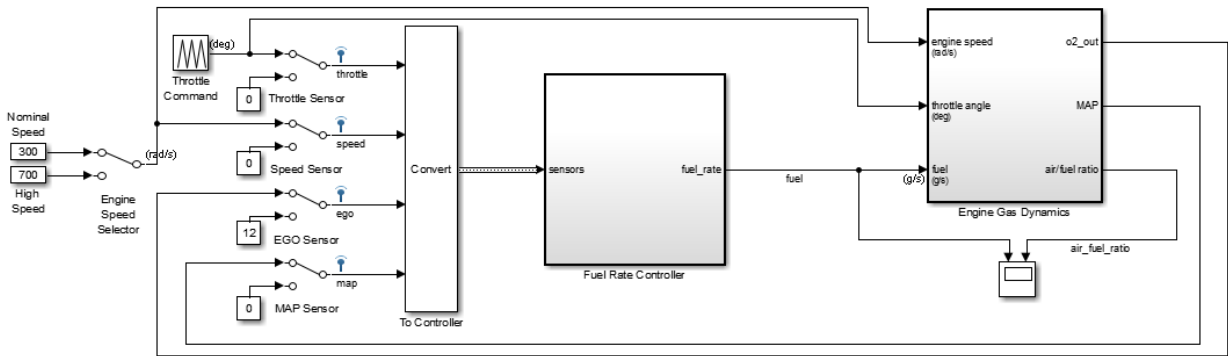

100%

The top model no longer displays warnings.

Now that you have introduced units to the plant and successfully resolved unit inconsistency problems, you can add units to the controller. In the Fuel Rate Controller subsystem, set the **Unit** parameter of the fuel\_rate outport block to kg/s (kilograms per second).

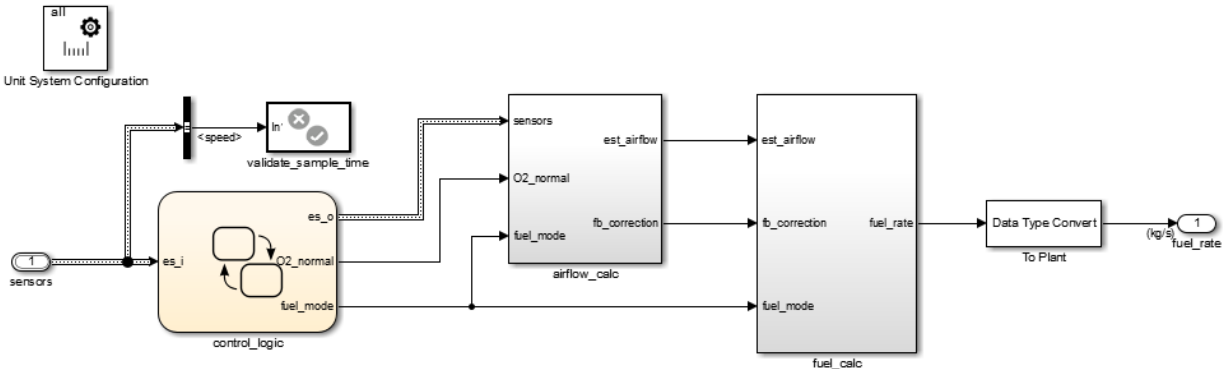

Navigate back to the top model. To recompile it, press **Ctrl+D**.

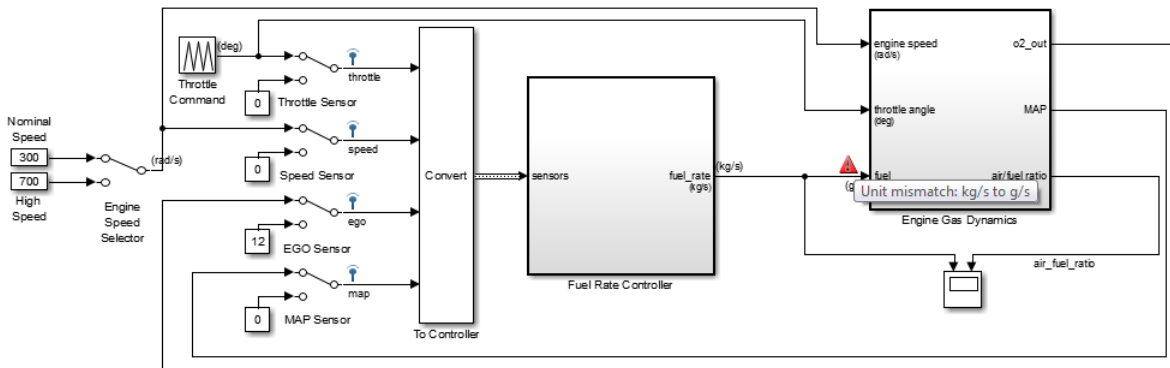

The top model now shows a warning for mismatched units between the controller and plant. To resolve this error, you can:

- Explicitly insert a Unit Conversion block between the two components.
- Select the **Allow automatic unit conversions** configuration parameter.

Both options convert units in the same way. A situation in which you might disallow automatic conversions and insert conversion blocks instead is when you are integrating many components in a large system model. In that case, manually inserting conversion blocks can give you an added degree of control of unit conversions in the model. Also, with a conversion block, you can control the data type of the converted signal. This is useful, for instance, when you are modeling for fixed-point precision.

In this case, to enable Simulink to resolve the unit mismatch automatically, select **Allow automatic unit conversions**. To recompile the model, press **Ctrl+D**.

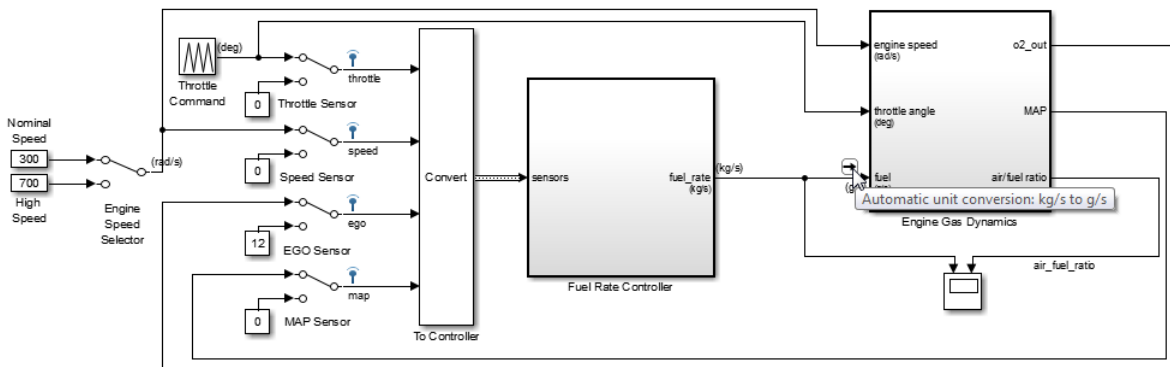

Simulink automatically converts units between the controller and the plant. An automatic conversion icon replaces the warning.

The top model includes a `EngSensors` bus object that passes various sensor signals as a composite signal to the controller. To use the Bus Editor to add units to individual elements of the bus object, select **Edit > Bus Editor**.

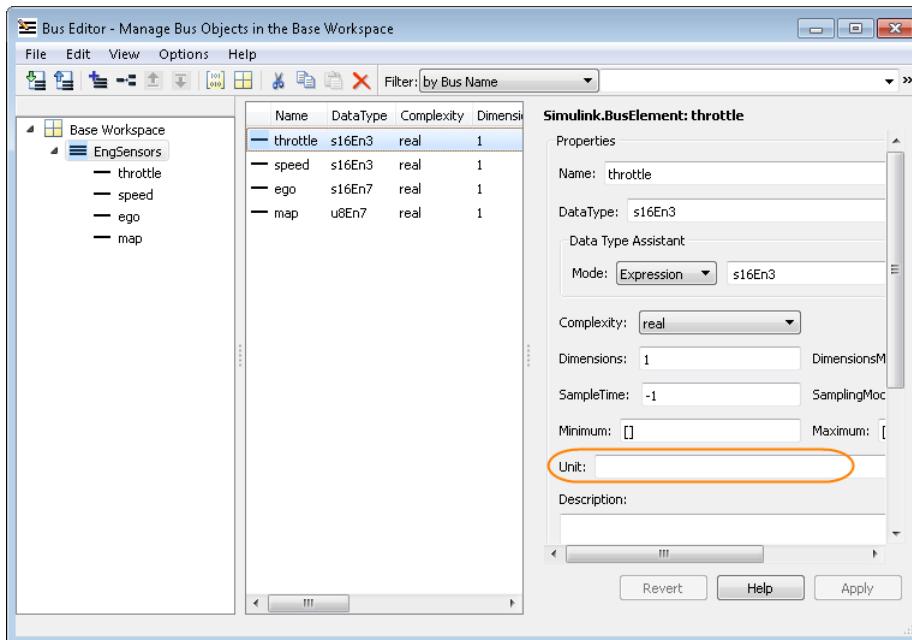

For the `EngSensors` bus object, set the **Unit** parameter of each element.

Signal	Unit Parameter Setting
throttle	deg (degrees)
speed	rad/s (radians per second)
ego	V (volts)
map	bar (bars)

To recompile the model, press **Ctrl+D**.

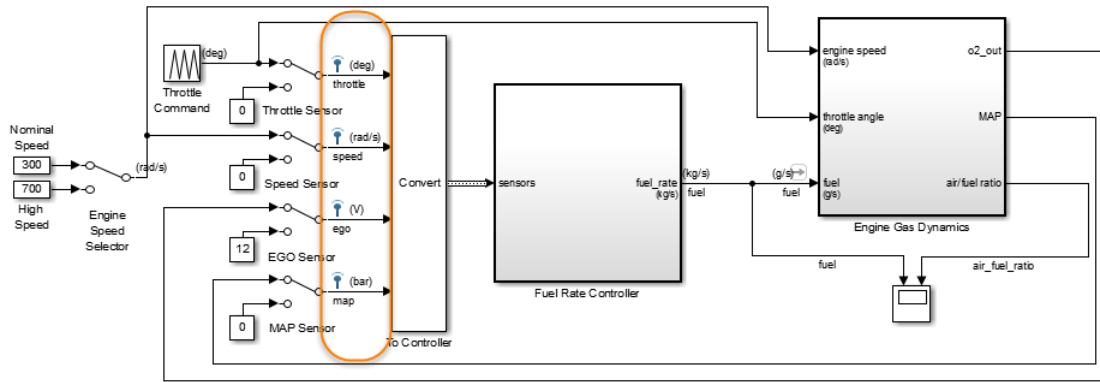

The model shows units on the individual elements of the bus object.

You can also see the units in the interface view of your model. Select **Display > Interface**.

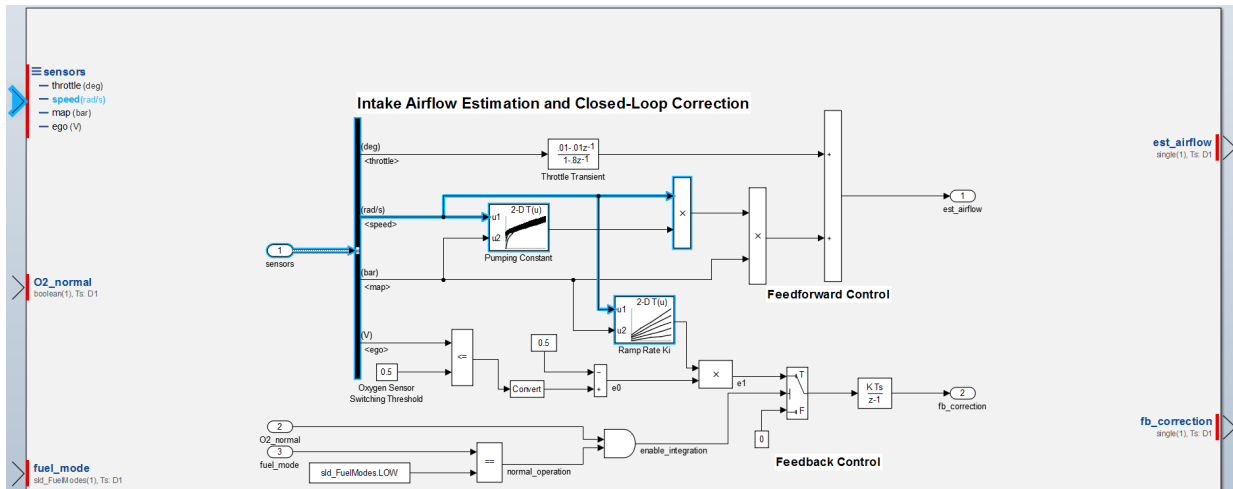

The `airflow_calc` block of the controller subsystem displays units on the individual elements of the bus object, both at the component interface and within the component.

After you introduce units incrementally and resolve inconsistency and mismatch issues, you can simulate the model.

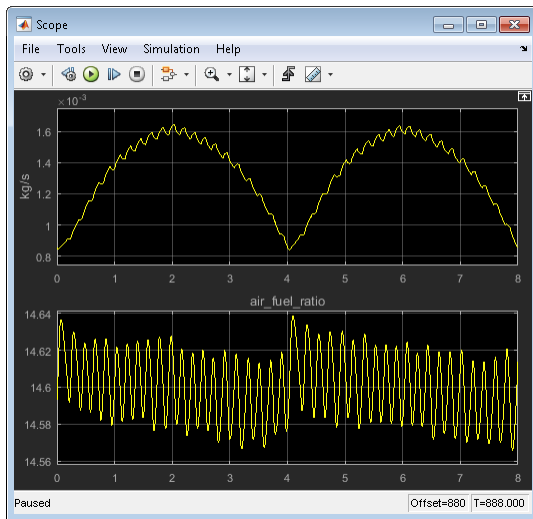

For the `fuel` signal that is connected to the scope, the plot window displays the associated units of `kg/s` as a *y*-axis label.

## See Also

[Inport](#) | [Outport](#) | [Unit Conversion](#) | [Unit System Configuration](#)

## More About

- “Unit Specification in Simulink Models” on page 9-2
- “Nonvirtual and Virtual Blocks” on page 34-2
- “Displaying Units” on page 9-9
- “Unit Consistency Checking and Propagation” on page 9-11
- “Converting Units” on page 9-16
- “Troubleshooting Units” on page 9-26

## Troubleshooting Units

### In this section...

“Undefined Units” on page 9-26

“Overflow and Underflow Errors or Warning” on page 9-26

“Mismatched Units Detected” on page 9-27

“Mismatched Units Detected While Loading” on page 9-27

“Disallowed Unit Systems” on page 9-27

“Automatic Unit Conversions” on page 9-27

“Unsuccessful Automatic Unit Conversions” on page 9-28

“Simscape Unit Specification Incompatible with Simulink” on page 9-28

To help you troubleshoot issues with unit settings, Simulink uses Model Advisor checks to generate a report useful for larger models.

By default, Simulink flags unit usage issues, such as mismatched units, with warnings. Warnings enable you to continue working despite mismatched units. You can reduce the number of warnings you see by setting the configuration parameter **Units inconsistency messages** to **none**.

### Undefined Units

Simulink does not support custom unit specifications. For more information about supported unit systems and the units they contain, see Allowed Units.

The Model Advisor check “Identify undefined units in the model” identifies undefined units.

### Overflow and Underflow Errors or Warning

You can get overflow and underflow errors or warnings when using the Unit Conversion block. If you get:

- Overflow messages, change the data type at the output port to one with a better range
- Underflow messages, change the data type at the output port to one with better precision



## Mismatched Units Detected

At the boundary of a component, Simulink detects if the units of two ports do not match. To see the tooltip, hover over the warning badge. If the unit is convertible, Simulink displays advice on fixing the issue.



The Model Advisor check “Identify unit mismatches in the model” identifies mismatched units.

## Mismatched Units Detected While Loading

At the boundary of a component, Simulink detects if the units of two ports do not match. To see the tooltip, hover the warning badge. When possible, Simulink displays advice on fixing the issue.



The Model Advisor check “Identify unit mismatches in the model” identifies mismatched units.

## Disallowed Unit Systems

Simulink supports only the unit systems listed in the tables of allowed units.

The Model Advisor check “Identify disallowed unit systems in the model” identifies unit systems that are not allowed in the configured units systems.

## Automatic Unit Conversions

If the **Allow automatic unit conversions** configuration parameter is set, Simulink supports the automatic conversion of units. Simulink flags automatically converted units with the  badge.

For a list of the automatic unit conversions, use the Model Advisor check “Identify automatic unit conversions in the model”.

### Unsuccessful Automatic Unit Conversions

If the **Allow automatic unit conversions** configuration parameter is set, Simulink supports the automatic conversion of units. If Simulink cannot perform the automatic unit conversion, Simulink returns a warning (). In such cases, consider manually specifying the unit.

---

**Tip:** Automatic unit conversion is a convenience. For better control of units, you can manually set the units for two connecting ports.

---

### Simscape Unit Specification Incompatible with Simulink

If these are true:

- You define a new unit to your unit registry by using the `pm_addunit` function.
- You use the new unit with the Simulink-PS Converter or PS-Simulink Converter block.
- Your new unit conflicts with an existing one in the Simulink database.

Simulink returns a warning about a potential incorrect calculation (.

### See Also

[Simulink.Parameter](#) | [Inport](#) | [MATLAB Function](#) | [Outport](#) | [Signal Specification](#) | [Simulink.BusElement](#) | [Simulink.Signal](#) | [Unit Conversion](#) | [Unit System Configuration](#)

### More About

- “Unit Specification in Simulink Models” on page 9-2
- “Displaying Units” on page 9-9
- “Unit Consistency Checking and Propagation” on page 9-11
- “Converting Units” on page 9-16
- “Troubleshooting Units” on page 9-26

# Conditional Subsystems

---

- “Conditional Subsystems” on page 10-2
- “Enabled Subsystems” on page 10-4
- “Triggered Subsystems” on page 10-14
- “Enabled and Triggered Subsystems” on page 10-19
- “Function-Call Subsystems” on page 10-23
- “Conditional Subsystem Initial Output Values” on page 10-27
- “Conditional Subsystem Output Values When Disabled” on page 10-29
- “Simplified Initialization Mode” on page 10-30
- “Classic Initialization Mode” on page 10-32
- “Convert from Classic to Simplified Initialization Mode” on page 10-50
- “Export-Function Models” on page 10-52
- “Resettable Subsystems” on page 10-72
- “Action Subsystem” on page 10-79
- “Simulink Functions” on page 10-82
- “Simulink Functions in Models” on page 10-93
- “Argument Specification for Simulink Functions” on page 10-111
- “Simulink Functions in Referenced Models” on page 10-116
- “Private Scoping of Simulink Functions” on page 10-125
- “Diagnostics Using a Client-Server Architecture” on page 10-130
- “Initialize, Reset, and Terminate Function Limitations” on page 10-136
- “Create Model to Initialize, Reset, and Terminate State” on page 10-139
- “Create Test Harness to Generate Function Calls” on page 10-155

## Conditional Subsystems

A *conditionally executed subsystem* is an atomic subsystem that allows you to control its execution with an external signal. The external signal, called the *control signal*, is attached to the *control input* port. Conditional subsystems are useful when you create complex models that contain components whose execution depends on other components.

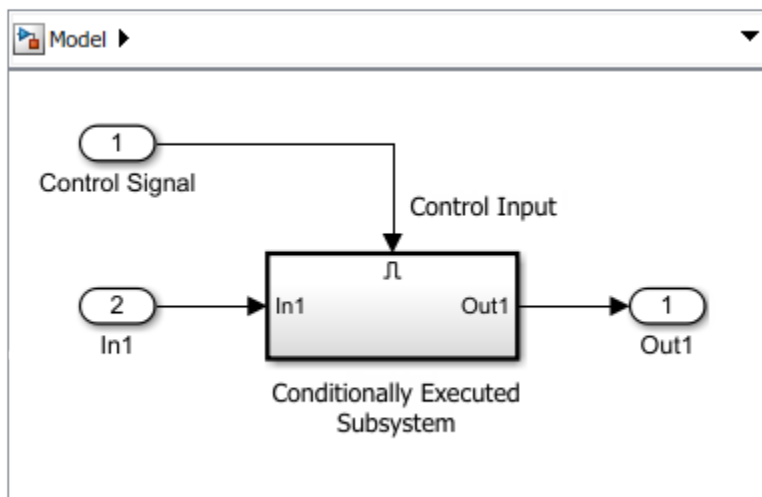

Simulink supports these types of conditional subsystems:

- **Enabled Subsystem** — Executes at each time step while the control signal is positive. Execution starts at the time step when the control signal crosses zero from the negative to the positive direction. See “Enabled Subsystems” on page 10-4.
- **Triggered Subsystem** — Executes each time a trigger event occurs. A trigger event can occur on the rising or falling edge of a continuous or discrete trigger signal. See “Triggered Subsystems” on page 10-14.
- **Enabled and Triggered Subsystem** — Executes once at the time step when a trigger event occurs and the enable control signal has a positive value. See “Enabled and Triggered Subsystems” on page 10-19.
- **Function-Call subsystem** — Executes each time a function-call event occurs. A Stateflow chart, Function-Call Generator block, or an S-function block can provide function call events. See “Function-Call Subsystems” on page 10-23.

## See Also

### Blocks

Enabled and Triggered Subsystem | Enabled Subsystem | Function-Call Subsystem | Triggered Subsystem

## Related Examples

- “Enabled Subsystems” on page 10-4
- “Triggered Subsystems” on page 10-14
- “Enabled and Triggered Subsystems” on page 10-19
- “Function-Call Subsystems” on page 10-23

## More About

- “Conditional Subsystem Initial Output Values” on page 10-27
- “Conditional Subsystem Output Values When Disabled” on page 10-29

## Enabled Subsystems

### In this section...

“Create an Enabled Subsystem” on page 10-5

“Blocks in Enabled Subsystems” on page 10-6

“Alternately Executing Enabled Subsystems” on page 10-8

An *enabled subsystem* is a conditionally executed subsystem that runs once at each major time step while the control signal has a positive value. If the signal crosses zero during a minor time step, the subsystem is not enabled or disabled until the next major time step.

The control signal can be either a scalar or a vector.

- If a scalar value is greater than zero, the subsystem executes.
- If any one of the vector element values is greater than zero, the subsystem executes.

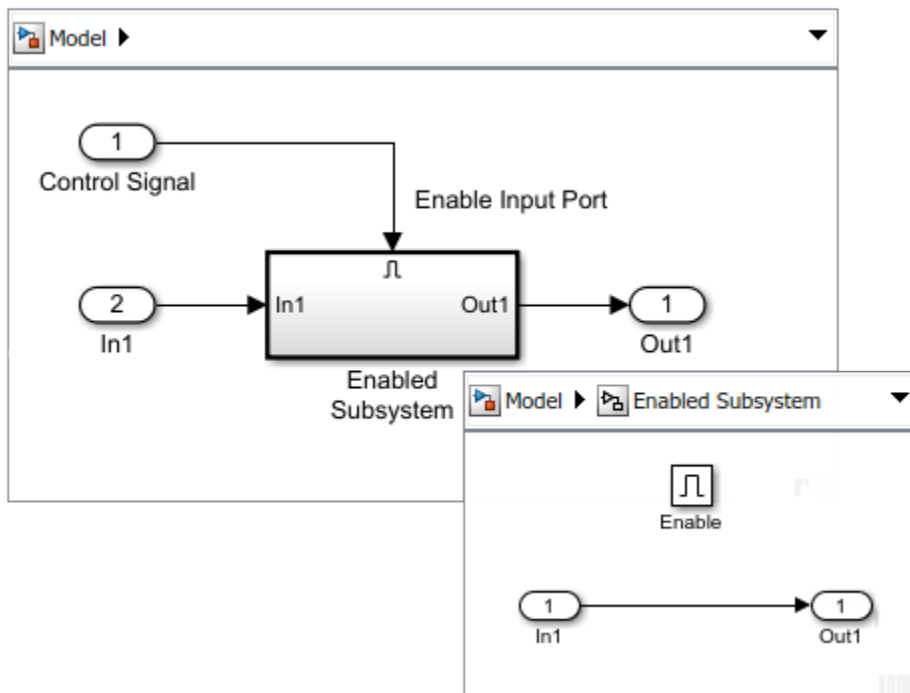

## Create an Enabled Subsystem

To create an enabled subsystem:

- 1 Add an Enabled Subsystem block to your model.
  - Copy a block from the Simulink Ports & Subsystems library to your model.
  - Click the model diagram, start typing `enabled`, and then select Enabled Subsystem.

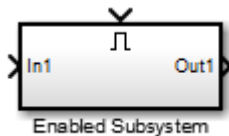

- 2 Set initial and disabled values for the Output blocks. See “Conditional Subsystem Initial Output Values” on page 10-27 and “Conditional Subsystem Output Values When Disabled” on page 10-29.
- 3 Specify how subsystem states are handled when the subsystem is enabled.

Open the subsystem block, and then open the parameter dialog box for the Enable port block. From the **States when enabling** drop-down list, select:

- **held** — States maintain their most recent values.
- **reset** — If the subsystem is disabled for at least one time step, states revert to their initial conditions .

In simplified initialization mode (default), the subsystem elapsed time is always reset during the first execution after becoming enabled. This reset happens regardless of whether the subsystem is configured to reset on being enabled. See “Underspecified initialization detection”.

For nested subsystems whose Enable blocks have different parameter settings, the settings for the child subsystem override the settings inherited from the parent subsystem.

- 4 Output the control signal from the Enable block.

In the parameter dialog box for the Enable Block, select the **Show output port** check box.

Selecting this parameter allows you to pass the control signal into the enabled subsystem. You can use this signal with an algorithm that depends on the value of the control signal.

## Blocks in Enabled Subsystems

### Discrete Blocks

Discrete blocks in an enabled subsystem execute only when the subsystem executes, and only when their sample times are synchronized with the simulation sample time.

Consider the `ex_enabled_subsys_1` model, which contains four discrete blocks and a control signal. The discrete blocks are:

- Block A, with the sample time of 0.25 seconds
- Block B, with the sample time of 0.5 seconds

Signal E is the enable control signal generated by a Pulse Generator with a sample time of 0.125. Its output changes value from 0 to 1 at 0.375 seconds and returns to 0 at 0.875 seconds.

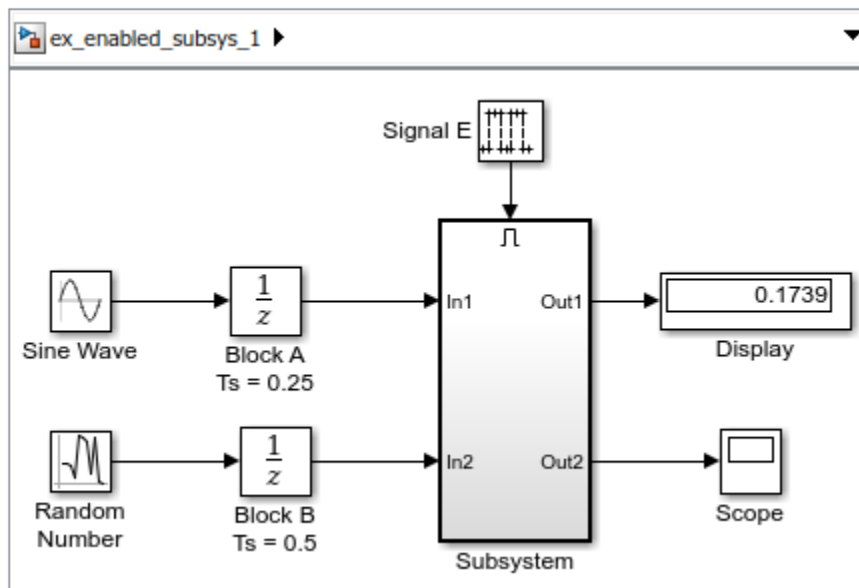



The discrete blocks in the enabled subsystem are:

- Block C, within the enabled subsystem, with the sample time of 0.125 seconds
- Block D, also within the enabled subsystem, with the sample time of 0.25 seconds

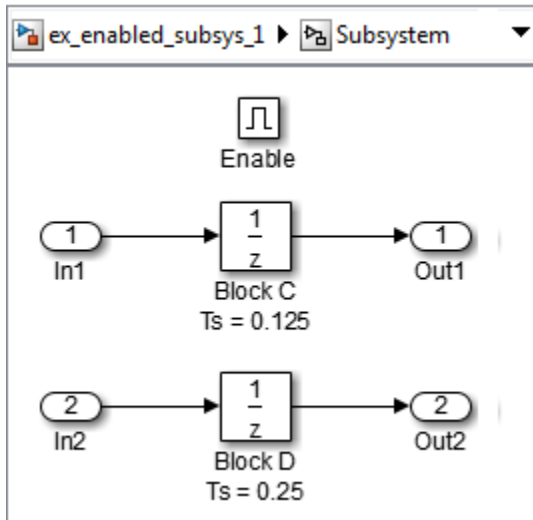

Discrete blocks execute at sample times shown.

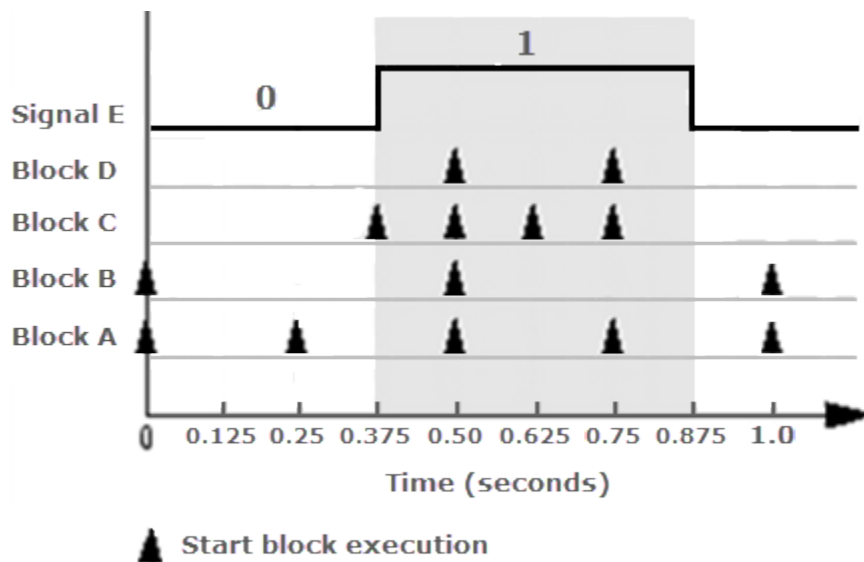

Blocks A and B execute independently of the enable control signal because they are not part of the enabled subsystem. When the enable control signal becomes positive, blocks C and D execute at their assigned sample rates until the enable control signal becomes zero again. Block C does not execute at 0.875 seconds when the enable control signal changes to zero.

### Goto Blocks

Enabled subsystems can contain Goto blocks. However, only output ports for blocks with state can connect to Goto blocks. See the `Locked` subsystem in the model `sldemo_clutch`, for an example of using Goto blocks in an enabled subsystem.

### Alternately Executing Enabled Subsystems

You can use conditional subsystems with Merge blocks to create sets of subsystems that execute alternately, depending on the current state of the model.

Consider a model that uses two Enabled Subsystem blocks and a Merge block to model a full-wave rectifier (a device that converts AC current to pulsating DC current).

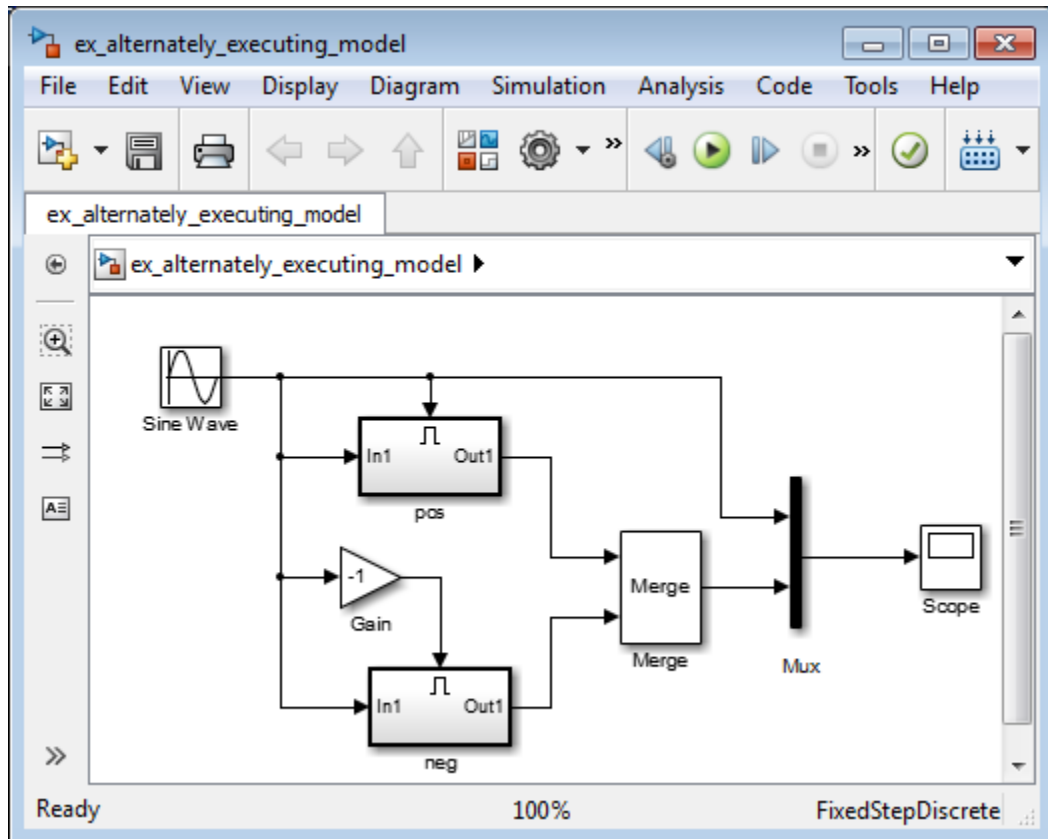

Open the `pos` subsystem. The subsystem is enabled when the AC waveform is positive and passes the waveform unchanged to its output.

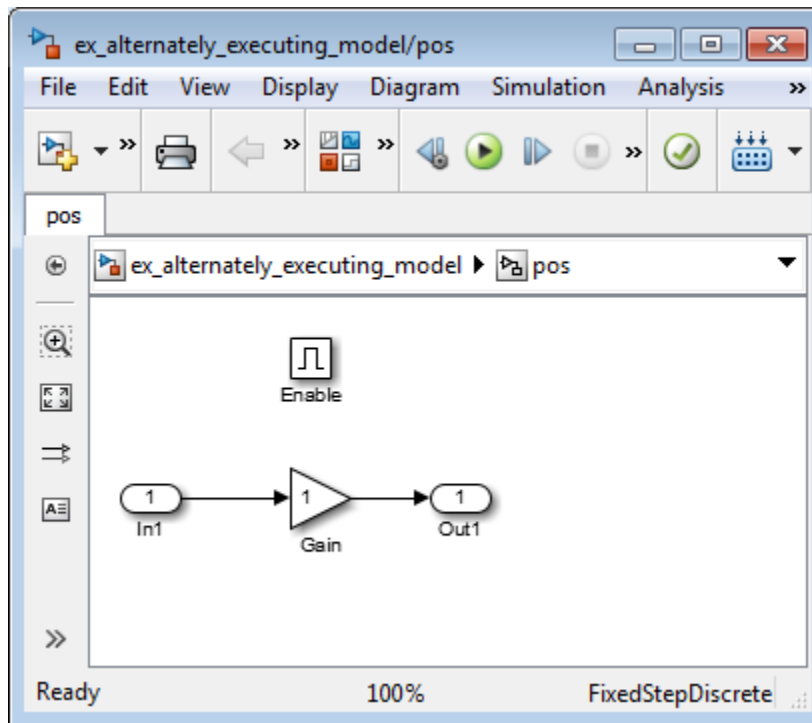

Open the `neg` subsystem. The subsystem is enabled when the waveform is negative and inverts the waveform.

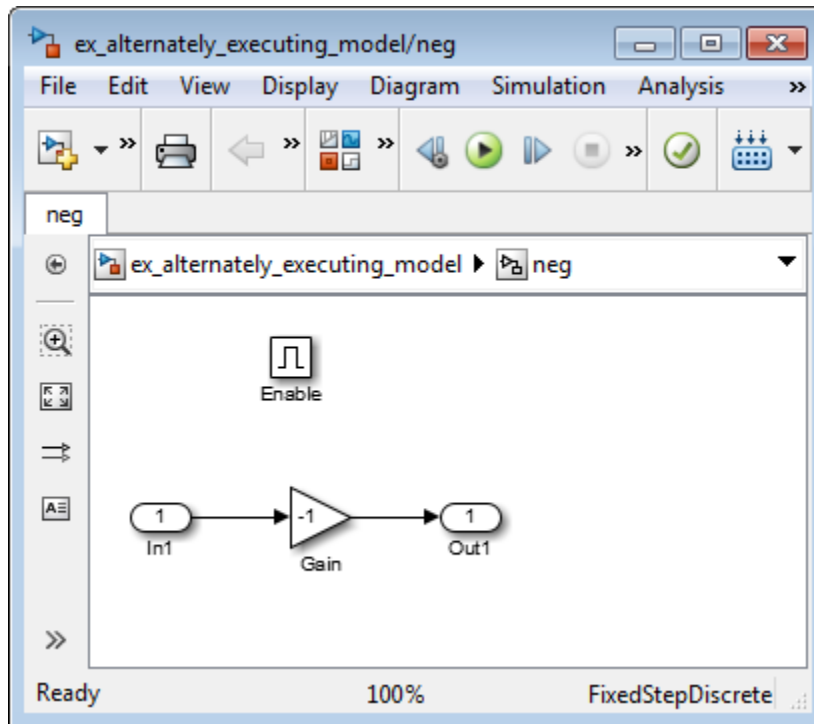

The Merge block passes the output of the currently enabled subsystem along with the original waveform to the Scope block.

Running a simulation and then opening the Scope block shows the following result.

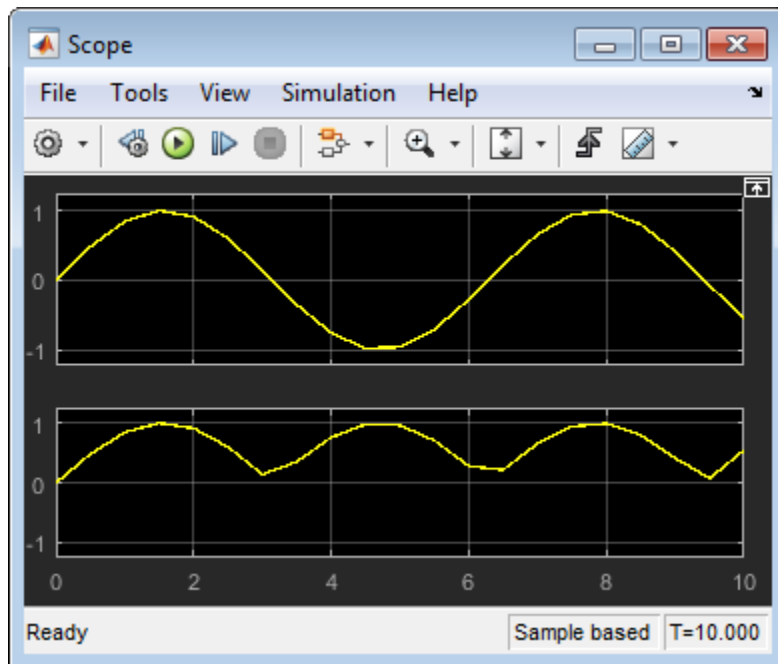

### See Also

#### Blocks

Enabled and Triggered Subsystem | Enabled Subsystem | Function-Call Subsystem | Triggered Subsystem

### Related Examples

- “Triggered Subsystems” on page 10-14
- “Enabled and Triggered Subsystems” on page 10-19
- “Function-Call Subsystems” on page 10-23

### More About

- “Conditional Subsystems” on page 10-2
- “Conditional Subsystem Initial Output Values” on page 10-27
- “Conditional Subsystem Output Values When Disabled” on page 10-29

- “Comparison of Resettable Subsystems and Enabled Subsystems” on page 10-75

## Triggered Subsystems

In this section...
“Create a Triggered Subsystem” on page 10-15
“Triggering with Discrete Time Systems” on page 10-17
“Triggered Model Versus a Triggered Subsystem” on page 10-17
“Blocks in a Triggered Subsystem” on page 10-18

A triggered subsystem is a conditionally executed atomic subsystem that runs each time the trigger input port receives a trigger event.

Trigger events can occur when the control signal:

- Either rises from a negative value to a positive value or zero, or rises from a zero value to a positive value.
- Either falls from a positive value to a negative value or zero, or falls from a zero value to a negative value.
- Rises or falls through or to a zero value.



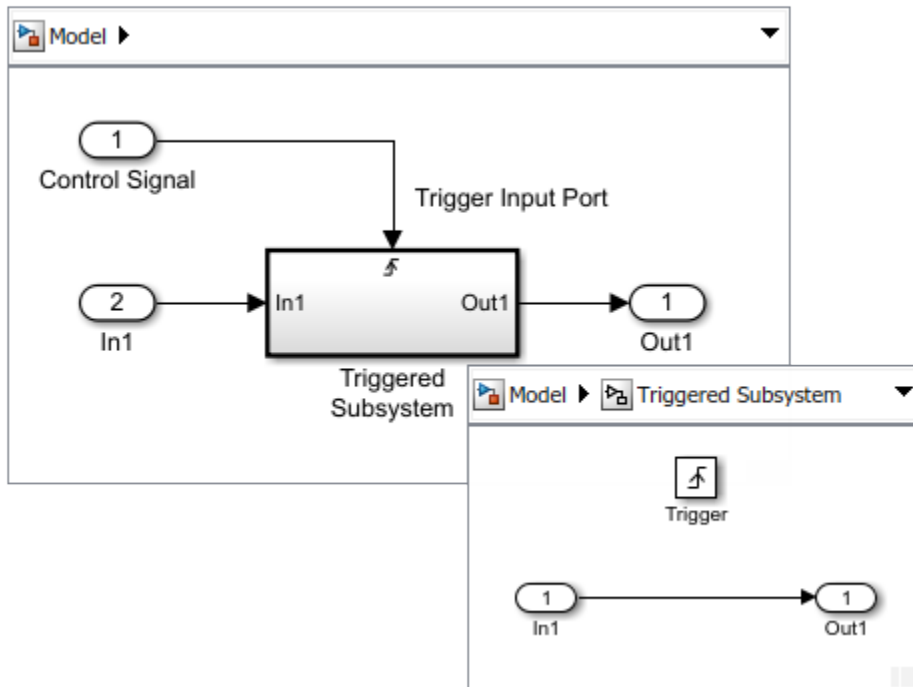

Unlike an Enabled Subsystem block, a Triggered Subsystem block always holds its outputs at the last value between triggering events. Also, triggered subsystems cannot reset block states when triggered; the states of any discrete block are held between trigger events.

## Create a Triggered Subsystem

To create a triggered subsystem:

- 1 Add a Triggered Subsystem block to your model.
  - Copy a block from the Simulink Ports & Subsystems library to your model.
  - Click the model diagram, start typing `trigger`, and then select Triggered Subsystem.

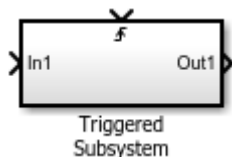

- 2 Set initial and disabled values for the Output blocks. See “Conditional Subsystem Initial Output Values” on page 10-27 and “Conditional Subsystem Output Values When Disabled” on page 10-29.
- 3 Set how the control signal triggers execution.

Open the subsystem block, and then open the parameter dialog box for the Trigger port block. From the **Trigger type** drop-down list, select:

- **rising** — Trigger execution of the subsystem when the control signal rises from a negative or zero value to a positive value.
- **falling** — Trigger execution of the subsystem when the control signal falls from a positive or zero value to a negative value.
- **either** — Trigger execution of the subsystem with either a rising or falling control signal.

Different symbols appear on the Trigger and Subsystem blocks to indicate rising and falling triggers.

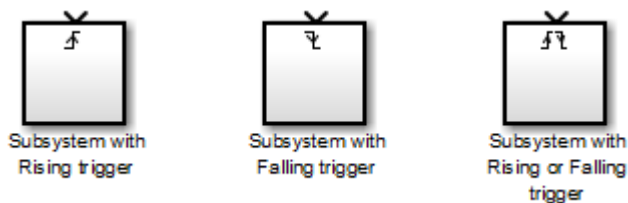

- 4 Output the enable control signal from the Trigger port block. Open the Trigger port block. Select the **Show output port** check box to pass the control signal into the triggered subsystem.

You can use this signal with an algorithm that depends on the value of the control signal.

- 5 From the **Output data type** drop-down list, select `auto`, `int8`, or `double`.

The `auto` option causes the data type of the output signal to be the data type (either `int8` or `double`) of the block port connected to the signal.

## Triggering with Discrete Time Systems

For a discrete time system, the trigger control signal must remain at zero for more than one time step. This triggering strategy eliminates false triggers caused by control signal sampling.

In the following timing diagram for a discrete system, a rising trigger event (R) does not occur at time step 3. The trigger signal remains at zero for only one time step before the signal increases from zero.

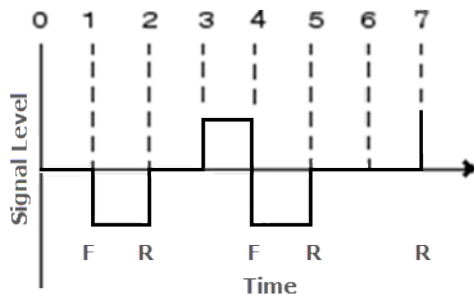

## Triggered Model Versus a Triggered Subsystem

You can place a Trigger port block in a Model block (referenced model) to simplify your model design instead of using one of these blocks:

- A Triggered Subsystem block in a Model block.
- A Model block in a Triggered Subsystem block.

For information about using Trigger port blocks in referenced models, see “Create and Reference Conditional Referenced Models” on page 8-82.

To convert a subsystem to use model referencing, see “Convert a Subsystem to a Referenced Model” on page 8-17.

### Blocks in a Triggered Subsystem

All blocks in a triggered subsystem must have **Sample time** set to inherited (-1) or constant (inf). This requirement allows the blocks in a triggered subsystem to run only when the triggered subsystem itself runs. This requirement also means that a triggered subsystem cannot contain continuous blocks, such as an Integrator block.

### See Also

#### Blocks

Enabled and Triggered Subsystem | Enabled Subsystem | Function-Call Subsystem | Triggered Subsystem

### Related Examples

- “Enabled Subsystems” on page 10-4
- “Enabled and Triggered Subsystems” on page 10-19
- “Function-Call Subsystems” on page 10-23

### More About

- “Conditional Subsystems” on page 10-2
- “Conditional Subsystem Initial Output Values” on page 10-27
- “Conditional Subsystem Output Values When Disabled” on page 10-29

## Enabled and Triggered Subsystems

### In this section...

“Creating an Enabled and Triggered Subsystem” on page 10-20

“Blocks in an Enabled and Triggered Subsystem” on page 10-22

An Enabled and Triggered Subsystem is a conditionally executed subsystem that runs once at each simulation time step when both these conditions apply:

- Enabled control signal has a positive value.
- Trigger input port receives a trigger event.

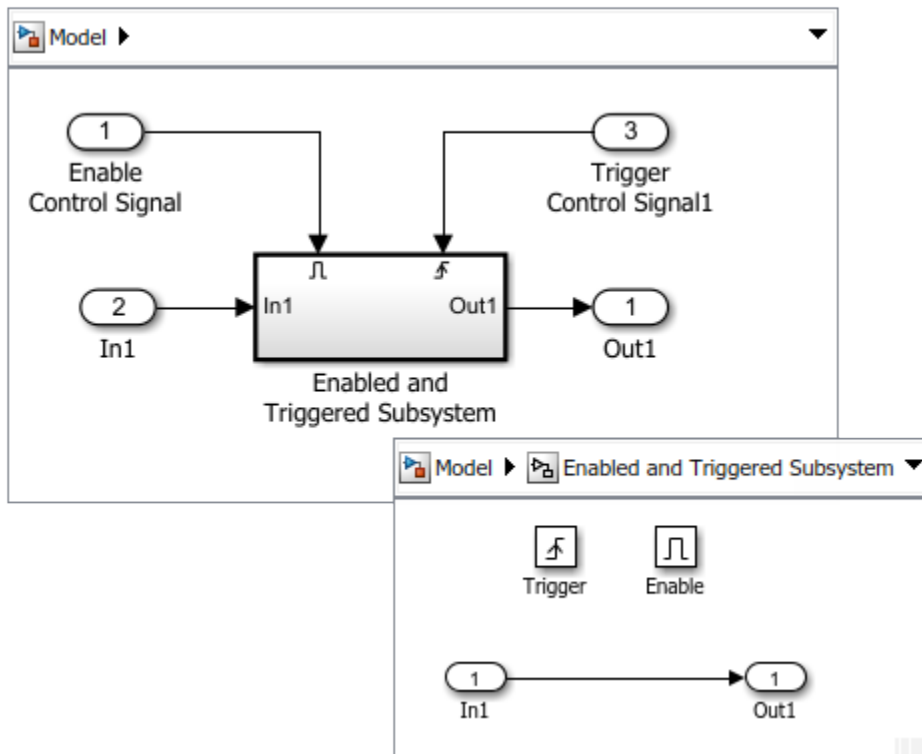

An Enabled and Triggered Subsystem block contains both an Enable port block and a Trigger port block. When a trigger event occurs, the enable input port is checked to

evaluate the enable control signal. If its value is greater than zero, the subsystem is executed. When both inputs are vectors, the subsystem executes if at least one element of each vector is nonzero.

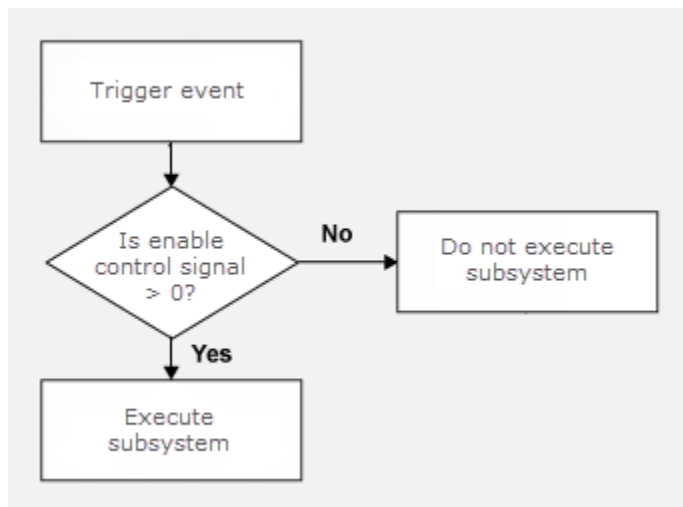

## Creating an Enabled and Triggered Subsystem

To create an enabled and triggered subsystem:

- 1 Add an Enabled and Triggered Subsystem block to your model.
  - Copy a block from the Simulink Ports & Subsystems library to your model.
  - Click the model diagram, start typing `enabled`, and then select Enabled and Triggered Subsystem.

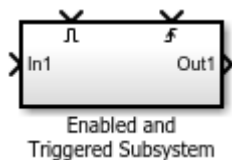

- 2 Set initial and disabled values for the Output blocks. See “Conditional Subsystem Initial Output Values” on page 10-27 and “Conditional Subsystem Output Values When Disabled” on page 10-29.

### 3 Set how the control signal triggers execution.

Open the subsystem block, and then open the block parameters dialog box for the Trigger port block. From the **Trigger type** drop-down list, select:

- **rising** — Trigger execution of the subsystem when the control signal rises from a negative or zero value to a positive value.
- **falling** — Trigger execution of the subsystem when the control signal falls from a positive or zero value to a negative value.
- **either** — Trigger execution of the subsystem with either a rising or falling control signal.

Different symbols appear on the Trigger and Subsystem blocks to indicate rising and falling triggers.

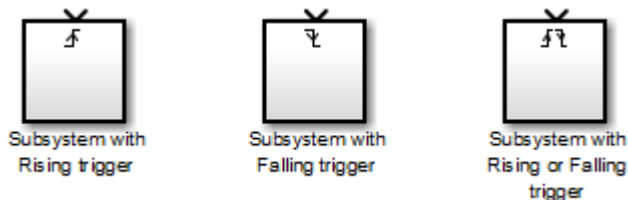

### 4 Specify how subsystem states are handled when enabled.

Open the subsystem block, and then open the Enable port block. From the **States when enabling** drop-down list, select:

- **held** — States maintain their most recent values.
- **reset** — States revert to their initial conditions if the subsystem is disabled for at least one time step.

In simplified initialization mode, the subsystem elapsed time is always reset during the first execution after becoming enabled. This reset happens regardless of whether the subsystem is configured to reset on being enable. See “Underspecified initialization detection”.

For nested subsystems whose Enable blocks have different parameter settings, the settings for the child subsystem override the settings inherited from the parent subsystem.

### Blocks in an Enabled and Triggered Subsystem

All blocks in a triggered subsystem must have **Sample time** set to inherited (-1) or constant (inf). This requirement allows the blocks in a triggered subsystem to run only when the triggered subsystem itself runs. This requirement also means that a triggered subsystem cannot contain continuous blocks, such as an Integrator block.

### See Also

#### Blocks

Enabled and Triggered Subsystem | Enabled Subsystem | Function-Call Subsystem | Triggered Subsystem

### Related Examples

- “Enabled Subsystems” on page 10-4
- “Triggered Subsystems” on page 10-14
- “Function-Call Subsystems” on page 10-23

### More About

- “Conditional Subsystems” on page 10-2
- “Conditional Subsystem Initial Output Values” on page 10-27
- “Conditional Subsystem Output Values When Disabled” on page 10-29



## Function-Call Subsystems

### In this section...

“Creating a Function-Call Subsystem” on page 10-23

“Sample Time Propagation in a Function-Call Subsystem” on page 10-25

A Function-Call Subsystem block is a conditionally executed subsystem that runs each time the control signal has a function-call event. A Stateflow chart, Function-Call Generator block, or an S-function block can provide function call events.

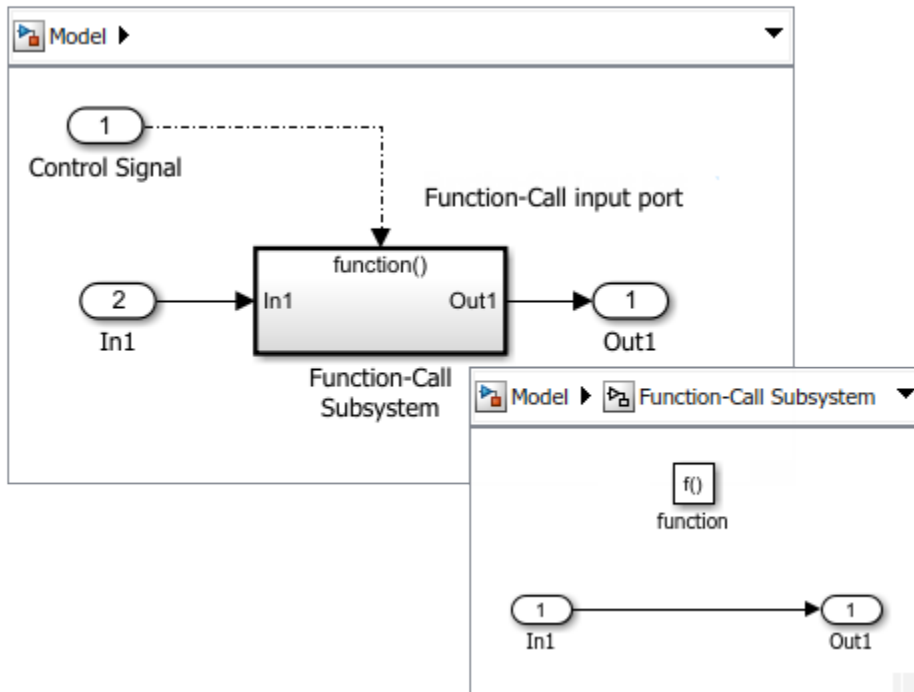

A function-call subsystem is analogous to a function in a procedural programming language. Invoking a function-call subsystem executes the output methods of the blocks within the subsystem in sorted order.

### Creating a Function-Call Subsystem

To create a function-call subsystem:

- 1 Add an Function-Call Subsystem block to your model.
  - Copy a block from the Simulink Ports & Subsystems library to your model.
  - Click the model diagram, start typing `function-call`, and then select Function-Call Subsystem.

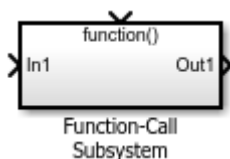

- 2 Set initial and disabled values for the Outport blocks. See “Conditional Subsystem Initial Output Values” on page 10-27 and “Conditional Subsystem Output Values When Disabled” on page 10-29.
- 3 Set how subsystem states are handled when executed.

Open the subsystem block, and then open the block parameters dialog box for the Trigger block. From the **States when enabling** drop-down list, select:

- **held** — States maintain their most recent values.
- **reset** — States set to their initial conditions.
- **inherit** — Use the held or reset setting from the parent subsystem initiating the function-call.

For nested subsystems whose Function-Call Subsystem blocks have different parameter settings, the settings for the child subsystem override the settings inherited from the parent subsystem.

- 4 Attach a function-call initiator to the function-call input port.

If you attach an Inport block, open the block, select the Signal Attributes pane, and then select the **Output function call** check box.

You can also create a function-call subsystem from scratch. First, add a Subsystem block in your model, and then add a Trigger block in the subsystem. Next, open the Trigger block dialog box and set the **Trigger type** to `function-call`.

## Sample Time Propagation in a Function-Call Subsystem

Configure a Function-Call Subsystem block by setting the **Sample time type** of its Trigger port block to **triggered** or **periodic**.

- A triggered function-call subsystem can execute zero, one, or multiple times during a time step.

If a function-call subsystem is triggered by a root Inport block with a discrete sample time, multiple function-calls during a time step are not allowed. To allow multiple function-calls, set **Sample time** to **-1**.

You must set the sample time for all the blocks in a triggered function-call subsystem to **inherited (-1)**.

- A periodic function-call subsystem executes once during a time step and must receive periodic function-calls. If the function-calls are aperiodic, the simulation stops and an error message is displayed.

You can specify a noninherited sample time or **inherited (-1)** sample time. All blocks that specify a noninherited sample time must specify the same sample time. For example, if one block specifies **0.1** as the sample time, all other blocks must specify a sample time of **0.1** or **-1**. If function-calls are at a rate that differs from the sample time specified by the blocks in the subsystem, the simulation stops and an error message is displayed.

---

**Note:** During range checking, the minimum and maximum parameter settings are back-propagated to the actual source port of the function-call subsystem, even when the function-call subsystem is not enabled.

To prevent this back propagation:

- 1 Add a Signal Conversion block and a Signal Specification block after the source port.
  - 2 Set the **Output** of the Signal Conversion block to **Signal copy**.
  - 3 Specify the minimum and maximum values for the Signal Specification block instead of specifying them on the source port.
-

### See Also

#### Blocks

Function-Call Feedback Latch | Function-Call Generator | Function-Call Split | Function-Call Subsystem | Trigger

### Related Examples

- “Export-Function Models” on page 10-52
- “Generate Component Source Code for Export to External Code Base” (Embedded Coder)
- “Context-dependent inputs”
- “Invalid function-call connection”
- “Check usage of function-call connections”
- “Check for potentially delayed function-call subsystem return values”

### More About

- “Conditional Subsystems” on page 10-2
- “Conditional Subsystem Initial Output Values” on page 10-27
- “Conditional Subsystem Output Values When Disabled” on page 10-29

## Conditional Subsystem Initial Output Values

### In this section...

“Inherit Initial Output Values from Input Signals” on page 10-27

“Specify Initial Output Values” on page 10-28

To initialize the output values of a conditional subsystem, initialize its Output blocks by using one of these methods:

- Inherit initial output values from input signals.
- Specify initial output values using Output block parameters.

---

**Note:** If the conditional subsystem is driving a Merge block in the same model, you do not need to specify an initial condition for the subsystem Output block.

---

### Inherit Initial Output Values from Input Signals

By default, Simulink uses subsystem input signals to initialize output values. Valid sources for input signals are:

- Output ports from another conditionally executed subsystem
- Output ports from a Model block with a Trigger block set to function-call
- Merge blocks
- Constant blocks
- IC (initial condition) blocks
- Stateflow chart

If the input signal is from a block that is not listed here, the Output block uses the default initial value of the output data type.

To Specify output values with input signals:

- 1 Open the dialog box for an Output block in a conditional subsystem.
- 2 From the **Source of initial output value** drop-down list, select **Input signal**.

---

**Note:** If you are using classic initialization mode, selecting `Input signal` causes an error. To inherit the initial output value from an input signal, set this parameter to `Dialog` and set **Initial output** to the empty matrix `[]`.

---

### Specify Initial Output Values

Explicitly set the initial output values in cases where you want to:

- Test the behavior of a model with various initial values.
- Set initial values to steady state and reduce simulation time.
- Eliminate having to trace input signals to determine the initial output values.

To specify initial output values:

- 1 Open the dialog box for an Output block in a conditional subsystem.
- 2 From the **Source of initial output value** drop-down list, select `Dialog`.
- 3 In the **Initial output** box, enter the initial value.

---

**Note:** You cannot use a `Simulink.Signal` object to specify the **Initial output** value.

---

### More About

- “Conditional Subsystems” on page 10-2
- “Conditional Subsystem Output Values When Disabled” on page 10-29

## Conditional Subsystem Output Values When Disabled

Although a conditional subsystem does not execute while it is disabled, the output signal is still available to other blocks. When a conditional subsystem is disabled and you have specified to not inherit initial conditions from an input signal, you can hold the subsystem outputs at their previous values or reset them to their initial conditions.

To specify output values when disabled:

- 1 Open the dialog box for an Output block in a conditional subsystem.
- 2 From the **Source of initial output value** drop-down list, select **Dialog**.
- 3 From the **Output when disabled** drop-down list, select one of these options:
  - **held** — Maintain the most recent value.
  - **reset** — Use the initial condition when enabled.

---

**Note:** If you are connecting the output of a conditionally executed subsystem to a Merge block, set **Output when disabled** to **held** to ensure consistent simulation results.

If you are using simplified initialization mode, you must select **held** when connecting a conditionally executed subsystem to a Merge block. For more information, see “Underspecified initialization detection”.

---

- 4 In the **Initial output** box, enter the initial value.

---

**Note:** If an Output block in an Enabled Subsystem resets its output when disabled at a different rate from the execution of the subsystem contents, both the disabled and execution outputs write to the subsystem output. This behavior can cause unexpected results.

---

### More About

- “Conditional Subsystems” on page 10-2
- “Conditional Subsystem Initial Output Values” on page 10-27

## Simplified Initialization Mode

In this section...
“When to Use Simplified Initialization” on page 10-30
“Set Initialization Mode to Simplified” on page 10-31

Initialization mode controls how Simulink handles:

- Initialization values for conditionally executed subsystems.
- Initial values for Merge blocks.
- Discrete-Time Integrator blocks.
- Subsystem elapsed time.

The default initialization mode for a model is simplified. This mode uses enhanced processing to improve consistency of simulation results and helps to:

- Attain the same simulation results with the same inputs when using the same blocks in a different model.
- Avoid unexpected changes to simulation results as you modify a model.

### When to Use Simplified Initialization

Use simplified initialization mode for models that contain one or more of the following blocks:

- Conditional subsystem blocks.
- Merge blocks. If a root Merge block has an empty matrix ([]) for its initial output value, simplified mode uses the default ground value of the output data type.
- Discrete-Time Integrator blocks. Simplified mode always uses the initial value as both the initial and reset value for output from a Discrete-Time Integrator block.

Use simplified mode if your model uses features that require simplified initialization mode, such as:

- Specify a structure to initialize a bus.
- Branch merged signals inside a conditional subsystem.



## Set Initialization Mode to Simplified

Simplified mode is the default initialization mode when creating a new Simulink model. If your model is using classic mode, you might need to make changes after you select simplified mode. See “Convert from Classic to Simplified Initialization Mode” on page 10-50.

- 1 Open the Configuration Parameters dialog box.
- 2 Select the **All Parameters** tab.
- 3 In the search box, enter **Underspecified initialization detection**.
- 4 From the drop-down list, select **Simplified**.

### More About

- “Conditional Subsystems” on page 10-2

## Classic Initialization Mode

### In this section...

“When to Use Classic Initialization” on page 10-32

“Set Initialization Mode to Classic” on page 10-32

“Classic Initialization Issues” on page 10-33

“Identity Transformation Can Change Model Behavior” on page 10-34

“Discrete-Time Integrator or S-Function Block Can Produce Inconsistent Output” on page 10-37

“Sorted Order Can Affect Merge Block Output” on page 10-40

### When to Use Classic Initialization

Initialization mode controls how Simulink handles the initialization values for conditionally executed subsystems.

**Classic** mode was the default initialization mode for Simulink models created in R2013b or before. You can continue to use classic mode if:

- The model does not include any modeling elements affected by simplified mode.
- The behavior and requirements of simplified mode do not meet your modeling goals.
- The work involved in converting to simplified mode is greater than the benefits of simplified mode. See “Convert from Classic to Simplified Initialization Mode” on page 10-50.

### Set Initialization Mode to Classic

To set classic initialization mode:

- 1 Open the Configuration Parameters dialog box.
- 2 Select the **All Parameters** tab.
- 3 In the search box, enter **Underspecified initialization detection**.
- 4 From the drop-down list, select **Classic**.

## Classic Initialization Issues

Using classic initialization mode can result in one or more of the following issues. You can address these issues by using simplified mode. The description of each issue includes an example of the behavior in classic mode, the behavior when you use simplified mode, and a summary of the changes you must make to use simplified mode.

- “Identity Transformation Can Change Model Behavior” on page 10-34.

Conditional subsystems that include identical subsystems can display different initial values before the first execution if both of these apply:

- The model uses classic initialization mode.
  - One or more of the identical subsystems outputs to an identity transformation block.
- “Discrete-Time Integrator or S-Function Block Can Produce Inconsistent Output” on page 10-37

Conditional subsystems that use classic initialization mode and whose output connects to a Discrete-Time Integrator block or S-Function block can produce inconsistent output.

- “Sorted Order Can Affect Merge Block Output” on page 10-40

The sorted order of conditional subsystems that used classic mode initialization, when connected to a Merge block, can affect the output of that Merge block. A change in block execution order can produce unexpected results.

- When you rename the Merge block source subsystem blocks, the initial output of the Merge block can change.

When two or more subsystems are feeding different initial output values to a Merge block that does not specify its own initial output value, renaming one of the subsystems can affect the initial output of the Merge block in classic initialization mode.

For additional information about the tasks involved to convert a model from classic to simplified mode, see “Convert from Classic to Simplified Initialization Mode” on page 10-50.

## Identity Transformation Can Change Model Behavior

Conditional subsystems that include identical subsystems can display different initial values before the first execution if both of these apply:

- The model uses classic initialization mode.
- One or more of the identical subsystems outputs to an identity transformation block.

An identity transformation block is a block that does not change the value of its input signal. Examples of identify transform blocks are a Signal Conversion block or a Gain block with a value of 1.

In the `ex_identity_transform_cl` model, subsystems A and B are identical, but B outputs to a Gain block, which in turn outputs to an Outport block.

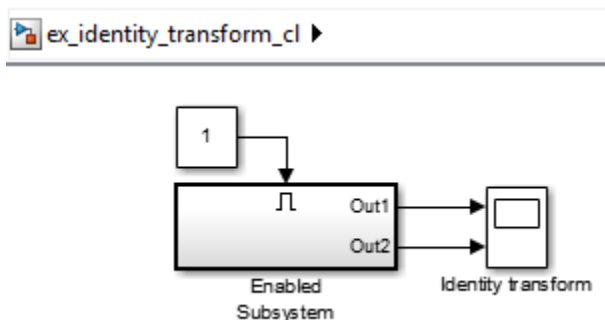

ex\_identity\_transform\_cl ▶ Enabled Subsystem ▶

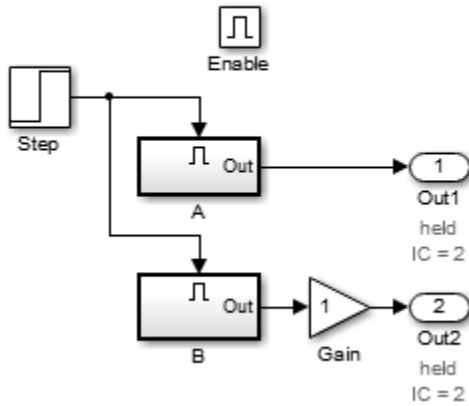

ex\_identity\_transform\_cl ▶ Enabled Subsystem ▶ A

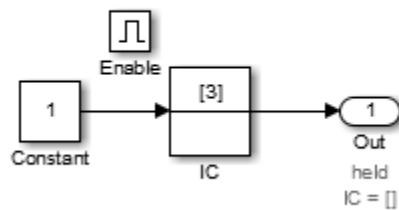

When you simulate the model, the initial value for A (the top signal in the Scope block) is 2, but the initial value of B is 0, even though the subsystems are identical.

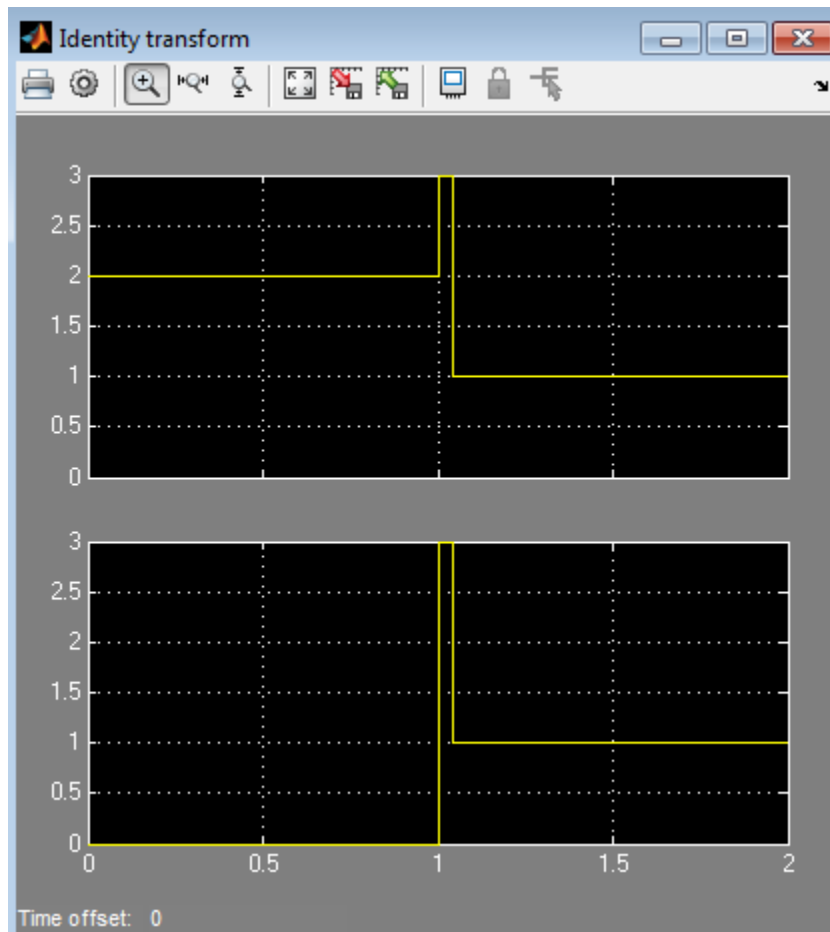

If you update the model to use simplified initialization mode (see `ex_identity_transform_simpl`), the model looks the same. The steps required to convert `ex_identity_transform_cl` to `ex_identity_transform_simpl` are:

- 1 Set **Configuration Parameters** > **All Parameters** > **Underspecified initialization detection** to **Simplified**.
- 2 For the Outputport blocks in subsystems A and B, set the **Source of initial output value** parameter to `Input signal`.

You can also get the same behavior by setting the **Source of initial output value** parameter to `Dialog` and the **Initial output** parameter to 3.

When you simulate the updated model, the connection of an identity transformation does not change the result. The output is consistent in both cases.

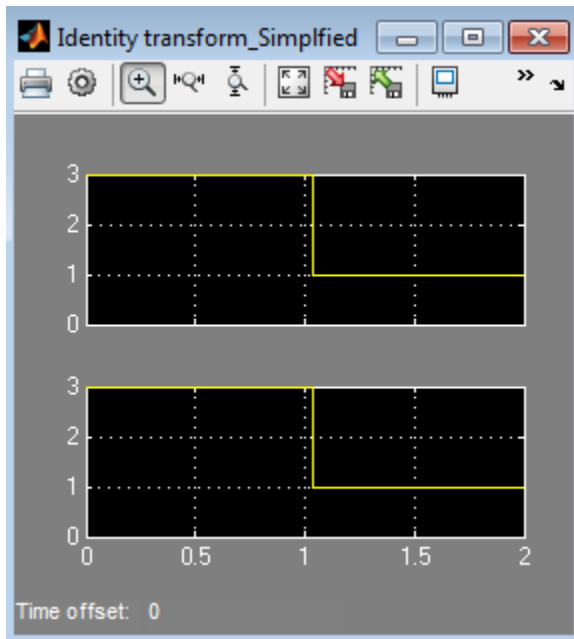

## Discrete-Time Integrator or S-Function Block Can Produce Inconsistent Output

Conditional subsystems that use classic initialization mode and whose output connects to a Discrete-Time Integrator block or S-Function block can produce inconsistent output.

In the `ex_discrete_time_cl` model, the enabled subsystem includes two Constant blocks and outputs to a Discrete-Time Integrator block. The enabled subsystem outputs to two Display blocks.

ex\_discrete\_time\_cl ▶

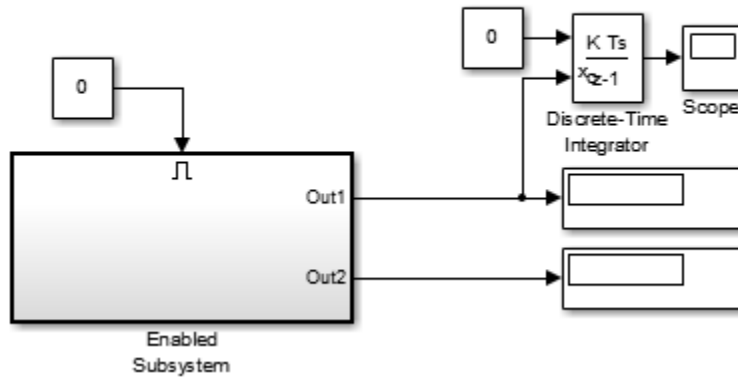

ex\_discrete\_time\_cl ▶ Enabled Subsystem

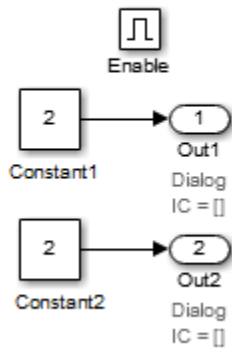

When you simulate the model, the two display blocks show different values.



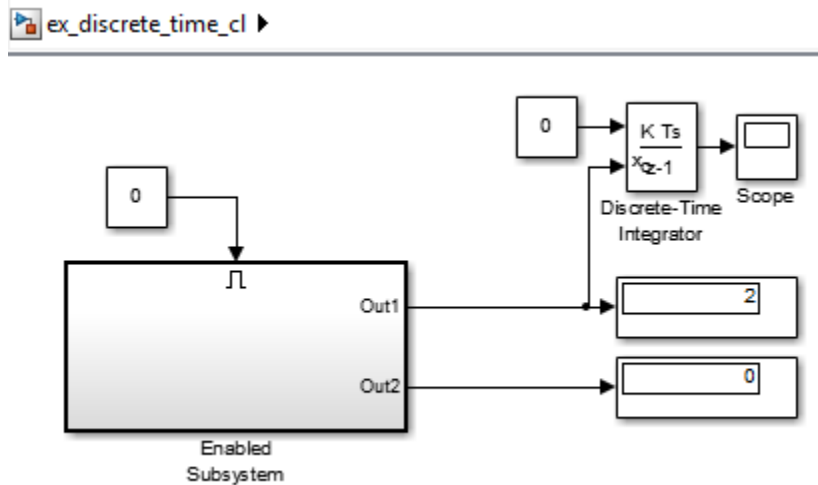

The Constant1 block, which is connected to the Discrete-Time Integrator block, executes, even though the conditional subsystem is disabled. The top Display block shows a value of 2, which is the value of the Constant1 block. The Constant2 block does not execute, so the bottom Display block shows a value of 0.

If you update the model to use simplified initialization mode (see `ex_discrete_time_simpl`), the model looks the same. The updated model corrects the inconsistent output issue by using simplified mode. The steps required to convert `ex_discrete_time_cl` to `ex_discrete_time_simpl` are:

- 1 Set **Configuration Parameters > All Parameters > Underspecified initialization detection** to **Simplified**.
- 2 For the Output blocks Out1 and Out2, set the **Source of initial output value** parameter to **Input signal**. This setting explicitly inherits the initial value, which in this case is 2.

You can also get the same behavior by setting the **Source of initial output value** parameter to **Dialog** and the **Initial output** parameter to 2.

When you simulate the updated model, the Display blocks show the same output. The output value is 2 because both Output blocks inherit their initial value.

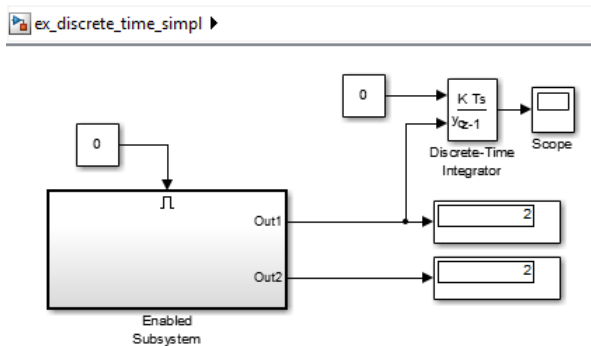

## Sorted Order Can Affect Merge Block Output

The sorted order of conditional subsystems that used classic mode initialization, when connected to a Merge block, can affect the output of that Merge block. A change in block execution order can produce unexpected results. The behavior depends on how you set the **Output When Disabled** parameter.

### Example Using Default Setting for the Output When Disabled Parameter

The `ex_basic_merge_sorted_order_1_cl` model has two identical enabled subsystems (Enable A and Enable B) that connect to a Merge block. When you simulate the model, the red numbers show the sorted execution order of the blocks.

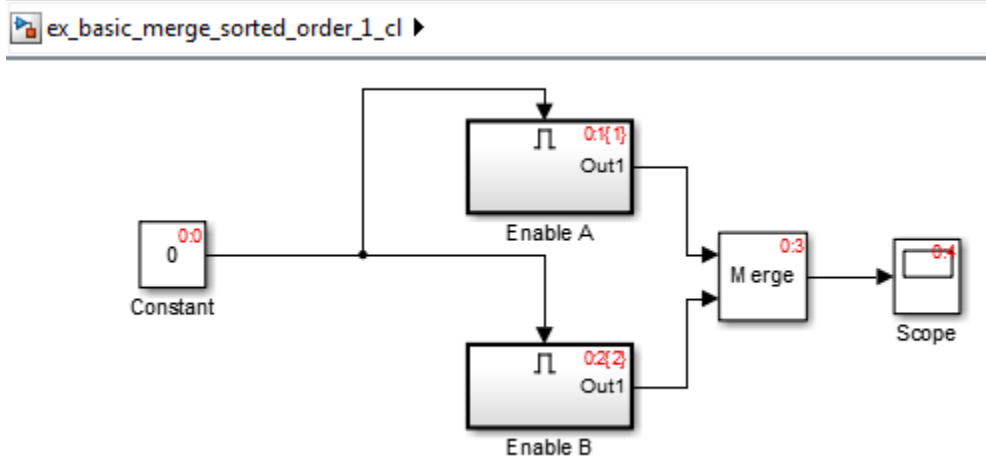

ex\_basic\_merge\_sorted\_order\_1\_cl ▶ Enable A

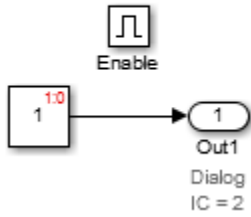

ex\_basic\_merge\_sorted\_order\_1\_cl ▶ Enable B

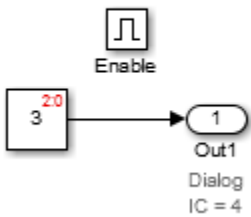

When you simulate the model, the Scope block looks like this:

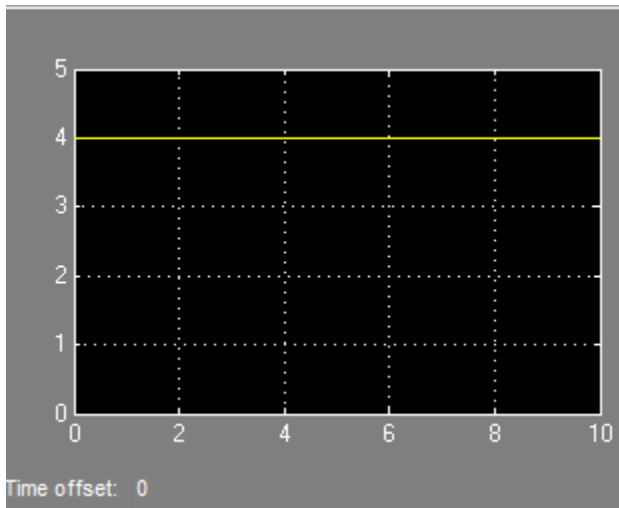

The `ex_basic_merge_sorted_order_2_cl` model is the same as `ex_merge_sorted_1_cl`, except that the block execution order is the reverse of the default execution order. To change the execution order:

- 1 Open the Properties dialog box for the Enable A subsystem and set the **Priority** parameter to 2.
- 2 Set the **Priority** of the Enable B subsystem to 1.

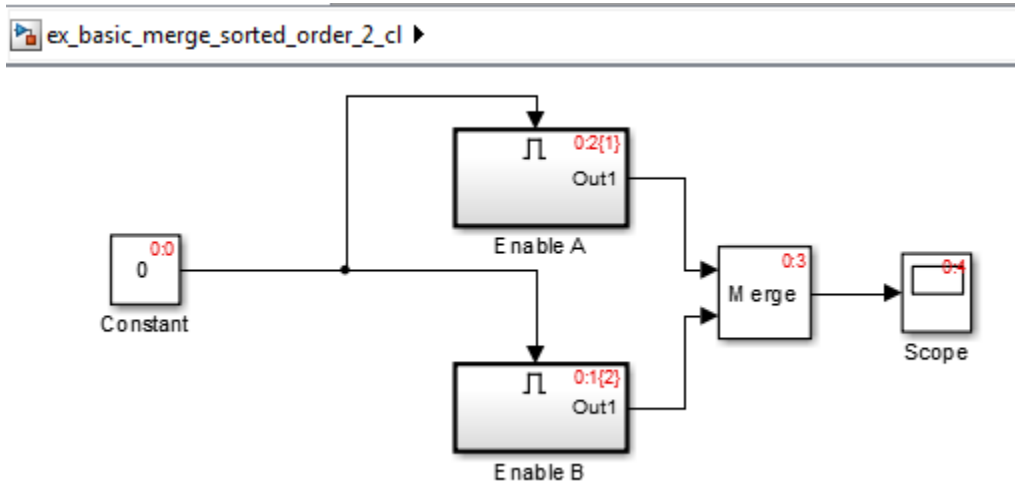

When you simulate the model using the different execution order, the Scope block looks like this:

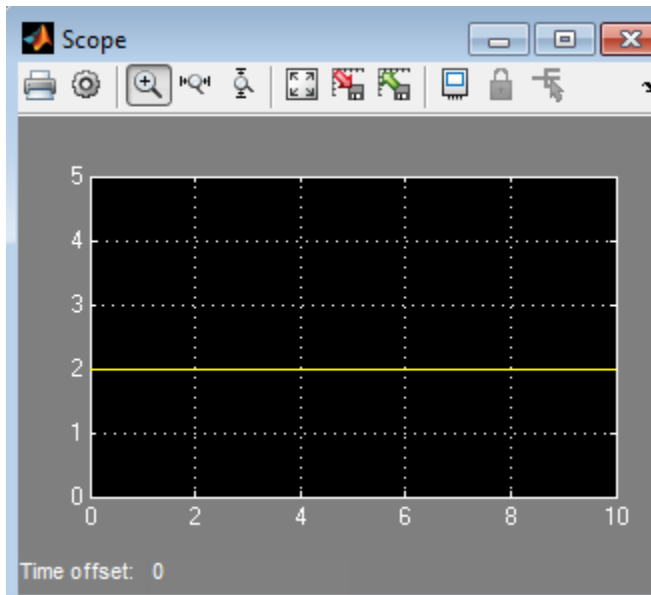

The change in sorted order produces different results from identical conditional subsystems.

To update the models to use simplified initialization mode, (see `ex_basic_merge_sorted_order_1_simpl` and `ex_basic_merge_sorted_order_2_simpl`):

- 1 Set **Configuration Parameters > All Parameters > Underspecified initialization detection** to **Simplified**.

The **Initial Output** parameter of the Merge block is an empty matrix, `[]`, by default. Hence, the initial output value is set to the default initial value for this data type, which is 0. For information on default initial value, see “Initializing Signal Values” on page 62-16. When you simulate each simplified mode model, both models produce the same results.

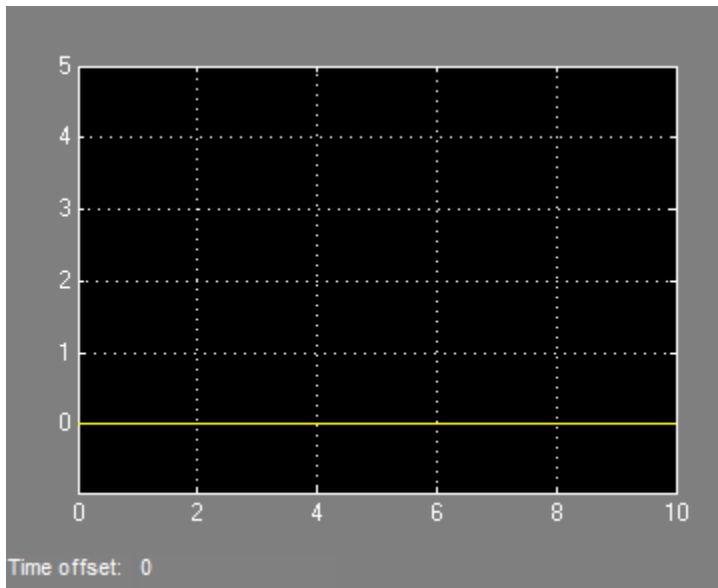

### Example Using Output When Disabled Parameter Set to Reset

The `ex_merge_sorted_1_cl` model has two enabled subsystems (Enable A and Enable B) that connect to a Merge block. When you simulate the model, the red numbers show the sorted execution order of the blocks.

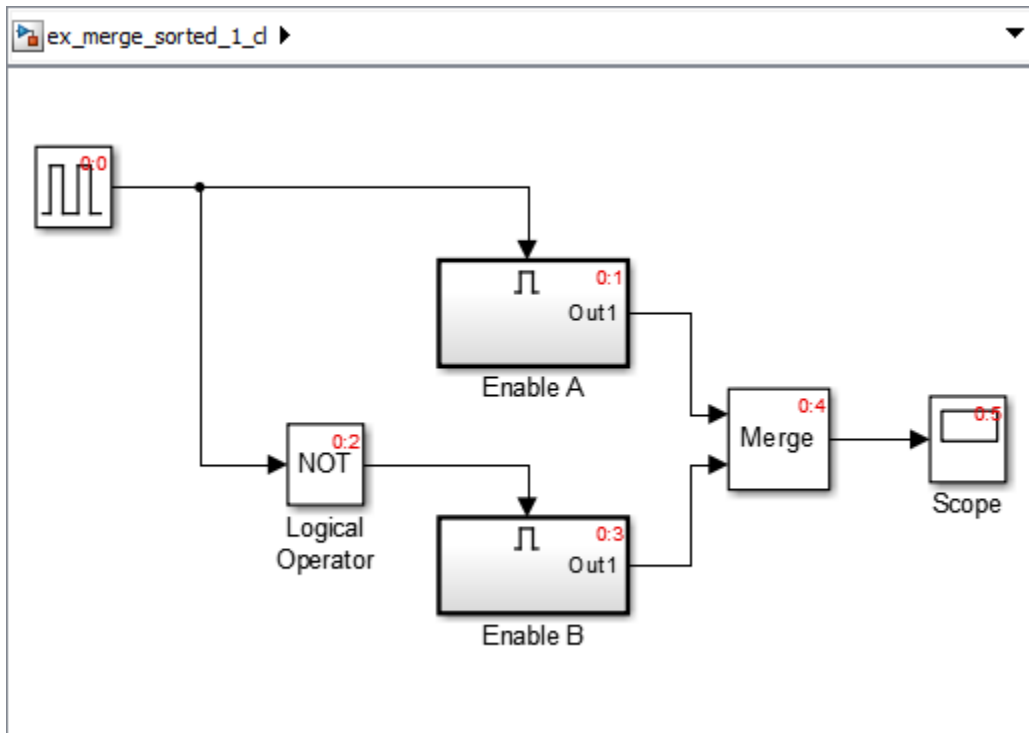

ex\_merge\_sorted\_1.cl ▸ Enable A

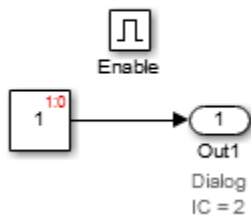

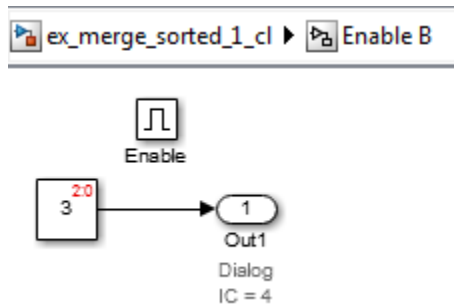

When you simulate the model, the Scope block looks like this:

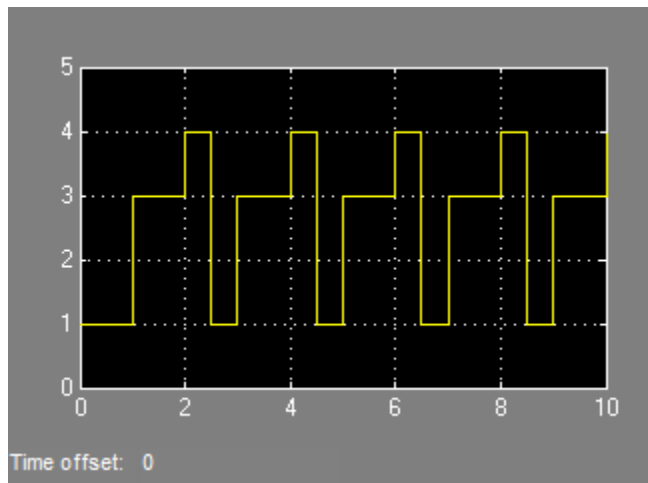

The `ex_merge_sorted_2_cl` model is the same as `ex_merge_sorted_1_cl`, except that the block execution order is the reverse of the default execution order. To change the execution order:

- 1 Open the Properties dialog box for the Enable A subsystem and set the **Priority** parameter to 2.
- 2 Set the **Priority** of the Enable B subsystem to 1.



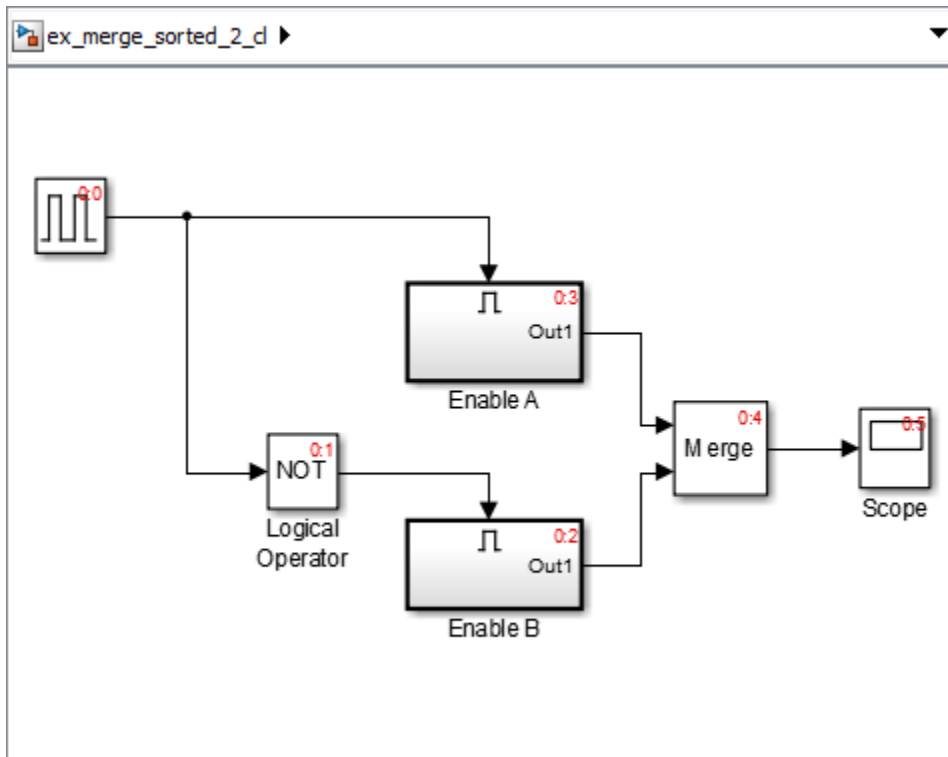

When you simulate the model using the different execution order, the Scope block looks like this:

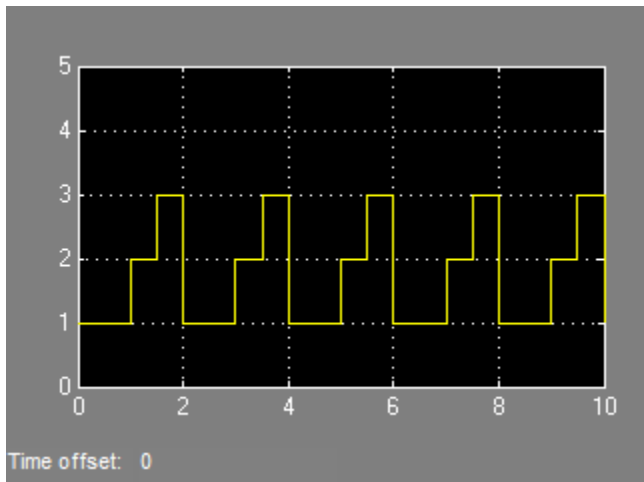

The change in sorted order produces different results from identical conditional subsystems.

To update the models to use simplified initialization mode (see `ex_merge_sorted_1_simpl` and `ex_merge_sorted_2_simpl`):

- 1 Set **Configuration Parameters > All Parameters > Underspecified initialization detection** to **Simplified**.
- 2 For the Outport blocks in Enable A and Enable B, set the **Output when disabled** parameter to **held**. Simplified mode does not support `reset` for outports of conditional subsystems driving Merge blocks.

When you simulate each simplified mode model, both models produce the same results.

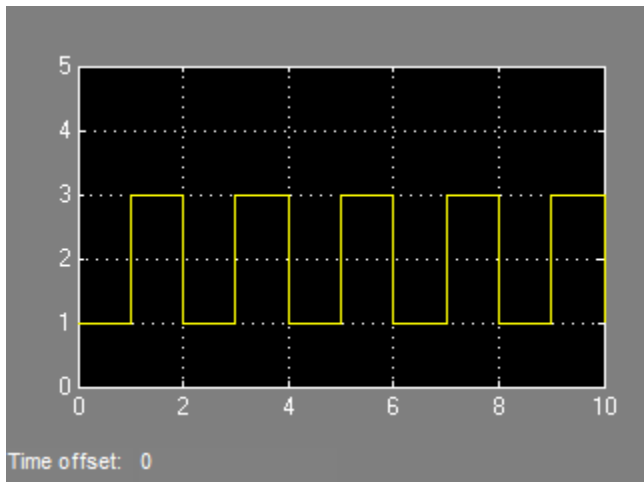

### More About

- “Conditional Subsystems” on page 10-2

## Convert from Classic to Simplified Initialization Mode

If you switch the initialization mode from classic to simplified mode, you can encounter several issues that you must fix. For most models, the following approach helps you to address conversion issues more efficiently.

- 1 Save the existing model and simulation results for the model.

Because you might need to make several changes to your model during the conversion process, it is helpful to have the original model for reference and for comparing simulation results.

- 2 Simulate the model and address any warnings.
- 3 In the Model Advisor, in the Simulink checks section, run the checks in the folder “Migrating to Simplified Initialization Mode Overview”.
- 4 Address the issues that Model Advisor identifies.
- 5 Simulate the model to make sure that there are no errors.
- 6 Rerun the Model Advisor checks in the folder “Migrating to Simplified Initialization Mode Overview” check to confirm that the modified model addresses the issues related to initialization.

For examples of models that have been converted from classic initialization mode to simplified initialization mode, see “Classic Initialization Issues” on page 10-33.

### Blocks to Consider

#### Discrete-Time Integrator Blocks

Discrete-Time Integrator block behaves differently in simplified mode than it does in classic mode. The changes for simplified mode promote more robust and consistent model behavior. For details, see “Behavior in Simplified Initialization Mode” in the Discrete-Time Integrator block reference documentation.

#### Library Blocks

Simulink creates a library assuming that classic mode is in effect. If you use a library block that is affected by simplified mode in a model that uses simplified mode, then use the Model Advisor to identify changes you must make so that the library block works with simplified mode.

## **More About**

- “Conditional Subsystems” on page 10-2

## Export-Function Models

**In this section...**

“About Export-Function Models” on page 10-52

“Requirements for Export-Function Models” on page 10-53

“Sample Time for Function-Call Subsystems in Export-Function Models” on page 10-54

“Control Export Function Scheduling Using Sample Time” on page 10-56

“Execution Order for Function-Call Root-Level Inport Blocks” on page 10-59

“Workflows for Export-Function Models” on page 10-64

“Nested Export-Function Models” on page 10-69

“Comparison Between Export-Function Models and Models with Asynchronous Function-Call Inputs” on page 10-70

### About Export-Function Models

Simulink provides the capability to export functions from Simulink models that are invoked by controlling logic that is outside the model. Such models are called export-function models, and their functional blocks are made up exclusively of function-call subsystems, function-call model blocks or other export-function models. These blocks are invoked using function-call triggers passed via root-level Inport blocks. Execute these functions by providing model inputs through root-level Inport blocks or by referencing this model in a top model to invoke the function-calls. The execution of these functions is subject to the guidelines described in “Requirements for Export-Function Models” on page 10-53.

The figure shows an export-function model and the resulting generated functions.

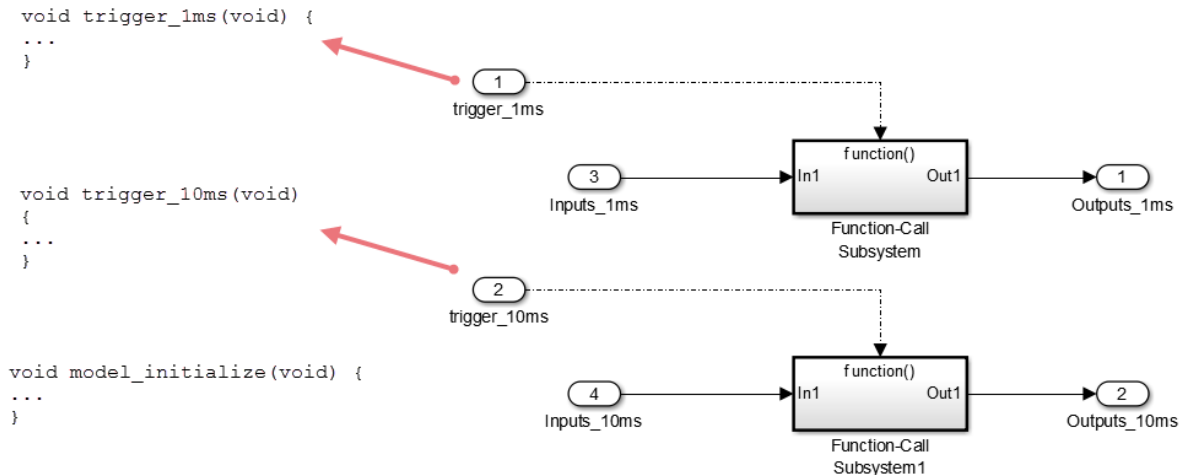

## Requirements for Export-Function Models

To set up a model to export functions, first meet these requirements. These requirements ensure that the executable components of the model are made up only of function-call blocks.

- The model solver must be a fixed-step discrete solver.
- Configure each root-level Inport block triggering a function-call subsystem to output a function-call trigger. These Inport blocks cannot be connected to an Asynchronous Task Specification block.
- Export-function models generate functions to be integrated with an external environment. Simulink does not generate a step function or a terminate function, and all blocks in these models must be executed in a function-call context. Thus, the model must contain only the following blocks at root level:
  - Function-call blocks, such as Function-Call Subsystem, S-functions, and Simulink Function blocks. Function-call Model blocks can be placed at the root-level only if their model parameter **Configuration Parameters > Solver > Tasking and sample time options > Periodic sample time constraint** is set to **Ensure sample time independent**.
  - Inport and Outport blocks

- Blocks with a sample time of Inf
- Merge and Data Store Memory blocks
- Virtual connection blocks (Function-Call Split, Mux, Demux, Bus Creator, Bus Selector, Signal Specification, and any virtual subsystem that contains any of the blocks listed.)
- Blocks inside function-call subsystems must support code generation. These blocks can use absolute or elapsed time if they are inside a periodic function-call subsystem with a discrete sample time specified on the corresponding function-call root-level Inport block.
- Data signals connected to root-level Inport and root-level Outport blocks cannot be a virtual bus.
- Data logging and signal-viewer blocks, such as the Scope block, are not allowed at the root level and within the function-call blocks.

## Sample Time for Function-Call Subsystems in Export-Function Models

There are two blocks for each function-call subsystem in export-function models where you must specify the sample time. These blocks are the function-call root-level Inport block and the Trigger block inside the function-call subsystem. The table shows how to specify these sample times.

	<b>Function-call root-level Inport block with inherited sample time (-1) specified</b>	<b>Function-call root-level Inport block with discrete sample time specified</b>
<b>Trigger block of function-call subsystem has sample time type set to Periodic</b>	Configuration not allowed.	Set sample time of Trigger block to inherited (-1) or the sample time of the function-call root-level Inport block. The subsystem executes at the specified rate. Periodic function-call run-time checks apply if the export-function model is used as a referenced model in normal simulation mode.



		<p>These subsystems can contain blocks that use elapsed time (e.g., Discrete-Time Integrator) and blocks that use absolute time (e.g., Digital Clock).</p> <p>You cannot set the model configuration parameter <b>Fixed-step size (fundamental sample time)</b> to <b>auto</b>.</p>
<p><b>Trigger block of function-call subsystem has sample time type set to Triggered</b></p>	<p>No sample time specification.</p>	<p>No sample time specification. The subsystem executes at the specified rate.</p> <p>You cannot set the model configuration parameter <b>Fixed-step size (fundamental sample time)</b> to <b>auto</b>.</p>

### Sample Time in Top Model Function-Call Initiators

The blocks that output function-call signals to the function-call root-level Inport blocks of the export-function models are called *function-call initiators*. When a top model references an export-function model, the blocks that supply the function-call inputs to the referenced model are the function-call initiators in the top model.

Top model function-call initiators that drive function-call blocks in the referenced export-function model can have different sample times. You can also mux function-call initiator blocks with different sample times before feeding them to the referenced export-function model. In the Solver pane of the Configuration Parameters dialog box, when you clear the **Treat each discrete rate as a separate task** check box, function-call initiator blocks with smaller sample times execute first.

The sample time of function-call initiators must be an integer multiple of the sample time of the corresponding data inputs to the export-function model. The initiators must invoke a function-call subsystem in an export-function model at simulation times that are integer multiples of the sample time of the function-call root-level Inport block of the subsystem.

When you mux function-call initiator blocks in the top-level model, the function-call blocks they invoke do not receive the name of the initiator.

### Control Export Function Scheduling Using Sample Time

You can use the sample time of each export function call in your model to control the scheduling of triggers. In the following example, the order of the function-call triggers is determined by the sample times of their corresponding export-function blocks.

In this example, the function calls are scheduled based on the sample time specified on the function-call port. Based on the color coded display, `onesecond` (F0) executes every 0.1 time steps while function `twoseconds` (F1) executes every 0.2 time steps.

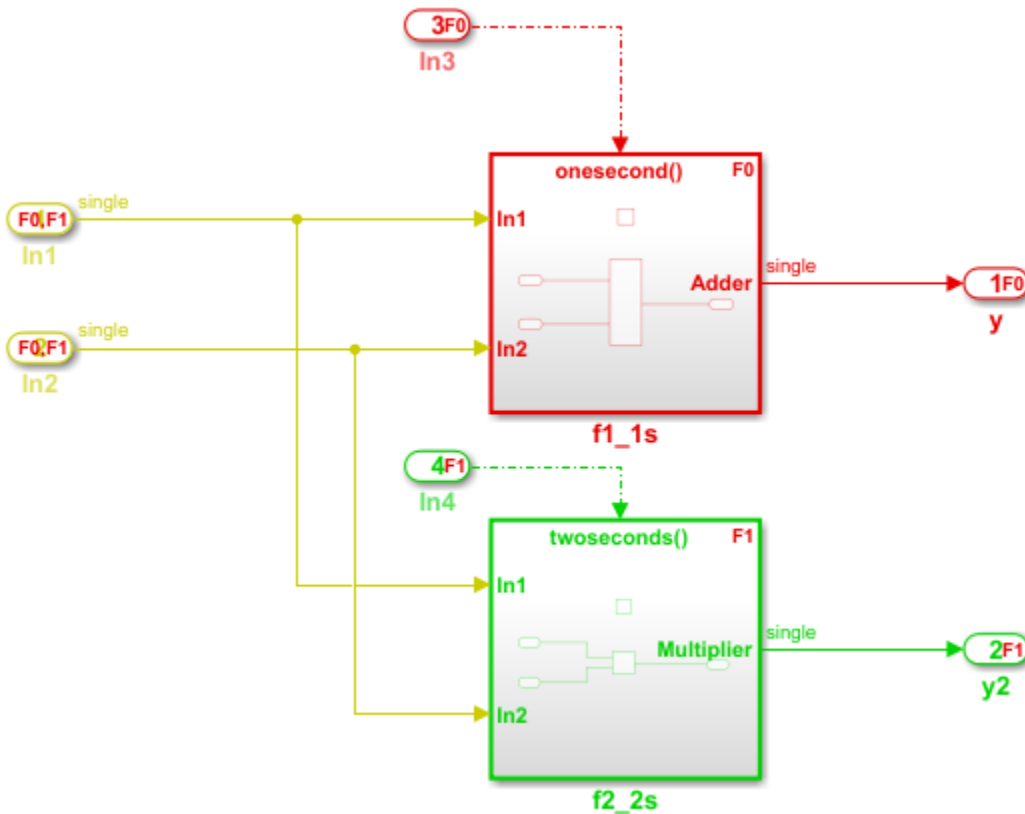

You specify the sample time on the root-level function-call input ports.

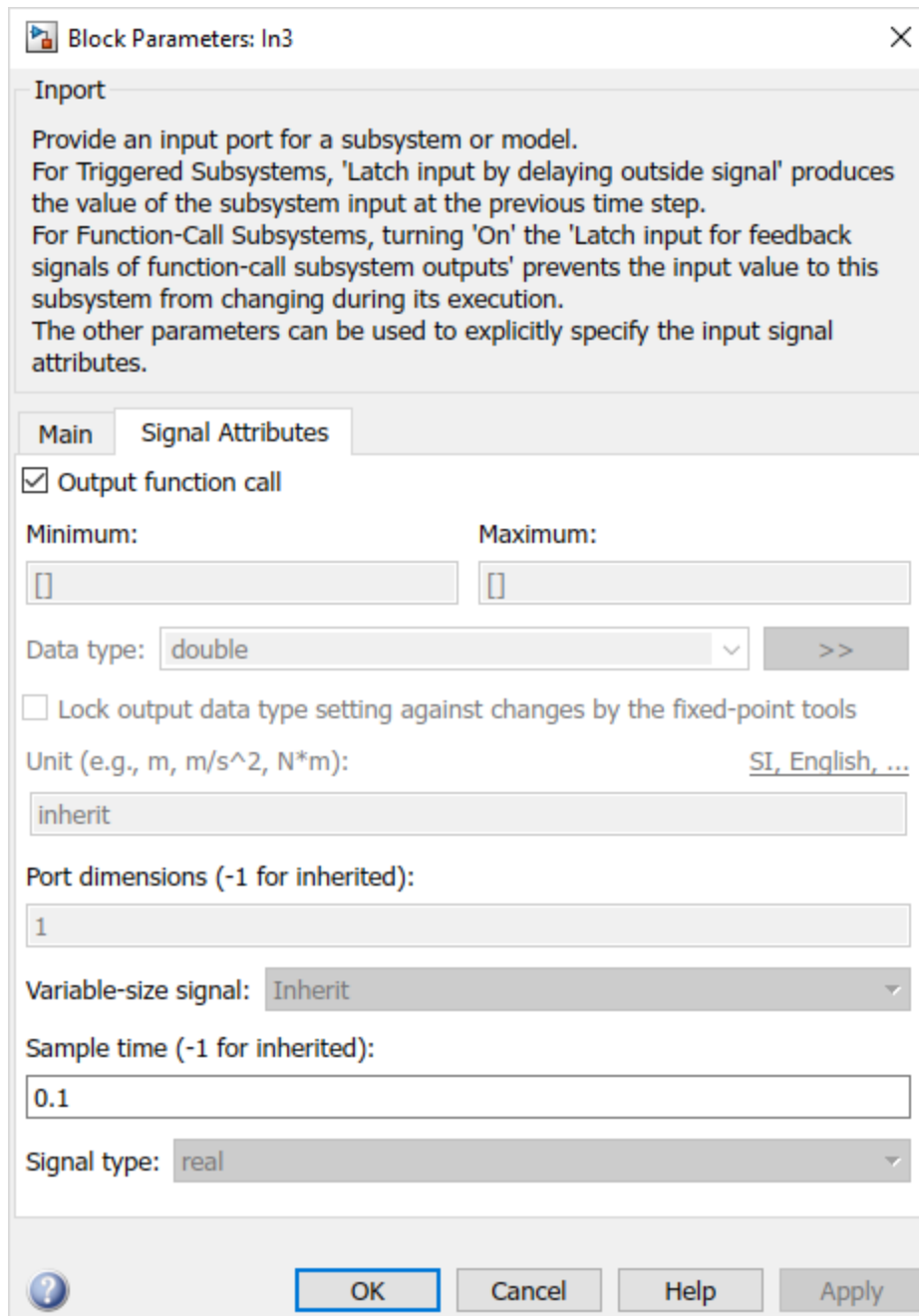

Using the sample time, you can have more fine-grained control over how function-call triggers are scheduled in your model.

When two blocks have different values for the **Sample time** parameter, the block with the lower priority executes first. If the **Priority** parameter is equal, the block with the faster rate executes first. If **Priority** and sample time are the same for both of the blocks, the block with the lower port number executes first.

## Execution Order for Function-Call Root-Level Inport Blocks

You can display the sorted execution order to interpret simulation results. This display has no impact on generated code. To display the sorted execution order, select **Display > Blocks > Sorted Execution Order**. In the following example, notice the sorted order for both the function-call triggers. Based on sorted order display labels, **fcIn1 (F0)** executes before **fcIn2 (F1)** when both have a sample hit at the same time step.

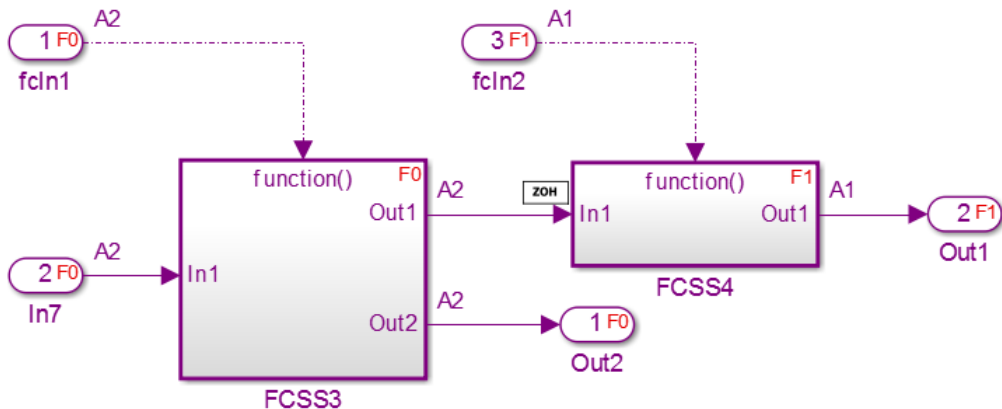

The referenced export-function model in the top model shows the local execution order of the Inport and Outport blocks in the model.

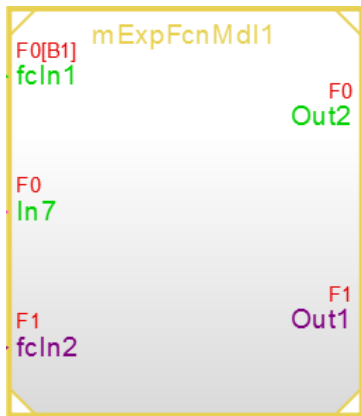

Simulink compares Inport block properties to determine their relative execution order. Simulink checks the block properties in this order:

- 1 Priority (lower priority executes first)
- 2 Sample time (smaller sample time executes first)
- 3 Port number (smaller port number executes first)

When two blocks have different values for the **Priority** parameter, the block with the lower priority executes first. If the **Priority** parameter is equal, the block with the faster rate executes first. If **Priority** and sample time are the same for both of the blocks, the block with the lower port number executes first. This example shows how relative execution order is calculated.

---

**Note:** When the simulation mode of the top model is **Accelerator** or **Rapid Accelerator**, Simulink does not perform run-time checks for the execution order of function-call root-level Inport blocks inside referenced export-function models.

---

### Determine Relative Execution Order

Suppose that an export function model has five function-call root-level Inport blocks, A to E, with block properties as shown in the table. To determine their relative execution order, Simulink compares their sample times (if distinct and noninherited), **Priority** parameter, and port number, in order.

function-call root-level Inport	A	B	C	D	E
Priority	10	30	40	40	30
Sample Time	-1	0.2	0.1	0.1	-1
Port Number	5	4	3	2	1

Block A has the lowest priority of all five blocks. A executes first.

Using the same logic, B and E execute after A but before C and D. Since B and E have the same priority, Simulink compares their sample time to determine execution order. E has a sample time of -1 (inherited), which is smaller than 0.2, the sample time of B. E executes before B.

C and D have the same priority and the same distinct, noninherited sample times. The port number for D (2) is smaller than C (3), D executes before C.

The relative execution order of these Inport blocks, then, is A, E, B, D, and C.

### Scheduling Restrictions for Referenced Export-Function Models

If a top model references an export-function model, there are restrictions on function-call subsystems within the export-function model. These restrictions ensure consistency with standalone simulation results.

- In the top model, the same function-call initiator must output function-calls originating with the same sample time. You cannot use two function-call initiators with the same sample time. You cannot disable this restriction.
- The function-call inputs from the top model must follow the execution order of the function-call Inport blocks in the referenced export-function model. You can disable this restriction.
- The sample time of the function-call root-level Inport block must be inherited (-1) or match the sample time of the function-call initiator block that drives it. If you disable this restriction, the sample time of the function-call root-level Inport block must be inherited (-1) or an integer multiple of the sample time of the function-call initiator block.

To disable the restrictions, clear the check box **Model Configuration Parameters > Model Referencing > Enable strict scheduling checks for referenced export-function models**.

An error appears if the top model calls the referenced model functions out of order at any time step. For information on sorted execution order, see “Control and Display the Sorted Order” on page 34-27.

### **Data Transfer Between Function-Call Subsystems**

You must know the timing of the data being transferred between function-call subsystems to understand and interpret simulation results.

To display which subsystem executes first during simulation, the signal lines are annotated with different symbols at the input ports of the subsystems:

- **ZOH** indicates that all source function-call subsystems execute before the function-call block reading this signal.
- **1/z** indicated that all source function-call subsystems execute after the function-call block reading this signal.
- **Mixed** indicates that some source function-call subsystems execute before and some function-call subsystems execute after the function-call block reading this signal.

In the block diagram, notice the sorted execution order for each block. We can see that for the input port **In1** of subsystems **FCSS3** (F1), the source subsystem **FCSS1** (F0) executes before **FCSS3** (F1). Hence, a badge of **ZOH** is added next to **In1**. Similarly, **FCSS2** (F2) executes after **FCSS3** (F1). Hence, Simulink adds a badge of **1/z** next to **In3** of subsystem **FCSS3** (F1). Port **In2** inputs signals from both **FCSS1** (F0) and **FCSS2** (F2). Hence, it has a badge **Mixed** next to it.



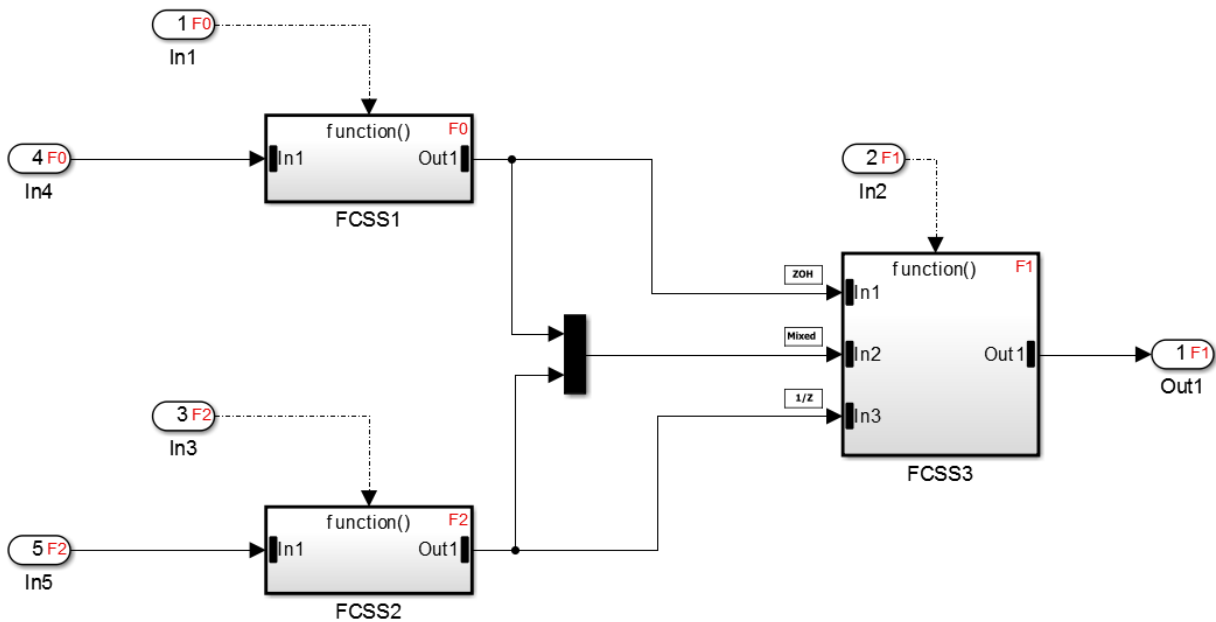

You can latch Inport blocks in function-call subsystems to ensure data integrity. If your function-call subsystems have Inport blocks that are latched, then the root-level data Inport block of the export-function model is latched only if all the data Inport blocks it is feeding to are latched. For more information, see “Latch input for feedback signals of function-call subsystem outputs”.

When referencing an export function model or a model with asynchronous function-call inputs, the data input to the referenced model is latched if all function-call block inputs it feeds inside the referenced model are latched.

---

**Note:** Data transfer signals are unprotected in the generated code by default. You must prevent data corruption in these signals due to pre-emption in the target environment or implementing protection using custom storage classes.

---

## Workflows for Export-Function Models

The most common workflow is to test function-call behavior through simulation and generate the functions using standalone code generation.

### Standalone Simulation

When function-call sequencing is simple enough to be specified as a model input, standalone simulation is the preferred workflow. For a standalone simulation, create data sets for the function-call and data root-level Inport blocks. For more information on function-call inputs, see “Specifying Function-Call Inputs” on page 10-64.

You can also specify the execution order for function-call subsystems. For more information, see “Execution Order for Function-Call Root-Level Inport Blocks” on page 10-59.

### Specifying Function-Call Inputs

You can create data sets for the function-call and data root-level Inport blocks in **Simulation > Model Configuration Parameters > Data Import/Export > Input**.

For function-call inputs, specify a time-vector indicating when events occur.

- The time vector data type must be double and monotonically increasing.
- All time data must be integer multiples of the model sample time.
- To specify multiple function-calls at a given time step, repeat the time value accordingly. For example, to specify three events at  $t = 1$  and 2 events at  $t = 9$ , list 1 three times and 9 twice in your time vector,  $\mathbf{t} = [1\ 1\ 1\ 9\ 9]'$ .

The normal data input can use any other supported format as described in “Forms of Input Data” on page 59-151.

Consider the following export-function model with one function-call input port **fcIn1** and one data input **In2**.

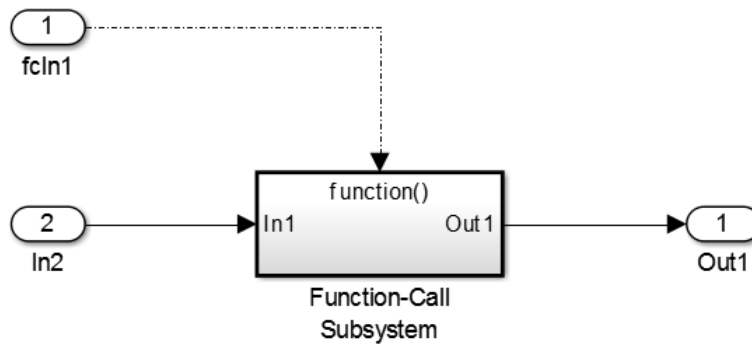

In the **Configuration Parameters > Data Import/Export** pane, set the **Input** parameter to  $t$ ,  $tu$ .

$t$  is a column vector containing the times of events for the Inport block.  $tu$  is a table of input values versus time for the In2 block.

The table describes how to specify the vector  $t$ .

	Root-level Inport block with inherited sample time (-1) specified	Root-level Inport block with discrete sample time specified
<b>Function-call subsystem trigger port sample time type is Periodic</b>	Not applicable	Use an empty matrix ( <code>[]</code> ). The function-call subsystem executes at every sample time hit of the root-level Inport block invoking it.
<b>Function-call subsystem trigger port sample time type is Triggered</b>	Use a nondecreasing column vector. Each element in the column vector must be an integral multiple of the fundamental sample time of the model. The function-call subsystem executes at the times specified by the column vector.  If you specify an empty matrix ( <code>[]</code> ), the function-	Use a nondecreasing column vector. Each element in the column vector must be an integral multiple of discrete sample time of the function-call root-level Inport block. The function-call subsystem executes at the times specified by the column vector.

	Root-level Inport block with inherited sample time (-1) specified	Root-level Inport block with discrete sample time specified
	call subsystem does not execute.	Alternatively, specify an empty matrix ([ ]), and the function-call subsystem executes at every sample time hit.

### Top-Model Simulation Using Model Reference

The more common simulation workflow of export-function models is by referencing export-function models. When function-call sequencing is too complicated to specify with data sets in a standalone simulation, create a harness top model to mimic target environment behavior. Use this top model to give inputs to the export-function model. There are two forms to mimic behavior of the scheduling environment:

- Common function-call initiator, in which you fully control the scheduling process. Use Stateflow or S-functions to create arbitrary call sequences.

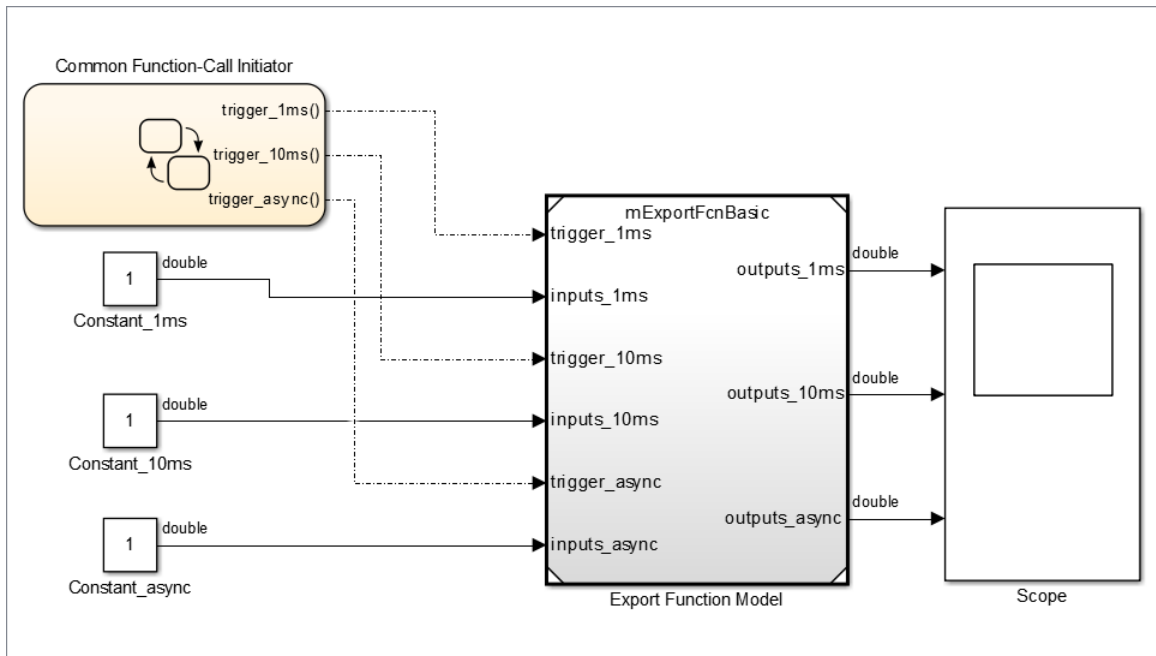

**Note:** Simulink does not simulate pre-empting function-calls.

- Multiple function-call initiators with distinct sample times: Use Simulink scheduling for simulation, which is useful when the rate monotonic scheduling behavior in Simulink is similar to the target OS behavior.

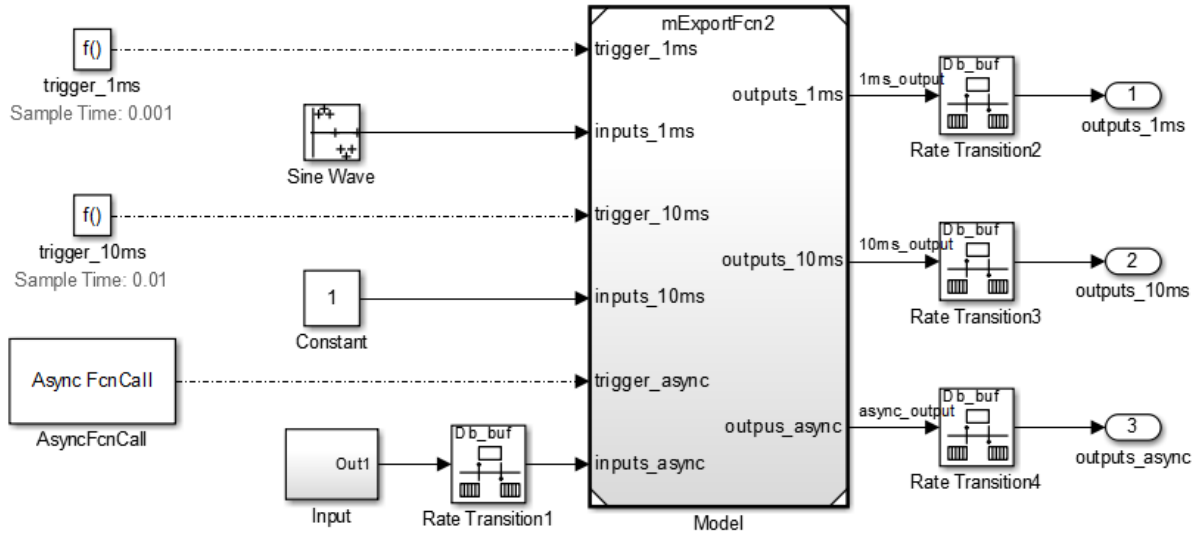

---

**Note:** When using export-function models in top-model simulations, do not change the enable/disable status of the model during the simulation. Enable it at the start of the simulation and use function-calls to call it.

---

### Standalone Code Generation

For standalone code generation, specify an ERT code-generation target, such as `ert.tlc`, and select **Code > C/C++ Code > Build Model** to generate code. In the generated code, each function-call root Inport generates a void-void function. The function name for each function-call root Inport block is the name of the output function-call signal of the block. If there is no signal name, then the function name is derived from the name of the root Inport block. Building the model generates a model initialization function but does not generate a model step function or an enable/disable function.

To customize the model initialize function name for the referenced export-function model, open the top model and complete these steps:

- Select **Model Configuration Parameters > Code Generation > Interface**.
- Click **Configure Model Functions**.
- In the Model Interface dialog box, set **Function specification** to **Model specific C prototypes** and click **Validate**.
- Type the function name in the **Initialize function** name text box and click **Apply**.
- Generate code again to see the new function name.

## Nested Export-Function Models

Nested export-function models provide an additional layer of organization for your model. The schematic explains how you can export functions at the vehicle level or the individual feature level.

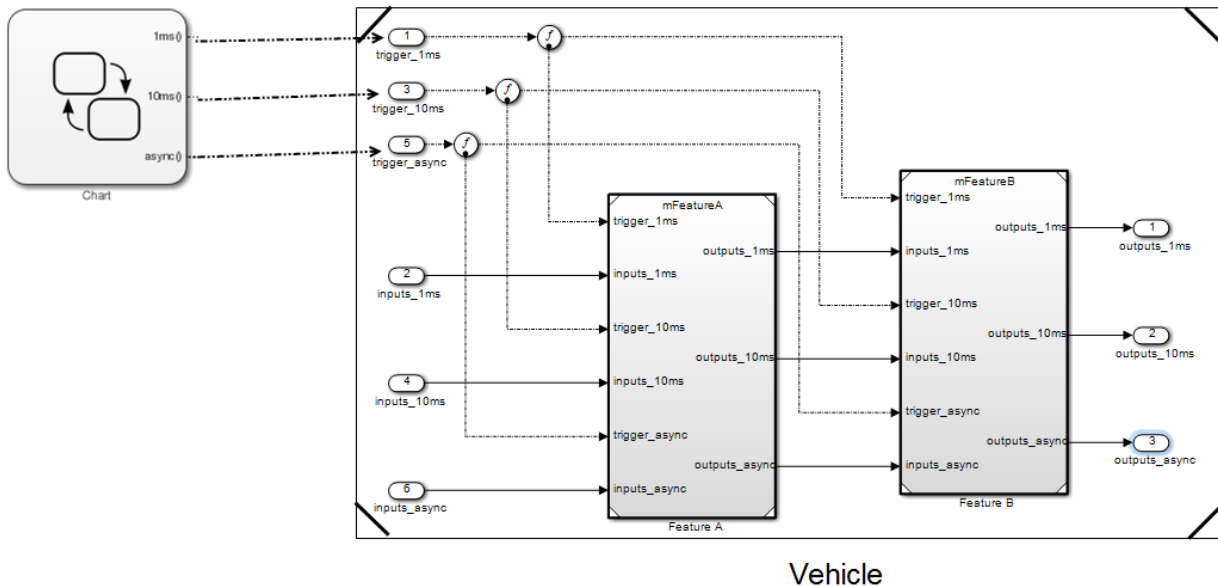

**Note:** An export-function model cannot contain a model with asynchronous function-call inputs, but can contain function-call subsystems and function-call models. A model with asynchronous function-call inputs can contain an export-function model, function-call subsystem, or a function-call model.

## Comparison Between Export-Function Models and Models with Asynchronous Function-Call Inputs

An export-function models capability is available for models with asynchronous function-call inputs. You use these models primarily in the Simulink environment where the Simulink scheduler calls generated functions.

	<b>Export-Function Models</b>	<b>Models with Asynchronous Function-Call Inputs</b>
Definition	These models have function-call root-level Inport blocks that are not connected to an Asynchronous Task Specification block. These Inport blocks trigger function-call subsystems or referenced models with function-call trigger inputs.	These models have function-call root-level Inport blocks connected to Asynchronous Task Specification blocks. These Inport blocks trigger function-call subsystems or referenced models with function-call trigger inputs.
Root-level blocks	Only blocks executing in a function-call context are allowed at the root level.	Blocks executing in a non-function-call context are also allowed.
Data transfer	Use data transfer indicators to interpret simulation results. Data transfer in export-function models is not protected by default in generated code. For more details, see “Data Transfer Between Function-Call Subsystems” on page 10-62.	Use Rate Transition blocks to protect data transferred between function-call subsystems running at different rates. For more information, see Rate Transition.
Simulation support	These models support standalone simulation and top-model simulation in all simulation modes.	These models support top-model simulation in all simulation modes and standalone simulation in normal, accelerator, and rapid accelerator modes.
Code generation support	Top-model and standalone code generation is supported.	Top-model and standalone code generation is supported.



## **See Also**

### **Blocks**

Function-Call Subsystem

## **More About**

- “Control and Display the Sorted Order” on page 34-27

## Resettable Subsystems

### In this section...

“Behavior of Resettable Subsystems” on page 10-72

“Comparison of Resettable Subsystems and Enabled Subsystems” on page 10-75

### Behavior of Resettable Subsystems

Use resettable subsystems when you want to conditionally reset the states of all blocks within a subsystem to their initial condition. A resettable subsystem executes at every time step but conditionally resets the states of blocks within it when a trigger event occurs at the reset port. This behavior is similar to the reset behavior of blocks with reset ports, except that a resettable subsystem resets the states of all blocks inside it.

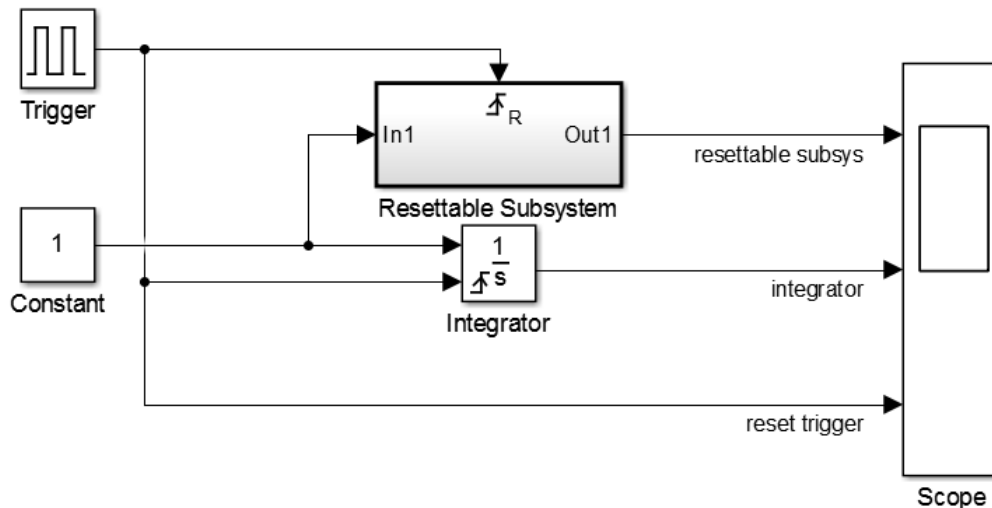

Using resettable subsystems over other methods of resetting states of your block or subsystem has these advantages:

- When you want to reset the states of multiple blocks in a subsystem, displaying and connecting the reset port of each block is cumbersome and makes the block diagram

hard to read. Instead, place all the blocks in a resettable subsystem and configure the Reset block in the subsystem.

- Some blocks, such as the Discrete State-Space block, have states but do not have reset ports. You cannot reset these blocks individually, and you must reset the subsystem they are inside. In such cases, it is useful to place these blocks in a resettable subsystem.
- You can also reset blocks in enabled subsystems by setting the **States when enabling** parameter on the enable port to **reset**. However, for this behavior, you must disable the subsystem and then reenabling it at a later time step. To reset your block states at the same time step, use resettable subsystems. For more information, see “Comparison of Resettable Subsystems and Enabled Subsystems” on page 10-75.

All blocks in a resettable subsystem must have the same sample time, and they execute at every sample time hit of the subsystem. Resettable subsystems and the model use a common clock.

This model shows that the behavior of block reset ports and resettable subsystems is the same. A resettable subsystem enables you to reset the states of all blocks inside it. The resettable subsystem contains an integrator block that is configured similar to the root-level Integrator block, but the block does not have a reset port. The subsystem resets the states of the integrator block inside it in the same manner as the reset port of the Integrator block. You can see this behavior by running the model and viewing the output in the scope.

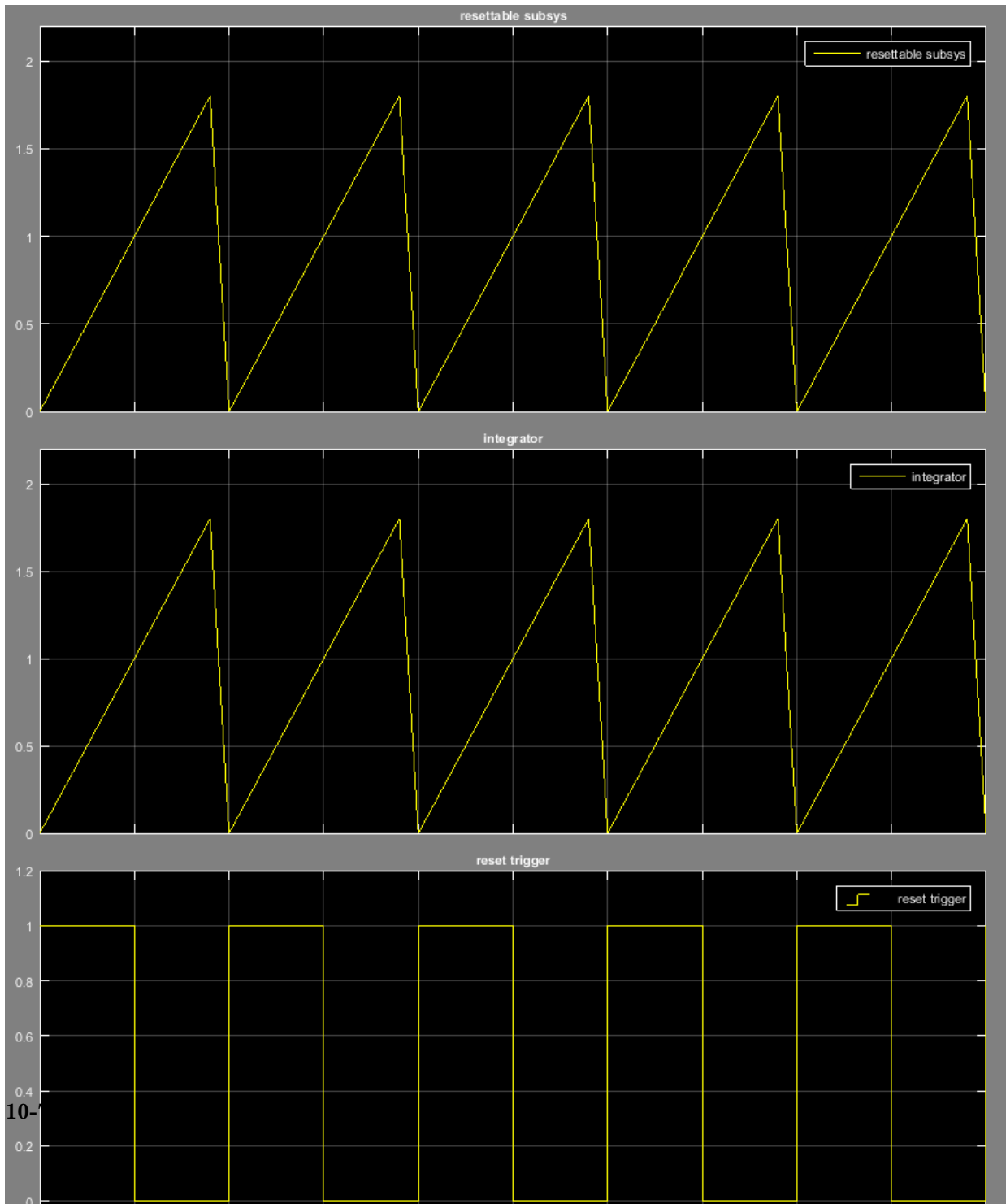

## Comparison of Resettable Subsystems and Enabled Subsystems

If you set **States when enabling** for the Enable block to **reset**, the enabled subsystem resets the states of all blocks in the subsystem. However, you must disable the subsystem for at least one time step and then reenable it for the states to reset.

In contrast, resettable subsystems always execute and reset the states of their blocks instantaneously.

This model shows the difference in the execution behavior of these subsystems. It contains an enabled subsystem and a resettable subsystem whose control ports are connected to pulse generator. The resettable subsystem is set to reset on the rising edge of the control signal, and the enabled subsystem has the **States when enabling** parameter set to **reset** in the enable port.

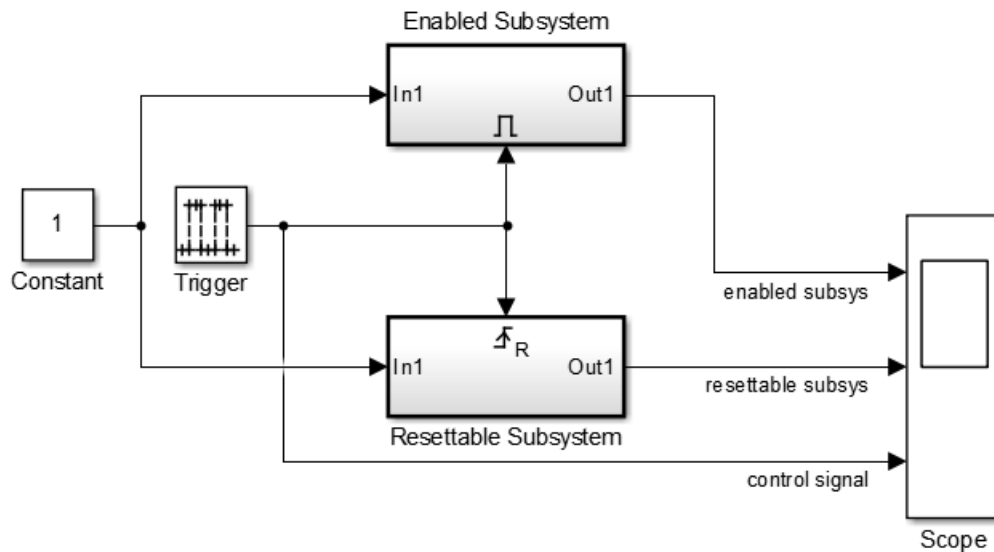

The subsystems contain identical Discrete-Time Integrator blocks, whose input is the Constant block at the root level of the model. The figure shows the contents of the resettable subsystem.

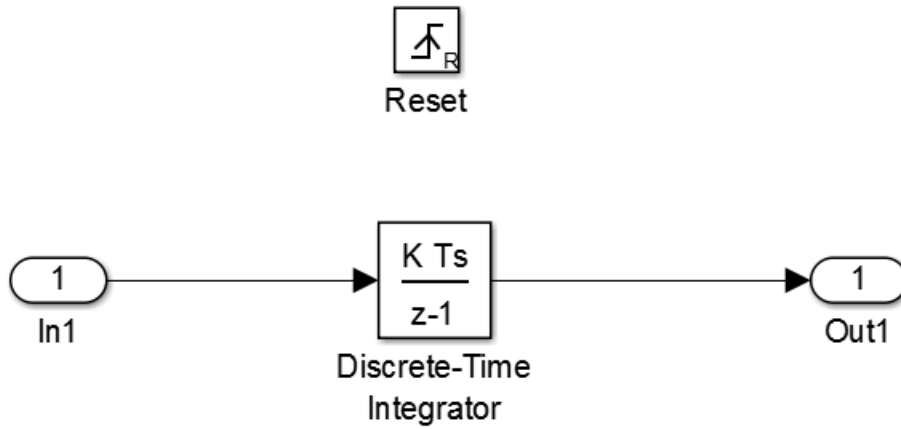

The figure shows the simulation output.

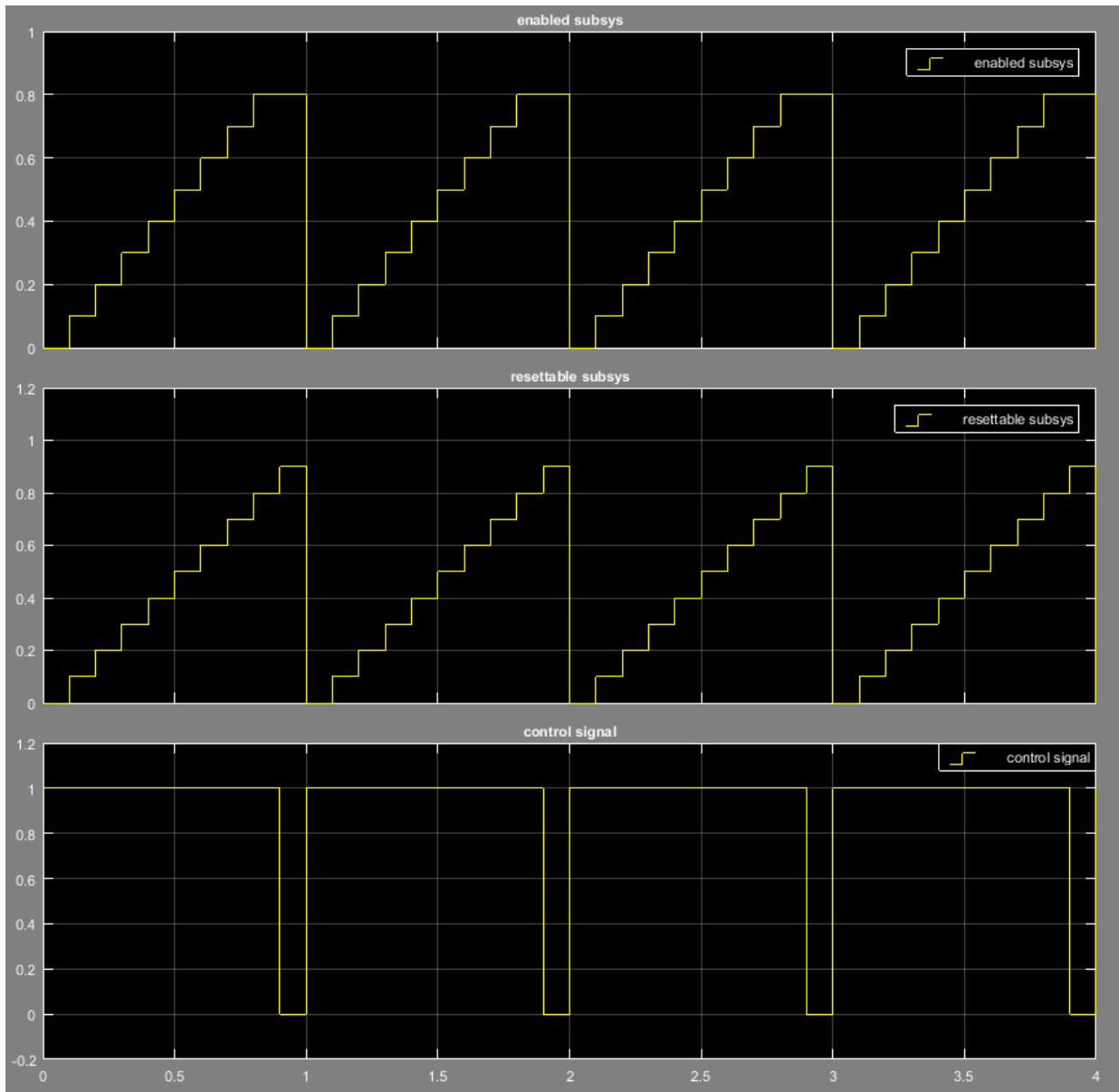

When the control signal is 0, the enabled subsystem is disabled and the integrator does not change its output while the resettable subsystem is executing. The rising edge of the control signal triggers the reset port of the resettable subsystem and enables the enabled subsystem. Both subsystems reset their states at this time step.

Notice that the enabled subsystem is disabled for at least one time step before its states can be reset. The resettable subsystem does not have this limitation.

### See Also

#### Blocks

Enabled Subsystem | Resettable Subsystem

### More About

- “Conditional Subsystems” on page 10-2
- “Enabled Subsystems” on page 10-4



## Action Subsystem

### In this section...

“What Are Action Subsystems?” on page 10-79

“Set States When an Action Subsystem Executes” on page 10-80

### What Are Action Subsystems?

Action subsystems are subsystems that execute in response to a conditional output from an If block or a Switch Case block. In essence, they are subsystems with an Action port, which allow for block execution based on conditional inputs from an If block or Switch Case block.

Simulink has two types of action subsystems, based on the type of block they receive conditional input from.

#### If Action Subsystem

An If Action Subsystem is preconfigured to serve as a starting point for creating a subsystem whose execution is triggered by an If block. To implement an if-else condition, connect If Action Subsystem blocks to the outputs of an If block.

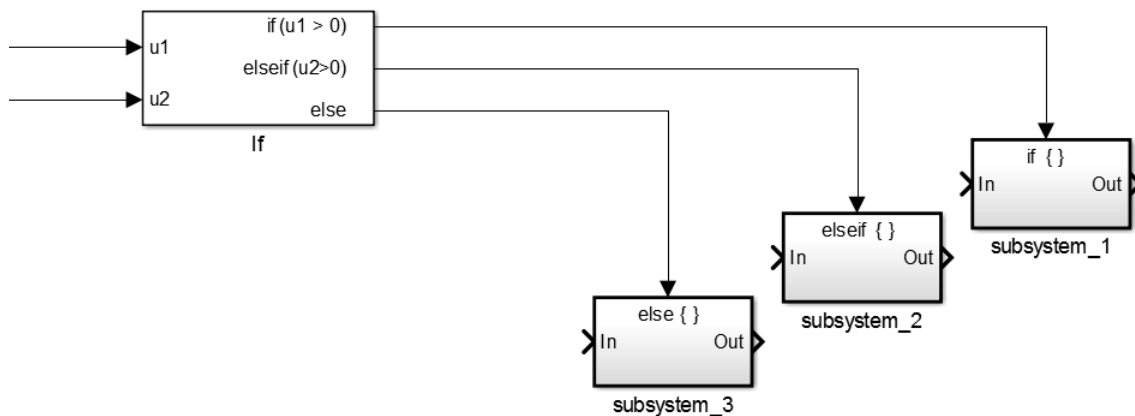

### Switch Case Action Subsystem

The Switch Case Action Subsystem is preconfigured to serve as a starting point for creating a subsystem whose execution is triggered by a Switch Case block. To implement a switch condition, connect Switch Case Action Subsystem blocks to the outputs of a Switch Case block.

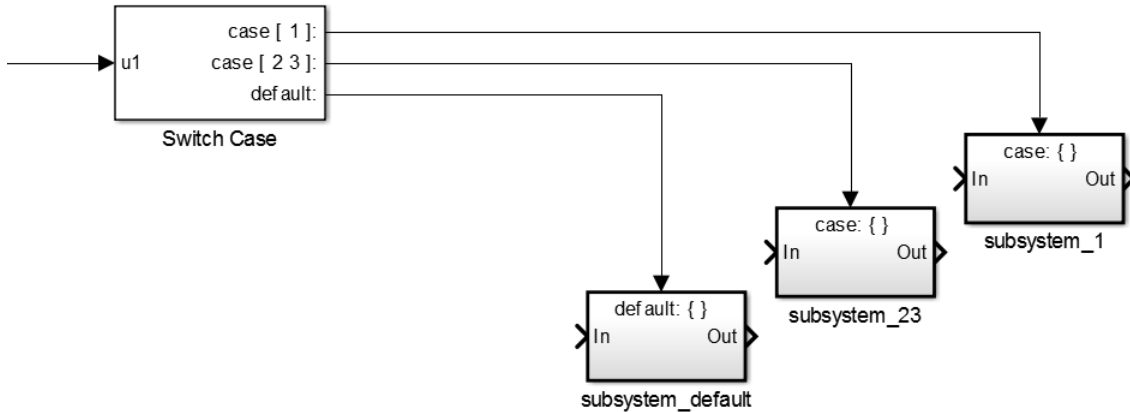

### Set States When an Action Subsystem Executes

When an action subsystem is triggered to execute, you can choose whether to hold the subsystem states at their previous values or reset them to their initial conditions.

- 1 Open the Action Port block inside the action subsystem.
- 2 Select one of the following for the **States when execution is resumed** parameter:
  - **held** if you want the states to maintain their most recent values
  - **reset** if you want the states to revert to their initial conditions

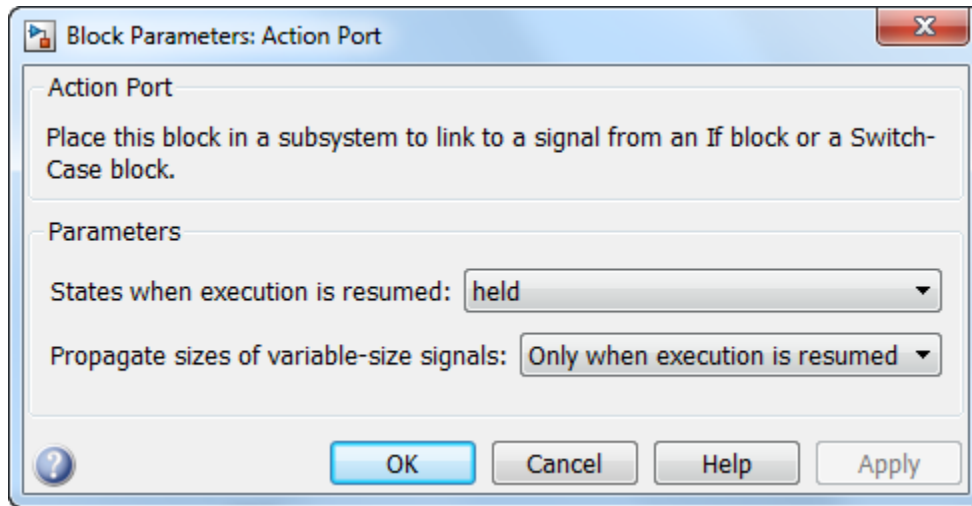

---

**Note:** For nested subsystems whose Action Port blocks have different parameter settings, the settings on the child subsystem dialog box override those setting inherited from the parent subsystem.

---

## See Also

### Blocks

Action Port | If | Switch Case

## More About

- “Conditional Subsystems” on page 10-2

## Simulink Functions

### In this section...

- “What Are Simulink Functions?” on page 10-82
- “What Are Simulink Function Callers?” on page 10-82
- “Connect to Local Signals” on page 10-83
- “Reusable Logic with Functions” on page 10-83
- “Input/Output Argument Behavior” on page 10-84
- “Shared Resources with Functions” on page 10-85
- “How a Function Caller Identifies a Function” on page 10-86
- “Reasons to Use a Simulink Function Block” on page 10-87
- “Choose a Simulink Function or Reusable Subsystem” on page 10-88
- “When Not to Use a Simulink Function Block” on page 10-88
- “Tracing Simulink Functions” on page 10-88

### What Are Simulink Functions?

A Simulink function in a Simulink model is a computational unit that calculates a set of outputs when provided with a set of inputs. The function header uses a notation similar to programming languages such as MATLAB and C++. You can implement a Simulink function in several ways:

- **Simulink Function block** — Function defined using Simulink blocks within a Simulink Function block. See Simulink Function block reference.
- **Stateflow graphical function** — Function defined with state transitions within a Stateflow chart, and then exported to a Simulink model.
- **Stateflow MATLAB function** — Function defined with MATLAB language statements within a Stateflow chart, and then exported to a Simulink model.

### What Are Simulink Function Callers?

A Simulink function caller invokes the execution of a Simulink function. You can call a function from anywhere in a model or chart hierarchy.

- **Function Caller block** — In a Simulink model, calls a function defined in Simulink or exported from Stateflow. See Function Caller block reference.

- **Stateflow chart transition** — In a Stateflow chart, calls functions defined in Simulink or exported from Stateflow.
- **MATLAB Function block** — In a Simulink model, calls a function from a MATLAB language script.

## Connect to Local Signals

In addition to Argument Inport and Argument Outport blocks, a Simulink Function block can interface to signals in the local environment of the block through Inport or Outport blocks. These signals are hidden from the caller. You can use port blocks to connect and communicate between two Simulink Function blocks or connect to root Inport and Outport blocks that represent external I/O.

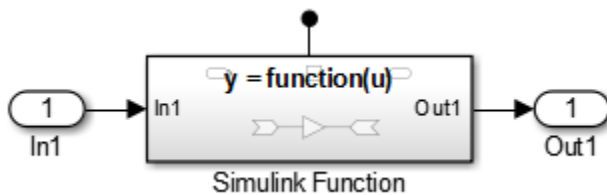

You can also connect the Outport blocks to sink blocks including logging (To File, To Workspace) and viewing (Scope, Display) blocks. However, these blocks execute last after all other blocks.

## Reusable Logic with Functions

Use functions when you need reusable logic across a model hierarchy. Consider an example where a Simulink Function with reusable logic is in a Stateflow chart.

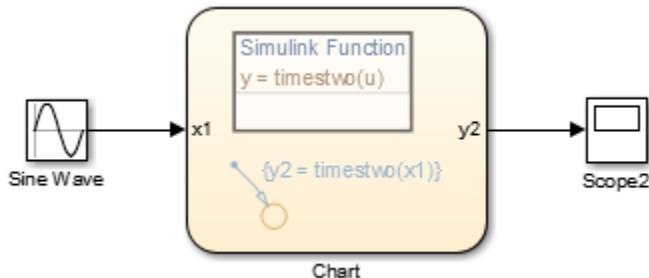

You can move the reusable logic from inside the Stateflow chart to a Simulink Function block. The logic is then reusable by function callers in Simulink subsystems (Subsystem and Model blocks) and in Stateflow charts at any level in the model hierarchy.

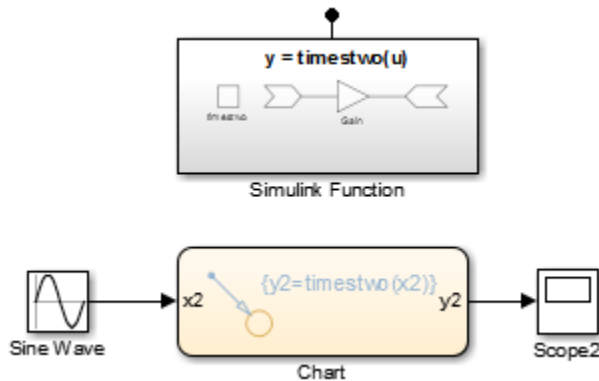

The result is added flexibility for structuring your model for reuse.

---

**Note:** Input and output argument names ( $x_2$ ,  $y_2$ ) for calling a function from a Stateflow chart do not have to match the argument names in the function prototype ( $u$ ,  $y$ ) of a Simulink Function block.

---

## Input/Output Argument Behavior

The function prototype for a Simulink Function block can have identical input and output arguments. For example, a function that filters noise could input a signal and then return the signal after filtering.

```
mySignal = filter(mySignal)
```

You can call the function with a Function Caller block and add noise to a test signal to verify the function algorithm.

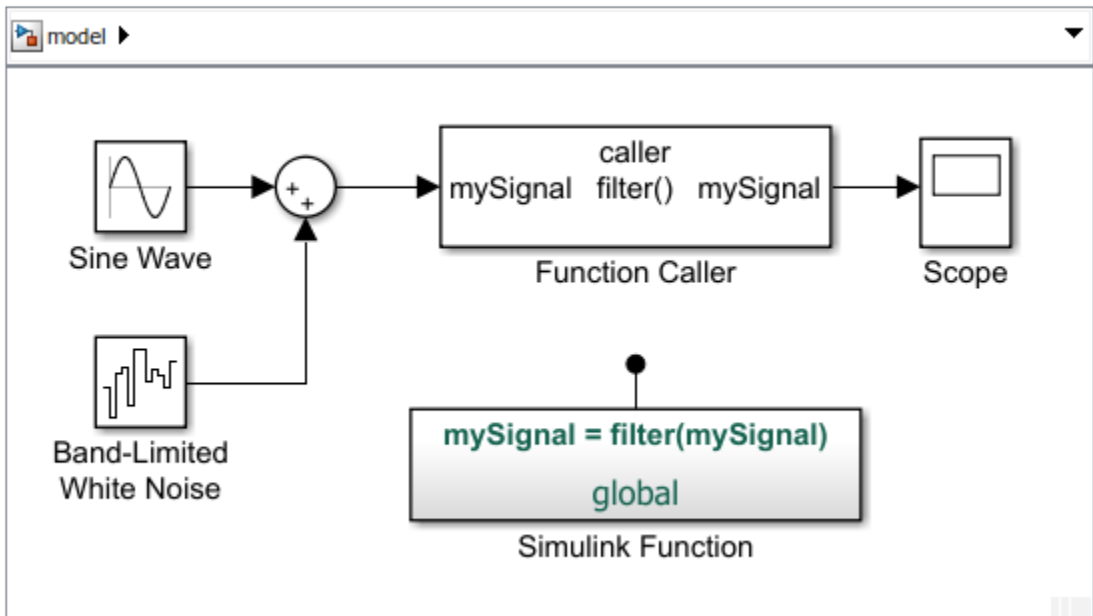

When generating code for this model, the input argument for the Simulink Function block passes a pointer to the signal, not a copy of the signal value.

```
void filter(real_T *rtuy_mySignal)
{
    . . .

    *rtuy_mySignal = model_P.DiscreteFilter_NumCoef * DiscreteFilter_tmp;
}
```

## Shared Resources with Functions

Use functions when you model a shared resource, such as a printer. The model `slexPrinterExample` uses Simulink Function blocks as a common interface between multiple computers and a single Stateflow chart that models a printer process.

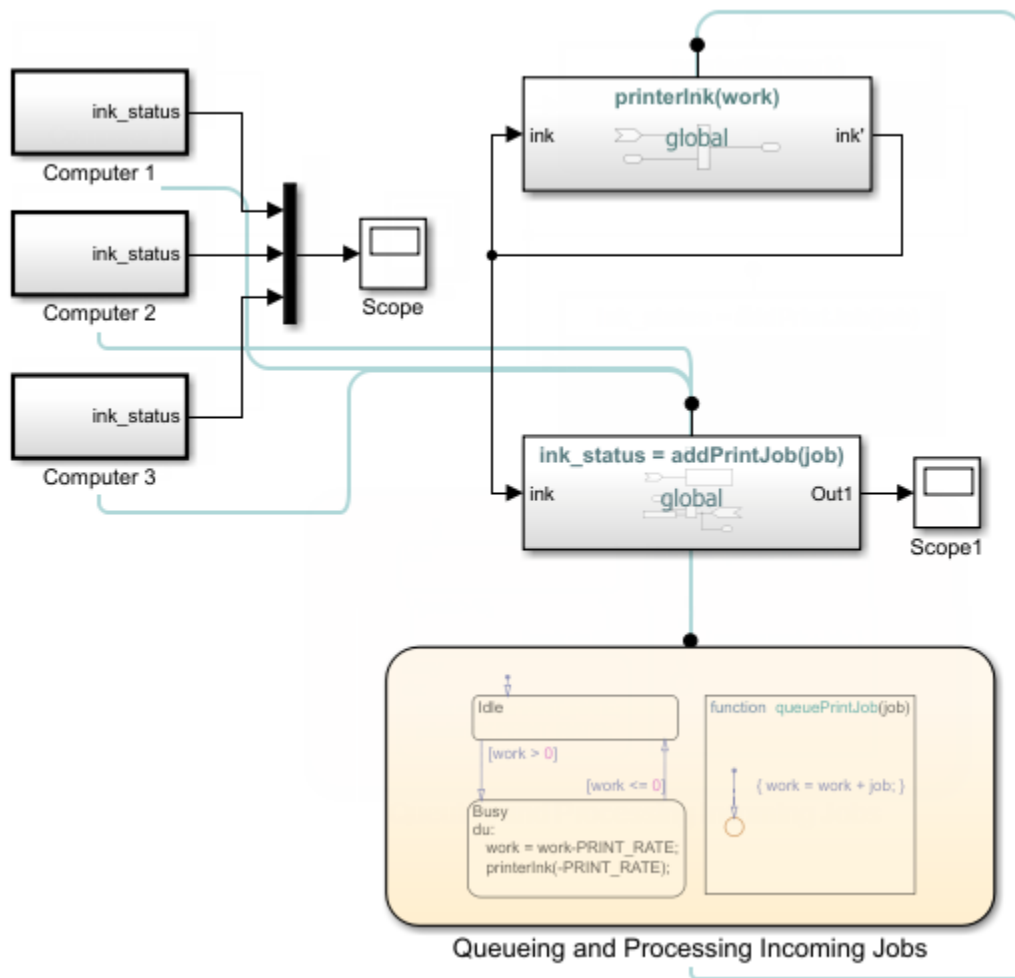

## How a Function Caller Identifies a Function

The function interface uses MATLAB syntax to define the name of a function and its input and output arguments. The model hierarchy can contain only one function definition with the identified function name. Simulink verifies that:



- The arguments in the **Function prototype** parameter for a Function Caller block matches the arguments specified in the function. For example, a function with two input arguments and one output argument appears as:

```
y = MyFunction(u1, u2)
```

- The data type, dimension, and complexity of the arguments must agree. For a Function Caller block, you can set the **Input argument specifications** and **Output argument specifications** parameters, but usually you do not need to specify these parameters manually. Simulink derives the specification from the function.

The only case where you must specify the argument parameters is when the Function Caller block cannot find the function in the model or in any child model it references. This situation can happen when the Functions Caller block and called function are in separate models that referenced by a common parent model. See “Simulink Functions in Referenced Models” on page 10-116 and “Argument Specification for Simulink Functions” on page 10-111.

## Reasons to Use a Simulink Function Block

Function-Call Subsystem blocks with direct signal connections for triggering provide better signal traceability than Simulink Function blocks, but Simulink Function blocks have other advantages.

- **Eliminate routing of signal lines.** The Function Caller block allows you to execute functions defined with a Simulink Function block without a connecting signal line. In addition, functions and their callers can reside in different models or subsystems. This approach eliminates signal routing problems through a hierarchal model structure and allows greater reuse of model components.
- **Use multiple callers to the same function.** Multiple Function Caller blocks or Stateflow charts can call the same function. If the function contains state (e.g., a Unit Delay block), the state is shared between the different callers.
- **Separate function interface from function definition.** Functions separate their interface (input and output arguments) from their implementation. Therefore, you can define a function using a Simulink Function block, an exported graphical function from Stateflow, or an exported MATLAB function from Stateflow. The caller does not need to know how or where the function was implemented.

## Choose a Simulink Function or Reusable Subsystem

A consideration for using a Simulink Function block or a Subsystem block has to do with shared state between function calls. A Simulink Function block has shared state while a Subsystem block, even if specified as a reusable function, does not.

- For a Simulink Function block, when one block has multiple callers, code is always generated for one function. If the Simulink Function block contains blocks with state (for example, Delay or Memory), the state is persistent and shared between function callers. In this case, the order of calls is an important consideration.
- For a Subsystem block, when a block has multiple instances and is configured as a reusable function, code is usually generated for one function as an optimization. If the Subsystem block contains blocks with state, code is still generated for one function, but a different state variable is passed to the function. State is not shared between the instances.

## When Not to Use a Simulink Function Block

Simulink Function blocks allow you to implement functions graphically, but sometimes using a Simulink Function block is not the best solution.

For example, when modeling a PID controller or a digital filter and you have to model the equations defining the dynamic system. Use an S-Function, Subsystem, or Model block to implement systems of equations, but do not use a Simulink Function block, because these conditions can occur:

- **Persistence of state between function calls.** If a Simulink Function block contains any blocks with state (for example, Unit Delay or Memory), then their state values are persistent between calls to the function. If there are multiple calls to that function, the state values are also persistent between the calls originating from different callers. For more on this topic, see “Call a Simulink Function Block from Multiple Sites” on page 10-107.
- **Inheriting continuous sample time.** A Simulink Function block cannot inherit a continuous sample time. Therefore, do not use this block in systems that use continuous sample times to model continuous system equations.

## Tracing Simulink Functions

Visually display connections between a Simulink function and their callers with lines that connect callers to functions:

- Turning on/off tracing lines — From the Simulink Editor menu, select **Display > Function Connectors**.
- Direction of tracing lines — Lines connected at the bottom of a block are from a function caller. Lines connected at the top of a block are to a Simulink function or a subsystem containing the function.

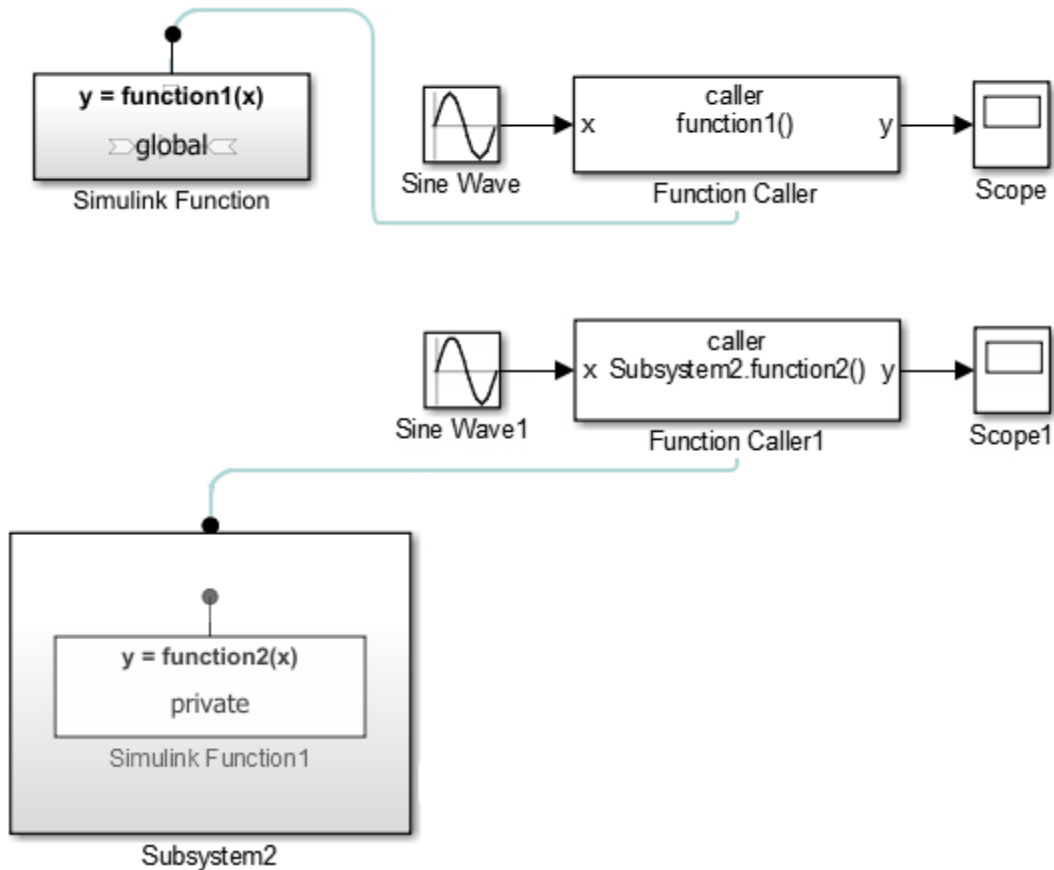

- Navigation to functions — A function caller can be within a subsystem.

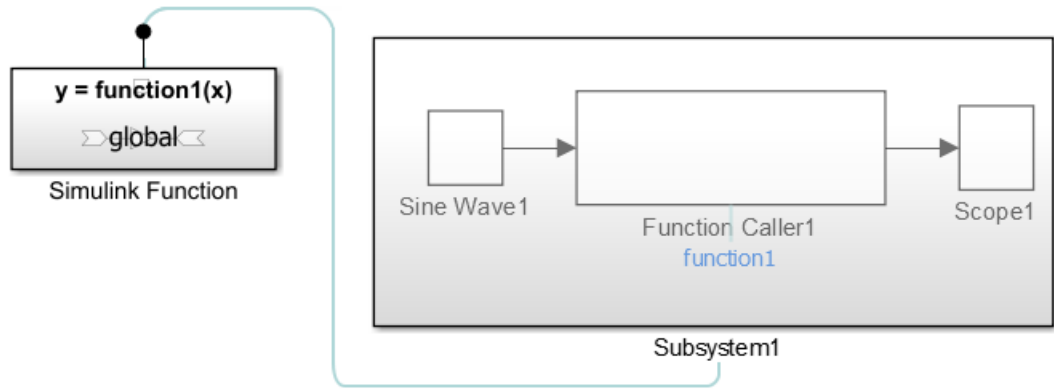

Navigate from a caller in a subsystem to a function by first opening the subsystem, and then clicking a link to the function.

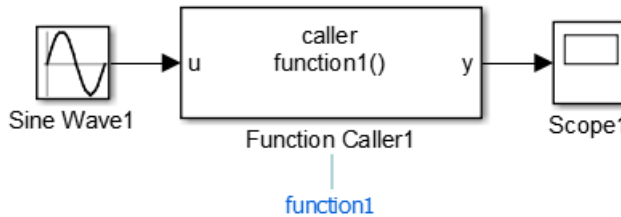

If the function is at the root level of a model, the function opens. If the function is within a subsystem, the subsystem containing the function opens.

### Monitor Ink Status on a Shared Printer Using Simulink Functions

After selecting **Display > Function Connectors**, the model `slexPrinterExample` shows the relationships between callers and functions.

In this example, the Function Caller in the Simulink Function block `addPrintJob`, calls the exported Stateflow function `queuePrintJob`. The subchart `Busy` calls the Simulink Function block `printerInk`. Tracing lines are drawn into and out of the Stateflow chart.

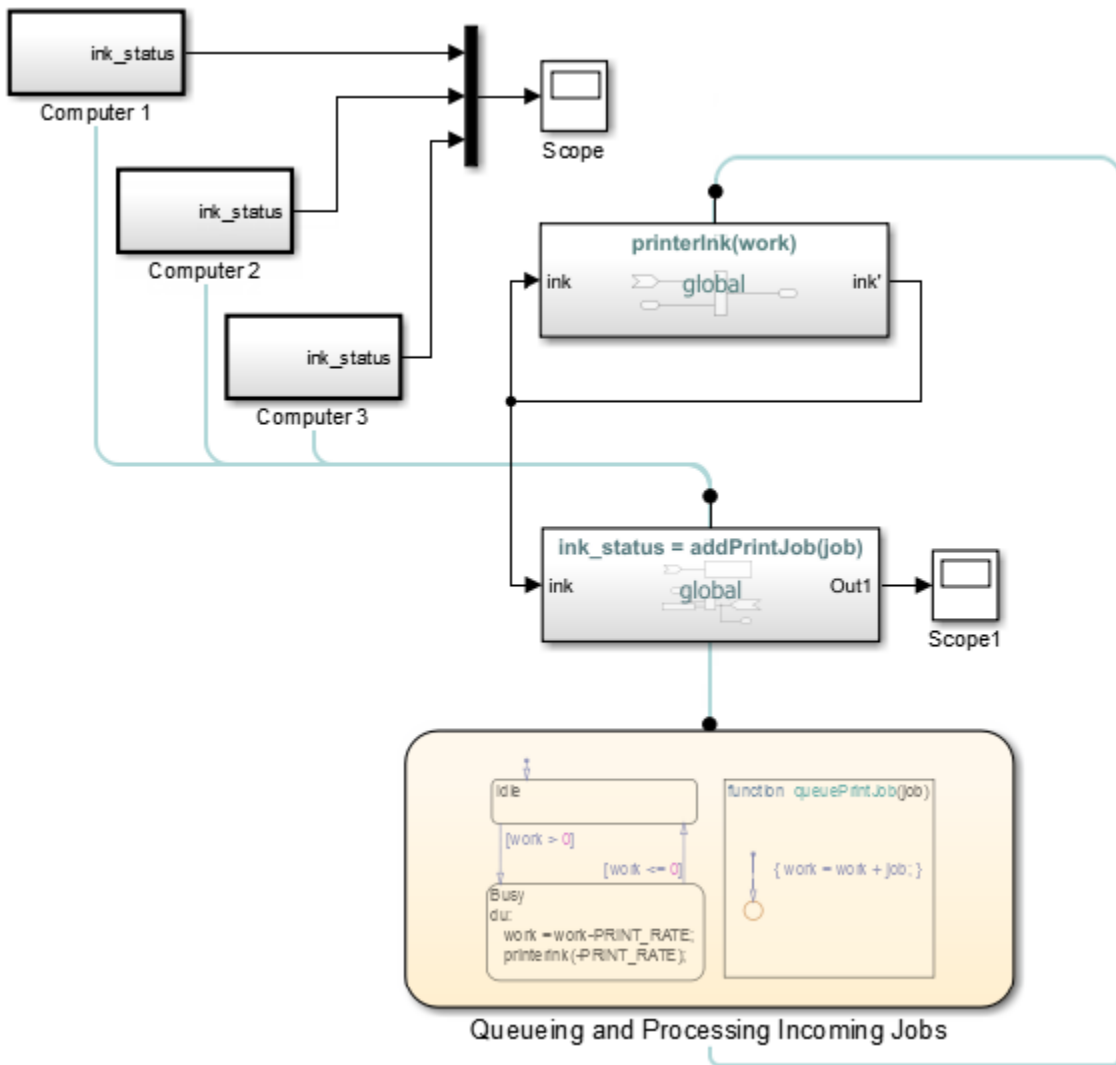

## See Also

### Blocks

Argument Inport | Argument Outport | Function Caller | MATLAB Function | Simulink Function

### **Related Examples**

- “Simulink Functions” on page 10-82
- “Simulink Functions in Models” on page 10-93
- “Argument Specification for Simulink Functions” on page 10-111
- “Simulink Functions in Referenced Models” on page 10-116
- “Private Scoping of Simulink Functions” on page 10-125
- “Diagnostics Using a Client-Server Architecture” on page 10-130

# Simulink Functions in Models

## In this section...

- “Create Simulink Functions in a Simulink Model” on page 10-93
- “Call Simulink Functions with a Function Caller Block” on page 10-100
- “Call Simulink Functions from a MATLAB Function Block” on page 10-103
- “Call Simulink Functions from a Stateflow Chart” on page 10-105
- “Call a Simulink Function Block from Multiple Sites” on page 10-107

## Create Simulink Functions in a Simulink Model

Simulink functions have a function interface with input and output arguments similar to programming languages. You create the function definitions:

- Graphically, using Simulink blocks in a Simulink Function block, or Stateflow state transitions in a graphical function exported from a Stateflow chart.
- Textually, using MATLAB code in a MATLAB function exported from a Stateflow chart.

### Simulink Function Block

Set up a Simulink Function block to receive data through an input argument from a function caller. Multiply the input argument by 2, and then pass the calculated value back through an output argument.

- 1 Add a Simulink Function block from the User-Defined Functions library into your model.

Open the Library Browser by selecting the Library Browser toolbar button .

- 2 On the block, enter this function prototype to set the function name to `timestwo`, the input argument to `u`, and the output argument to `y`:

```
y = timestwo(u)
```

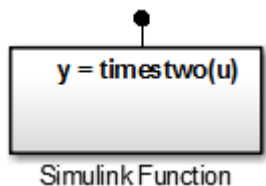

- 3 Double-click the block to open the subsystem defining the function.
- 4 Add a Gain block and set the **Gain** parameter to 2.

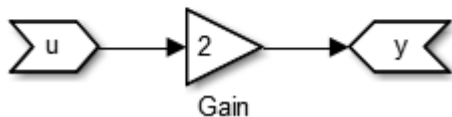

### Export Graphical Function from Stateflow Chart

Set up a graphical function in a Stateflow chart to receive data through an input argument from a function caller. Multiply the input argument by 2, and then pass the calculated value back through an output argument. Set chart parameters to export the function to a Simulink model.

#### Define a Graphical Function

Create a graphical function in a Stateflow chart. Define the function interface and function definition.

- 1 Add a Stateflow Chart to your Simulink model. From the Simulink Editor menu, select **File > New > Chart**.
- 2 Drag the new chart to your model. Double-click the chart to open it.
- 3 Add a graphical function. From the left-side toolbar, click and drag the graphical function icon  onto the chart.
- 4 Define the function interface. In the function box, replace the ? with the function interface `y = timestwo_gf(x)`.



- Define the function. Click the transition arrow and replace the ? with the MATLAB code  $\{y = 2*x\}$ .

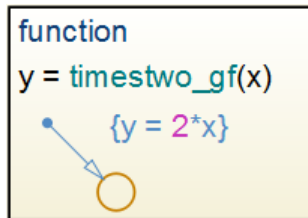

- Add a transition in the chart. Connect the chart input to a Sine Wave input and the output to a Scope.

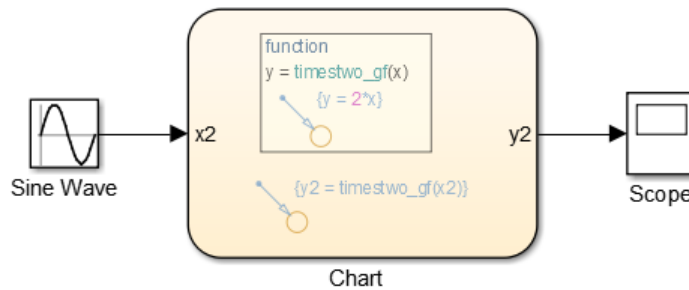



- Run a simulation to test the function.

### Set Argument Parameters for a Graphical Function

Specify the size, complexity, and type of the function input and output arguments. A chart can export only functions with fully specified prototypes.

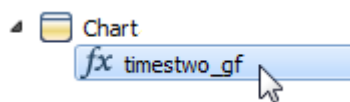
- Open Model Explorer. In the left pane, select the graphical function.



- From the **Column View** list in the middle pane, select **Stateflow**. Select the filter icon , and then select **All Stateflow Objects**. From the table at the bottom of the pane, select an input or output argument.

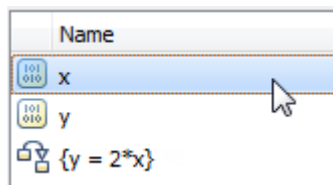

- 3 In the right pane, enter 1 (scaler) for Size, select Off (real number) for **Complexity**, and select **double** for **Type**.

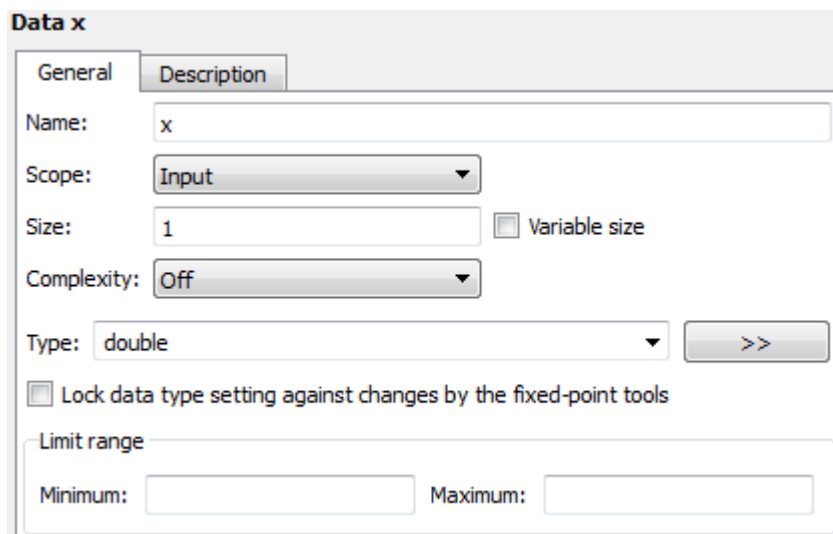

- 4 Repeat steps 2 and 3 with the remaining function arguments.

#### Set Export Function Parameters for a Graphical Function

Set parameters to export the graphical function during a simulation.

- 1 From the left pane, select the chart containing the graphical function.

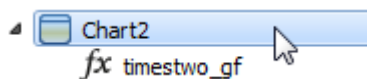

Alternatively, open the chart and from the menu, select **Chart > Properties**.

- 2 In the property dialog box, select **Export Chart Level Functions (Make Global)** and **Allow exported functions to be called by Simulink** check boxes.

If you are calling the exported graphical function from another Stateflow chart (not the chart that exported the graphical function), you do not need to select the **Allow exported functions to be called by Simulink** check box.

### Export MATLAB Function from Stateflow Chart

Set up a MATLAB function in a Stateflow chart to receive data through an input argument from a function caller. Multiply the input argument by 2, and then pass the calculated value back through an output argument. Set chart parameters to export the function to a Simulink model.

#### Define MATLAB Function

Create a graphical function in a Stateflow chart. Define the function interface and function definition.

- 1 Add a Stateflow Chart to your Simulink model. From the Simulink Editor menu, select **File > New > Chart**. A new chart opens in a new model.
- 2 Drag the new chart to your model. Double-click the chart to open it.
- 3 Add a graphical function. From the left-side toolbar, click and drag the graphical function icon  onto the chart.
- 4 Define the function interface. In the function box, replace the ? with the function interface `y = timestwo_mf(x)`.

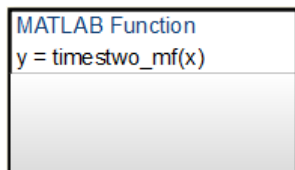

- 5 Double-click the function box to open the MATLAB code editor. Define the function with the MATLAB code.

```

1 function y = timestwo_mf(x)
2
3 y = 2*x;

```

- 6 Add a transition to test the MATLAB function. Add a Sine Wave input and connect the output to a Scope.

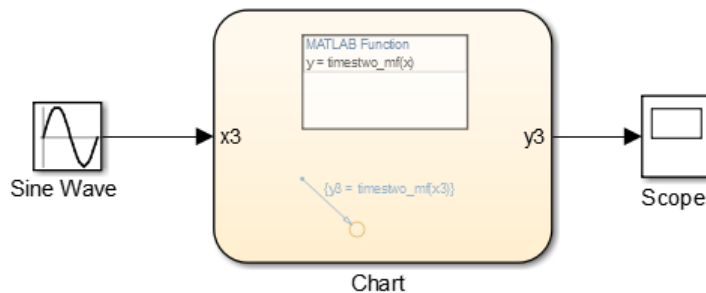

- 7 Run a simulation to test the function.

### Set Argument Parameters

Specify the size, complexity, and type of the function input and output arguments. A chart can export only functions with fully specified prototypes.

- 1 Open Model Explorer. In the left pane, select the MATLAB function.

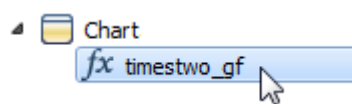

- 2 In the middle pane, from the **Column View** list, select **Stateflow**. From the table, select an input or output argument.

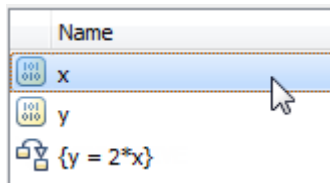

- 3 In the right pane, enter 1 (scaler) for **Size**, select Off (real number) for **Complexity**, and select **double** for **Type**.

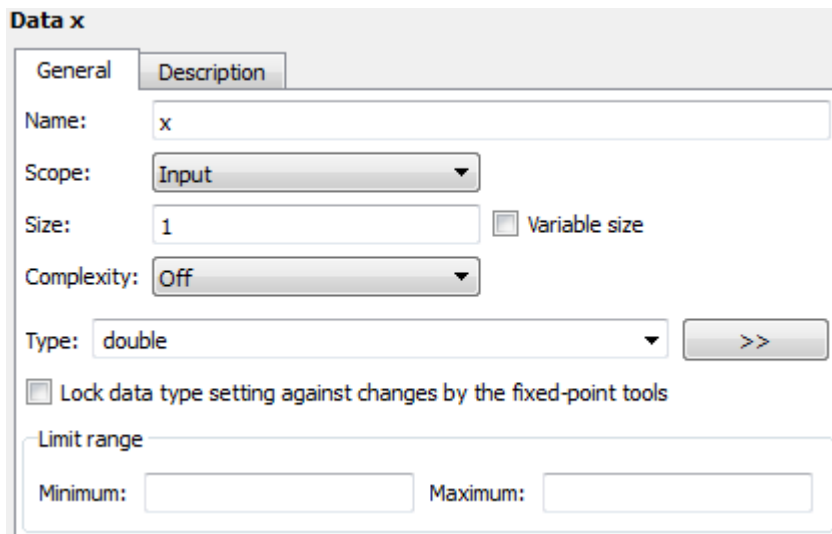

- 4 Repeat steps 2 and 3 with the remaining function arguments.

#### Set Export Function Parameters

Set parameters to export the MATLAB function during a simulation.

- 1 From the left pane, select the chart containing the graphical function.

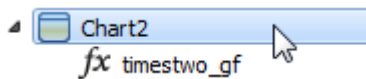

Alternatively, open the chart and from the menu, select **Chart > Properties**.

- 2 In the property dialog box, select **Export Chart Level Function (Make Global)** and **Allow exported functions to be called by Simulink** check boxes.

If you are calling the exported graphical function from another Stateflow chart (not the chart that exported the graphical function), you do not need to select the **Allow exported functions to be called by Simulink** check box.

## Call Simulink Functions with a Function Caller Block

The following examples show how to use a Function Caller block to call:

- Simulink Function block.
- Exported Graphical function from a Stateflow chart.
- Exported MATLAB function from a Stateflow chart.

The functions multiply a value from the caller by 2, and then send the calculated value back to the caller.

Because the Function Caller block cannot determine function arguments at compile time, you have to name the Function Caller block input and output arguments. The argument names in the **Function prototype** must match the function argument names.

### Function Caller Block to Call Simulink Function Block

Set up a Function Caller block to send data through an input argument to a Simulink Function block. Receive data back from the function through an output argument. Points to consider:

- The input and output argument names for the Simulink Function block and the prototype for a Function Caller block must match exactly.
- If the Function Caller block is within a Model block (referenced model), you must define the **Input argument specification** and **Output argument specification**. See “Simulink Functions in Referenced Models” on page 10-116 and “Argument Specification for Simulink Functions” on page 10-111.

To add a Function Caller block.

- 1 Add a Function Caller block from the User-Defined Functions library into your model.

- 2 In the Function Caller dialog box, in the **Function prototype** box, enter `y = timestwo(u)`. This function prototype creates an input port `u` and output port `y` on the Function Caller block.

---

**Note:** Typing in a blank text box displays a list of previously created function prototypes that match the text you're typing.

---

- 3 Add a Sine Wave block to the input and a Scope block to the output.

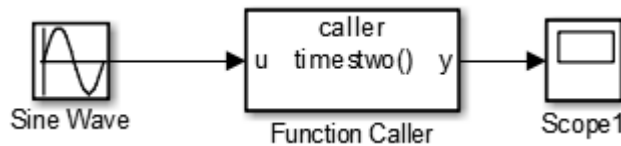

- 4 Set up a Simulink Function block as described in “Simulink Function Block” on page 10-93.

### Simulate the Model

After you create a function using a Simulink Function block and setup a call to that function using a Function Caller block, you can simulate the model.

- 1 Return to the top level of the model.

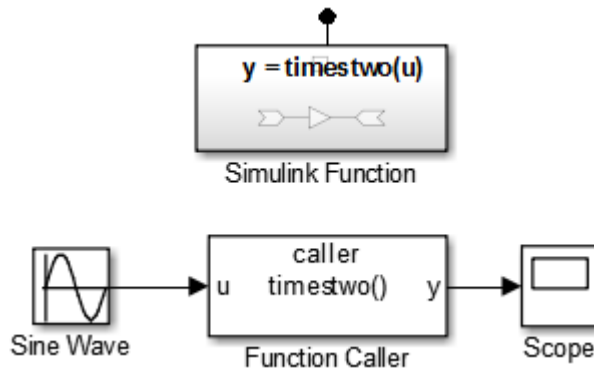

- 2 Run a simulation.
- 3 To view the signal results, double-click the Scope block. The input sine wave with an amplitude of 2 is doubled.

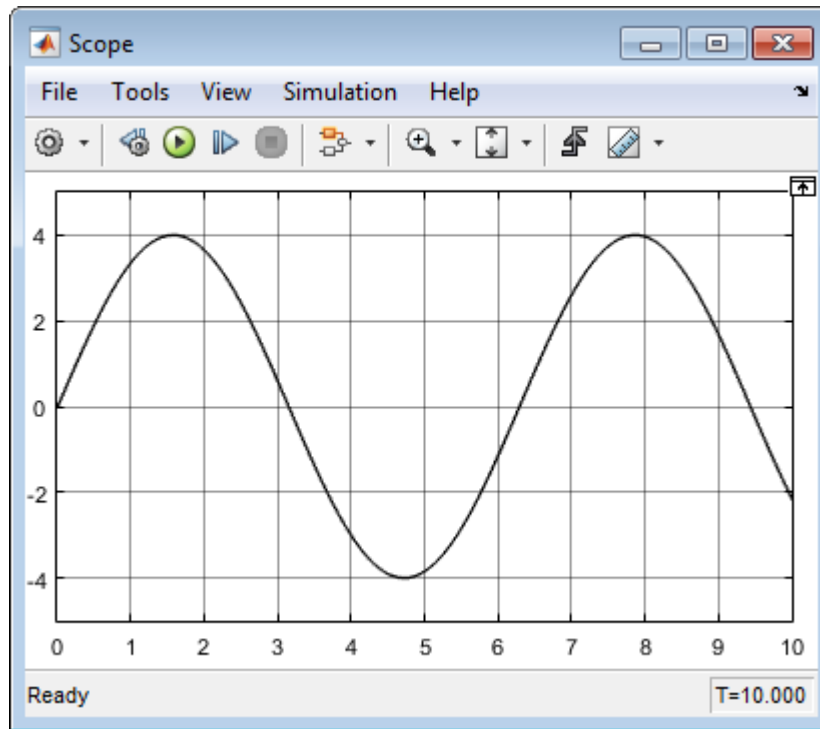

### Function Caller Block to Call Exported Graphical Function

Calling an exported graphical function from Stateflow is no different than calling a Simulink Function block. Points to consider:

- The input and output argument names for an exported function and the prototype for a Function Caller block must match exactly.
- If the Function Caller block is within a Model block (referenced model), you must define the **Input argument specification** and **Output argument specification**. See “Simulink Functions in Referenced Models” on page 10-116 and “Argument Specification for Simulink Functions” on page 10-111.

To create an exported graphical function, see “Export Graphical Function from Stateflow Chart” on page 10-94.



## Function Caller Block to Call Exported MATLAB Functions

Calling an exported MATLAB function from Stateflow is no different than calling a Simulink Function block. Points to consider:

- The input and output argument names for an exported function and the prototype for a Function Caller block much match exactly.
- If the Function Caller block is within a Model block (referenced model), you must define the **Input argument specification** and **Output argument specification**. See “Simulink Functions in Referenced Models” on page 10-116 and “Argument Specification for Simulink Functions” on page 10-111.

To create an exported MATLAB function, see “Export MATLAB Function from Stateflow Chart” on page 10-97.

## Call Simulink Functions from a MATLAB Function Block

A MATLAB Function block can call another function. The following examples show how to use a MATLAB Function block to call:

- Simulink Function block.
- Exported Graphical function from a Stateflow chart.
- Exported MATLAB function from a Stateflow chart.

The functions multiply a value from the caller by 2, and then send the calculated value back to the caller.

MATLAB Function blocks only support discrete and fixed-in-minor sample times. When using a Sine Wave block as an input signal, setup the model and block parameters for a sample time compatible with the MATLAB Function block:

- Discrete — Open the model Configuration Parameters dialog box to the Solver pane. Set **Type** to Fixed-step and enter a value for **Fixed-step size** (fundamental sample time). Open the Sine Wave Block Parameters dialog box and set **Sample time** to the model sample time you entered.
- Fixed-In-Minor step — Open the Sine Wave Block Parameters dialog box. In the **Sample time** box, enter [0 1].

### MATLAB Function Block to Call Simulink Function Block

Set up a MATLAB Function block to send data through an input argument to a Simulink Function block. Receive data back from the function through an output argument.

- 1 Add a MATLAB Function block to your model.
- 2 Double-click the block, which opens the MATLAB editor. Enter the function call `y1 = timestwo(u1)`.

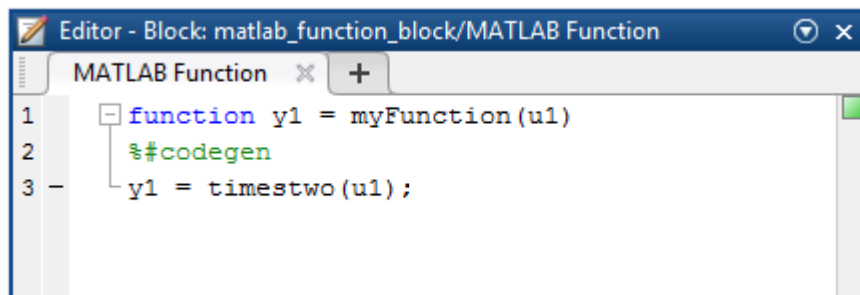

```

Editor - Block: matlab_function_block/MATLAB Function
MATLAB Function
1 function y1 = myFunction(u1)
2     %#codegen
3     y1 = timestwo(u1);
  
```

---

**Note:** The argument names for the function you define in the MATLAB Function block do not have to match the argument names for the function that you define in the Simulink Function block. For a Function Caller block that calls a Simulink Function block, argument names must match.

---

- 3 Add a Sine Wave block for an input signal and a Scope block to view the output signal.

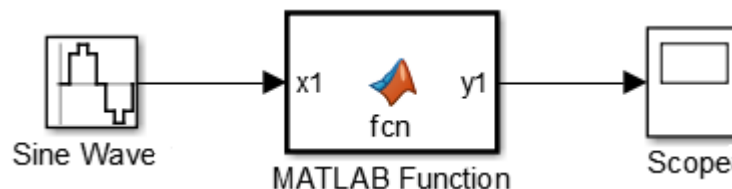

- 4 For the Sine Wave block, set the **Sample time** to 0.01. For the model, open the Configuration Parameters dialog box to the solver pane. Set **Type** to Fixed-step and **Fixed-step size** to 0.01.
- 5 Set up a Simulink Function block as described in “Simulink Function Block” on page 10-93.

### MATLAB Function Block to Call Exported Graphical Function

Calling an exported graphical function from a MATLAB Function block is the same as calling a Simulink Function block. See “MATLAB Function Block to Call Simulink Function Block” on page 10-104.

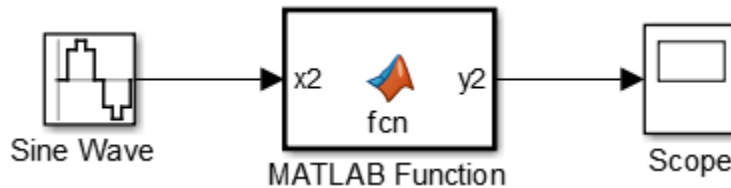

### MATLAB Function Block to Call Exported MATLAB Function

Calling an exported MATLAB function from a MATLAB Function block is the same as calling a Simulink Function block. See “MATLAB Function Block to Call Simulink Function Block” on page 10-104.

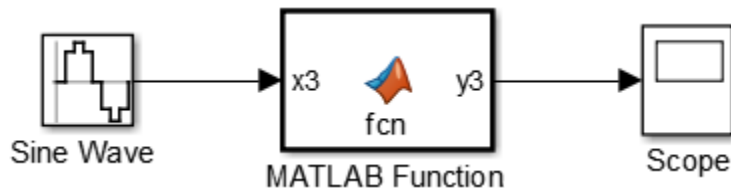

### Call Simulink Functions from a Stateflow Chart

The following examples show how to use a Stateflow chart to call functions external to the chart but accessible in a Simulink model:

- Simulink Function block
- Exported Stateflow graphical function
- Exported Stateflow MATLAB function

There are no limitations to a function call from a Stateflow chart:

- Caller argument names can be different from the function argument names.
- Input signals to a Stateflow chart can be either continuous or discrete.

### Create Stateflow Chart with a Transition

- 1 Add a Stateflow Chart to your Simulink model. From the Simulink Editor menu, select **File > New > Chart**. A new chart opens in a new model.
- 2 Drag the new chart to your model. Double-click the chart to open it.
- 3 Add a graphical function. From the left-side toolbar, click and drag the transition icon  onto the chart.
  - a From the menu, select **Chart > Add Inputs & Outputs > Data Input From Simulink**.
  - b In the Data dialog box, set **Name** to x1.
- 5 Add output port.
  - a From the menu, select **Chart > Add Inputs & Outputs > Data Output To Simulink**.
  - b In the Data dialog box, set **Name** to y1.
- 6 Add a Sine Wave block and connect signal output to the chart input port. Add a Scope block and connect input to the chart output port.
- 7 Edit transition code to call a function. For example, to call the Simulink Function block, enter:

```
{y1=timestwo_sf(x1);}
```

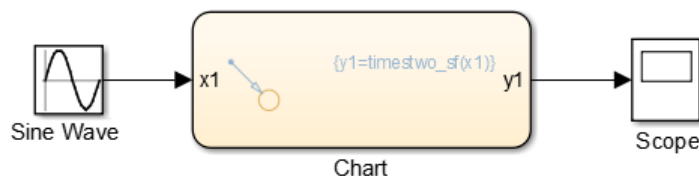

- 8 Set up a Simulink Function block as described in “Simulink Function Block” on page 10-93.

### Stateflow Chart to Call Exported Graphical Function

Calling an exported graphical function from a Stateflow chart is the same as calling a Simulink Function block. See “Call Simulink Functions from a Stateflow Chart” on page 10-105.

- 1 Open a Stateflow chart.
- 2 Click transition and enter  

```
{y2=timestwo_gf(x2);}
```

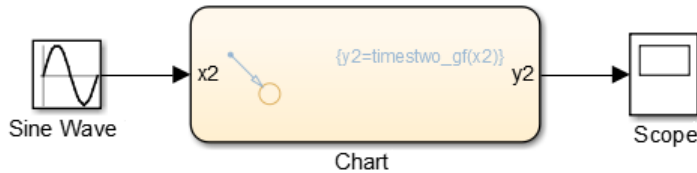

### Stateflow Chart to Call Exported MATLAB Functions

Calling an exported MATLAB function from a Stateflow chart is the same as calling a Simulink Function block. See “Call Simulink Functions from a Stateflow Chart” on page 10-105.

- 1 Open Stateflow chart.
- 2 Click transition and enter:

```
{y3=timestwo_sf(x3);}
```

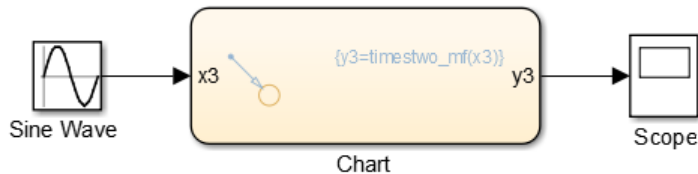

### Call a Simulink Function Block from Multiple Sites

If you call a Simulink Function block from multiple sites, all call sites share the state of the function. For example, suppose that you have a Stateflow chart with two calls and two Function Caller blocks with calls to the same function.

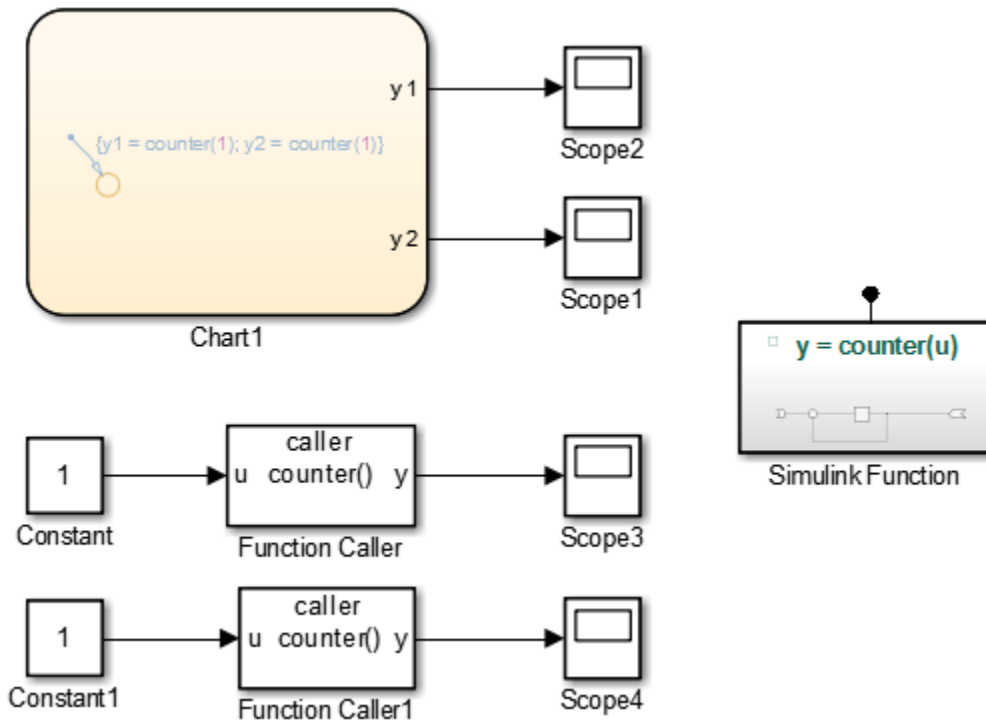

A function defined with a Simulink Function block is a counter that increments by 1 each time it is called with an input of 1.

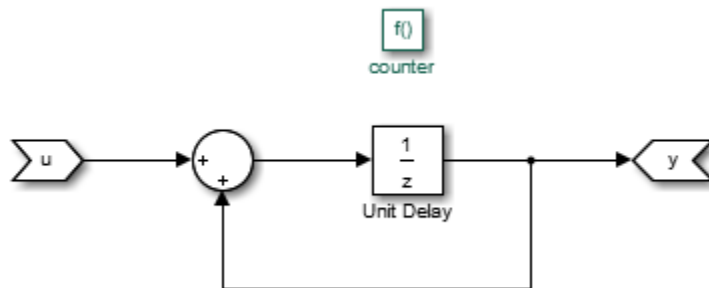

The Unit Delay block has state because the block value is persistent between calls from the two Function Caller blocks and the Stateflow chart. Conceptually, you can think of this function being implemented in MATLAB code:

```
function y = counter(u)
persistent state;
if isempty(state)
    state = 0;
end
y = state;
state = state + u;
```

Simulink initializes the state value of the Unit Delay block at the beginning of a simulation. After that, each time the function is called, the state value is updated.

In this example, the output observed in Scope1 increments by 4 at each time step. Scope2, Scope3, and Scope4 show a similar behavior. The only difference is a shift in the observed signal due to the execution sequence of the function calls.

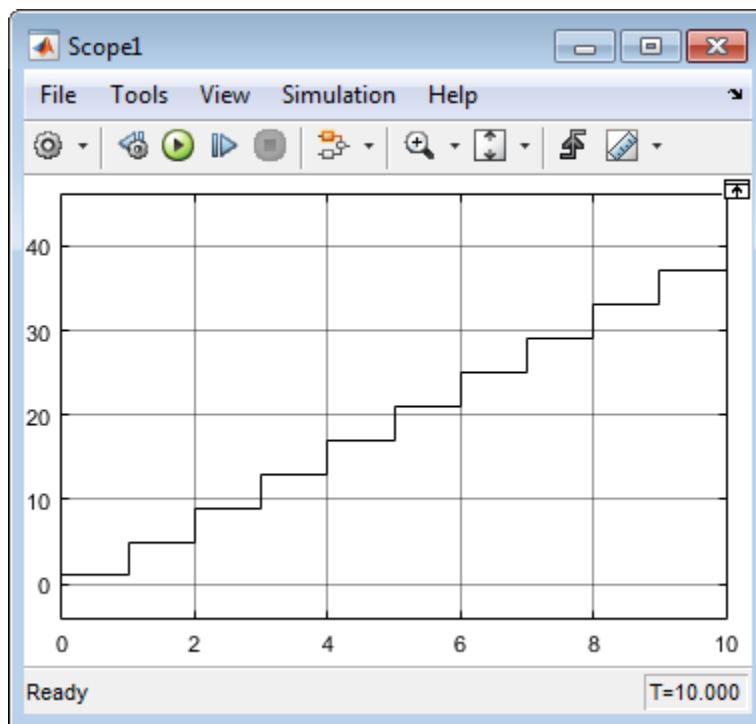

“Create Stateflow Chart with a Transition” on page 10-106

### Diagnostic Settings With Multiple Callers

For multiple callers that share a function and have different sample time rates, data integrity and consistency of real-time code might be a problem. Consider controlling the severity of diagnostics.

Select a **Fixed-step** solver. Set the **Treat each discrete rate as a separate task** to:

- Clear (single-tasking), and then set **Single task rate transition** parameter to **none** (default), **warning**, or **error**.
- Select (multi-tasking), and then set **Multitask rate transition** parameter to **error** (default) or **warning**.

### See Also

#### Blocks

Argument Inport | Argument Outport | Function Caller | MATLAB Function | Simulink Function

### Related Examples

- “Simulink Functions” on page 10-82
- “Simulink Functions in Models” on page 10-93
- “Argument Specification for Simulink Functions” on page 10-111
- “Simulink Functions in Referenced Models” on page 10-116
- “Private Scoping of Simulink Functions” on page 10-125
- “Diagnostics Using a Client-Server Architecture” on page 10-130



## Argument Specification for Simulink Functions

### In this section...

“Example Argument Specifications for Data Types” on page 10-111

“Input Argument Specification for Bus Data Type” on page 10-112

“Input Argument Specification for Enumerated Data Type” on page 10-113

“Input Argument Specification for an Alias Data Type” on page 10-114

When a Simulink Function block is within the scope of a Function Caller block, you do not have to specify the parameters. In such a case, the Function Caller block can determine the input and output argument specifications.

You specify arguments when a Simulink Function block is outside the scope of a Function Caller block. A Simulink Function block is considered to be out of scope of a Function Caller block when the two blocks are in separate models referenced by a common parent model.

### Example Argument Specifications for Data Types

This table lists possible input and output argument specifications.

Simulink Function Block Data Type	Function Caller Block Expression	Description
double	<code>double(1.0)</code>	Double-precision scalar.
double	<code>double(ones(12,1))</code>	Double-precision column vector of length 12.
single	<code>single(1.0)</code>	Single-precision scalar.
int8, int16, int32	<code>int8(1), int16(1), int32(1)</code>	Integer scalars.
	<code>int32([1 1 1])</code>	Integer row vector of length 3.
	<code>int32(1+1i)</code>	Complex scalar whose real and imaginary parts are 32-bit integers.
uint8, int16, int32	<code>uint8(1), uint16(1), uint32(1)</code>	Unsigned integer scalars.

Simulink Function Block Data Type	Function Caller Block Expression	Description
boolean	boolean(true),boolean(	Booleans, initialized to true (1) or false (0).
fixdt(1,16) fixdt(signed, word_length)	fi(0,1,16) fi(value, signed, word_length)	16-bit fixed-point signed scalar with binary point set to zero.  Fixed-point numbers can have a word size up to 128 bits.
fixdt(1,16,4)	fi(0,1,16,4)	16-bit fixed-point signed scalar with binary point set to 4.
fixdt(1,16,2^0,0)	fi(0,1,16,2^0,0)	16-bit fixed-point signed scalar with slope set to 2^0 and bias set to 0.
Bus: <object name>	parameter object name	Simulink.Parameter object with the Value parameter set to a MATLAB structure for the bus.
Enum: <class name>	parameter object name	Simulink.Parameter object with the Value parameter set to an enumerated value.
<alias name>	parameter object name	Simulink.Parameter object with the DataType parameter set to a Simulink.AliasType object and the Value parameter set to a value.

## Input Argument Specification for Bus Data Type

Create a bus with two signals, and then specify the **Input argument specification** parameter for a Function Caller block. The Function Caller block calls a Simulink Function block that accepts the bus as input.

A bus input to a Function Caller block must be a nonvirtual bus using a bus object.

- 1 Create a Simulink bus object `myBus`.

```
myBus = Simulink.Bus;
```

- 2 Add elements A and B.

```
myBus.Elements(1).Name = 'A';
myBus.Elements(2).Name = 'B';
```

- 3 Create a MATLAB structure `myBus_MATLABstruct` with fields A and B.

```
myBus_MATLABstruct.A = 0;
myBus_MATLABstruct.B = 0;
```

- 4 Create a Simulink parameter object `myBus_parameter` and assign the MATLAB structure to the `Value` parameter.

```
myBus_parameter = Simulink.Parameter;
myBus_parameter.DataType = 'Bus: myBus';
myBus_parameter.Value = myBus_MATLABstruct;
```

- 5 For the Function Caller block dialog box, set the **Input argument specification** parameter to `myBus_parameter`.
- 6 For the Argument In block dialog box of the Simulink Function block, set the **Data type** parameter to `Bus: myBus`.

## Input Argument Specification for Enumerated Data Type

Create an enumerated data type for the three primary colors, and then specify the **Input argument specification** parameter for a Function Caller block. The Function Caller block calls a Simulink Function block that accepts a signal with the enumerated type as input.

- 1 Create a MATLAB file for saving the data type definition. On the MATLAB toolstrip, select **New > Class**.
- 2 In the MATLAB editor, define the elements of an enumerated data type. The class `BasicColors` is a subclass of the class `Simulink.IntEnumType`.

```
classdef BasicColors < Simulink.IntEnumType
    enumeration
        Red(0)
        Yellow(1)
        Blue(2)
    end
end
```

- 3 Save the class definition in a file named `BasicColors.m`.

- 4 Create a Simulink parameter object `myEnum_parameter` and assign one of the enumerated values to the `Value` parameter.

```
myEnum_parameter = Simulink.Parameter;  
myEnum_parameter.Value = BasicColors.Red;
```

- 5 For the Function Caller block dialog box, set the **Input argument specification** to `myEnum_parameter`.
- 6 For the Argument In block dialog box within a Simulink Function block, set the **Data type** parameter to `Enum: BasicColors`.

## Input Argument Specification for an Alias Data Type

Create an alias name for the data type `single`, and then specify the **Input argument specification** parameter for a Function Caller block. The Simulink Function block called by the Function Caller block also uses the alias name to define the input data type.

- 1 Create a Simulink alias data type object `myAlias`.

```
myAlias = Simulink.AliasType;
```

- 2 Assign a data type.

```
myAlias.BaseType = 'single';
```

- 3 Create a Simulink parameter object `myAlias_parameter` and assign the alias name to the `Data Type` parameter.

```
myAlias_parameter = Simulink.Parameter;  
myAlias_parameter.DataType = 'myAlias';  
myAlias_parameter.Value = 1;
```

- 4 For the Function Caller block dialog box, set the **Input argument specification** parameter to `myAlias_parameter`.
- 5 For the Argument In block dialog box within a Simulink Function block, set the **Data type** parameter to `myAlias`.

## See Also

### Blocks

Argument Inport | Argument Outport | Function Caller | MATLAB Function | Simulink Function

## **Related Examples**

- “Simulink Functions” on page 10-82
- “Simulink Functions in Models” on page 10-93
- “Argument Specification for Simulink Functions” on page 10-111
- “Simulink Functions in Referenced Models” on page 10-116
- “Private Scoping of Simulink Functions” on page 10-125

## **More About**

- “Simulink Functions” on page 10-82

## Simulink Functions in Referenced Models

In this section...
“Simulink Function Block in Referenced Model” on page 10-116
“Function Caller Block in Referenced Model” on page 10-119
“Function and Function Caller in Separate Models” on page 10-121
“Function and Function Caller in the Same Model” on page 10-123

You can place Simulink Function and Function Caller blocks in a referenced model, but doing so requires some special considerations:

- The referenced model must follow export-function model rules. See “Export-Function Models” on page 10-52.
- Sometimes, you must explicitly define the argument data types for a Function Caller block.

These examples show four relationships between Function Caller blocks, Simulink Function blocks, and referenced models.

### Simulink Function Block in Referenced Model

In this example, the parent model contains a Function Caller block, and the referenced model, `Model_B`, contains a Simulink Function block. `Model_B` must follow export-function model rules.

Since the Function Caller block is a parent of the function, it can determine the argument data types of the function. In the Function Caller block, you do not need to define the **Input argument specification** and **Output argument specification** parameters.

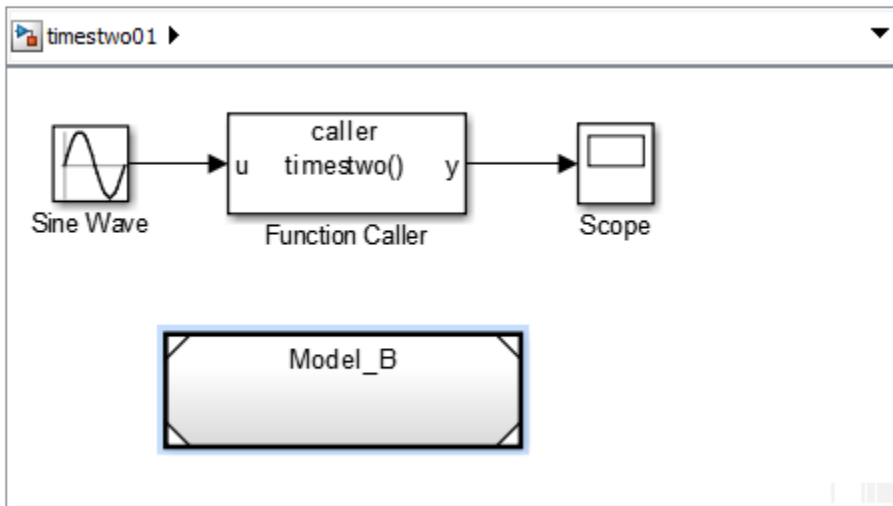

Model\_B contains a Simulink Function block that defines a function for multiplying the input by 2. Because this model contains only a Simulink Function block, it satisfies export-function model rules. See “Export-Function Models” on page 10-52.

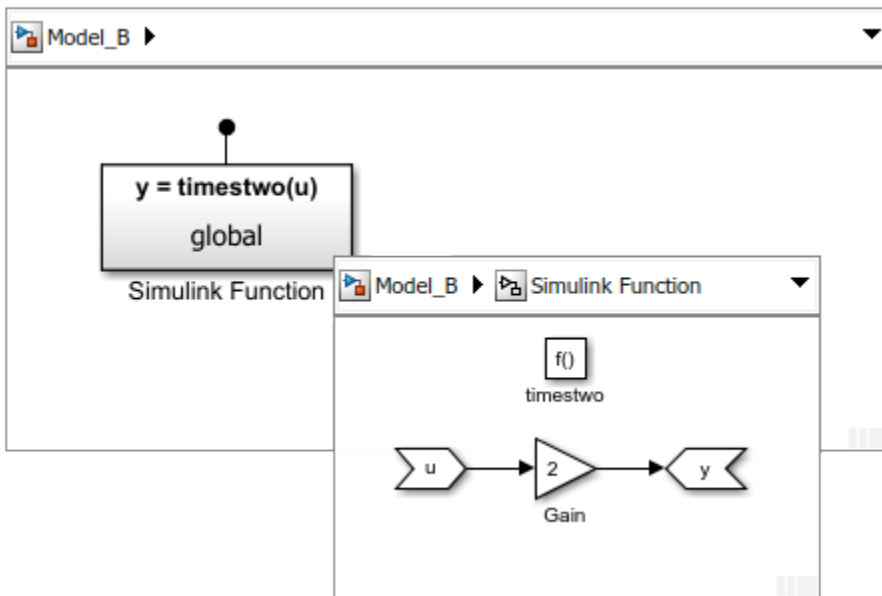

For `Model_B`, set the Configuration Parameters for the solver to satisfy export-function model rules:

- **Type:** Fixed-step.
- **Solver:** discrete (no continuous states).

### **Simulink Function in Referenced Model Placed in Subsystem**

Once the Simulink Function block is identified as global by placing it at the root level of a referenced model there are no limitations on where this referenced model can be placed.

For example, you could place `Model_B` with a Simulink Function block in a Subsystem block.



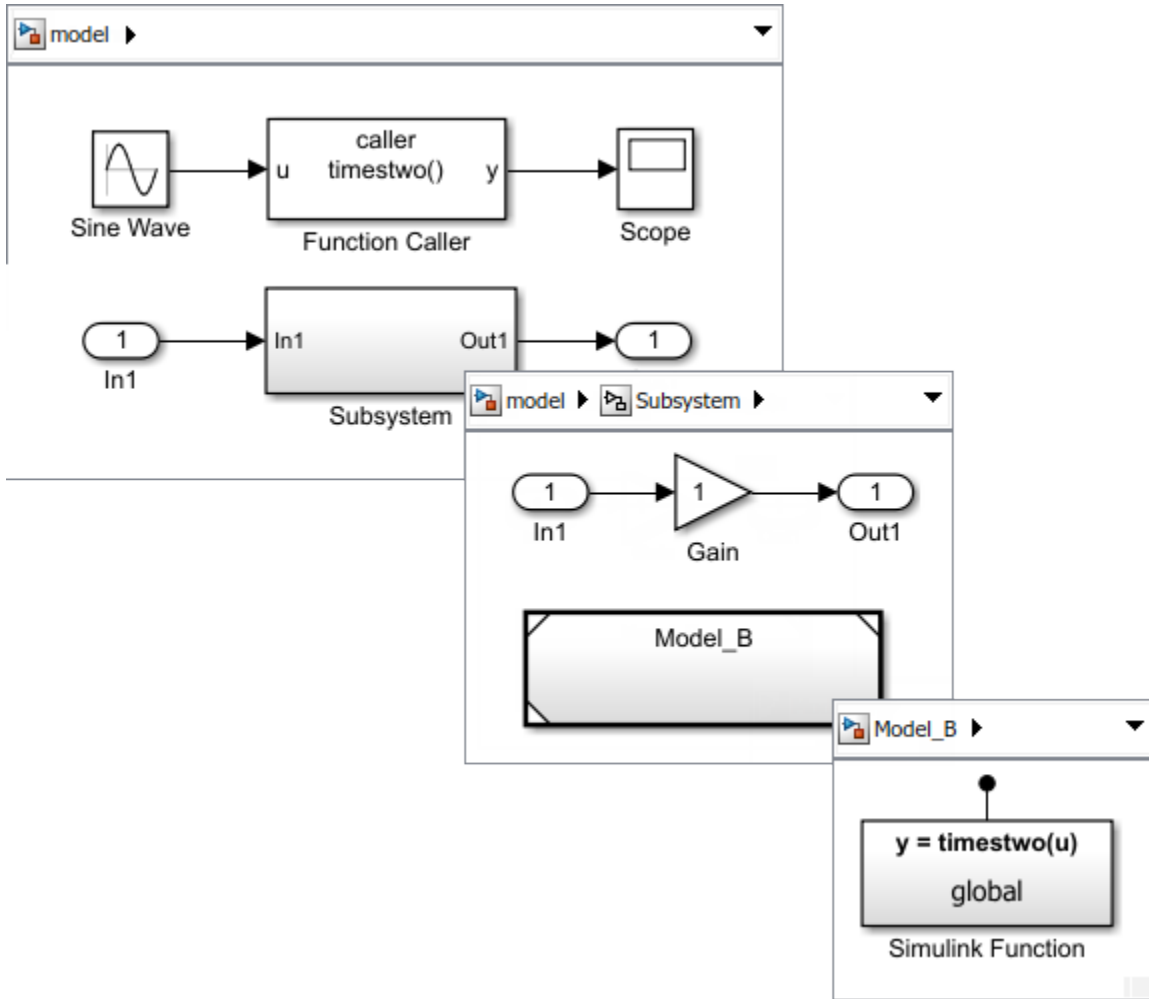

## Function Caller Block in Referenced Model

In this example, the parent model contains a Simulink Function block, and a referenced model, `Model_A`, contains a Function Caller block.

For the parent model, you can set the solver type to `Variable-step` or `Fixed-step`.

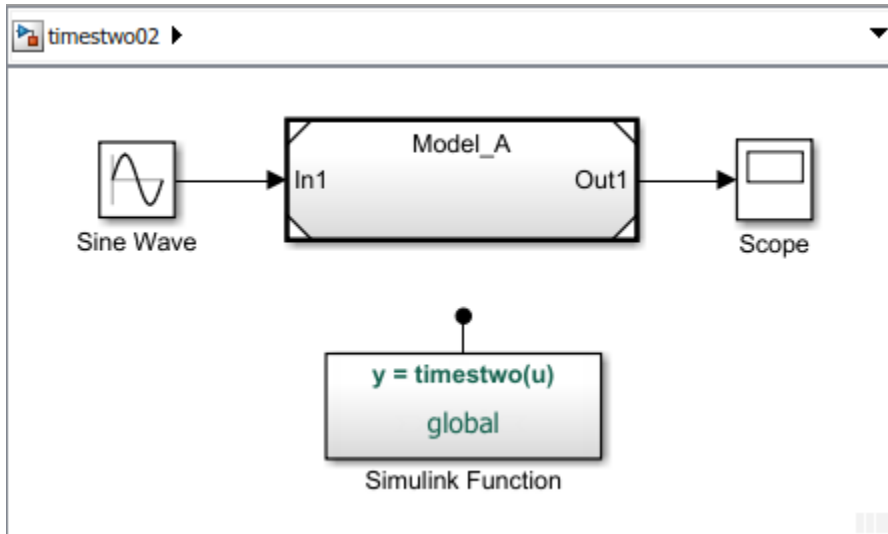

Model\_A contains a Function Caller block.

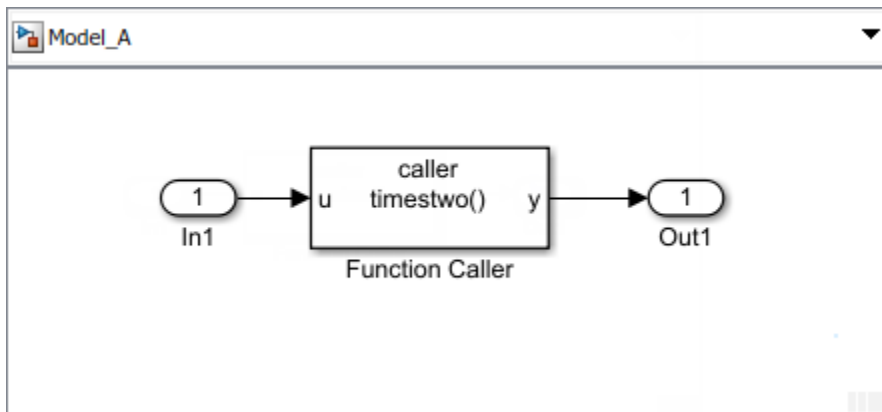

Since the Function Caller block cannot find the function in `Model_A` or in a model it references, you must specify the Function Caller block argument parameters:

- **Input argument specification:** Specify to match the Simulink Function block input argument data types, for example, `double(1.0)`.

Specify the argument specification for a Simulink Function block with the **Data type** parameter in the Input Argument and Output Argument blocks.

- **Output argument specification:** Specify to match the Simulink Function block output argument data types, for example, `double(1.0)`.

## Function and Function Caller in Separate Models

In this example, the parent model contains two referenced models. **Model\_A** is a referenced model with a Function Caller block. **Model\_B** is a referenced model with a Simulink Function block. Only **Model\_B** with a Simulink Function block must follow export-function rules.

For **Model\_A**, specify parameters as you do for the referenced model in “Function Caller Block in Referenced Model” on page 10-119. For **Model\_B**, specify parameters as you do for the referenced model in “Simulink Function Block in Referenced Model” on page 10-116.

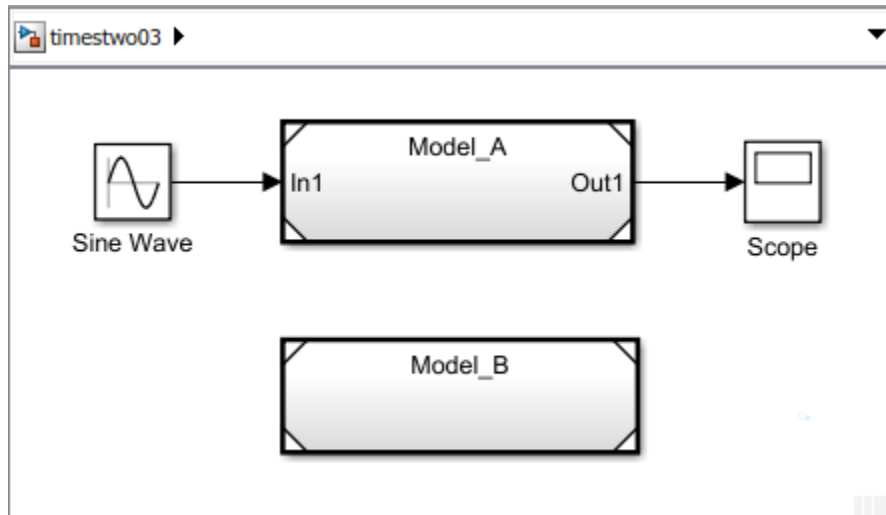

**Model\_A** contains a Function Caller block.

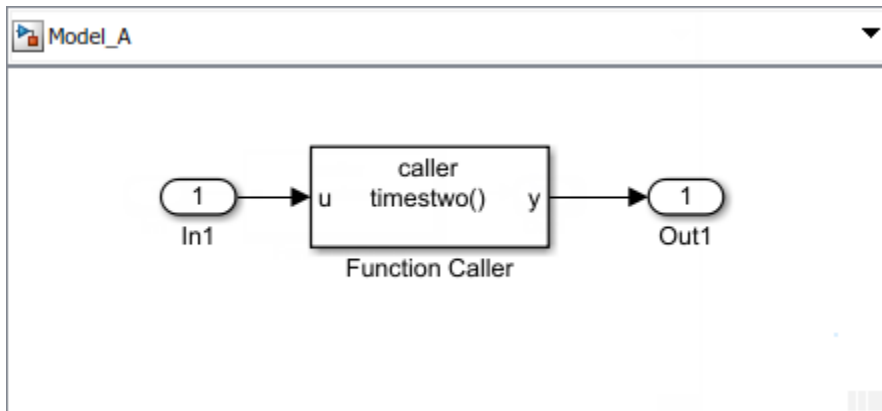

Model\_B contains a Simulink Function block that defines a function for multiplying the input by 2. Because this model contains only a Simulink Function block, it satisfies export-function model rules. See “Export-Function Models” on page 10-52.

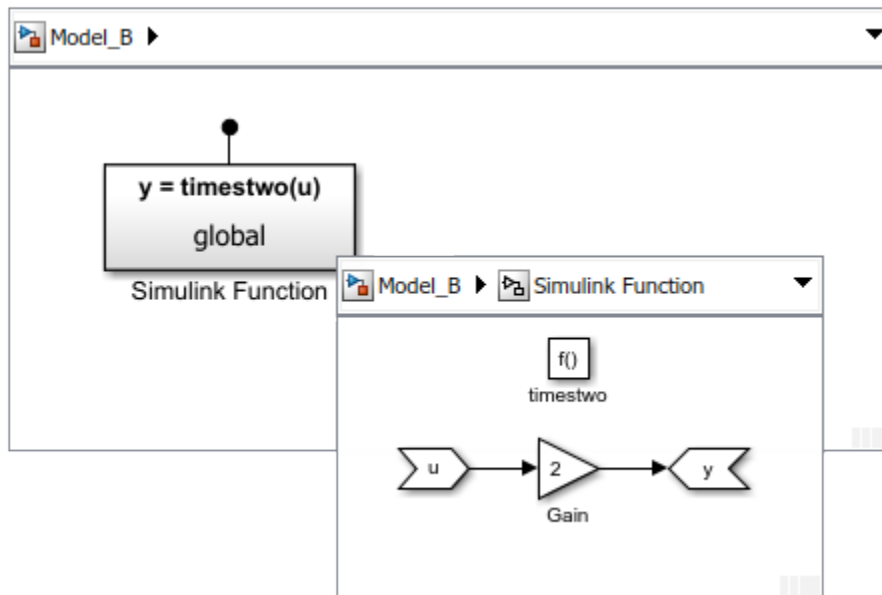

## Function and Function Caller in the Same Model

In this example, the parent model contains one referenced model, `Model_C`, with both a Function Caller block and a Simulink Function block. Because both function and caller are in the same model, `Model_C` does not need to follow export-function rules.

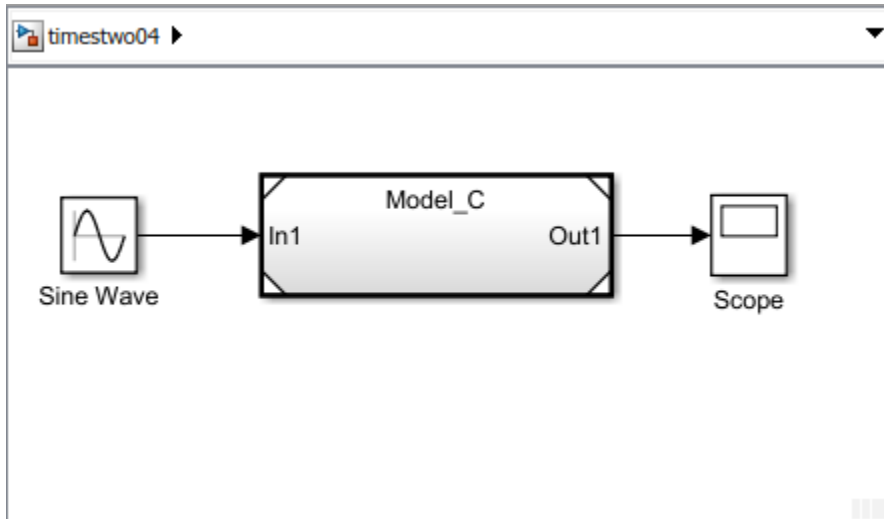

`Model_C` contains both a Function Caller block and a Simulink Function block.

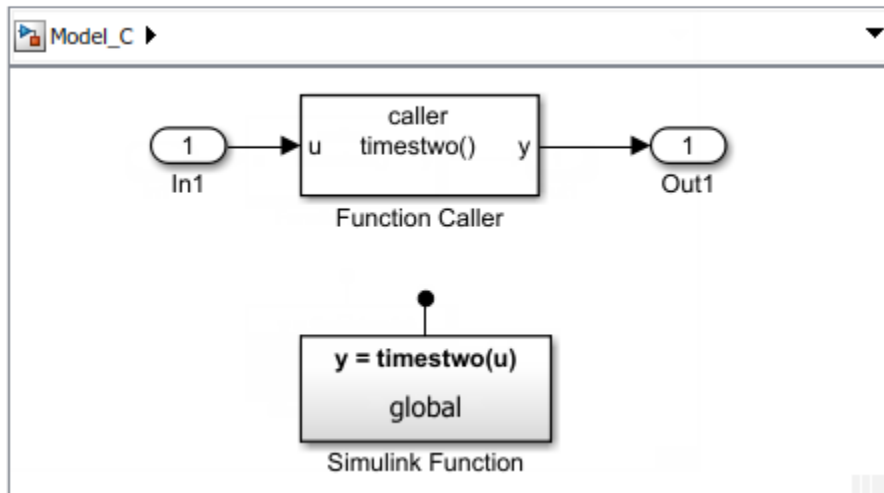

### See Also

#### Blocks

Argument Inport | Argument Outport | Function Caller | MATLAB Function | Simulink Function

### Related Examples

- “Simulink Functions” on page 10-82
- “Simulink Functions in Models” on page 10-93
- “Argument Specification for Simulink Functions” on page 10-111
- “Simulink Functions in Referenced Models” on page 10-116
- “Private Scoping of Simulink Functions” on page 10-125

## Private Scoping of Simulink Functions

The scope of a Simulink function is defined within the context of a model. If you place a function in any subsystem, the function scope is private to the model. Access to the function from outside the model is prohibited. You can place a function:

- In a virtual subsystem — You can access the function from within the subsystem without qualifying the function name, or you can access the function from outside the subsystem by qualifying the function name with the subsystem name.
- In an atomic subsystem — You can call functions from within the subsystem, but not from outside the subsystem by qualifying the name.

Placing a virtual subsystem at the root level of a model enables you to create a library of Simulink functions. The functions are then accessible from anywhere in your model.

### Resolve to a Function Hierarchically

Placing a Simulink Function block within a virtual or atomicSubsystem block limits access to the function and removes the function name from the global namespace. You can call the function from inside the subsystem without qualification. For example:

```
y = function_name(x)
```

The function caller can be:

- At the same hierarchic level as the function

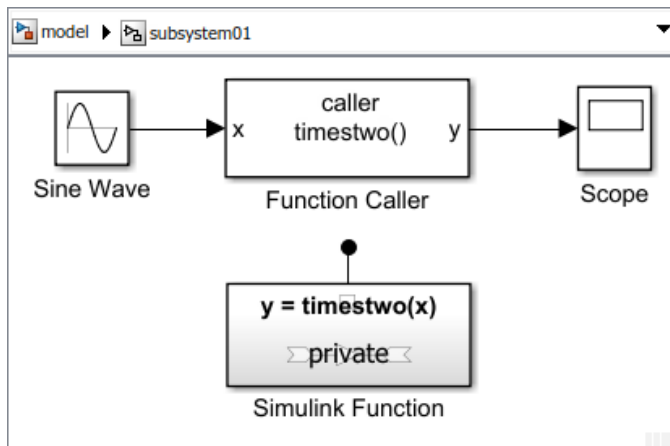

- In a subsystem one or more levels below the hierarchic level of the function

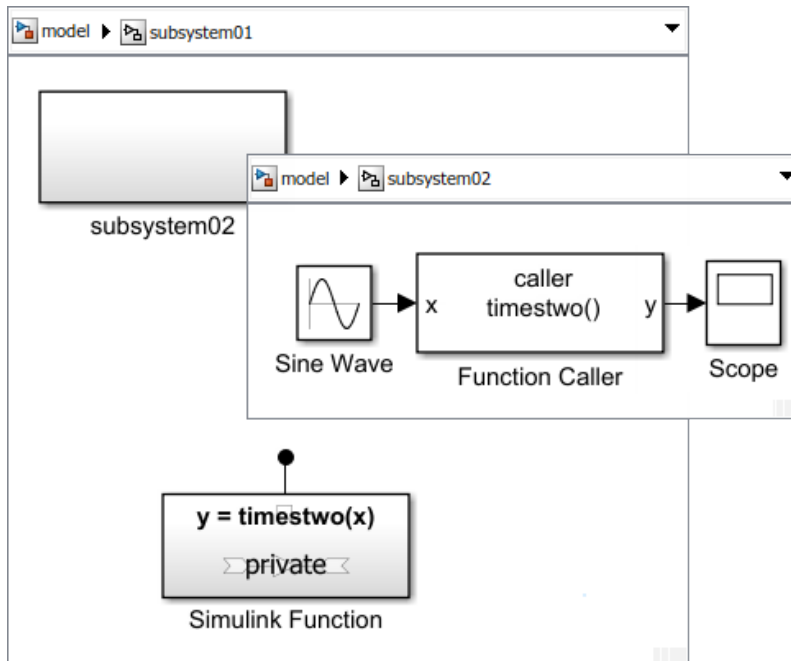

You can also call a private Simulink Function block without qualification from a MATLAB Function block or a Stateflow chart within the subsystem.

## Resolve to a Function by Qualification

When you place a Simulink Function block in a virtual Subsystem block, the function name is not visible outside the subsystem, but you can call the function from outside the subsystem. To call the function, qualify the function name with the subsystem name. For example:

```
y = subsystem01.function(x)
```

A function caller can be at a level where it can hierarchically resolve to the subsystem containing the function:

- Outside the subsystem one hierarchic level above the function



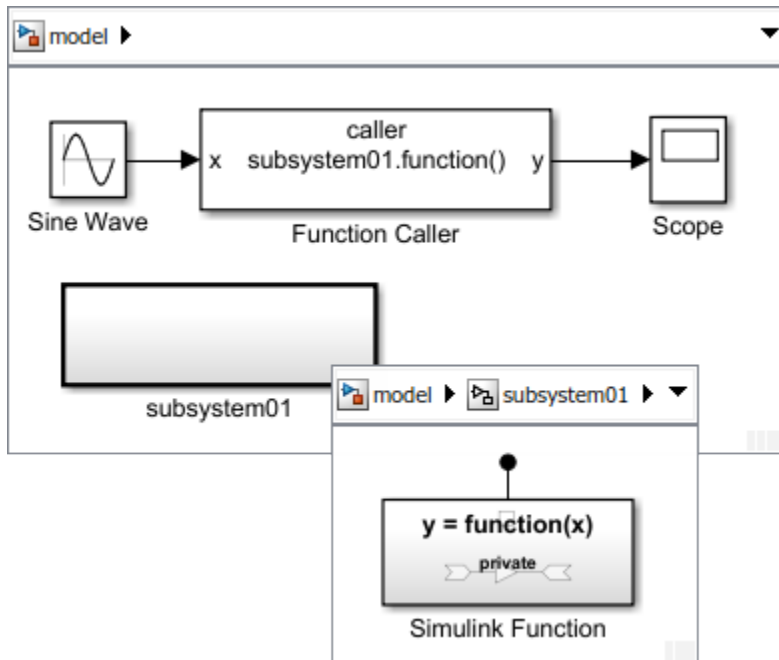

- In another subsystem at the same hierarchic level as the function

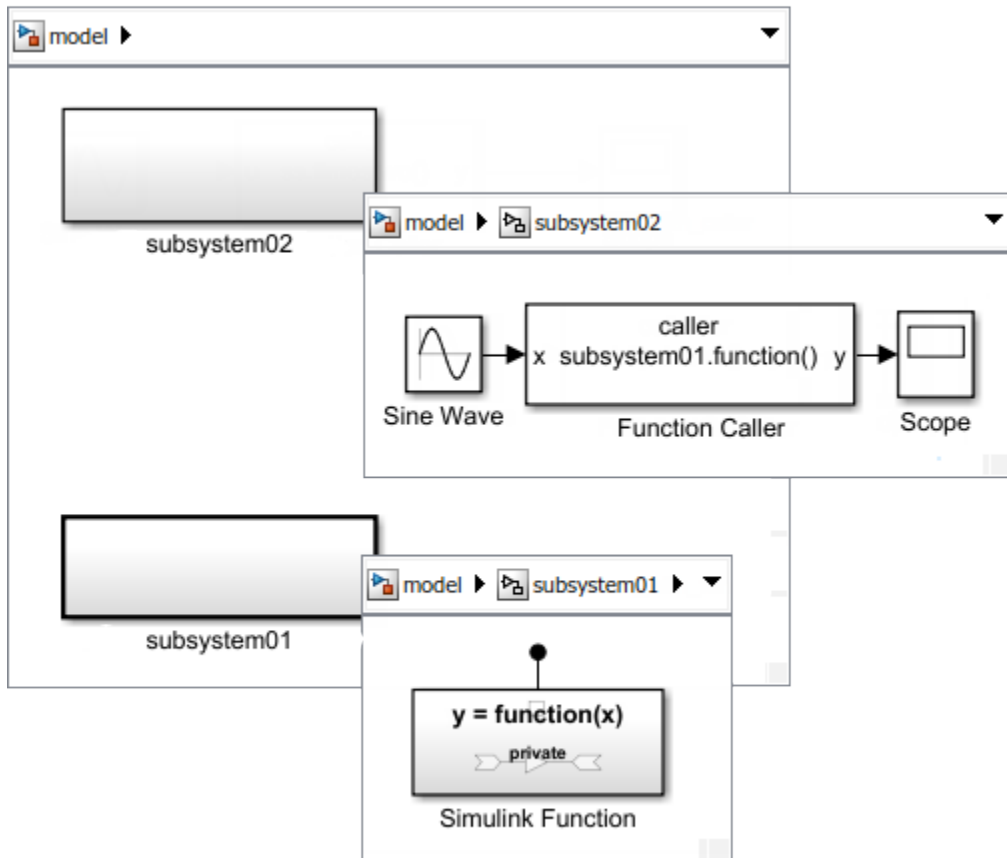

- In another subsystem one or more levels below the hierarchic level of the function

## See Also

### Blocks

Argument Inport | Argument Outport | Function Caller | MATLAB Function | Simulink Function

## **Related Examples**

- “Simulink Functions” on page 10-82
- “Simulink Functions in Models” on page 10-93
- “Argument Specification for Simulink Functions” on page 10-111
- “Simulink Functions in Referenced Models” on page 10-116
- “Export Stateflow Functions for Reuse” (Stateflow)

## Diagnostics Using a Client-Server Architecture

In this section...
“Diagnostic Messaging with Simulink Functions” on page 10-130
“Client-Server Architecture” on page 10-130
“Modifier Pattern” on page 10-132
“Observer Pattern” on page 10-134

### Diagnostic Messaging with Simulink Functions

Use Simulink functions when you define a diagnostic service where callers pass an error code. The service tracks error codes for all errors that occur. One-way to implement this service is to use an indexed Data Store Memory block. A diagnostic monitoring system can then periodically check for the occurrence of specific errors and modify system behavior accordingly.

### Client-Server Architecture

You can use Simulink Function blocks and Function Caller blocks to model client-server architectures. Uses for this architecture include memory storage and diagnostics.

As an example, create a model of a simple distributed system consisting of multiple control applications (clients), each of which can report diagnostics throughout execution. Since client-server architectures are typically constructed in layers, add a service layer to model the diagnostic interface.

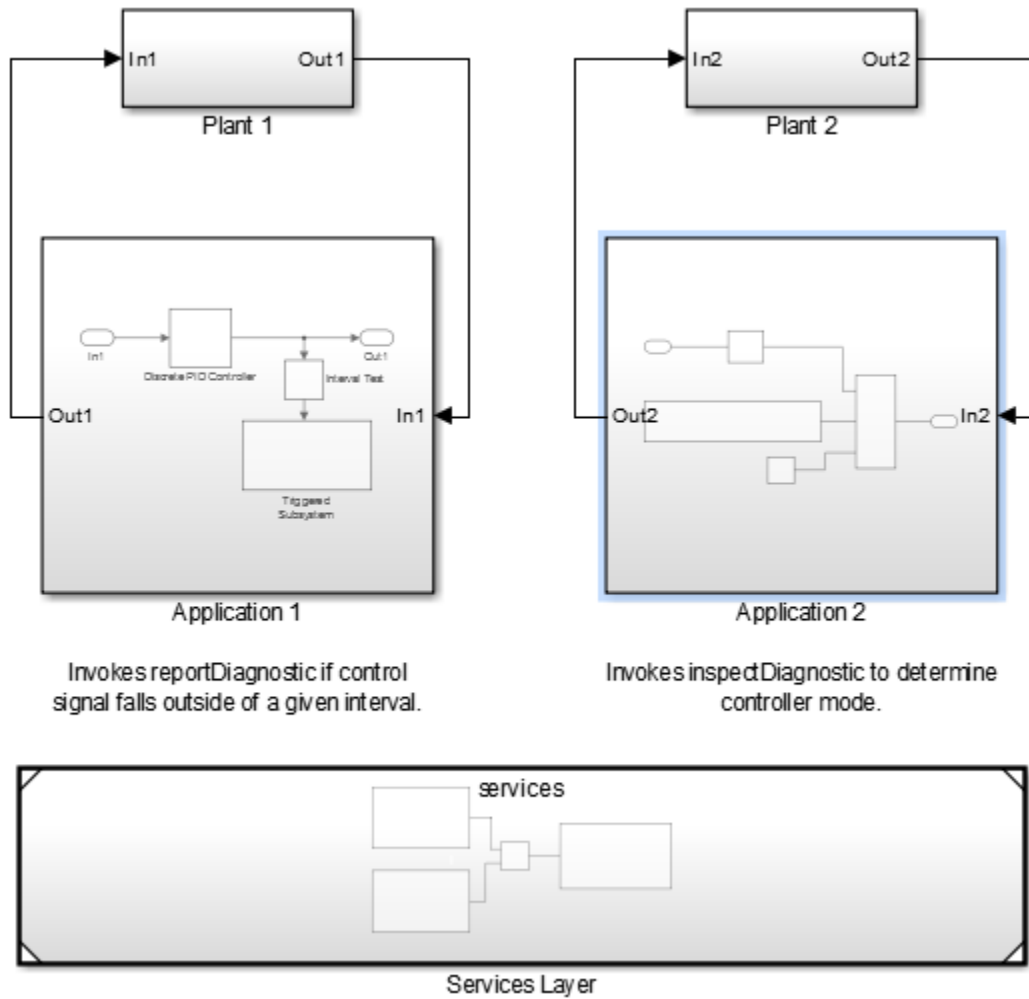

The services (servers), modeled using Simulink Function blocks, are in a separate model. Add the service model to your system model as a referenced model.

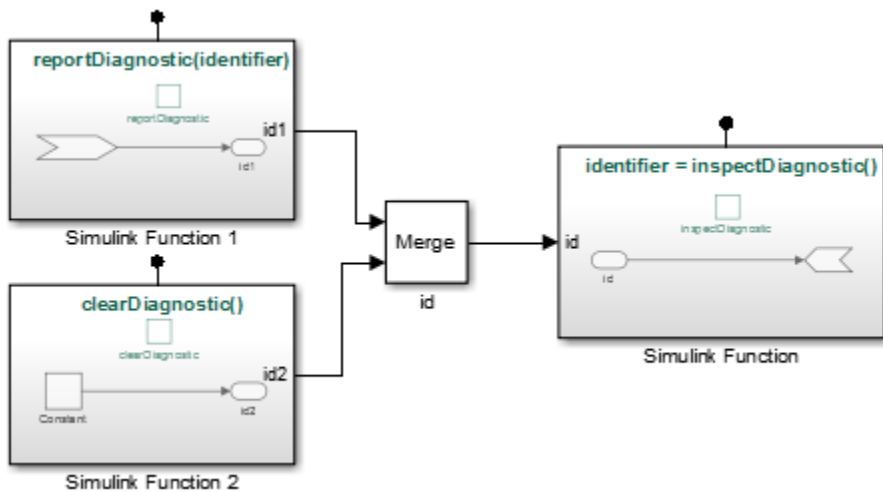

The control applications (clients) interact with the diagnostic interface using Function Caller blocks.

## Modifier Pattern

Application 1 reports a diagnostic condition by invoking the `reportDiagnostic` interface within the service layer. The application calls this function while passing in a diagnostic identifier.

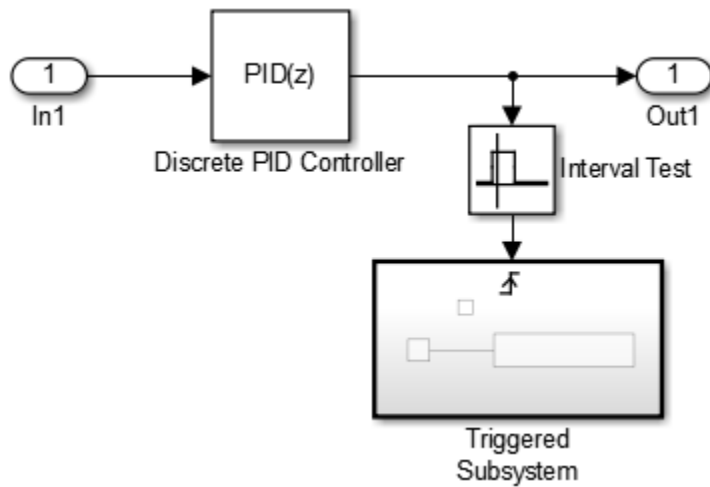

The interval test determines when to create a diagnostic identifier.

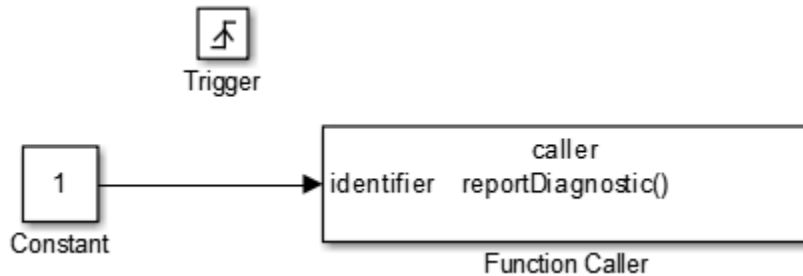

The implementation of the function (Simulink Function 1) tracks the passed-in identifier by transferring the value to a graphical output of the function. A graphical output is a server-side signal that is not part of the server interface but facilitates communication between service functions through function arguments. The value of graphical outputs is held between function invocations.



The `reportDiagnostic` function is an example of a modifier pattern. This pattern helps to communication of data from the caller to the function and later computations based on that data.

### Observer Pattern

Application 2 invokes the `inspectDiagnostic` interface within the service layer to inspect whether diagnostics were reported.

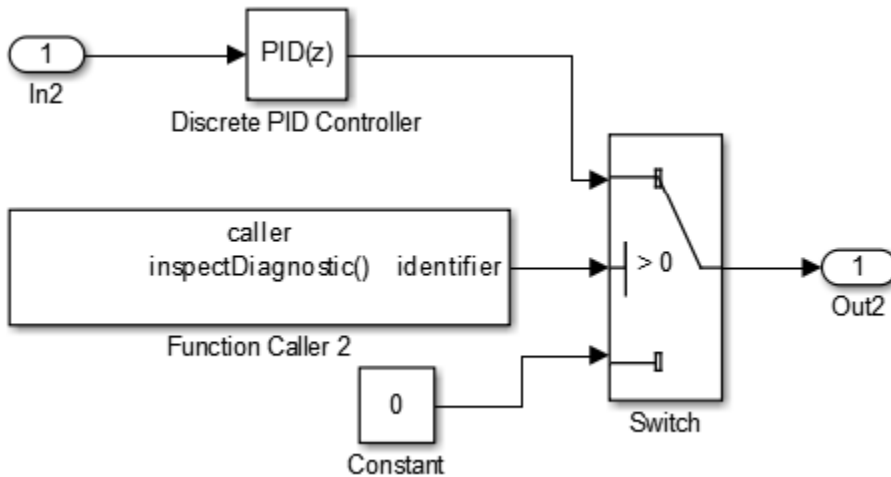

The implementation of the function (Simulink Function) uses a graphical input (`id`) to observe the last reported diagnostic and transfer this value as an output argument (`identifier`) to the caller. A graphical input is a server-side signal that is not part of the server interface.





The `inspectDiagnostic` function is an example of an observer pattern. This pattern helps to communication of data from the function to the caller.

## See Also

### Blocks

Argument Inport | Argument Outport | Function Caller | MATLAB Function | Simulink Function

## Related Examples

- “Simulink Functions in Models” on page 10-93
- “Simulink Functions in Referenced Models” on page 10-116
- “Private Scoping of Simulink Functions” on page 10-125

## More About

- “Simulink Functions” on page 10-82

## Initialize, Reset, and Terminate Function Limitations

In this section...
“Unsupported Blocks” on page 10-136
“Unsupported Features” on page 10-136
“Component I/O Blocks” on page 10-137

### Unsupported Blocks

Initialize, Reset, and Terminate Function blocks do not support:

- Model blocks
- Custom code blocks
- Stateflow charts
- Resettable Subsystem blocks
- Conditional Subsystem blocks with an output port
- Blocks with state, for example, Unit Delay blocks
- Blocks with absolute time, for example, Clock blocks
- MATLAB Function block or MATLAB System block with states

Initialize, Reset, and Terminate Function blocks cannot call Simulink Function blocks with:

- Input or output ports
- An Initialize Function, Reset Function, or Terminate Function block
- Unsupported blocks

### Unsupported Features

Initialize, Reset, and Terminate Function blocks do not support:

- Using variable-size signals
- Logging signals from Inport and Outport blocks

## Component I/O Blocks

The input and output ports of a model component containing Initialize Function, Reset Function, or Terminate Function blocks must connect to root Inport and Outport blocks without intervening blocks.

In this example, an Initialize Function block is placed in a Subsystem block. The model containing the Subsystem block is referenced from a model that is referenced from the root level model. Only the root level model with the **Show model initialize port** parameter selected can have blocks between the input and output ports.

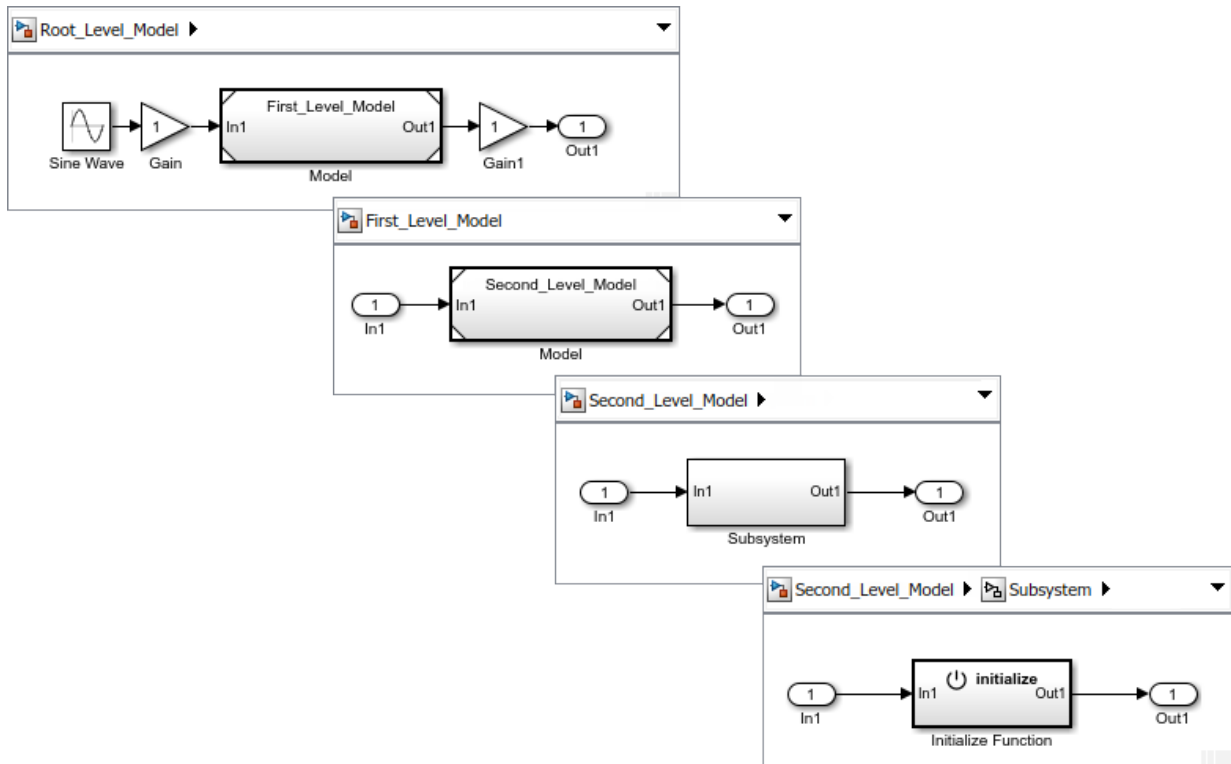

### See Also

#### Blocks

Event Listener | Initialize Function | Reset Function | State Reader | State Writer | Terminate Function

### Related Examples

- “Create Model to Initialize, Reset, and Terminate State” on page 10-139
- “Create Test Harness to Generate Function Calls” on page 10-155

## Create Model to Initialize, Reset, and Terminate State

### In this section...

“Create Model Component with State” on page 10-139

“Initialize Block State” on page 10-141

“Reset Block State” on page 10-144

“Read and Save Block State” on page 10-147

“Prepare Model Component for Testing” on page 10-151

“Create an Export-Function Model” on page 10-152

Some blocks maintain state information that they use during a simulation. For example, the Unit Delay block uses the current state of the block to calculate the output signal value for the next simulation time step.

Subsystem blocks have default initialize and termination routines. You can add custom routines to the default routines using Initialize Function and Terminate Function blocks to change or read block states. These function blocks contain:

- Event Listener blocks that trigger the execution of the combined routines when receiving an initialize or terminate function-call signal.
- State Writer blocks to initialize the block state and State Reader blocks to read the state.

### Create Model Component with State

You can define model algorithms using Simulink blocks. In this example, a single Discrete-Time Integrator block defines the algorithm for integrating an input signal.

- 1 Open a new Simulink model. Save this model with the name `Model01`.
- 2 Add a Discrete-Time Integrator block. Verify the default parameter values are **1.0** for **Gain value**, **0** for **Initial condition**, **State** (most efficient) for **Initial condition setting**, and **-1** for **Sample time**.
- 3 Connect a Constant block to the input of the Discrete-Time Integrator block to model an input signal. Connect a Scope block to the output signal.

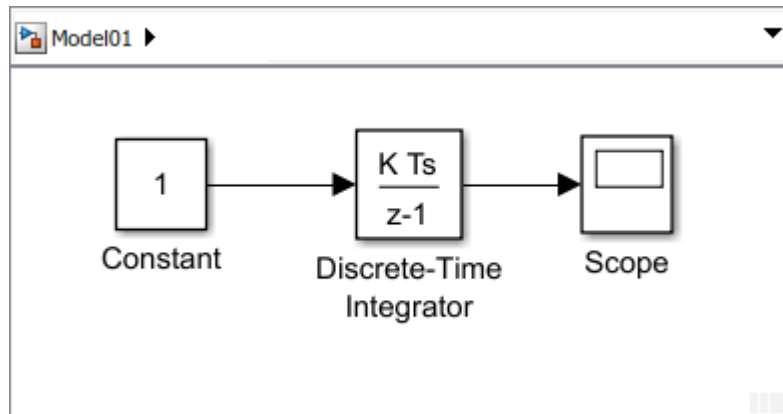

- 4 Open the Configuration Parameters dialog box. Set the simulation parameters for the Solver **Type** to **Fixed-step**, **Solver** to **auto**, and **Fixed-step size** to **1**.
- 5 Open the Scope block, and then run simulation. The output signal increases by 1 at each time step.

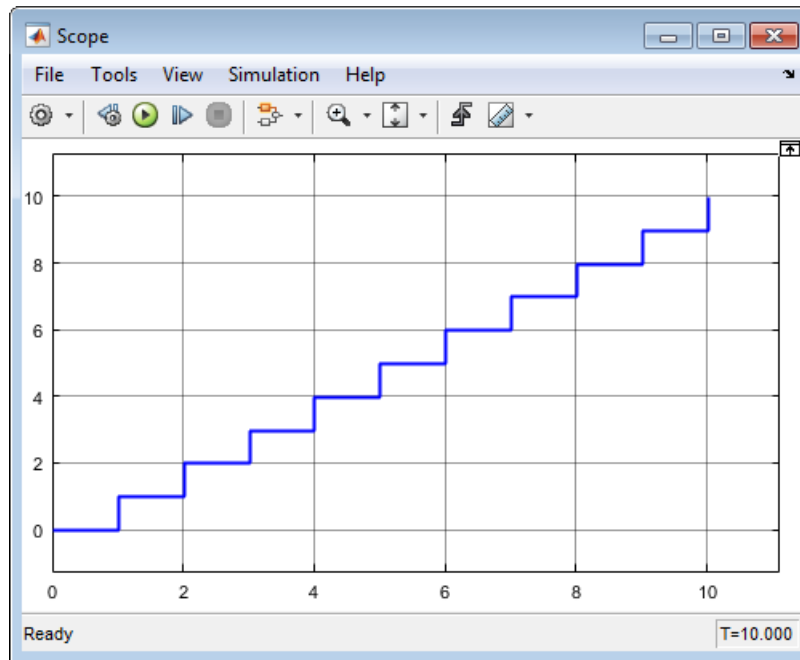

## Initialize Block State

Some model algorithms contain states that you can initialize. For example, with an algorithm that reads a sensor value, you can perform a computation to set the initial sensor state.

At the beginning of a simulation, initialize the state of a block using a State Writer block. To control when initialization occurs, use an Initialize Function block that includes the State Writer block.

- 1 Add an Initialize Function block.

By default, the Initialize Function block includes an Event Listener block with the **Event type** parameter set to **Initialize**. The block also includes a State Writer block, and a Constant block as a placeholder for the source of the initial state value.

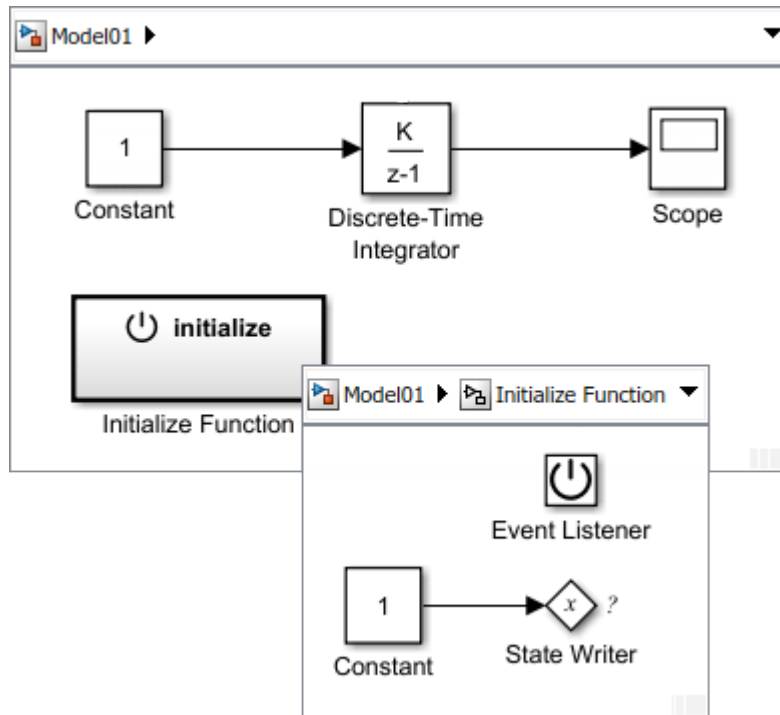

- 2 Model initial conditions. In this example, set the **Constant value** parameter for the Constant block to 4.
- 3 Connect the state writer with the state owner. Open the State Writer dialog box. Expand the State Owner Selector Tree, select **Discrete-Time Integrator**, and then click **Apply**.



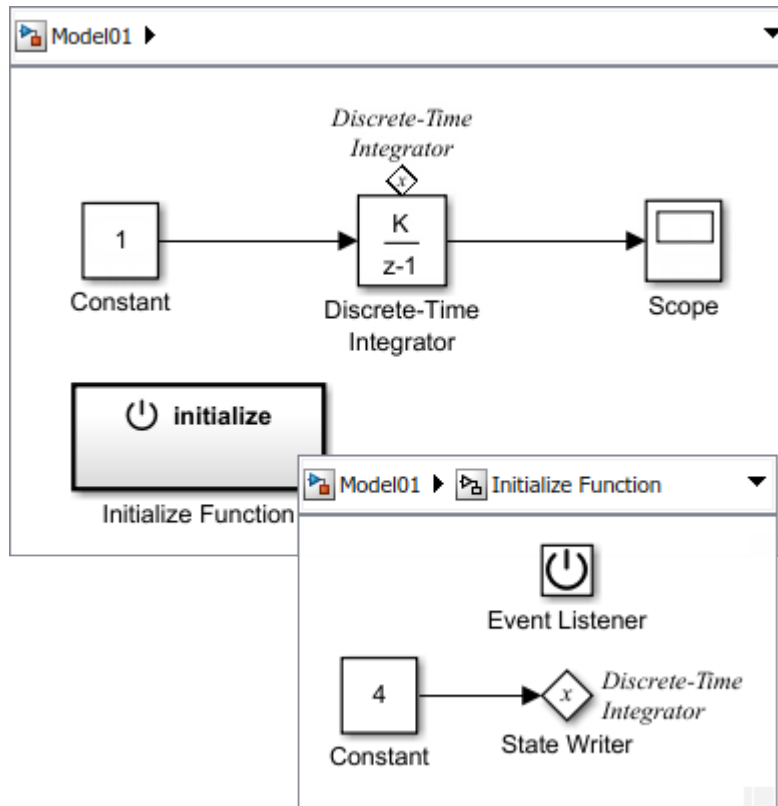

The State Writer block displays the name of the state owner block. The state owner block displays a tag  $x$  indicating a link to a State Writer block. If you click the label above the tag, a list opens with a link for navigating to the State Writer block.

- 4 Run simulation to confirm that your model simulates without errors.

The Initialize Function block executes at the beginning of a simulation. The output signal starts at the initial value of 4 and then increases by 1 until the end of the simulation.

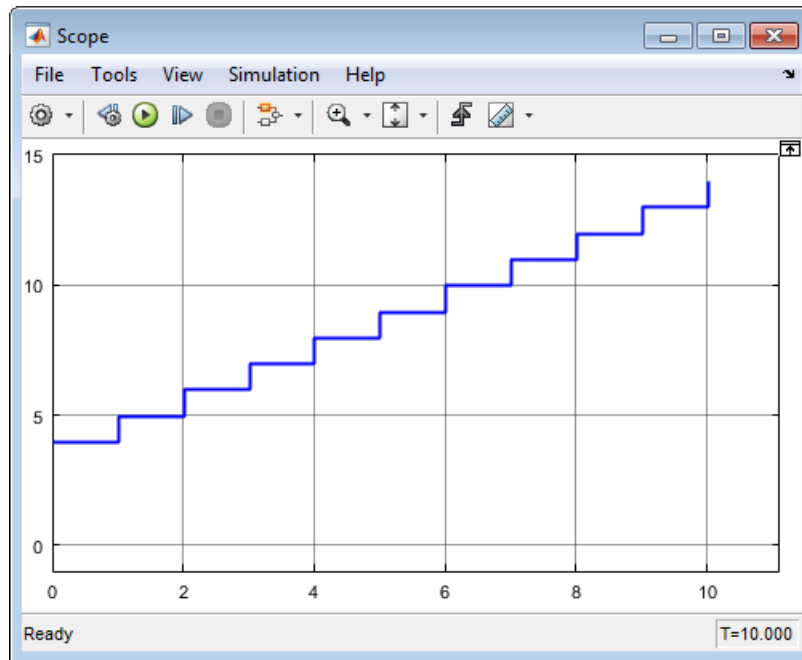

## Reset Block State

During a simulation, you can reset the state of a block using a State Writer block. To control when reset occurs, use an Initialize Function block that you reconfigure to a Reset Function block.

- 1 Add an Initialize Function block.

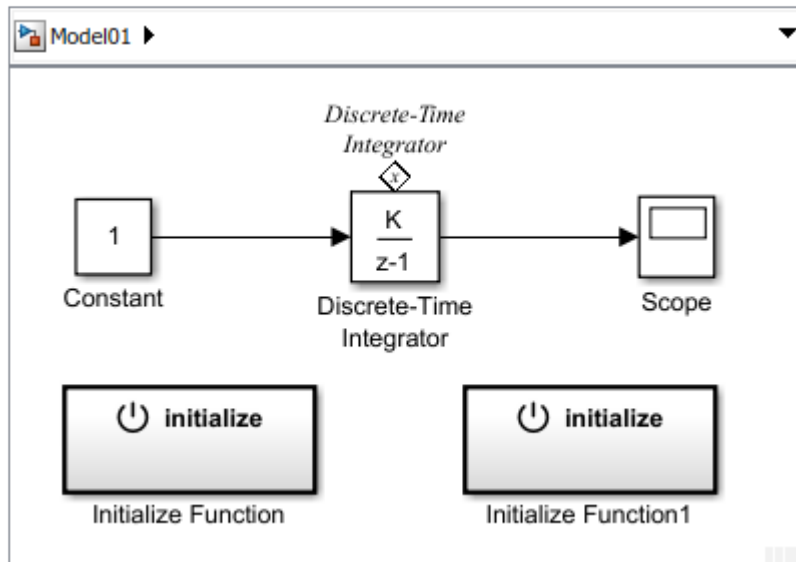

- 2 Open the new Initialize Function block.
- 3 Configure block for reset. Open the Block Parameter dialog box for the Event Listener block. From the **Event type** drop-down list, select **Reset**. In the **Event name** box, enter an event name. For example, enter **reset**. Close the dialog box.
- 4 Model reset conditions. In this example, set the **Constant value** parameter for the Constant block to **6**.
- 5 Connect state writer with the state owner. Open the State Writer dialog box. Expand the State Owner Selector Tree, select **Discrete-Time Integrator**, and then click **Apply**.
- 6 Navigate to the top level of **Model01**. Rename the block from **Initialize Function1** to **Reset Function**.

After updating your model, the event name for the Reset Function block is displayed on the face of the block.

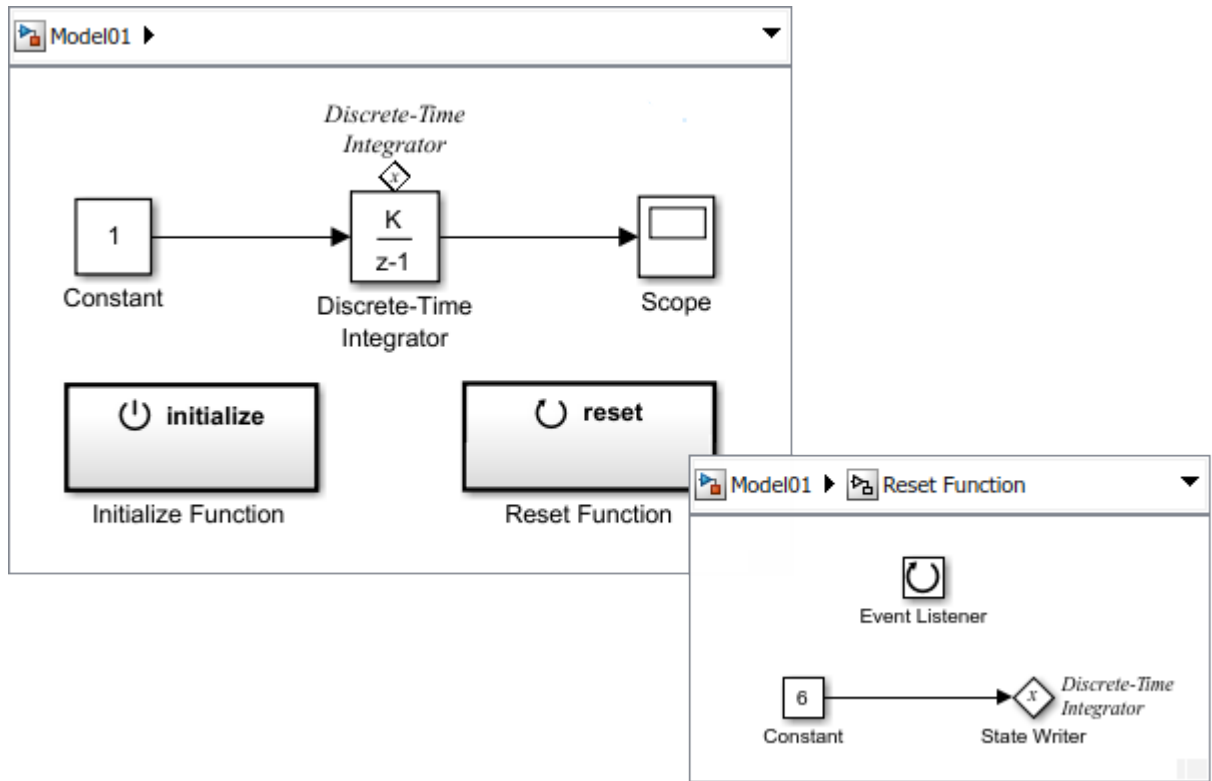

If you click above the tag, a list opens with a link for navigating to the State Writer blocks located in the Initialize Function block and the Reset Function block.

- 7 Run a simulation to confirm that your model simulates without errors.

The Reset Function block does not execute during the simulation. It needs an event signal.

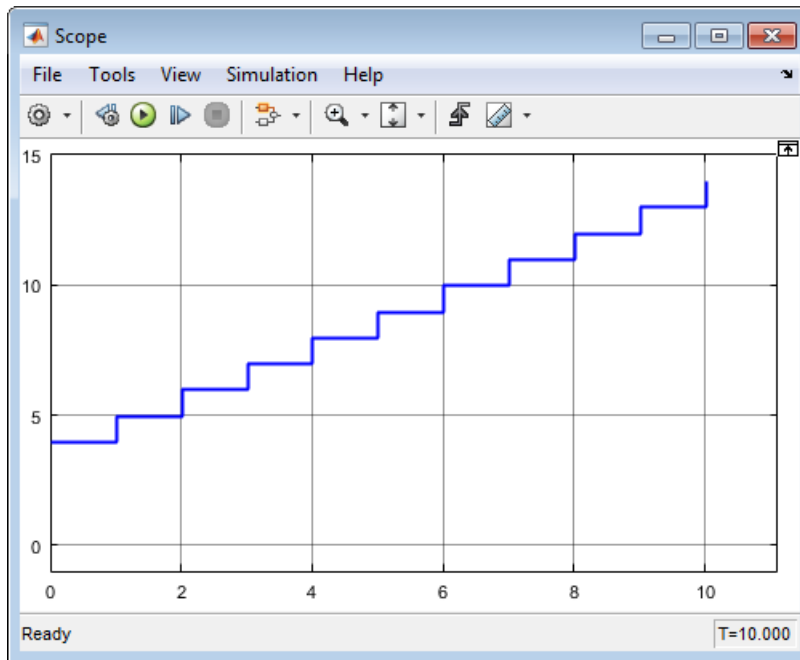

## Read and Save Block State

At the end of a simulation, you can read the state of a block, and save that state.

- 1 Add a Terminate Function block.

By default, the Terminate Function block includes an Event Listener block with the parameter **Event type** set to **Terminate**. The block also includes a State Reader block, and a Terminator block as a placeholder for saving the state value.

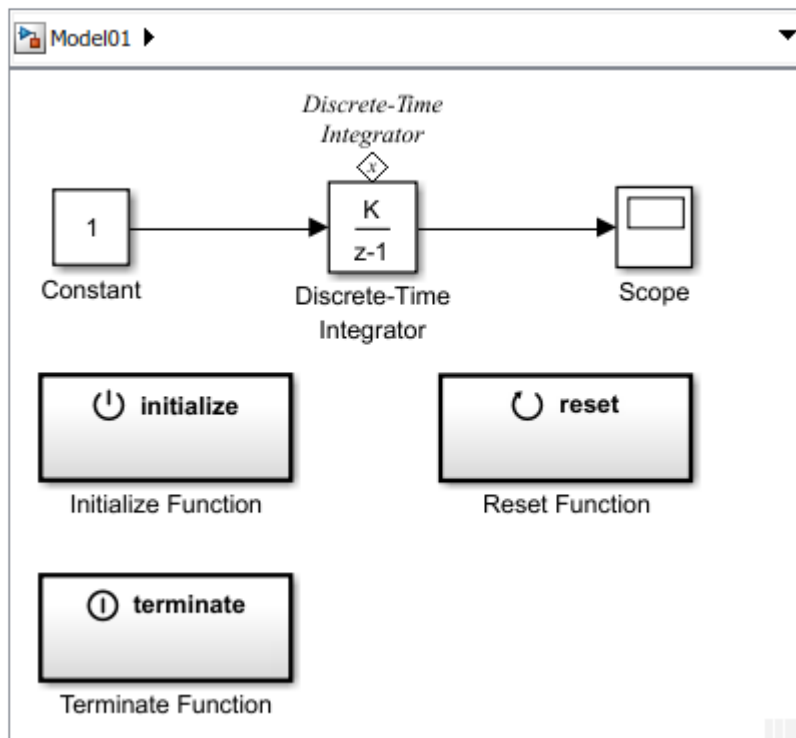

- 2 Connect the state reader with the state owner. Open the State Reader dialog box. From the State Owner Selector Tree, select **Discrete-Time Integrator**, and then click **Apply**.

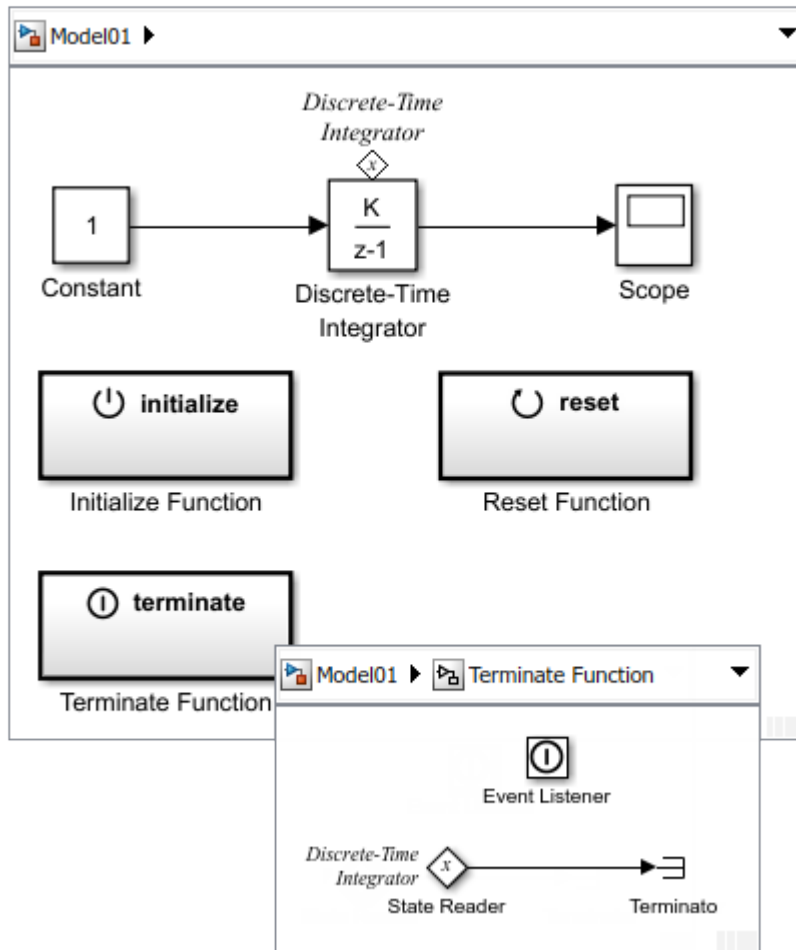

- 3 Run a simulation to confirm that your model simulates without errors. The Terminate Function block executes at the end of a simulation.

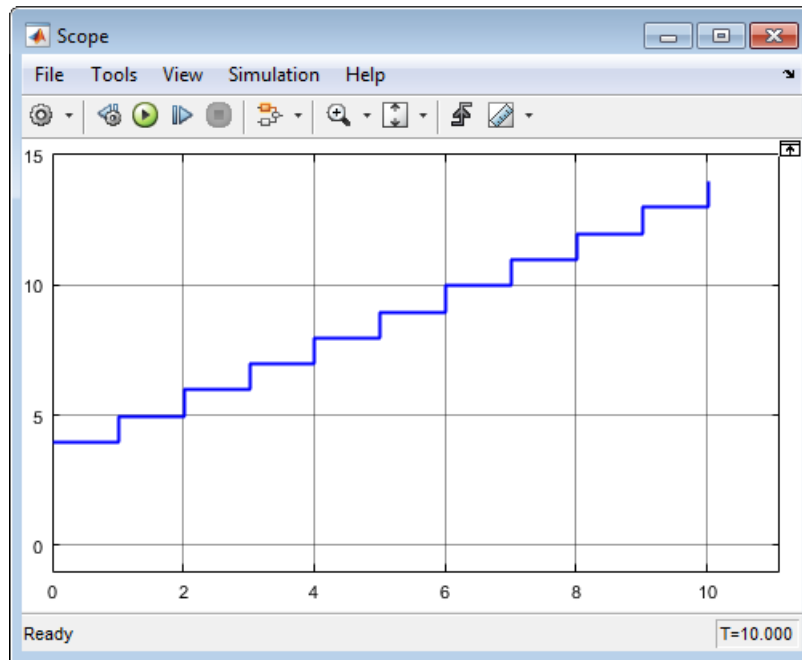

- 4 Delete the blocks that you added for testing. Replace the Constant block with an Inport block and the Scope block with an Outport block.



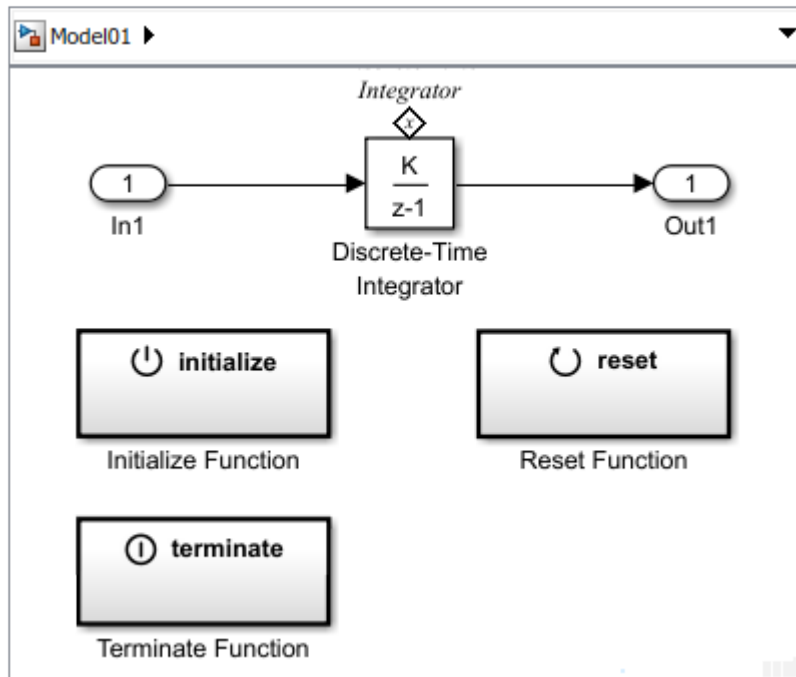

## Prepare Model Component for Testing

Make the following changes to avoid simulation errors when the component model is placed in an Export-Function Model for simulation testing.

- 1 Open the Block Parameters dialog box for the Discrete-Time Integrator block. Set **Integrator method** to Accumulation:Forward Euler.
- 2 Open the Model Configuration Parameters dialog box. Confirm the solver **Type** is set to Fixed-step and **Solver** is set to auto. Change the **Fixed-step size** from 1 to auto.

This change avoids a simulation error caused by having multiple sample times in a Function-Call Subsystem.

## Create an Export-Function Model

Placing a model component in a test harness for testing the initialize, reset, and terminate functions requires the model to follow export-function rules. See “Export-Function Models” on page 10-52 and “Create Test Harness to Generate Function Calls” on page 10-155.

To create an export-function model, place the model component in a Function-Call Subsystem block using a Model block. Connect input and output ports from the model to the subsystem input and output ports.

- 1 Create a Simulink model. Save this model with the name **Model102**.
- 2 Open the Configuration Parameters dialog box. Set the simulation parameter for the Solver **Type** to **Fixed-step**. Confirm **Solver** is set to **auto** and **Fixed-step size** is set to **auto**.
- 3 Add a Function-Call Subsystem block. Open the subsystem by double-clicking the block.
- 4 Add a Model block to the subsystem and set **Model name** to **Model102**. Add Inport and Outport blocks.

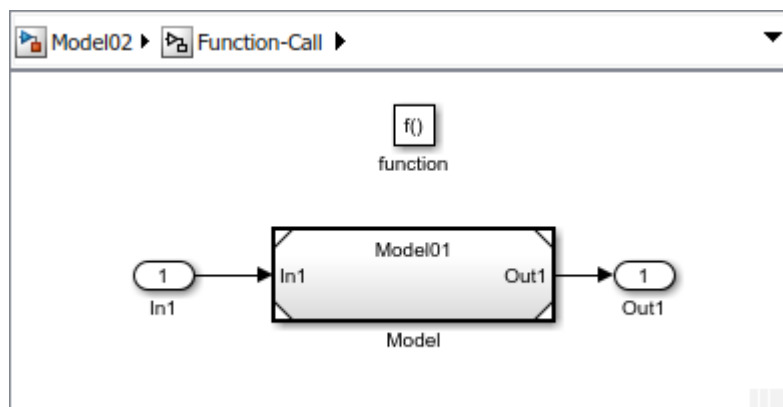

- 5 Navigate to the top level of the model.
- 6 Add an Inport block. This block is the control signal for executing the subsystem. Change the block name to **RUN** and connect it to the **function()** port.

Open the Inport block dialog box and on the Signal Attributes tab, select the **Output function call** check box.

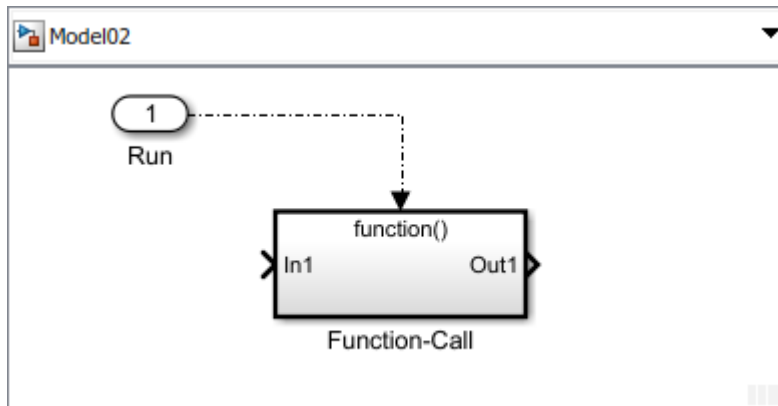

- 7 Add a second Inport block and rename it to **Signal In**. Connect it to the **In1** port of the subsystem. This block is the signal for the integration algorithm.

Add an Outport block, rename it to **Signal Out**, and then connect it to the **Out1** port of the subsystem. This block is the integrated signal.

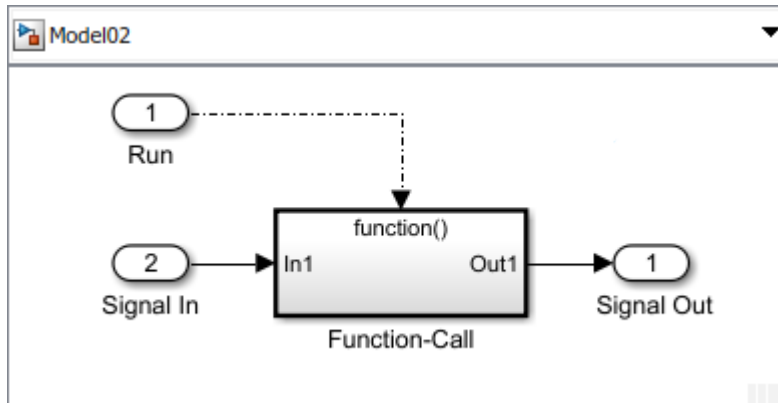

- 8 Open the Configuration Parameters dialog box. On the Model Referencing pane, set the **Total number of instances allowed per top model** to one.

Since logging root-level Outport blocks or signals in **Dataset** format are not supported, on the Data Import/Export pane, clear the **Time** and **Output** check boxes.

- 9 Update your model and confirm that there are no errors by pressing **Ctrl-D**.

The next step is create a test harness. See “Create Test Harness to Generate Function Calls” on page 10-155.

### See Also

#### Blocks

Event Listener | Initialize Function | Reset Function | State Reader | State Writer | Terminate Function

### Related Examples

- “Create Test Harness to Generate Function Calls” on page 10-155
- “Generate Code That Responds to Initialize, Reset, and Terminate Events” (Simulink Coder)
- Initialize and Terminate Functions video

## Create Test Harness to Generate Function Calls

### In this section...

“Reference the Export-Function Model” on page 10-155

“Model an Event Scheduler” on page 10-158

“Connect Chart to Test Model” on page 10-160

After you create a model component to initialize, reset, and terminate the state of blocks (see “Create Model to Initialize, Reset, and Terminate State” on page 10-139), you can place the model in a simulation test harness. A test harness is a Simulink model that you use to develop, test, and debug a model component.

To create the test harness, reference the export-function model containing the model component in a new model, and then add a Stateflow chart to model an event scheduler.

### Reference the Export-Function Model

The export-function model contains the model component for testing. To create the export function model, see “Create an Export-Function Model” on page 10-152.

- 1 Create a new Simulink model. Save this model with the name `Test_Model`.
- 2 Set Model Configuration Parameters for solver **Type** to **Fixed-step**, Solver to **auto**, and **Fixed-step size** to 1.
- 3 Add a Model block. Open the Block Parameters dialog box. In the **Model name** text box, enter the name of your export-function model. In this example, enter `Model02`.
- 4 Test the referenced model component by connecting a Function-Call Generator block to the **Run** port. Connect a Constant block to the **Signal In** port and a Scope block to the **Signal Out** port.

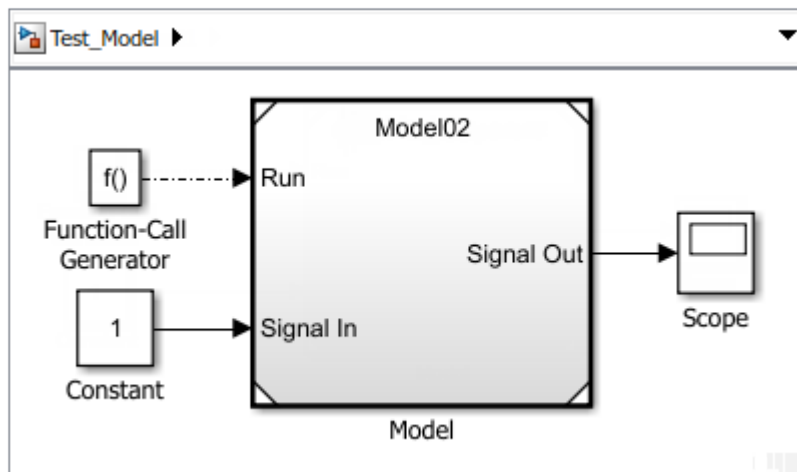

- 5 Run simulation to verify your model simulates correctly from the parent model. When the model is simulated without event ports, the Initialize Function block executes at the beginning of a simulation and the Terminate Function block executes at the end of the simulation.

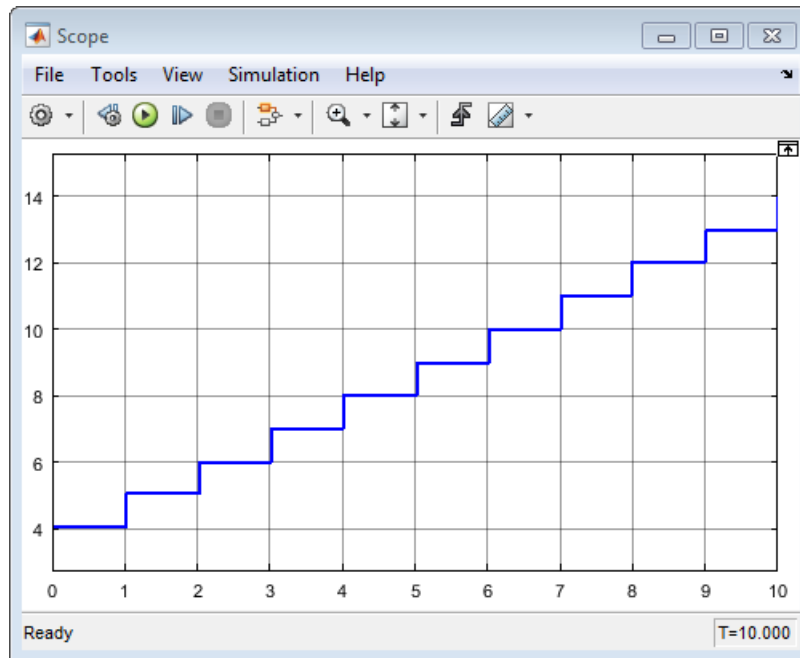

- 6 Expose function-call ports on the model block. Right-click the Model block and select **Block Parameters**. In the Block Parameters dialog box, select the **Show model initialize port**, **Show model reset port**, and **Show model terminate port** check boxes.
- 7 Delete the Function-Call Generator block and update the model by pressing **Ctrl-D**.

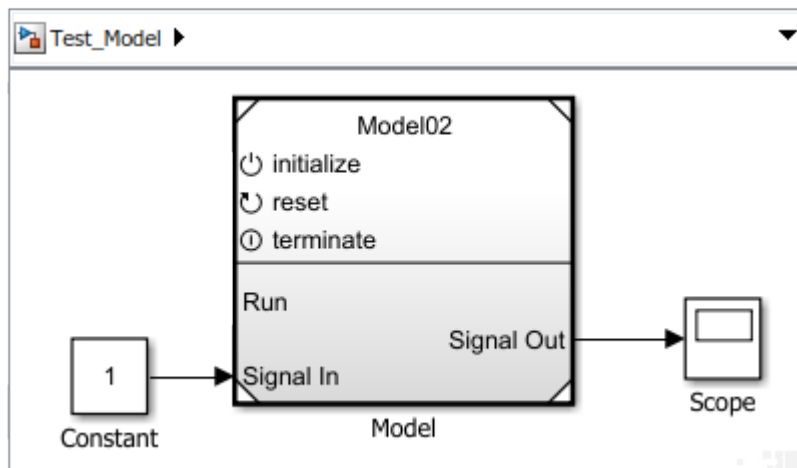

When you activate the initialize function-call port on a Model block, the model has to receive an initialize function call on the `initialize` port before it can execute. The reception of a function call triggers the execution of the default model initialize routine, and then the execution of the Initialize Function block contents.

The reception of a function call on the `Reset` port triggers the execution of the Reset Function block contents.

The reception of a function call on the `Terminate` port triggers the execution of the Terminate Function block contents, and then the execution of the default model terminate routine. The model then stops running. To execute the model again, you have to reinitialize the model by sending an event signal to the `initialize` port.

## Model an Event Scheduler

Use a Stateflow chart to model an event schedule and generate the initialize and terminate function call signals.

- 1 Add a Stateflow Chart. Click the model diagram and start typing `Chart`. From the search list, select .
- 2 Open the chart and add two state blocks, one above the other.
- 3 Add a default transition and connect it to the top state block. Edit the label:



```
{step = 0}
```

- 4 Add a transition from the top block to the bottom block. Edit the label:

```
[step == 2]/{Initialize}
```

- 5 Add a transition from the bottom block to top block. Edit the label:

```
[step == 9]/{Reset}
```

- 6 Add a transition from the bottom block and back to the bottom block. Edit the label:

```
[step == 5]/{Terminate}
```

- 7 Edit the content of the top block:

```
Inactive
entry: step = step + 1;
during: step = step + 1;
```

- 8 Edit the content of the bottom block:

```
Running
entry: step = step + 1; Run;
during: step = step + 1; Run;
```

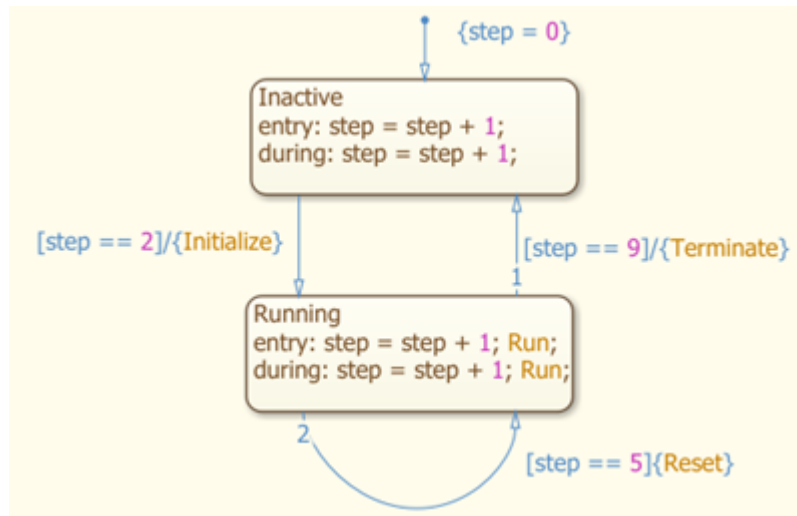

## Connect Chart to Test Model

Create function-call ports on the chart to control and run the model component.

- 1 Open Model Explorer. **View > Model Explorer > Model Explorer.**
- 2 Create index variable. From the menu, select **Add > Data**. In the Data dialog box, enter **Step** for the **Name**.
- 3 Create function-call ports. For each event you create, select **Add > Event** and in the Event dialog box, enter, and select the following values.

Enter in Event text box	Set Scope	Set Trigger
Initialize	Output to Simulink	Function call
Reset	Output to Simulink	Function call
Terminate	Output to Simulink	Function call
Run	Output to Simulink	Function call

- 4 Navigate to the top level of the model. Connect the Initialize, Reset, Terminate, and Run ports on the chart to the initialize, reset, terminate, and Run input ports on the Model block.

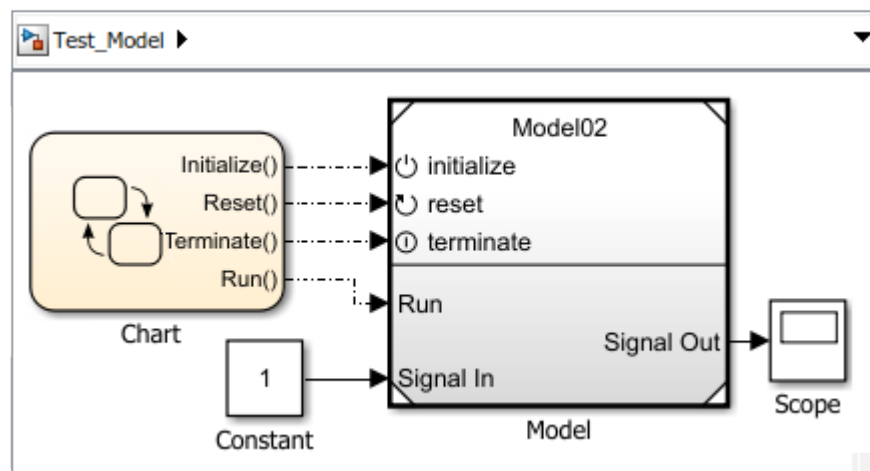

- 5 Run simulation.

The model cannot execute until the second time step, when the block state is initialized to 4. At the fifth time step, a reset function call to the reset port triggers

the Reset Function block to execute. At the ninth time step, the subsystem stops executing, and the block state remains constant.

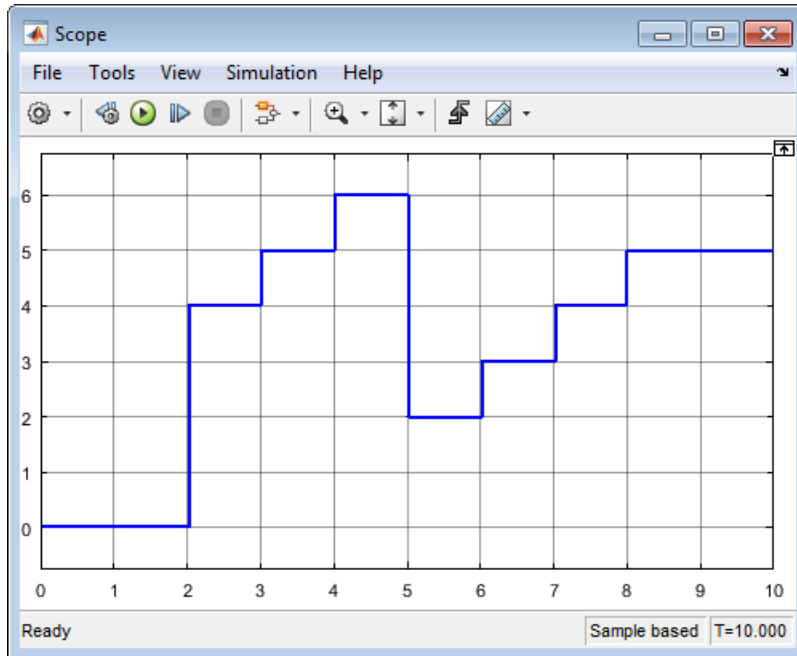

If the model receives a function call to run before an initialize function call, a simulation error occurs.

## See Also

### Blocks

Event Listener | Initialize Function | Reset Function | State Reader | State Writer | Terminate Function

## Related Examples

- “Create Model to Initialize, Reset, and Terminate State” on page 10-139
- Initialize and Terminate Functions video



# Modeling Variant Systems

---

- “What Are Variants and When to Use Them” on page 11-2
- “Working with Variant Choices” on page 11-12
- “Introduction to Variant Controls” on page 11-16
- “Create a Simple Variant Model” on page 11-25
- “Create Variant Controls Programmatically” on page 11-29
- “Define, Configure, and Activate Variants” on page 11-31
- “Prepare Variant-Containing Model for Code Generation” on page 11-40
- “Set up Model Variants” on page 11-45
- “Visualize Variant Implementations in a Single Layer” on page 11-51
- “Define and Configure Variant Sources and Sinks” on page 11-54
- “Variant Condition Propagation with Variant Sources and Sinks” on page 11-61
- “Create and Validate Variant Configurations” on page 11-73
- “Import Control Variables to Variant Configuration” on page 11-77
- “Define Constraints” on page 11-81
- “Reduce Models Containing Variant Blocks” on page 11-84
- “Condition Propagation with Variant Subsystem” on page 11-93
- “Variants Example Models” on page 11-102
- “Use Subsystem Variants To Generate Code That Uses C Preprocessor Conditionals” on page 11-104
- “Propagating Variant Conditions to Subsystems” on page 11-111
- “Variant Subsystems” on page 11-114
- “Model Reference Variants” on page 11-123
- “Variant Source and Variant Sink Blocks” on page 11-128
- “Control Variant Condition Propagation” on page 11-132
- “Propagate Variant Condition to Conditional Subsystem” on page 11-137

## What Are Variants and When to Use Them

### In this section...

“What Are Variants?” on page 11-2

“Advantages of Using Variants” on page 11-4

“When to Use Variants” on page 11-5

“Options for Representing Variants in Simulink” on page 11-6

“Mapping Inports and Outports of Variant Choices” on page 11-7

“Variant Badges” on page 11-8

“Comment Out and Comment Through” on page 11-10

### What Are Variants?

In Simulink, you can use the variant blocks to create a single model that caters to multiple variant requirements. Such models have a fixed common structure and a finite set of variable components. The variable components are activated depending on the variant choice that you select. Thus, the resultant active model is a combination of the fixed structure and the variable components based on the variant choice.

The use of variant blocks in a model helps in reusability of the model for different conditional expressions called variant choices. This approach helps you to meet diverse customer requirements based on application, cost, or operational considerations.

You can use these variants blocks depending on the model design:

- Variant Subsystem: For hierarchical model structure.
- Inline Variants: For flat model structure.
  - Variant Source
  - Variant Sink
  - Manual Variant Source
  - Manual Variant Sink
- Model Variants

---

**Note:** You can convert a Subsystem block available in a model to a Variant Subsystem block. To do so, right-click the Subsystem block, in the context menu, click **Subsystem & Model Reference > Convert Subsystem to > Variant Subsystem**.

---

Suppose you want to simulate a model that represents an automobile with several configurations. These configurations, although similar in several aspects, can differ in properties such as fuel consumption, engine size, or emission standard. Instead of designing multiple models that together represent all possible configurations, you can use variants to model only the varying configurations. This approach keeps the common components fixed.

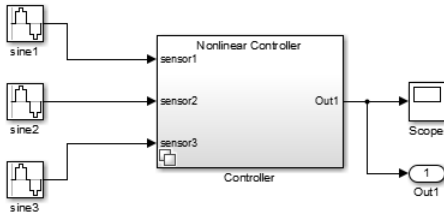

This model contains two variant choices inside a single Variant Subsystem block. Variant choices are two or more configurations of a component in your model.

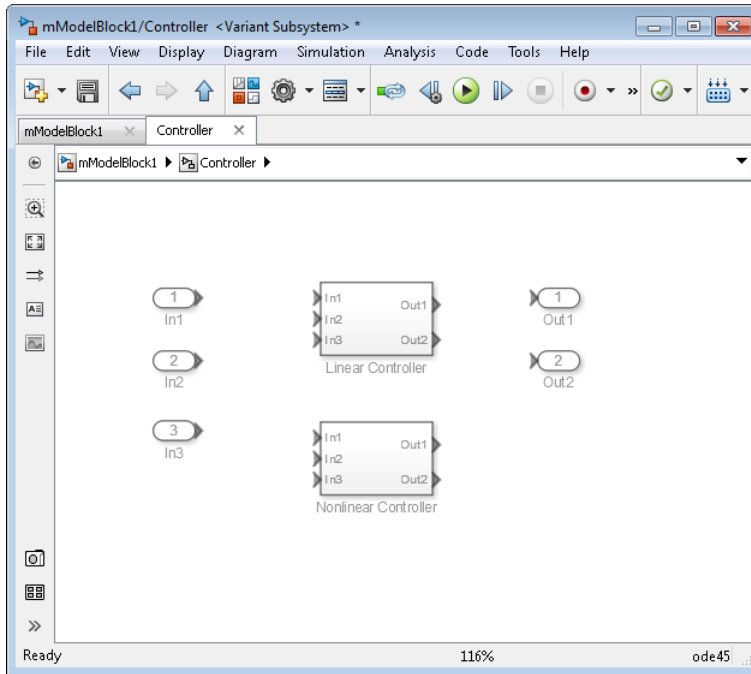

## Advantages of Using Variants

Using variants in Model-Based Design provides several advantages:

- Variants provide you a way to design one model for many systems.
- You can rapidly prototype design possibilities as variants without having to comment out sections of your model.
- Variants help you develop modular design platforms that facilitate reuse and customization. This approach improves workflow speed by reducing complexity.
- If a model component has several alternative configurations, you can efficiently explore these varying alternatives without altering the fixed, unvarying components.
- You can use different variant configurations for simulation or code generation from the same model.
- You can simulate every design possibility in a combinatorial fashion for a given test suite.



- If you are working with large-scale designs, you can distribute the process of testing these designs on a cluster of multicore computers. Alternatively, you can map different test suites to design alternatives for efficiently managing design-specific tests.
- You can generate a reduced model with a subset of configuration from a master model with many variants.

## When to Use Variants

Variants help you specify multiple implementations of a model in a single, unified block diagram. Here are three scenarios where you can use variants:

- Models that represent multiple simulation, code generation, or testing workflows.

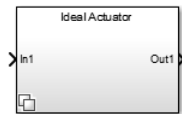

Figure 1. Model of an ideal actuator for basic simulation.

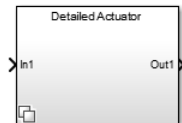

Figure 2. Detailed actuator for simulating customizations.

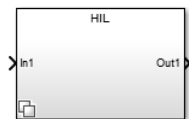
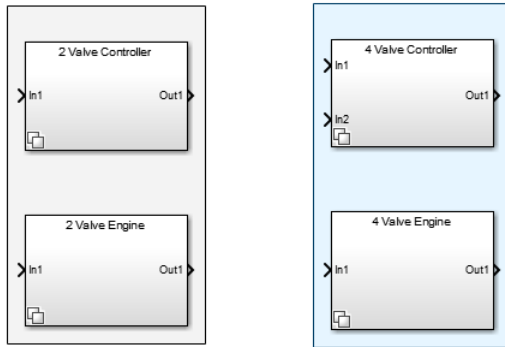

Figure 3. Model that is configured for Hardware-in-the-Loop simulation.

- Models that contain multiple design choices at the component level.



Subsystem blocks representing variant choices can have inports and outports that differ in number from the inports and outports in the parent Variant Subsystem block. See “Mapping Inports and Outports of Variant Choices” on page 11-7.

- Models that are mostly similar but have slight variations, such as in cases where you want to separate a test model from a debugging model.

The test model on the left has a fixed design. On the right, the same test model includes a variant that is introduced for debugging purposes.

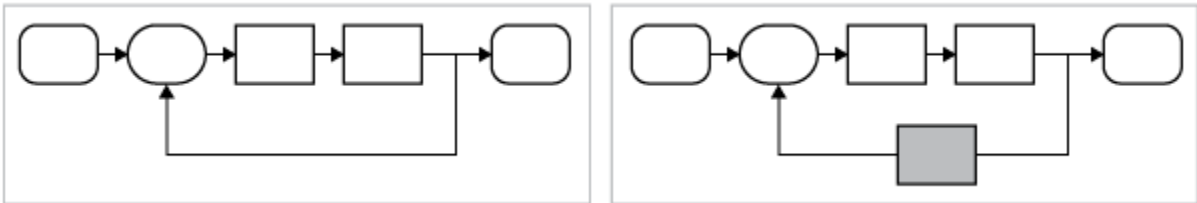

Simulink selects the active variant during update diagram time and during code compile time.

## Options for Representing Variants in Simulink

You can represent one or more variants as variant choices inside these blocks.

	<b>Variant Source and Variant Sink blocks</b>	<b>Variant Subsystem block</b>	<b>Model Variant block</b>
Variant choice representation	Number of ports	Subsystem or Model block	Only Model block
Allows choice hierarchy	No	Yes	Yes
Mismatched number of inports and outports among variant choices	Simulink disables inactive ports	Simulink disables inactive ports	Requires manual resolution of disconnected signal lines
Option to specify default variant	Yes	Yes	No
Supports control ports	No	No	Yes
Can be saved as standalone file	No	No	Yes
Supports physical modeling connection ports	No	Partially	No
Comment choice	Yes	No	No

In addition, you can represent variant choices using Variant Source and Variant Sink block. These blocks enable the propagation of variant conditions and they allow you to visualize variant choices in a single layer of your model.

You can create variants at several levels inside your model hierarchy.

## Mapping Inports and Outports of Variant Choices

A Variant Subsystem is a container of variants choices that are represented as Subsystem or Model blocks. The inputs that the Variant Subsystem block receives from upstream models components map to the inports and outports of the variant choices.

Subsystem and Model blocks representing variant choices can have inports and outports that differ in number from the inports and outports in the parent Variant Subsystem block. However, the following conditions must be satisfied:

- The names of the inports of a variant choice are a subset of the inport names used by the parent variant subsystem.
- The names of the outports of a variant choice are a subset of the outport names used by the parent variant subsystem.





During simulation, Simulink disables the inactive ports in a Variant Subsystem block. If you are specifying variant choices in a Model Variant block, resolve any disconnected signal lines manually when you switch between choices.

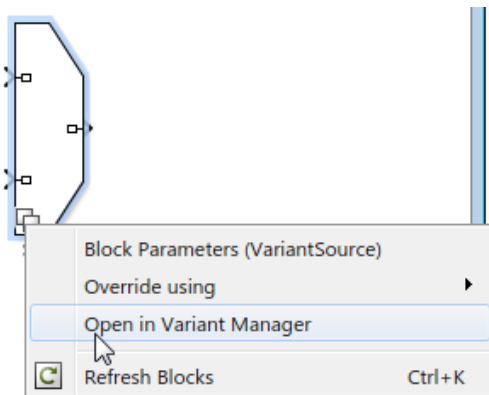

## Variant Badges

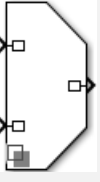
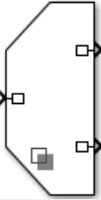
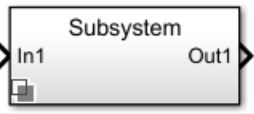
Each Variant block has a badge associated with it. The color and icon of a Variant badge indicate the status of the Variant block. It also provides quick access to few Variant commands. You can right-click the Variant badge to access these commands.

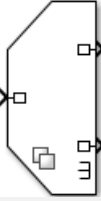
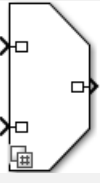
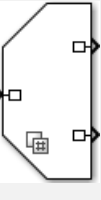

Variant Badge	Variant Source	Variant Sink	Variant Subsystem
Default Variant badge when no option is selected.			

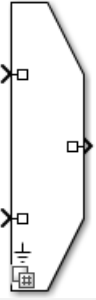
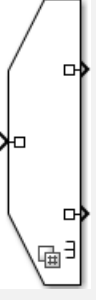
Variant Badge	Variant Source	Variant Sink	Variant Subsystem
<p>Variant block with <b>Override variant conditions and use the following variant</b> option selected.</p>			
<p>Variant block with <b>Allow zero active variant controls</b> option selected.</p>			<p>Not applicable</p>
<p>Variant block with <b>Analyze all choices during update diagram and generate preprocessor conditionals</b> option selected.</p>			
<p>Variant block with <b>Propagate conditions outside of variant subsystem</b> option selected.</p>	<p>Not applicable</p>	<p>Not applicable</p>	

Variant Badge	Variant Source	Variant Sink	Variant Subsystem
Variant block with <b>Analyze all choices during update diagram and generate preprocessor conditionals</b> and <b>Allow zero active variant controls</b> option selected.			Not applicable
Variant block with <b>Analyze all choices during update diagram and generate preprocessor conditionals</b> and <b>Propagate conditions outside of variant subsystem</b> option selected.	Not applicable	Not applicable	

## Comment Out and Comment Through

Consider when you want to simulate a Simulink model by excluding some of its blocks from simulation and without physically removing the blocks from the model. The **Comment Out** and **Comment Through** commands in Simulink provide you with an option to exclude blocks from simulation. Depending on your modeling requirement, you can use these options:

- **Comment Out:** Excludes the selected block from simulation. The signals are terminated and grounded.
- **Comment Through:** Excludes the selected block from simulation. The signals are passed through. To comment through a block, the number of input ports and the output ports for the block must be same.

To access the **Comment Out** or the **Comment Through** options, right-click the block and in the context menu either select **Comment Out** or **Comment Through** based on your modeling requirement.

Alternatively, you can also select the block and press **Ctrl+Shift+X** to comment out or press **Ctrl+Shift+Y** to comment through.

You can use `get_param` and `set_param` commands to view or change the commented state of a block programmatically. For example,

- `get_param(gcb,'commented');` % To view the commented state of the block
- `set_param(gcb,'commented','on');` % To comment out a block
- `set_param(gcb,'commented','through');` % To comment through a block
- `set_param(gcb,'commented','off');` % To uncomment a block

When you comment out a block, the signal names at the output port of the block are ignored. To include such signals during simulation, the signal name must be added at the input port of the block.

**Comment Out** and **Comment Through** are not supported with these blocks: Inport, Outport, Duplicate Port, Connection ports, Argument Inport, Argument Outport, Data Store Memory, Signal Generator, Goto Tag Visibility, For, and While blocks.

## Related Examples

- “Define, Configure, and Activate Variants” on page 11-31
- “Create and Validate Variant Configurations” on page 11-73
- “Create Variant Controls Programmatically” on page 11-29
- “Working with Variant Choices” on page 11-12
- “Transform Model to Variant System” (Simulink Verification and Validation)

## More About

- “Introduction to Variant Controls” on page 11-16
- “Create a Simple Variant Model” on page 11-25
- “Commenting Stateflow Objects in a Chart” (Stateflow)

## Working with Variant Choices

In this section...
“Default Variant Choice” on page 11-13
“Active Variant Choice” on page 11-13
“Inactive Variant Choice” on page 11-14
“Empty Variant Choice” on page 11-14
“Open Active Variant” on page 11-14

Each variant choice in your model is associated with a conditional expression called variant control. The way you specify your variant controls determines the active variant choice.

This image shows the block parameters dialog box of a Variant Subsystem block that contains four variant choices:

- The first choice is empty and has been commented out by adding the % symbol before the variant control.
- The second choice is the default and is activated when no variant control evaluates to `true`.
- The third choice is activated when the expression `mode==3 && version==2` evaluates to `true`.
- The fourth choice is activated when the expression `mode==2 && version==1` evaluates to `true`.



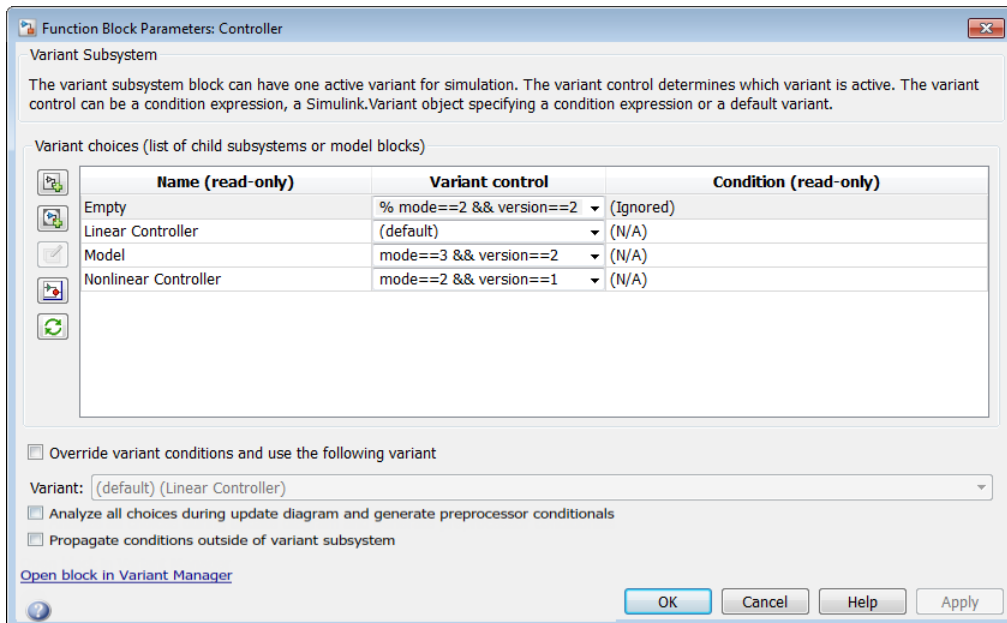

## Default Variant Choice

You can specify almost one variant choice as the default for the model. As shown in the image above, the **Linear Controller** subsystem is defined as the default variant choice. During model compilation, if Simulink finds that no variant control evaluates to true, it uses the default choice.

In the dialog box, select the variant choice and change its **Variant control** property to (default).

## Active Variant Choice

While each variant choice is associated with a variant control, only one variant control can evaluate to true at a time. When a variant control evaluates to true, Simulink activates the variant choice that corresponds to that variant control.

In this example, you can activate either the **Model** variant choice or the **Nonlinear Controller** variant choice by specifying appropriate values for **mode** and **version**.

Value of mode	Value of version	Active variant choice
2	1	Nonlinear Controller
3	2	Model

You can specify the values of `mode` and `version` at the MATLAB Command Window.

You can also override the active variant choice with another variant choice. Right-click the active variant block in the Simulink Editor, and select **Variant > Override using**. Then select your variant choice.

## Inactive Variant Choice

When a variant control activates one variant choice, Simulink considers the other variant choices to be inactive. Simulink ignores inactive variant choices during simulation. However, Simulink continues to execute block callbacks inside the inactive variant choices.

## Empty Variant Choice

When you are prototyping variant choices, you can create empty Subsystem blocks with no inputs or outputs inside the Variant Subsystem block. The empty subsystem recreates the situation in which that subsystem is inactive without the need for completely modeling the variant choice.

For an empty variant choice, you can either specify a variant activation condition or comment out the variant condition by placing a `%` symbol before the condition.

If this variant choice is active during simulation, Simulink ignores the empty variant choice. However, Simulink continues to execute block callbacks inside the empty variant choices.

## Open Active Variant

When you open a model, variant blocks display the name of the variant that was active the last time that you saved your model. Use the **Variant** menu to open the active variant. Right-click the block and select **Variant > Open**. Then select the active variant.

Use this command to find the current active choice:

```
get_param(gcb, 'ActiveVariant')
```

Use this command to find the path to the current active choice:

```
get_param(gcb, 'ActiveVariantBlock')
```

---

**Note:** The `ActiveVariantBlock` parameter is supported only for the Variant Subsystem block.

---

## Related Examples

- “Define, Configure, and Activate Variants” on page 11-31

## More About

- “Introduction to Variant Controls” on page 11-16
- “Create a Simple Variant Model” on page 11-25

## Introduction to Variant Controls

In this section...
“Operands” on page 11-16
“Operators” on page 11-16
“Approaches for Specifying Variant Controls” on page 11-17
“Operators and Operands in Variant Condition Expressions” on page 11-23

The components of a Simulink model that contain Variants are activated or deactivated based on the variant choice that you select.

Each variant choice in your model is associated with a conditional expression called variant control. Variant controls determine which variant choice is active. By changing the value of a variant control, you can switch the active variant choice.

While each variant choice is associated with a variant control, only one variant control can evaluate to true. When a variant control evaluates to true, Simulink activates the variant choice that corresponds to that variant control.

A variant control is a Boolean expression that activates a specific variant choice when it evaluates to `true`.

---

**Note:** You can specify variant controls in the MATLAB workspace or a data dictionary.

---

You can specify variant controls as `Simulink.Variant` objects or as expressions that contain one or more of these operands and operators.

### Operands

- Variable names that resolve to MATLAB variables or `Simulink.Parameter` objects with integer or enumerated data type and scalar literal values
- Variable names that resolve to `Simulink.Variant` objects
- Scalar literal values that represent integer or enumerated values

### Operators

- Parentheses for grouping

- Arithmetic, relational, logical, or bit-wise operators

For more information, see “Operators and Operands in Variant Condition Expressions” on page 11-23.

When you compile the model, Simulink determines that a variant choice is active if its variant control evaluates to `true`.

## Approaches for Specifying Variant Controls

You can use many approaches for switching between variant choices—from options to use while prototyping to options required for generating code from your model.

Specification	Purpose	Example
Scalar variable	Rapid prototyping	<code>A == 1</code>
<code>Simulink.Variant</code> object	Reuse variant conditions	<code>LinearController = Simulink.Variant('FUEL==2 &amp;&amp; EMIS==1');</code>
<code>Simulink.Parameter</code> object	Generate preprocessor conditionals for code generation	<code>mode == 1</code> , where <code>mode</code> is a <code>Simulink.Parameter</code> object
Enumerated type	Improved code readability because condition values are represented as meaningful names instead of integers	<code>LEVEL == Level.Advanced</code>

You can convert MATLAB variables in variant control expressions into `Simulink.Parameter` object using the function `Simulink.VariantManager.findVariantControlVars`.

### Scalar Variables for Rapid Prototyping

Scalar MATLAB variables allow you to rapidly prototype variant choices when you are still building your model. They help you focus more on building your variant choices than on developing the expressions that activate those choices.

Consider a model that contains two variant choices, each represented by a Variant Subsystem block.

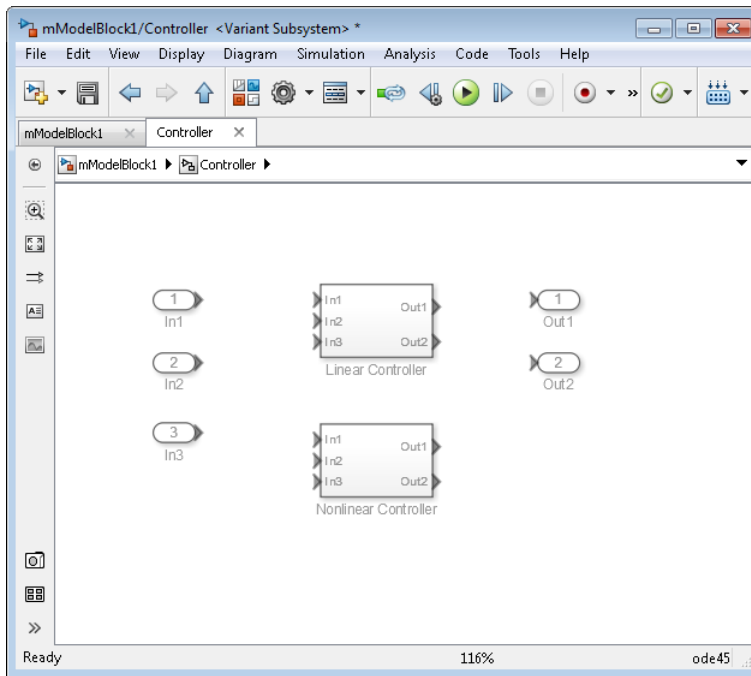

You can specify variant controls in their simplest form as scalar variables in the block parameters dialog box of the Variant Subsystem block.

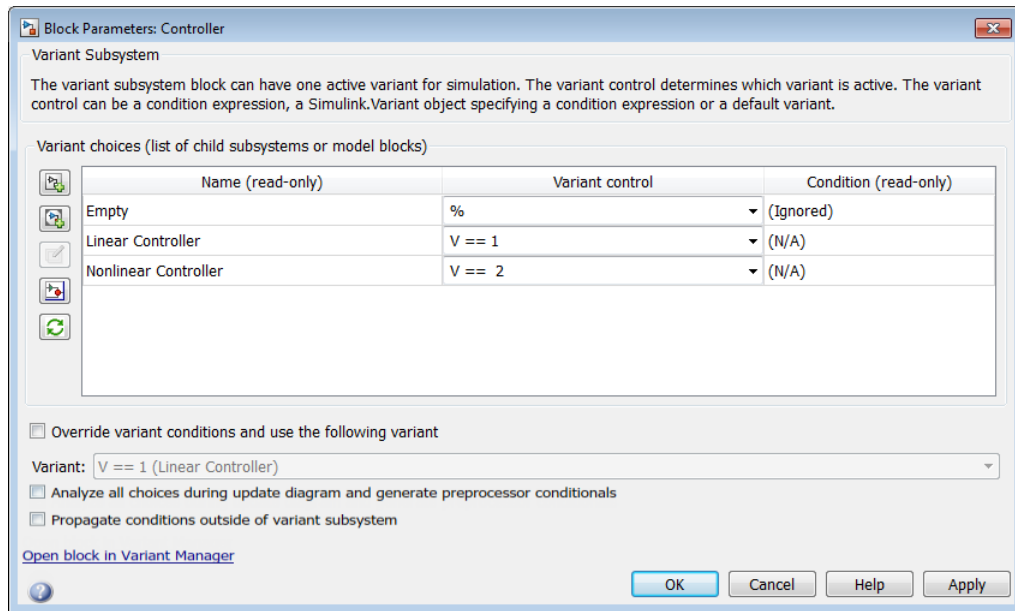

The **Condition** field for both the **Linear Controller** and **Nonlinear Controller** are N/A, because the variant control itself is the condition.

You can activate one of the variant choices by defining a scalar variable **V** and setting its value to **1** at the MATLAB Command Window.

```
V = 1;
```

This condition activates the **Linear Controller** variant choice.

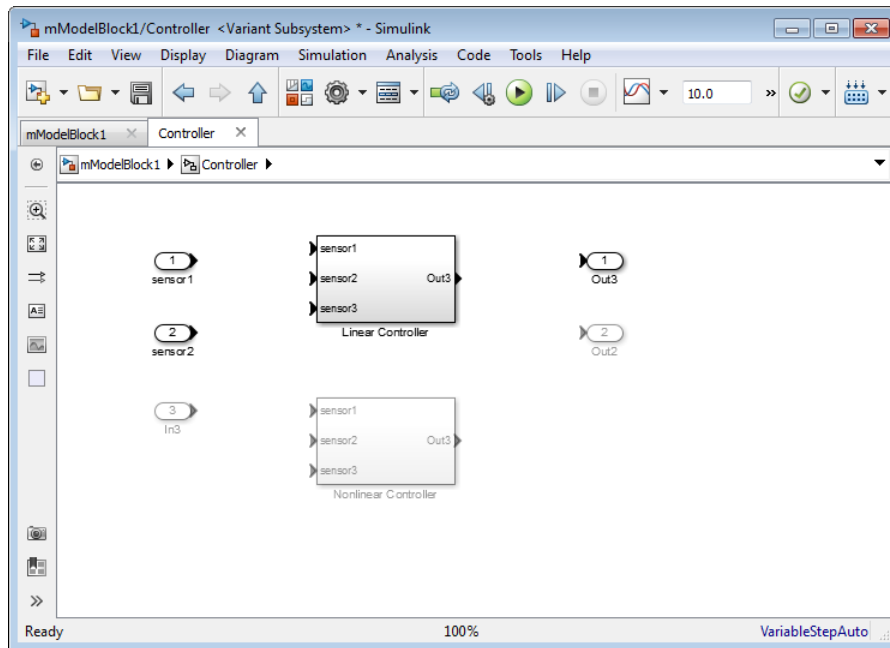

Similarly, if you change the value of  $V$  to 2, Simulink activates the **Nonlinear Controller** variant choice.

### Simulink.Variant Objects for Variant Condition Reuse

After identifying the variant choices that your model requires, you can construct complex variant conditions to control the activation of your variant choices. Define variant conditions as `Simulink.Variant` objects.

`Simulink.Variant` objects enable you to reuse common variant conditions across models and help you encapsulate complex variant condition expressions.

Consider an example where variant controls are already defined in the base workspace.

```
V=1;
V=2;
```

You can convert these controls into condition expressions encapsulated as `Simulink.Variant` objects.

```
LinearController=Simulink.Variant('V==1');
```



```
NonLinearController=Simulink.Variant('V==2');
```

You can then specify these `Simulink.Variant` objects as the variant controls in the block parameters dialog box of the Variant Subsystem block.

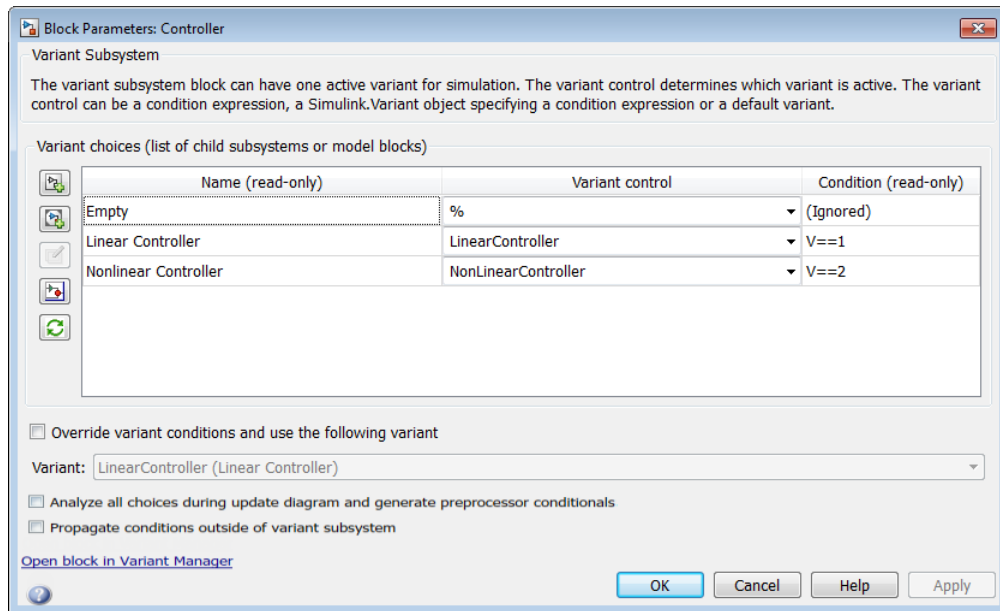

The **Condition** field now reflects the encapsulated variant condition. Using this approach, you can develop complex variant condition expressions that are reusable.

### Simulink.Parameter Objects for Code Generation

If you intend to generate code for a model containing variant choices, specify variant control variables as `Simulink.Parameter` objects. In addition to enabling parameter value specification, `Simulink.Parameter` objects allow you to specify other attributes (such as data type) that are required for generating code.

```
VSSMODE = Simulink.Parameter;
VSSMODE.Value = 1;
VSSMODE.DataType = 'int32';
VSSMODE.CoderInfo.StorageClass = 'Custom';
VSSMODE.CoderInfo.CustomStorageClass = 'ImportedDefine';
VSSMODE.CoderInfo.CustomAttributes.HeaderFile = ...
'rtwdemo_importedmacros.h';
```

Variant control variables defined as `Simulink.Parameter` objects can have one of these storage classes:

- `Define` or `ImportedDefine` with header file specified
- `CompilerFlag`
- `SystemConstant` (AUTOSAR)
- Your own custom storage class that defines data as a macro

You can also convert a scalar variant control variable into a `Simulink.Parameter` object. See “Convert Variant Control Variables into `Simulink.Parameter` Objects” on page 11-40.

### Enumerated Types for Improving Code Readability

Use enumerated types to give meaningful names to integers used as variant control values.

- 1 In the MATLAB Editor, define the classes that map enumerated values to meaningful names.

```
classdef sldemo_mrv_CONTROLLER_TYPE < Simulink.IntEnumType
    enumeration
        NONLINEAR (1)
        SECOND_ORDER (2)
    end
end

classdef sldemo_mrv_BUILD_TYPE < Simulink.IntEnumType
    enumeration
        PROTOTYPE (1)
        PRODUCTION (2)
    end
end
```

- 2 Define `Simulink.Variant` objects for these classes in the base workspace.

```
VE_NONLINEAR_CONTROLLER = Simulink.Variant...
('E_CTRL==sldemo_mrv_CONTROLLER_TYPE.NONLINEAR')
VE_SECOND_ORDER_CONTROLLER = Simulink.Variant...
('E_CTRL==sldemo_mrv_CONTROLLER_TYPE.SECOND_ORDER')
VE_PROTOTYPE = Simulink.Variant...
('E_CURRENT_BUILD==sldemo_mrv_BUILD_TYPE.PROTOTYPE')
VE_PRODUCTION = Simulink.Variant...
('E_CURRENT_BUILD==sldemo_mrv_BUILD_TYPE.PRODUCTION')
```

Using enumerated types simplifies the generated code because it contains the names of the values rather than integers.

## Operators and Operands in Variant Condition Expressions

Simulink evaluates condition expressions within variant controls to determine the active variant choice. You can include the following operands in a condition expression:

- Scalar variables
- `Simulink.Parameter` objects that are not structures and that have data types other than `Simulink.Bus` objects
- Enumerated types
- Parentheses for grouping

Variant condition expressions can contain MATLAB operators, provided the expression evaluates to a boolean value. In these examples, `A` and `B` are expressions that evaluate to an integer, and `x` is a constant integer literal.

MATLAB Expressions That Support Generation of Preprocessor Conditionals	Equivalent Expression in C Preprocessor Conditional
<b>Arithmetic</b>	
<ul style="list-style-type: none"> <li>• <code>A + B</code></li> <li>• <code>+A</code></li> </ul>	<ul style="list-style-type: none"> <li>• <code>A + B</code></li> <li>• <code>A</code></li> </ul>
<ul style="list-style-type: none"> <li>• <code>A - B</code></li> <li>• <code>-A</code></li> </ul>	<ul style="list-style-type: none"> <li>• <code>A - B</code></li> <li>• <code>-A</code></li> </ul>
<code>A * B</code>	<code>A * B</code>
<code>idivide(A,B)</code>	<code>A / B</code>  If the value of the second operand (B) is 0, the behavior is undefined.
<code>rem(A,B)</code>	<code>A % B</code>  If the value of the second operand (B) is 0, the behavior is undefined.
<b>Relational</b>	

<b>MATLAB Expressions That Support Generation of Preprocessor Conditionals</b>	<b>Equivalent Expression in C Preprocessor Conditional</b>
A == B	A == B
A ~= B	A != B
A < B	A < B
A > B	A > B
A <= B	A <= B
A >= B	A >= B
<b>Logical</b>	
~A	!A, where A is not an integer
A && B	A && B
A    B	A    B
<b>Bit-wise (A and B cannot both be constant integer literals)</b>	
bitand(A,B)	A & B
bitor(A,B)	A   B
bitxor(A,B)	A ^ B
bitcmp(A)	~A
bitshift(A,x)	A << x
bitshift(A,-x)	A >> x

## Related Examples

- “Define, Configure, and Activate Variants” on page 11-31
- “Create and Validate Variant Configurations” on page 11-73
- “Create Variant Controls Programmatically” on page 11-29
- “Working with Variant Choices” on page 11-12

## More About

- “Create a Simple Variant Model” on page 11-25

## Create a Simple Variant Model

- 1 Create a model that contains variant blocks. For example, see `sldemo_variant_subsystems` that contains a Variant Subsystem block (Controller).

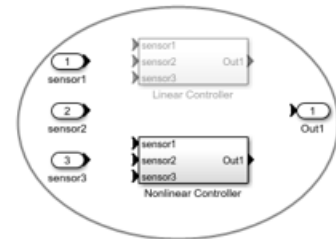
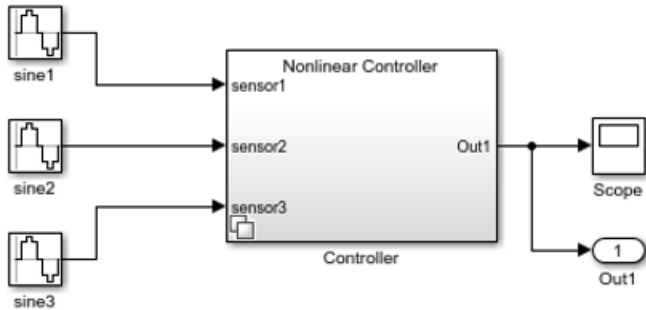

Components of 'Controller' block

- 2 Define variant control variables that determine the condition under which a variant choice is active.
  - a Right-click the variant block and click **Block Parameters**. The Block Parameters dialog box for the variant block opens.
  - b Use the options available on the Block Parameter dialog box to add variant controls and its corresponding variant condition.

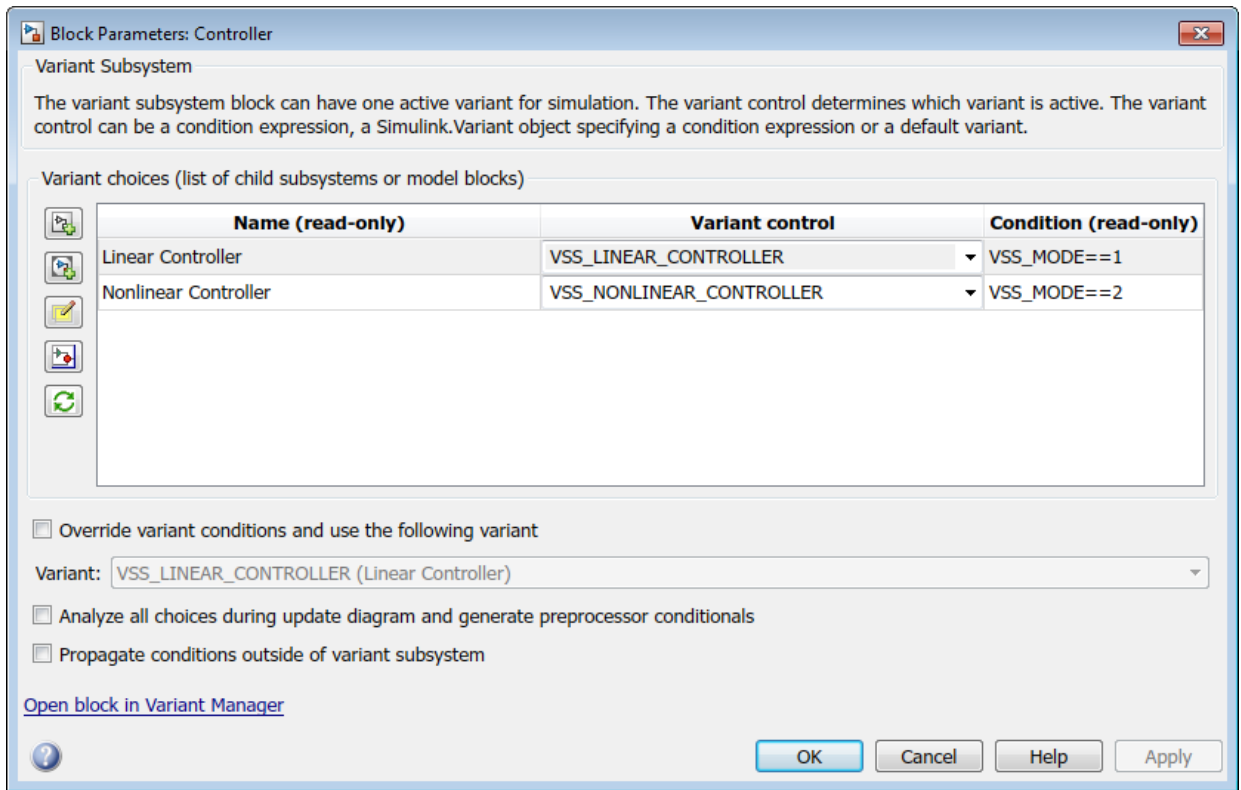



---

**Note:** The variables used to specify the variant control and variant condition must be defined in the base workspace or data dictionary for the model.

---

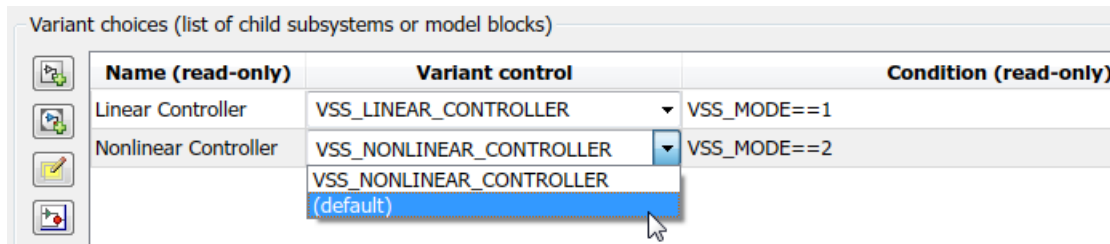
- 3 Specify a default variant condition to be used when there is no active variant choice. Use the **Variant control** dropdown menu to specify the default.



- 4 To activate a variant choice, type the variant choice in MATLAB command window. For example, type `VSS_MODE = 2`.
- 5 To simulate the model, click **Simulation > Run**. The model simulates for the specified active choice.
- 6 Modify the active choice and simulate the model again, if necessary.
- 7 Generate code for the variants model with preprocessor conditionals.

---

**Note:** You must have Embedded Coder license to generate code.

---

- a In the Block Parameters dialog box, select the **Analyze all choice during update diagram and generate preprocessor conditionals** check box.
  - b In the **Code Generation** section of Configuration Parameters dialog box, specify the **System target file** as `ert.tlc`.
  - c In Model Explorer, define the variables used to specify the variant choice as a `Simulink.Parameter`. The data type of the variable can be of type Integer, Boolean, or Enumerated and the storage class can be either `importedDefine(Custom)`, `Define(Custom)`, or `CompilerFlag`.
- 8 For the variants that are defined in the base workspace, export the control variables to a MAT-file. For example, type the following in the MATLAB command window:
  - a `save <MAT-File Name> <Variable Name>`
  - b `PostLoadCallback > load MAT-File Name`

---

**Note:** To update or refresh active models that contain Variant Subsystem blocks, click **Diagram > Refresh Blocks** (Ctrl + K) or **Simulink > Update Diagram** (Ctrl + D) in Simulink.

---

## Related Examples

- “Define, Configure, and Activate Variants” on page 11-31
- “Create and Validate Variant Configurations” on page 11-73
- “Create Variant Controls Programmatically” on page 11-29
- “Represent Subsystem and Model Variants in Generated Code” (Embedded Coder)
- “Export Workspace Variables” on page 57-102



# Create Variant Controls Programmatically

## In this section...

- “Create and Export Variant Controls” on page 11-29
- “Reuse Variant Conditions” on page 11-29
- “Enumerated Types as Variant Controls” on page 11-30

## Create and Export Variant Controls

Create control variables, define variant conditions, and export control variables.

- 1 Create control variables in the base workspace or a data dictionary.

```
FUEL=2;  
EMIS=1;
```

- 2 Use the control variables to define the control condition using a `Simulink.Variant` object.

```
LinearContoller=Simulink.Variant('FUEL==2 && EMIS==1');
```

---

**Note:** Before each simulation, define `Simulink.Variant` objects representing the variant conditions.

---

- 3 If you saved the variables in the base workspace, select the control variables to export. Right-click and click **Save As** to specify the name of a MAT-file.

## Reuse Variant Conditions

If you want to reuse common variant conditions across models, specify variant control conditions using `Simulink.Variant` objects.

Reuse `Simulink.Variant` objects to change the model hierarchy dynamically to reflect variant conditions by changing the values of the control variables that define the condition expression.

The example models `AutoMRVar` and `AutoSSVar` show the use of `Simulink.Variant` objects to define variant control conditions.

## Enumerated Types as Variant Controls

Use enumerated types to give meaningful names to integers used as variant control values.

- 1 In the MATLAB Editor, define the classes that map enumerated values to meaningful names.

```
classdef sldemo_mrv_CONTROLLER_TYPE < Simulink.IntEnumType
    enumeration
        NONLINEAR (1)
        SECOND_ORDER (2)
    end
end
```

```
classdef sldemo_mrv_BUILD_TYPE < Simulink.IntEnumType
    enumeration
        PROTOTYPE (1)
        PRODUCTION (2)
    end
end
```

- 2 Define `Simulink.Variant` objects for these classes in the base workspace.

```
VE_NONLINEAR_CONTROLLER = Simulink.Variant...
('E_CTRL==sldemo_mrv_CONTROLLER_TYPE.NONLINEAR')
VE_SECOND_ORDER_CONTROLLER = Simulink.Variant...
('E_CTRL==sldemo_mrv_CONTROLLER_TYPE.SECOND_ORDER')
VE_PROTOTYPE = Simulink.Variant...
('E_CURRENT_BUILD==sldemo_mrv_BUILD_TYPE.PROTOTYPE')
VE_PRODUCTION = Simulink.Variant...
('E_CURRENT_BUILD==sldemo_mrv_BUILD_TYPE.PRODUCTION')
```

Using enumerated types simplifies the generated code because it contains the names of the values rather than integers.

## Related Examples

- “Generate Preprocessor Conditionals for Variant Systems” (Embedded Coder)
- “Create and Validate Variant Configurations” on page 11-73

## More About

- “Approaches for Specifying Variant Controls” on page 11-17

## Define, Configure, and Activate Variants

### In this section...

“Represent Variant Choices” on page 11-31

“Include Simulink Model as Variant Choice” on page 11-35

“Configure Variant Controls” on page 11-37

“Convert Subsystem to Variant Subsystem” on page 11-38

### Represent Variant Choices

Variant choices are two or more configurations of a component in your model. This example shows how to represent variant choices inside a Variant Subsystem block in your model. For other ways to represent design variants, see “Options for Representing Variants in Simulink” on page 11-6.

- 1 Add a Variant Subsystem block to your model and name it.

This block serves as the container for the variant choices.

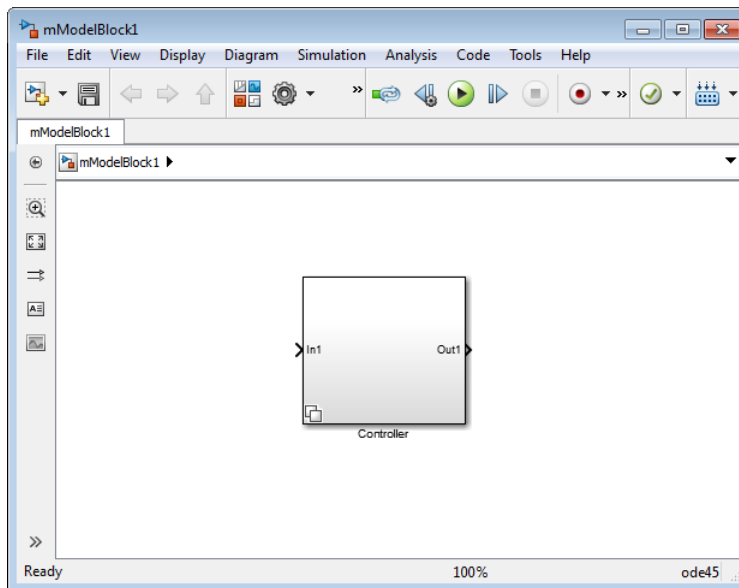



- 2 Double-click the Variant Subsystem block. Add inport and outport blocks so that they match the inputs into and outputs from this block.

---

**Note:** You can add only Inport, Outport, Subsystem, and Model blocks inside a Variant Subsystem block.

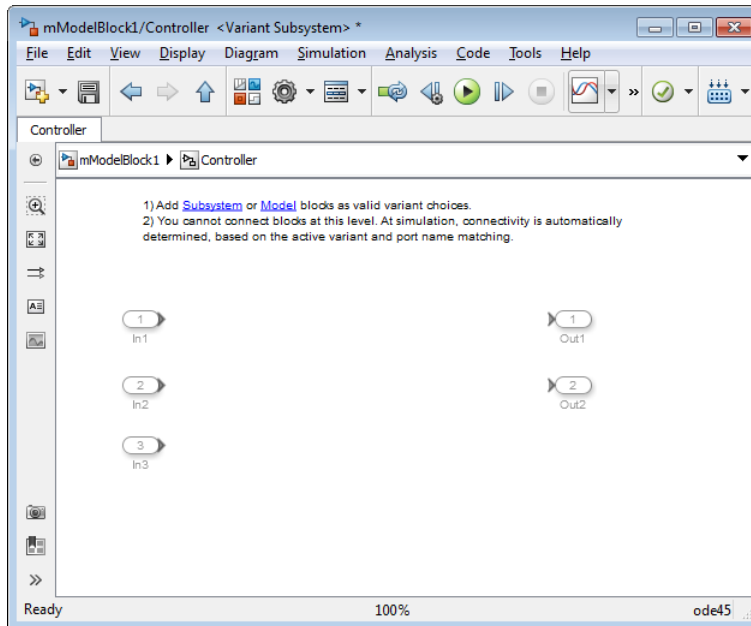
---



- 3 Right-click the badge on the Variant Subsystem block and select **Block Parameters (Subsystem)**.
- 4 In the block parameters dialog box, click the  button for each subsystem variant choice you want to add.

Simulink creates empty Subsystem blocks inside the Variant Subsystem block. The new blocks have the same number of inports and outports as the containing Variant Subsystem block.

**Tip:** (If your variant choices have different numbers of inports and outports, see “Mapping Inports and Outports of Variant Choices” on page 11-7.)

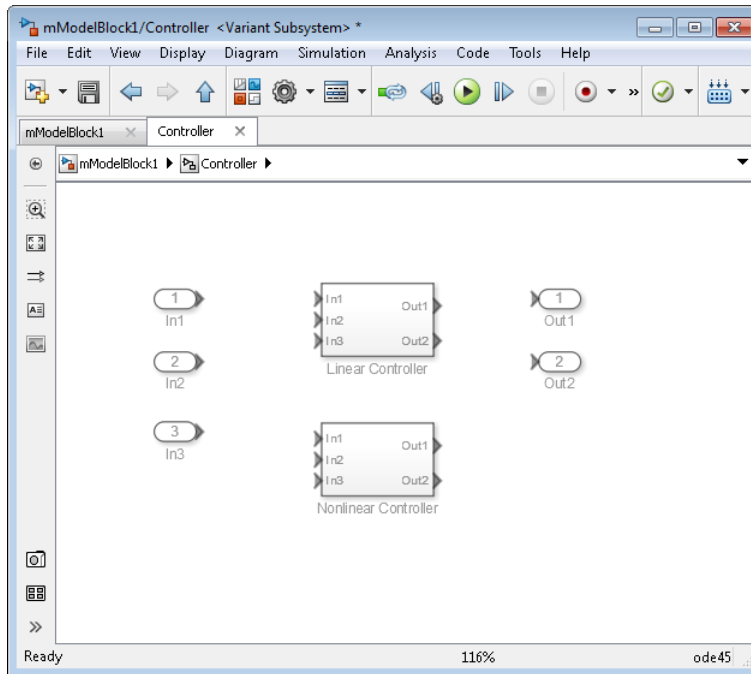

- 5 Open each Subsystem block and create the model that represents a variant choice.

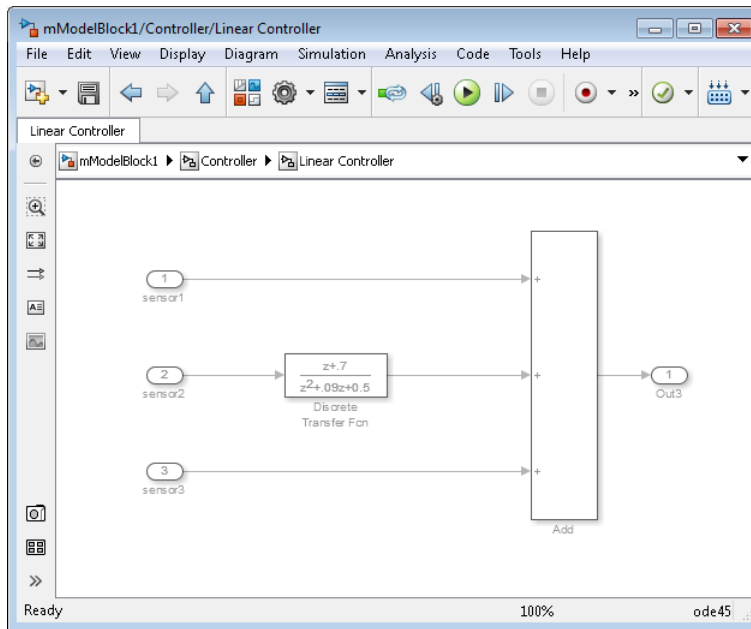

- When you are prototyping variants, you can create empty Subsystem blocks with no inputs or outputs inside the Variant Subsystem block. The empty subsystem recreates the situation in which a subsystem is inactive without the need for completely modeling the variant. For an empty variant choice, either specify a variant activation condition or comment out the variant condition by placing a % symbol before the condition.

If the empty variant choice is active during simulation, Simulink ignores it.

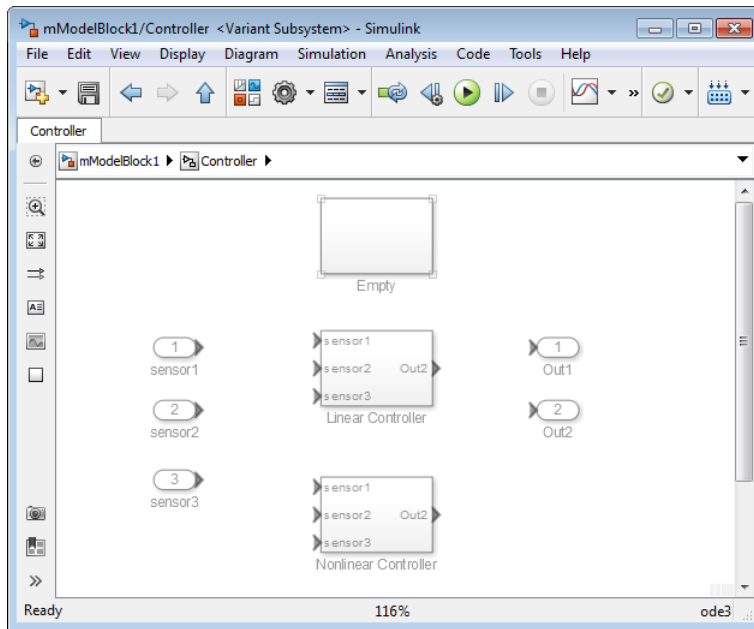

## Include Simulink Model as Variant Choice

You can include a Simulink model as a variant choice inside a Variant Subsystem block.

- 1 Create a model that you want to include as a variant choice. Make sure that it has the same number of inports and outports as the containing Variant Subsystem block.

---

**Note:** If your model has different numbers of inports and outports, see “Mapping Inports and Outports of Variant Choices” on page 11-7.

---

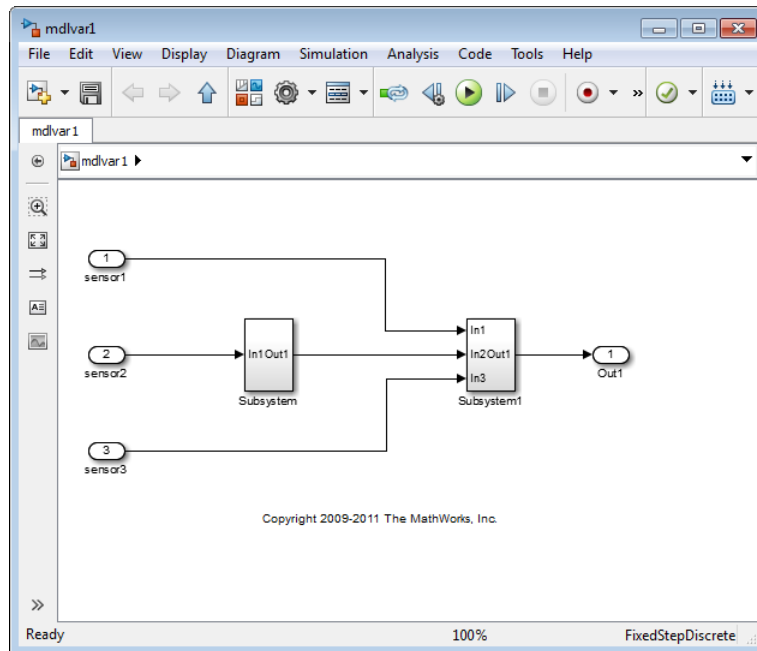

- 2 In your model, right-click the Variant Subsystem block that contains variant choices and select **Block Parameters (Subsystem)**.
- 3 In the block parameters dialog box, click the  button to add a Model block as variant choice.

Simulink creates an unresolved model reference block in the Variant Subsystem block.

- 4 Double-click the unresolved model block. In the **Model name** box, enter the name of the model you want to use as a model variant choice and click **OK**.



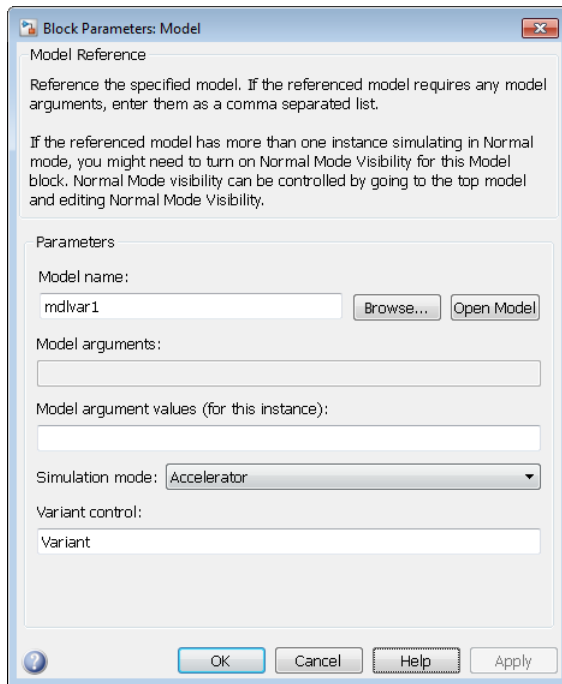

## Configure Variant Controls

You can specify the conditions for activating a variant choice using variant controls. You can also specify at most one variant choice as the default.

- 1 At the MATLAB command prompt, specify the control variables that create an activation condition when combined.

```
mode = 3;
version = 2;
```

- 2 Right-click the Variant Subsystem block that is the container for variant choices in your model and select **Block Parameters (Subsystem)**.
- 3 In the block parameters dialog box, in the **Variant control** column, select **(default)** next to one of the choices.

Simulink verifies that only one variant choice is active for simulation. When the control condition does not activate a variant, Simulink uses the default variant for simulation.

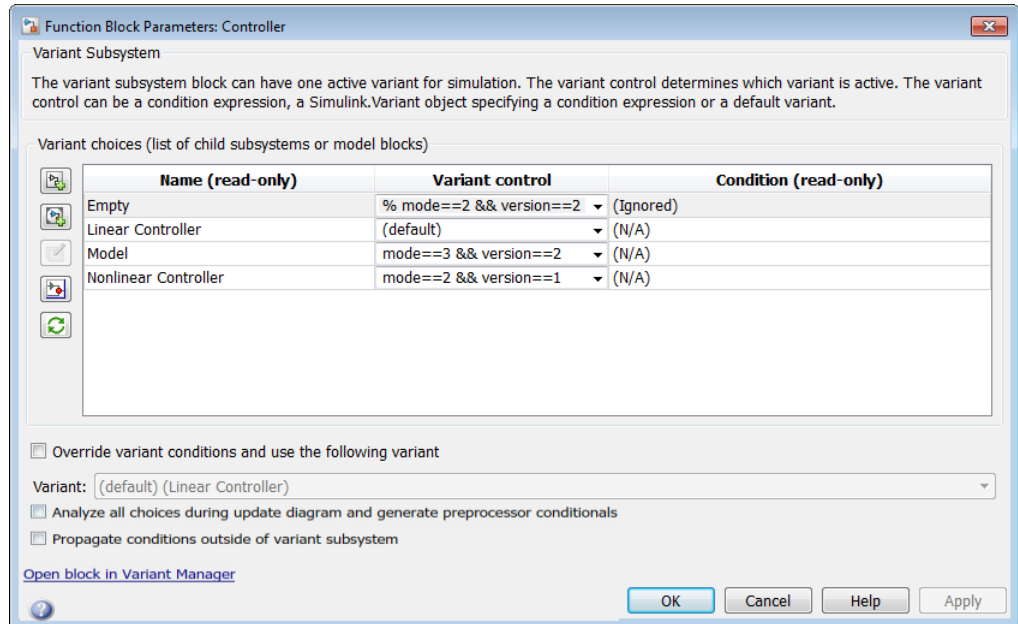

- 4 Specify a variant condition each of the other choices. If you are using an empty variant choice, specify a variant condition for for the choice. You can also comment out an existing activation condition by prefixing it with a % symbol.
- 5 Click **Apply**; otherwise, your changes are not saved.

## Convert Subsystem to Variant Subsystem

You can convert a Subsystem block available in a model to a Variant Subsystem block. To do so, right-click the Subsystem block, in the context menu, click **Subsystem & Model Reference > Convert Subsystem to > Variant Subsystem**.

To convert a Subsystem block to Variant Subsystem block programmatically, use any of these syntaxes:

- `Simulink.VariantManager.convertToVariant(gcb)`

- `Simulink.VariantManager.convertToVariant(gcbh)`

## **Related Examples**

- “Create and Validate Variant Configurations” on page 11-73

## **More About**

- “Introduction to Variant Controls” on page 11-16
- “Approaches for Specifying Variant Controls” on page 11-17

## Prepare Variant-Containing Model for Code Generation

### In this section...

“Convert Variant Control Variables into Simulink.Parameter Objects” on page 11-40

“Configure Model for Generating Preprocessor Conditionals” on page 11-42

Using Embedded Coder, you can generate code from Simulink models containing one or more variant choices. The generated code contains preprocessor conditionals that control the activation of each variant choice.

### Convert Variant Control Variables into Simulink.Parameter Objects

MATLAB variables allow you to rapidly prototype variant control expressions when you are building your model. However, if you want to generate preprocessor conditionals for code generation, convert MATLAB variables into `Simulink.Parameter` objects.

In addition to enabling parameter value specification, `Simulink.Parameter` objects allow you to specify other attributes (such as data type) that are required for generating code.

- 1 Specify the model in which you want to replace MATLAB variant control variables with `Simulink.Parameter` objects.

```
model = 'my_model_containing_variant_choices';
open_system(model);
```

- 2 Get the variables that are referenced in variant control expressions.

```
vars = Simulink.VariantManager.findVariantControlVars(model)
```

```
vars =
```

```
4x1 struct array with fields:
```

```
    Name
    Value
    Exists
    Source
    SourceType
```

- 3 Create an external header file for specifying variant control values so that the variable definitions are imported when the code runs.

```
headerFileName = [model '_importedDefines.h'];
```

```

headerPreamble = strep(upper(headerFileName), '.', '_');

fid = fopen(headerFileName, 'w+');
fidErr = (fid == -1);
if (fidErr)
    fprintf('There was an error creating header file %s:...
\n', headerFileName);
else
    fprintf('+++ Creating header file ''%s'' with variant control...
variable definitions.\n\n', headerFileName);
    fprintf(fid, '#ifndef %s\n', headerPreamble);
    fprintf(fid, '#define %s\n', headerPreamble);
end

```

Variant control variables defined as `Simulink.Parameter` objects can have one of these storage classes.

- Define or ImportedDefine with header file specified
  - CompilerFlag
  - SystemConstant (AUTOSAR)
  - Your own custom storage class that defines data as a macro
- 4** Loop through all the MATLAB variables to convert them into `Simulink.Parameter` objects.

```

count = 0;
for countVars = 1:length(vars)
    var = vars(countVars).Name;
    val = vars(countVars).Value;
    if isa(val, 'Simulink.Parameter')
        % Do nothing
        continue;
    end
    count = count+1;

% Create and configure Simulink.Parameter objects corresponding to the
% control variable names. Specify the custom storage class as
% ImportedDefine so that the values are specified
% by an external header file.
newVal = Simulink.Parameter(val);
newVal.DataType = 'int16';
newVal.CoderInfo.StorageClass = 'Custom';
newVal.CoderInfo.CustomStorageClass = 'ImportedDefine';
newVal.CoderInfo.CustomAttributes.HeaderFile = headerFileName;

```

```
    assigninGlobalScope(model, var, newVal);  
  
    if ~fidErr  
        fprintf(fid, '#endif\n');  
        fclose(fid);  
    end  
end
```

## Configure Model for Generating Preprocessor Conditionals

If you represent variant choices inside a Variant Subsystem block or a Model Variant block, code generated for each variant choice is enclosed within C preprocessor conditionals `#if`, `#else`, `#elif`, and `#endif`.

If you represent variant choices using a Variant Source block or a Variant Sink block, code generated for each variant choice is enclosed within C preprocessor conditionals `#if` and `#endif`.

Therefore, the active variant is selected at compile time and the preprocessor conditionals determine which sections of the code to execute.

- 1 In the Simulink editor, select **Simulation > Model Configuration Parameters**.
- 2 Select the **Code Generation** pane, and set **System target file** to `ert.tlc`.
- 3 In the **Report** pane, select **Create code generation report**.
- 4 Select the **Code Generation** pane, and clear **Ignore custom storage classes** and **Apply**.
- 5 In your model, right-click the block containing the variant choices (Variant Subsystem, Variant Source, Variant Sink, or Model Variant) and select **Block Parameters**.
- 6 Select the option **Analyze all choices during update diagram and generate preprocessor conditionals**.

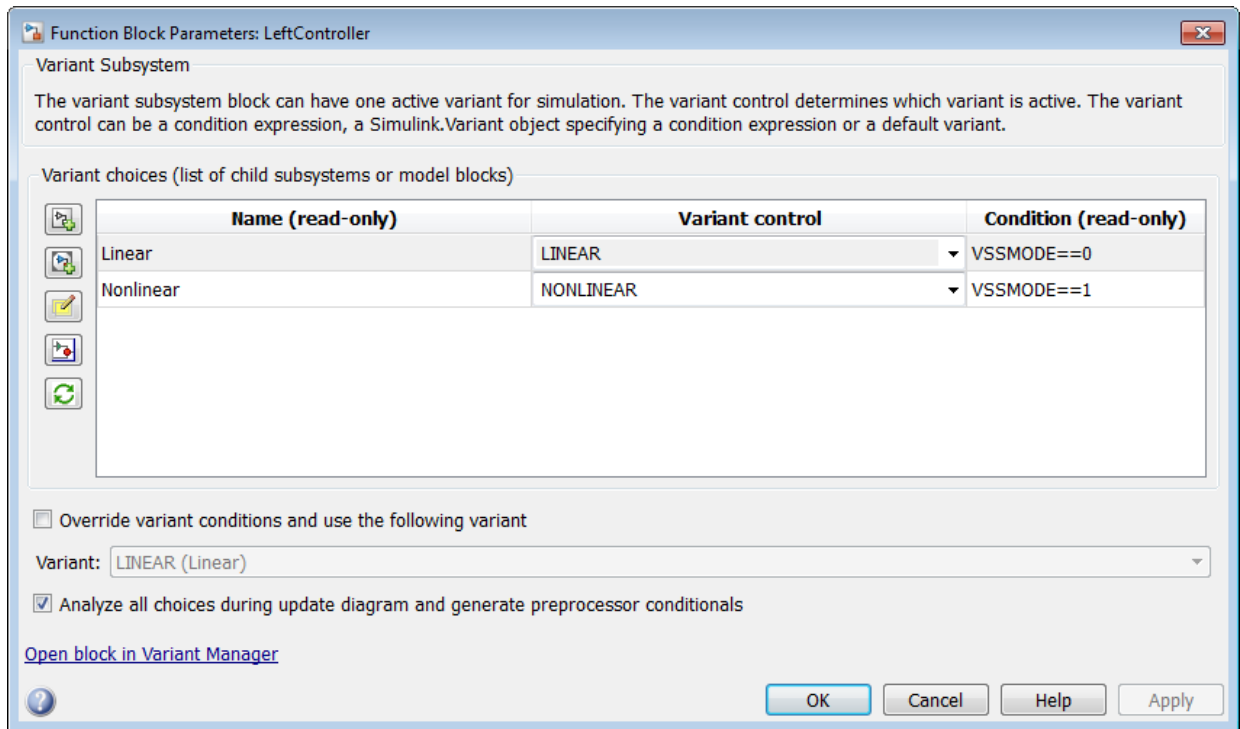

Simulink analyzes all variant choices during an update diagram or simulation. This analysis provides early validation of the code generation readiness for all variant choices.

- 7 Clear the option **Override variant conditions and use following variant**.
- 8 Build the model.

## Related Examples

- “Define, Configure, and Activate Variants” on page 11-31
- “Create and Validate Variant Configurations” on page 11-73
- “Create Variant Controls Programmatically” on page 11-29
- “Working with Variant Choices” on page 11-12

### **More About**

- “Code Generation for Variant Blocks” (Embedded Coder)
- “Represent Subsystem and Model Variants in Generated Code” (Embedded Coder)
- “Represent Variant Source and Sink Blocks in Generated Code” (Embedded Coder)
- “Model AUTOSAR Variants” (Embedded Coder)
- “Use Subsystem Variants To Generate Code That Uses C Preprocessor Conditionals” on page 11-104



## Set up Model Variants

### In this section...

“Configure the Model Variants Block” on page 11-46

“Disable and Enable Model Variants” on page 11-48

“Parameterize Model Variants” on page 11-49

“Additional Examples” on page 11-49

Open the example model AutoMRVar. You can also open the model from the MATLAB prompt:

```
addpath([docroot ' /toolbox/simulink/ug/examples/variants/mdlref/']);
open('AutoMRVar');
```

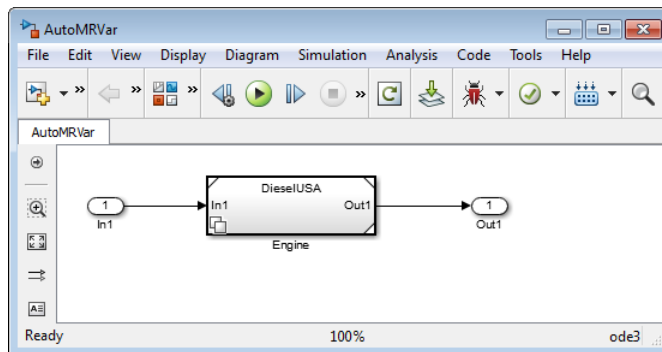

The symbol  appears in the lower-left corner of the block to indicate that it uses variants. The name of the variant that was active the last time you saved the model appears on the block.

When you change the active variant, the variant block refreshes. The name changes to reflect the current active variant.

When you open the example model, the `load` function loads a MAT-file that populates the base workspace with the variables and objects used by the model.

Name	Value
DE	<1x1 Simulink.Variant>
DU	<1x1 Simulink.Variant>
EMIS	1
FUEL	2
GE	<1x1 Simulink.Variant>
GU	<1x1 Simulink.Variant>

The example shows the use of variants for the following cases:

- The automobile can use a diesel or a gasoline engine.
- Each engine must meet the European or United States (USA) emission standard.

AutomRVar implements the automobile application using the Model Variants block named **Engine**. The Engine block specifies four referenced models. Each referenced model represents one permutation of engine fuel and emission standards. The table shows the variant choices.

Model Name	Variant Control	Condition (read only)
GasolUSA	GU	FUEL==1 && EMIS==1
GasolEuro	GE	FUEL==1 && EMIS==2
DieselUSA	DU	FUEL==2 && EMIS==1
DieselEuro	DE	FUEL==2 && EMIS==2

**Note:** You can use condition expressions directly in the **Variant control** field. You do not need to create `Simulink.Variant` objects.

## Configure the Model Variants Block

You can configure a Model block and specify your variant choices.

- 1 Create a model.
- 2 From the **Ports & Subsystems** library, add a Model block to the model.
- 3 Right-click the Model block and select **Block Parameters (ModelReference)** from the context menu.

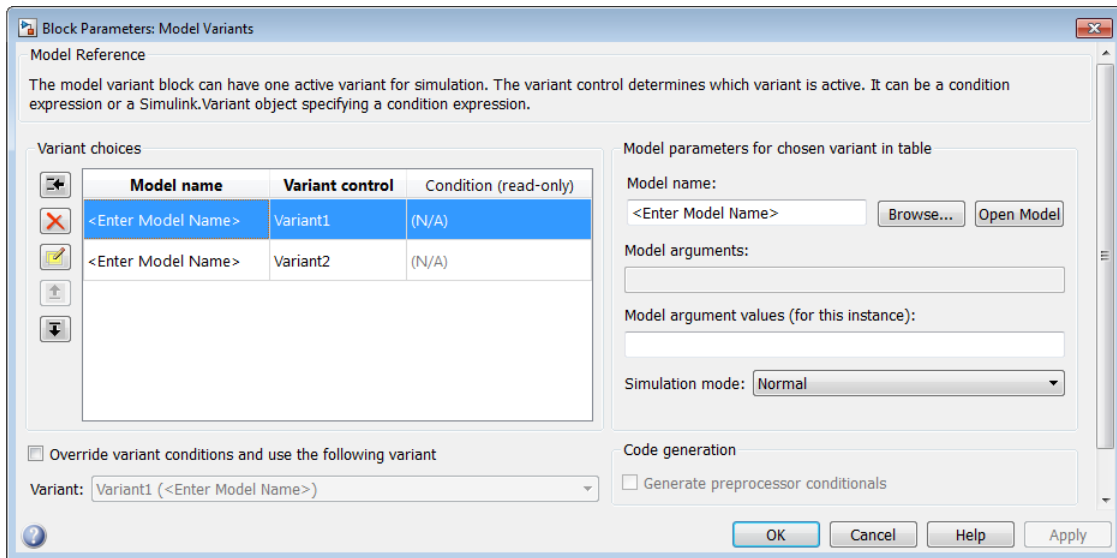

- Under **Variant choices**, specify the model choices in the **Model name** column. To specify a protected model, use the extension `.slxp` or `.mdl`. For more information, see “Protected Model” on page 8-90.

---

**Note:** You cannot specify a model as the default variant if that model is a variant choice in a Model block. Instead, you can add that model as a variant choice in a Subsystem block, and then specify that model as the default variant.

---

- For each model choice, specify the variant control in the **Variant control** column. Use a Boolean condition expression or a `Simulink.Variant` object representing a Boolean condition expression.

Populate the **Variant control** column for each choice. You cannot comment out (%) variant control values for the Model block. However, for Variant Subsystem blocks, you can comment out variant choices.

- To edit the condition that determines the active variant choice, click the **Create/Edit selected variant** button . In the dialog box, enter the condition and click **OK**.

- 7 If you want, specify the model arguments and the **Simulation mode**. All simulation modes work with model variants. For more information, see “Parameterize Model Variants” on page 11-49 and “Simulate Model Referencing Models” on page 8-31.
- 8  If you want to add more variant choices, click the **Add a new variant** button.
- 9 After you have specified referenced models and added variant choices, click **OK**.

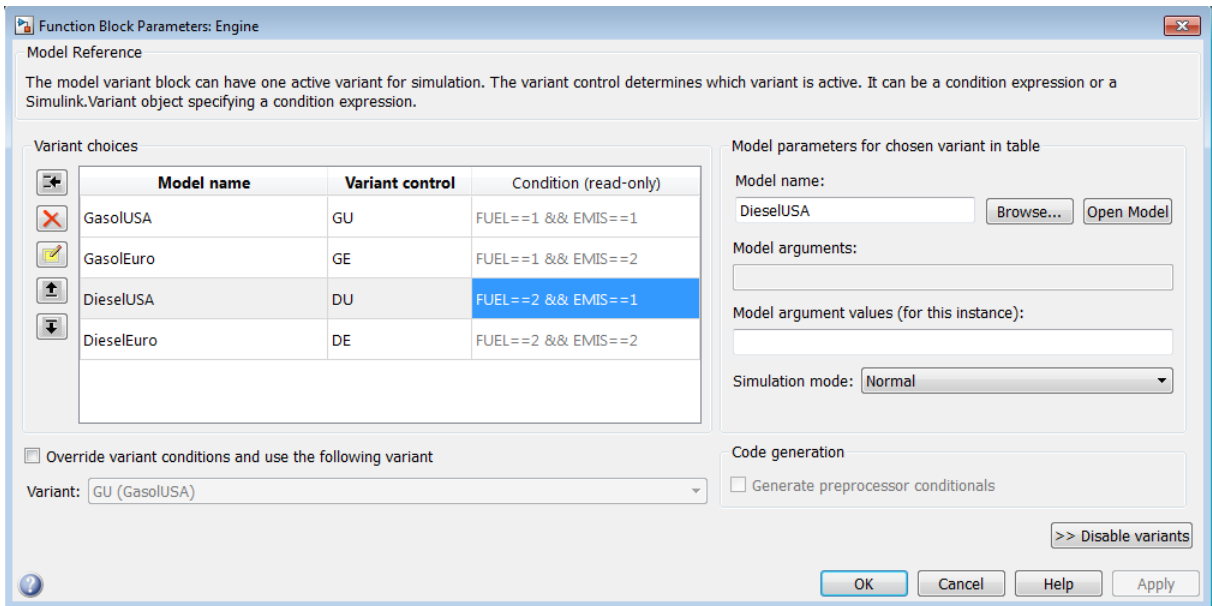

For next steps, see “Working with Variant Choices” on page 11-12.

## Disable and Enable Model Variants

You can disable model variants without losing your variant settings. After you enable variants, they remain enabled until you explicitly disable them.

Disabling variants:

- Hides and ignores the content of the **Variant choices** section of the dialog box
- Retains the active variant as the model name

- Ignores subsequent changes to variant control variables and other models, other than the current model

To disable variants from a Model block:

- 1 Right-click the block and select **Block Parameters (ModelReference)** to open the block parameters dialog box.
- 2 Click **Disable Variants**.

To enable variants, click **Enable Variants**. The Model block selects an active variant according to the current base workspace variables and conditions.

## Parameterize Model Variants

You can apply a parameter to a variant control. Parameter values are the same as for a referenced model.

- 1 In the block parameters dialog box, under **Variant choices**, select the row for the variant control that you want to parameterize.
- 2 In the **Model argument values (for this instance)** text box, specify the parameter.
- 3 Click **Apply**.

For more information, see “Model Arguments for Model Variants Blocks” on page 8-78.

## Additional Examples

For additional examples of model reference variants, in the Help browser, select **Simulink > Examples > Modeling Features > Model Reference > Model Reference Variants**.

The example `sldemo_md1ref_variants` shows a model variant.

## Related Examples

- “Define, Configure, and Activate Variants” on page 11-31
- “Create and Validate Variant Configurations” on page 11-73
- “Create Variant Controls Programmatically” on page 11-29
- “Working with Variant Choices” on page 11-12

### **More About**

- “Introduction to Variant Controls” on page 11-16
- “Create a Simple Variant Model” on page 11-25

## Visualize Variant Implementations in a Single Layer

Simulink provides two blocks that you can use to visualize all possible implementations of variant choices in a model. These blocks are called Variant Source and Variant Sink.

When you compile the model, Simulink determines which variant control evaluates to true. Simulink then deactivates blocks that are not tied to the variant control being true and visualizes the active connections.

### How Variant Sources and Sinks Work

The Variant Source block has one or more input ports and one output port. You can define variant choices as blocks that are connected to the input port so that, at most, one choice is active. The active choice is connected directly to the output port of the Variant Source and the inactive choices are eliminated during simulation.

The Variant Sink block has one input port and one or more output ports. You can define variant choices as blocks that are connected to the output port so that, at most, one choice is active. The active choice is connected directly to the input port of the Variant Sink, and the inactive choices are eliminated during simulation.

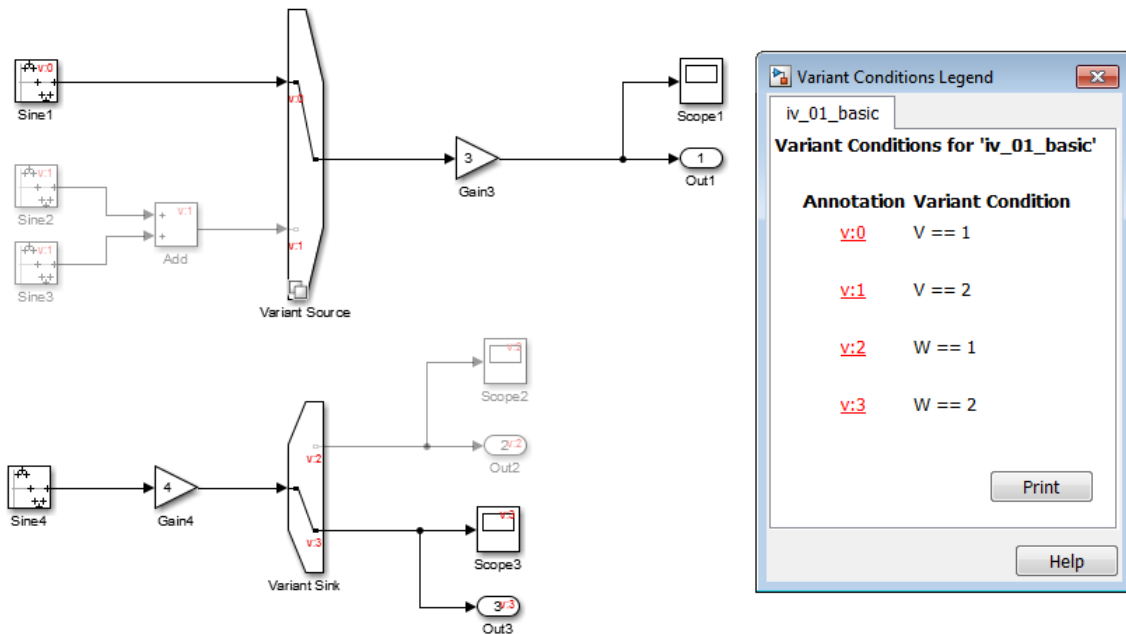

Connect one or more blocks to the input port of the Variant Source block or the output port of the Variant Sink block. Then, you define variant controls for each variant choice entering the Variant Source block and exiting the Variant Sink block. For more information, see “Variant Condition Propagation with Variant Sources and Sinks” on page 11-61.

## Advantages of Using Variant Sources and Sinks

Using Variant Source and Variant Sink blocks in Model-Based Design provides these advantages:

- The blocks enable the propagation of variant conditions and allow you to visualize variant choices in a single layer of your model.
- By visualizing all possible implementations of variant choices, you can improve the readability of your model.
- During model compilation, Simulink eliminates inactive blocks throughout the model, improving the runtime performance of your model.



- Variant sources and sinks provide variant component interfaces that you can use to quickly model variant choices.

## **Limitations of Using Variant Sources and Sinks**

- Variant Source and Variant Sink blocks work with time-based, function-call, or action signals. You cannot use SimEvents, Simscape Multibody, or other non-time-based signals with these blocks.
- The code generation variant report does not contain Variant Source and Variant Sink blocks.

## **Related Examples**

- “Define and Configure Variant Sources and Sinks” on page 11-54

## **More About**

- “Variant Condition Propagation with Variant Sources and Sinks” on page 11-61

## Define and Configure Variant Sources and Sinks

Simulink provides two blocks that you can use to visualize all possible implementations of variant choices in a model graphically. These blocks are called Variant Source and Variant Sink.

When you compile the model, Simulink determines which variant control evaluates to true. Simulink then deactivates blocks that are not tied to the variant control being true and visualizes the active connections.

- 1 Add Variant Source and Variant Sink blocks to your model.

These blocks enable ports that activate variant choices.

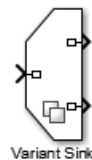
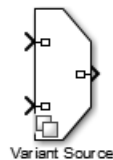

- 2 Using blocks from the Simulink Library Browser, create sources and sinks that represent variant choices. Connect choices to the input and output ports of the Variant Source and Variant Sink blocks.

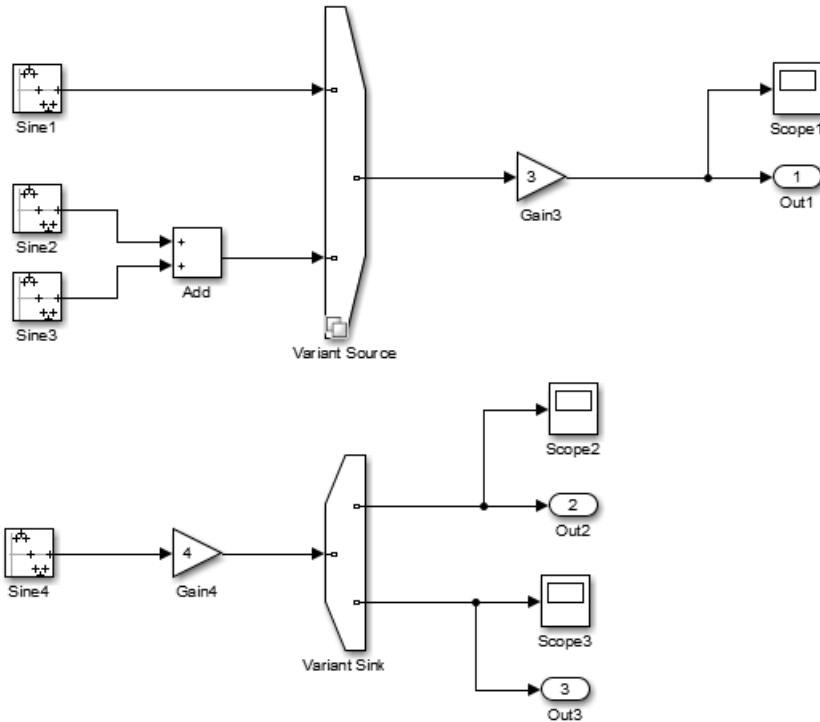

- 3 At the MATLAB command prompt, specify the control variable that creates an activation condition for the variant source.

```
V = Simulink.Parameter(1);
```

- 4 Right-click the Variant Source block and select **Block Parameters (VariantSource)**.
- 5 In the block parameters dialog box, in the **Variant control** column, type  $V==1$  next to one of the choices and  $V==2$  next to the other. Click **Apply**; otherwise, your changes are not saved.

Simulink verifies that only one variant is active for simulation. When the control condition does not activate a variant, Simulink uses the default variant for simulation.

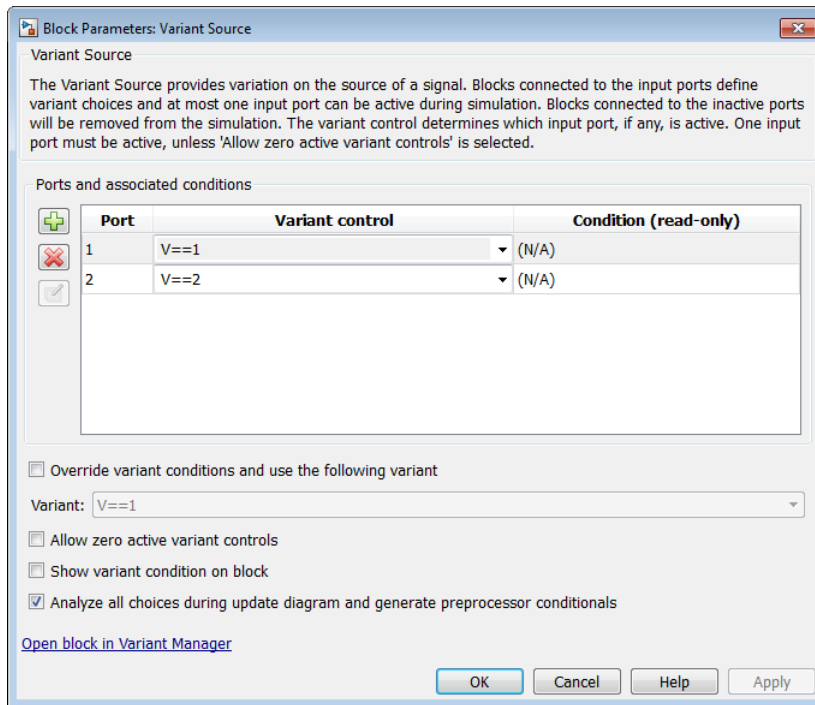

- 6 At the MATLAB command prompt, specify the control variable that creates an activation condition for the variant sink.

```
W = Simulink.Parameter(2);
```

- 7 Double-click the Variant Sink. In the block parameters dialog box, in the **Variant control** column, type  $W=1$  next to one of the choices and  $W=2$  next to the other.

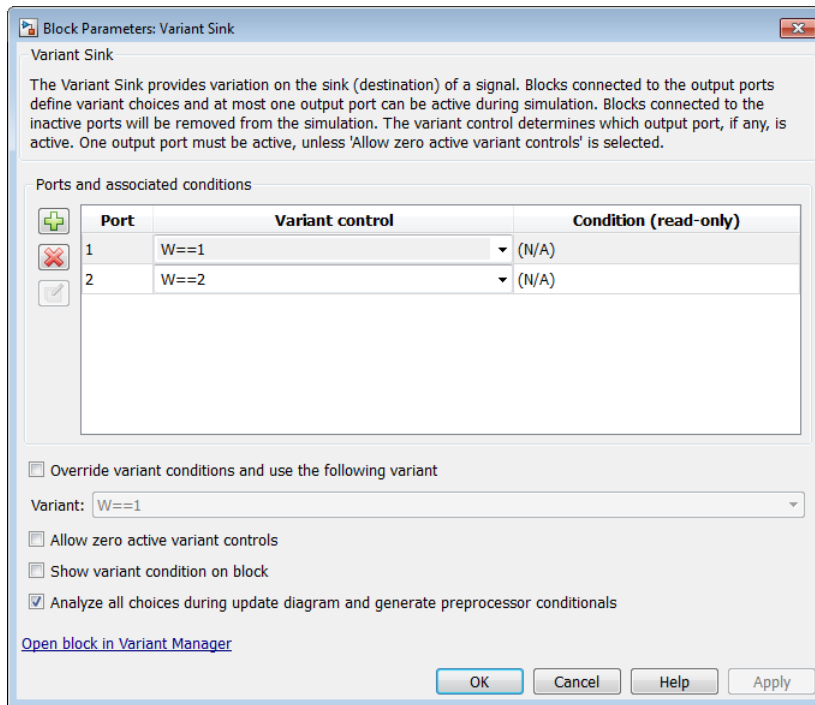

- 8 Click **Apply**; otherwise, your changes are not saved.
- 9 Simulate the model. Simulink propagates the variant conditions to identify which model components to activate.

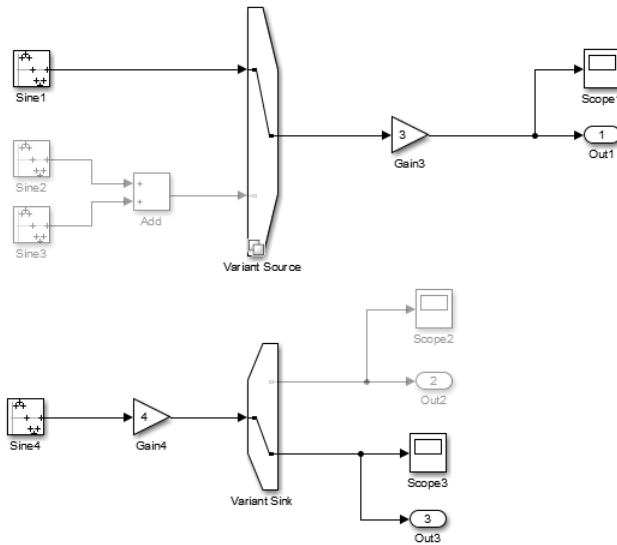

10 You can visualize the conditions that activate each variant choice by selecting **Display > Blocks > Variant Conditions**.

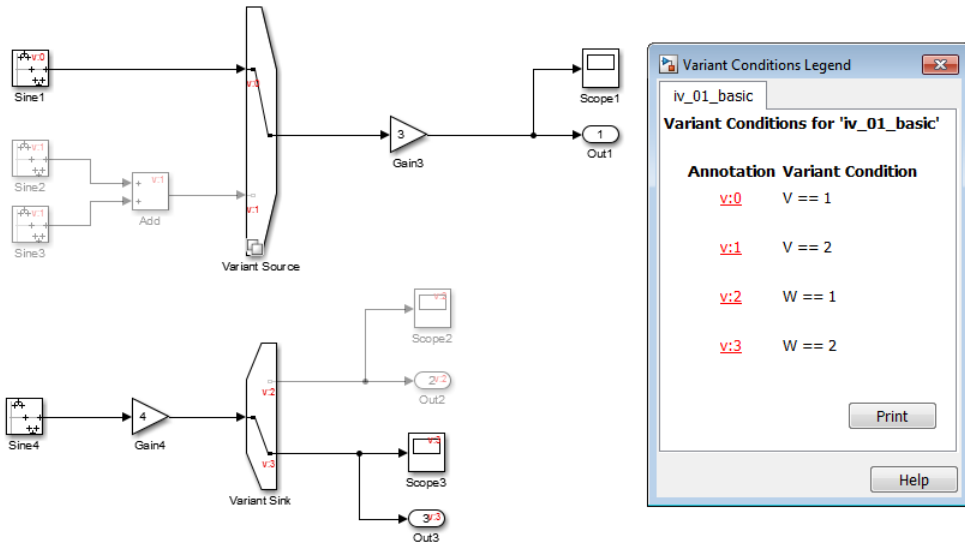

- In the Variant Condition Legend dialog box, click through the hyperlinked variant condition annotations to observe which parts of the model each condition activates.

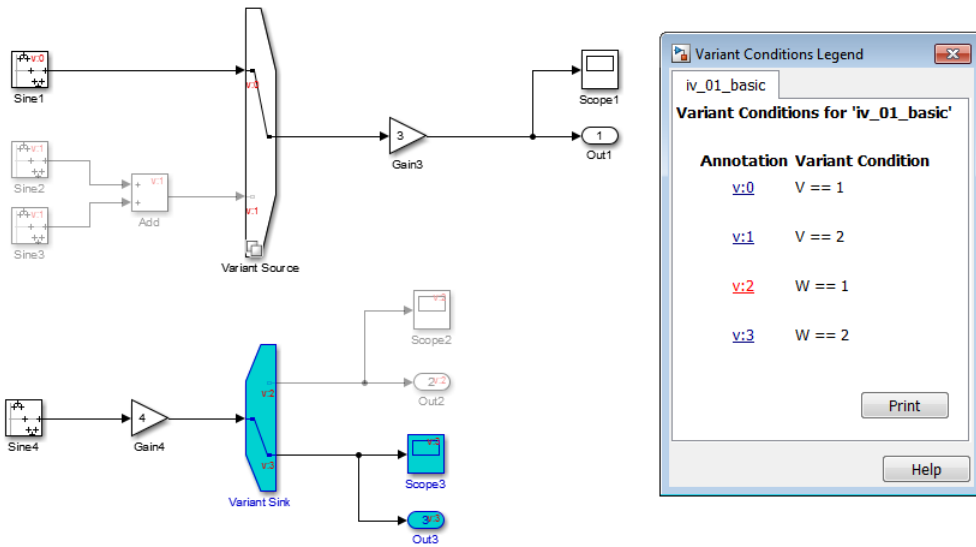

Variant Conditions Legend

iv\_01\_basic

Variant Conditions for 'iv\_01\_basic'

Annotation	Variant Condition
v:0	V == 1
v:1	V == 2
v:2	W == 1
v:3	W == 2

Print

Help

## Related Examples

- “Visualize Variant Implementations in a Single Layer” on page 11-51
- “Working with Variant Choices” on page 11-12

## More About

- “Introduction to Variant Controls” on page 11-16
- “Create a Simple Variant Model” on page 11-25



## Variant Condition Propagation with Variant Sources and Sinks

When you specify variant conditions in models containing Variant Source and Variant Sink blocks, Simulink propagates these conditions to determine which components of the model are active during simulation.

### In this section...

“View Variant Condition Annotations” on page 11-61

“How Variant Condition Propagation Works” on page 11-64

“Condition Propagation with Subsystems” on page 11-67

“Condition Propagation with Other Simulink Blocks” on page 11-68

“Known Limitations” on page 11-72

### View Variant Condition Annotations

When you develop a model that contains Variant Source or Variant Sink blocks, you can visualize the conditions that activate each variant choice. Simulink annotates these models with their corresponding variant conditions.

Consider this model containing multiple variant choices feeding into Variant Source blocks. A specific variant condition activates each variant choice.

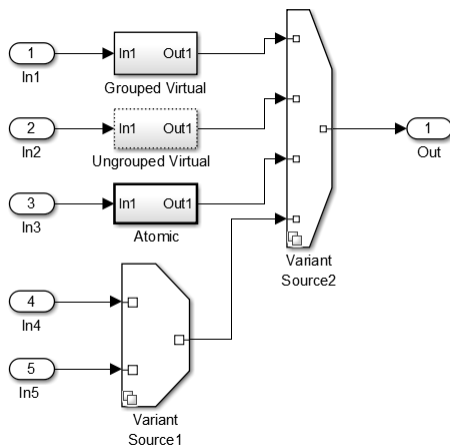

To visualize the variant conditions, select **Display > Blocks > Variant Conditions**.

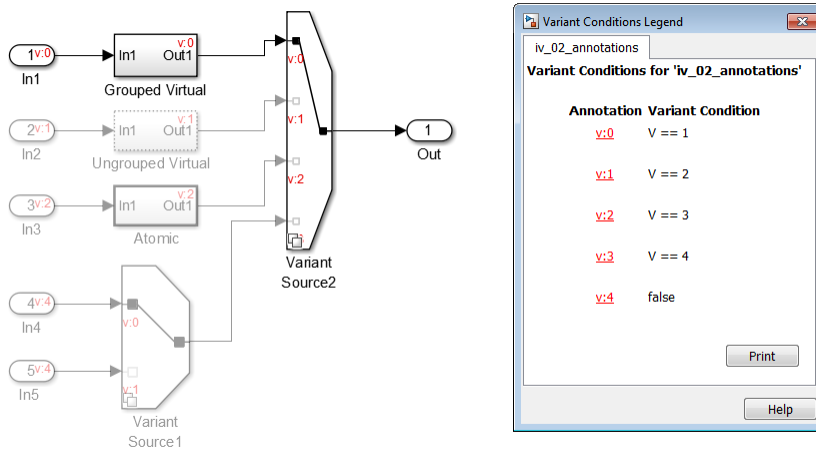

The **Variant Condition Legend** dialog box appears. Variant conditions on blocks are annotated as  $v:C$ , where  $v$  is the variant semantic indicator and  $C$  represents the variant condition index. The dialog box also shows the expression associated with each condition.

In the **Variant Condition Legend** dialog box, you can click through the hyperlinked variant annotations to observe which parts of the model each condition activates. For example, if you click  $v:3$ , Simulink highlights the parts of the model that are activated when the condition  $V==3$  evaluates to **true**.

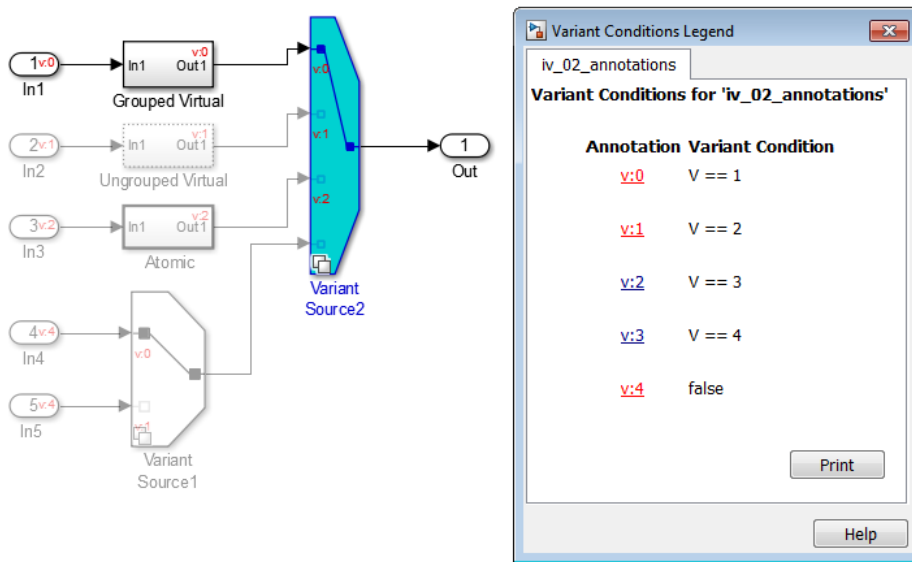

Variant condition annotations have these properties:

- There are no annotations on unconditional blocks. Therefore, the Out block is not annotated.
- To reduce clutter, the legend only displays the final computed conditions. For example, if you enter a variant condition in a Variant Source block, that condition appears in the annotations only when you apply your changes.
- The conditions in the legend are sorted during display.
- In the legend, a condition is set to **false** if Simulink assesses that the blocks associated with that condition are never active.

For example, the In4 block is connected to the Variant Source1 block, whose condition is  $V==1$ . Variant Source1 is connected to the Variant Source2 block, which activates Variant Source1 only when  $V==4$ . Therefore, In4 can only be active when  $V==1 \ \&\& \ V==4$ , a condition that is always **false**.

## How Variant Condition Propagation Works

When you compile a model containing Variant Source or Variant Sink blocks, Simulink determines which variant control evaluates to `true`. Simulink then deactivates blocks that are not tied to the variant control being `true` and visualizes the active connections.

### Cross-Coupling of Inputs and Outputs

In this model, two inputs feed the Variant Source block. The first input is active when `Var == 1`, and it branches into the second input before connecting to the Variant Source block. The second input is the default variant choice.

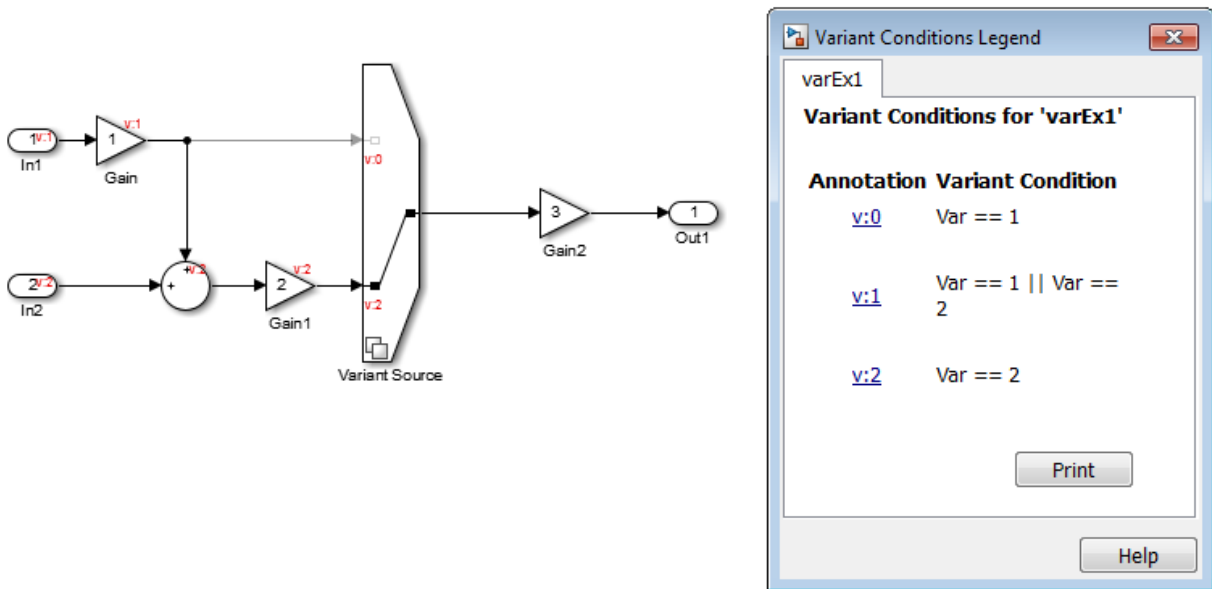

During simulation, this model exhibits three modes of operation:

- When `Var == 1`, the first input is active and its branch into the second input is inactive.
- When `Var == 1 || Var == 2`, the second input is active and the branch of the first input is active.
- When `Var == 2`, the second input is active and the output is active.

## Cascading Blocks and Compounding Conditions

In this model, two Variant Source blocks, each fed by two input ports, are connected in a cascading manner. The inputs to Variant Source are active when  $\text{Var1} == 1$  or  $\text{Var1} == 2$ . The output of Variant Source branches into one of the inputs of Variant Source1. The inputs to Variant Source1 are active when  $\text{Var2} == 1$  or  $\text{Var2} == 2$ .

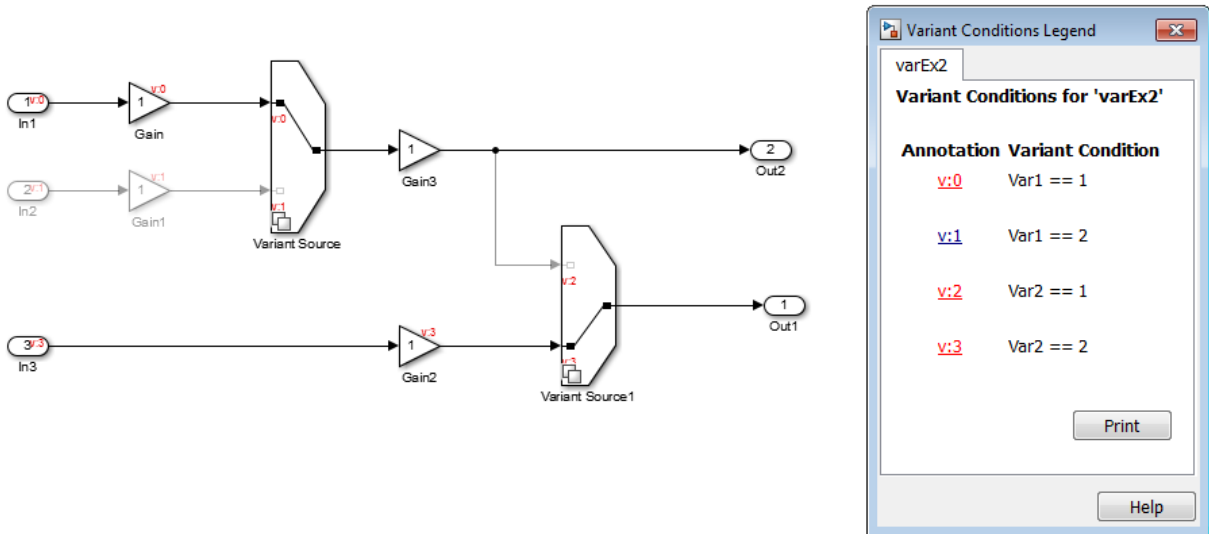

During simulation, this model exhibits eight modes of operation:

- When  $\text{Var1} == 1$  &&  $\text{Var2} == 1$ , the first inputs of Variant Source and Variant Source1 are active.
- When  $\text{Var1} == 1$  &&  $\text{Var2} == 2$ , the first input of Variant Source and the second input of Variant Source1 are active.
- When  $\text{Var1} == 2$  &&  $\text{Var2} == 1$ , the second input of Variant Source and the first input of Variant Source1 are active.
- When  $\text{Var1} == 2$  &&  $\text{Var2} == 2$ , the second inputs of Variant Source and Variant Source1 are active.
- When  $\text{Var1} == 1$  &&  $\text{Var2} != (1,2)$ , only the first input of Variant Source is active.
- When  $\text{Var1} == 2$  &&  $\text{Var2} != (1,2)$ , only the second input of Variant Source is active.

- When  $\text{Var1} \neq (1,2) \ \&\& \ \text{Var2} == 1$ , none of the inputs or outputs is active.
- When  $\text{Var1} \neq (1,2) \ \&\& \ \text{Var2} == 2$ , only the second input of Variant Source1 is active.
- When  $\text{Var1} \neq (1,2) \ \&\& \ \text{Var2} \neq (1,2)$ , none of the inputs or outputs is active.

### Hierarchical Nesting of Sources or Sinks

In this model, multiple Variant Source blocks are used to create hierarchical nesting of variant choices. Choices are first grouped by series: **A Series**, **B Series**, and **C Series**. A combination of one or more series is provided as input for a device model. The resulting device model is provided as input to the vendor by including or excluding a sensor selection.

Simulink propagates complex variant control conditions to determine which model components are active during compilation.

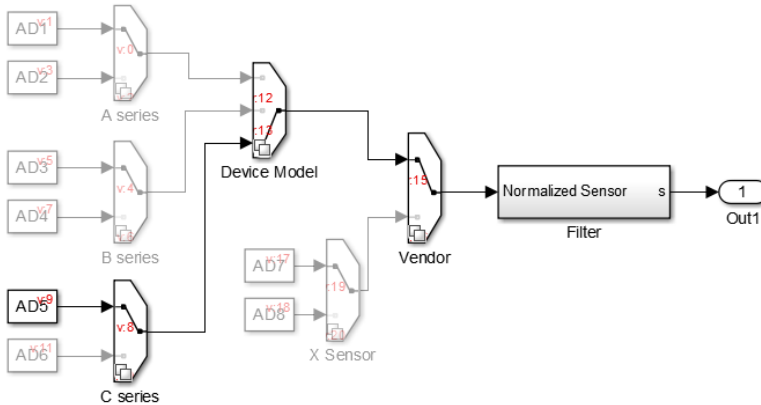

Copyright 2015 The MathWorks Inc.  
MathWorks Confidential

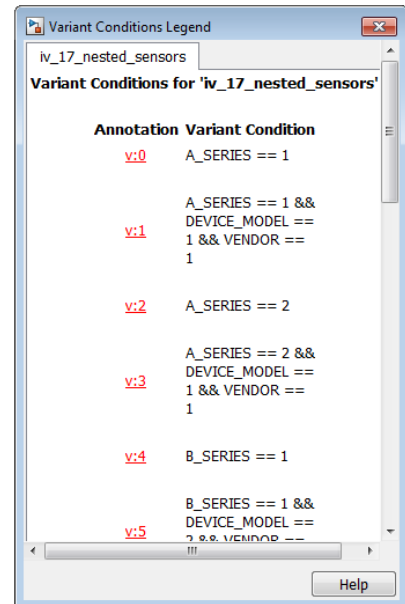

For more information, see Variant Sensors.

## Condition Propagation with Subsystems

A Subsystem can either be a virtual (grouped or ungrouped) or an atomic subsystem depending on the selections made in its **Block Parameters** dialog box. For,

- Grouped Virtual: Select the **Treat as grouped when propagating variant conditions** check box. A grouped virtual subsystem has a continuous line.
- Ungrouped Virtual: Clear the **Treat as grouped when propagating variant conditions** check box. An ungrouped virtual subsystem has a dotted line.
- Atomic: Select the **Treat as atomic unit** check box. An atomic virtual subsystem has a solid line.

Simulink propagates variant conditions differently to these Subsystem types.

In this model, three types of subsystems are provided as input to the block **Variant Source2**.

- The grouped virtual subsystem is activated when  $V == 1$ . Simulink propagates the variant activation condition to all the blocks in the subsystem.
- The ungrouped virtual subsystem is activated when  $V == 2$ . Simulink propagates the variant activation condition to the blocks that were available in the subsystem while marking the subsystem virtual.
- The atomic subsystem is activated when  $V == 3$ . Simulink does not propagate the variant activation condition into this subsystem

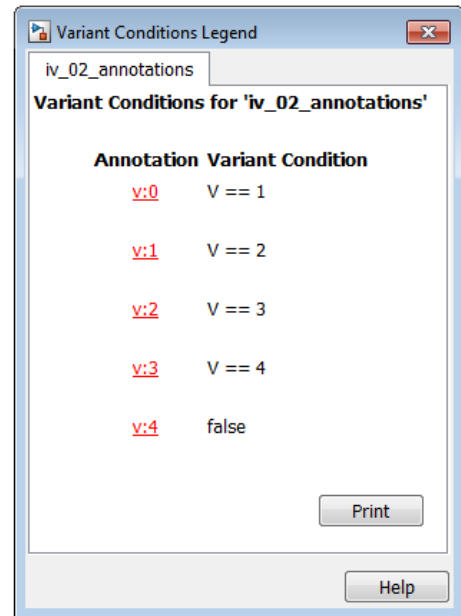
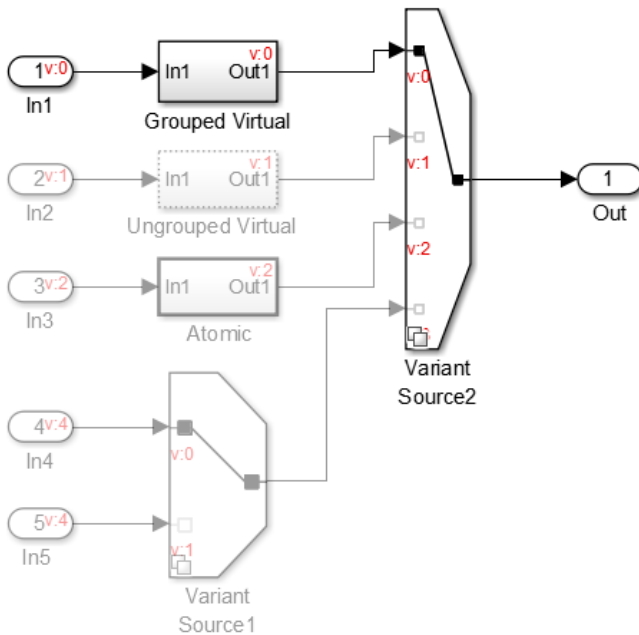

For more information, see “Propagating Variant Conditions to Subsystems” on page 11-111.

## Condition Propagation with Other Simulink Blocks

### Variant Condition Propagation with Model Block

Simulink compiles referenced models before propagating variant conditions. A variant condition can activate or deactivate a Model block, but variant conditions cannot propagate into the referenced model. A Model block can propagate variant conditions from its output port, if that variant condition originates at a port inside the model.

In this example, variant condition  $V==1$  activates the model block `iv_20_model_reference_sub`. However, the condition does not propagate into the model referenced by the block. Model block `iv_20_model_reference_sub2` propagates the same variant condition from its output port.



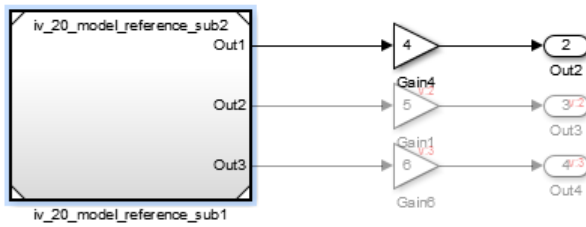
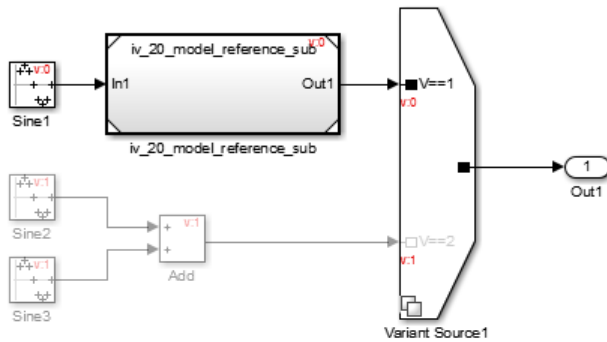

### Variant Condition Propagation with Simulink Function block

Argument Inport and Argument Outport blocks interfacing with Simulink Function blocks cannot be connected to Variant Source or Variant Sink blocks. One variant condition must control the entire Simulink Function.

Consider the model `slexVariantSimulinkFunction`.

In this example, the function-call port block within the Simulink Function block has the **Enable variant condition** option checked. This selection enables the option to **Generate preprocessor conditionals** and changes the visual appearance of the port on the Simulink Function block. The **Variant control** parameter of the function-call port is specified as `V==1`. If you change the value of `V`, the function caller block becomes inactive. As a result, the entire model becomes inactive.

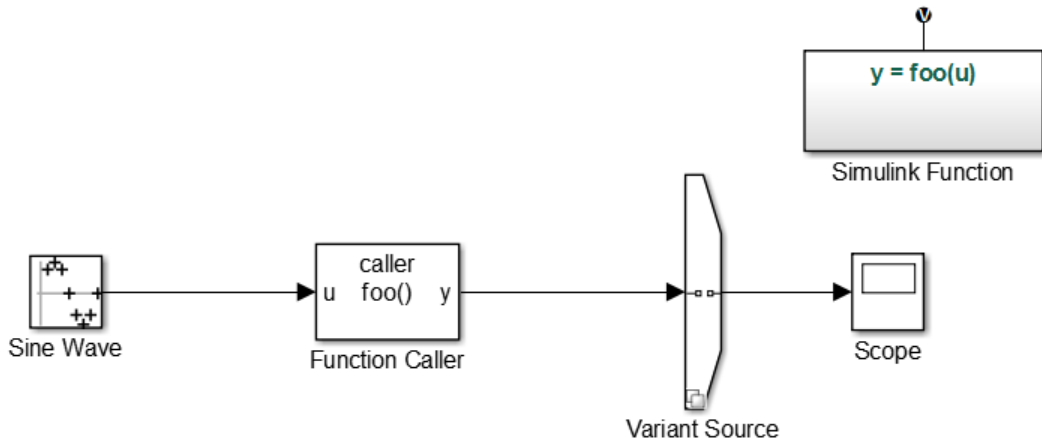

---

**Note:** The **Configure Model Functions** button on the **Code Generation > Interface** pane provides you flexible control over the model function prototypes that are generated for a model. If the inport and the outport share an argument name and have propagated variant conditions, the flexible control over the model function prototypes is not supported.

---

### Variant Condition Propagation with Initialize, Reset, and Terminate Blocks

The Initialize, Reset, and Terminate function blocks are pre-configured subsystem blocks that execute during model initialize, reset, and terminate events. Similar to a Simulink Function block these blocks support variant condition propagation.

In this example, the **Event Listener** block within the **Init**, **Reset**, and **Term** blocks have the **Enable variant condition** option selected. The **Variant control** parameter of the **Event Listener** block is specified as  $V==0$ . If you change the value of  $V$ , the **Init**, **Reset**, and **Term** blocks become inactive.

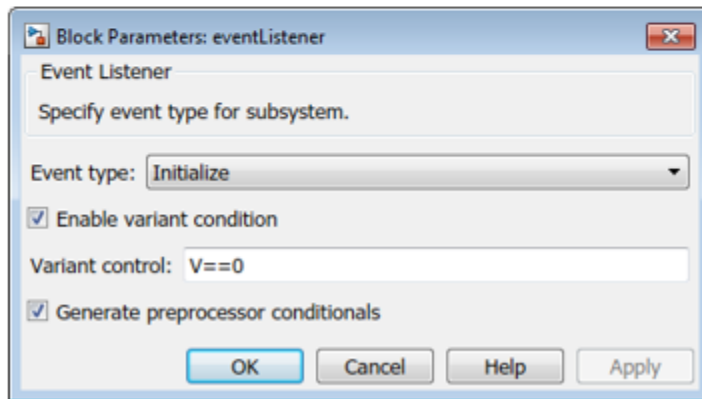
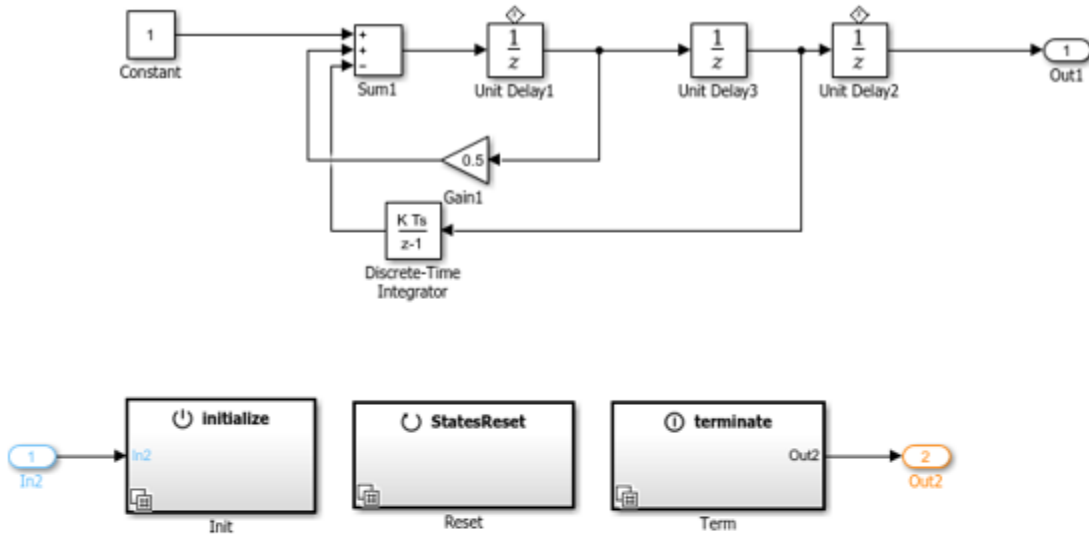

### Variant Condition Propagation with Subsystem Block

A variant condition can activate or deactivate a Subsystem block, but variant conditions cannot propagate into the subsystem. A Subsystem block can propagate variant conditions from its output port if that variant condition originates at a port inside the subsystem.

For more information, see “Propagating Variant Conditions to Subsystems” on page 11-111.

### **Variant Condition Propagation with Bus**

A Variant Source block can accept either virtual or nonvirtual bus inputs. When generating code with preprocessor conditionals, the bus types and hierarchies of all bus inputs must be the same. In addition, all elements of a bus signal must have the same variant condition. Elements of a bus cannot have different variant conditions.

Similarly, all elements of a Mux, Demux, or a Vector Concatenate block signal must have the same variant condition.

### **Known Limitations**

- Variant condition propagation from Simulink Function inside Stateflow block is not supported.
- Variant condition propagation to Bus element port is not supported.
- When you simulate an Inline variants model with Simscape blocks, the Simscape blocks become unconditional.
- C++ code generation is not supported for models that contain propagated variant conditions.

### **Related Examples**

- “Define and Configure Variant Sources and Sinks” on page 11-54

### **More About**

- “Visualize Variant Implementations in a Single Layer” on page 11-51

# Create and Validate Variant Configurations

This example shows how to create and validate variant configurations for a model.

## Step 1: Open Variant Manager

- 1 Open the model in which you want to create variant configurations. For example, consider a model containing a Variant Source, Variant Sink, and a Variant Subsystem block.

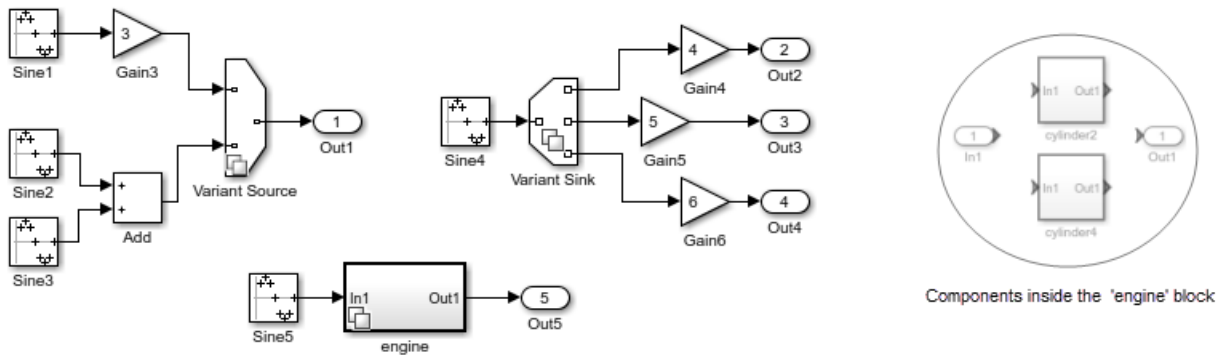

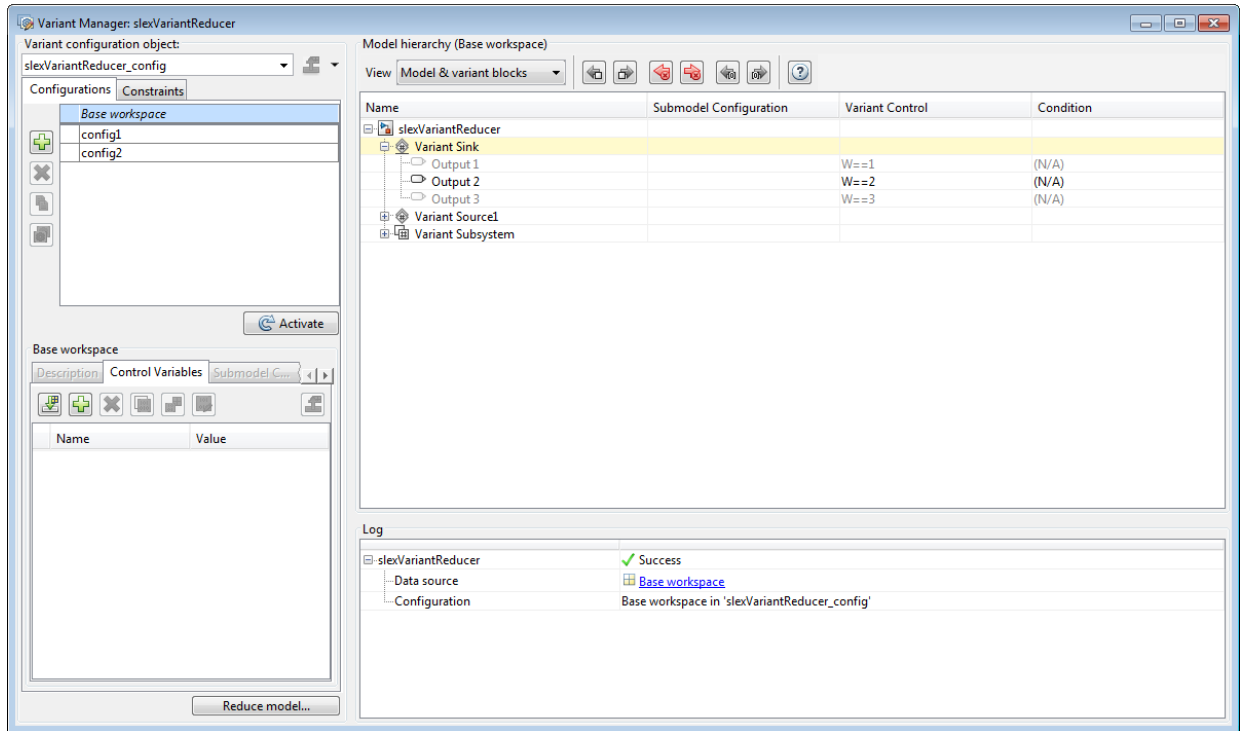

- 2 Right-click the variant badge and select **Open in Variant Manager**.





## Step 2: Define Variant Configuration

You can use the **Variant configuration data** pane to define and store a variant configuration. For detailed information on each pane, see “Variant Manager Overview”.

- 1 In the variant configuration data pane, click the **Configurations** tab.
- 2 Click . A variant configuration is added. Type a name for this configuration in the **Name** column.
- 3 Click the **Control Variables** tab in the controls section of the **Configurations** pane.
- 4 To import the control variables for the variant configuration from the global workspace, click  or  to add new control variables to the model.

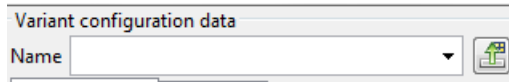
- 5 Type a name for the variant configuration in the **Name** box available at the top-left of Variant Manager.



- 6 To export the variant configuration information to the global workspace, click . The variant configuration for the model is now created.

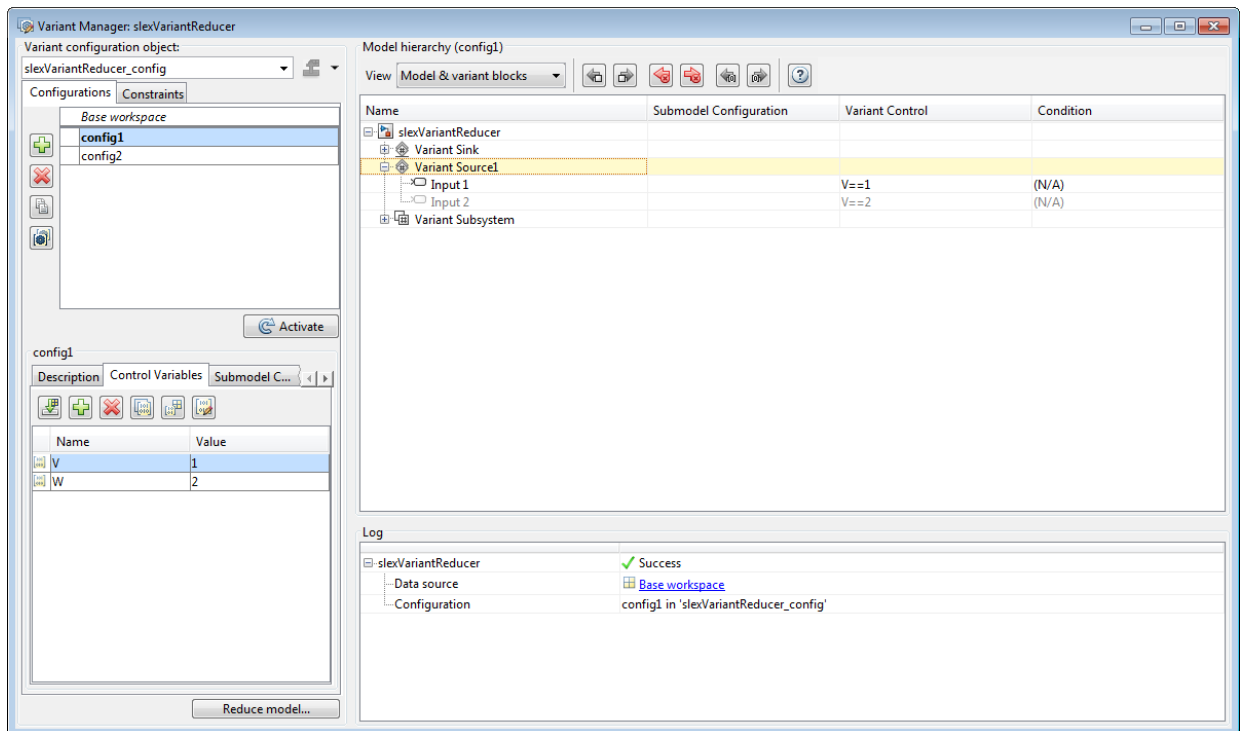

### Step 3: Activate and Validate Variant Configuration

To activate a variant configuration, select a configuration from the **Configurations** section and click the **Activate** button. The **Activate** button validates and applies the selected configuration on the model.

---

**Note:** To reduce a model based on a variant condition, click **Reduce model**. For more information, see “Reduce Models Containing Variant Blocks” on page 11-84

---

### **Related Examples**

- “Import Control Variables to Variant Configuration” on page 11-77
- “Define Constraints” on page 11-81

### **More About**

- “Approaches for Specifying Variant Controls” on page 11-17



## Import Control Variables to Variant Configuration

This example shows how to import control variables to a variant configuration and associate a configuration with a referenced submodel.

### Step 1: Open Variant Manager

- 1 Open `slexVariantManagementExample`, which contains the variant configurations.

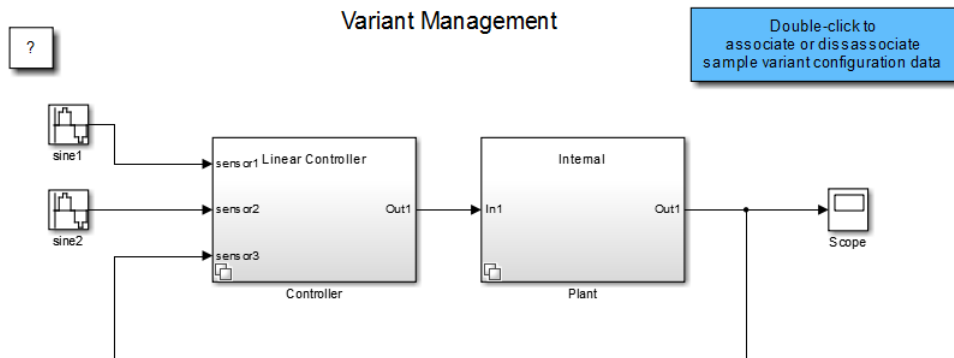

- 2 Double-click the blue block at the top to associate variant configuration data with the model.
- 3 Select **View > Variant Manager**.

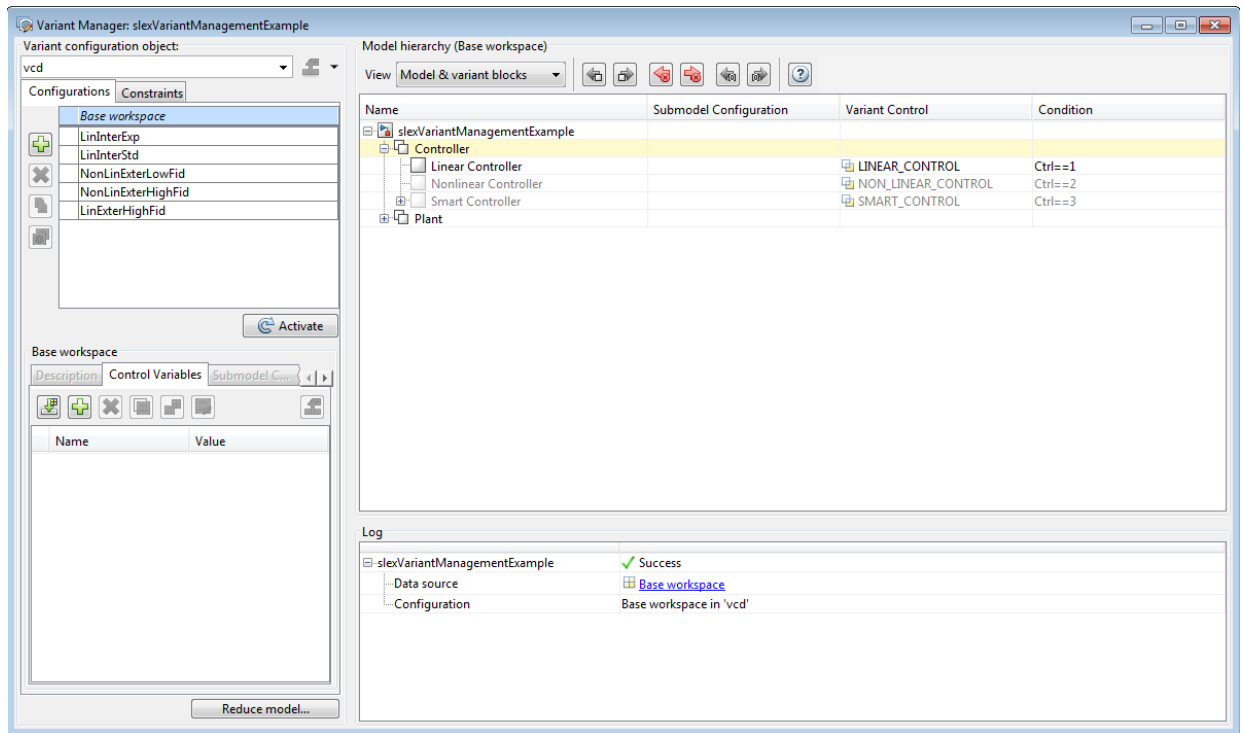

Variant configuration data vcd is associated with the model.

## Step 2: Import Variant Configuration

- 1 In the Variant Manager, in the **Configurations** tab, select **LinExterHighFid**.
- 2 In the **Control Variables** tab, click the **Import control variables from the base workspace** button .

The variables are imported.

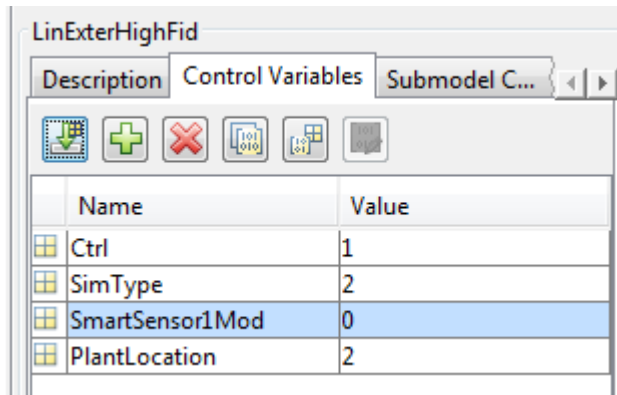

### Step 3: View Submodel Configuration

- 1 Open the referenced model `slexVariantManagementExternalPlantMdlRef`.

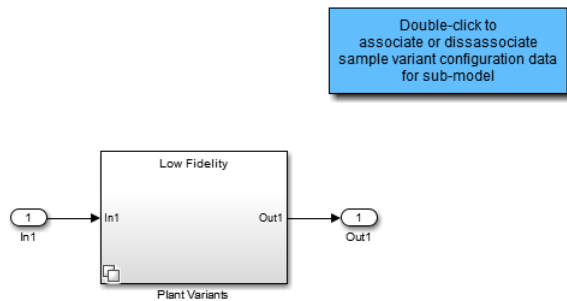

- 2 Double-click the blue block at the top to associate variant configuration data with the referenced model.
- 3 In the Variant Manager that is opened from `slexVariantManagementExample`, select `slexVariantManagementExternalPlantMdlRef` under the **Submodel Configurations** tab.
- 4 Select the `LOWFid` configuration from the dropdown menu.

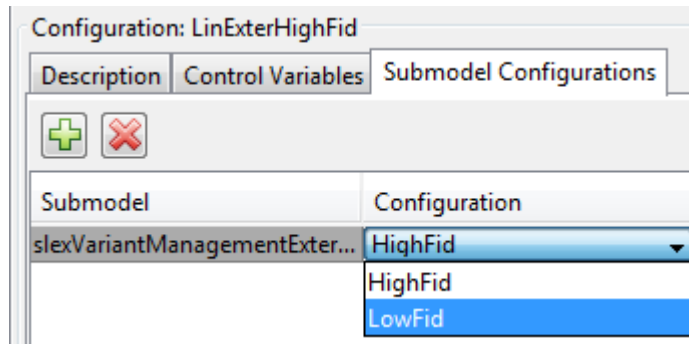

- 5 To validate the model using the `LinExterHighFid` variant configuration, select `LinExterHighFid` from the **Configurations** list and click **Activate**.

Simulink validates the new configuration against the model and returns the validation results.

## Related Examples

- “Define, Configure, and Activate Variants” on page 11-31

## More About

- “Introduction to Variant Controls” on page 11-16

## Define Constraints

This example shows how to define constraints that must evaluate to true for a variant configuration to become active.

- 1 Open `slexVariantManagementExample`.

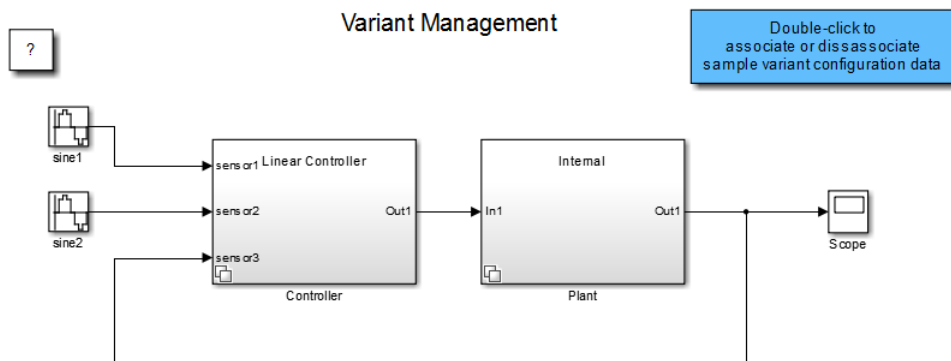

- 2 Select **View > Variant Manager**.

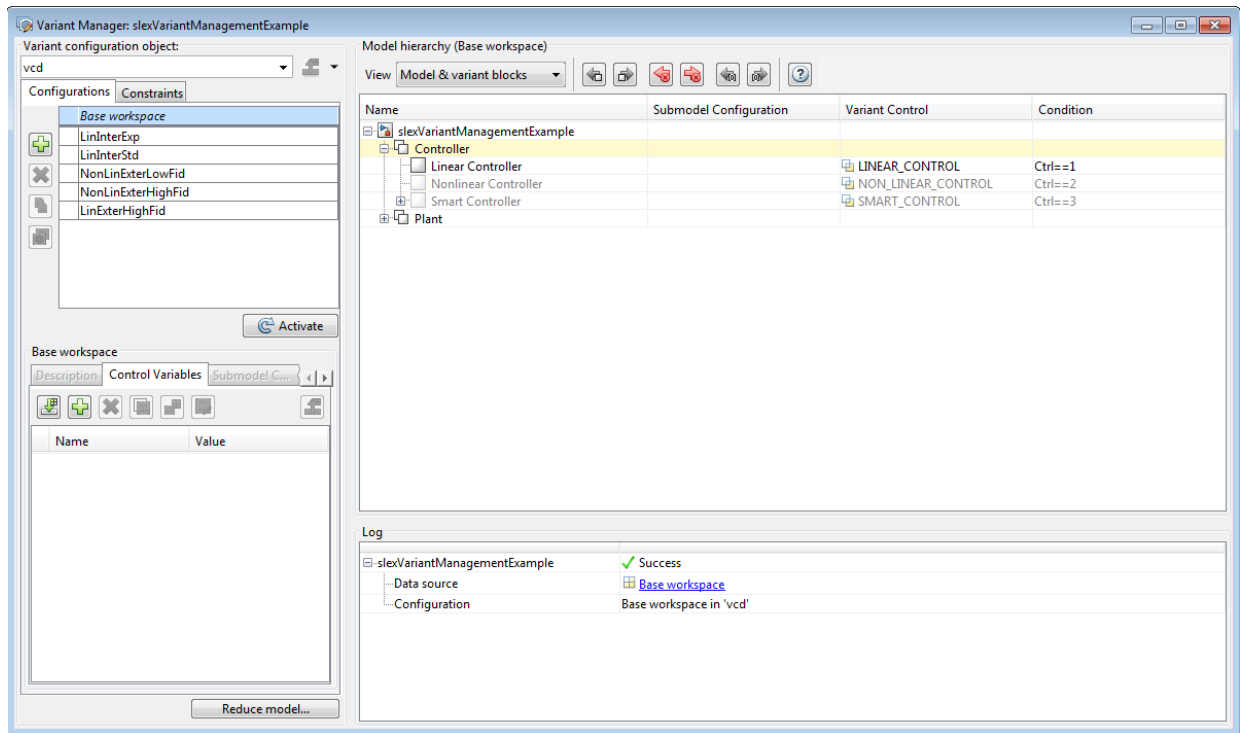

- 3 In the Variant Manager, in the **Constraints** tab, click .
- 4 Enter **LinNotExtern** as the **Name** and  $(Ctrl \sim = 1) \ || \ (PlantLocation \ \sim = 1)$  as the **Condition** for the constraint.

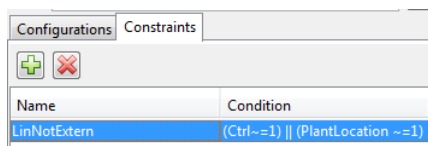

This constraint activates variants that do not use the Linear Controller and External Plant Controller configurations.

- 5 To activate and validate the constraint, click the **Activate** button.

## **Related Examples**

- “Create and Validate Variant Configurations” on page 11-73
- “Import Control Variables to Variant Configuration” on page 11-77

## **More About**

- “Create Variant Controls Programmatically” on page 11-29
- “Approaches for Specifying Variant Controls” on page 11-17

## Reduce Models Containing Variant Blocks

---

**Note:** You require a Simulink Design Verifier license to reduce your model.

---

A variant model can contain multiple variable structure and a single fixed structure. The combination of the variable structure and the fixed structure to create a model depends on different combinations of the variant choices that you select. Each combination of the variant choices can be stored as a variant configuration.

Variant models can be reduced to simplified, standalone model depending on the selected variant configurations.

Consider the model Variant Reducer. The model contains a Variant Source block, a Variant Sink block, and a Variant Subsystem block with these variant choices:

- Variant Source:  $V==1$  and  $V==2$
- Variant Sink:  $W==1$ ,  $W==2$ , and  $W==3$
- Variant Subsystem:  $V==1$  and  $V==2$

Assume that the model has two predefined variant configurations, named `config1` ( $V==1 \ \&\& \ W==2$ ) and `config2` ( $V==2 \ \&\& \ W==2$ ). These configurations are saved in a variant configuration data object, `varConfig`.



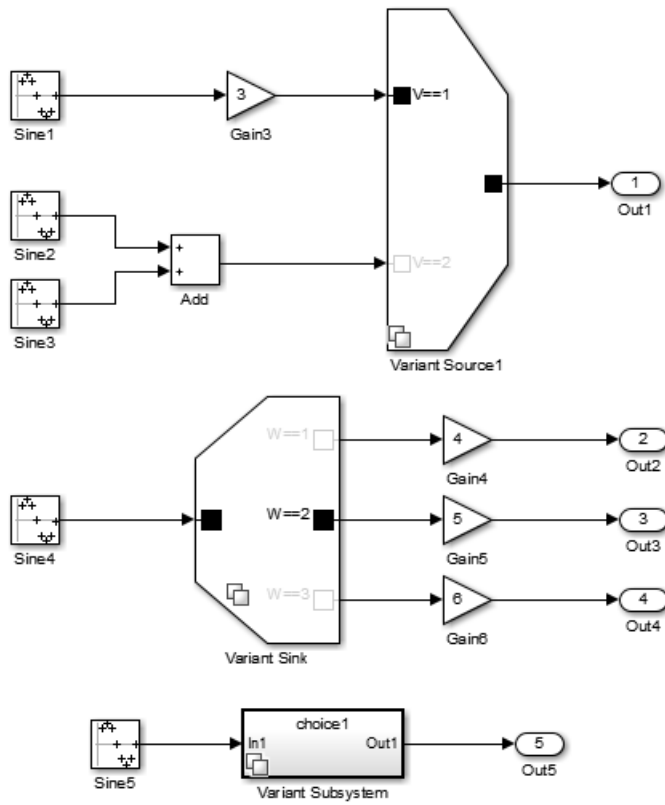

- 1 Right-click the variant badge, and select **Open in Variant Manager**. The Variant Manager opens displaying the predefined configurations.

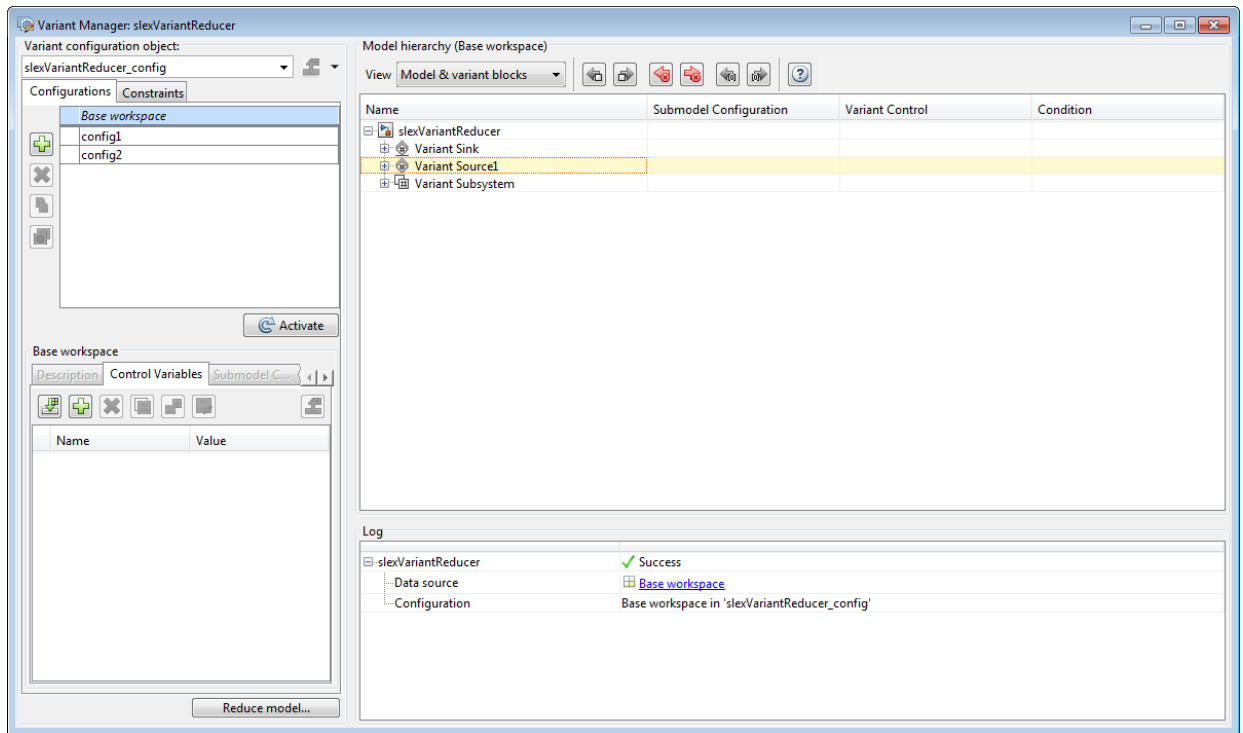

2 Click **Reduce model**. The Variant Reducer dialog box opens.

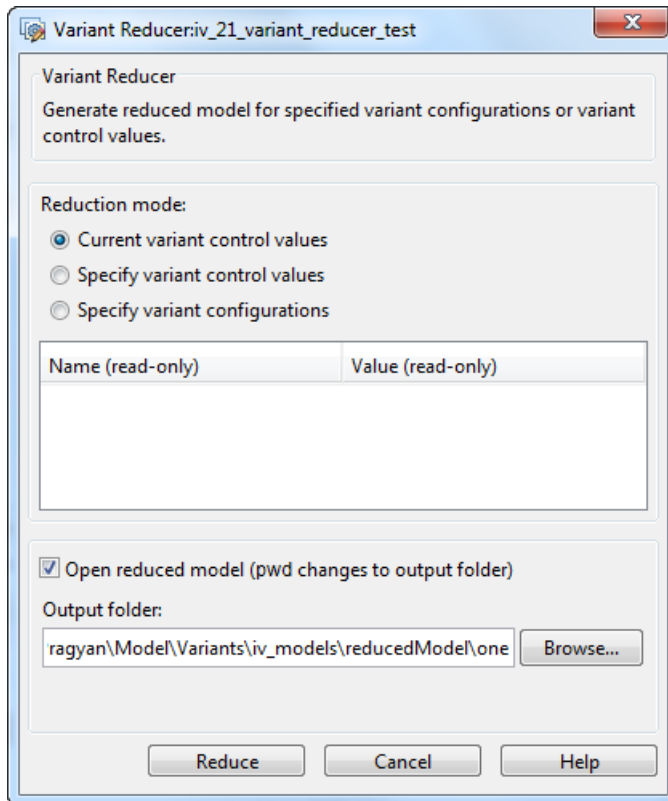

- 3** In the **Reduction mode** section, select:
- **Current variant control values** (default) : To reduce the model based on its variant control variable values in the global workspace.

Reduction mode:

Current variant control values  
 Specify variant control values  
 Specify variant configurations

Name (read-only)	Value (read-only)
V	1
W	2

Open reduced model (pwd changes to output folder)

Output folder:  
C:\Pragyan\Model\Variants\iv\_models\reducedModel

- **Specify variant control values:** To reduce the model based on the variant control variable values specified as a comma separated list.

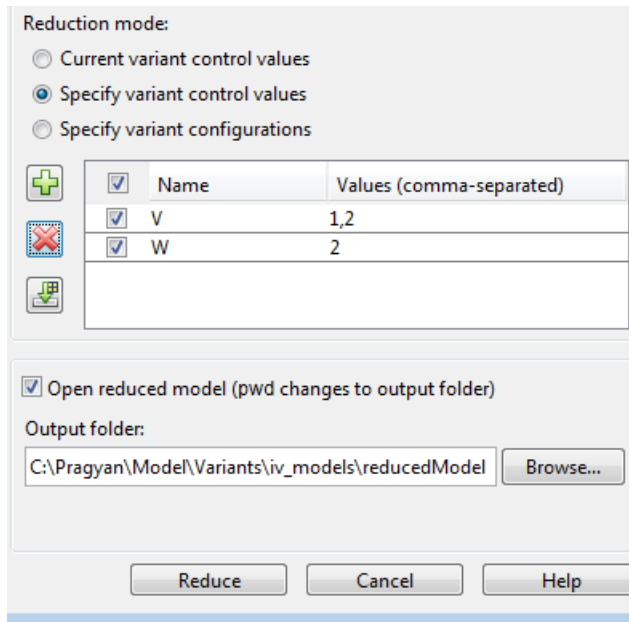

- **Specify variant configurations:** To reduce the model that is associated with a variant configuration data object and configurations to be retained in the reduced model.

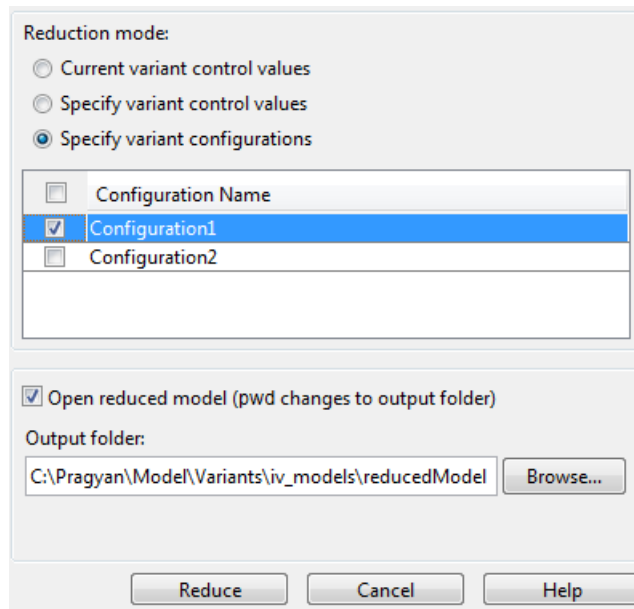

---

**Note:** During reduction, the control variable values from the last selected configuration are stored in the global workspace.

---

- 4 Specify the output folder to store the reduced model.

---

**Note:** To make the output folder as current working folder, select the **Open reduced model** check box

---

- 5 Click **Reduce**. The reduced model for the required configuration is now created. If the model contains resolved library links or referenced models, the corresponding parent is reduced for the specified configuration and is referenced in the model. The reduced model, reduced referenced model, and the reduced library get their names from the corresponding model, referenced model, or the library with `-r` appended to it.

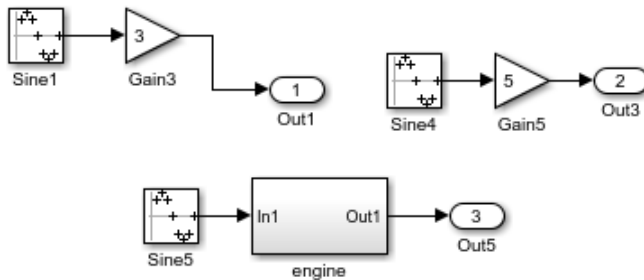

Consider a Variant model that contains a Simulink Function block with Variant condition on the Simulink Function block as  $V==1 \ || \ V==2 \ || \ V==3 \ || \ V==4$ . If the model is reduced for any or a combination of the available Variant conditions, the Simulink Function block in the reduced model is unconditional. For example, if the model is reduced for Variant condition,  $V=1$ ,  $V=2$ , and  $V=3$ , the Simulink Function block in the reduced model is unconditional. Whereas, if the model is reduced for Variant condition,  $V=1$ ,  $V=2$ , and  $V=5$ , the Simulink Function block in the reduced model remains conditional with  $V=1$  and  $V=2$  as the Variant condition.

## Reduce Model Programmatically

To reduce a model programmatically by using the below syntax:

```
Simulink.VariantManager.reduceModel(model, <Configuration>, <OutputFolder>)
```

For example,

- To reduce the model based on its variant control variable values in the global workspace.

```
Simulink.VariantManager.reduceModel('sldemo_variant_subsystems')
```

- To reduce the model based on its variant control variable values in the global workspace to a specified folder.

```
Simulink.VariantManager.reduceModel('sldemo_variant_subsystems', [], 'outdir')
```

- To reduce the model that is associated with a variant configuration data object and configurations to be retained in the reduced model.

```
Simulink.VariantManager.reduceModel('slexVariantManagementExample', ...
{'LinInterStd', 'NonLinExterHighFid'})
```

- To reduce the model by specifying configurations in the form of a structure of variant control variables.

```
Simulink.VariantManager.reduceModel('iv_model', struct('V', 1, 'W', [1 2]))
```

Here, two configurations are specified corresponding to  $\{V=1, W=1\}$  and  $\{V=1, W=2\}$ , respectively.

## Considerations and Limitations

- The output folder to store the reduced model must not be in `matlabroot`.
- If the model has dependencies on files that are located in `matlabroot`, these files are not modified or copied to the output folder during model reduction. File dependency can include files from the Simulink libraries, `.m` files, `.mat` files, `.sldd` files. Such models must be copied to a location that is not in `matlabroot` and then reduced.
- If the output folder contains the `variant_reducer.log` file from the previous model reduction, the reducer overwrites all the files available in that output for any subsequent reduction.
- Callback code (For example, model callbacks, mask initialization code and mask parameter callback codes) are not modified during model reduction and must be modified manually.
- Additional blocks are added automatically to the reduced model to ensure consistent simulation semantics. The additional blocks can include Signal Specification blocks for consistent signal attributes (data type, dimensions, complexity) or the Ground and the Terminator blocks for unconnected signals.
- During model reduction, commented blocks present on the active path are retained while the commented blocks presented on an inactive path are deleted.

## Related Examples

- “Create and Validate Variant Configurations” on page 11-73

## More About

- “Variant Condition Propagation with Variant Sources and Sinks” on page 11-61



## Condition Propagation with Variant Subsystem

When you specify variant conditions in models containing Variant Subsystem blocks, Simulink propagates these conditions to determine which components of the model are active during simulation. A variant condition can be a condition expression or a variant object.

The variant condition annotations help you visualize the propagated conditions. To view the variant condition annotations, click **Display > Blocks > Variant Condition Legend**.

---

**Note:** The **Variant Condition Legend** option is available only when **Display > Blocks > Variant Condition** is active.

---

Consider this model containing a Variant Subsystem block with variant choices. A specific variant condition activates each block.

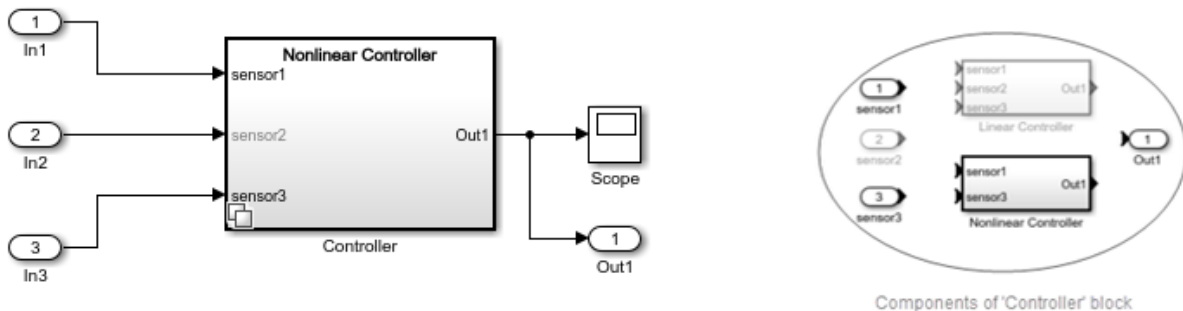

In the Variant Subsystem (Controller), sensor1 and sensor3 are used both in the Linear Controller and Nonlinear Controllers but sensor2 is used only in the Linear Controller. Hence, the sensor2 block is executed only when the Linear Controller choice is active and is not executed for any other choice. To ensure that the components outside of the Variant Subsystem (Controller) are aware of the active or inactive state of blocks with the Variant Subsystem, the block condition must propagate outside of the Variant Subsystem.

## Propagate Conditions Without Generate Preprocessor Conditionals

To propagate conditions outside of Variant Subsystems without generate preprocessor conditionals, select the **Propagate conditions outside of variant subsystem** check box in the **Block Parameter** dialog box of the Variant Subsystem block. By default, **Propagate conditions outside of variant subsystem** is not selected.

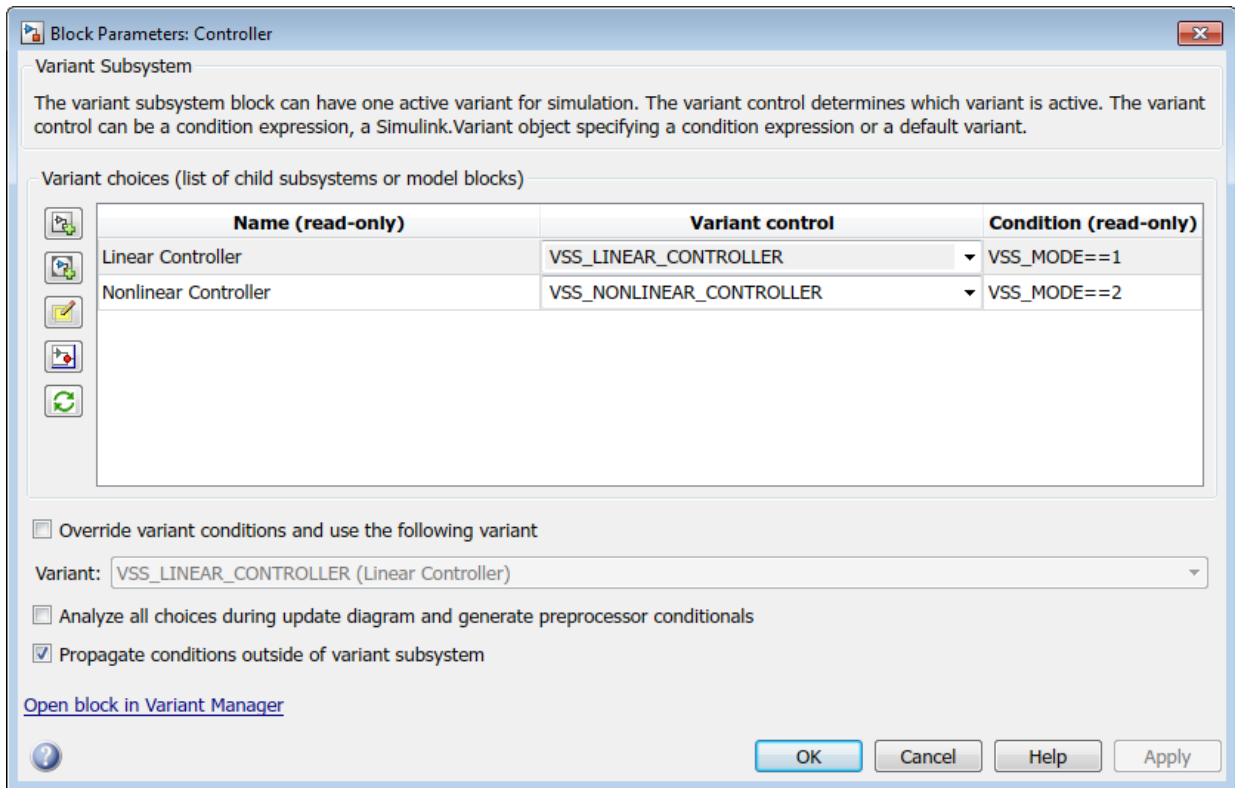

When you simulate the model with the active choice as Nonlinear Controller and the **Propagate condition outside of variant subsystem** selected, only the active choice is analyzed. Notice that the **Analyze all choices during update diagram and generate preprocessor conditional** check box is not selected.

The **Variant Condition Legend** displays the inactive conditions as **false**. Here, **sensor2** is inactive with variant choice as Nonlinear Controller and is marked as

false. The annotations are displayed on the `sensor2` port and the inactive block that is connected to `sensor2`.

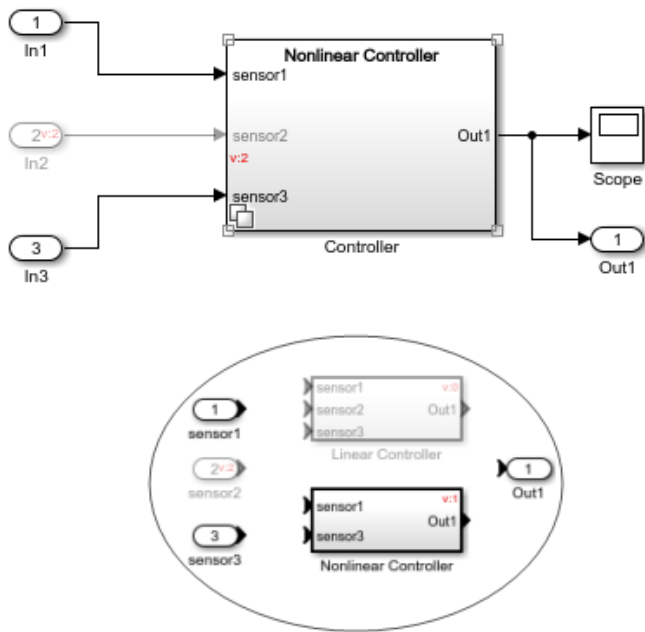

Components of 'Controller' block

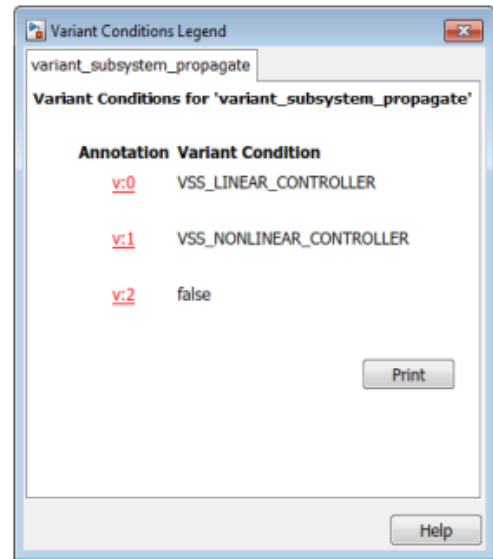

When you generate code for condition propagation without generate preprocessor conditionals, the inactive blocks are ignored. In this example, the input port `In2` is not shown in the generated code.

```

/* External inputs (root inport signals with auto storage) */
typedef struct {
    real_T In1;                /* '<Root>/In1' */
    real_T In3;                /* '<Root>/In3' */
} EXTU_variant_subsvstem_propagate_T;
  
```

## Propagate Conditions with Generate Preprocessor Conditionals

To propagate conditions outside of Variant Subsystem with generate preprocessor conditionals, select the **Propagate conditions outside of variant subsystem** check box and the **Analyze all choice during update diagram and generate preprocessor conditionals** check box in the **Block Parameter** dialog box of the Variant Subsystem.

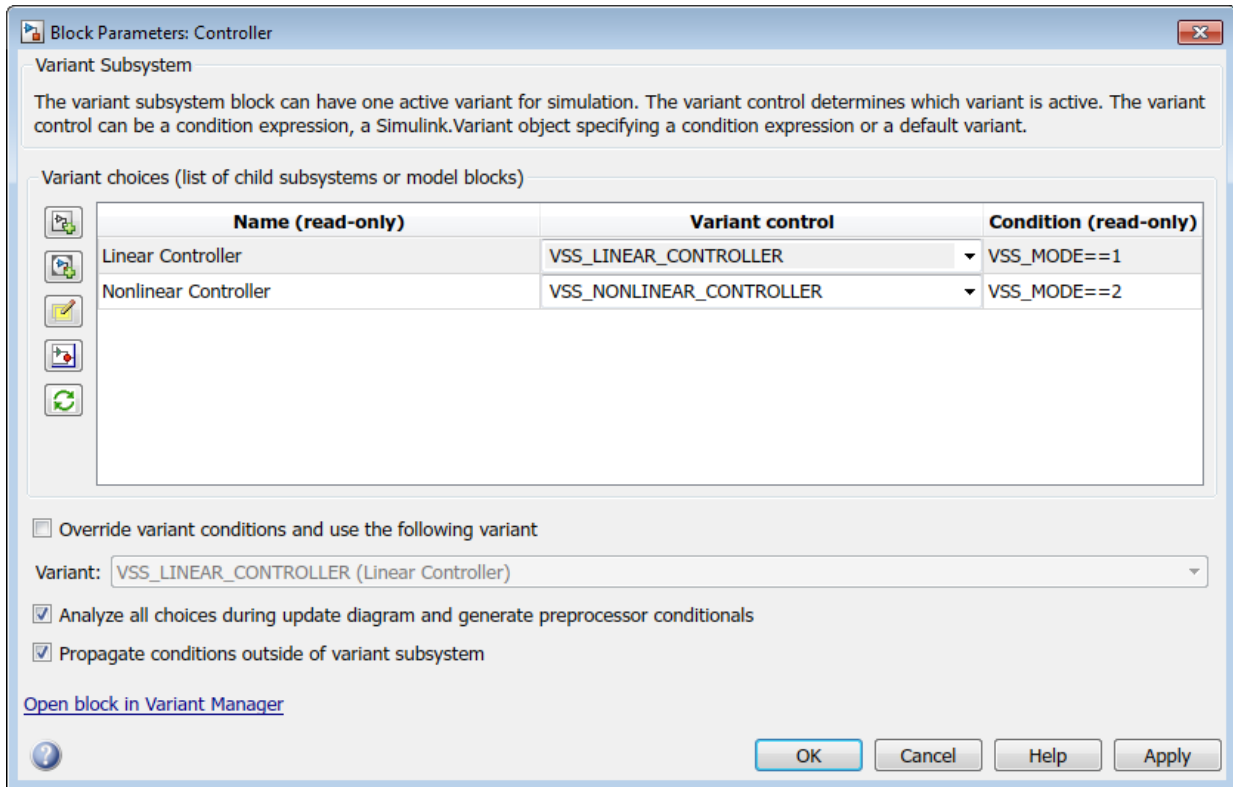

When you simulate the model with active choice as Nonlinear Controller and **Propagate conditions outside of variant subsystem** check box and the **Analyze all choice during update diagram and generate preprocessor conditionals** check box selected, all the variant choices are analyzed. The **Variant Condition Legend** displays the variant conditions associated with the model.

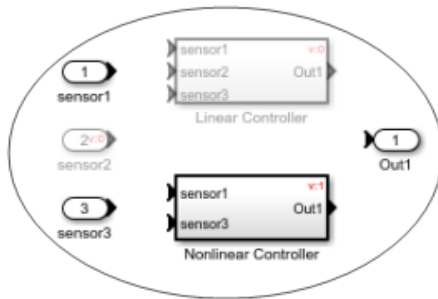
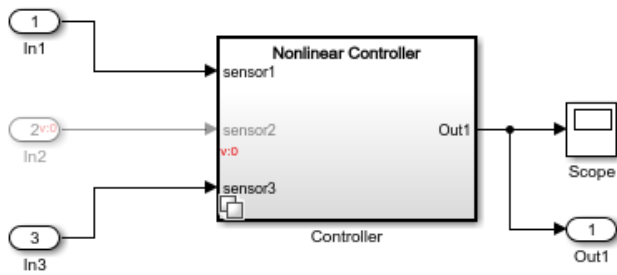

Components of 'Controller' block

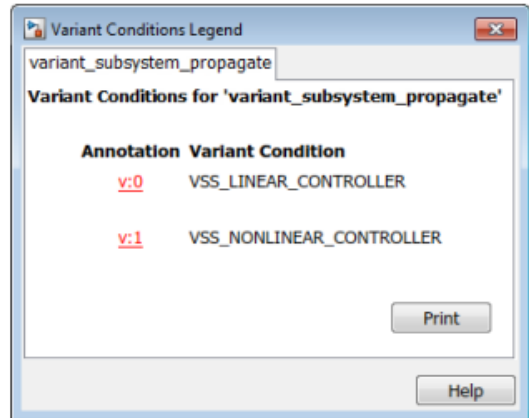

When you generate code for condition propagation with generate preprocessor conditionals, the model is analyzed for all the choices. In this example, the input port In2 is guarded with necessary conditions.

```
/* External inputs (root inport signals with auto storage) */
typedef struct {
    real_T In1;                                /* '<Root>/In1' */

#ifdef VSS_LINEAR_CONTROLLER

    real_T In2;                                /* '<Root>/In2' */

#define EXTU_VARIANT_SUBSYSTEM_PROPAGATE_T_VARIANT_EXISTS
#endif                                        /* VSS_LINEAR_CONTROLLER */

    real_T In3;                                /* '<Root>/In3' */
} EXTU_variant_subsystem_propagate_T;
```

## Adaptive Interface for Variant Subsystems

When you select the **Propagate conditions outside of variant subsystem** check box in the **Block Parameters** dialog box, the Variant Subsystem adapts its interface to the connected blocks. Consider this model.



## Adaptive Interfaces for Variant Subsystems

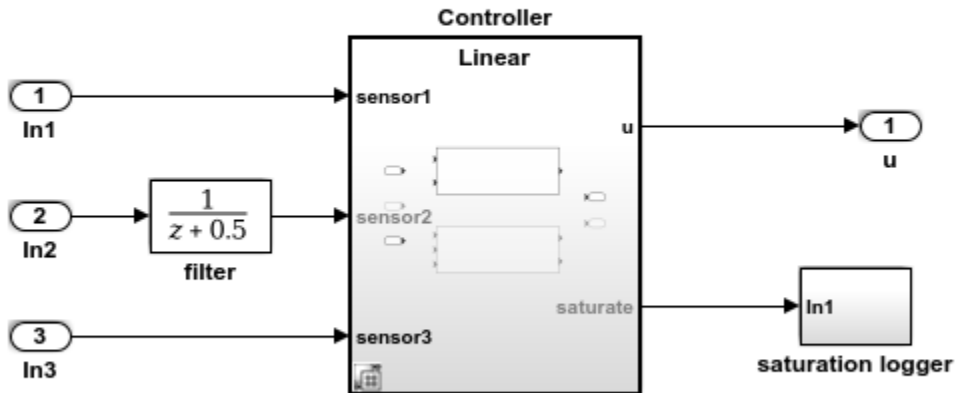

Copyright 2016 The MathWorks, Inc.

The Controller block is a Variant Subsystem that provides a Linear and a Nonlinear choice. The Linear choice is active when  $V = 1$ , and the Nonlinear choice is active when  $V = 2$ . Here,  $V$  is a variant control variable of the Simulink.Parameter type. Select the Controller block and, in Simulink click **Diagram > Block Parameters** (Subsystem). Verify that the **Propagate condition outside of variant subsystem** check box is selected.

To change the value of the variant control variable, in the MATLAB command window, type  $V.Value = 1$  or  $V.Value = 2$ .

Double-click the Controller block to view its contents. The Linear choice is using sensor1 and sensor3 inputs of the Controller (Variant Subsystem block). It is not using sensor2 and, therefore, does not produce a saturate output.

When you simulate this model, the Variant Subsystem block adapts its interface such that the condition  $V = 2$  ( $v:1 \ V=2$ ) propagates the In2, the filter, and the saturation logger blocks.

## Known Limitations

- Propagated variant conditions from variant subsystems cannot be set on blocks in Simscape domain or Stateflow based blocks.
- C++ code generation is not supported for models that contain propagated conditions outside of a Variant Subsystem.
- The propagated conditions to a Variant Subsystem choice block must be a subset of the variant condition on the variant subsystem block itself.

## Propagate Conditions Programmatically

To propagate conditions outside of Variant Subsystem programmatically, use one of these syntaxes:

- Propagate conditions without generate preprocessor conditionals:

```
set_param(VariantSubsystemName, 'PropagateVariantConditions','on')
```

For example,

```
set_param('sldemo_variant_subsystems/Controller', 'PropagateVariantConditions','on')
```

- Propagate conditions with generate preprocessor conditionals:

```
set_param(VariantSubsystemName, 'PropagateVariantConditions','on', 'GeneratePreprocessorConditionals','on')
```

For example,

```
set_param('sldemo_variant_subsystems/Controller', 'PropagateVariantConditions','on',  
'GeneratePreprocessorConditionals','on')
```

## More About

- “Prepare Variant-Containing Model for Code Generation” on page 11-40
- “Variant Condition Propagation with Variant Sources and Sinks” on page 11-61
- “Model AUTOSAR Variants” (Embedded Coder)
- “Represent Subsystem and Model Variants in Generated Code” (Embedded Coder)



- Masking Variant Model

## Variants Example Models

The Simulink Variants Example models help you to understand and use the variant blocks and features.

Variant Subsystem	Variant Subsystems – Enumerations and Reuse	Adaptive Interfaces for Variant Subsystems	Variant Source and Variant Sink Blocks
Manual Variant Source and Sink Blocks	Variant Source and Sinks blocks in car wiper motor	Variant Management	Variant Reducer
Variant Sensors	Masking a Variants Subsystem	Variant Condition Propagation to Subsystems	Variants with Function-Call Subsystem
Variants with Simulink Functions	Variant Condition Propagation to Conditionally Executed Subsystems	Variant Conditions and Data Stores	Variant Condition Propagation and Model Blocks
Controlling and Stopping Variant Condition Propagation	Generate preprocessor conditionals for Variant Subsystems	Dimension Variants	Model Reference Variants
Model Reference Variants - Enumerations and Reuse	Generate preprocessor conditionals for model Subsystems		

### More About

- “Introduction to Variant Controls” on page 11-16

- “Create a Simple Variant Model” on page 11-25

## Use Subsystem Variants To Generate Code That Uses C Preprocessor Conditionals

This example shows how to use Simulink® variant subsystems to generate C preprocessor conditionals that control which child subsystem of the variant subsystem is active in the generated code produced by the Simulink® Coder™.

### Overview of Variant Subsystems

A Variant Subsystem block contains two or more child subsystems where one child is active during model execution. The active child subsystem is referred to as the *active variant*. You can programmatically switch the active variant of the Variant Subsystem block by changing values of variables in the base workspace, or by manually overriding variant selection using the Variant Subsystem block dialog. The *active variant* is programmatically wired to the Inport and Outport blocks of the Variant Subsystem by Simulink® during model compilation.

To programmatically control variant selection, a `Simulink.Variant` object is associated with each child subsystem in the Variant Subsystem block dialog. `Simulink.Variant` objects are created in the MATLAB® base workspace. These objects have a property named `Condition`, an expression, which evaluates to a Boolean value and is used to determine the active variant child subsystem.

When you generate code, you can only generate code for the active variant. You can also generate code for all variants of a Variant Subsystem block and defer the choice of active variant until it is time to compile the generated code.

### Specifying Variants for a Subsystem Block

Opening the example model `rtwdemo_preprocessor_subsys` will run the `PostLoadFcn` defined in the "File: ModelProperties: Callbacks" dialog. This will populate the base workspace with the variables for the Variant Subsystem blocks.

```
open_system('rtwdemo_preprocessor_subsys')
```

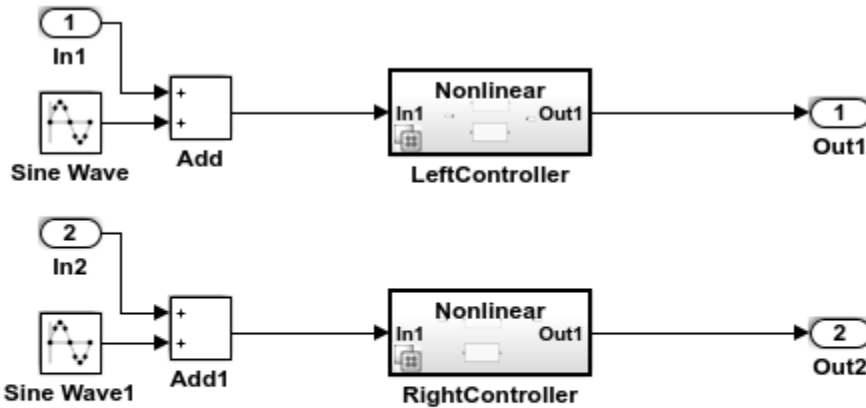

This model shows the generation of preprocessor conditionals for variant subsystems.

Copyright 2009-2014 The MathWorks, Inc.

The LeftController variant subsystem contains two child subsystems: Linear and Nonlinear. The LeftController/Linear child subsystem executes when the Simulink.Variant object LINEAR evaluates to true, and the LeftController/Nonlinear child subsystem executes when the Simulink.Variant object NONLINEAR evaluates to true.

Simulink.Variant objects are specified for the LeftController subsystem by right-clicking the LeftController subsystem and selecting **Subsystem Parameters**, which will open the LeftController subsystem block dialog.

```
open_system('rtwdemo_preprocessor_subsys/LeftController');
```

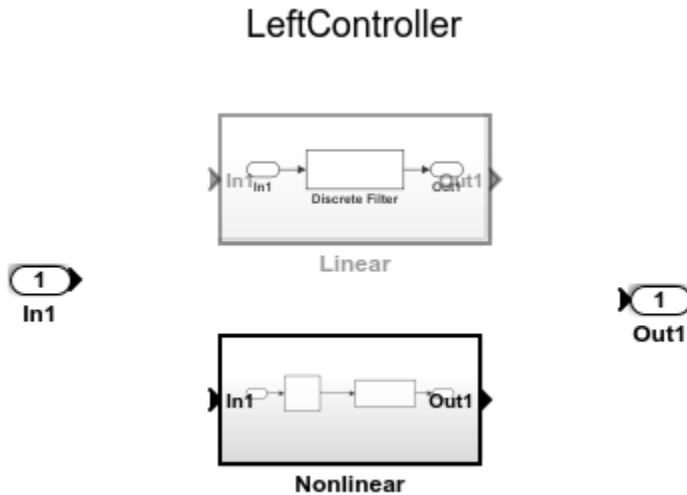

The LeftController subsystem block dialog creates an association between the Linear and Nonlinear subsystems with the two Simulink.Variant objects, LINEAR and NONLINEAR, that exist in the base workspace. These objects have a property named Condition, an expression, which evaluates to a Boolean value and determines the active variant child subsystem (Linear or Nonlinear). The condition is also shown in the subsystem block dialog. In this example, the conditions of LINEAR and NONLINEAR are 'VSSMODE == 0' and 'VSSMODE == 1', respectively.

In this example, the Simulink.Variant objects are created in the base workspace.

```
LINEAR = Simulink.Variant;
LINEAR.Condition = 'VSSMODE==0';
NONLINEAR = Simulink.Variant;
NONLINEAR.Condition = 'VSSMODE==1';
```

### Specifying a Variant Control Variable

Variant objects allow you to reuse arbitrarily complex conditions throughout a model. Multiple Variant Subsystem blocks can use the same Simulink.Variant objects, allowing you to toggle the activation of subsystem variants as a set. You can toggle the set prior to simulation by changing the value of VSSMODE in the MATLAB environment or when compiling the generated code, as explained in the next section. In this example,

LeftController and RightController reference the same variant objects, so that you can toggle them simultaneously.

The nonlinear controller subsystems implement hysteresis, while the linear controller subsystems act as simple low-pass filters. Open the subsystem for the left channel. The subsystems for the right channel are similar.

The generated code accesses the variant control variable `VSSMODE` as a user-defined macro. In this example, `rtwdemo_importedmacros.h` supplies `VSSMODE`. Within the MATLAB environment, you specify `VSSMODE` using a `Simulink.Parameter` object. Its value will be ignored when generating code including preprocessor conditionals. However, the value is used for simulation. The legacy header file specifies the value of the macro to be used when compiling the generated code, which ultimately activates one of the two specified variants in the embedded executable.

Variant control variables can be defined as `Simulink.Parameter` objects with one of these storage classes:

- `Define` or `ImportedDefine` with header file specified
- `CompilerFlag`
- `SystemConstant` (AUTOSAR)
- User-defined custom storage class that defines data as a macro in a specified header file

```
VSSMODE = Simulink.Parameter;  
VSSMODE.Value = 1;  
VSSMODE.DataType = 'int32';  
VSSMODE.CoderInfo.StorageClass = 'Custom';  
VSSMODE.CoderInfo.CustomStorageClass = 'ImportedDefine';  
VSSMODE.CoderInfo.CustomAttributes.HeaderFile = 'rtwdemo_importedmacros.h';
```

### Simulating the Model with Different Variants

Because you set the value of `VSSMODE` to 1, the model uses the nonlinear controllers during simulation.

```
sim('rtwdemo_preprocessor_subsys')  
youtn1 = yout;
```

If you change the value of `VSSMODE` to 0, the model uses the linear controllers during simulation.

```
VSSMODE.Value = int32(0);  
sim('rtwdemo_preprocessor_subsys')  
yout1 = yout;
```

You can plot and compare the response of the linear and nonlinear controllers:

```
figure('Tag','CloseMe');  
plot(tout, youtnl.signals(1).values, 'r-', tout, youtl.signals(1).values, 'b-')  
title('Response of Left Channel Linear and Nonlinear Controllers');  
ylabel('Response');  
xlabel('Time (seconds)');  
legend('nonlinear','linear')  
axis([0 100 -0.8 0.8]);
```

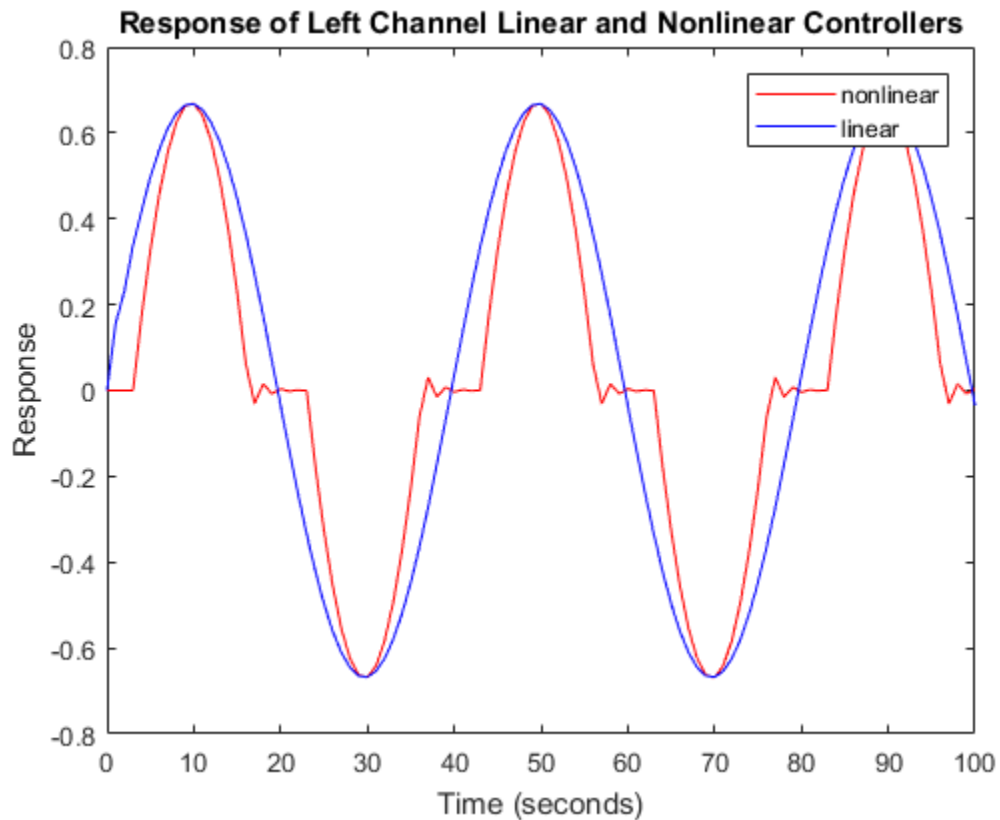



## Using C Preprocessor Conditionals

This example model has been configured to generate C preprocessor conditionals. You can generate code for the model by selecting Code > C/C++ Code > Build Model.

To activate code generation of preprocessor conditionals, check whether the following conditions are true:

- Select an Embedded Coder® target in **Code Generation > System target file** in the Configuration Parameters dialog box
- In the Variant Subsystem block parameter dialog box, clear the option to **Override variant conditions and use following variant**
- In the Variant Subsystem block parameter dialog box, Select the option to **Analyze all choices during update diagram and generate preprocessor conditionals**.

The Simulink® Coder™ code generation report contains sections in the Code Variants report dedicated to the subsystems that have variants controlled by preprocessor conditionals.

In this example, the generated code includes references to the Simulink.Variant objects `LINEAR` and `NONLINEAR`, as well as the definitions of macros corresponding to those variants. Those definitions depend on the value of `VSSMODE`, which is supplied in an external header file `rtwdemo_importedmacros.h`. The active variant is determined by using preprocessor conditionals (`#if`) on the macros (`#define`) `LINEAR` and `NONLINEAR`.

The macros `LINEAR` and `NONLINEAR` are defined in the generated `rtwdemo_preprocessor_subsys_types.h`, header file:

```
#ifndef LINEAR
#define LINEAR      (VSSMODE == 0)
#endif

#ifndef NONLINEAR
#define NONLINEAR  (VSSMODE == 1)
#endif
```

In the generated code, the code related to the variants is guarded by C preprocessor conditionals. For example, in `rtwdemo_preprocessor_subsys.c`, the calls to the step and initialization functions of each variant are conditionally compiled:

```
/* Outputs for atomic SubSystem: '<Root>/LeftController' */
#if LINEAR
```

```
        /* Output and update for atomic system: '<S1>/Linear' */  
#elif NONLINEAR  
        /* Output and update for atomic system: '<S1>/Nonlinear' */  
#endif
```

Close the model, figure, and workspace variables from the example.

```
bdclose('rtwdemo_preprocessor_subsys')  
close(findobj(0,'Tag','CloseMe'));  
clear LINEAR NONLINEAR VSSMODE  
clear tout yout youl1 youn1
```

# Propagating Variant Conditions to Subsystems

A Subsystem can be virtual or atomic. Simulink propagates variant conditions differently to such Subsystems. This example shows the propagation of variant conditions from Inline variants to Subsystem blocks. Consider a model as shown:



## Variant Condition Propagation to Subsystems

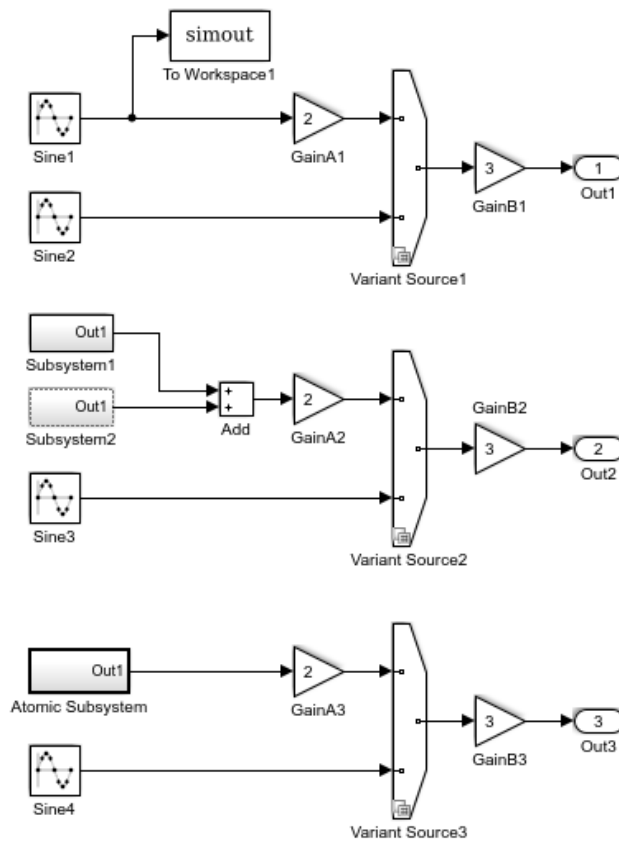

Click **Simulation > Run** to simulate this model and see the variant conditions being propagated from the Variant Source blocks to the blocks connected to it.

The variant condition annotation helps you visualize the propagated conditions. To be able to view the variant condition annotation, click **Display > Blocks > Variant Condition Legend**.

The model contains three Variant Source blocks: Variant Source1, Variant Source2, and Variant Source3, respectively.

Variant Source1 contains conditions  $V = 1$  and  $V = 2$  at inport. The variant condition  $V = 1$  propagates to GainA1 while  $V = 2$  propagates to Sine2. The Sine1 block does not get any propagated variant conditions because it is connected to an unconditional block To Workspace1. If the To Workspace block1 did not exist or was commented-out before simulating the model, variant condition  $V = 1$  propagates to Sine1.

Variant Source2 is connected to virtual subsystems Subsystem1 and Subsystem2 that have identical contents, a Sine Wave block connected to a To Workspace and an Output blocks. Subsystem1 is a grouped virtual subsystem (**Treat as grouped when propagating variant conditions** is selected) while Subsystem2 (**Treat as grouped when propagating variant conditions** is clear) is an ungrouped virtual subsystem.

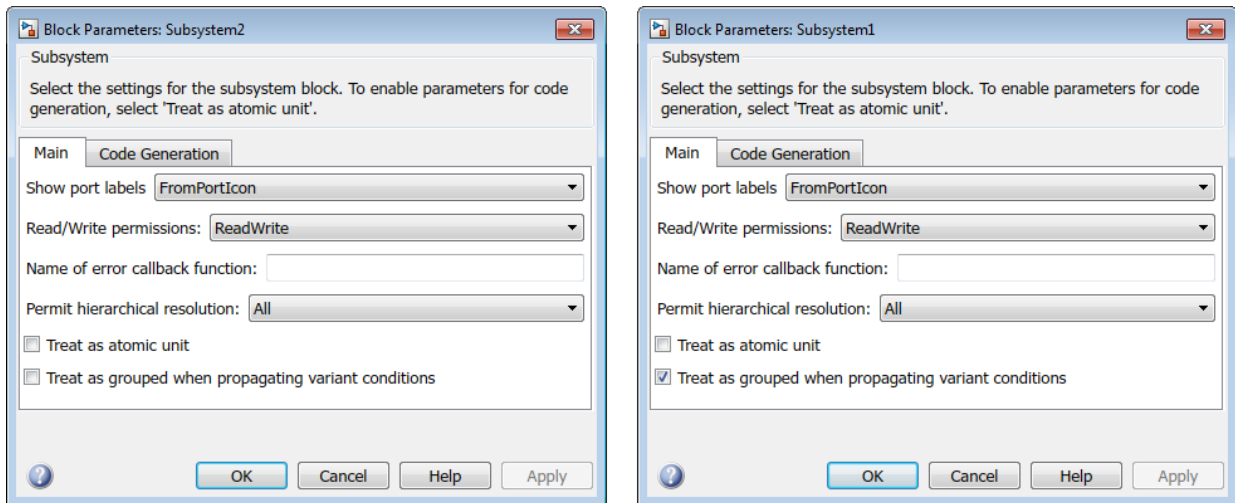

A Subsystem block becomes a grouped virtual subsystem when you select the **Treat as grouped when propagating variant conditions** checkbox in the block parameters

dialog box. When the **Treat as grouped when propagating variant conditions** checkbox is clear, the Subsystem is an ungrouped virtual subsystem.

A grouped subsystem represents a system of equation and hence the propagated conditions also apply to the blocks within this system. A grouped subsystem has a continuous boundary line. An ungrouped subsystem does not represent a system of equation and the blocks within it have ungrouped semantics. An ungrouped subsystem has a dotted boundary line and the conditions are propagated into the subsystem.

The variant condition  $V = 1$  propagates to **Subsystem1** and further to the blocks within it as **Subsystem1** is a grouped virtual subsystem (represents a system of equation).

**Subsystem2** that is an ungrouped virtual subsystem (does not represent a system of equation) also receives  $V = 1$  as the propagated condition, and the propagated variant condition  $V = 1$  propagates into **Subsystem 2** as if the subsystem were expanded.

**Variant Source3** is connected to a nonvirtual (atomic) subsystem with  $V = 1$  as the propagated variant condition. A nonvirtual (atomic) subsystem always represents a system of equations. An atomic subsystem has a continuous solid boundary line. The variant condition does not propagate inside of a nonvirtual subsystem. Instead, it stays on the boundary. The nonvirtual subsystem behaves as an entity.

### **More About**

- “Condition Propagation with Variant Subsystem”

## Variant Subsystems

This model illustrates Simulink® variant subsystems. Variant subsystems let you provide multiple implementations for a subsystem where only one implementation is active during simulation. You can programmatically swap out the active implementation and replace it with one of the other implementations without modifying the model.

### Overview of Variant Subsystems

A Variant Subsystem block contains two or more child subsystems where one child is active during model execution. The active child subsystem is referred to as the *active variant*. You can programmatically switch the active variant of the Variant Subsystem block by changing values of variables in the base workspace, or by manually overriding variant selection using the Variant Subsystem block dialog. The *active variant* is programmatically wired to the Inport and Outport blocks of the Variant Subsystem by Simulink during model compilation.

To programmatically control variant selection, a `Simulink.Variant` object is associated with each child subsystem in the Variant Subsystem block dialog. `Simulink.Variant` objects are created in the MATLAB® base workspace. These objects have a property named `Condition`, which is an expression, that evaluates to a boolean value and is used to determine the active variant child subsystem. For example, defining

```
VSS_LINEAR_CONTROLLER=Simulink.Variant('VSS_MODE==1');
```

in the base workspace creates a `Simulink.Variant` object where the constructor argument (`'VSS_MODE==1'`) defines when the variant is active. Using the Variant Subsystem dialog, you then associate `VSS_LINEAR_CONTROLLER` with one of the child subsystems within the Variant Subsystem. Defining

```
VSS_MODE=1
```

in the base workspace, activates the `VSS_LINEAR_CONTROLLER` variant. The condition argument can be a *simple expression* consisting of scalar variables, enumerations, equality, inequality, `&&`, `,` and `~`. Parenthesis `()` can be used for precedence grouping.

### Using Variant Subsystems

The model in this example uses the following variant objects and variant control variable, which are defined in the MATLAB base workspace:

```
VSS_LINEAR_CONTROLLER=Simulink.Variant('VSS_MODE==1');
```

```
VSS_NONLINEAR_CONTROLLER=Simulink.Variant('VSS_MODE==2');
```

```
VSS_MODE=2;
```

Opening the example model `sldemo_variant_subsystems` runs the **PreLoadFcn** defined in **File -> ModelProperties -> Callbacks**. This populates the base workspace with the variables for the Variant Subsystem block named **Controller**:

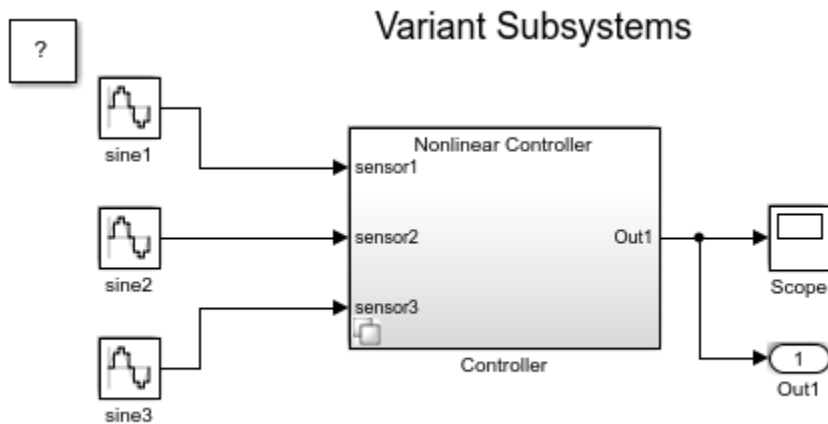

Copyright 2010-2013 The MathWorks, Inc.

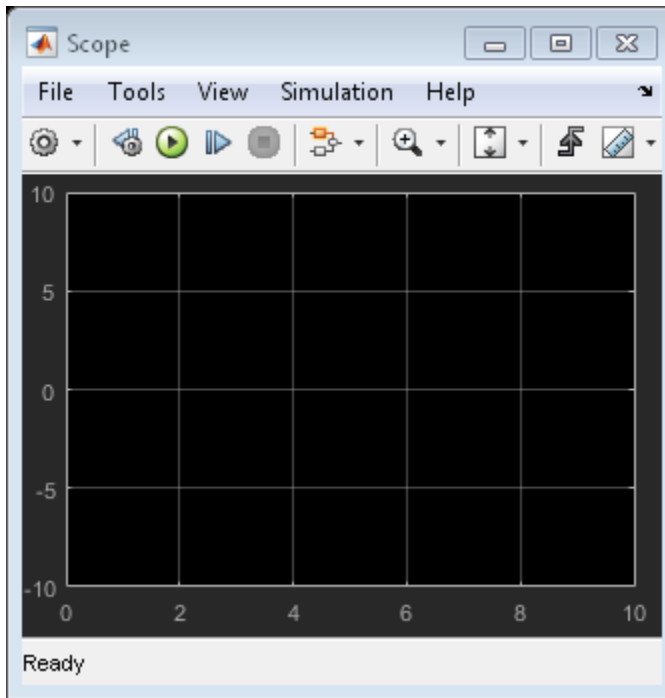

**Figure 1:** The example model, `sldemo_variant_subsystems`

To specify the `Simulink.Variant` objects association for the Controller subsystem, right-click on the Controller subsystem and select **Subsystem Parameters**, which will open the Controller subsystem block dialog.

The Controller subsystem block dialog specifies two potential variants. The two variants are in turn associated with the two `Simulink.Variant` objects `VSS_LINEAR_CONTROLLER` and `VSS_NONLINEAR_CONTROLLER`, which exist in the base workspace. These objects have a property named **Condition**, an expression that evaluates to a boolean and that determines which variant is active. The condition is also shown in the Variant Subsystem block dialog. In this example, the Condition properties of `VSS_LINEAR_CONTROLLER` and `VSS_NONLINEAR_CONTROLLER` are `VSS_MODE == 1` and `VSS_MODE == 2`, respectively. The variable `VSS_MODE` resides in the base workspace, and can be a standard MATLAB variable or a `Simulink.Parameter`.



If there is no associated variant object or a '%' (comment) character prefixes the variant object in the Variant Subsystem parameters dialog box, then the child subsystem is considered commented out and is not used during model execution.

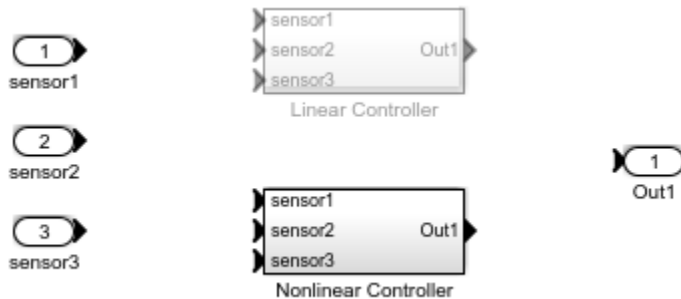

**Figure 2:** Contents of the Controller subsystem block

Within a Variant Subsystem block, you can place Inport, Outport, and Subsystem blocks. In this example, the `Linear Controller` Subsystem block is associated with the variant object, `VSS_LINEAR_CONTROLLER`, and the `Nonlinear Controller` Subsystem block is associated with the variant object, `VSS_NONLINEAR_CONTROLLER`.

Signal connections are not allowed in the Variant Subsystem. Simulink programmatically wires up the Inport and Outport blocks to the active variant when simulating the model.

### Switching Active Variants

To simulate using the `Linear Controller` variant, define:

```
VSS_MODE=1
```

in the base workspace and then simulate the model.

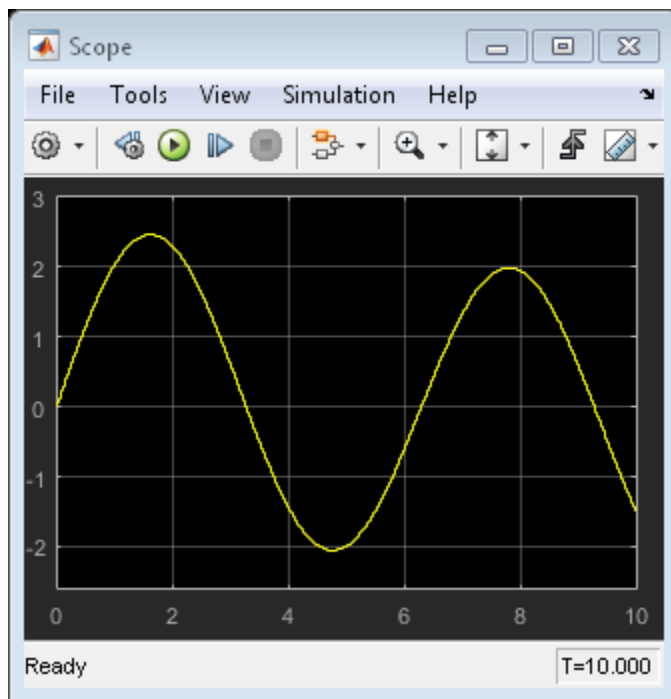
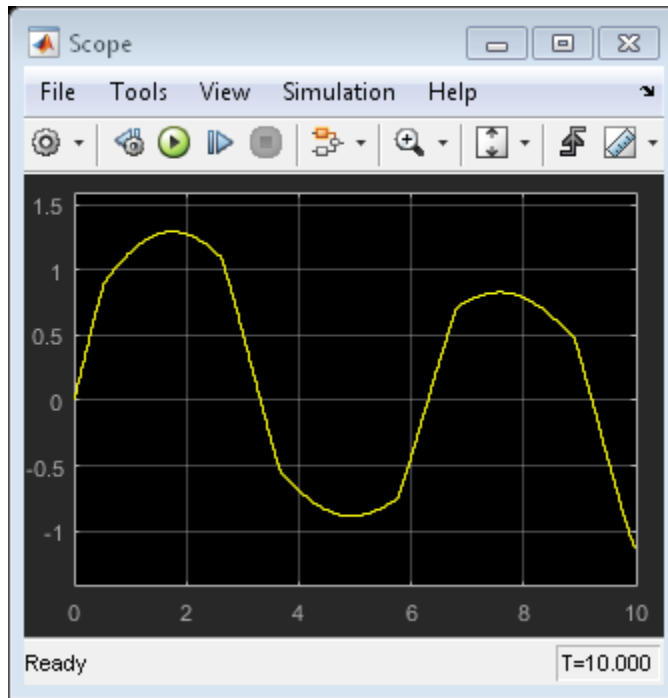

**Figure 3:** Simulation using the Linear Controller variant

To simulate using the Nonlinear Controller, define

`VSS_MODE=2`

in the base workspace and then simulate the model.



**Figure 4:** Simulation using the Nonlinear Controller variant

### Enumerations and Reuse

The `sldemo_variant_subsystems_enum` model illustrates the following `Simulink.Variant` capabilities:

1. **Enumerations:** MATLAB enumeration classes can be used to improve readability in the conditions of the variant object.
2. **Reuse:** `Simulink.Variant` objects can be reused in different Variant Subsystem blocks.

This example uses the following variables which are defined in the MATLAB base workspace:

```
VSSE_LINEAR_CONTROLLER=Simulink.Variant( ...
'VSSE_MODE==sldemo_vss_CONTROLLER_TYPE.LINEAR')
```

```
VSSE_NONLINEAR_CONTROLLER=Simulink.Variant( ...  
'VSSE_MODE==sldemo_vss_CONTROLLER_TYPE.NONLINEAR')  
  
VSSE_MODE=sldemo_vss_CONTROLLER_TYPE.LINEAR  
  
VSSE_PROTOTYPE=Simulink.Variant( ...  
'VSSE_MODE_BUILD==sldemo_vss_BUILD_TYPE.PROTOTYPE')  
  
VSSE_PRODUCTION=Simulink.Variant( ...  
'VSSE_MODE_BUILD==sldemo_vss_BUILD_TYPE.PRODUCTION')  
  
VSSE_MODE_BUILD=sldemo_vss_BUILD_TYPE.PRODUCTION
```

In these `Simulink.Variant` objects, we use the enumeration classes, `sldemo_vss_BUILD_TYPE.m`, and `sldemo_vss_CONTROLLER_TYPE.m` to define the `Simulink.Variant` **Condition** parameters which improves readability.

The three filter Variant Subsystems blocks, `Filter1`, `Filter2`, and `Filter3` all use the `VSSE_PROTOTYPE` and `VSSE_PRODUCTION` `Simulink.Variant` objects.

Opening the example model `sldemo_variant_subsystems_enum` runs the **PreLoadFcn** defined in `File -> ModelProperties -> Callbacks`. This populates the base workspace with variables for the Variant Subsystem blocks:

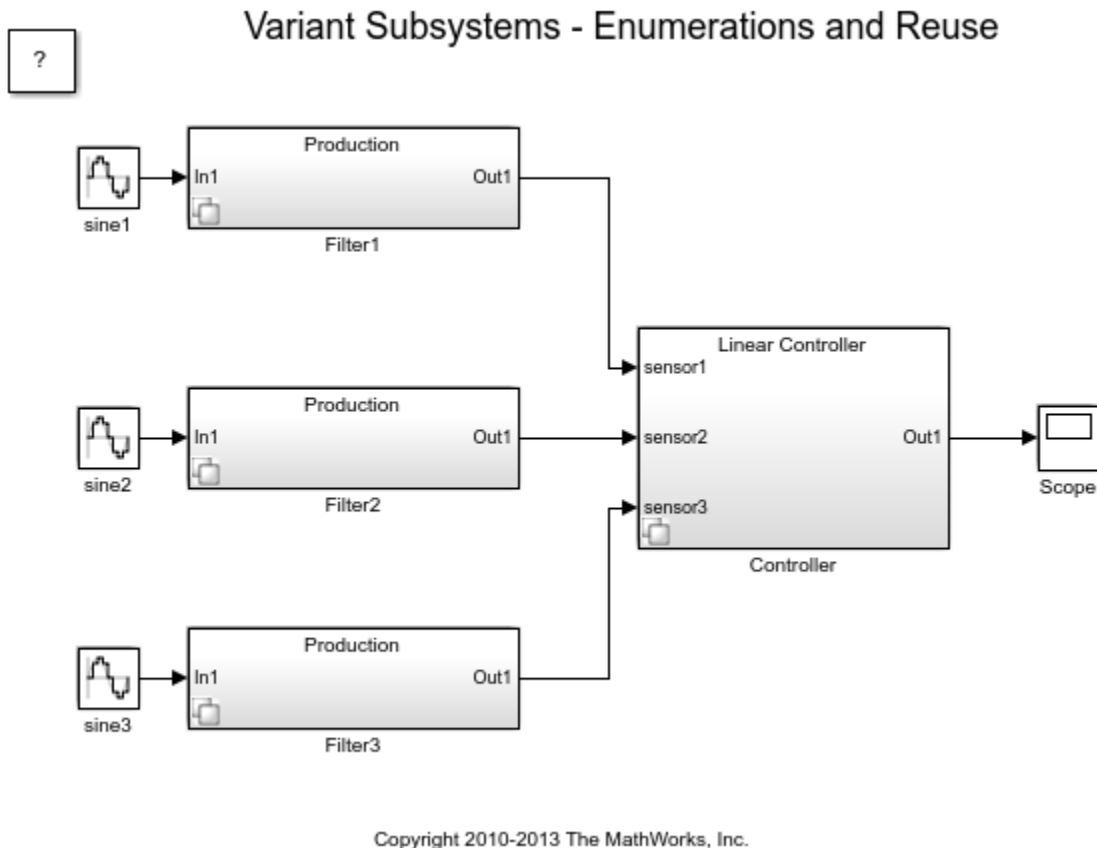

**Figure 5:** The example model, `sldemo_variant_subsystems_enum`

### Code Generation

You can use the Simulink® Coder™ to generate code from a model containing Variant Subsystem blocks. By default the generated code contains only the active variant. Alternatively, you can generate code for all variants guarded by C preprocessor conditionals (`#if`, `#elif`, `#endif`) when using the Embedded Coder™.

To generate preprocessor conditionals, the types of blocks that you can place within the child subsystems of a Variant Subsystem block are limited. During the code generation process, one Merge block is placed at the input of each Outport block within the variant

subsystem and connected to the child subsystems within the variant subsystem. Thus, the restrictions placed on Merge blocks apply to the contents of Variant Subsystem blocks. The restriction checks are only performed when generating code. In addition, the child subsystems of the Variant Subsystem block must be Atomic subsystems, which are created by selecting the **Treat as atomic unit** parameter of the Subsystem parameters dialog box.

Code generation of preprocessor conditionals is active when

- 1 Embedded Coder target is selected on the Code Generation pane of the Configuration Parameters dialog box.
- 2 The **Override variant conditions and use following variant** is *not* selected on the Variant Subsystem block parameter dialog box.

When code generation of preprocessor conditionals is active, the generated code contains all child subsystems of the Variant Subsystem blocks protected by C preprocessor conditionals. In this case, the selection of the active variants is deferred until compile-time of the generated code. Only one variant object which is encoded in C macros, must evaluate to true (be active).

In addition, the variant control variables (such as `VSS_MODE` and `VSSE_MODE` above) must be `Simulink.Parameter` objects that specify how the `#define`'s for the variant control variables are managed in the generated code. For the `sldemo_variant_subsystems`, you can clear the `VSS_MODE` double from the base workspace. Use Model Explorer -> Simulink Root -> Base Workspace to add a new `Simulink.Parameter` named `VSS_MODE`. Specify the parameter **Value** as 1 or 2, the **Data Type** as `int32`, and **Storage class** as `ImportedDefine (Custom)` with **Custom attributes Header file** as `sldemo_variant_subsystems_vdef.h`. You should then create this header in the current working directory:

```
/* File: sldemo_variant_subsystems_vdef.h */
#ifndef SLDEMO_VARIANT_SUBSYSTEM_VDEF_H
#define SLDEMO_VARIANT_SUBSYSTEM_VDEF_H
#define VSS_MODE 1
#endif
```

See the Embedded Coder documentation for more information on code generation for variant subsystems.

## Model Reference Variants

This example shows how to use model reference variants. A Model block is used to reference one Simulink® model from another Simulink model. A Model block can have different variants. A *variant* describes one of N possible modes a Model block can operate in. Each variant of the Model block references a specific model with optional model-specific arguments. Only one variant is active for simulation. You can switch the active variant of a Model block by changing the values of variables in the base workspace, or by manually overriding variant selection using the Model block dialog.

### Example Requirements

During this example, Simulink and Simulink® Coder™ may generate code in the code generation folder in current working directory. If you do not want to (or cannot) generate files in this directory, you should change the working directory to a suitable directory.

### Overview of Model Variants

A Model block is used to reference one Simulink model (the *child model*) from another Simulink model (the *parent model*). A Model block can have different variants. The variants comprise a set of models that have the potential to be referenced by the Model block. In this example, there are two models that are potentially referenced by the Model block named Controller.

Each *variant* in a Model block is associated with a `Simulink.Variant` object. `Simulink.Variant` objects are created in the MATLAB® base workspace. For example:

```
V_LINEAR_CONTROLLER=Simulink.Variant('CTRL==1');
```

where the constructor argument ('CTRL==1') defines the condition when the variant is active. In this case, defining:

```
CTRL=1
```

in the base workspace would activate the `V_LINEAR_CONTROLLER` variant. The condition argument can be a *simple expression* consisting of scalar variables, enumerations, equality, inequality, `&&`, `,` and `~`. Parenthesis `()` can be used for precedence grouping.

For a given Model block, one variant is active during simulation. The *active variant* is determined by evaluating the variant object conditions in the MATLAB base workspace. Alternatively, you can instruct the Model block to use a specific variant by selecting the **Override variant conditions and use following variant** checkbox.

## Specifying Variants for a Model Block

The model used in this example requires the following variables be defined in the MATLAB base workspace:

```
V_LINEAR_CONTROLLER=Simulink.Variant('CTRL==1');
```

```
V_NONLINEAR_CONTROLLER=Simulink.Variant('CTRL==2');
```

```
CTRL=2;
```

Opening the model `sldemo_mdref_variants` will run the **PreLoadFcn** defined in `File -> ModelProperties -> Callbacks`. This will populate the base workspace with the variables for the Model block named Controller:

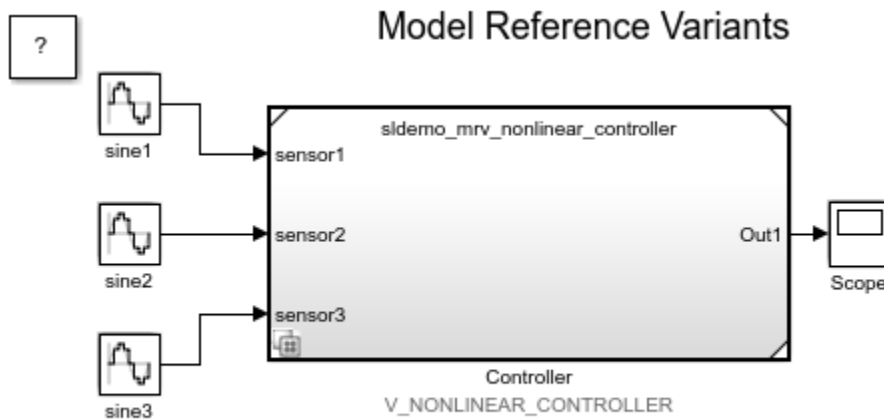

Copyright 2009-2014 The MathWorks, Inc.

**Figure 1:** The top model, `sldemo_mdref_variants`

Right-click the model block Controller and select the menu item **Block Parameters (ModelReference)** to open the Model block dialog.

The dialog specifies two potential variants. The two variants are in turn associated with the two `Simulink.Variant` objects `V_LINEAR_CONTROLLER` and `V_NONLINEAR_CONTROLLER`, which exist in the base workspace. These objects have



a property named **Condition**, an expression that evaluates to a boolean and that determines which variant is active. The **Condition** is also shown in the Model block dialog. In this example, the **Condition**'s of `V_LINEAR_CONTROLLER` and `V_NONLINEAR_CONTROLLER` are `CTRL == 1` and `CTRL == 2`, respectively. The variable `CTRL` resides in the base workspace, and may be a standard MATLAB variable or a `Simulink.Parameter`.

### Switching Active Variants

To simulate using the `sldemo_mrv_linear_controller`, define:

```
CTRL=1
```

in the base workspace and then simulate the model.

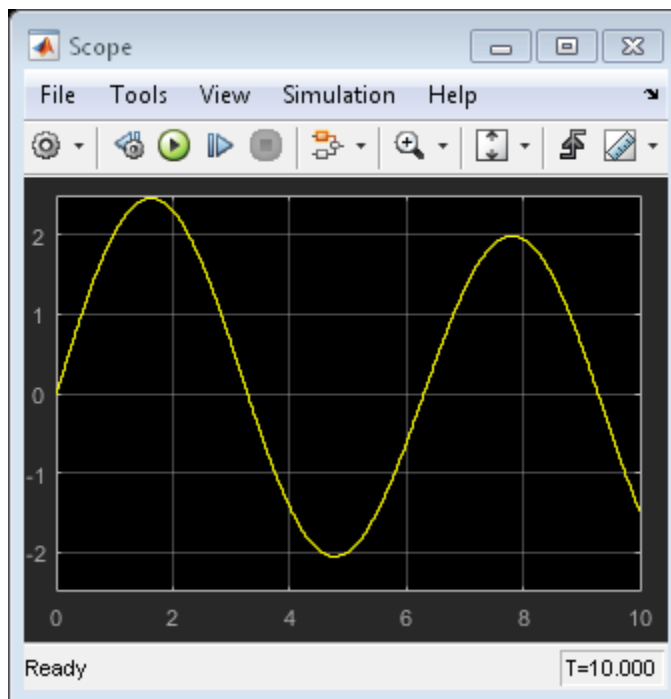
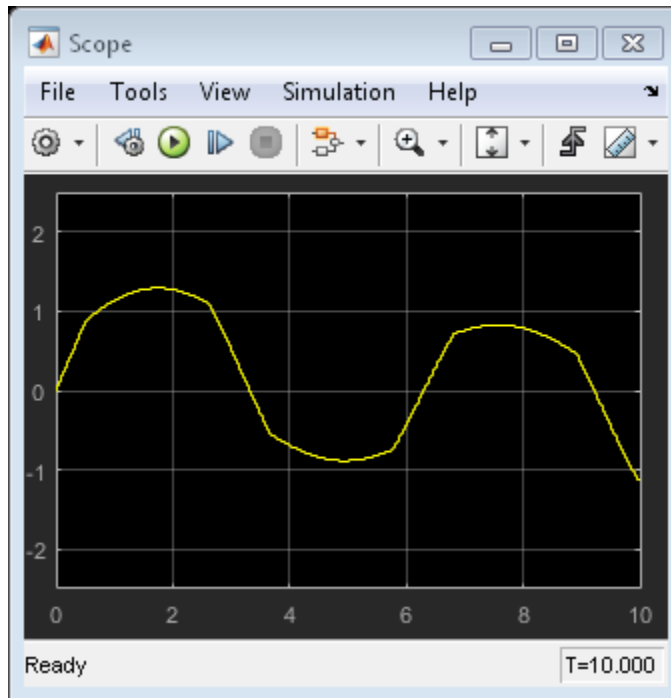

**Figure 2:** Simulation using the `sldemo_mrv_linear_controller` variant

To simulate using the `sldemo_nonlinear_controller`, define

CTRL=2

in the base workspace and then simulate the model.



**Figure 3:** Simulation using the `sldemo_mrv_nonlinear_controller` variant

### Enumerations and Reuse

The `sldemo_mdref_variants_enum` model illustrates `Simulink.Variant` capabilities:

1. **Enumerations:** MATLAB enumeration classes can be used to improve readability in the conditions of the variant object.
2. **Reuse:** `Simulink.Variant` objects can be reused in different Model blocks.

This example requires the following variables be defined in the MATLAB base workspace:

```
VE_LINEAR_CONTROLLER=Simulink.Variant('E_CTRL==sldemo_mrv_CONTROLLER_TYPE.LINEAR');
```

```
VE_NONLINEAR_CONTROLLER=Simulink.Variant('E_CTRL==sldemo_mrv_CONTROLLER_TYPE.N  
E_CTRL=sldemo_mrv_CONTROLLER_TYPE.LINEAR  
VE_PROTOTYPE=Simulink.Variant('E_CURRENT_BUILD==sldemo_mrv_BUILD_TYPE.PROTOTYP  
VE_PRODUCTION=Simulink.Variant('E_CURRENT_BUILD==sldemo_mrv_BUILD_TYPE.PRODUCT  
E_CURRENT_BUILD=sldemo_mrv_BUILD_TYPE.PRODUCTION
```

In these `Simulink.Variant`'s, we use the enumeration classes, `sldemo_mrv_BUILD_TYPE.m`, and `sldemo_mrv_CONTROLLER_TYPE.m` within the `Simulink.Variant` **Condition** properties to improve readability.

The `VE_PROTOTYPE` and `VE_PRODUCTION` `Simulink.Variant` objects are reused across the three filter Model blocks, `Filter1`, `Filter2`, and `Filter3`.

Opening the model `sldemo_mdref_variants_enum` will run the **PreLoadFcn** defined in `File -> ModelProperties -> Callbacks`. This will populate the base workspace with variables for the Model blocks, which are displayed in the MATLAB Command Window:

## Variant Source and Variant Sink Blocks

Define variant choice regions in the Variant Source and Sink blocks based on the block connectivity. The variant choice regions are computed by Simulink when you update diagram (**Simulation > Update Diagram**).

The process of computing the variant choice regions is called **variant condition propagation**. The Variant Source block provides variation on the source of a signal, and the Variant Sink blocks provides variation on the destination (sink) of a signal.

Consider a model containing two Variant Source blocks (**Variant Source1**, **Variant Source2**) and a Sink block (**Variant Sink**).

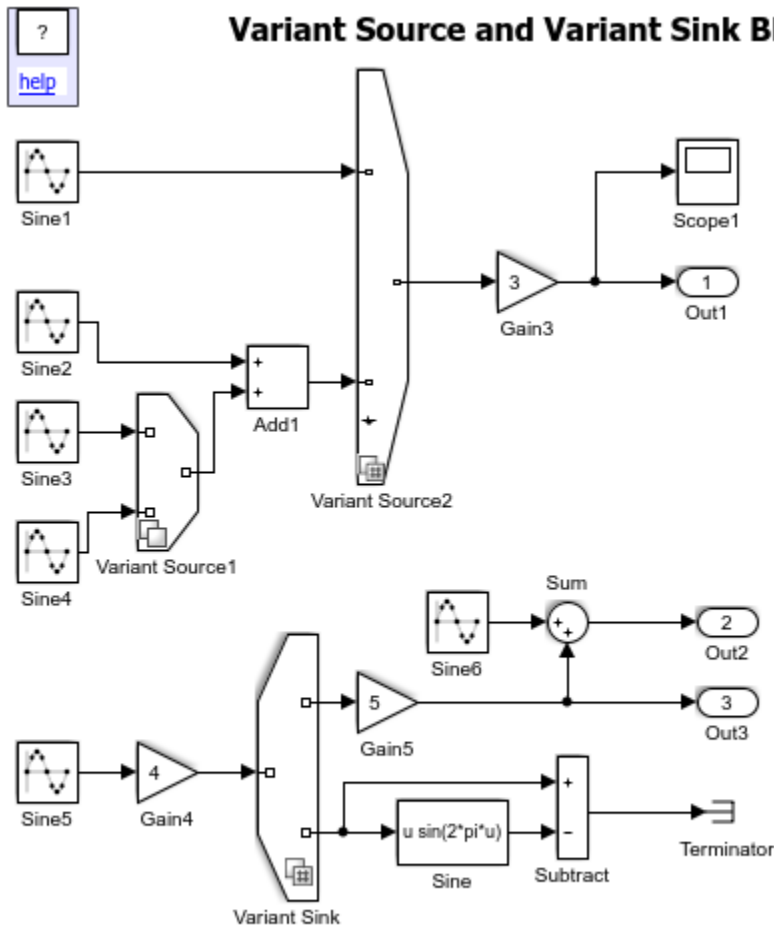

Copyright 2016 The MathWorks, Inc.

The variant conditions at the inports and outports of Variant Source and Sink blocks, respectively, determine the activation and deactivation of the blocks connected to them. To view the annotations and the variant conditions, click **Display > Blocks > Variant Conditions**.

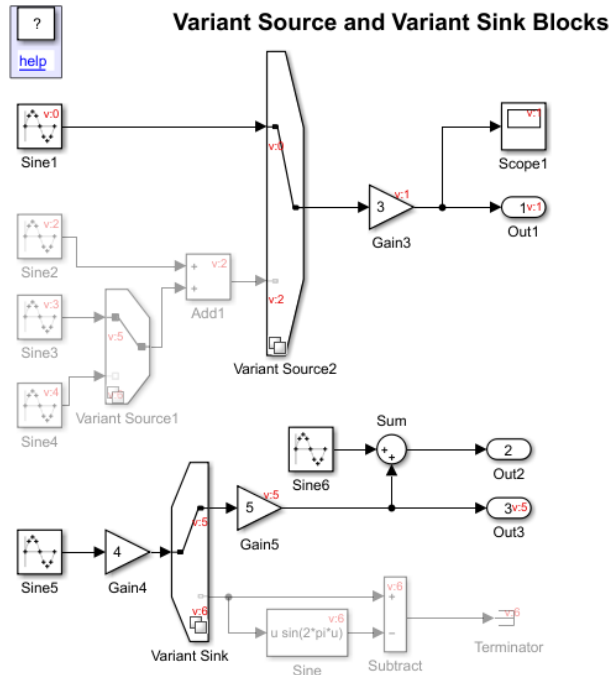
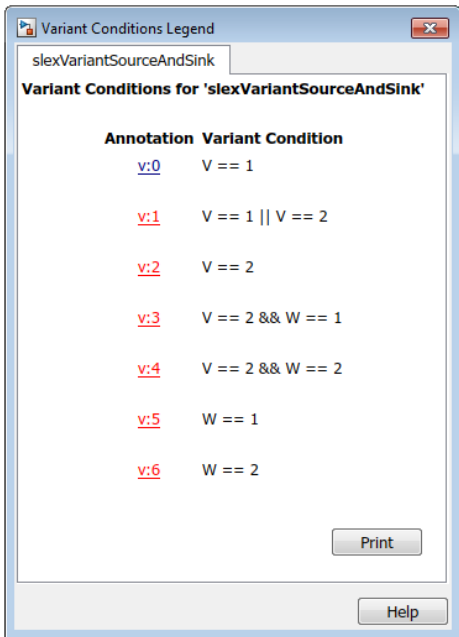

Let's analyze the variant conditions and the block activation state.

- In **Variant Source1**, when  $W==1$ , the **Sine3** block is active, and when  $W==2$ , the **Sine4** block is active.
- In **Variant Source2**, when  $V==1$ , the **Sine1** block is active, and when  $V==2$ , the **Add1** block is active.
- At **Add1** block the condition propagation continues making **Variant Source1** block to be active only when the  $V==2$ . This further propagates to **Sine3** block and **Sine4** block, making the **Sine3** block active at  $V==2 \ \&\& \ W==1$  and the **Sine4** block active at  $V==2 \ \&\& \ W==2$ , respectively.
- The **Gain3** block is active when either  $V==1$  or  $V==2$ , and hence the condition  $V==2 \ || \ V==1$ . The variant condition is further propagated to **Scope1** and **Out1**.
- The blocks connected to the outport of **Variant Sink** are active when  $W==1$  (**Gain5**), or  $W==2$  (**Sine**, **Subtract**, **Terminator**).
- The **Sum** block illustrates two key concepts in variant condition propagation: Signals are only variant if explicitly marked or when all paths can be proven to be variant.

To make the `Sine6`, `Sum`, `Out2` variant, place a Single-Input Single-Output Variant Source before `Out2` (or after the `Sine6`). Reading an inactive signal is equivalent to reading ground. When  $W \neq 1$ , then the bottom input to the `Sum` block is inactive and  $\text{Out2} = \text{Sine6} + \text{ground}$ .

If you select the **Analyze all choices during update diagram and generate preprocessor conditionals** parameter for the Variant Source and Variant Sink block, the generated code contains the code for the active and the inactive (`#if COND`). If this parameter is not selected, then code is generated only for the active choices.

If you select the **Allow zero active variant controls** parameter for the Variant Source and Variant Sink block, you can simulate the variant model without an active variant. In such cases, Simulink disables the blocks connected to the input and output stream of Variant Source and Variant Sink. These disabled blocks are ignored from update diagram or simulation.

### More About

- “Define and Configure Variant Sources and Sinks”

### Control Variant Condition Propagation

During variant condition propagation, Simulink automatically assigns conditions to blocks. You can control how the variant condition propagates upstream and downstream in a model.

Consider this model.





## Controlling and Stopping Variant Condition Propagation

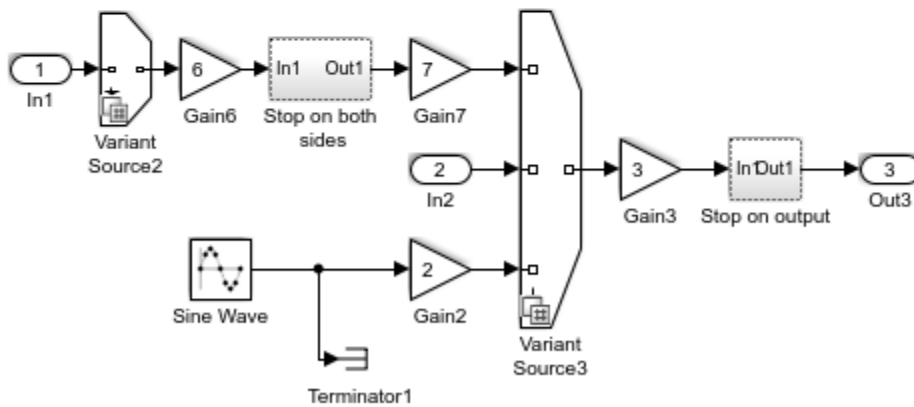
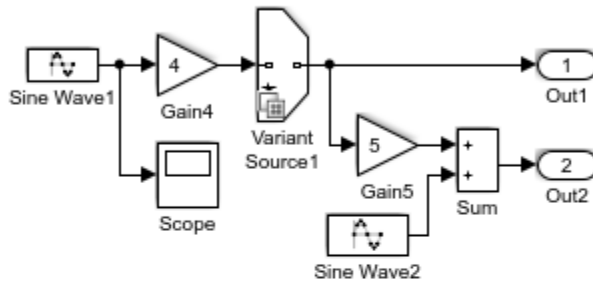

Copyright 2016 The MathWorks, Inc.

In Simulink, click **Simulation** > **Run** to view the variant condition propagation to blocks.

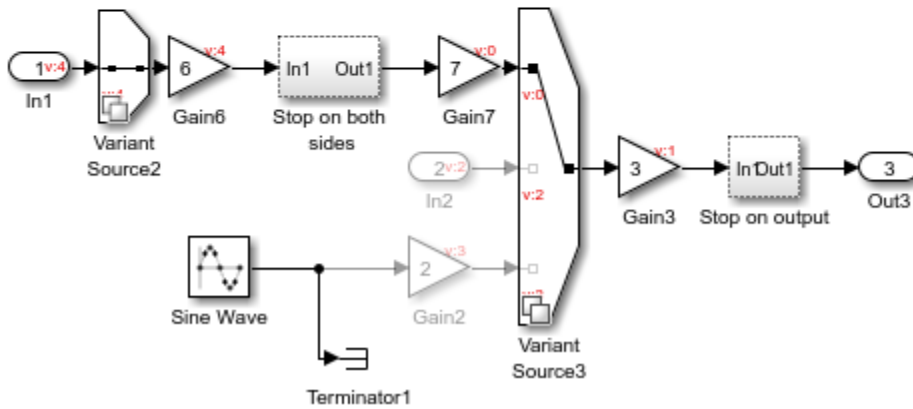
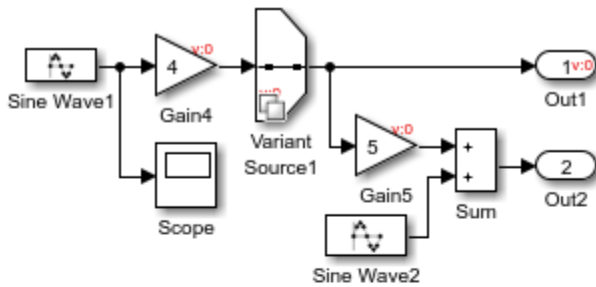

The **Variant Source1** block has the  $A==1$  condition, which propagates backward and forward to the blocks connected to **Variant Source1** block. The variant condition propagates to **Gain4** block but does not propagate to the **Sine Wave1** block.

The **Scope** block is unconditional and receives its inputs from the **Sine Wave1** block. Therefore, the **Sine Wave1** block is unconditional. If you remove the **Scope** block, the variant condition propagates to the **Sine Wave1** block.

If you replace the **Scope** block with any other block (including the **Terminator** block), the **Sine Wave1** block remains unconditional.

A block is unconditional if at least one of its inputs is unconditional. The input side of the **Sum** block is connected to **Gain5** (conditional) block and to the **Sine Wave2** (unconditional) block. Therefore, the **Sum** block is unconditional.

You can use these concepts to create a Subsystem block that controls the propagation of variant conditions to both sides or to one side.

### Stop Propagation of Variant Condition Upstream and Downstream

Consider the section of the model that is connected to the Variant Source2 and Variant Source3 blocks. When you simulate the model, the Variant condition from the Variant Source2 block and the Variant Source3 blocks propagates upstream and downstream.

The Stop on both sides block between Gain6 and the Gain7 block, prevents the Variant condition from propagating upstream or downstream. Double-click the Stop on both sides block to view its components.

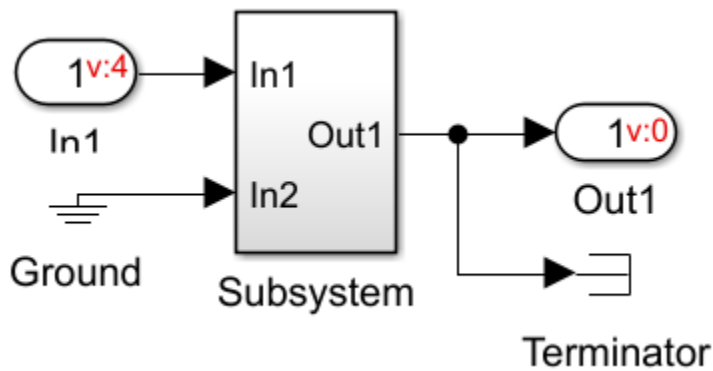

The Stop on both sides block uses a Terminator to stop the variant condition propagation on upstream of the Subsystem block. To stop the condition propagation on the downstream side of the Subsystem block, one of the inports is connected to Ground (unconditional). Therefore, this arrangement stops the variant condition propagation upstream and downstream. Similarly, you can selectively stop the condition propagation of variant condition at upstream or downstream for a model. For example, if you remove the Terminator block, variant condition propagated upstream but is stopped downstream.

## Stop Propagation of Variant Condition Downstream

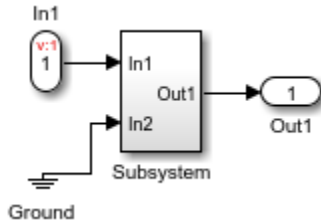

Here, one input port of the Subsystem block is unconditional making the Subsystem block unconditional at input side and thus stopping the propagation of variant condition downstream.

### More About

- “Define and Configure Variant Sources and Sinks”

## Propagate Variant Condition to Conditional Subsystem

A conditional subsystem (also known as a conditionally executed subsystem) is a type of subsystem where you can control the execution using an external signal.

Enabled, Triggered, and Function-Call Subsystems are examples of conditional subsystems. The signal that controls a conditional subsystem is called the *control signal* and the port from which the signal enters the block is called the *control port*. For more information on conditional subsystems, see “Conditional Subsystems”.

You can use a Variant block to control the execution of a conditional subsystem blocks.

Consider this model.



### Variant Condition Propagation to Conditionally Executed Subsystems

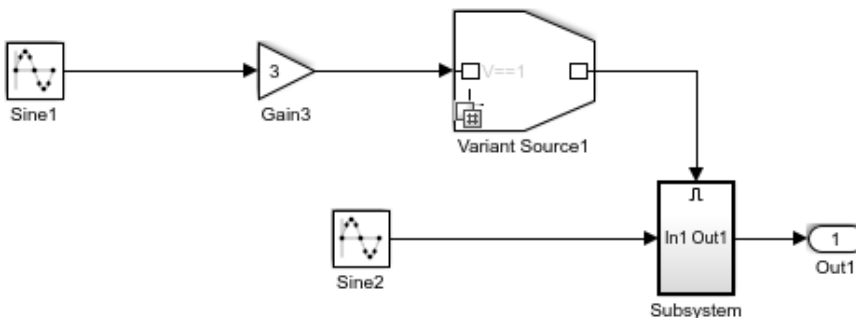

Copyright 2016 The MathWorks, Inc.

Variant Source1 is a single-input/single-output Variant Source block with variant condition as  $V==1$ . When you simulate this model, the variant condition from the Variant Source1 block propagates to the control port of the Subsystem block and then to the blocks connected to its inports and outports.

For example, when  $V=1$ , Variant Source1 is active and the Variant condition propagates to the control port of the Subsystem block. Therefore, the Subsystem block

is also active and the variant condition propagates to the blocks connected to the input and output ports of the Subsystem block.

### Propagate Variant Condition to Function-Call Subsystem

A Function-Call Subsystem block is a subsystem that another block can invoke directly during simulation. The Function-Call Subsystem block is analogous to a function in procedural programming language. For more information, see “Function-Call Subsystems”.

You can use a single-input/single-output variant block to make the Function-Call Subsystem block conditional.

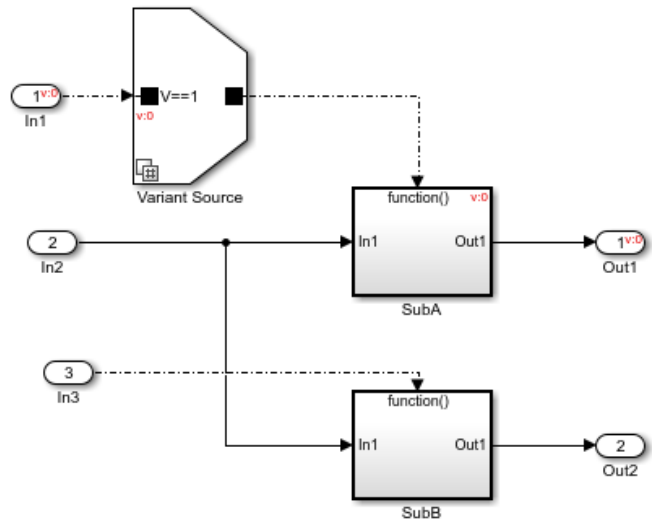
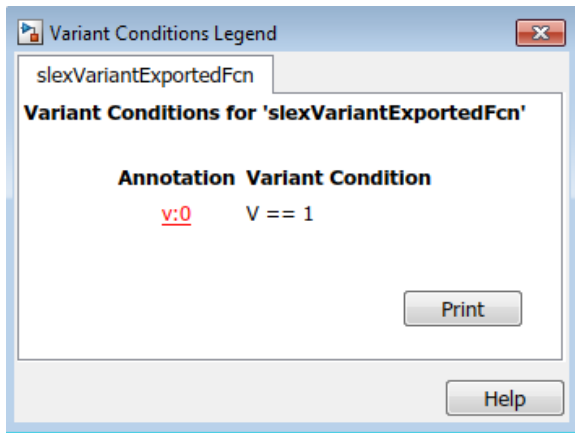

The Variant Source block has condition  $V==1$ , where  $V$  is a `Simulink.Parameter`.

When you simulate this model, the variant condition from the Variant Source block propagates to the control port of the SubA subsystem block and further propagates to the blocks connected to its inports and outports.

For example, when  $V=1$ , the SubA block is active and the variant condition propagates backward and forward to the blocks connected to the input (In1) and output (Out1) ports.

When  $V \neq 1$  (for example,  $V=0$ ), SubA becomes inactive, making Out1 to be inactive. In2 remains active as it is connected to SubB, which is active.

If In2 is not connected to SubB, In2 becomes inactive when  $V \neq 1$ .

**Note:** If the **Function-Call Subsystem** is placed inside a virtual grouped subsystem, the variant condition triggering the **Function-Call Subsystem** must match the corresponding condition on the input of the higher level subsystem block.

### **More About**

- “Define and Configure Variant Sources and Sinks”





# Exploring, Searching, and Browsing Models

---

- “Search and Edit Using Model Explorer” on page 12-2
- “Customize Model Explorer Views” on page 12-39
- “Find Model Elements in Simulink Models” on page 12-48
- “Model Dependency Viewer” on page 12-56
- “View Linked Requirements in Models and Blocks” on page 12-61
- “Trace Connections Using Interface Display” on page 12-69

## Search and Edit Using Model Explorer

### In this section...

“What You Can Do Using the Model Explorer” on page 12-2

“Open the Model Explorer and Edit Object Properties” on page 12-3

“Search Bar Controls” on page 12-3

“Model Explorer Components” on page 12-6

“Add Objects to a Model, Chart, or Workspace” on page 12-8

“Focus on Specific Elements of a Model or Chart” on page 12-9

“Model Explorer: Model Hierarchy Pane” on page 12-10

“Model Explorer: Contents Pane” on page 12-18

“Organize Data Display in Model Explorer” on page 12-23

“Filter Objects in the Model Explorer” on page 12-31

“Model Explorer: Property Dialog Pane” on page 12-36

### What You Can Do Using the Model Explorer

Use the Model Explorer to view, modify, and add elements of Simulink models, Stateflow charts, and workspace variables. The Model Explorer lets you focus on specific elements (for example, blocks, signals, and properties) without navigating through the model or chart.

Use the Model Explorer to search for:

- Variables in workspaces and data dictionaries
- Variable usage in a model
- Instances of a type of block
- Block parameters and parameter values

You can combine search criteria and iteratively refine the results. Search in Model Explorer for model elements, starting with the node you select in the model hierarchy. You can search the entire model, in a particular system, or in a system and all the systems below it in the hierarchy. For details on the options, see “Search Bar Controls” on page 12-3.

For an example showing how to search for a parameter, see “Search Using Model Explorer” on page 12-52.

Using your search results, you can apply changes to multiple elements at once.

To create, modify, and view the entries in a data dictionary, use the Model Explorer. See “Edit and Manage Workspace Variables Used by Models” on page 57-92 and “View and Revert Changes to Dictionary Data” on page 61-27.

## Open the Model Explorer and Edit Object Properties

To open the Model Explorer, use one of these approaches:

- From the Simulink Editor **View** menu, select **Model Explorer** or select the Model Explorer icon  from the toolbar.
- In an open model in the Simulink Editor, right-click a block and from the context menu, select **Explore**.
- In an open Stateflow chart, right-click in the drawing area and from the context menu, select **Explore**.
- At the MATLAB command line, enter `daexplr`.

Use this workflow to view and edit object properties:

- 1 To specify whether to display only the current system or the whole system hierarchy, select the model in the **Model Hierarchy** pane.
- 2 Control the model information the **Contents** pane displays:
  - Control which property columns to display using the **View > Column View** option.
  - Control which types of objects to display using the **View > Row Filter** option.
  - Directly manipulate column headings
- 3 Identify model elements with specific values using the search bar.
- 4 Edit the values for model elements, in either the **Contents** pane or the **Dialog** pane. To edit workspace variables, you can use the Variable Editor.

## Search Bar Controls

The search bar includes these controls:

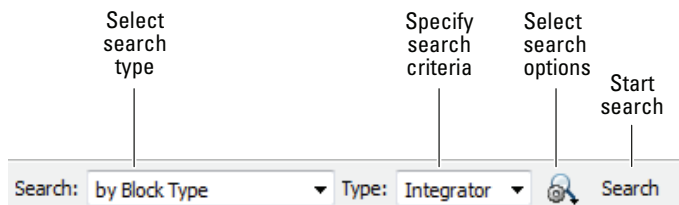

## Search Type

Use the **Search Type** control to specify the type of objects or properties to include in the search.

Search Type Option	Description
by Name	Searches a model or chart for all objects that have the specified string in the name of the object. See “Search Strings” on page 12-6.
by Property Name	Searches for objects that have a specified property. Specify the target property name from a list of properties that objects in the search domain can have.
by Property Value	Searches for objects with a property value that matches the value you specify. Specify the name of the property, the value to be matched, and the type of match (for example, equals, less than, or greater than). See “Search Strings” on page 12-6.
by Block Type	Searches for blocks of a specified block type. Select the target block type from the list of types contained in the currently selected model.
by Stateflow Type	Searches for Stateflow objects of a specified type.
for Variable Usage	Searches for blocks that use variables defined in a workspace. Select the base workspace or a model workspace (model name) and, optionally, the name of a variable. See “Search Strings” on page 12-6.
for Referenced Variables	Searches for variables that a model or block uses. Specify the name of the model or block in the <b>by System</b> field. The model or block must be in the <b>Model Hierarchy</b> pane.

Search Type Option	Description
for Unused Variables	Searches for variables that are defined in a workspace but not used by any model or block. Select the name of the workspace from the drop-down list for the <b>in Workspace</b> field.
for Library Links	Searches for library links in the current model.
by Class	Searches for Simulink objects of a specified class.
for Fixed Point Capable	Searches a model for all blocks that support fixed-point computations.
for Model References	Searches a model for references to other models.
by Dialog Prompt	Searches a model for all objects whose dialogs contain the prompt you specify. See “Search Strings” on page 12-6.
by String	Searches a model for all objects in which the string you specify occurs. See “Search Strings” on page 12-6.

### Search Options

Use the **Search Options** control to specify the scope and how to apply search strings.

Search Option	Description
<b>Match Whole String</b>	Do not allow partial string matches (for example, do not allow <b>sub</b> to match <b>substring</b> ).
<b>Match Case</b>	Considers case when matching strings (for example, <b>Gain</b> does not match <b>gain</b> ).
<b>Regular Expression</b>	Considers a string to be matched as a regular expression.
<b>Evaluate Property Values During Search</b>	Applies only for searches by property value. If enabled, Model Explorer evaluates the value of each property as a MATLAB expression and compares the result to the search value. If this option is disabled (the default), the Model Explorer compares the

Search Option	Description
	unevaluated property value to the search value.
<b>Refine Search</b>	Initiates a secondary search that provides additional search criteria to refine the initial search results. The second search operation searches for objects that meet both the original and the new search criteria.

For an example showing how to search for a parameter, see “Search Using Model Explorer” on page 12-52.

### Search Strings

By default, search strings are case-insensitive and are treated as regular expressions.

By default, the search allows partial string matches. You cannot use wildcard characters in search strings. For example, if you enter \*1 as a name search string, you get no search results unless there is an item whose name starts with the two characters \*1. If there is an out1 item, the search results do not include that item.

### Model Explorer Components

By default, the Model Explorer opens with three panes (**Model Hierarchy**, **Contents**, and **Dialog**), a main toolbar, and a search bar.

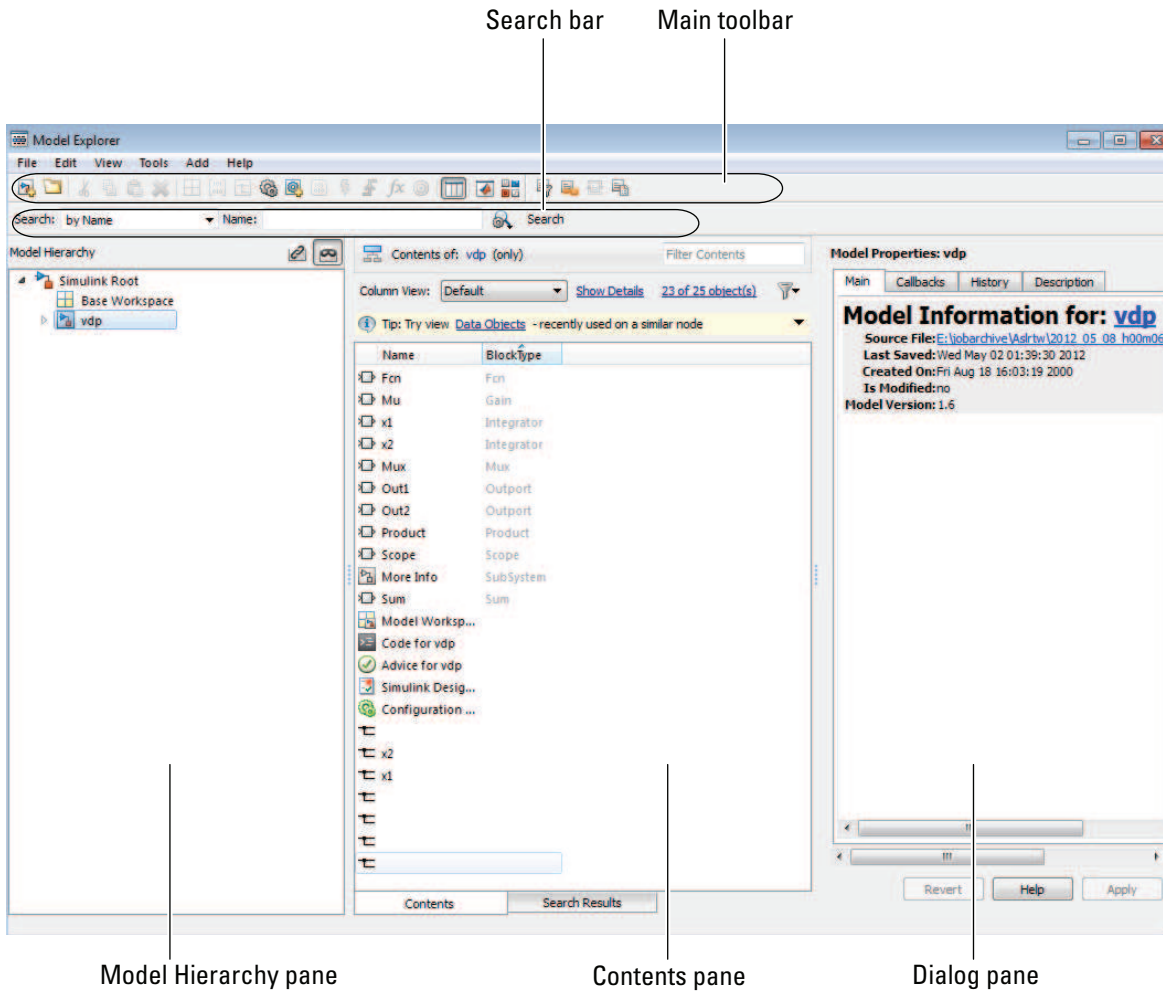

Component	Purpose	Documentation
Main toolbar	Execute Model Explorer commands	Most toolbar buttons perform actions that you can also perform using Model Explorer menu items, except to bring MATLAB to the front or open the Simulink Library Browser.

Component	Purpose	Documentation
		If you have Simulink Verification and Validation installed, you can use additional toolbar buttons relating to requirements links.
Search bar	Perform a search within the context of the selected node in <b>Model Hierarchy</b> pane.	“Search Bar Controls” on page 12-3
<b>Model Hierarchy</b> pane	Navigate and explore model, chart, and workspace nodes	“Model Explorer: Model Hierarchy Pane” on page 12-10
<b>Contents</b> pane	Display and modify model or chart objects	“Model Explorer: Contents Pane” on page 12-18
<b>Dialog</b> pane	View and change the details of object properties	“Model Explorer: Property Dialog Pane” on page 12-36

## Add Objects to a Model, Chart, or Workspace

You can use the Model Explorer to add many kinds of objects to a model, chart, or workspace. The types of objects that you can add depend on the node you select in the **Model Hierarchy** pane. Use toolbar buttons or the **Add** menu to add objects. The **Add** menu lists the types of objects you can add.



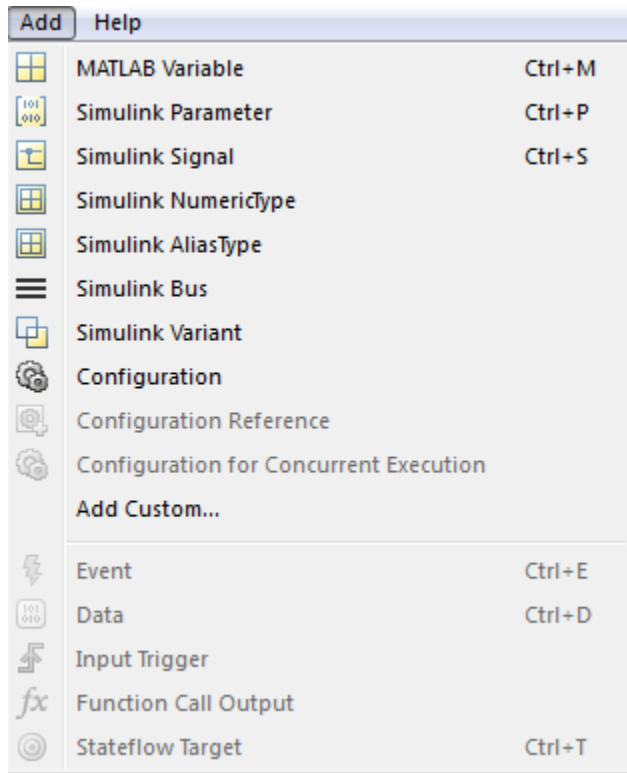

## Focus on Specific Elements of a Model or Chart

As you explore a model or chart, you might want to narrow the contents that you see in the Model Explorer to particular elements of a model or chart. You can use several different techniques. The table summarizes techniques for controlling the content the Model Explorer displays and how the contents appear.

Technique	When to Use	Documentation
Show partial or whole model hierarchy contents	To control how much of a hierarchical model to display	“Display Partial or Whole Model Hierarchy Contents” on page 12-12
Use the Row Filter option	To focus on, or hide, a specific kind of a model object, such as signals	“Use the Row Filter Option” on page 12-31

Technique	When to Use	Documentation
Search	To find objects that might not be currently displayed	“Search Using Model Explorer” on page 12-52
Filter contents	To focus on specific objects in the <b>Contents</b> pane, based on a search string	“Filtering Contents” on page 12-34

Once you have the general set of data that you are interested in, you can use the following techniques to organize the display of contents.

Technique	When to Use	Documentation
Sort	To quickly organize data for a property in ascending or descending order	“Sort Column Contents” on page 12-23
Group by property column	To logically group data based on values for a property	“How to Group by a Property Column” on page 12-25
Use column views	To display a named subset of property columns to apply to different kinds of nodes in the <b>Model Hierarchy</b> pane	“Customize Model Explorer Views” on page 12-39
Add, delete, or rearrange property table columns	To customize property columns	“Organize Data Display in Model Explorer” on page 12-23

### Model Explorer: Model Hierarchy Pane

- “Simulink Root” on page 12-11
- “Base Workspace” on page 12-11
- “Work With Model Workspace Variables and Configuration Sets” on page 12-12
- “Display Partial or Whole Model Hierarchy Contents” on page 12-12
- “Display Linked Library Subsystems and Masked Subsystems” on page 12-14
- “Navigating to the Block Diagram” on page 12-14
- “Expand and Edit Model References” on page 12-15
- “Cut, Copy, and Past Objects Between Workspaces” on page 12-17

The **Model Hierarchy** pane displays a tree-structured view of the Simulink model and Stateflow chart hierarchy. Use the **Model Hierarchy** pane to navigate to the part of the model and chart hierarchy that you want to explore.

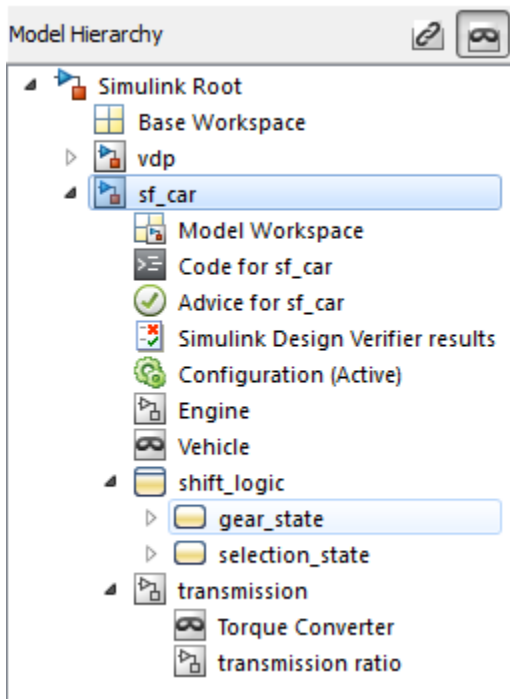

Select the object in the **Model Hierarchy** pane whose contents you want to display in the **Contents** pane.

### Simulink Root

The first node in the hierarchy represents the Simulink root. Expand the root node to display nodes representing the MATLAB workspace, Simulink models, and Stateflow charts that are in the current session.

### Base Workspace

This node represents the MATLAB workspace. The MATLAB workspace is the base workspace for Simulink models and Stateflow charts. Variables defined in this workspace are visible to all open models and charts.

For information about exporting and importing workspace variables, see “Export Workspace Variables” on page 57-102 and “Importing Workspace Variables” on page 57-104.

### Work With Model Workspace Variables and Configuration Sets

Expanding a model or chart node in the **Model Hierarchy** pane displays nodes representing the following elements, as applicable for the models and charts you have open.

Node	Description
Model workspace	For information about how to use the Model Explorer to work with model workspace variables, see the following sections: <ul style="list-style-type: none"> <li>• “Finding Variables That Are Used by a Model or Block” on page 57-92</li> <li>• “Finding Blocks That Use a Specific Variable” on page 57-95</li> <li>• “Editing Workspace Variables” on page 57-98</li> <li>• “Export Workspace Variables” on page 57-102</li> <li>• “Importing Workspace Variables” on page 57-104</li> <li>• “Model Workspaces” on page 57-106</li> </ul>
Configuration sets	For information about adding, deleting, saving, and moving configuration sets, see “Manage a Configuration Set” on page 13-11.
Top-level subsystems	Expand a node representing a subsystem to display underlying subsystems, if any.
Model blocks	Expand model blocks to show contents of referenced models (see “Expand and Edit Model References” on page 12-15).
Stateflow charts	<ul style="list-style-type: none"> <li>• Expand a node representing a Stateflow chart to display the top-level states of the chart.</li> <li>• Expand a node representing a state to display its substates.</li> </ul>

### Display Partial or Whole Model Hierarchy Contents

By default, the Model Explorer displays objects for the system that you select in the **Model Hierarchy** pane. It does not display data for child systems. You can override

that default, so that the Model Explorer displays objects for the whole hierarchy of the currently selected system. To toggle between displaying only the current system and displaying the whole system hierarchy of the current system, use one of these techniques:

- Select **View > Show Current System and Below**.
- Click the **Show Current System and Below** button () at the top of the **Contents** pane.

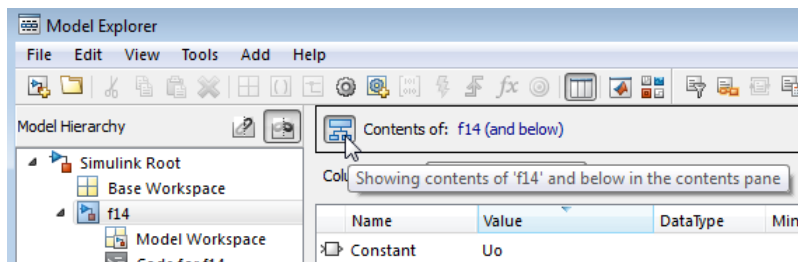

When you select the **Show Current System and Below** option:

- The **Model Hierarchy** pane highlights in pale blue the current system and its child systems.
- After the path in the **Contents of** field, the text (and below) appears.
- The appearance of the **Show Current System and Below** button at the top of the **Contents** pane and in the **View** menu changes.
- The status bar indicates the scope of the displayed objects when you hover over the **Show Current System and Below** button.

Loading very large models for the current system and below can be slow. To stop the loading process at any time, either click the **Show Current System and Below** button or click another node in the tree hierarchy.

If you show the current system and below, you might want to change the view to better reflect the displayed system contents. For details about views, see “Customize Model Explorer Views” on page 12-39.

The setting for the **Show Current System and Below** option is persistent across Simulink sessions.

### Display Linked Library Subsystems and Masked Subsystems

By default, the Model Explorer does not display the contents of linked library subsystems or masked subsystems in the **Model Hierarchy** pane. To display the contents of linked library subsystems, use one of these approaches:

- At the top of the **Model Hierarchy** pane, click the **Show/Hide Library Links** button (🔗) or the **Show/Hide Masked Subsystems** button (🔒).
- From the **View** menu, select **Show Library Links** or **Show Masked Subsystems**.

Library-linked subsystems and masked subsystems are visible in the **Contents** pane, regardless of how you configure the **Model Hierarchy** pane.

---

**Note:** Search does not find elements in linked library or masked subsystems that are not displayed in the **Model Hierarchy** pane.

---

For subsystems that are both library-linked and masked, how you set the linked library subsystems and masked subsystems options affects which subsystems appear in the **Model Hierarchy** pane, as described in the following table.

Settings	Subsystems Displayed in the Model Hierarchy Pane
Show Library Links	Only library-linked, unmasked subsystems
Hide Masked Subsystems	
Hide Library Links	Only masked subsystems that are not library-linked subsystems
Show Masked Subsystems	
Show Library Links	All library-linked or masked subsystems
Show Masked Subsystems	

### Navigating to the Block Diagram

To open a graphical object (for example, a model, subsystem, or chart) in an editor window, right-click the object in the **Model Hierarchy** pane. From the context menu, select **Open**.

## Expand and Edit Model References

To browse a model that includes Model blocks, you can expand the **Model Hierarchy** pane nodes of the Model blocks. For example, the `sldemo_md1ref_depgraph` model includes Model blocks that reference other models. If you open the `sldemo_md1ref_depgraph` model and expand that model node in the **Model Hierarchy** pane, you see that the model contains several Model blocks, including `heat2cost`.

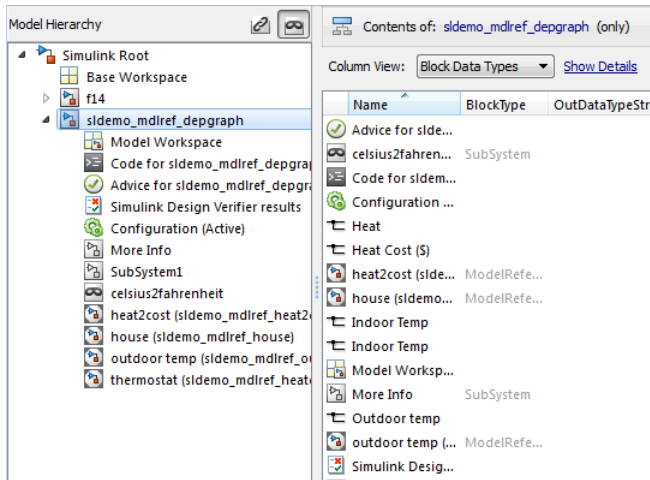

To browse a model referenced by a Model block:

- 1 Right-click the referenced model node in the **Model Hierarchy** pane.
- 2 From the context menu, choose **Open Model**.
  - The referenced model opens.
  - The **Model Hierarchy** pane indicates that you can expand the Model block node.
  - The **Model Hierarchy** pane displays a separate expandable node for the referenced model (read-only).
  - The **Contents** pane displays objects corresponding to the Model block node (read-only).

For example, if you right-click the `heat2cost` Model block node and select the **Open Model** option, the **Contents** pane displays the objects corresponding to the `heat2cost` Model block. You can expand the `heat2cost` node.

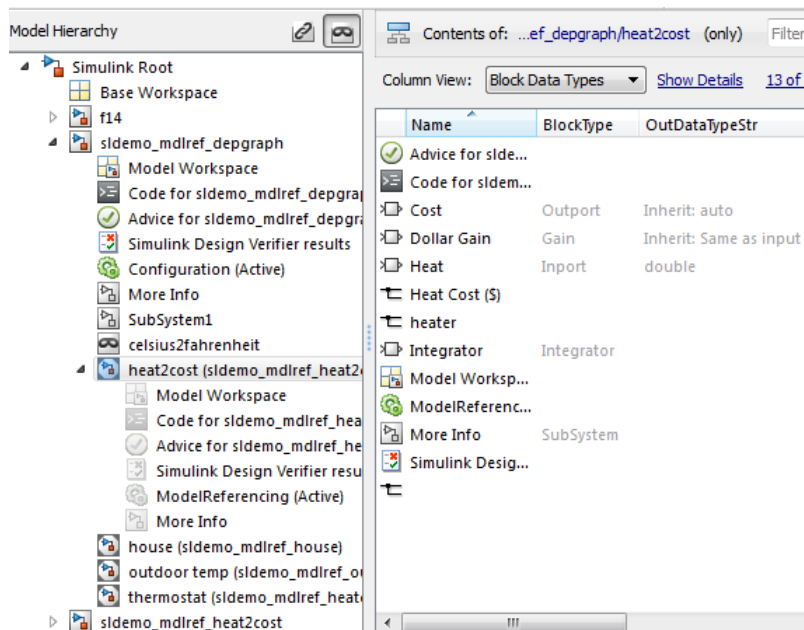

You can browse the contents of the referenced model, but you cannot edit the model objects that are underneath the Model block.

To edit the referenced model, expand the referenced model node in the **Model Hierarchy** pane, then you can edit the properties of objects in the referenced model. For example, expand the `sldemo_md1ref_heat2cost` node:



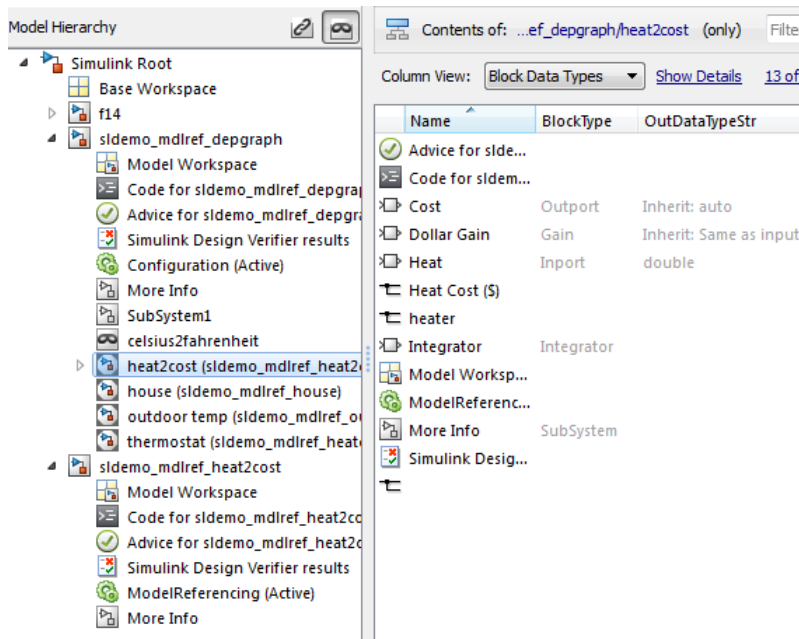



For information about referenced models, see “Model Referencing”.

### Cut, Copy, and Past Objects Between Workspaces

To cut, copy, and paste workspace objects from one workspace into another workspace:

- 1 In the **Contents** pane, right-click on the workspace object you want to cut or copy.
- 2 From the context menu, select **Cut** or **Copy**.
  - You can also cut a workspace object by selecting in the **Contents** pane **Edit** > **Cut** or by clicking the **Cut** button ()
  - You can also copy a workspace object by selecting **Edit** > **Copy** or by clicking the **Copy** button ()
- 3 If you want to paste the workspace object that you cut or copied, in the **Model Hierarchy** pane, right-click the workspace into which you want to paste the object, and select **Paste**.

- You can also paste the object by selecting **Edit > Paste** or by clicking the **Paste** button ()

You can also perform cut, copy, and paste operations by selecting an object and performing drag and drop operations.

### Model Explorer: Contents Pane

- “Contents Pane Tabs” on page 12-18
- “Data Displayed in the Contents Pane” on page 12-20
- “Link to the Currently Selected Node” on page 12-21
- “Working with the Contents Pane” on page 12-21
- “Editing Object Properties” on page 12-22

#### Contents Pane Tabs

The **Contents** pane displays one of two tables containing information about models and charts, depending on the tab that you select:

- The **Contents** tab displays an object property table for the node that you select in the **Model Hierarchy** pane.
- The **Search Results** tab displays the search results table (see “Search Using Model Explorer” on page 12-52).

Optionally, you can also open a column view details section in the **Contents** pane. The following graphic shows the **Contents** pane with the column view details section opened.

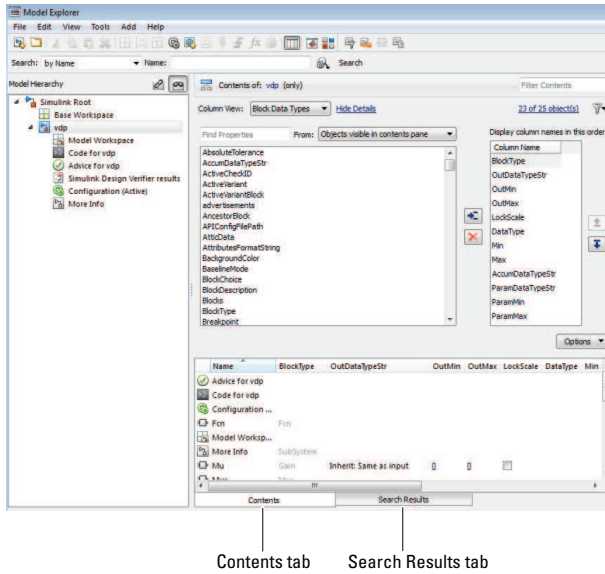

To open the column view details section, click **Show Details**, at the top of the **Contents** pane.

Column View Details section

Object Property Table section

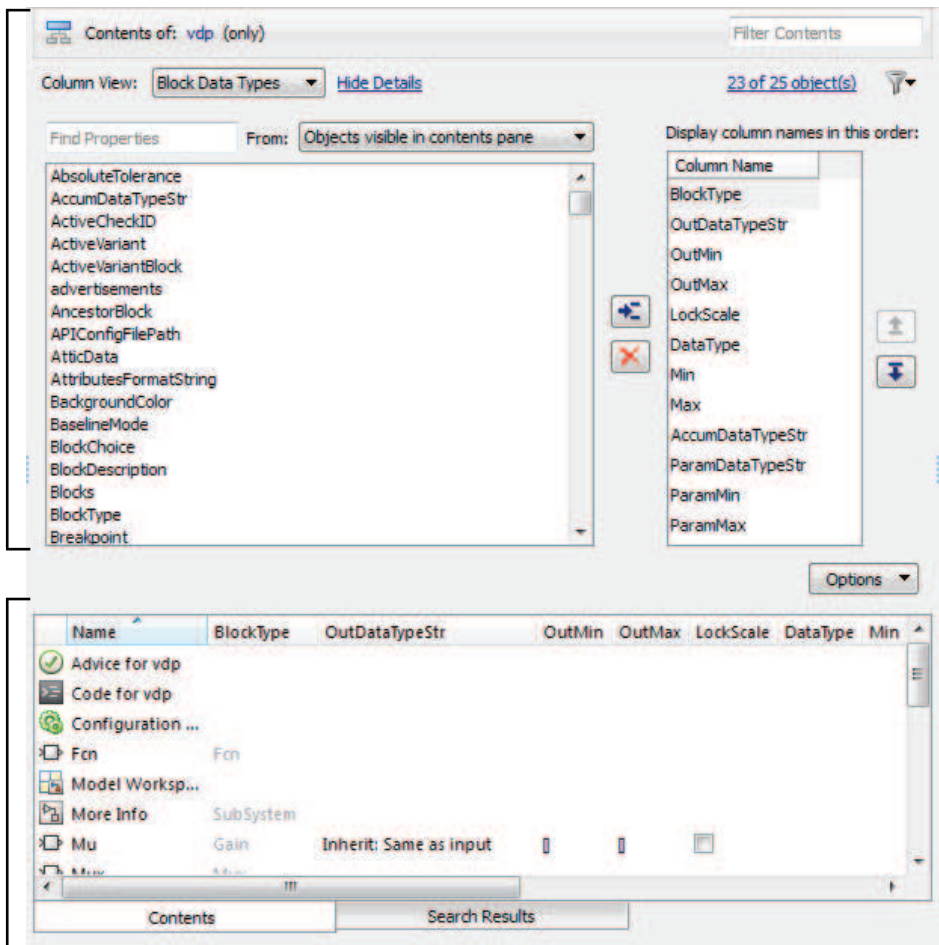

The **Column view details** section provides an interface for customizing the column view (hidden by default).

The **Object property table** section displays a table of model and chart object data (open by default).

### Data Displayed in the Contents Pane

In the object property table section of the **Contents** tab and in the **Search Results** tab:

- Table columns correspond to object properties (for example, Name and BlockType).

The object property table displays the first two columns (the object icon and the Name property) persistently, so that these columns remain visible regardless of how far you scroll to the right.

- Table rows correspond to objects (for example, blocks, and states).

The objects and properties displayed in the **Contents** pane depend on:

- The column view that you select in the **Contents** pane
- The node that you select in the **Model Hierarchy** pane
- The kind of object (for example, subsystem, chart, or configuration set) that you select in the **Model Hierarchy** pane
- The **View > Row Filter** options that you select

For more information about controlling which objects and properties to display in the **Contents** pane, see:

- “Customize Model Explorer Views” on page 12-39
- “Organize Data Display in Model Explorer” on page 12-23
- “Filter Objects in the Model Explorer” on page 12-31

### Link to the Currently Selected Node

The **Contents of** link at the top left side of the **Contents** pane links to the currently selected node in the **Model Hierarchy** pane. The model data displayed in the Contents pane reflects the setting of the **Current System and Below** option. In the following example, **Contents of** links to the **vdp** model, which is the currently selected node.

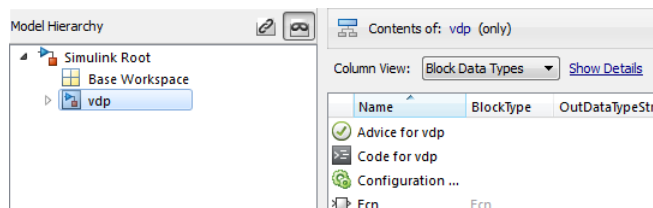

### Working with the Contents Pane

The following table summarizes the key tasks to control what is displayed in the **Contents**.

Task	Documentation
Control which kinds of objects to display.	“Use the Row Filter Option” on page 12-31
Search within the selected set of objects.	“Search Using Model Explorer” on page 12-52
Specify a set of properties to display based on the kind of node.	“Customize Model Explorer Views” on page 12-39
Group data based on unique values in a property column.	“Group by a Property” on page 12-24
Manage views (for example, save and export a view).	“Managing Views” on page 12-43
Add, remove, or rearrange columns.	“Organize Data Display in Model Explorer” on page 12-23
Edit object property values.	“Editing Object Properties” on page 12-22

### Editing Object Properties

To open a properties dialog box for an object in the **Model Hierarchy** pane, right-click the object, and from the context menu, select **Properties**. Alternatively, click an object and from the **Edit** menu, select **Properties**.

You can change modifiable properties in the **Contents** pane (for example, a block name) by editing the displayed value. To edit a value, first select the row that contains the value, and then click the value. An edit control replaces the value (for example, an edit field for text values or a list for a range of values). For workspace variables that are arrays or structures, you can use the Variable Editor. Use the edit control to change the value of the selected property.

To assign the same property value to multiple objects in the **Contents** pane, select the objects and then change one of the selected objects to have the new property value. An edit control replaces the value with `<edit>`, indicating that you are doing batch editing. The Model Explorer assigns the new property value to the other selected objects, as well.

You can also change property values using the **Dialog** pane. See “Model Explorer: Property Dialog Pane” on page 12-36.

## Organize Data Display in Model Explorer

- “Sort Column Contents” on page 12-23
- “Group by a Property” on page 12-24
- “Change the Order of Property Columns” on page 12-27
- “Add Property Columns” on page 12-28
- “Hide or Remove Property Columns” on page 12-29
- “Mark Nonexistent Properties” on page 12-30

You can control how the object property table and **Search Results** pane organize the layout of property information by:

- Sorting column contents
- Grouping by a property
- Changing the order of property columns
- Adding a property column
- Hiding and removing property columns

### Sort Column Contents

To sort the column contents in ascending order, click the heading of the property column. A triangle pointing up appears in the column heading. To change the order from ascending to descending, or from descending to ascending, click the heading of the column again.

For example, if properties are in ascending order, based on the **Name** property (the default), click the heading of the **Name** column to display objects by name, in descending order.

By default, the **Contents** pane displays its contents in ascending order, based on the name of the object. Objects that have no values in any property columns appear at the end of the object property table.

---

**Note:** When you group by property, the Model Explorer applies sorting of column contents within each group.

---

## Group by a Property

### Organizing Contents by Property Values

When you explore a model, you might want to focus on all objects with the same property value. One approach is to group data by a property column.

For example, suppose that you want to see all of the blocks in the f14 model. You could perform the following search.

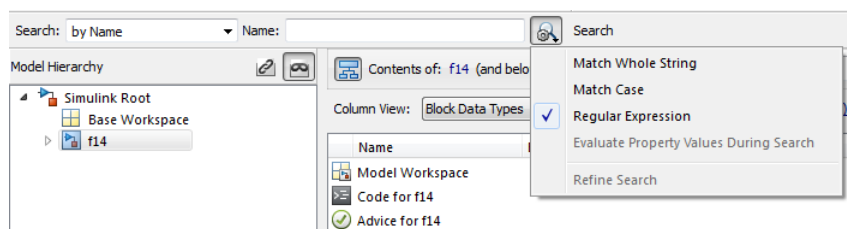

The search results obscure the whole path name for lower-level nodes:

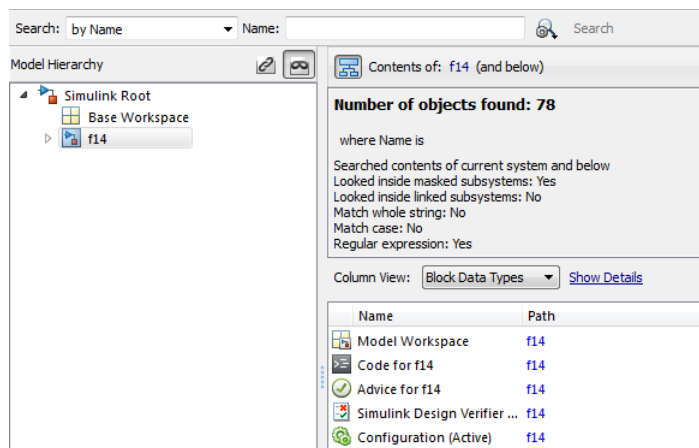

By grouping on the Path property column, you see the whole path for lower-level nodes.



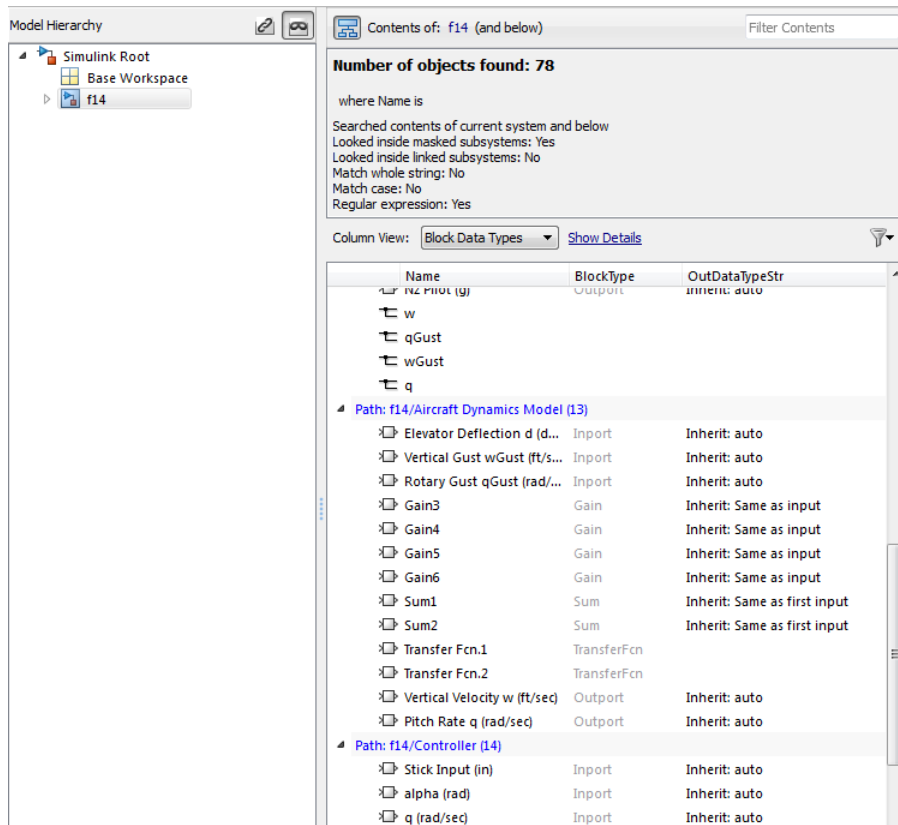

You can also collapse groups to focus on specific portions of a model.

### How to Group by a Property Column

To group by a property:

- 1 In the object property table, right-click the column heading of the property by which you want to group contents.

You can group by object icons, such as a block icon (📦), which represents a type of object. Right-click the empty column heading in the first column.

- 2 From the context menu, select the **Group By This Column** menu item.

### Sorting with Grouped Data

When you group by property, the Model Explorer applies sorting of column contents within each group.

### Expanding and Collapsing Grouped Data

By default, Model Explorer displays groups in expanded form. That is, all the objects in each group are visible. You can collapse and expand groups.

- To collapse the contents of a group, click the minus sign icon for that group.
- To expand a group, click the plus sign.
- To collapse or expand all the groups, right-click anywhere in the object property table and select either the **Collapse All Groups** menu item (**Shift+C**) or **Expand All Groups** menu item (**Shift+E**).

### Hiding the Group Column

By default, the property column that you use for grouping appears in the property table. That property also appears in the top row for each group.

To hide the group column in the property table, use one of the following approaches:

- From the **View** menu, clear the **Show Group Column** check box.
- Right-click a column heading in the property table and clear the **Show Group Column** check box.

### Persistence of Grouped Data Settings

If you group by a property, that grouping is saved as part of the view definition.

When you select a different node in the **Model Hierarchy** pane, the contents for the new node are grouped by that same property. However, all groups are expanded, even if you had collapsed all groups before switching nodes.

### Group Search Results

You can use grouping to organize the **Search Results** pane. The grouping that you apply to the **Search Results** pane also applies to the object property table, if that property is in the table. If the search results include a property that is not in the object property table, and you group on that property, then the Model Explorer removes the grouping setting that was in effect in the object property table.

## Change the Order of Property Columns

### Object Icon and Name Columns Are Always First

The first two columns of every object property table are the object icon column (the column with a blank column heading) and the **Name** property column. You cannot hide, remove, or change the location of the first two columns.

### How to Change the Order of Property Columns

To change the order of property columns in the object property table, use one of these approaches:

- In the object property table, select a column heading and drag it to a new location in the table.

This approach avoids opening the column view details section and makes it easier to move a column a short distance to the right or left.



- In the column view details section, select one or more property columns and move them up or down in the list, using the arrow buttons to the right of the list.

This approach allows you to move several property columns in one step, but it moves the selected columns right or left by only one column at a time.

To move a property column by using the view details interface:

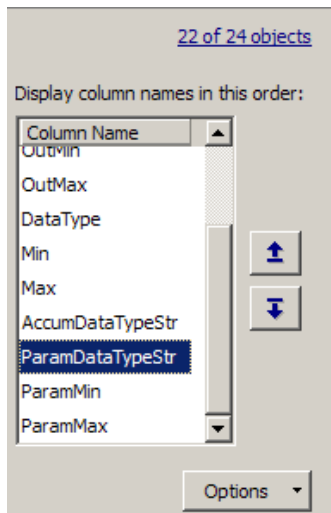
- 1 In the **Display column names in this order** list on the right side of the column view details section, select one or more property columns that you want to move.





- 2 Click the **Move column left in view** button () or the **Move column right in view** button ()

## Add Property Columns

To add property columns to a view:

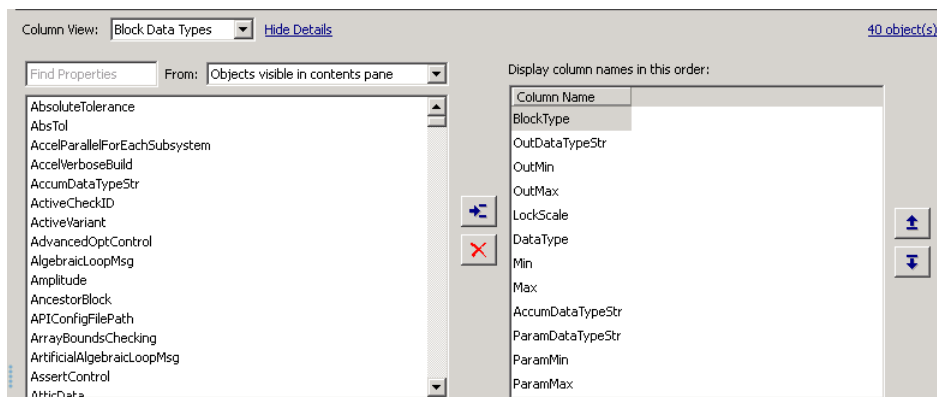
- 1 If you do not have the column view details section of the **Contents** pane already open, then at the top of the **Contents** pane, select **Show Details**.



- 2 In the list of properties on left side of the column view details section, select one or more properties that you want to add.
  - The list displays property names in alphabetical order. You can use the **Find Properties** search box in the column view details section to search for properties that contain the text string that you enter. You can specify the scope of the search with the **From** list to the right of the search box.
- 3 In the list of column names on the right side, select the property column that you want to be to the left of the property columns you insert.
- 4 Click the **Display property as column in view** button ()

### Adding a Path Property Column

The Model Explorer provides a shortcut for adding a **Path** property column to a view. To add a **Path** property column:

- 1 Right-click the column heading in the object property table to the right of which you want to insert a **Path** column.
- 2 From the context menu, select **Insert Path**.

### Hide or Remove Property Columns

You can choose between two approaches to hide (remove) a property column from the object property table. Hiding and removing a column both have the same result. You can:

- Hide a column using the context menu for a column heading. This approach avoids needing to open the column view details section.
- Remove a column using the column view details interface. This approach allows you to delete several properties in one step.

#### Hiding a Column Using the Column Heading Context Menu

- 1 Right-click the column heading of the column that you want to remove.
- 2 From the context menu, select **Hide**.

#### Removing a Column Using the Column View Details Interface

- 1 If you do not have the column view details section of the **Contents** pane already open, then at the top of the **Contents** pane, select **Show Details**.

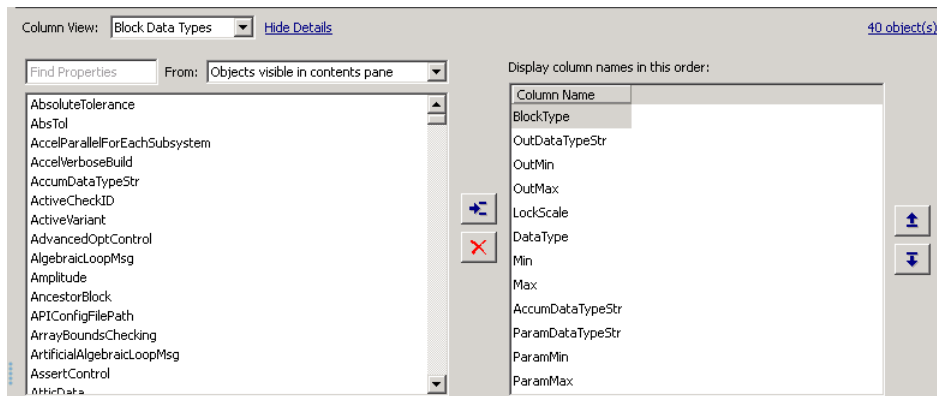

- 2 In the column view details section of the **Contents** pane, in the **Display column names in this order** list, select one or more properties that you want to remove.
- 3 Click the **Remove column from view** button () or the **Delete** key.

### Inserting Recently Hidden or Removed Columns

The Model Explorer maintains a list of columns you hide or remove for each view during a Simulink session.

To add a recently hidden or removed column back into a view:

- 1 Right-click the column heading of the column to the right of which you want to insert a recently hidden column.
- 2 From the context menu, select **Insert Recently Hidden Columns**.
- 3 Select the column that you want to insert.

See “Hide or Remove Property Columns” on page 12-29.

### Mark Nonexistent Properties

Usually, some of the properties that the **Contents** pane displays do not apply to all the displayed objects (in other words, some objects do not have values set). By default, the Model Explorer displays a dash (–) to mark properties that do not have a value.

If you want the Model Explorer to display a blank (instead of the default dash) in property cells that have no values, clear the **View > Show Nonexistent Properties as “\_”** option. The **Contents** pane looks similar to the following graphic:

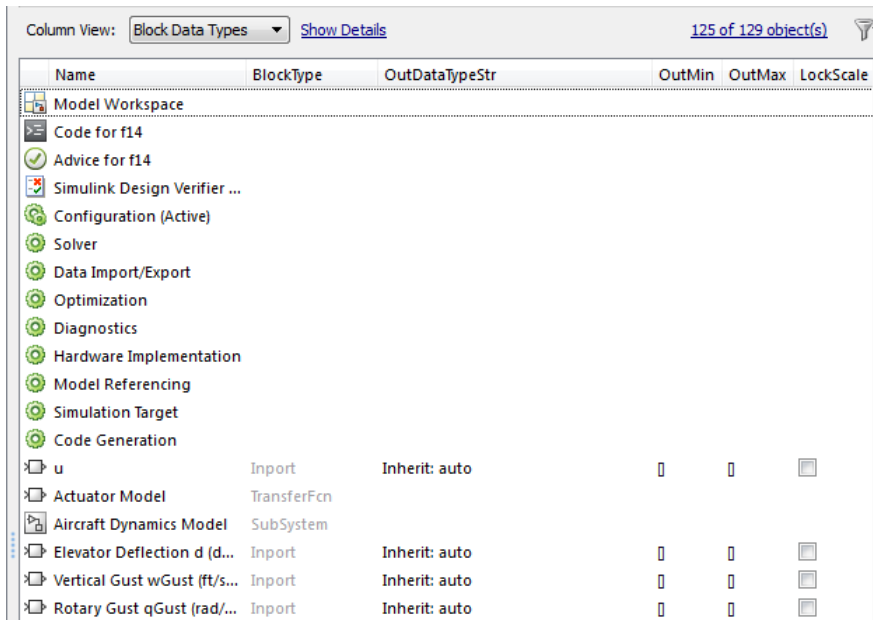

## Filter Objects in the Model Explorer

- “Use the Row Filter Option” on page 12-31
- “Filtering Contents” on page 12-34

Two techniques that you can use to control the set of objects that the **Contents** pane displays are:

- Using the Row Filter option
- Filtering contents

For a summary of other techniques, see “Focus on Specific Elements of a Model or Chart” on page 12-9.

### Use the Row Filter Option

You can filter the kinds of objects that the **Contents** pane displays:

- 1 Open the **Row Filter** options menu. In the Model Explorer, at the top-right corner of the **Contents** pane, click the **Row Filter** button.

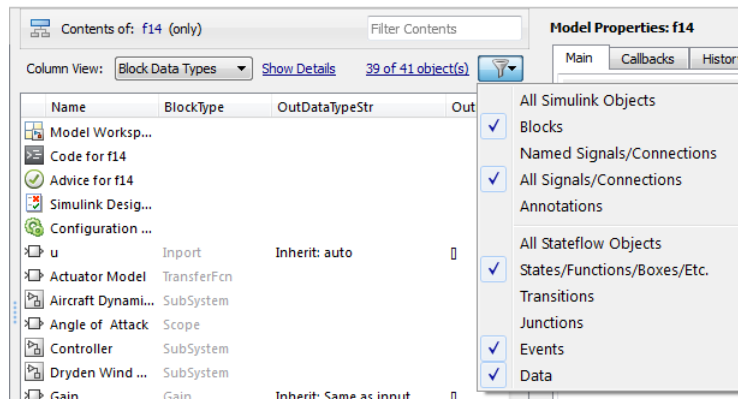

An alternative way to open the Row Filter menu is to select **View > Row Filter**.

By default, the **Contents** pane displays these kinds of objects for the selected node:

- Blocks
  - Signals and connections
  - Stateflow states, functions, and boxes
  - Stateflow events
  - Stateflow data
- 2** Clear the kinds of objects that you do not want to display in the **Contents** pane, or enable any cleared options to display more kinds of objects. For example, clear **All Signals/Connections** to prevent the display of signal and connection objects in the **Contents** pane.



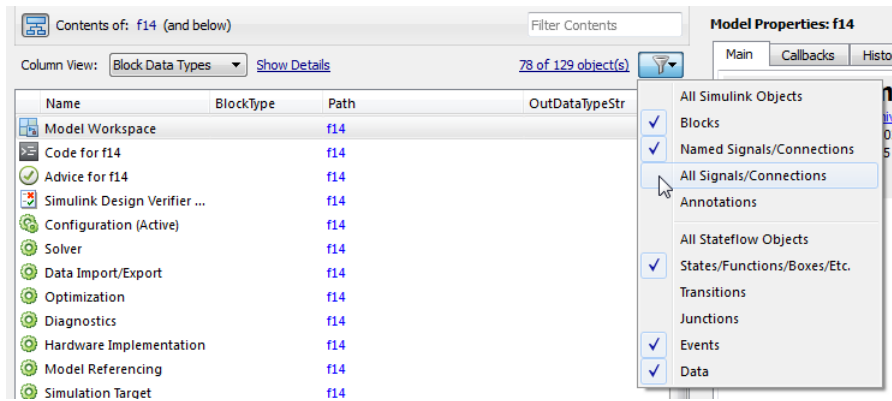

## Object Count

The top-right portion of the **Contents** pane includes an object counter, indicating how many objects the **Contents** pane is displaying.

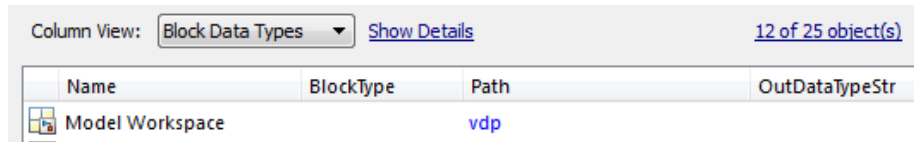

When you use the **Row Filter** option to filter objects, the object count indicator reflects that the **Contents** pane displays a subset of all the model and chart objects.

To view an explanation of the current object count, click the object count link (for example, 12 of 25 objects). That link displays a pop-up information box:

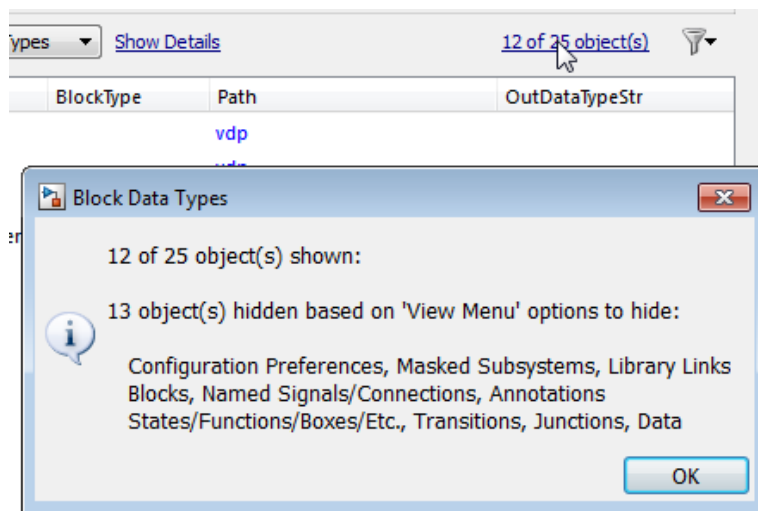

## Filtering Contents

To refine the display of objects that are currently displayed in the **Contents** pane, you can use the **Filter Contents** text box at the top of the **Contents** pane to specify search strings for filtering a subset of objects.

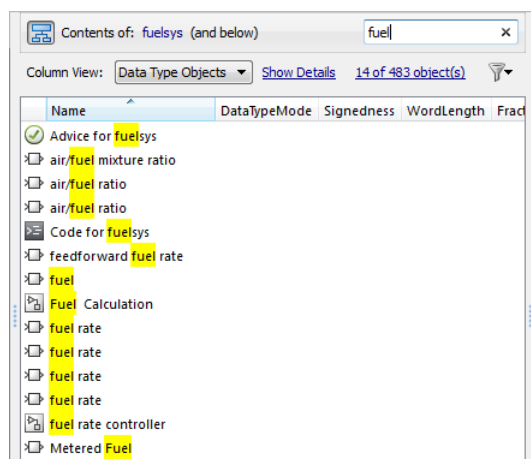

Using the **Filter Contents** text box can help you to find specific objects within the set of objects, based on a particular object name, property value, or property that is of interest

to you. For example, if you enter the text string `fuel` in the **Filter Contents** edit box, the Model Explorer displays results similar to those shown above. The results highlight the text string that you specified.

### Specifying Filter Text Strings

As you enter text in the **Filter Contents** text box, the Model Explorer performs a dynamic search, displaying results that reflect the text as you enter it.

The text strings you enter must be in the format consistent with the guidelines described in the following sections.

**Case Sensitivity** — By default, the Model Explorer ignores case as it performs the filtering.

To specify that you want the Model Explorer to respect case sensitivity for a text string that you enter, put that text string in quotation marks. For example, if you want to restrict the filtering to display only objects that include the text `Fuel` (with a capital F), enter `"Fuel"` (with quotation marks).

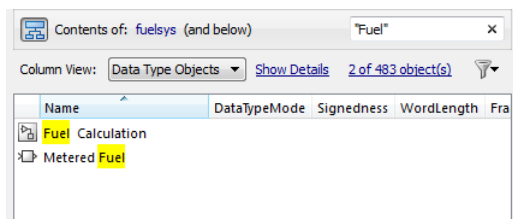

**Specifying Properties and Property Values** — To restrict the filtering to apply to objects with a specific property, specify the property name followed by a colon (:). The **Contents** pane displays objects that have that property.

To filter for a objects for which a specific property has a specific value, specify the property name followed by a colon (:) and then the value. For example, to filter the contents to display only objects whose `OutDataTypeStr` property has a value that includes `Inherit`, enter `OutDataTypeStr: Inherit` (alternatively, you could put the whole string in quotation marks to enforce case sensitivity):

Name	BlockType	OutDataTypeStr
Constant2	Constant	Inherit: Inherit from 'Constant v
Constant3	Constant	Inherit: Inherit from 'Constant v
Constant4	Constant	Inherit: Inherit from 'Constant v
Constant5	Constant	Inherit: Inherit from 'Constant v
High Speed (rad./Sec.)	Constant	Inherit: Inherit from 'Constant v
Nominal Speed	Constant	Inherit: Inherit from 'Constant v
engine speed	Inport	Inherit: auto
throttle angle	Inport	Inherit: auto
fuel	Inport	Inherit: auto

Wildcards and MATLAB Expressions Not Supported — The Model Explorer does not recognize wildcard characters, such as an asterisk (\*), as having any special meaning. For example, if you enter `fuel*` in the **Filter Contents** text box, you get no results, even if several objects contain the text string `fuel`.

Also, if you specify a MATLAB expression, in the **Filter Contents** text box, the Model Explorer interprets that string as literal text, not as a MATLAB expression.

### Clearing the Filtered Contents

To redisplay the object property table as it appeared before you filtered the contents, click the **X** in the **Filter Contents** text box.

### Filtering Removes Grouping

If you have set up grouping on a column, then when you filtering contents, the Model Explorer does not retain that grouping.

## Model Explorer: Property Dialog Pane

- “Showing and Hiding the Dialog Pane” on page 12-36
- “Editing Properties in the Dialog Pane” on page 12-37

Use the **Dialog** pane to view and change properties of objects that you select in the **Model Hierarchy** pane or in the **Contents** pane.

### Showing and Hiding the Dialog Pane

By default, the **Dialog** pane appears in the Model Explorer, to the right of the **Contents** pane. To show or hide the **Dialog** pane, use one of these approaches:

- From the **View** menu, select **Show Dialog Pane**.
- From the main toolbar, click the **Dialog View** button (.

### Editing Properties in the Dialog Pane

To edit property values using the **Dialog** pane:

- 1 In the **Contents** pane, select an object (such as a block or signal). The **Dialog** pane displays the properties of the object you selected.

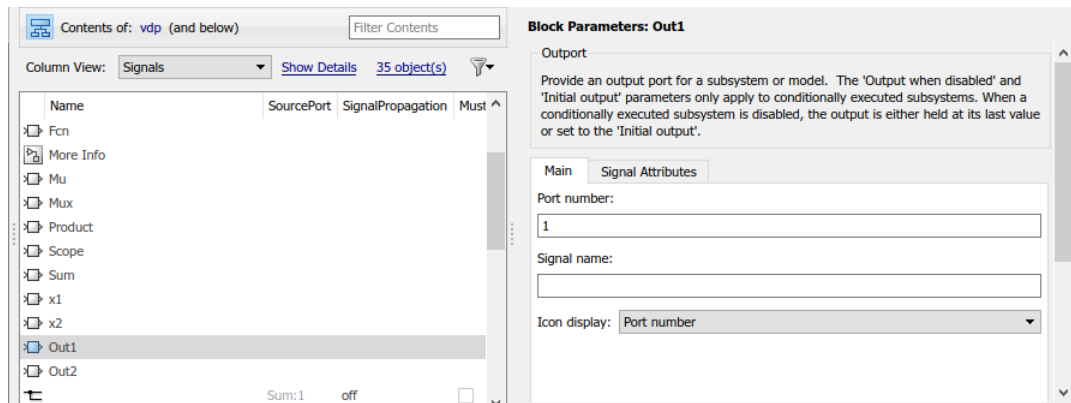

- 2 Change a property (for example, the port number of an Outport block) in the **Dialog** pane.
- 3 Click **Apply** to accept the change, or click **Revert** to return to the original value.

By default, clicking outside a dialog box with unapplied changes causes the Apply Changes dialog box to appear:

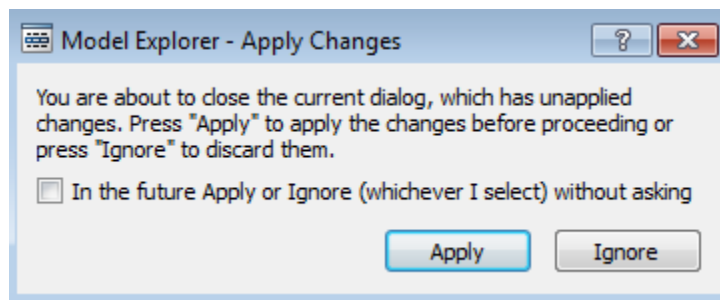

Click **Apply** to accept the changes or **Ignore** to revert to the original settings.

To prevent display of the **Apply Changes** dialog box:

- 1 In the dialog box, click the **In the future Apply or Ignore (whichever I select) without asking** check box.
- 2 If you want Simulink to apply changes without warning you, press **Apply**. If you want Simulink to ignore changes without warning you, press **Ignore**.

To restore display of the **Apply Changes** dialog box, from the **Tools** menu, select **Prompt if dialog has unapplied changes**.

### Related Examples

- “Customize Model Explorer Views” on page 12-39
- “Find Model Elements in Simulink Models” on page 12-48
- “Edit and Manage Workspace Variables Used by Models” on page 57-92
- “View and Revert Changes to Dictionary Data” on page 61-27

# Customize Model Explorer Views

## In this section...

“Using Views” on page 12-39

“Customizing Views” on page 12-42

“Managing Views” on page 12-43

## Using Views

### What Is a Column View?

A view in the Model Explorer is a named set of properties.

The Model Explorer uses views to specify sets of property columns to display in the **Contents** pane.

For each kind of node in the **Model Hierarchy** pane, certain properties are most relevant for the objects displayed in the **Contents** pane. For example, for a Simulink model node, such as a model or subsystem, some properties that are useful to display include:

- **BlockType** (block type)
- **OutDataTypeStr** (output data type)
- **OutMin** (minimum value for the block output)

Generally, a column view does not contain the total set of properties for all the objects in a node. Specifying a subset of properties to display can streamline the task of exploring and editing model and chart object properties and increase the density of the data displayed in the **Contents** pane.

### What You Can Capture in a View

You can use a view to capture the following characteristics of the model information to show in the Model Explorer:

- Properties that you want to display in the **Contents** pane (see “Customizing Views” on page 12-42)
- Layout of the **Contents** pane (for example, grouping by property, the order of property columns, and sorting), as described in “Organize Data Display in Model Explorer” on page 12-23.

### Use Standard Views or Customized Views

You can use views in the following ways:

- Use the standard views shipped with the Model Explorer
- Customize the standard views
- Create your own views

### Automatically Applied Views

The first time you open the Model Explorer, the software automatically applies one of the standard views to the node you select in the **Model Hierarchy** pane. The Model Explorer applies a view based on the kind of node you select.

The Model Explorer assigns one of four categories of nodes in the **Model Hierarchy** pane. The Model Explorer initially associates a default view with each node category. The four node categories are:

Node Category	Kinds of Hierarchy Nodes Included	Initial Associated View
Simulink	Models, subsystems, and root level models	Block Data Types
Workspace	Base and model workspace objects	Data Objects
Stateflow	Stateflow charts and states	Stateflow
Other	Objects that do not fit into one of the first three categories; for example, configuration sets	Default

The **Column View** field at the top of the **Contents** pane displays the view that the Model Explorer is currently using.

#### If you select a view

In the **Contents** pane, from the **Column View** list, you can select a different view. If you select a different view, then the Model Explorer associates that view with the category of the current node. For example, suppose the selected node in the **Model Hierarchy** pane is a Simulink model, and the current view is **Data Objects**. If you



change the view to **Signals**, then when you select another Simulink model node, the Model Explorer uses the **Signals** view. See “Selecting a View Manually” on page 12-41.

## Selecting a View Manually

By default, the Model Explorer automatically applies a view, based on the category of node that you select and the last view used for that node. You can manually select a view from the **Column View** list that better meets your current task.

You can shift from the default mode of having the Model Explorer automatically apply views to a mode in which you must manually select a view to change views.

To enable the manual view selection mode:

- 1 Select **View > Column View > Manage Views**.

The View Manager dialog box opens.

- 2 In the View Manager dialog box, click the **Options** button and clear **Change View Automatically**.

In the manual view selection mode, if you switch to a different kind of node in the **Model Hierarchy** pane that has a different view associated with it, the **Contents** pane displays a yellow informational bar suggesting a view to use.

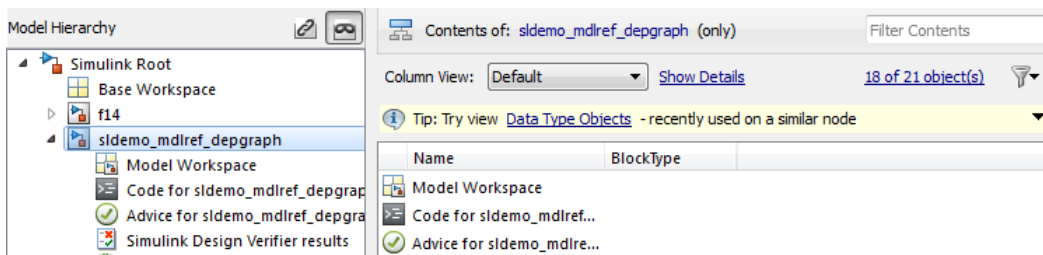

### Tip interface

The tip interface appears immediately above the object property table.

The tip does not appear if you use automatic view selection.

To hide the currently displayed tip, from the menu button on the right-hand side of the tip bar, select **Hide This Tip**.

The tip interface displays a link for changing the current view to a suggested view. To choose the suggested view displayed in the tip bar, click the link.

Initially, the suggested view is the default view associated with a node. If you associate a different view with a node category, then the tip suggests the most recently selected view when you select similar nodes.

To change from manual specification of views to automatic specification, from the tip interface, select the down arrow and then the **Change View Automatically** menu item.

### Customizing Views

If a standard view does not meet your needs, you can either modify the view or create a new view.

You can customize the object property table represented by the current view in several ways, as described in these sections:

- “Add Property Columns” on page 12-28
- “Hide or Remove Property Columns” on page 12-29
- “Change the Order of Property Columns” on page 12-27

### How the Model Explorer Saves Your Customizations

As you modify the object property table, you change the current view definition.

The Model Explorer saves the following changes to the object property table as part of the column view definition:

- Grouping by property
- Sorting in a column
- Changing the order of property columns
- Adding a property column
- Hiding and removing property columns

When you change from one view to another view, the Model Explorer saves any customizations that you have made to the previous view.

For example, suppose you use the **Block Data Types** view and you remove the **LockScale** property column. If you then switch to use the **Data Objects** view, and

later use the **Block Data Types** view again, the **Block Data Types** view no longer includes the **LockScale** column that you deleted.

At the end of a Simulink session, the Model Explorer saves the view customizations that you made during that session. When you reopen the Model Explorer, Simulink uses the customized view, reflecting any changes that you made to the view in the previous session.

### Controlling the Font Size

You can change the font size in the Model Explorer panes:

- To increase the font size, press the **Ctrl + Plus Sign (+)**.

Alternatively, from the Model Explorer **View** menu, select **Increase Font Size**.

- To decrease the font size, press the **Ctrl + Minus Sign (-)**.

Alternatively, from the Model Explorer **View** menu, select **Decrease Font Size**.

---

**Note** The changes remain in effect for the Model Explorer and in the Simulink dialog boxes across Simulink sessions.

---

## Managing Views

If a standard view does not meet your needs, you can either modify the view or create a new view. See “Customizing Views” on page 12-42.

You can manage views (for example, create a new view or export a view) using the View Manager dialog box.

### Opening the View Manager Dialog Box

To open the View Manager dialog box, select the **Manage Views** option from either:

- The **View > Column View** menu
- The options listed when you click the **Options** button in the column view details section

The View Manager dialog box displays a list of defined views and provides tools for you to manage views.

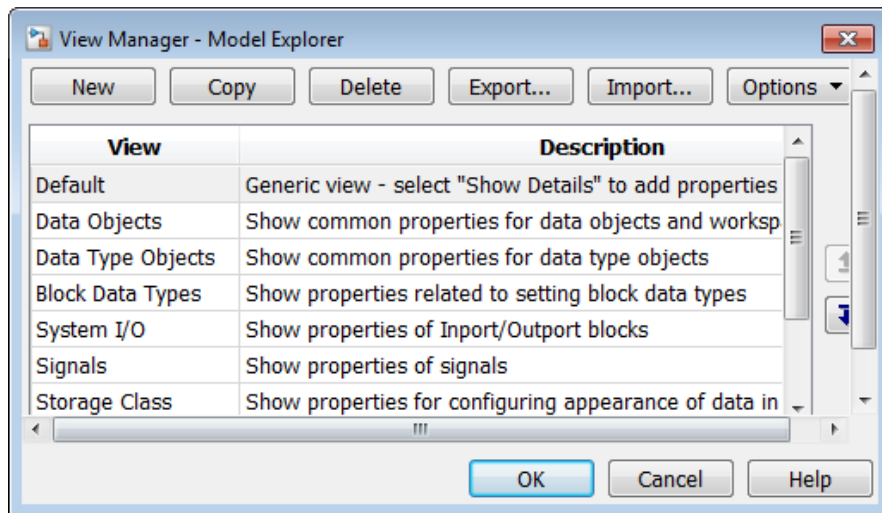

You can manage views in several ways, including:

- “Creating a New View” on page 12-44
- “Deleting Views” on page 12-45
- “Reordering Views” on page 12-45
- “Exporting Views” on page 12-46
- “Importing Views” on page 12-46
- “Resetting Views to Factory Settings” on page 12-47

### Creating a New View

To create a new view that has a new name, you can use one of these approaches:

- Copy an existing view, rename it, and customize the view.
- Create a completely new view.

After you create a new view, you can customize the view as described in “Customizing Views” on page 12-42.

### Copying and renaming an existing view

You can build a new view by copying an existing view, renaming it, and optionally customizing the renamed view. In the View Manager dialog box:

- 1 Select the view that you want to use as the starting point for your new view.
- 2 Click the **Copy** button.

A new row appears at the bottom of the View Manager table of views. The new row contains the name of the view you copied, followed by a number in parentheses. For example, if you copy the **Stateflow** view, the initial name of the copied view is **Stateflow (1)**.

### Creating a completely new view

To create a completely view, in the View Manager dialog box, click the **New** button. A new view row appears at the bottom of the View Manager dialog box list of views.

### Naming and describing a new view

Once you create a view, you can name the view and provide a description of the view:

- 1 Double-click **New View** in the left column of the table of views and replace the text with a name for the view.
- 2 Double-click **Description** in the table and replace the text with a description of the view.
- 3 Click **OK**.

### Deleting Views

To delete a view from the **Column View** list of views:

- 1 In the View Manager dialog box, select one or more views that you want to remove from the list.
- 2 Click the **Delete** button or the **Delete** key.
- 3 Click **OK**.

Deleting a view using the View Manager dialog box permanently deletes that view from the Model Explorer interface.

If you think you or someone else might want to use a view again, consider exporting the view before you delete it (see “Exporting Views” on page 12-46).

### Reordering Views

To change the position of a view in the **Column View** list, in the View Manager dialog box:

- 1 Select one or more views that you wish to move up or down one row in the table of views.
- 2 Click the up or down arrow buttons to the right of the table of views. Repeat this step until the view appears where you want it to be in the table.
- 3 Click **OK**.

### Exporting Views

To export views that you or others can then import, in the View Manager dialog box:

- 1 In the View Manager dialog box, select one or more views that you want to export.
- 2 Click the **Export** button.

An Export Views dialog box opens, with check marks next to the views that you selected.

- 3 Click **OK**.

An Export to File Name dialog box opens.

- 4 Navigate to the folder to which you want to export the view.

By default, the Model Explorer exports views to the MATLAB current folder.

- 5 Specify the file name for the exported view.

The file format is `.mat`.

- 6 Click **OK**.

### Importing Views

To import view files from another location for use by the Model Explorer:

- 1 In the View Manager dialog box, click the **Import** button.

The Select `.mat` File to Import dialog box opens.

- 2 Navigate to the folder from which you want to import the view.
- 3 Select the MAT-file containing the view that you want to import and then click **Open**.

A confirmation dialog box opens. Click **OK** to import the view.

The imported view appears at the bottom of the **Column View** list of views.

The Model Explorer automatically renames the view if a name conflict occurs.

### **Resetting Views to Factory Settings**

You can reset (restore) the original definition of a specific standard view (that is, a view shipped with the Model Explorer) if that view is the current view. To do so, click the **Options** button in the column view details section and select **Reset This View to Factory Settings**.

To reset the factory settings for *all* standard views in one step, in the View Manager dialog box, click the **Options** button and select **Reset All Views to Factory Settings**.

---

**Note:** When you reset all views, the Model Explorer removes all the custom views you have created. Before you reset views to factory settings, export any views that you will want to use in the future.

---

### **Related Examples**

- “Organize Data Display in Model Explorer” on page 12-23
- “Search Using Model Explorer” on page 12-52
- “Filter Objects in the Model Explorer” on page 12-31

### **More About**

- “Search and Edit Using Model Explorer” on page 12-2

## Find Model Elements in Simulink Models

When you build and modify your model, it helps when you understand your model structure and can locate specific model elements. Simulink Editor tools simplify these tasks. Use the tool that is appropriate for your model size and complexity.

- Use the model browser to view and navigate the structure of your model. You can find an element using the model browser by navigating to it through the model hierarchy. This approach works well for a smaller model whose structure you are familiar with. See “Explore the Model Hierarchy Using the Model Browser” on page 12-48.
- Use **Edit > Find** to locate model elements that match search criteria. You can search in a selected system and optionally include all systems below it. You can also narrow your results based on search criteria. See “Search for Model Elements Using Find” on page 12-49.
- Use the Model Explorer to search the model hierarchy using advanced criteria. You can use it to search the model hierarchy and search for variables. The Model Explorer also enables you to search in and apply a change to multiple model elements at once. See “Search Using Model Explorer” on page 12-52.
- Use project-wide search to search across all your models and supporting files in one place. You can find matches inside model files, MATLAB files, and other project files such as PDF and Microsoft Word files. See “Project-Wide Search” on page 17-4.

### Explore the Model Hierarchy Using the Model Browser

Use the model browser to navigate a model hierarchy using a tree structure. The browser helps you to understand the organization of your model and explore systems within systems.

To display the model browser, in the Simulink Editor, select **View > Model Browser > Show Model Browser**. You can also use the **Hide/Show Model Browser** control on the palette to toggle the browser display.

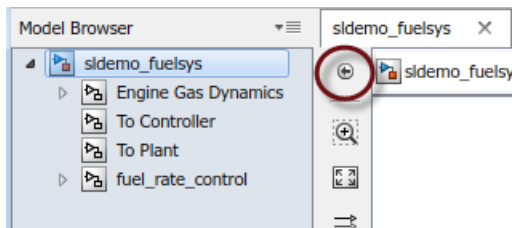



You can use the commands on the **View > Model Browser** menu to specify whether to include in the browser blocks that are linked to a library and masked subsystems. For information on these types of blocks, see “Linked Blocks” on page 39-15 and “Masking Fundamentals” on page 37-2.

## Search for Model Elements Using Find

You can search in Simulink models using **Edit > Find**. Use Find and the Finder interface to locate, navigate to, and select any element that matches the search string that you enter. Searching can match the string anywhere in the element, such as in the name and in parameter values. You can customize the search to look only in certain types of elements or when specific parameters are set a certain way.

Default Search	Search Options
In the current system	Specify to search the current system and all systems below it in the model hierarchy.
In all model elements, including all types of Simulink and Stateflow objects	Narrow your search to include only the elements you are interested in, such as blocks, annotations, or signals.
In parameters	Specify to omit parameter values from the search.
Case-insensitive, partial matches	Search for an exact match and use regular expressions.
In referenced models but not in linked blocks or masked systems	You can turn each of these options off and on.

### Perform a Basic Search

Search in the current level of the model `sldemo_fuelsys` for any model element that contains the number 2.

---

**Tip:** Open the property inspector to see the properties and parameters of the current selection. Select **View > Property Inspector**.

---

- 1 Open the model `sldemo_fuelsys`.

- 2 Select **Edit > Find**.
- 3 In the search box, enter `2` and press **Enter**.

Nine model elements appear highlighted. The first element found, the copyright annotation, has a stronger highlight to show that it is the current match.

- 4 To move to the next element, click the search box down arrow. In this example, the current selection highlight moves to a Constant block. The block name does not appear in the model. Look in the Property Inspector to see the block name, `Constant2`.
- 5 Use the up and down arrows to move through the rest of the elements found.

### Search for a Property Value

Using the search box, you can specify a property and value to search for. Enter the search string in the form `Property:Value`. For example, to search for all **Constant value** parameters whose value is `throttle_sw`, type `Value:throttle_sw` and press **Enter**. To search for all Constant blocks, enter `BlockType:Constant`. To search for text that appears in the description of the block, use the form `Description:textstring`.

- Search using the programmatic name of the property. To find the programmatic name, in the Property Inspector, hover over the property.
- Enter the full property name, case insensitive. You cannot use regular expressions or partial matches for the property name.
- By default, the value search is case insensitive and finds partial matches. Use the advanced search settings to make the search case sensitive, specify verbatim matches, or search using regular expressions.

To search for a string that has a colon and prevent the text before the colon from being treated as a property, use any of these approaches:

- Escape the colon using a backslash, for example, `Earth\ : a planet`.
- Use single or double quotes around the expression, for example, `'Earth: a planet'` or `"Earth: a planet"`.

### Specify Search Criteria and Sort Results

You can specify criteria for your search and sort the results using the Finder interface. In this example, you search for all elements that contain the string `fuel`. You then use the Finder interface to narrow your results.

---

**Tip:** Use the model browser with the Finder interface to select the starting point for your search.

---

- 1 Open the model `sldemo_fuelsys`.
- 2 Select **Edit > Find**. Next to the search box, click the **View Details** button.

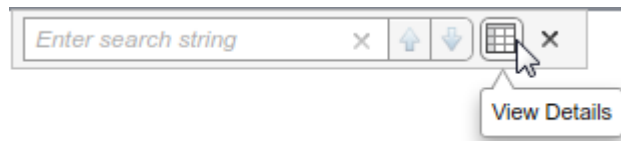

- 3 To expand the scope of the search, in the Finder interface, click the **Click to search in current system and below** button .
- 4 Search for any elements that include the string `fuel`. In the search box, enter `fuel` and press **Enter**.

The model has many elements with `fuel` in the name or in a parameter or property value, including blocks, annotations, signals (data), and Stateflow charts.

Use the Finder interface to make your results more meaningful. For example, you can sort by any of the headings and double-click an item in the list to go to and select the element in the model. Click an item in the list to make it the current match in the model if it is displayed.

- 5 When a search returns too many results, use the advanced search settings. Next to the search box, click the **Configure advanced search settings** button .
- 6 Search only for blocks. In the Advanced Search Settings dialog box, under **Object Type**, clear the **Stateflow** check box. Expand the **Simulink** list and clear the **Annotations** and **Signals** check boxes.
- 7 Narrow the search further to look only in blocks whose description contains the word `input`. Under **Property : Value**, from the property list, select **BlockDescription**. In the value box, enter `input`, and then click the **Add property and value** button. Click **OK**.
- 8 Searching returns 11 blocks. You can add more property values to narrow the search further. For example, you can specify the type of blocks to search in. Open the Advanced Search Settings dialog box. Under **Property : Value**, add another property-value pair. Set the property to **BlockType** and the value to `MultiPortSwitch`. Click the **Add property and value** button and click **OK**.

- One block appears in the list.
- 9 Clear the advanced search criteria. Click the arrow on the **Configure advanced search settings** button and select **Clear advanced settings**.

### Search Using Model Explorer

Model Explorer helps you to explore and modify your model using advanced techniques. Use the Model Explorer for to search for:

- Variables in workspaces and data dictionaries
- Variable usage in a model
- Instances of a type of block
- Block parameters and parameter values

You can combine search criteria and iteratively refine the results. Search in Model Explorer for model elements, starting with the node you select in the model hierarchy. You can search the entire model, in a particular system, or in a system and all the systems below it in the hierarchy. For details on the options, see “Search Bar Controls” on page 12-3.

Using your search results, you can apply changes to multiple elements at once.

#### Search for a Parameter and Refine Results

In this example, you search for model elements that have an **Output minimum** parameter. You then refine the results to include only Constant blocks. You can use the search results to find out more about how these values are set or make batch changes to the model elements found by the search.

- 1 Open the model `sldemo_fuelsys`.
- 2 Open Model Explorer. Select **View > Model Explorer > Model Explorer**.

By default, the Model Explorer searches the current system and below. You can use the model hierarchy tree in combination with the **Show contents** button  to specify the scope of the search. For example, you can select a node and set the search to **current system only** to keep the search only at that level. Set the search to **current system and below** to search the current system and all the subsystems within it.

- 3 For this example, leave the search scope set to search the current system and below, starting with the top level of the model. Specify your search criteria. In the search bar, set:

- **Search** to by Property Name
- **Property** to OutMin

OutMin is the programmatic name for the **Output Minimum** parameter. For a list of these names, see “Block-Specific Parameters”.

- 4 Click **Search**. In the **Search Results** box, 126 results appear. You can go to an item by clicking the link to the path.
- 5 Refine the search. In the search bar, click **Search Options** and select **Refine Search**.

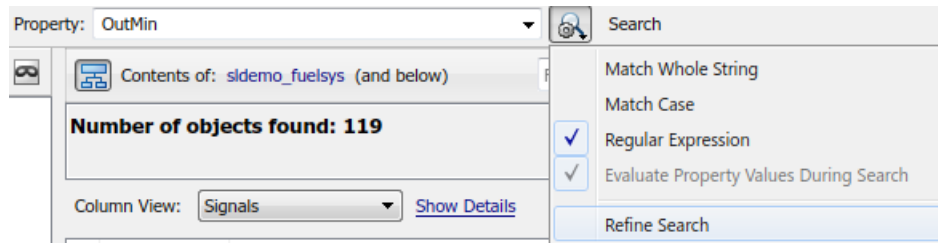

The search button label changes to **Refine**. With this label in effect, additional search criteria act on the previous set of results.

- 6 Set **Search** to by Block Type and set **Type** to Constant. Click **Refine**.

The search returns 19 items.

- 7 To work further with the values, click **Show Details**.
- 8 The property you are interested learning more about or acting on is OutMin. First add a column for it in the search results. Select OutMin from the list (you can enter it in the **Find Properties** box to locate it quickly), and click the **Display property as column in view** button.

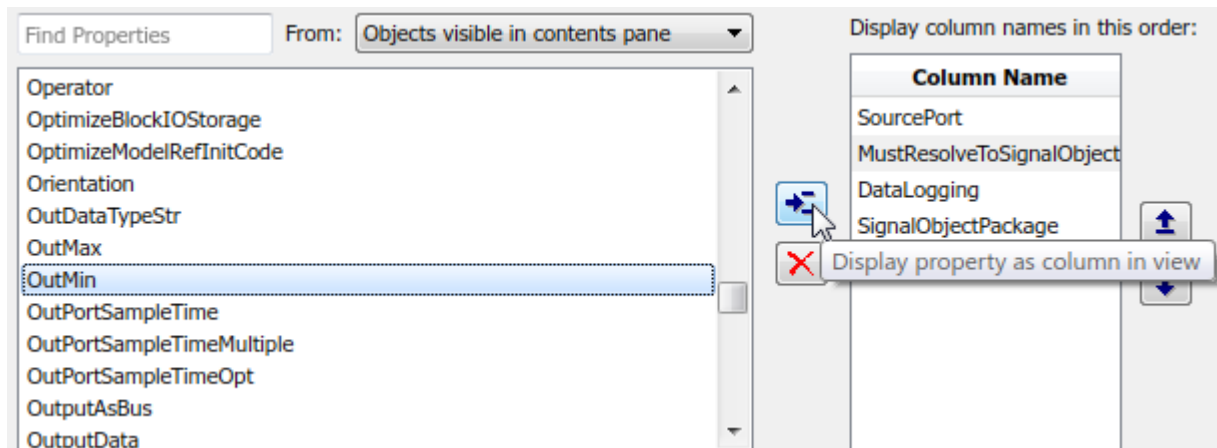

A column for **OutMin** appears in the search results. For any parameter or property that appears in a column, you can view, sort, and change values for multiple items. For example, to change the **OutMin** values on all Constant blocks you find by searching, select all the items in the list. In the **OutMin** column, click one value, type the new value (for example, 0), and press **Enter**.

---

**Tip:** To view a summary of the search options that you used, expand the **Number of objects found** box by clicking the **Show Search Details** button .

---

- To create, modify, and view the entries in a data dictionary, use the Model Explorer. See “Edit and Manage Workspace Variables Used by Models” on page 57-92 and “View and Revert Changes to Dictionary Data” on page 61-27.
- For general information about Model Explorer and its uses, see “Search and Edit Using Model Explorer” on page 12-2.

## See Also

find\_system

## Related Examples

- “Edit and Manage Workspace Variables Used by Models” on page 57-92

- “View and Revert Changes to Dictionary Data” on page 61-27
- “Project-Wide Search” on page 17-4

## **More About**

- “Use the Search & Replace Tool” (Stateflow)
- “Subsystems”
- “Regular Expressions” (MATLAB)
- “Search and Edit Using Model Explorer” on page 12-2

## Model Dependency Viewer

### In this section...

“Model Dependency Views” on page 12-56

“View Model File and Library Dependencies” on page 12-59

### Model Dependency Views

The Model Dependency Viewer displays a dependency view of a model. The dependency view is a graph of all the models and libraries referenced directly or indirectly by the model. You can use the dependency view to find and open referenced libraries and models. To identify and package all required files instead, see “Analyze Model Dependencies” on page 18-25.

The Model Dependency Viewer allows you to choose between the file dependency view and the model instances view.

#### File Dependency View

The file dependency view shows the model and library files referenced by a top model. A referenced model or library appears only once in the view even if it is referenced more than once in the model. The figure shows a dependency view. Gray blocks represent model files and blue boxes represent libraries. Arrows represent dependencies. For example, the arrows in this view indicate that the `aero_guidance` model references two libraries: `aerospace` and `simulink_need_slupdate`.

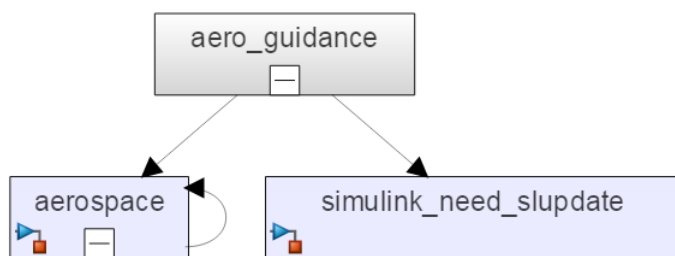

An arrow from a library that points to itself indicates that the library references itself. Blocks in the library reference other blocks in that same library. The example view shows that the `aerospace` library references itself.



A file dependency view can include a legend that identifies the model in the view and the date and time the view was created.

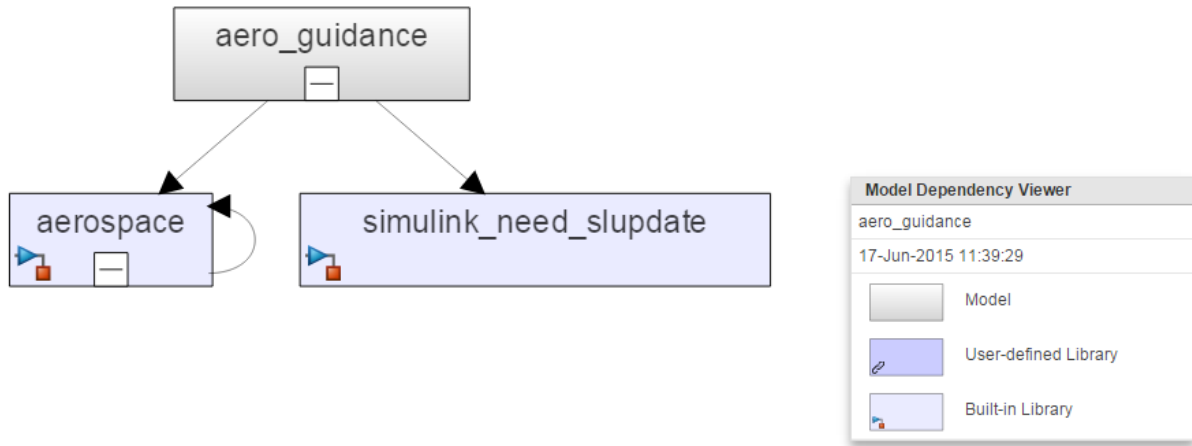

### Model Instances View

The model instances view shows every reference to a model in a model reference hierarchy (see “Model Referencing”) with the top model at the root of the hierarchy. If a model hierarchy references the same model more than once, the referenced model appears multiple times in the instance view, once for each reference. For example, this view indicates that the model reference hierarchy for `sldemo_md1ref_depgraph` contains two references to the model `sldemo_md1ref_F2C`.

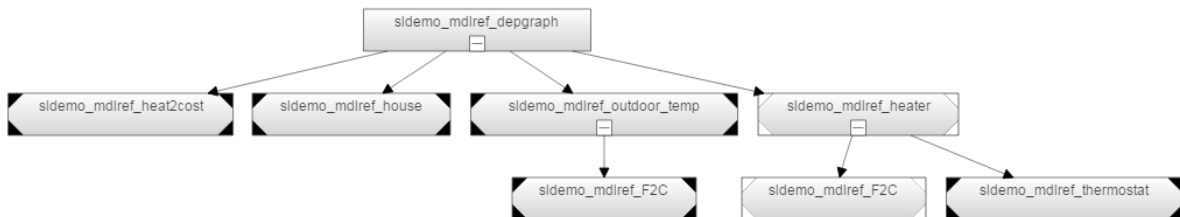

In an instance view, boxes represent a top model and model references. Boxes representing accelerated-mode instances (see “Simulate Model Referencing Models”

on page 8-31) have filled triangles in their corners; boxes representing normal-mode instances have empty triangles in their corners. For example, the previous diagram shows that one of the references to `sldemo_md1ref_F2C` operates in normal mode, and the other operates in accelerated mode.

Boxes representing protected referenced models on page 8-90 show the protected models `.slxp` extension. You cannot expand protected reference models.

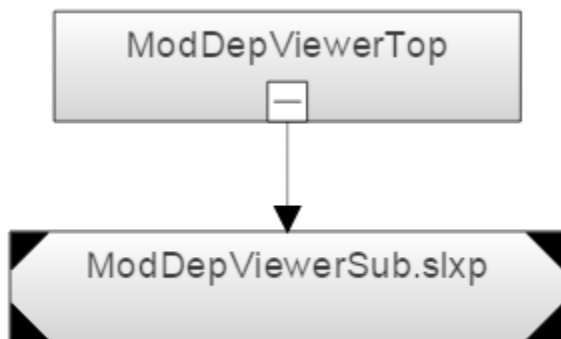

An instance view displays information icons  on instance boxes to indicate an override in simulation mode for that instance. For example, if a referenced model is configured to run in normal mode and it runs in accelerator mode, its simulation mode is overridden. This override occurs because another referenced model that runs in accelerator mode directly or indirectly references it.

#### **Processor-in-the-Loop Mode Indicator**

An instance view appends PIL to the names of models that run in processor-in-the-loop mode (see “Simulate Model Referencing Models” on page 8-31). For example, this dependency instance view indicates one instance of the referenced model `ModDepViewerSub` runs in processor-in-the-loop mode.

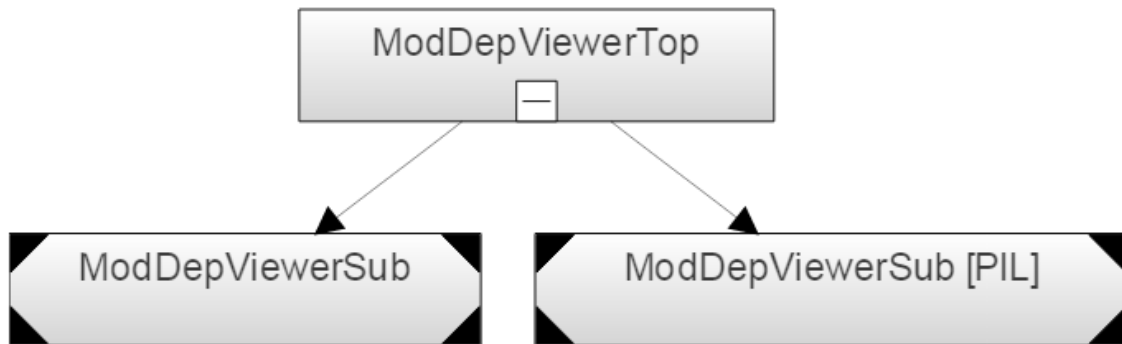

## View Model File and Library Dependencies

This example shows how to use Model Dependency Viewer to view model file and library dependencies of the model. To identify and package all required files instead, see “Analyze Model Dependencies” on page 18-25.

- 1 Open the model `sldemo_mdhref_depgraph`.
- 2 To open the Model Dependency Viewer in file dependency view, select **Analysis > Model Dependencies > Model Dependency Viewer > Models Only**.
- 3 Select the **User-Defined Libraries** check box. The viewer shows dependencies on user-defined libraries, if such dependencies exist.

You can open this view directly from the Simulink Editor by selecting **Analysis > Model Dependencies > Model Dependency Viewer > Models & Libraries**.

- 4 Select the **Built-In Libraries** check box to show dependencies on MathWorks built-in libraries.
- 5 To view the dependencies laid out horizontally, click **Options** and, under **Layout**, select **Horizontal**.
- 6 Collapse the dependencies of `sldemo_mdhref_outdoor_temp`. Click **-** on the box for `sldemo_mdhref_outdoor_temp`.
- 7 Hide the dependency viewer legend. Click **Options** and, under **Display**, select the **Legend** check box.
- 8 Click **Model Instances** to open the model instance view.

You can open this view directly from the Simulink editor by selecting **Analysis > Model Dependencies > Model Dependency Viewer > Referenced Model Instances**.

- 9 To display full paths in the boxes representing the instances, click **Options** and, under **Display**, select the **Full path** check box. Each box in the instance view displays the path of the Model block corresponding to the instance. The name of the referenced model appears in parentheses.
- 10 Select the box for `sldemo_md1ref_heat2cost` and click **Highlight Box**. The corresponding block in the `sldemo_md1ref_depgraph` model appears highlighted.
- 11 In the dependency viewer, double-click the `sldemo_md1ref_heat2cost` box to open the model in the Simulink Editor.

### More About

- “Libraries”
- “Model Referencing”

## View Linked Requirements in Models and Blocks

### In this section...

- “Requirements Traceability in Simulink” on page 12-61
- “Highlight Requirements in a Model” on page 12-61
- “View Information About a Requirements Link” on page 12-64
- “Navigate to Requirements from a Model” on page 12-65
- “Filter Requirements in a Model” on page 12-66

### Requirements Traceability in Simulink

If your Simulink model has links to requirements in external documents, you can review these links. To identify which model objects satisfy certain design requirements, use the following requirements features available in Simulink software:

- Highlighting objects in your model that have links to external requirements
- Viewing information about a requirements link
- Navigating from a model object to its associated requirement
- Filtering requirements highlighting based on specified keywords

Having a Simulink Verification and Validation license enables you to perform the following additional tasks, using the Requirements Management Interface (RMI):

- Adding new requirements
- Changing existing requirements
- Deleting existing requirements
- Applying user tags to requirements
- Creating reports about requirements links in your model
- Checking the validity of the links between the model objects and the requirements documents

### Highlight Requirements in a Model

You can highlight a model to identify which objects in the model have links to requirements in external documents. Both the Simulink Editor and the Model Explorer provide this capability.

- “Highlight a Model Using the Simulink Editor” on page 12-62
- “Highlight a Model Using the Model Explorer” on page 12-63

---

**Note:** If your model contains a Model block whose referenced model contains requirements, those requirements are not highlighted. If you have Simulink Verification and Validation, you can view this information only in requirements reports. To generate requirements information for referenced models and then see highlighted snapshots of those requirements, follow the steps in “Report for Requirements in Model Blocks” (Simulink Verification and Validation).

---

### Highlight a Model Using the Simulink Editor

If you are working in the Simulink Editor and want to see which model objects in the `slvndemo_fuelsys_officereq` model have requirements, follow these steps:

- 1 Open the example model:

```
slvndemo_fuelsys_officereq
```

- 2 Select **Analysis > Requirements Traceability > Highlight Model**.

Two types of highlighting indicate model objects with requirements:

- Yellow highlighting indicates objects that have requirements links for the object itself.



- Orange outline indicates objects, such as subsystems, whose child objects have requirements links.

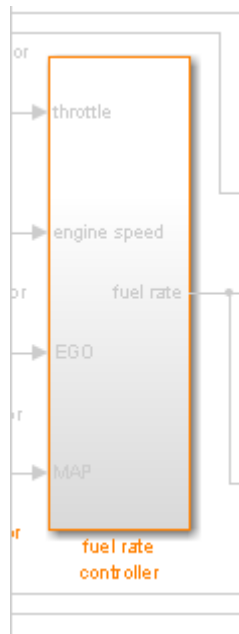

Objects that do not have requirements are colored gray.



- 3 To remove the highlighting from the model, select **Analysis > Requirements Traceability > Unhighlight Model**. Alternatively, you can right-click anywhere in the model, and select **Remove Highlighting**.

While a model is highlighted, you can still manage the model and its contents.

### Highlight a Model Using the Model Explorer

If you are working in Model Explorer and want to see which model objects have requirements, follow these steps:

- 1 Open the example model:  
`slvndemo_fuelsys_officereq`
- 2 Select **View > Model Explorer**.
- 3 To highlight all model objects with requirements, click the **Highlight items with requirements on model** icon ().

The Simulink Editor window opens, and all objects in the model with requirements are highlighted.

---

**Note:** If you are running a 64-bit version of MATLAB, when you navigate to a requirement in a PDF file, the file opens at the beginning of the document, not at the specified location.

---

### View Information About a Requirements Link

Using Simulink, you can view detailed information about a requirements link, such as identifying the location and type of document that contains the requirement.

---

**Note:** You can only modify the requirements information if you have a Simulink Verification and Validation license.

---

For example, to view information about the requirements link from the MAP Sensor block in the `slvndemo_fuelsys_officereq` example model, follow these steps:

- 1 Open the example model:  
`slvndemo_fuelsys_officereq`
- 2 Right-click the MAP sensor block, and select **Requirements > Edit/Add Links**.

The Requirements dialog box opens and displays the following information about the requirements link:

- The description of the link (which is the actual text of the requirement).



- The Microsoft Excel® workbook named `slvndemo_FuelSys_TestScenarios.xlsx`, which contains the linked requirement.
- The requirements text, which appears in the named cell `Simulink_requirement_item_2` in the workbook.
- The user tag `test`, which is associated with this requirement.

## Navigate to Requirements from a Model

### Navigate from the Model Object

You can navigate directly from a model object to that object's associated requirement. When you take these steps, the external requirements document opens in the application, with the requirements text highlighted.

- 1 Open the example model:  
`slvndemo_fuelsys_officereq`
- 2 Open the fuel rate controller subsystem.
- 3 To open the linked requirement, right-click the Airflow calculation subsystem and select **Requirements Traceability > 1. “Mass airflow estimation”**.

The Microsoft Word document `slvndemo_FuelSys_DesignDescription.docx`, opens with the section **2.1 Mass airflow estimation** selected.

---

**Note:** If you are running a 64-bit version of MATLAB, when you navigate to a requirement in a PDF file, the file opens at the top of the page, not at the bookmark location.

---

### Navigate from a System Requirements Block

Sometimes you want to see all the requirements links at a given level of the model hierarchy. In such cases, you can insert a System Requirements block to collect all requirements links in a model or subsystem. The System Requirements block lists requirements links for the model or subsystem in which it resides; it does not list requirements links for model objects inside that model or subsystem, because those are at a different level of the model hierarchy.

In the following example, you insert a System Requirements block at the top level of the `slvndemo_fuelsys_officereq` model, and navigate to the requirements using the links inside the block.

- 1 Open the example model:

`slvndemo_fuelsys_officereq`

- 2 In the Simulink Editor, select **Analysis > Requirements Traceability > Highlight Model**.
- 3 Open the fuel rate controller subsystem.

The Airflow calculation subsystem has a requirements link.

- 4 Open the Airflow calculation subsystem.
- 5 In the Simulink Editor, select **View > Library Browser**.
- 6 On the **Libraries** pane, select **Simulink Verification and Validation**.

This library contains only one block—the System Requirements block.

- 7 Drag a System Requirements block into the Airflow calculation subsystem.

The RMI software collects and displays any requirements links for that subsystem in the System Requirements block.

- 8 In the System Requirements block, double-click **1. “Mass airflow subsystem”**.

The Microsoft Word document, `slvndemo_FuelSys_DesignDescription.docx`, opens, with the section **2.1 Mass airflow estimation** selected.

### Filter Requirements in a Model

- “Filtering Requirements Highlighting by User Tag” on page 12-66
- “Filtering Options for Highlighting Requirements” on page 12-67

#### Filtering Requirements Highlighting by User Tag

Some requirements links in your model can have one or more associated user tags. *User tags* are keywords that you create to categorize a requirement, for example, **design** or **test**.

For example, in the `slvndemo_fuelsys_officereq` model, the requirements link from the MAP sensor block has the user tag **test**.

To highlight only all the blocks that have a requirement with the user tag `test`:

- 1 Open the example model:

`slvndemo_fuelsys_officereq`

- 2 In the Simulink Editor, select **Analysis > Requirements > Settings**.

The Requirements Settings dialog box opens. If you do not have a Simulink Verification and Validation license, the **Filters** tab is the only option available.

By default, your model has no requirements filtering enabled.

- 3 Select **Filter links by user tags when highlighting and reporting requirements**.
- 4 In the **Include links with any of these tags** text box, delete `design`, and enter `test`.
- 5 Press **Enter**.
- 6 Highlight the `slvndemo_fuelsys_officereq` model for requirements. Select **Analysis > Requirements > Highlight Model**.

In the top-level model, only the MAP sensor block and the Test inputs block are highlighted.

- 7 To disable the filtering by user tag, select **Analysis > Requirements > Settings**, and clear **Filter links by user tags when highlighting and reporting requirements**.

The model highlighting updates immediately.

### Filtering Options for Highlighting Requirements

On the **Filters** tab, you select options that designate which objects with requirements are highlighted. The following table describes these settings, which apply to all requirements in your model for the duration of your MATLAB session.

Option	Description
<b>Filter links by user tags when highlighting and reporting requirements</b>	Enables filtering for highlighting and reporting, based on specified user tags.
<b>Include links with any of these tags</b>	Highlights all objects whose requirements match at least one of the specified user

Option	Description
	tags. The tag names must match exactly. Separate multiple user tags with commas or spaces.
<b>Exclude links with any of these tags</b>	Excludes from the highlighting all objects whose requirements match at least one of the specified user tags. The tag names must match exactly. Separate multiple user tags with commas or spaces.
<b>Apply same filters in context menus</b>	Disables navigation links in context menus for all objects whose requirements do not match at least one of the specified user tags.
<b>Under Link type filters, Disable DOORS surrogate item links in context menus</b>	Disables links to IBM® Rational® DOORS® surrogate items from the context menus when you right-click a model object. This option does not depend on current user tag filters.

# Trace Connections Using Interface Display

## In this section...

“How Interface Display Works” on page 12-69

“Trace Connections in a Subsystem” on page 12-69

## How Interface Display Works

In the Simulink Editor, you can turn on and off the display of interfaces in a model. When you are building large, complex models, you can connect or add signal lines between blocks or buses that are at different levels. The interface view allows you to trace signals through the nested levels. This capability helps you to:

- Identify inputs and outputs.
- Trace signal lines and bus elements to sources and terminations.
- Annotate signal characteristics such as data type, dimensions, and sample time.
- View units associated with signals, where applicable.

When you build a model, transition block pairs such as Inport and Outport and From and Goto help you to simplify connections of the crossovers among many signal lines. The interface view enables you to trace the hand-off and receipt between such blocks by way of colored highlights.

## Trace Connections in a Subsystem

This example shows how to use the display of model interfaces to examine, trace, and understand the flow of signals and buses. This model propagates bus signals into referenced models.

- 1 Open the model `sldemo_mdhref_counter_bus`.

The `counter_bus_input` port channels the data and saturation limits of the counter to count and sets the upper and lower limit values. The `increment_bus_input` port channels a bus signal to change the increment and reset the counter.

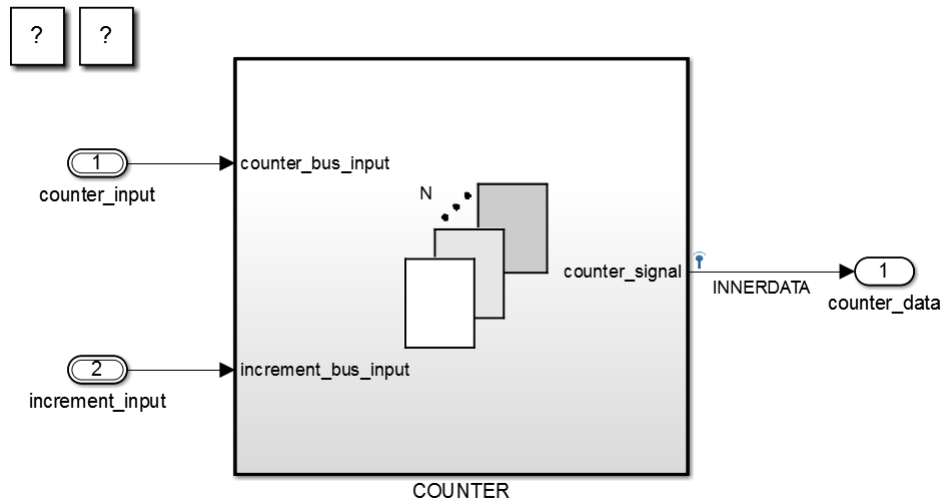

- 2 Select **Display > Interface** to enable the interface view.

**Tip:** Use the perspectives control in the lower-right corner of the model to toggle the display of interfaces.

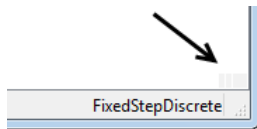

The three bars next to the `counter_input` and `increment_input` interfaces indicate the bus input signals. The single bars indicate data lines, such as counts per second, or command lines, such as reset, to start a new counting sequence. The three bars next to `limits` indicate that bus signals are nested inside the `COUNTER` subsystem.

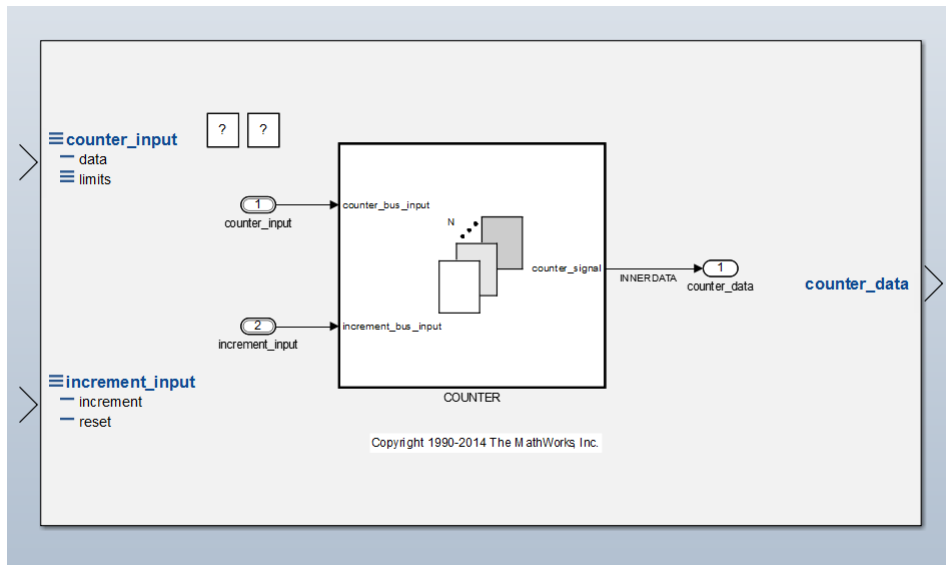

- 3 Under `counter_input`, click `data`.

The path for the data appears in blue. The COUNTER subsystem is highlighted, indicating the path continues within it.

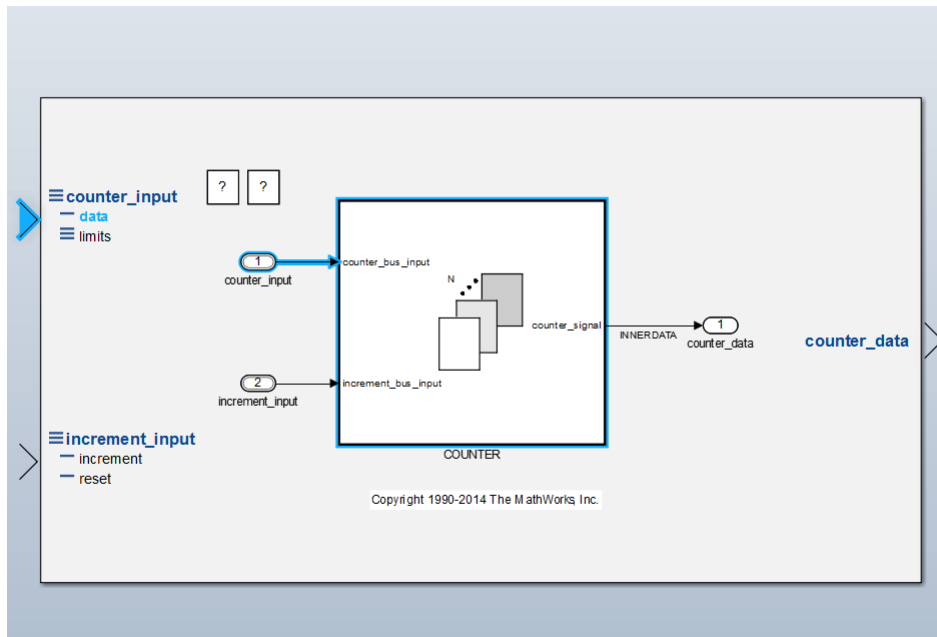

4 Double-click the COUNTER subsystem.

The continuation of the path for the data signal appears in blue.

5 Select **Simulation > Update Diagram**.

---

**Note:** This model requires values from a parent model to simulate completely.

---

The `counter_signal` interface displays these signal attributes, which help you to synchronize signals between blocks during simulation:

- Data type: int32 (signed 32-bit integer)
- Dimensions: (2) (a 1-D Simulink representation of a scalar)
- Sample time: Ts:D1 (a discrete sample time of D1, which is the highest speed)

In addition, when you update the diagram with interfaces displayed, the model displays the color code for sample time at each interface. For example, this model displays a red bar at each interface to indicate a sample time of D1.



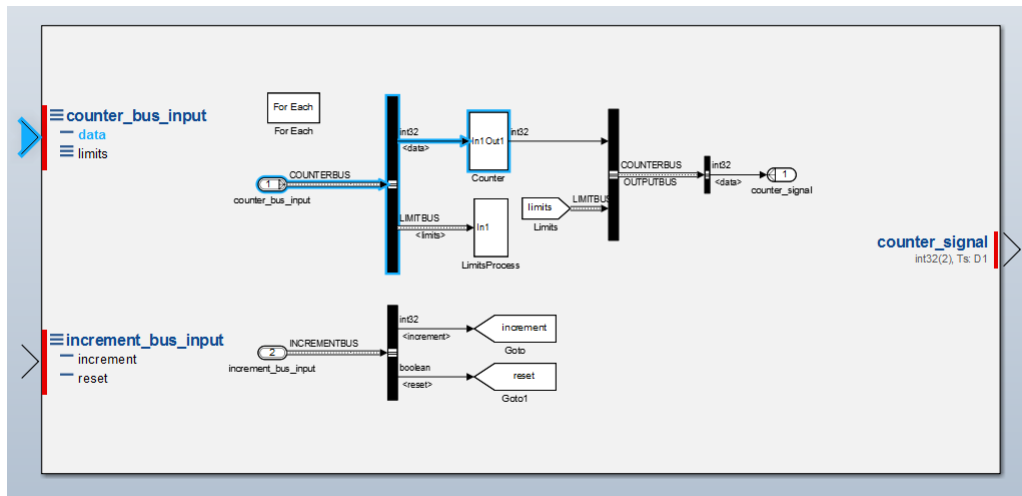

**Tip:** To display a legend of the meaning of sample time colors, select **Display > Sample Time > Colors**.

- Click the `counter_signal` output interface to see the output of the bus outlined in blue, where the path ends.

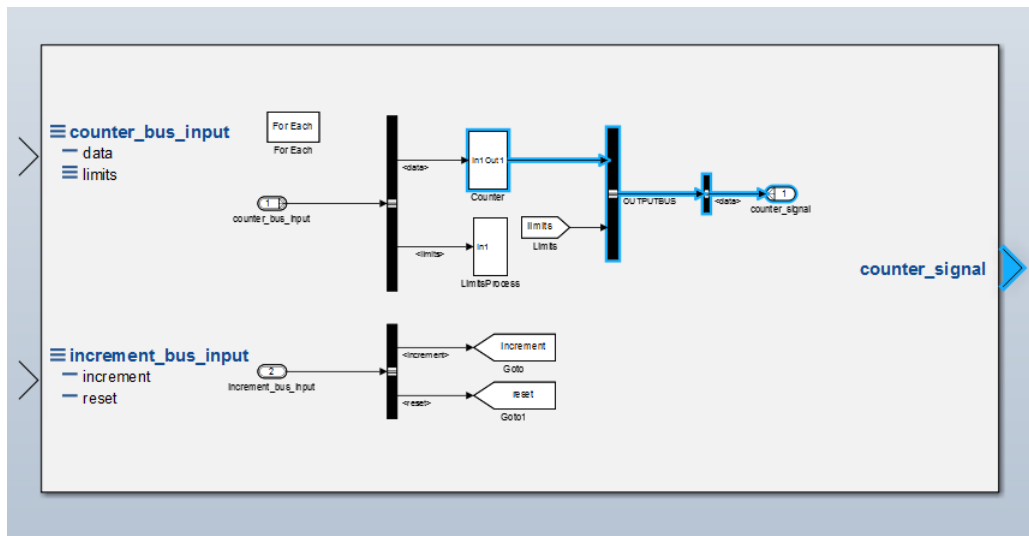

- 7 If you want to print this diagram with the interfaces displayed, select **File > Print > Print**.

When signals in your model have units associated with them, you see the units in the interface view. For example, in the model `sldemo_metro`, the `Metronome1` subsystem shows units for inputs and outputs of the subsystem in the interface view.

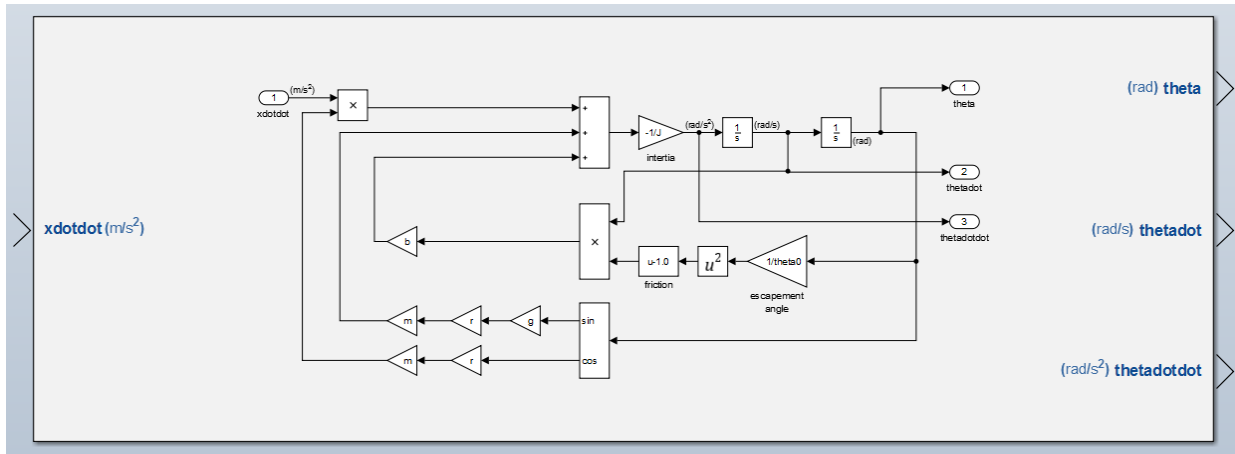

### More About

- “Interface Design” on page 21-13
- “What Is Sample Time?” on page 7-2
- “Buses” on page 63-3

# Managing Model Configurations

---

- “About Model Configurations” on page 13-2
- “Multiple Configuration Sets in a Model” on page 13-3
- “Share a Configuration for Multiple Models” on page 13-4
- “Share a Configuration Across Referenced Models” on page 13-6
- “Manage a Configuration Set” on page 13-11
- “Manage a Configuration Reference” on page 13-18
- “About Configuration Sets” on page 13-25
- “About Configuration References” on page 13-28
- “Model Configuration Command Line Interface” on page 13-32

## About Model Configurations

A model configuration is a named set of values for the parameters of a model. It is referred to as a *configuration set*. Every new model is created with a default configuration set, called `Configuration`, that initially specifies default values for the model parameters. You can change the default values for new models by setting the Model Configuration Preferences. For more information, see “Model Configuration Pane”.

You can subsequently create and modify additional configuration sets and associate them with the model. The configuration sets associated with a model can specify different values for any or all configuration parameters. For more information, see “About Configuration Sets” on page 13-25. For examples on how to use configuration sets, see:

- “Multiple Configuration Sets in a Model” on page 13-3
- “Manage a Configuration Set” on page 13-11

By default, a configuration set resides within a single model so that only that model can use it. Alternatively, you can store a configuration set independently, so that other models can use it. A configuration set that exists outside any model is a *freestanding configuration set*. Each model that uses a freestanding configuration set defines a *configuration reference* that points to the freestanding configuration set. A freestanding configuration set allows you to single-source a configuration set for several models. For more information, see “About Configuration References” on page 13-28. For examples on how to use configuration references, see:

- “Share a Configuration for Multiple Models” on page 13-4
- “Share a Configuration Across Referenced Models” on page 13-6
- “Manage a Configuration Reference” on page 13-18

### More About

- “Configuration Parameters Dialog Box Overview”
- “Solver Pane”
- “Hardware Implementation Pane”

## Multiple Configuration Sets in a Model

A model can include many different configuration sets. This capability is useful if you want to compare the difference in simulation output after changing the values of several parameters. Attaching additional configuration sets allows you to quickly switch the active configuration.

- 1** To create additional configuration sets in your model, in the Model Explorer, select your model node in the Model Hierarchy pane and do one of the following:
  - Right-click the model node and select **Configuration > Add Configuration**.
  - Right-click an existing configuration set. In the context menu, select **Copy**.
- 2** To import a previously saved configuration set, right-click the model node and select **Configuration > Import**. In the Import Configuration From File dialog box, select a configuration file.
- 3** To modify the newly added configuration set, in the Model Hierarchy pane, select the configuration node. In the **Contents** pane, select a component, and then modify any parameters which are displayed in the right pane.
- 4** To make the new configuration set the active configuration, in the configuration set context menu, select **Activate**. In the Model Hierarchy pane, the new configuration set name is now displayed as **(Active)**.
- 5** To simulate your model using a different configuration set, switch the active configuration by repeating step 4.

### Related Examples

- “Manage a Configuration Set” on page 13-11
- “Model Configuration Command Line Interface” on page 13-32

## Share a Configuration for Multiple Models

With configuration references, multiple models can share a configuration set. To share a configuration set between models, store the configuration set as a configuration set object in the base workspace. Then create a configuration reference in your model that references the configuration set object. You can create configuration references in other models that also point to the same configuration set object.

---

**Note:** Before saving and closing your models, follow the instructions to “Save a Referenced Configuration Set” on page 13-23. If you do not save the referenced configuration set from the base workspace, when you reopen your model, the configuration reference is unresolved.

---

### Convert an Existing Configuration Set to a Configuration Reference

To convert an existing configuration set in your model to a configuration reference:

- 1 Open the Model Explorer.
- 2 In the Model Hierarchy pane, right-click the active configuration set to share.
- 3 In the configuration set context menu, select **Convert to Configuration Reference**, which opens a dialog box. Alternatively, you can right-click the model node and select **Configuration > Convert Active Configuration to Reference**.
- 4 In the Convert Active Configuration to Reference dialog box, use the default configuration set object name, `configSetObj`, or type a name.
- 5 Click **OK**, which creates a configuration reference in the model and a configuration set object in the base workspace. The configuration reference points to the configuration set object, which has the same values as the original active configuration set. The configuration reference name in the Model Hierarchy is now marked as *(Active)*.
- 6 To change the name of the configuration reference, select it in the Model Hierarchy, and in the right pane, change the **Name** field.

### Create a Configuration Reference in Another Model

To share the preceding configuration set, which is stored as `configSetObj` in the base workspace, create a configuration reference in another model:

- 1 In the Model Hierarchy pane, right-click the model node.
- 2 In the context menu, select **Configuration > Add Configuration Reference**.
- 3 The Create Configuration Reference dialog box opens. Specify the name of the configuration set object, `configSetObj`, in the base workspace.
- 4 To make the new configuration reference the active configuration, in the Model Hierarchy, right-click the configuration reference. In the context menu, select **Activate**.

Both models now contain a configuration reference that points to the same configuration set object in the base workspace. To set up your model to automatically load the configuration set object, see “Callbacks for Customized Model Behavior” on page 4-46.

## Related Examples

- “Manage a Configuration Reference” on page 13-18
- “Model Configuration Command Line Interface” on page 13-32
- “Share a Configuration Across Referenced Models” on page 13-6

## More About

- “About Configuration References” on page 13-28

## Share a Configuration Across Referenced Models

This example shows how to share the same configuration set for the top model and referenced models in a model reference hierarchy. You can use a configuration reference in each of the models to reference the same configuration set object in the base workspace.

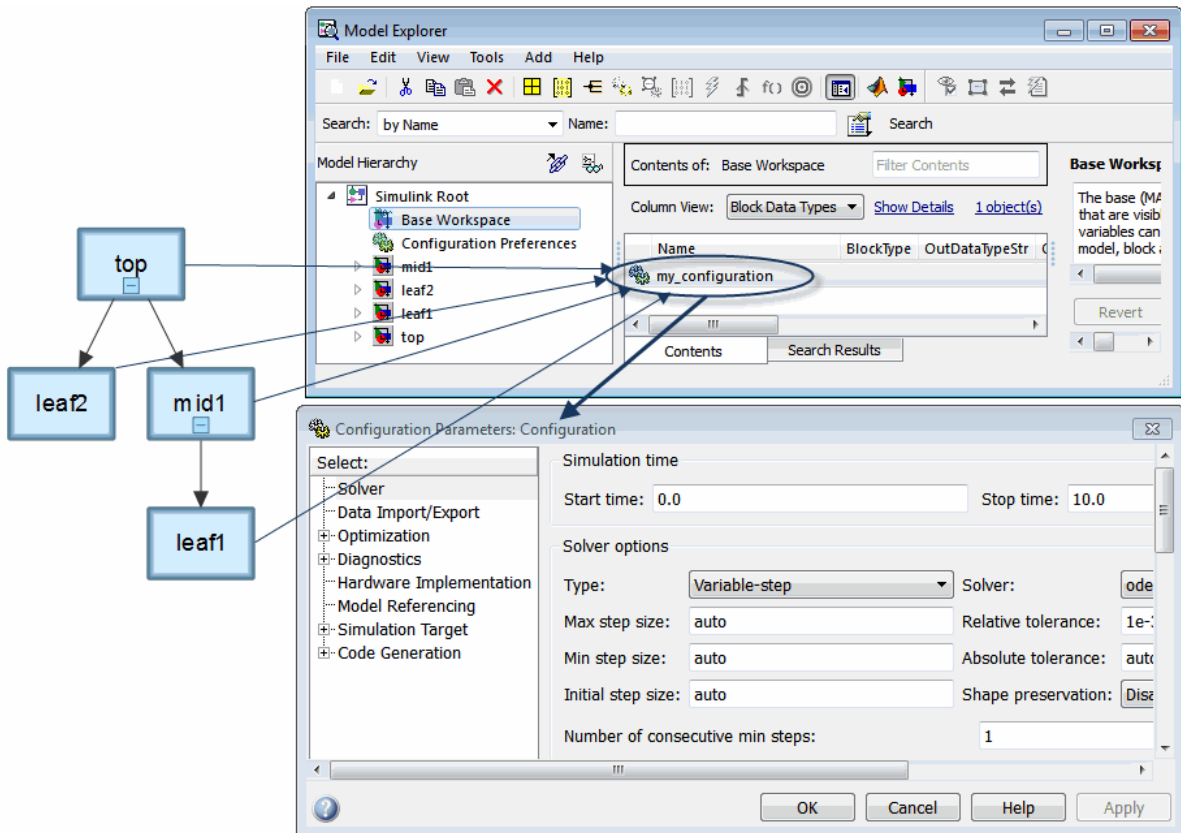

In the diagram, each model shown in the Model Dependency Viewer specifies the configuration reference, `my_configuration`, as its active configuration set. `my_configuration` points to the freestanding configuration set, `Configuration`. Therefore, the parameter values in `Configuration` apply to all four models. Any parameter change in `Configuration` applies to all four models.



## Convert Configuration Set to Configuration Reference

In the top model, you must convert the active configuration set to a configuration reference:

- 1 Open the `sldemo_mdhref_depgraph` model and the Model Explorer.
- 2 In the Model Hierarchy pane, expand the top model, `sldemo_mdhref_depgraph`. In the list, right-click **Configuration (Active)**. In the context menu, select **Convert to Configuration Reference**.
- 3 In the **Configuration set name** field, specify a name for the configuration set object, or use the default name, `configSetObj`. This configuration set object is stored in the base workspace.
- 4 Optionally, you can save the configuration set to a MAT-file. Select **Save configuration set to file**. This enables the **File name** parameter.
- 5 In the **File name** field, specify a name for the MAT-file.

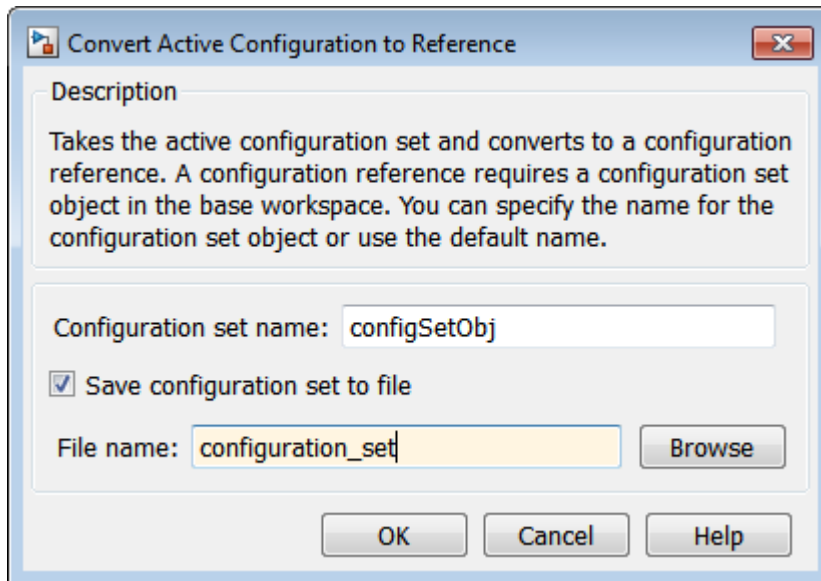

- 6 Click **OK**.

The original configuration set is now stored as a configuration set object, `configSetObj`, in the base workspace. The configuration set is also stored in a MAT-file, `configuration_set.mat`. The active configuration for the top model is now a

configuration reference. This configuration reference points to the configuration set object in the base workspace.

### Propagate a Configuration Reference

Now that the top model contains an active configuration reference, you can propagate this configuration reference to all of the child models. Propagation creates a copy of the top model configuration reference in each referenced model. For each referenced model, the configuration reference is now the active configuration. The configuration references point to the configuration set object, `configSetObj`, in the base workspace.

- 1 In the Model Explorer, in the Model Hierarchy pane, expand the `sldemo_md1ref_depgraph` node.

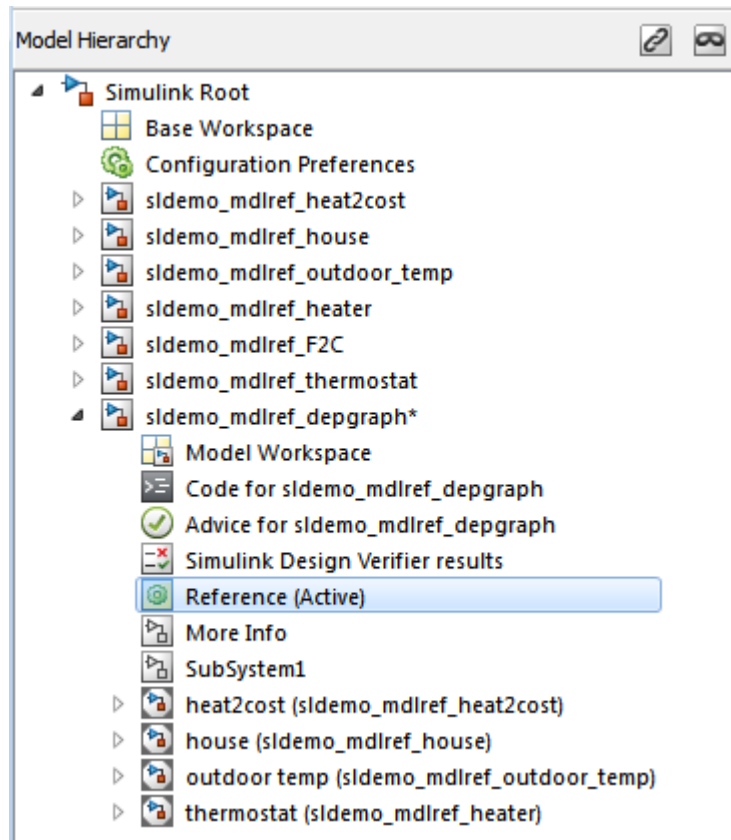

- 2 Right-click the active configuration reference, **Reference (Active)**. In the context menu, select **Propagate to Referenced Models**.
- 3 In the Configuration Reference Propagation dialog box, select the check box for each referenced model. In this example, they are already selected.
- 4 Verify that your current folder is a writable folder. The propagation mechanism saves the original configuration parameters for each referenced model so that you can undo the propagation. Click **Propagate**.
- 5 In the Propagation Confirmation dialog box, click **OK**.
- 6 In the Configuration Reference Propagation dialog box, the Propagation Report is updated and the **Status** for each referenced model is marked as **Converted**.

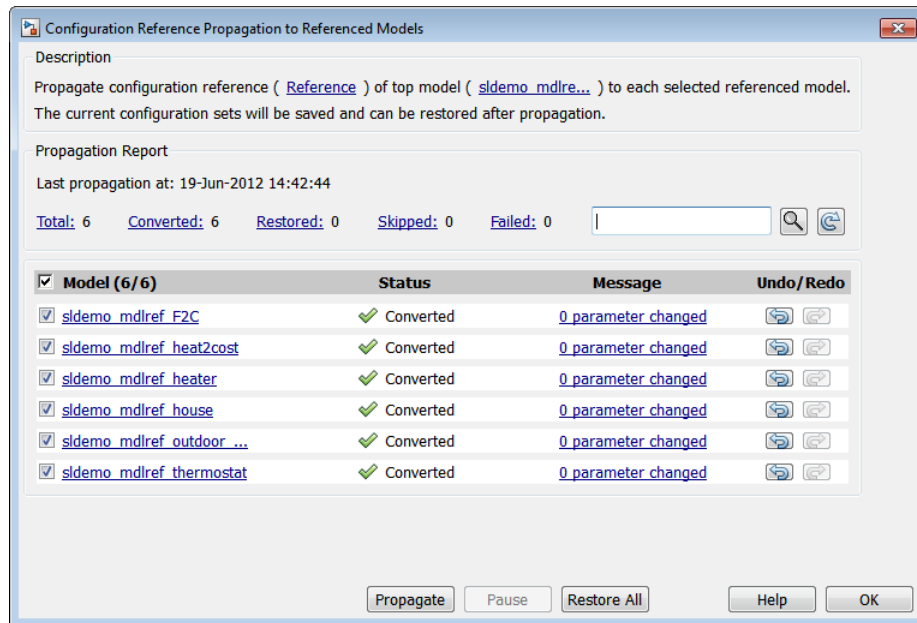

## Undo a Configuration Reference Propagation

After propagating a configuration reference from a top model to the referenced models, you can undo the propagation for all referenced models by clicking **Restore All**. If you want to undo the propagation for individual referenced models, in the **Undo/Redo** column, click the **Undo** button. The Propagation Report is updated and the **Status** for the referenced model is set to **Restored**.

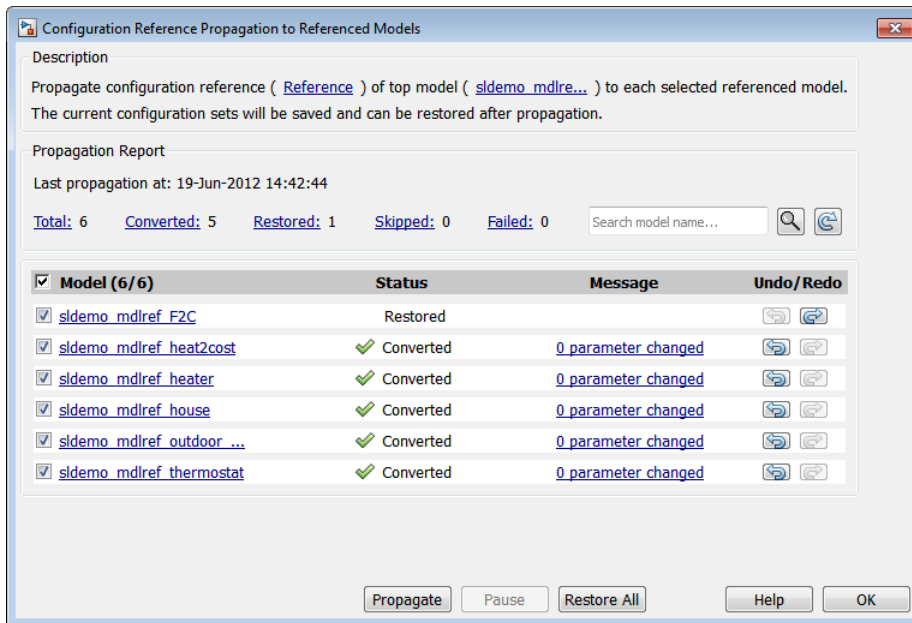

## Related Examples

- “Manage a Configuration Reference” on page 13-18
- “Model Configuration Command Line Interface” on page 13-32

## More About

- “About Configuration References” on page 13-28

## Manage a Configuration Set

### In this section...

- “Create a Configuration Set in a Model” on page 13-11
- “Create a Configuration Set in the Base Workspace” on page 13-11
- “Open a Configuration Set in the Configuration Parameters Dialog Box” on page 13-12
- “Activate a Configuration Set” on page 13-13
- “Set Values in a Configuration Set” on page 13-13
- “Copy, Delete, and Move a Configuration Set” on page 13-13
- “Save a Configuration Set” on page 13-14
- “Load a Saved Configuration Set” on page 13-15
- “Copy Configuration Set Components” on page 13-15
- “Compare Configuration Sets” on page 13-16

### Create a Configuration Set in a Model

- 1 Open the Model Explorer.
- 2 In the Model Hierarchy pane, select the model name.
- 3 You can create a new configuration set in any of the following ways:
  - From the **Add** menu, select **Configuration**.
  - On the toolbar, click the **Add Configuration** button .
  - In the Model Hierarchy pane, right-click an existing configuration set and copy and paste the configuration set.

### Create a Configuration Set in the Base Workspace

- 1 Open the Model Explorer.
- 2 In the Model Hierarchy pane, select **Base Workspace**.
- 3 You can create a new configuration set object in the following ways:
  - From the **Add** menu, select **Configuration**

- In the toolbar, click the **Add Configuration** button 
- 4 The configuration set object appears in the Contents pane, with the default name, ConfigSet.

## Open a Configuration Set in the Configuration Parameters Dialog Box

In the Model Explorer, to open the Configuration Parameters dialog box for a configuration set, right-click the configuration set's node to display the context menu, then select **Open**. You can open the Configuration Parameters dialog box for any configuration set, whether or not it is active.

The title bar of the dialog box indicates whether the configuration set is active or inactive.

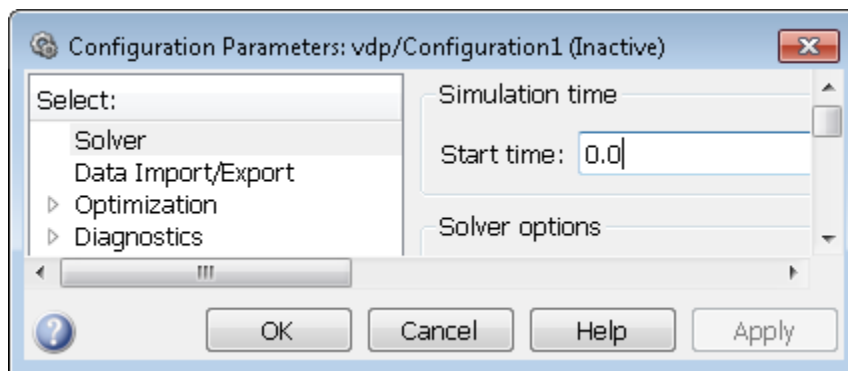
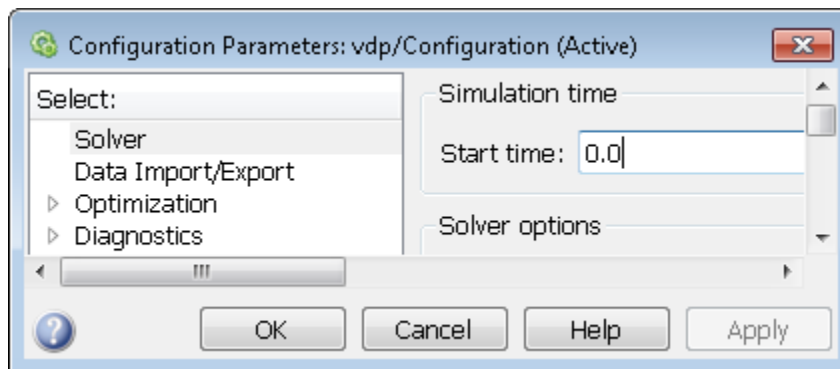

**Note:** Every configuration set has its own Configuration Parameters dialog box. As you change the state of a configuration set, the title bar of the dialog box changes to reflect the state.

---

## Activate a Configuration Set

Only one configuration set associated with a model is active at any given time. The active set determines the current values of the model parameters. You can change the active or inactive set at any time (except when executing the model). In this way, you can quickly reconfigure a model for different purposes, for example, testing and production, or apply standard configuration settings to new models.

To activate a configuration set, right-click the configuration set node to display the context menu, then select **Activate**.

## Set Values in a Configuration Set

To set the value of a parameter in a configuration set, in the Model Explorer:

- 1 In the Model Hierarchy, select the configuration set node.
- 2 In the Contents pane, select the component from where the parameter resides.
- 3 In the Dialog pane, edit the parameter value.

## Copy, Delete, and Move a Configuration Set

You can use edit commands on the Model Explorer **Edit** or context menus or object drag-and-drop operations to delete, copy, and move configuration sets among models displayed in the **Model Hierarchy** pane.

For example, to copy a configuration set from one model to another:

- 1 In the **Model Hierarchy** pane, right-click the configuration set node that you want to copy.
- 2 Select **Copy** in the configuration set context menu.
- 3 Right-click the model node in which you want to create the copy.
- 4 Select **Paste** from the model context menu.

To copy the configuration set using object drag-and-drop, hold down the right mouse button and drag the configuration set node to the node of the model in which you want to create the copy.

To move a configuration set from one model to another using drag-and-drop, hold the left mouse button down and drag the configuration set node to the node of the destination model.

---

**Note** You cannot move or delete an active configuration set from a model.

---

### Save a Configuration Set

You can save the settings of configuration sets as MATLAB functions or scripts. Using the MATLAB function or script, you can share and archive model configuration sets. You can also compare the settings in different configuration sets by comparing the MATLAB functions or scripts of the configuration sets.

To save an active or inactive configuration set from the Model Explorer:

- 1 Open the model.
- 2 Open the Model Explorer.
- 3 Save the configuration set:
  - a In the **Model Hierarchy** pane:
    - Right-click the model node and select **Configuration > Export Active Configuration Set**.
    - Right-click a configuration set and select **Export**.
    - Select the model. In the **Contents** pane, right-click a configuration set and select **Export**.
  - b In the Export Configuration Set to File dialog box, specify the name of the file and the file type. If you specify a `.m` extension, the file contains a function that creates a configuration set object. If you specify a `.mat` extension, the file contains a configuration set object.



---

**Note:** Do not specify the name of the file to be the same as a model name. If the file and model have the same name, the software cannot determine which file contains the configuration set object when loading the file.

---

- c Click **Save**. The Simulink software saves the configuration set.

## Load a Saved Configuration Set

You can load configuration sets that you previously saved as MATLAB functions or scripts.

To load a configuration set from the Model Explorer:

- 1 Open the model.
- 2 Open the Model Explorer.
- 3 In the **Model Hierarchy** pane, right-click the model and select **Configuration > Import**.
- 4 In the Import Configuration Set From File dialog box, select the `.m` file that contains the function to create the configuration set object, or the `.mat` file that contains the configuration set object.
- 5 Click **Open**. The Simulink software loads the configuration set.

---

### Note:

- If you load a configuration set object that contains an invalid custom target, the software sets the “**System target file**” (**Simulink Coder**) parameter to `ert.tlc`.
  - If you load a configuration set that contains a component that is not available on your system, the parameters in the missing component are reset to their default values.
- 
- 6 Optionally, activate the configuration set. For more information, see “Activate a Configuration Set” on page 13-13.

## Copy Configuration Set Components

To copy a configuration set component from one configuration set to another:

- 1 Select the component in the Model Explorer **Contents** pane.
- 2 From either the Model Explorer **Edit** menu or the component context menu, select **Copy**.
- 3 Select the configuration set into which you want to copy the component.
- 4 From either the Model Explorer **Edit** menu or the component context menu, select **Paste**.

---

**Note** The copy replaces the component of the same name in the destination configuration set. For example, if you copy the Solver component of configuration set A and paste it into configuration set B, the copy replaces the existing Solver component in B.

---

## Compare Configuration Sets

You can visually compare two configuration sets using the `visdiff` function. This function opens the Comparison Tool and presents the differences between the two files. If you have Simulink Report Generator, you can select a pair of models to compare XML text files generated from them. See “Select Simulink Models for XML Comparison” (Simulink Report Generator) and “View Changes in Model Configuration Parameters” (Simulink Report Generator) in the Simulink Report Generator documentation.

- 1 Get the first configuration set for a model.  

```
cs = getConfigSet('model_name','config_set_1_name');
```
- 2 Save the configuration set to a MAT-file.  

```
save('configSet1.mat','cs');
```
- 3 Get the second configuration set for the model.  

```
cs = getConfigSet('model_name','config_set_2_name');
```
- 4 Save the second configuration set to a MAT-file.  

```
save('configSet2.mat','cs');
```
- 5 Compare the files.  

```
visdiff('configSet1.mat','configSet2.mat');
```

For more information on using the Comparison Tool to compare MAT-files, see “Comparing MAT-Files” (MATLAB).

## **Related Examples**

- “Model Configuration Command Line Interface” on page 13-32
- “Multiple Configuration Sets in a Model” on page 13-3

## **More About**

- “About Configuration Sets” on page 13-25
- “Model Configuration Pane”

## Manage a Configuration Reference

### In this section...

“Create and Attach a Configuration Reference” on page 13-18

“Resolve a Configuration Reference” on page 13-19

“Activate a Configuration Reference” on page 13-21

“Manage Configuration Reference Across Referenced Models” on page 13-22

“Change Parameter Values in a Referenced Configuration Set” on page 13-23

“Save a Referenced Configuration Set” on page 13-23

“Load a Saved Referenced Configuration Set” on page 13-24

### Create and Attach a Configuration Reference

To use a configuration reference, it must point to freestanding configuration set. Create a freestanding configuration set before creating a configuration reference, see “Create a Configuration Set in the Base Workspace” on page 13-11.

To create a configuration reference:

- 1 In the Model Explorer, in the Model Hierarchy pane, select the model.
- 2 Click the **Add Reference** tool  or select **Add > Configuration Reference**. The Create Configuration Reference dialog box opens.
- 3 Specify the **Configuration set name** of the configuration set object in the base workspace to be referenced.
- 4 Click **OK**. If you chose to create a configuration reference without first creating a configuration set object, a dialog box opens asking if you would like to continue. If you choose:
  - **Yes**, an unresolved configuration reference is created. For more information, see “Unresolved Configuration References” on page 13-29. Follow the instructions in “Resolve a Configuration Reference” on page 13-19.
  - **No**, then the configuration reference is not created. Follow the instructions in “Create a Configuration Set in the Base Workspace” on page 13-11, and then return to step 1 above.

- 5 A new configuration reference appears in the Model Hierarchy under the selected model. The default name of the new reference is **Reference**.

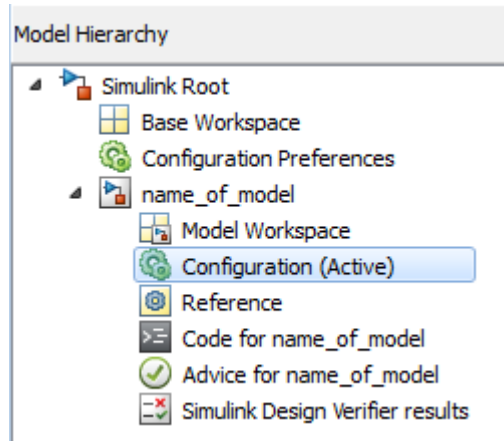

## Resolve a Configuration Reference

An unresolved configuration reference is a configuration reference that is not pointing to a valid configuration set object.

To resolve a configuration reference:

- 1 In the Model Hierarchy pane, select the unresolved configuration reference or right-click the configuration reference, and select **Open** from the context menu.

The Configuration Reference dialog box opens in the Dialog pane or a separate window.

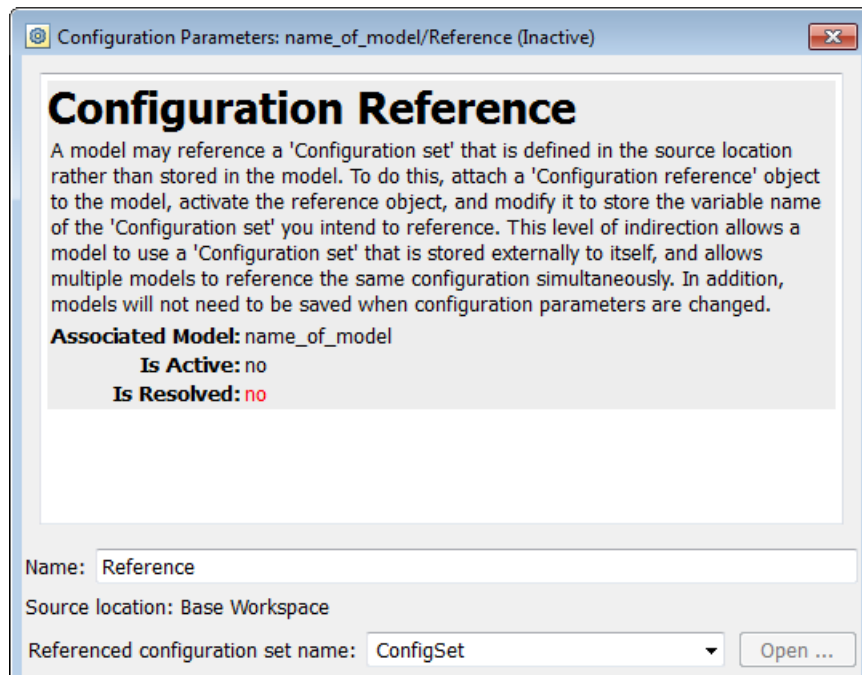

- 2 Specify the **Referenced configuration** set to be a configuration set object already in the base workspace. If one does not exist, see “Create a Configuration Set in the Base Workspace” on page 13-11.

---

**Tip:** Do not specify the name of a configuration reference. If you nest a configuration reference, an error occurs.

---

- 3 Click **OK** or **Apply**.

If you specified a Referenced configuration that exists in the base workspace, the **Is Resolved** field in the dialog box changes to **yes**.

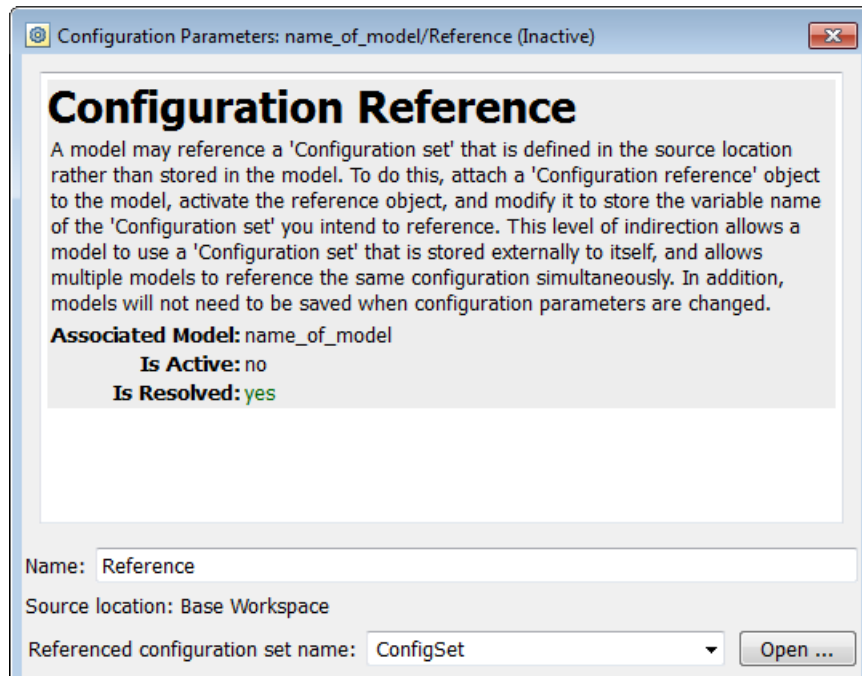

## Activate a Configuration Reference

After you create a configuration reference and attach it to a model, you can activate it so that it is the active configuration.

- In the GUI, from the context menu of the configuration reference, select **Activate**.
- From the API, execute `setActiveConfigSet`, specifying the configuration reference as the second argument.

When a configuration reference is active, the **Is Active** field of the Configuration Reference dialog box changes to **yes**. Also, the Model Explorer shows the name of the reference with the suffix (**Active**).

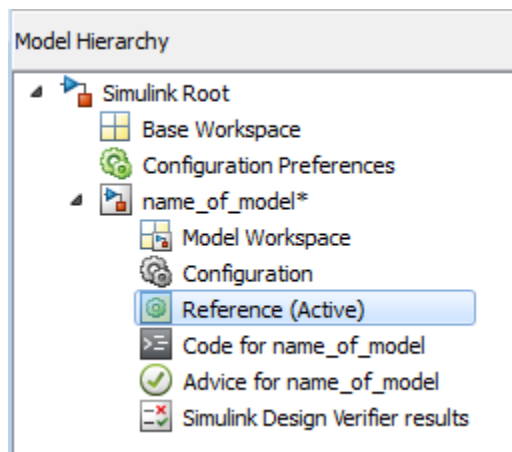

The freestanding configuration set of the active reference now provides the configuration parameters for the model.

## Manage Configuration Reference Across Referenced Models

In a model hierarchy, you can share a configuration reference across referenced models. Using the Configuration Reference Propagation dialog box, you can propagate a configuration reference of a top model to an individual referenced model or to all referenced models in the model hierarchy. The dialog box provides:

- A list of referenced models in the top model.
- The ability to select only specific referenced models for propagation.
- After propagation, the status for the converted configuration for each referenced model.
- A view of the changed parameters after the propagation.
- The ability to undo the configuration reference and restore the previous configuration settings for a referenced model.

To open the dialog box, in the Model Explorer, in the model hierarchy pane, right-click the configuration reference node of a model. In the context menu, select **Propagate to Referenced Models**. For an example, see “Share a Configuration Across Referenced Models” on page 13-6.



## Change Parameter Values in a Referenced Configuration Set

To obtain a referenced configuration set:

- 1 In the Model Hierarchy pane, select the configuration reference, or right-click the configuration reference, and select **Open** from the context menu.

The Configuration Reference dialog box appears in the Dialog pane or in a separate window.

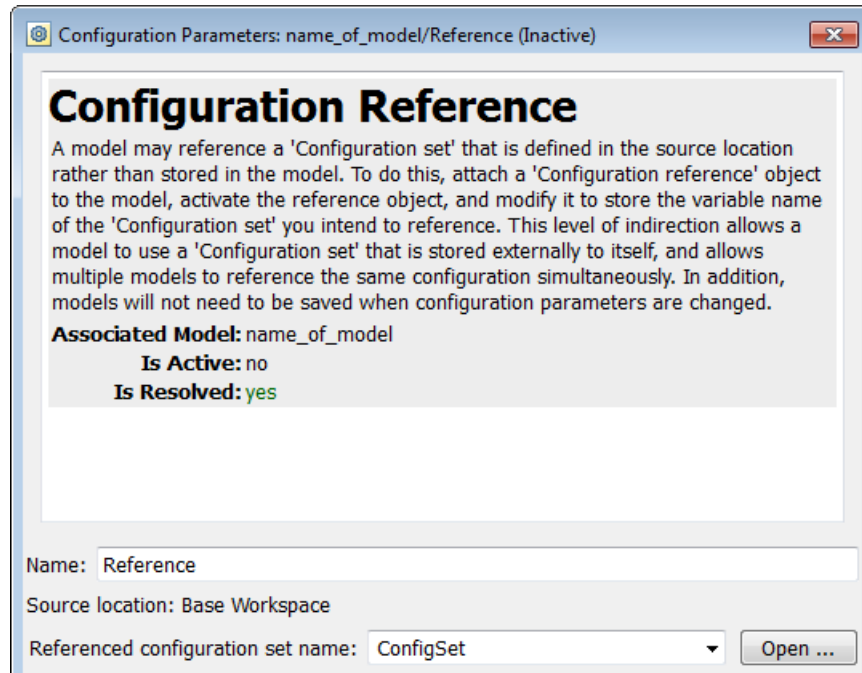

- 2 To the right of the **Referenced configuration** field, click **Open**. The Configuration Parameters dialog box opens. You can now change and apply parameter values as you would for any configuration set.

## Save a Referenced Configuration Set

If your model uses a configuration reference to specify the model configuration, before closing your model, you need to save the referenced configuration set to a MAT-file or MATLAB script.

- 1 In the Model Explorer, in the Model Hierarchy, select **Base Workspace**.
- 2 In the Contents pane, right-click the name of the referenced configuration set object.
- 3 From the context menu, select **Export Selected**.
- 4 Specify the filename for saving the configuration set as either a MAT-file or a MATLAB script.

---

**Tip:** When you reopen the model you must load the saved configuration set, otherwise, the configuration reference is unresolved. To set up your model to automatically load the configuration set object, see “Callbacks for Customized Model Behavior” on page 4-46.

---

### Load a Saved Referenced Configuration Set

If your model uses a configuration reference to specify the model configuration, you need to load the referenced configuration set from a MAT-file or MATLAB script to the base workspace.

- 1 In the Model Explorer, in the Model Hierarchy, right-click **Base Workspace**.
- 2 From the context menu, select **Import**.
- 3 Specify the filename for the saved configuration set and select OK. The configuration set object appears in the base workspace.

---

**Tip:** When you reopen the model you must load the saved configuration set, otherwise, the configuration reference is unresolved. To set up your model to automatically load the configuration set object, see “Callbacks for Customized Model Behavior” on page 4-46.

---

### Related Examples

- “Model Configuration Command Line Interface” on page 13-32
- “Share a Configuration for Multiple Models” on page 13-4
- “Share a Configuration Across Referenced Models” on page 13-6

### More About

- “About Configuration References” on page 13-28

## About Configuration Sets

In this section...
“What Is a Configuration Set?” on page 13-25
“What Is a Freestanding Configuration Set?” on page 13-26

### What Is a Configuration Set?

A configuration set comprises groups of related parameters called components. Every configuration set includes the following components:

- Solver
- Data Import/Export
- Optimization
- Diagnostics
- Hardware Implementation
- Model Referencing
- Simulation Target

Some MathWorks products that work with Simulink, such as Simulink Coder, define additional components. If such a product is installed on your system, the configuration set also contains the components that the product defines.

When you select any model configuration, the Model Configuration dialog appears in the Model Explorer **Dialog** pane. In this location, you can edit the name and description of your configuration.

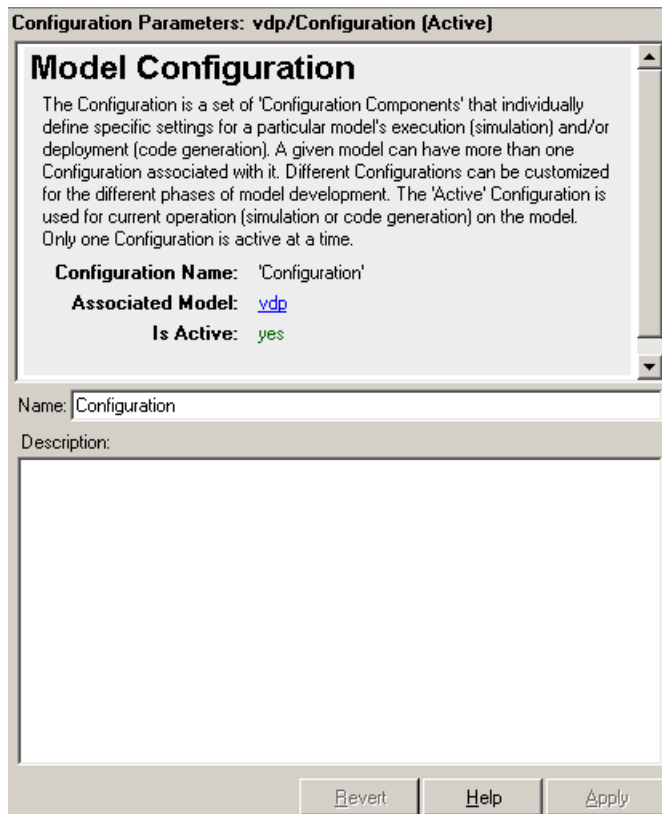

---

**Tip:** If you want to reuse the same configuration settings in new models, use a model template. See “Use Customized Settings When Creating New Models” on page 1-8.

---

## What Is a Freestanding Configuration Set?

A freestanding configuration set is a configuration set object, `Simulink.ConfigSet`, stored in the base workspace. To use a freestanding configuration set as the configuration for a model, you must create a configuration reference in the model that references it. You can create a freestanding configuration set in the base workspace in these ways:

- Create a new configuration set object.

- Copy a configuration set that resides within a model to the base workspace.
- Load a configuration set from a MAT-file.

You can store any number of configuration sets in the base workspace by assigning each set to a different MATLAB variable.

---

**Note:** Although you can store a configuration set in a model and point to it with a base workspace variable, such a configuration set is not freestanding. Using it in a configuration reference causes an error.

---

## Related Examples

- “Manage a Configuration Set” on page 13-11
- “Model Configuration Command Line Interface” on page 13-32
- “Multiple Configuration Sets in a Model” on page 13-3

## More About

- “Configuration Parameters Dialog Box Overview”
- “About Configuration References” on page 13-28

## About Configuration References

### In this section...

“What Is a Configuration Reference?” on page 13-28

“Why Use Configuration References?” on page 13-28

“Unresolved Configuration References” on page 13-29

“Configuration Reference Limitations” on page 13-29

“Configuration References for Models with Older Simulation Target Settings” on page 13-30

### What Is a Configuration Reference?

A configuration reference in a model is a reference to a configuration set object in the base workspace. A model that has a configuration reference that points to a freestanding configuration set uses that configuration set when configuration reference is active. The model then has the same configuration parameters as if the referenced configuration set resides directly in the model.

You can attach any number of configuration references to a model. Each reference must have a unique name. For more information, see “Why Use Configuration References?” on page 13-28. For an example on how to use configuration references, see “Share a Configuration for Multiple Models” on page 13-4 or “Create and Attach a Configuration Reference” on page 13-18.

---

**Tip:** Save or export the configuration set object. Otherwise, when you reopen your model the configuration reference is unresolved. To set up your model to automatically load the configuration set object, see “Callbacks for Customized Model Behavior” on page 4-46.

---

### Why Use Configuration References?

You can use configuration references and freestanding configuration sets to:

- **Assign the same configuration set to any number of models**

Each model that uses a given configuration set contains a configuration reference that points to a MATLAB variable. The value of that variable is a freestanding

configuration set. All the models share that configuration set. Changing the value of any parameter in the set changes it for every model that uses the set. Use this feature to reconfigure many referenced models quickly and ensure consistent configuration of parent models and referenced models.

- **Replace the configuration sets of any number of models without changing the model files**

When multiple models use configuration references to access a freestanding configuration set, assigning a different set to the MATLAB variable assigns that set to all models. Use this feature to maintain a library of configuration sets and assign them to any number of models in a single operation.

- **Use different configuration sets for a referenced model used in different contexts without changing the model file**

A referenced model that uses different configuration sets in different contexts contains a configuration reference that specifies the referenced model configuration set as a variable. When you call an instance of the referenced model, Simulink software assigns that variable a freestanding configuration set for the current context.

## Unresolved Configuration References

When a configuration reference does not reference a valid configuration set, the **Is Resolved** field of the Configuration Reference dialog box has the value **no**. If you activate an unresolved configuration reference, no warning or error occurs. However, an unresolved configuration reference that is active provides no configuration parameter values to the model. Therefore:

- Fields that display values known only by accessing a configuration parameter, like Stop Time in the model window, are blank.
- Trying to build the model, simulate it, generate code for it, or otherwise require it to access configuration parameter values, causes an error.

For more information, see “Resolve a Configuration Reference” on page 13-19.

## Configuration Reference Limitations

- You cannot nest configuration references. Only one level of indirection is available, so a configuration reference cannot link to another configuration reference. Each reference must specify a freestanding configuration set.

- If you activate a configuration reference when using a custom target, the `ActivateCallback` function does not trigger to notify the corresponding freestanding configuration set. Likewise, if a freestanding configuration set switches from one target to another, the `ActivateCallback` function does not trigger to notify the new target. This behavior occurs, even if an active configuration reference points to that target. For more information about `ActivateCallback` functions, see “`rtwgensettings` Structure” (Simulink Coder) in the Simulink Coder documentation.

## Configuration References for Models with Older Simulation Target Settings

Suppose that you have a nonlibrary model that contains one of these blocks:

- MATLAB Function
- Stateflow chart
- Truth Table
- Attribute Function

In R2008a and earlier, this type of nonlibrary model does not store simulation target (or `Sfun`) settings in the configuration parameters. Instead, the model stores the settings outside any configuration set.

When you load this older type of model, the simulation target settings migrate to parameters in the active configuration set.

- If the active configuration set resides internally with the model, the migration happens automatically.
- If the model uses an active configuration reference to point to a configuration set in the base workspace, the migration process is different.

The following sections describe the two types of migration for nonlibrary models that use an active configuration reference.

### Default Migration Process That Disables the Configuration Reference

Because multiple models can share a configuration set in the base workspace, loading a nonlibrary model cannot automatically change any parameter values in that configuration set. By default, these actions occur during loading of a model to ensure that simulation results are the same, no matter which version of the software that you use:



- A copy of the configuration set in the base workspace attaches to the model.
- The simulation target settings migrate to the corresponding parameters in this new configuration set.
- The new configuration set becomes active.
- The old configuration reference becomes inactive.

A warning message appears in the MATLAB Command Window to describe those actions. Although this process ensures consistent simulation results for the model, it disables the configuration reference that links to the configuration set in the base workspace.

### **Related Examples**

- “Model Configuration Command Line Interface” on page 13-32
- “Share a Configuration for Multiple Models” on page 13-4
- “Share a Configuration Across Referenced Models” on page 13-6

### **More About**

- “About Configuration Sets” on page 13-25

## Model Configuration Command Line Interface

### In this section...

“Overview” on page 13-32

“Load and Activate a Configuration Set at the Command Line” on page 13-33

“Save a Configuration Set at the Command Line” on page 13-34

“Create a Freestanding Configuration Set at the Command Line” on page 13-34

“Create and Attach a Configuration Reference at the Command Line” on page 13-35

“Attach a Configuration Reference to Multiple Models at the Command Line” on page 13-36

“Get Values from a Referenced Configuration Set” on page 13-37

“Change Values in a Referenced Configuration Set” on page 13-37

“Obtain a Configuration Reference Handle” on page 13-38

### Overview

An application programming interface (API) lets you create and manipulate configuration sets at the command line or in a script. The API includes the `Simulink.ConfigSet` and `Simulink.ConfigSetRef` classes and the following functions:

- `attachConfigSet`
- `attachConfigSetCopy`
- `detachConfigSet`
- `getConfigSet`
- `getConfigSets`
- `setActiveConfigSet`
- `getActiveConfigSet`
- `openDialog`
- `closeDialog`
- `Simulink.BlockDiagram.saveActiveConfigSet`
- `Simulink.BlockDiagram.loadActiveConfigSet`

These functions, along with the methods and properties of `Simulink.ConfigSet` class, allow you to create a script to:

- Create and modify configuration sets.
- Attach configuration sets to a model.
- Set the active configuration set for a model.
- Open and close configuration sets.
- Detach configuration sets from a model.
- Save configuration sets.
- Load configuration sets.

For examples using the preceding functions and the `Simulink.ConfigSet` class, see the function and class reference pages.

## Load and Activate a Configuration Set at the Command Line

To load a configuration set from a MATLAB function or script:

- 1 Use the `getActiveConfigSet` or `getConfigSet` function to get a handle to the configuration set that you want to update.
- 2 Call the MATLAB function or execute the MATLAB script to load the saved configuration set.
- 3 Optionally, use the `attachConfigSet` function to attach the configuration set to the model. To avoid configuration set naming conflicts, set `allowRename` to `true`.
- 4 Optionally, use the `setActiveConfigSet` function to activate the configuration set.

Alternatively, to load a configuration set at the command line and make it the active configuration set:

- 1 Open the model.
- 2 Use the `Simulink.BlockDiagram.loadActiveConfigSet` function to load the configuration set and make it active.

---

**Note:** If you load a configuration set with the same name as the:

- Active configuration set, the software overwrites the active configuration set.

- Inactive configuration set that is associated with the model, the software detaches the inactive configuration from the model.
- 

## Save a Configuration Set at the Command Line

To save an active or inactive configuration set as a MATLAB function or script:

- 1 Use the `getActiveConfigSet` or `getConfigSet` function to get a handle to the configuration set.
- 2 Use the `saveAs` method of the `Simulink.Configset` class to save the configuration set as a function or script.

Alternatively, to save the active configuration set:

- 1 Open the model.
- 2 Use the `Simulink.BlockDiagram.saveActiveConfigSet` function to save the active configuration set.

## Create a Freestanding Configuration Set at the Command Line

### Copy a Configuration Set Stored in a Model

Create a freestanding configuration set to be referenced by a configuration reference in several models. You must copy any configuration set obtained from an existing model, otherwise, `cset` refers to the existing configuration set stored in the model, rather than a new freestanding configuration set in the base workspace. For example, use one of the following:

- `cset = copy (getActiveConfigSet(model))`
- `cset = copy (getConfigSet(model, ConfigSetName))`

`model` is any open model, and `ConfigSetName` is the name of any configuration set attached to the model.

### Read a Configuration Set from a MAT-File

To use a freestanding configuration set across multiple MATLAB sessions, you can save it to a MAT-file. To create the MAT-file, you first copy the configuration set to a base workspace variable, then save the variable to the MAT-file:

```
save (workfolder/ConfigSetName.mat, cset)
```

*workfolder* is a working folder, *ConfigSetName.mat* is the MAT-file name, and *cset* is a base workspace variable whose value is the configuration set to save. When you later reopen your model, you can reload the configuration set into the variable:

```
load (workfolder/ConfigSetName.mat)
```

To execute code that reads configuration sets from MAT-files, use one of these techniques:

- The preload function of a top model
- The MATLAB startup script
- Interactive entry of load statements

## Create and Attach a Configuration Reference at the Command Line

To create and populate a configuration reference, `Simulink.ConfigSetRef`, using the API:

- 1 Create the reference:

```
cref = Simulink.ConfigSetRef
```

- 2 Change the default name if desired:

```
cref.Name = 'ConfigSetRefName'
```

- 3 Specify the referenced configuration set:

```
cref.SourceName = 'cset'
```

---

**Tip:** Do not specify the name of a configuration reference. If you nest a configuration reference, an error occurs.

---

- 4 Attach the reference to a model:

```
attachConfigSet(model, cref, true)
```

The third argument is optional and authorizes renaming to avoid a name conflict.

Using a configuration reference with an invalid configuration set, `SourceName`, generates an error and is called an unresolved configuration reference. The GUI

equivalent of `SourceName` is **Referenced configuration**. You can later use the API or GUI to provide the name of a freestanding configuration set. For more information, see “Unresolved Configuration References” on page 13-29.

---

**Note:** A `Simulink.ConfigSetRef` object cannot be saved to a MATLAB file. To save the configuration, call the `Simulink.ConfigSetRef.getRefConfigSet` method. Then save the `Simulink.ConfigSet` object that the method returns. For more information, see “Save a Configuration Set at the Command Line” on page 13-34.

---

## Attach a Configuration Reference to Multiple Models at the Command Line

After you create a configuration reference and attach it to a model, you can attach copies of the reference to any other models. Each model has its own copy of any configuration reference attached to it, just as each model has its own copy of any attached configuration set.

If you use the GUI, attaching an existing configuration reference to another model automatically attaches a distinct copy to the model. If necessary to prevent name conflict, the GUI adds or increments a digit at the end of the name of the copied reference. If you use the API, be sure to copy the configuration reference explicitly before attaching it, with statements like:

```
cref = copy (getConfigSet(model, ConfigSetRefName))  
attachConfigSet (model, cref, true)
```

If you omit the `copy` operation, `cref` becomes a handle to the original configuration reference, rather than a copy of the reference. Any attempt to use `cref` causes an error. If you omit the argument `true` to `attachConfigSet`, the operation fails if a name conflict exists.

The following example shows code for obtaining a freestanding configuration set and attaching references to it from two models. After the code executes, one of the models contains an internal configuration set and a configuration reference that points to a freestanding copy of that set. If the internal copy is an extra copy, you can remove it with `detachConfigSet`, as shown in the last line of the example.

```
open_system('model1')  
% Get handle to local cset
```

```

cset = getConfigSet('model1', 'Configuration')

% Create freestanding copy; original remains in model
cset1 = copy(cset)

% In the original model, create a configuration
% reference to the cset copy
cref1 = Simulink.ConfigSetRef
cref1.SourceName = 'cset1'

% Attach the configuration reference to the model
attachConfigSet('model1', cref1, true)

% In a second model, create a configuration
% reference to the same cset
open_system('model2')
% Rename if name conflict occurs
attachConfigSetCopy('model2', cref1, true)

% Delete original cset from first model
detachConfigSet('model1', 'Configuration')

```

## Get Values from a Referenced Configuration Set

You can use `get_param` on a configuration reference to obtain parameter values from the linked configuration set, as if the reference object were the configuration set itself. Simulink software retrieves the referenced configuration set and performs the indicated `get_param` on it.

For example, if configuration reference `cref` links to configuration set `cset`, the following operations give identical results:

```

get_param (cset, 'StopTime')
get_param (cref, 'StopTime')

```

## Change Values in a Referenced Configuration Set

By operating on only a configuration reference, you cannot change the referenced configuration set parameter values. If you execute:

```

set_param (cset, 'StopTime', '300')
set_param (cref, 'StopTime', '300')           % ILLEGAL

```

the first operation succeeds, but the second causes an error. Instead, you must obtain the configuration set itself and change it directly, using the GUI or the API.

To obtain a referenced configuration set using the API:

- 1 Follow the instructions in “Obtain a Configuration Reference Handle” on page 13-38.
- 2 Obtain the configuration set *cset* from the configuration reference *cref*:

```
cset = cref.getRefConfigSet
```

You can now use `set_param` on *cset* to change parameter values. For example:

```
set_param (cset, 'StopTime', '300')
```

---

**Tip:** If you want to change parameter values through the GUI, execute:

```
cset.openDialog
```

The Configuration Parameters dialog box opens on the specified configuration set.

---

## Obtain a Configuration Reference Handle

Most functions and methods that operate on a configuration reference take a handle to the reference. When you create a configuration reference:

```
cref = Simulink.ConfigSetRef
```

the variable *cref* contains a handle to the reference. If you do not already have a handle, you can obtain one by executing:

```
cref = getConfigSet(model, 'ConfigSetRefName')
```

*ConfigSetRefName* is the name of the configuration reference as it appears in the Model Explorer, for example, **Reference**. You specify this name by setting the **Name** field in the Configuration Reference dialog box or executing:

```
cref.Name = 'ConfigSetRefName'
```

The technique for obtaining a configuration reference handle is the same technique you use to obtain a configuration set handle. Wherever the same operation applies to both configuration sets and configuration references, applicable functions and methods overload to perform correctly with either class.



## **Related Examples**

- “Manage a Configuration Set” on page 13-11
- “Manage a Configuration Reference” on page 13-18

## **More About**

- “About Configuration Sets” on page 13-25
- “About Configuration References” on page 13-28



# Configuring Models for Targets with Multicore Processors

---

- “Concepts in Multicore Programming” on page 14-2
- “Multicore Programming with Simulink” on page 14-10
- “Implement Data Parallelism in Simulink” on page 14-14
- “Implement Task Parallelism in Simulink” on page 14-18
- “Implement Pipelining in Simulink” on page 14-21
- “Configure Your Model for Concurrent Execution” on page 14-24
- “Specify a Target Architecture” on page 14-25
- “Partition Your Model Using Explicit Partitioning” on page 14-31
- “Implicit and Explicit Partitioning of Models” on page 14-37
- “Configure Data Transfer Settings Between Concurrent Tasks” on page 14-40
- “Optimize and Deploy on a Multicore Target” on page 14-44
- “Concurrent Execution Models” on page 14-52
- “Programmatic Interface for Concurrent Execution” on page 14-53
- “Supported Targets For Multicore Programming” on page 14-55
- “Limitations with Multicore Programming in Simulink” on page 14-57

## Concepts in Multicore Programming

### In this section...

“Basics of Multicore Programming” on page 14-2

“Types of Parallelism” on page 14-3

“System Partitioning for Parallelism” on page 14-6

“Challenges in Multicore Programming” on page 14-7

### Basics of Multicore Programming

Multicore programming helps you create concurrent systems for deployment on multicore processor and multiprocessor systems. A *multicore processor system* is a single processor with multiple execution cores in one chip. By contrast, a *multiprocessor system* has multiple processors on the motherboard or chip. A multiprocessor system might include a Field-Programmable Gate Array (FPGA). An FPGA is an integrated circuit containing an array of programmable logic blocks and a hierarchy of reconfigurable interconnects. A *processing node* processes input data to produce outputs. It can be a processor in a multicore or multiprocessor system, or an FPGA.

The multicore programming approach can help when:

- You want to take advantage of multicore and FPGA processing to increase the performance of an embedded system.
- You want to achieve scalability so your deployed system can take advantage of increasing numbers of cores and FPGA processing power over time.

Concurrent systems that you create using multicore programming have multiple tasks executing in parallel. This is known as *concurrent execution*. When a processor executes multiple parallel tasks, it is known as *multitasking*. A CPU has firmware called a scheduler, which handles the tasks that execute in parallel. The CPU implements tasks using operating system threads. Your tasks can execute independently but have some data transfer between them, such as data transfer between a data acquisition module and controller for the system. Data transfer between tasks means that there is a *data dependency*.

Multicore programming is commonly used in signal processing and plant-control systems. In signal processing, you can have a concurrent system that processes multiple frames

in parallel. In plant-control systems, the controller and the plant can execute as two separate tasks. Using multicore programming helps to split your system into multiple parallel tasks, which run simultaneously, speeding up the overall execution time.

To model a concurrently executing system, see “Partitioning Guidelines” on page 14-37.

## Types of Parallelism

The concept of multicore programming is to have multiple system tasks executing in parallel. Types of parallelism include:

- Data parallelism
- Task parallelism
- Pipelining

### Data Parallelism

Data parallelism involves processing multiple pieces of data independently in parallel. The processor performs the same operation  $F()$  on each piece of data. You achieve parallelism by feeding the data in parallel.

The figure shows the timing diagram for this parallelism. The input is divided into four chunks, A, B, C, and D. The same operation  $F()$  is applied to each of these pieces and the output is  $O_A$ ,  $O_B$ ,  $O_C$ , and  $O_D$  respectively. All four tasks are identical, and they run in parallel.

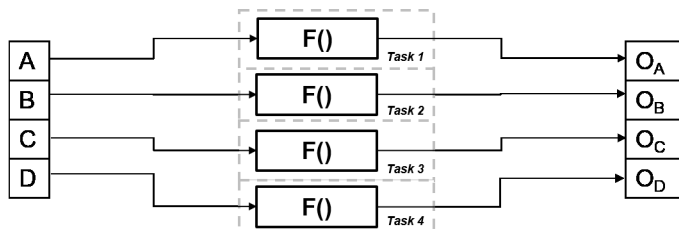

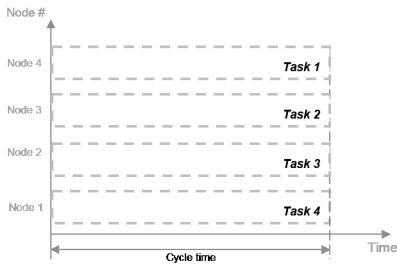

The time taken per processor cycle, known as cycle time, is

$$t = tF.$$

The total processing time is also  $tF$ , since all four tasks run simultaneously. In the absence of parallelism, all four pieces of data are processed by one processing node. The cycle time is  $tF$  for each task but the total processing time is  $4 * tF$ , since the pieces are processed in succession.

You can use data parallelism in scenarios where it is possible to process each piece of input data independently. For example, a web database with independent data sets for processing or processing frames of a video independently are good candidates for data parallelism.

### Task Parallelism

In contrast to data parallelism, task parallelism doesn't split up the input data. Instead, it achieves parallelism by splitting up an application into multiple tasks. Task parallelism involves distributing tasks within an application across multiple processing nodes. Some tasks can have data dependency on others, so all tasks do not run at exactly the same time.

Consider a system that involves four functions. Functions F2a() and F2b() are in parallel, that is, they can run simultaneously. In task parallelism, you can divide your computation into two tasks. Function F2b() runs on a separate processing node after it gets data Out1 from Task 1, and it outputs back to F3() in Task 1.

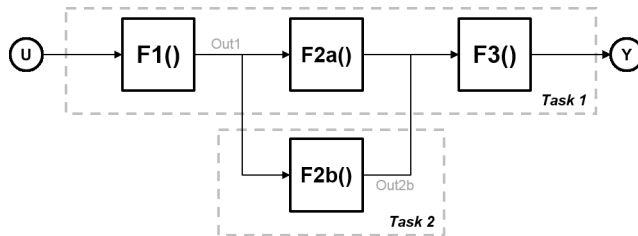

The figure shows the timing diagram for this parallelism. Task 2 does not run until it gets data Out1 from Task 1. Hence, these tasks do not run completely in parallel. The time taken per processor cycle, known as cycle time, is

$$t = tF1 + \max(tF2a, tF2b) + tF3.$$

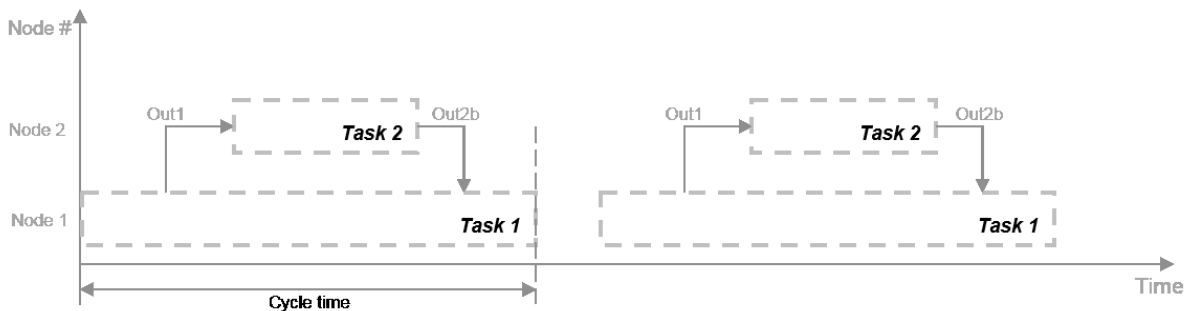

You can use task parallelism in scenarios such as a factory where the plant and controller run in parallel.

### Model Pipeline Execution (Pipelining)

Use model pipeline execution, or pipelining, to work around the problem of task parallelism where threads do not run completely in parallel. This approach involves modifying your system model to introduce delays between tasks where there is a data dependency.

In this figure, the system is divided into three tasks to run on three different processing nodes, with delays introduced between functions. At each time step, each task takes in the value from the previous time step by way of the delay.

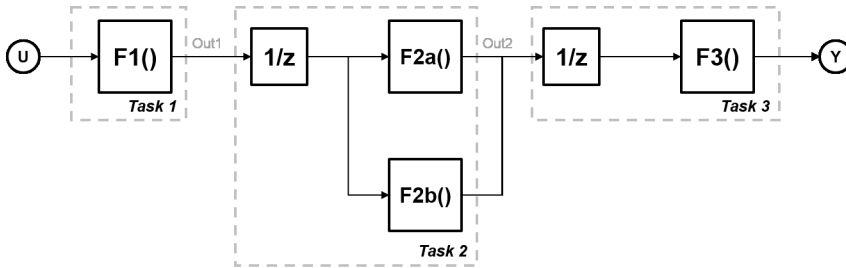

Each task can start processing at the same time, as this timing diagram shows. These tasks are truly parallel and they are no longer serially dependent on each other in one processor cycle. The cycle time does not have any additions but is the maximum processing time of all the tasks.

$$t = \max(\text{Task1}, \text{Task2}, \text{Task3}) = \max(t_{F1}, t_{F2a}, t_{F2b}, t_{F3}).$$

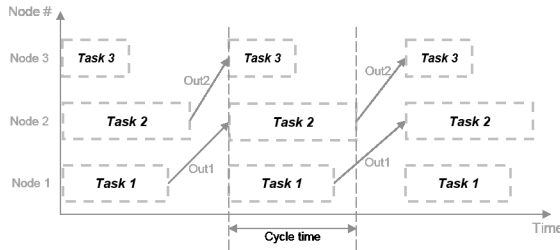

You can use pipelining wherever you can introduce delays artificially in your concurrently executing system. The resulting overhead due to this introduction must not exceed the time saved by pipelining.

## System Partitioning for Parallelism

Partitioning methods help you to designate areas of your system for concurrent execution. Partitioning allows you to create tasks independently of the specifics of the target system on which the application is deployed.

Consider this system. F1–F6 are functions of the system that can be executed independently. An arrow between two functions indicates a data dependency. For example, the execution of F5 has a data dependency on F3.

Execution of these functions is assigned to the different processor nodes in the target system. The grey arrows indicate assignment of the functions to be deployed on the CPU



or the FPGA. The CPU scheduler determines when individual tasks run. The CPU and FPGA communicate via a common communication bus.

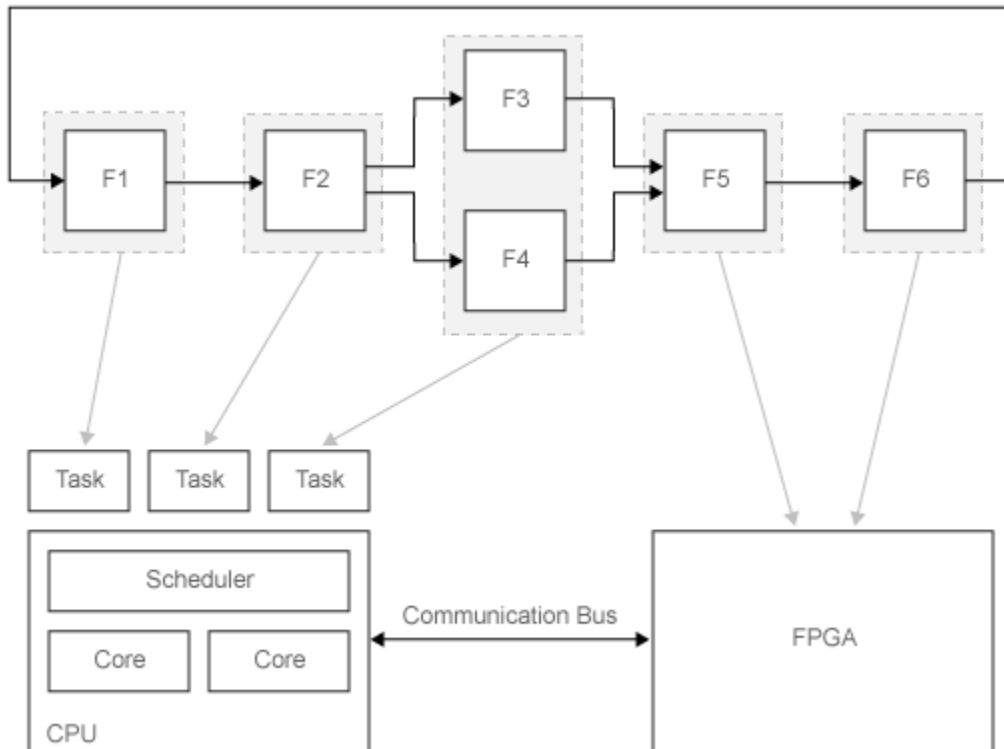

The figure shows one possible configuration for partitioning. In general, you test different configurations and iteratively improve until you get the optimal distribution of tasks for your application.

## Challenges in Multicore Programming

Manually coding your application onto a multicore processor or an FPGA poses challenges beyond the problems caused by manual coding. In concurrent execution, you must track:

- Scheduling of the tasks that execute on the embedded processing system multicore processor

- Data transfers to and from the different processing nodes

Simulink manages the implementation of tasks and data transfer between tasks. It also generates the code that is deployed for the application. For more information, see “Multicore Programming with Simulink” on page 14-10.

In addition to these challenges, there are challenges when you want to deploy your application to different architectures and when you want to improve the performance of the deployed application.

### **Portability: Deployment to Different Architectures**

The hardware configuration that runs the deployed application is known as the architecture. It can contain multicore processors, multiprocessor systems, FPGAs, or a combination of these. Deployment of the same application to different architectures can require effort due to:

- Different number and types of processor nodes on the architecture
- Communication and data transfer standards for the architecture
- Standards for certain events, synchronization, and data protection in each architecture

To deploy the application manually, you must reassign tasks to different processing nodes for each architecture. You might also need to reimplement your application if each architecture uses different standards.

Simulink helps overcome these problems by offering portability across architectures. For more information, see “How Simulink Helps You to Overcome Challenges in Multicore Programming” on page 14-11.

### **Deployment Efficiency**

You can improve the performance of your deployed application by balancing the load of the different processing nodes in the multicore processing environment. You must iterate and improve upon your distribution of tasks during partitioning, as mentioned in “System Partitioning for Parallelism” on page 14-6. This process involves moving tasks between different processing nodes and testing the resulting performance. Since it is an iterative process, it takes time to find the most efficient distribution.

Simulink helps you to overcome these problems using profiling. For more information, see “How Simulink Helps You to Overcome Challenges in Multicore Programming” on page 14-11.

## Cyclic Data Dependency

Some tasks of a system depend on the output of other tasks. The data dependency between tasks determines their processing order. Two or more partitions containing data dependencies in a cycle creates a data dependency loop, also known as an *algebraic loop*.

Simulink identifies loops in your system before deployment. For more information, see “How Simulink Helps You to Overcome Challenges in Multicore Programming” on page 14-11.

## Related Examples

- “Implement Data Parallelism in Simulink” on page 14-14
- “Implement Task Parallelism in Simulink” on page 14-18
- “Implement Pipelining in Simulink” on page 14-21

## More About

- “Multicore Programming with Simulink” on page 14-10

## Multicore Programming with Simulink

### In this section...

“Basic Workflow” on page 14-10

“How Simulink Helps You to Overcome Challenges in Multicore Programming” on page 14-11

Using the process of partitioning, mapping, and profiling in Simulink, you can address common challenges of designing systems for concurrent execution.

Partitioning enables you to designate regions of your model as tasks, independent of the details of the embedded multicore processing hardware. This independence enables you to arrange the content and hierarchy of your model to best suit the needs of your application.

In a partitioned system, mapping enables you to assign partitions to processing elements in your embedded processing system. Use the Simulink mapping tool to represent and manage the details of executing threads, HDL code on FPGAs, and the work that these threads or FPGAs perform. While creating your model, you do not need to track the partitions or data transfer between them because the tool does this work. Also, you can reuse your model across multiple architectures.

Profiling simulates deployment of your application under typical computational loads. It enables you to determine the partitioning and mapping for your model that gives the best performance, before you deploy to your hardware.

### Basic Workflow

To deploy your model to the target.

- 1 Set up your model for concurrent execution.
  - If you are using a desktop target, you need to configure your model. For more information, see “Configure Your Model for Concurrent Execution” on page 14-24.
  - If you are not using a desktop target, you need to configure your model, specify a target, and explicitly partition your model. Additionally, you may want to change the default mapping of blocks to tasks in explicit partitioning. To set up

your model for concurrent execution, see “Configure Your Model for Concurrent Execution” on page 14-24. To specify the target architecture, see “Specify a Target Architecture” on page 14-25. For explicit partitioning of a model, see “Partition Your Model Using Explicit Partitioning” on page 14-31

- 2 Generate code and deploy it to your target. You can choose to deploy onto multiple targets.
  - To build and deploy on a desktop target, see “Build on Desktop” on page 14-45.
  - To deploy onto embedded targets using Embedded Coder, see “Deployment” (Embedded Coder).
  - To deploy onto FPGAs using HDL Coder™, see “Deployment” (HDL Coder).
  - To build and deploy on a real-time target using Simulink Real-Time™, see “Standalone Operation” (Simulink Real-Time).
- 3 Optimize your design. This step is optional, and includes iterating over the design of your model and mapping to get the best performance, based on your metrics. One way to evaluate your model is to profile it and get execution times.

Product	Information
Desktop target	“Profile and Evaluate on a Desktop” on page 14-47
Simulink Real-Time	“Execution Profiling for Real-Time Applications” (Simulink Real-Time)
Embedded Coder	“Perform Execution-Time Profiling for IDE and Toolchain Targets” (Embedded Coder)
HDL Coder	“Speed and Area Optimization” (HDL Coder)

## How Simulink Helps You to Overcome Challenges in Multicore Programming

Manually programming your application for concurrent execution poses challenges beyond the typical challenges with manual coding. With Simulink, you can overcome the challenges of portability across multiple architectures, efficiency of deployment for an architecture, and cyclic data dependencies between application components. For more information on these challenges, see “Challenges in Multicore Programming” on page 14-7

### Portability

Simulink enables you to determine the content and hierarchical needs of the modeled system without considering the target system. While creating model content, you do not need to keep track of the number of cores in your target system. Instead, you select the partitioning methods that enable you to create model content. Simulink generates code for the architecture you specify.

You can select an architecture from the available supported architectures or add a custom architecture. When you change your architecture, Simulink generates only the code that needs to change for the second architecture. The new architecture reuses blocks and functions. For more information, see “Supported Targets For Multicore Programming” on page 14-55 and “Specify a Target Architecture” on page 14-25.

### Deployment Efficiency

To improve the performance of the deployed application, Simulink allows you to simulate it under typical computational loads and try multiple configurations of partitioning and mapping the application. Simulink compares the performance of each of these configurations to provide the optimal configuration for deployment. This is known as profiling. Profiling helps you to determine the optimum partition configuration before you deploy your system to the desired hardware.

You can create a mapping for your application in which Simulink maps the application components across different processing nodes. You can also manually assign components to processing nodes. For any mapping, you can see the data dependencies between components and remap accordingly. You can also introduce and remove data dependencies between different components.

### Cyclic Data Dependency

Some tasks of a system depend on the output of other tasks. The data dependency between tasks determines their processing order. Two or more partitions containing data dependencies in a cycle creates a data dependency loop, also known as an *algebraic loop*. Simulink does not allow algebraic loops to occur across potentially parallel partitions because of the high cost of solving the loop using parallel algorithms.

In some cases, the algebraic loop is artificial. For example, you can have an artificial algebraic loop because of Model-block-based partitioning. An algebraic loop involving Model blocks is artificial if removing the use of Model partitioning eliminates the loop. You can minimize the occurrence of artificial loops. In the Configuration Parameter

dialog boxes for the models involved in the algebraic loop, select **Model Referencing > Minimize algebraic loop occurrences**.

Additionally, if the model is configured for the Generic Real-Time target (`grt.tlc`) or the Embedded Real-Time target (`ert.tlc`) in the Configuration Parameters dialog box, clear the **All Parameters > Single output/update function** check box.

If the algebraic loop is a true algebraic condition, you must either contain all the blocks in the loop in one Model partition, or eliminate the loop by introducing a delay element in the loop.

The following examples show how to implement different types of parallelism in Simulink. These examples contain models that are partitioned and mapped to a simple architecture with one CPU and one FPGA.

## Related Examples

- “Implement Data Parallelism in Simulink” on page 14-14
- “Implement Task Parallelism in Simulink” on page 14-18
- “Implement Pipelining in Simulink” on page 14-21

## More About

- “Concepts in Multicore Programming” on page 14-2
- “Supported Targets For Multicore Programming” on page 14-55
- “Limitations with Multicore Programming in Simulink” on page 14-57

## Implement Data Parallelism in Simulink

This example shows how to implement data parallelism for a system in a Simulink model. The model consists of an input, a functional component that applies to each input, and a concatenated output. For more information on data parallelism, see “Types of Parallelism” on page 14-3.

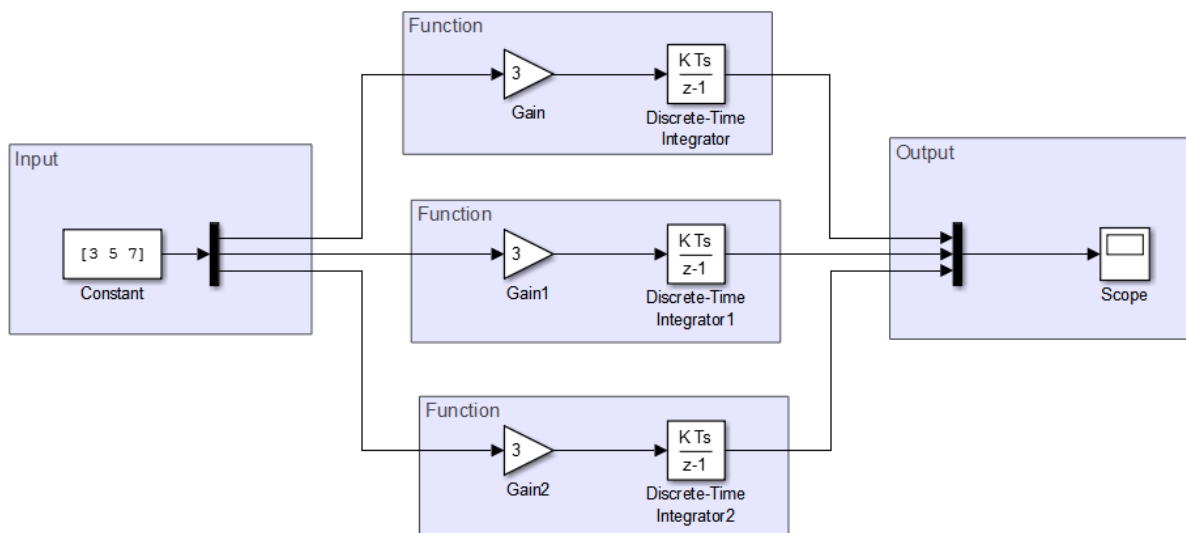

Set up this model for concurrent execution. To see the completed model, open `ex_data_parallelism_top`.

- 1 Convert areas in this model to referenced models. Use the same referenced model to replace each of the functional components that process the input. The figure shows a sample configuration.



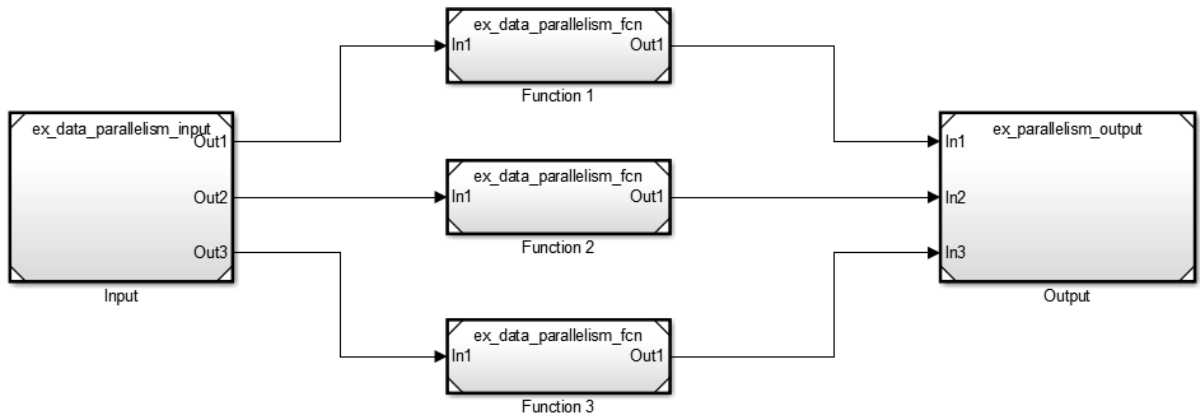

- 2 Open the Model Explorer.
- 3 Expand the options for the top-level model and right-click the **Configuration (Active)**, the active configuration set. Select **Show Concurrent Execution options** to see how the options for concurrent execution are set in the model configuration parameters.
- 4 Close the Model Explorer and open the model configuration parameters. In the **All Parameters** tab, clear the **MAT-file logging** check box.
- 5 On the **Solver** pane, set **Type** to **Fixed-step** and click **Apply**. Under **Additional options**, click **Configure Tasks**.
- 6 In the Concurrent Execution dialog box, in the right pane, select the **Enable explicit model partitioning for concurrent behavior** check box. With explicit partitioning, you can partition your model manually.
- 7 In the selection pane, select **CPU**. Click **Add task**  four times to add four new tasks.
- 8 In the selection pane, select **Tasks and Mapping**. On the **Map block to tasks** pane:
  - Under **Block: Input**, click **select task** and select **Periodic: Task**.
  - Under **Block: Function 1**, select **Periodic: Task1**.
  - Under **Block: Function 2**, select **Periodic: Task2**.
  - Under **Block: Function 3**, select **Periodic: Task3**.

- Under **Block: Output**, select **Periodic: Task**.

This maps your partitions to the tasks you created. The Input and Output model blocks are on one task. Each functional component is assigned a separate task.

- 9 In the selection pane, select **Data transfer**. In the **Data Transfer Options** pane, set the parameter **Periodic signals** to **Ensure deterministic transfer (minimum delay)**. Click **Apply** and close the Concurrent Execution dialog box.
- 10 Apply these configuration parameters to all referenced models. For more information, see “Share a Configuration for Multiple Models” on page 13-4.

Update your model to see the tasks mapped to individual model blocks.

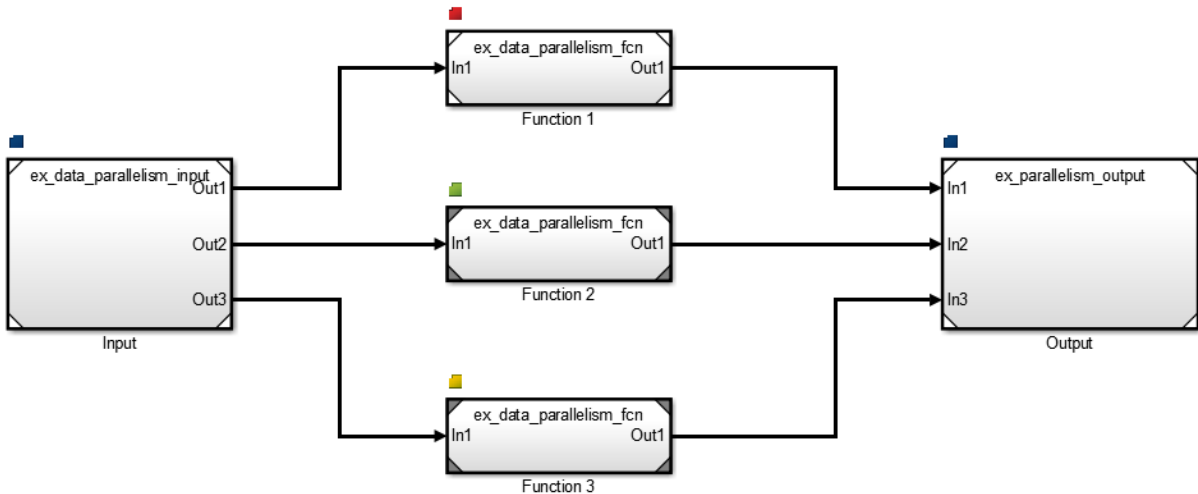

## Related Examples

- “Implement Task Parallelism in Simulink” on page 14-18
- “Implement Pipelining in Simulink” on page 14-21

## More About

- “Concepts in Multicore Programming” on page 14-2
- “Multicore Programming with Simulink” on page 14-10
- “Supported Targets For Multicore Programming” on page 14-55

- “Limitations with Multicore Programming in Simulink” on page 14-57

## Implement Task Parallelism in Simulink

This example shows how to implement task parallelism for a system in a Simulink model. The model consists of an input, functional components applied to the same input, and a concatenated output. For more information on Task Parallelism, see “Types of Parallelism” on page 14-3.

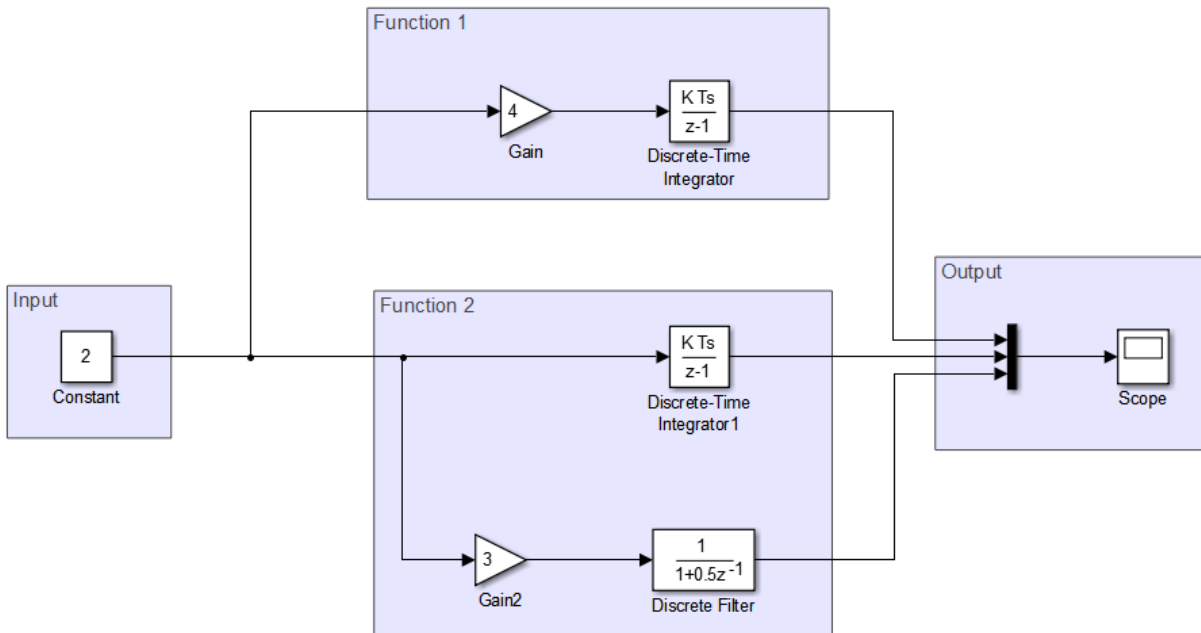

Setup this model for concurrent execution. To see the completed model, open `ex_task_parallelism_top`.

- 1 Convert areas in this model to referenced models. Use the same referenced model to replace each of the functional components that process the input. The figure shows a sample configuration.

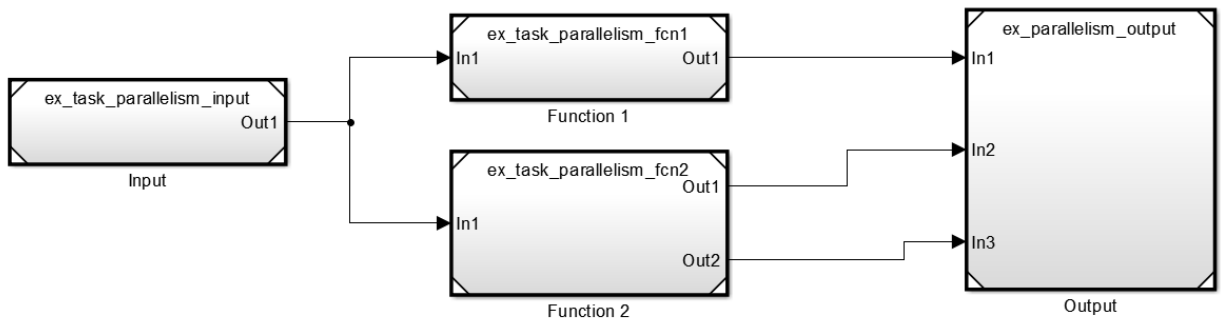

- 2 Open the Model Explorer.
- 3 Expand the options for the top-level model and right-click the **Configuration (Active)**, the active configuration set. Select **Show Concurrent Execution options** to see how the options for concurrent execution are set in the model configuration parameters.
- 4 Close the Model Explorer and open the model configuration parameters. In the **All Parameters** tab, clear the **MAT-file logging** check box.
- 5 On the **Solver** pane, set **Type** to **Fixed-step** and click **Apply**. Under **Additional options**, click **Configure Tasks**.
- 6 In the Concurrent Execution dialog box, in the right pane, select the **Enable explicit model partitioning for concurrent behavior** check box. With explicit partitioning, you can partition your model manually.
- 7 In the selection pane, select **CPU**. Click **Add task**  three times to add three new tasks.
- 8 In the selection pane, select **Tasks and Mapping**. On the **Map block to tasks** pane:
  - Under **Block: Input**, click **select task** and select **Periodic: Task**.
  - Under **Block: Function 1**, select **Periodic: Task1**.
  - Under **Block: Function 2**, select **Periodic: Task2**.
  - Under **Block: Output**, select **Periodic: Task**.

This maps your partitions to the tasks you created. The Input and Output model blocks are on one task. Each functional component is assigned a separate task.

- 9 In the selection pane, select **Data transfer**. In the **Data Transfer Options** pane, set the parameter **Periodic signals** to **Ensure deterministic transfer** (minimum delay). Click **Apply** and close the Concurrent Execution dialog box.
- 10 Apply these configuration parameters to all referenced models. For more information, see “Share a Configuration for Multiple Models” on page 13-4.

Update your model to see the tasks mapped to individual model blocks.

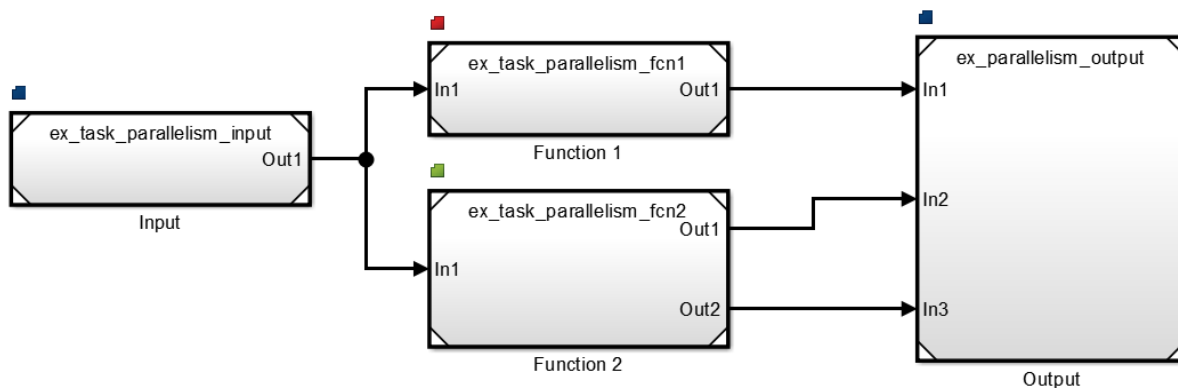

## Related Examples

- “Implement Data Parallelism in Simulink” on page 14-14
- “Implement Pipelining in Simulink” on page 14-21

## More About

- “Concepts in Multicore Programming” on page 14-2
- “Multicore Programming with Simulink” on page 14-10
- “Supported Targets For Multicore Programming” on page 14-55

## Implement Pipelining in Simulink

This example shows how to implement pipelining for a system in a Simulink model. The model consists of an input, functional components applied to the same input, and a concatenated output. For more information on pipelining, see “Types of Parallelism” on page 14-3.

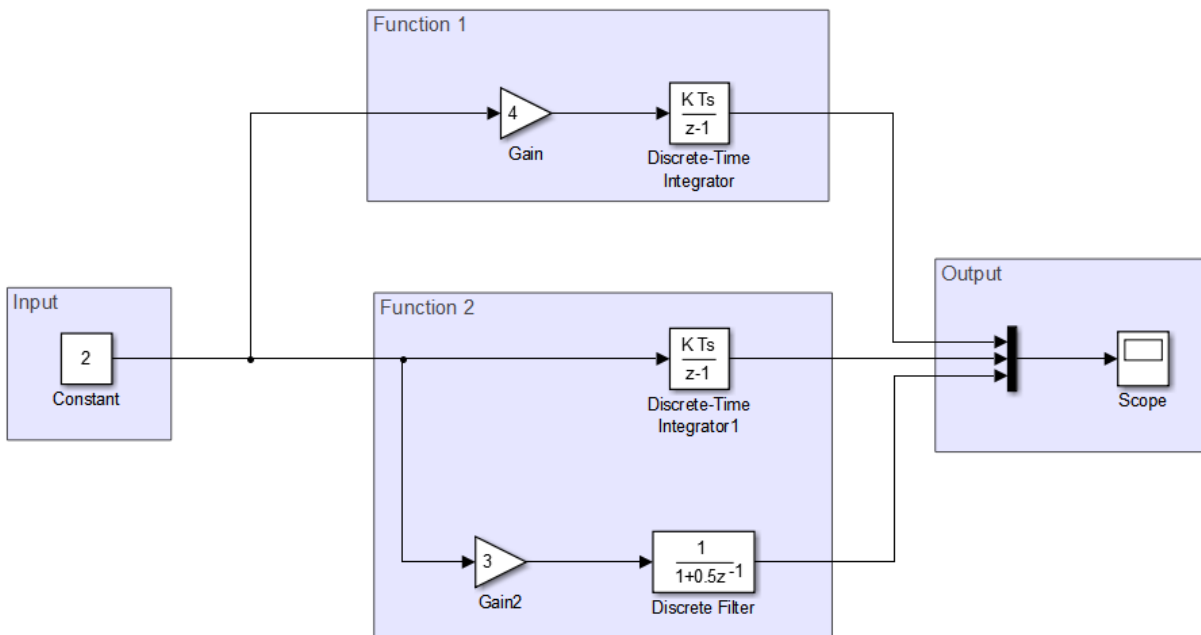

Setup this model for concurrent execution. To see the completed model, open `ex_pipelining_top`.

- 1 Convert areas in this model to referenced models. Use the same referenced model to replace each of the functional components that process the input. The figure shows a sample configuration.

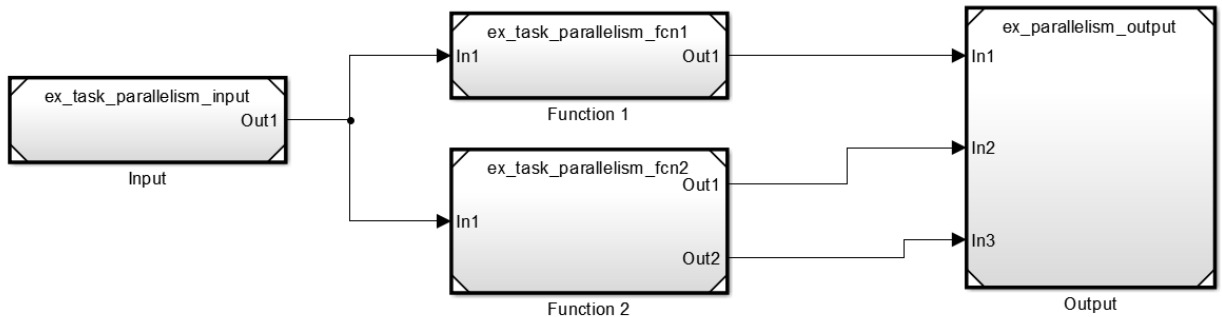

- 2 Open the Model Explorer.
- 3 Expand the options for the top-level model and right-click the **Configuration (Active)**, the active configuration set. Select **Show Concurrent Execution options** to see how the options for concurrent execution are set in the model configuration parameters.
- 4 Close the Model Explorer and open the model configuration parameters. In the **All Parameters** tab, clear the **MAT-file logging** check box.
- 5 On the **Solver** pane, set **Type** to **Fixed-step** and click **Apply**. Under **Additional options**, click **Configure Tasks**.
- 6 In the Concurrent Execution dialog box, in the right pane, select the **Enable explicit model partitioning for concurrent behavior** check box. With explicit partitioning, you can partition your model manually.
- 7 In the selection pane, select **CPU**. Click **Add task**  three times to add three new tasks.
- 8 In the selection pane, select **Tasks and Mapping**. On the **Map block to tasks** pane:
  - Under **Block: Input**, click **select task** and select **Periodic: Task**.
  - Under **Block: Function 1**, select **Periodic: Task1**.
  - Under **Block: Function 2**, select **Periodic: Task2**.
  - Under **Block: Output**, select **Periodic: Task**.

This maps your partitions to the tasks you created. The Input and Output model blocks are on one task. Each functional component is assigned a separate task.

- 9 Close the Concurrent Execution dialog box.



- 10** Apply these configuration parameters to all referenced models. For more information, see “Share a Configuration for Multiple Models” on page 13-4.

Update your model to see the tasks mapped to individual model blocks.

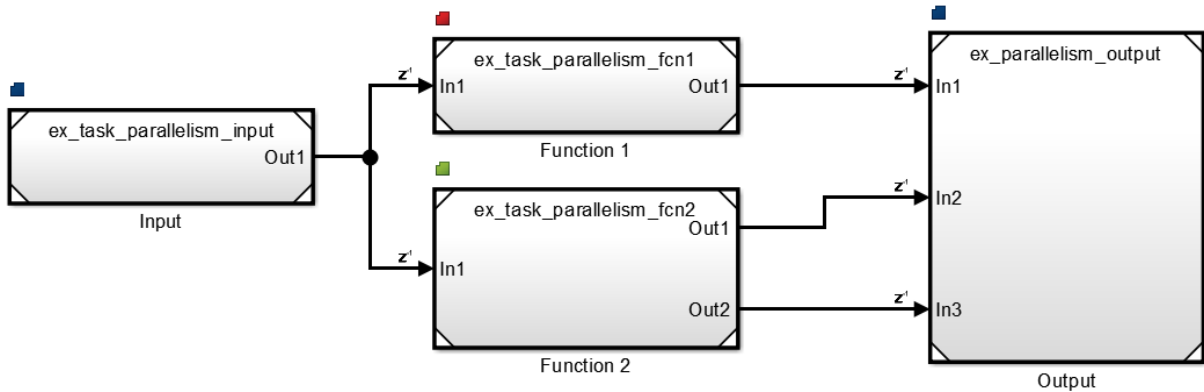

**Note:** Notice that delays are introduced between different tasks, indicated by the z-1 badge. Introducing these delays may cause different model outputs in Simulink. Ensure that your model has an expected output on simulating the parallelized model.

## Related Examples

- “Implement Data Parallelism in Simulink” on page 14-14
- “Implement Task Parallelism in Simulink” on page 14-18

## More About

- “Concepts in Multicore Programming” on page 14-2
- “Multicore Programming with Simulink” on page 14-10
- “Supported Targets For Multicore Programming” on page 14-55

## Configure Your Model for Concurrent Execution

Follow these steps to configure your Simulink model to take advantage of concurrent execution.

- 1 Open your model.
- 2 Open Model Explorer and expand the node for the model. Under the model, right-click **Configuration**, then select **Show Concurrent Execution options**.
- 3 Select the **Allow tasks to execute concurrently on target** check box in the **Solver** pane of the Configuration Parameters dialog box. Selection of this check box is optional for models referenced in the model hierarchy. When you select this option for a referenced model, Simulink allows each rate in the referenced model to execute as an independent concurrent task on the target processor.
- 4 Clear the **MAT-file logging** check box in the **All Parameters** tab.
- 5 Choose **Fixed-step** for the **Type** and **auto (Automatic solver selection)** for the **Solver** in **Configuration Parameters > Solver > Solver options**.

Once you have a model that executes concurrently on your computer, you can further configure your model in the following ways.

- “Specify a Target Architecture” on page 14-25
- Explicitly map blocks to tasks. For more information, see “Partition Your Model Using Explicit Partitioning” on page 14-31.
- “Configure Data Transfer Settings Between Concurrent Tasks” on page 14-40

### More About

- “Concepts in Multicore Programming” on page 14-2
- “Multicore Programming with Simulink” on page 14-10
- “Implicit and Explicit Partitioning of Models” on page 14-37
- “Specify a Target Architecture” on page 14-25
- “Partition Your Model Using Explicit Partitioning” on page 14-31
- “Configure Data Transfer Settings Between Concurrent Tasks” on page 14-40

## Specify a Target Architecture

### In this section...

“Choose from Predefined Architectures” on page 14-25

“Define a Custom Architecture File” on page 14-27

For models configured for concurrent execution, you can choose the architecture to which you want to deploy your model. Choose from a set of predefined architectures in Simulink, or you can create an interface for a custom architecture. After selecting your architecture, you can use explicit partitioning to specify which tasks run on it. For more information, see “Partition Your Model Using Explicit Partitioning” on page 14-31.

### Choose from Predefined Architectures

You can choose from the predefined architectures available in Simulink, or you can download support packages for different available architectures.

- 1 In the Concurrent Execution dialog box, in the **Concurrent Execution** pane, click **Select**. The concurrent execution target architecture selector appears.

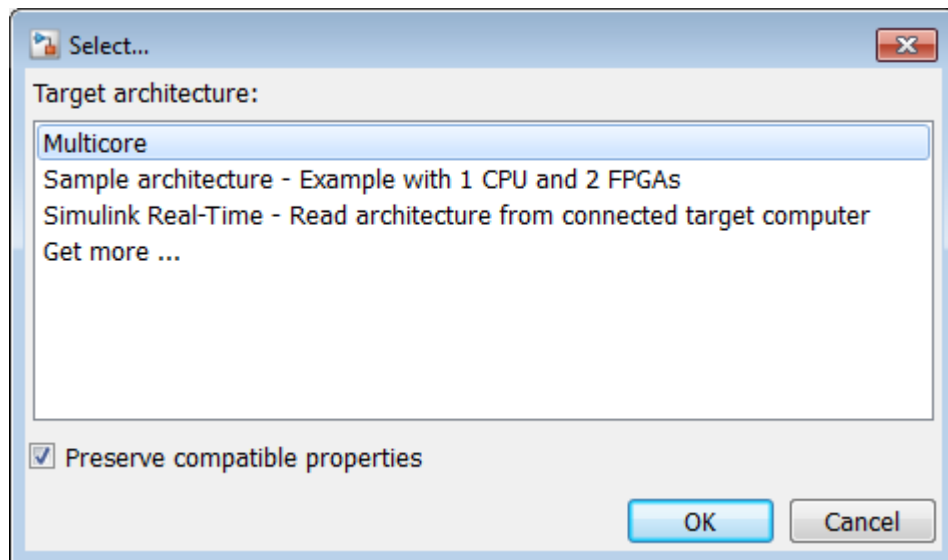

- 2 Select your target.

Property	Description
Multicore	Single CPU with multiple cores.
Sample Architecture	Single CPU with multiple cores and two FPGAs.
Simulink Real-Time	Simulink Real-Time target.
Get more ...	Click OK to start the Support Package Installer. From the list, select the target and follow the instructions.

- 3 In the Target architecture window, clear the **Preserve compatible properties** check box to reset existing target property settings to their default. Alternatively, select the **Preserve compatible properties** check box to preserve existing target property settings.
- 4 Click **OK**.

Simulink adds the corresponding software and hardware nodes to the configuration tree hierarchy. For example, the following illustrates one software node and two hardware nodes added to the configuration tree when you select **Sample architecture** as the target architecture.

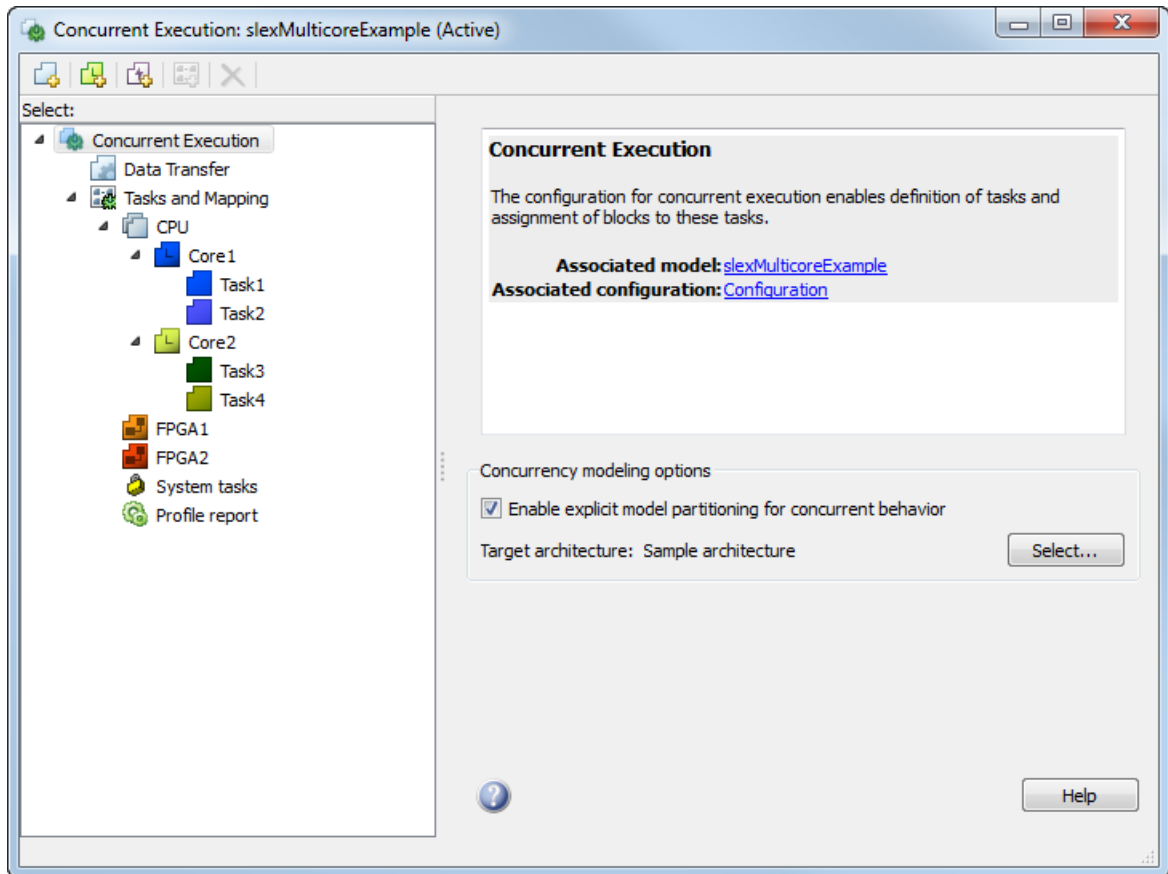

## Define a Custom Architecture File

A custom architecture file is an XML file that allows you to define custom target properties for tasks and triggers. For example, you may want to define custom properties to represent threading APIs. Threading APIs are necessary to take advantage of concurrency on your target processor.

The following is an example custom architecture file:

```
<architecture brief="Multicore with custom threading API"
  format="1.1" revision="1.1"
```

```

        uuid="MulticoreCustomAPI" name="MulticoreCustomAPI">
<configurationSet>
  <parameter name="SystemTargetFile" value="ert.tlc"/>
  <parameter name="SystemTargetFile" value="grt.tlc"/>
</configurationSet>
<node name="MulticoreProcessor" type="SoftwareNode" uuid="MulticoreProcessor"/>
<template name="CustomTask" type="Task" uuid="CustomTask">
  <property name="affinity" prompt="Affinity:" value="1" evaluate="true"/>
  <property name="schedulingPolicy" prompt="Scheduling policy:" value="Rate-monotonic">
    <allowedValue>Rate-monotonic</allowedValue>
    <allowedValue>Round-robin</allowedValue>
  </property>
</template>
</architecture>

```

An architecture file must contain:

- The architecture element that defines basic information used by Simulink to identify the architecture.
- A `configurationSet` element that lists the system target files for which this architecture is valid.
- One node element that Simulink uses to identify the multicore processing element.

---

**Note:** The architecture must contain exactly one node element that identifies a multicore processing element. You cannot create multiple nodes identifying multiple processing elements or an architecture with no multicore processing element.

---

- One or more template elements that list custom properties for tasks and triggers.
  - The type attribute can be `Task`, `PeriodicTrigger`, or `AperiodicTrigger`.
  - Each property is editable and has the default value specified in the `value` attribute.
  - Each property can be a text box, check box, or combo box. A check box is one where you can set the `value` attribute to `on` or `off`. A combo box is one where you can optionally list `allowedValue` elements as part of the property.
  - Each text box property can also optionally define an `evaluate` attribute. This lets you place MATLAB variable names as the value of the property.

Assuming that you have saved the custom target architecture file in `C:\custom_arch.xml`, register this file with Simulink using the `Simulink.architecture.register` function.

For example:

- 1 Save the contents of the listed XML file in `custom_arch.xml`.
- 2 In the MATLAB Command Window, type:
 

```
Simulink.architecture.register('custom_arch.xml')
```
- 3 In the MATLAB Command Window, type:
 

```
slexMulticoreSolverExample
```
- 4 In the Simulink editor, open the **Configuration Parameters** > **Solver** pane and click **Configure Tasks**. The Concurrent Execution dialog box displays.
- 5 In the **Concurrent Execution** pane, click **Select...** under **Target Architecture**. The Target architecture window displays.
- 6 Select `MulticoreCustomAPI` and click **OK**.

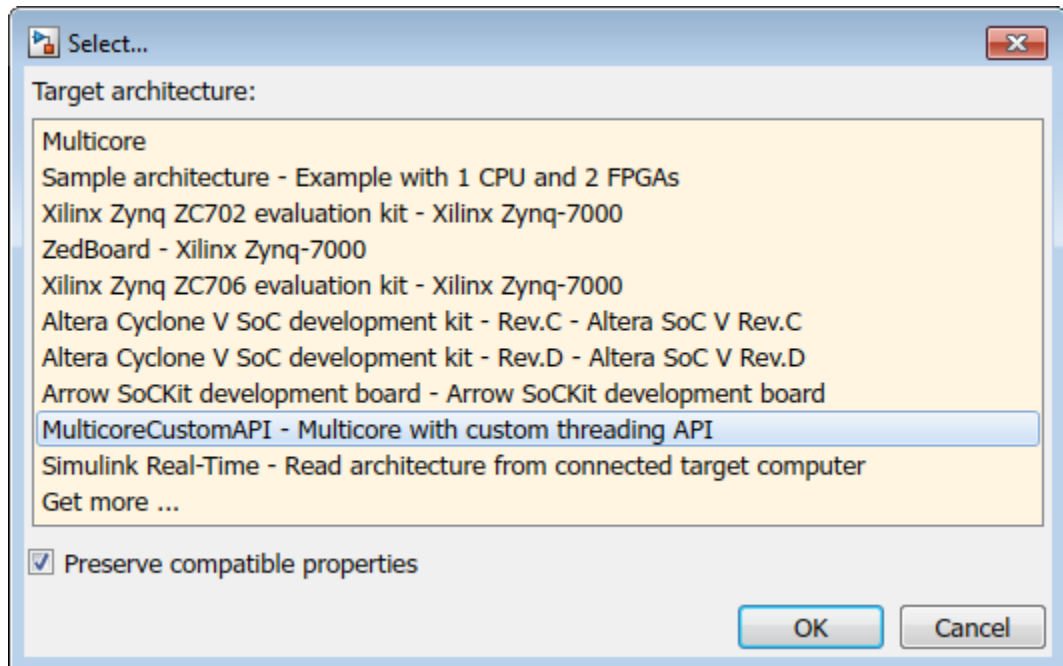

Your Concurrent Execution dialog box updates to contain Code Generation properties for the tasks as shown. These are the properties defined in the XML file.

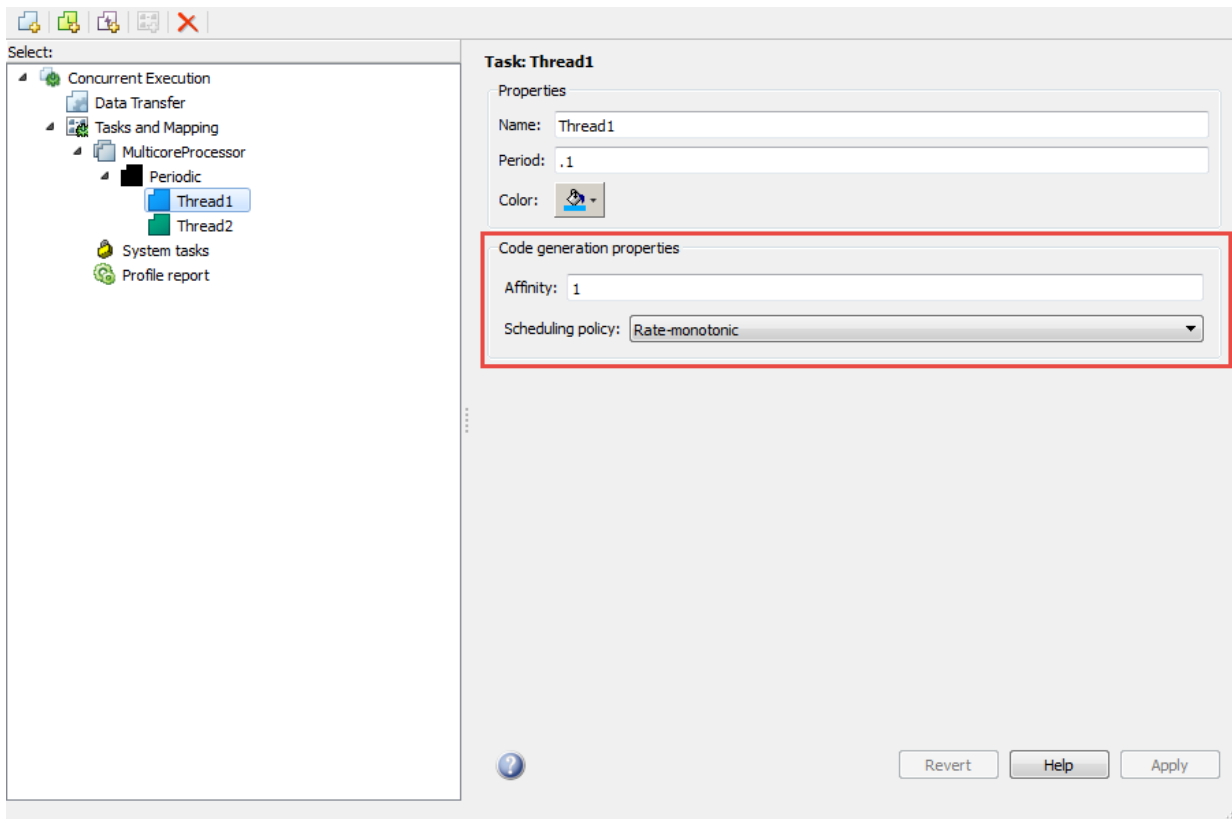

## More About

- “Configure Your Model for Concurrent Execution” on page 14-24
- “Partition Your Model Using Explicit Partitioning” on page 14-31
- “Implicit and Explicit Partitioning of Models” on page 14-37



## Partition Your Model Using Explicit Partitioning

When you have a model that is configured for concurrent execution, you can add tasks, create partitions, and map individual tasks to partitions using explicit partitioning. This enables you to execute different parts of your model to different parts of your architecture. For more information, see “Implicit and Explicit Partitioning of Models” on page 14-37.

### In this section...

“Prerequisites for Explicit Partitioning” on page 14-31

“Add Periodic Triggers and Tasks” on page 14-31

“Add Aperiodic Triggers and Tasks” on page 14-32

“Map Blocks to Tasks, Triggers, and Nodes” on page 14-34

### Prerequisites for Explicit Partitioning

To use explicit partitioning, you must meet the following prerequisites:

- 1 Set up your model for concurrent execution. For more information, see “Configure Your Model for Concurrent Execution” on page 14-24.
- 2 Convert all blocks at the root level of your model into MATLAB System blocks or models that are referenced using Model blocks. For more information, see “Implicit and Explicit Partitioning of Models” on page 14-37.

---

**Note:** When using referenced models, replicate the model configuration parameters of the top model to the referenced models. Consider using a single configuration reference to use for all of your referenced models. For more information, see “Configuration Reuse”.

---

- 3 Select the target architecture on which to deploy your model. For more information, see “Specify a Target Architecture” on page 14-25.

### Add Periodic Triggers and Tasks

Add periodic tasks for components in your model that you want to execute periodically. To add aperiodic tasks whose execution is trigger based, see “Add Aperiodic Triggers and Tasks” on page 14-32.

If you want to explore the effects of increasing the concurrency on your model execution, you can create additional periodic tasks in your model.

- 1 In the Concurrent Execution dialog box, right-click the **Periodic** node and select **Add task**.

A task node appears in the Configuration Execution hierarchy.

- 2 Select the task node and enter a name and period for the task, then click **Apply**.

The task node is renamed to the name you enter.

- 3 Optionally, specify a color for the task. The color illustrates the block-to-task mapping. If you do not assign a color, Simulink chooses a default color. If you enable sample time colors for your model, the software honors the setting.
- 4 Click **Apply** as necessary.

To create more periodic triggers, click the **Add periodic trigger** symbol. You can also create multiple periodic triggers with their own trigger sources.

---

**Note:** Periodic triggers let you represent multiple periodic interrupt sources such as multiple timers. The periodicity of the trigger is either the base rate of the tasks that the trigger schedules, or the period of the trigger. Data transfers between triggers can only be **Ensure Data Integrity Only** types. With blocks mapped to periodic triggers, you can only generate code for `ert.tlc` and `grt.tlc` system target files.

---

To delete tasks and triggers, right-click them in the pane and select **Delete**.

When the periodic tasks and trigger configurations are complete, configure the aperiodic (interrupt) tasks as necessary. If you do not need aperiodic tasks, continue to “Map Blocks to Tasks, Triggers, and Nodes” on page 14-34.

### Add Aperiodic Triggers and Tasks

Add aperiodic tasks for components in your model whose execution is interrupt-based. To add periodic tasks whose execution is periodic, see “Add Periodic Triggers and Tasks” on page 14-31.

- 1 To create an aperiodic trigger, in the Concurrent Execution dialog box, right-click the **Concurrent Execution** node and click the **Add aperiodic trigger** symbol.

A node named **Interrupt $N$**  appears in the configuration tree hierarchy, where  $N$  is an integer.

**2** Select **Interrupt**.

This node represents an aperiodic trigger for your system.

**3** Specify the name of the trigger and configure the aperiodic trigger source. Depending on your deployment target, choose either **Posix Signal (Linux/VxWorks 6.x)** or **Event (Windows)**. For POSIX<sup>®</sup> signals, specify the signal number to use for delivering the aperiodic event. For Windows events, specify the name of the event.

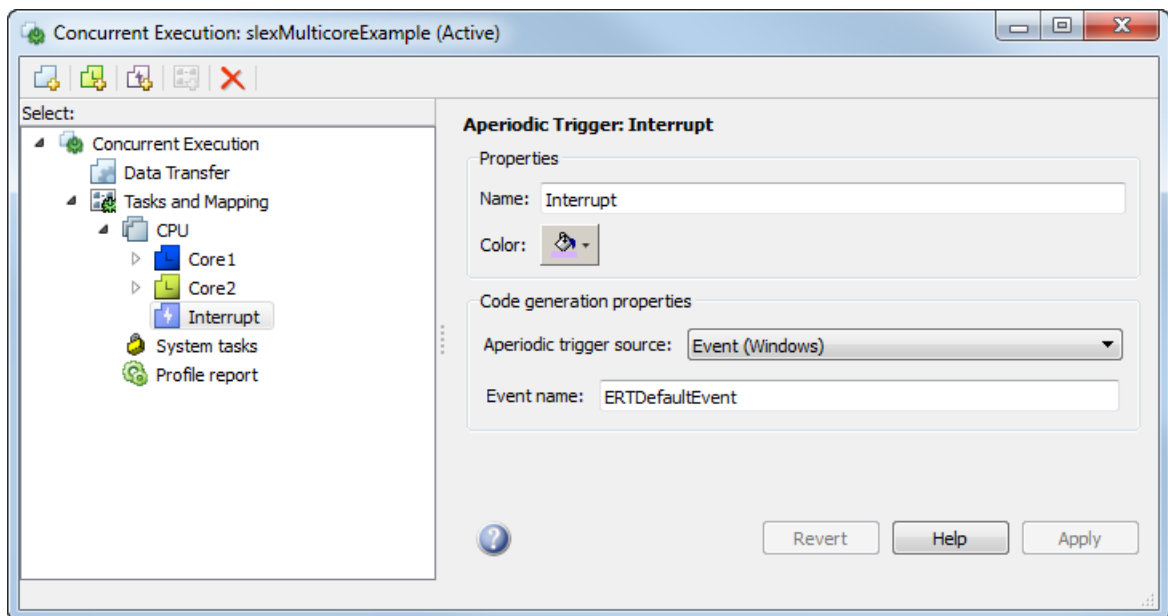

**4** Click **Apply**.

The software services aperiodic triggers as soon as possible. If you want to process the trigger response using a task:

**1** Right-click the **Interrupt** node and select **Add task**.

A new task node appears under the **Interrupt** node.

**2** Specify the name of the new task node.

- 3 Optionally, specify a color for the task. The color illustrates the block-to-task mapping. If you do not assign a color, Simulink chooses a default color.
- 4 Click **Apply**.

To delete tasks and triggers, right-click them in the pane and select **Delete**.

Once you have created your tasks and triggers, map your execution components to these tasks. For more information, see “Map Blocks to Tasks, Triggers, and Nodes” on page 14-34.

### Map Blocks to Tasks, Triggers, and Nodes

After you create the tasks and triggers, you can explicitly assign partitions to these execution elements.

- 1 In the Concurrent Execution dialog box, click the **Tasks and Mapping** node.

The **Tasks and Mapping** pane appears. If you add a Model block to your model, the new block appears in the table with a **select task** entry under it.

- 2 If you want to add a task to a block, in the **Name** column, right-click a task under the block and select **Add new entry**.
- 3 To assign a task for the entry, click the box in the **Name** column and select an entry from the list. For example:

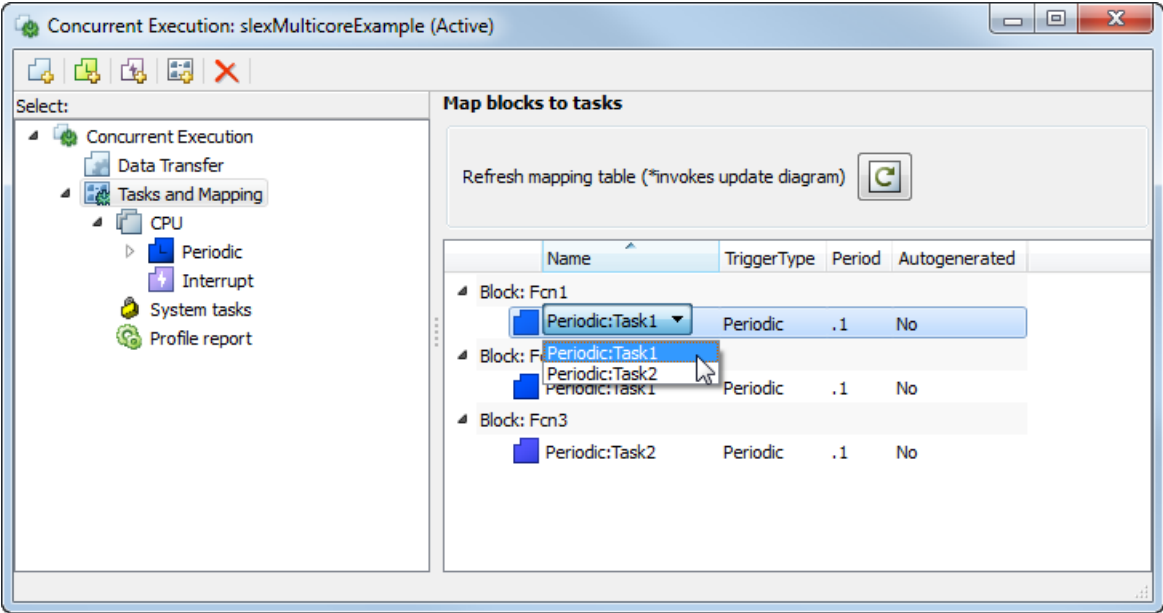

The block-to-task mapping symbol appears on the top-left corner of the Model block. For example:

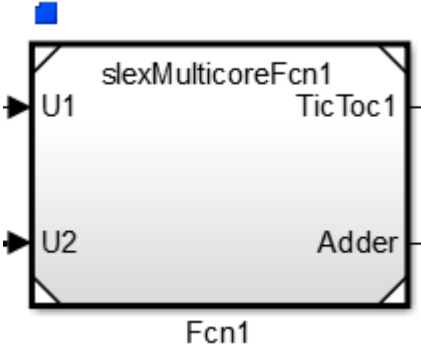

If you assign a Model block to multiple tasks, multiple task symbols are displayed in the top-left corner.

To display the Concurrent Execution dialog box from the block, click the block-to-task mapping symbol.

- 4 Click **Apply**.

---

**Note:**

- System tasks allow you to perform mapping incrementally. This means that if there is only one periodic trigger, Simulink assigns any Model blocks or MATLAB System blocks that you have not explicitly mapped to a task, trigger, or hardware node to a task created by the system. Simulink creates at most one system task for each rate in the model. If there are multiple periodic triggers created, explicitly map the Model block partitions or MATLAB System blocks to a task, trigger, or hardware node.
  - Map Model block partitions that contain continuous blocks to the same periodic trigger.
  - You can map only Model blocks to hardware nodes. Also, if you map the Model block to a hardware node, and the Model block contains multiple periodic sample times, clear the **Allow tasks to execute concurrently on target** check box in the **Solver** pane of the Configuration Parameters dialog box.
- 

When the mapping is complete, simulate the model again.

### Related Examples

- “Implement Data Parallelism in Simulink” on page 14-14
- “Implement Task Parallelism in Simulink” on page 14-18
- “Implement Pipelining in Simulink” on page 14-21

### More About

- “Concepts in Multicore Programming” on page 14-2
- “Multicore Programming with Simulink” on page 14-10
- “Implicit and Explicit Partitioning of Models” on page 14-37

## Implicit and Explicit Partitioning of Models

When implementing multicore programming for your application in Simulink, there are two ways to partition your model for running on individual processing nodes. If you are new to multicore programming in Simulink, use the default (implicit partitioning) for your first iteration of implementing multicore programming.

The automated way of creating tasks and mapping them to your processing nodes is called *implicit partitioning*. Simulink partitions your model based on the sample time of blocks at the root level. Each sample time in your model corresponds to a partition, and all blocks of a single rate or sample time belong to the same partition. Simulink maps these partitions to tasks that run on your processor. Implicit partitioning assumes your architecture to be a single multicore CPU. The CPU task scheduler handles all the partitioned tasks.

If you want to specify how to partition your model, use *explicit partitioning*. In explicit partitioning, you create partitions in the root-level model by using referenced models, MATLAB system blocks, and so on. For example, if your model has data acquisition and a controller, partition your model by putting these components in two referenced models at the model root-level. Each sample time in a referenced model or a system block is a partition. You can add tasks to run on processing nodes in the Concurrent Execution dialog box and assign your partitions to these tasks. If some partitions are left unassigned, Simulink automatically assigns them to tasks.

In explicit partitioning, you can specify your own architecture. The default architecture is a multicore CPU, the same as the assumed architecture in implicit partitioning. Explicit partitioning has more restrictions on your root-level model than implicit partitioning. For more information, see “Limitations with Multicore Programming in Simulink” on page 14-57.

### Partitioning Guidelines

There are multiple ways to partition your model for concurrent execution in Simulink. Rate-based and model-based approaches give you primarily graphical means to represent concurrency for systems that are represented using Simulink and Stateflow blocks. You can partition MATLAB code using the MATLAB System block. You can also partition models of physical systems using multisolver methods.

Each method has additional considerations to help you decide which to use.

Goal	Valid Partitioning Methods	Considerations
Increase the performance of a simulation on the host computer.	No partitioning method	Simulink tries to optimize the host computer performance regardless of the modeling method you use. For more information on the ways that Simulink helps you to improve performance, see “Performance”.
Increase the performance of a plant simulation in a multicore HIL (hardware-in-the-loop) system.	You can use any of the partitioning methods and their combinations.	The processing characteristics of the HIL system and the embedded processing system can vary greatly. Consider partitioning your system into more units of work than there are number of processing elements in the HIL or embedded system. This convention allows flexibility in the mapping process.
Create a valid model of a multirate concurrent system to take advantage of a multicore processing system.	You can use any of the partitioning methods and their combinations.	Partitioning can introduce signal delays to represent the data transfer requirements for concurrent execution. For more information, see “Configure Data Transfer Settings Between Concurrent Tasks” on page 14-40.
Create a valid model of a heterogeneous system to take advantage of multicore and FPGA processing.	<ul style="list-style-type: none"> <li>• Multicore processing: Use any of the partitioning methods.</li> <li>• FPGA processing: Partition your model using Model blocks.</li> </ul>	Consider partitioning for FPGA processing where your computations have bottlenecks that could be reduced using fine-grained hardware parallelism.

### Related Examples

- “Implement Data Parallelism in Simulink” on page 14-14
- “Implement Task Parallelism in Simulink” on page 14-18



- “Implement Pipelining in Simulink” on page 14-21

### **More About**

- “Concepts in Multicore Programming” on page 14-2
- “Multicore Programming with Simulink” on page 14-10
- “Supported Targets For Multicore Programming” on page 14-55

## Configure Data Transfer Settings Between Concurrent Tasks

Data dependencies arise when a signal originates from one block in one partition and is connected to a block in another partition. To create opportunities for parallelism, Simulink provides multiple options for handling data transfers between concurrently executing partitions. These options help you trade off computational latency for numerical signal delays.

Use the **Data Transfer Options** pane to define communications between tasks. Set the values for the `Use global setting` option of the Data Transfer tab in the Signal Properties dialog box. The table provides the model-level options that you can apply to each signal that requires data transfer in the system.

### Data Transfer Options

Goal	Data Transfer Type	Simulation	Deployment
<ul style="list-style-type: none"> <li>• Create opportunity for parallelism.</li> <li>• Reduce signal latency.</li> </ul>	Ensure data integrity only.	Data transfer is simulated using a one-step delay.	<p>Simulink Coder ensures data integrity during data transfer. Simulink generates code to operate with maximum responsiveness and data integrity. However, the implementation is interruptible, which can lead to loss of data during data transfer.</p> <p>Use a deterministic execution schedule to achieve determinism in the deployment environment.</p>
<ul style="list-style-type: none"> <li>• Create opportunity for parallelism.</li> </ul>	Ensure deterministic transfer (maximum delay).	Data transfer is simulated using a one-step delay,	Simulink Coder ensures data integrity during data

Goal	Data Transfer Type	Simulation	Deployment
<ul style="list-style-type: none"> <li>Produce numeric results that are repeatable with each run of the generated code.</li> </ul>		which can have impact on the numeric results. To compensate, you might need to specify an initial condition for these delay elements.	transfer. In addition, Simulink Coder ensures that data transfer is identical with simulation.
<ul style="list-style-type: none"> <li>Enforce data dependency.</li> <li>Produce numeric results that are repeatable with each run of the generated code.</li> </ul>	Ensure deterministic transfer (minimum delay).	Data transfer occurs within the same step.	

You can also override these options for each signal from the **Data Transfer** pane of the Signal Properties dialog box. For more information, see “Data Transfer Options for Concurrent Execution”.

For example, consider a control application in which a controller that reads sensory data at time  $T$  must produce the control signals to the actuator at time  $T+\Delta$ .

- If the sequential algorithm meets the timing deadlines, consider using option 3.
- If the embedded system provides deterministic scheduling, consider using option 2.
- Otherwise, use option 1 to create opportunities for parallelism by introducing signal delays.

For continuous signals, Simulink uses extrapolation methods to compensate for numerical errors that were introduced due to delays and discontinuities in data transfer.

To avoid numerical errors in signals configured for **Ensure Data Integrity Only** and **Ensure deterministic transfer (maximum delay)** data transfers, you may need to provide an initial condition. You can specify this initial condition in the **Data Transfer** tab of the Signal Properties dialog box. To access this dialog box, right-click the signal line and select **Properties** from the context menu. A dialog box like the following is displayed.

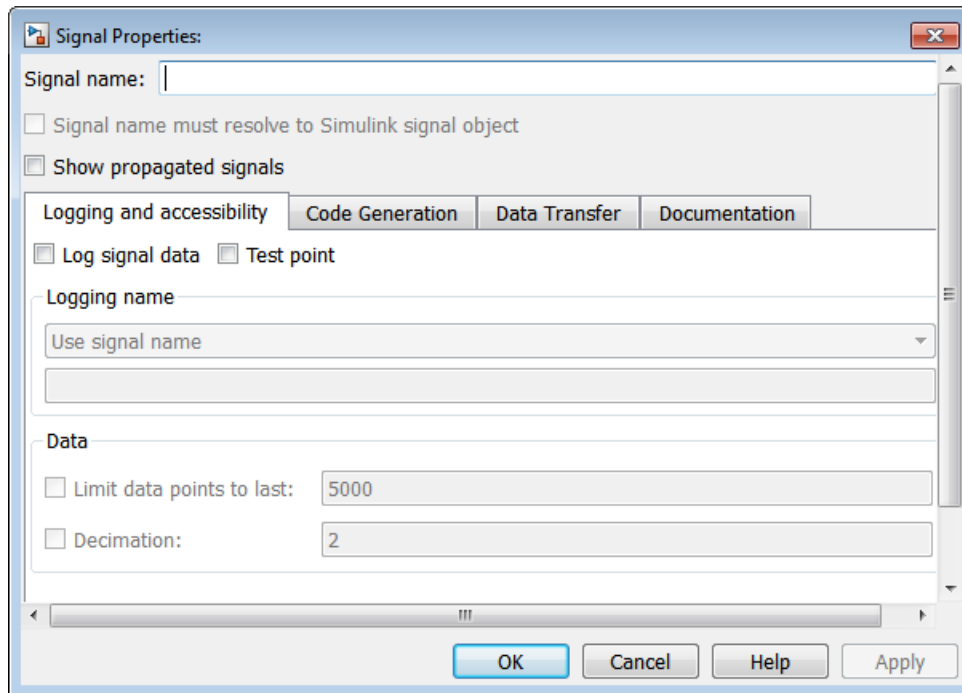

- 1 From the Data Transfer Options table, determine how you want your tasks to communicate.
- 2 In the Concurrent Execution dialog box, select Data Transfer defaults and apply the settings from step 1.

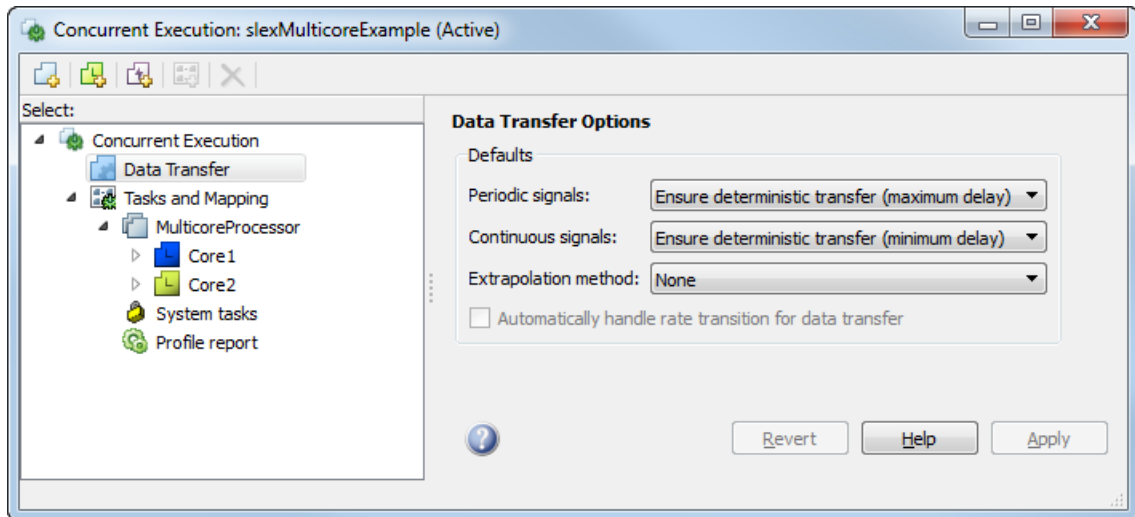

3 Apply your changes.

## More About

- “Multicore Programming with Simulink” on page 14-10
- “Supported Targets For Multicore Programming” on page 14-55
- “Implicit and Explicit Partitioning of Models” on page 14-37

## Optimize and Deploy on a Multicore Target

### In this section...

“Generate Code” on page 14-44

“Build on Desktop” on page 14-45

“Profile and Evaluate on a Desktop” on page 14-47

“Customize the Generated C Code” on page 14-51

This topic shows you how to use a model that is configured for concurrent execution using explicit partitioning and deploy it onto a target. To set up your model for concurrent execution, see “Configure Your Model for Concurrent Execution” on page 14-24. To specify the target architecture, see “Specify a Target Architecture” on page 14-25. To use explicit partitioning in a model that is set up for concurrent execution, see “Partition Your Model Using Explicit Partitioning” on page 14-31.

### Generate Code

To generate code for a model that is configured for concurrent execution, in the Simulink editor window, select **Code > C/C++ Code > Build Model**. The resulting code includes:

- C code for parts of the model that are mapped to tasks and triggers in the Concurrent Execution dialog box. C code generation requires a Simulink Coder license. For more information, see “Code Generation” (Simulink Coder) in the Simulink Coder documentation and “Code Generation from Simulink Models” (Embedded Coder) in the Embedded Coder documentation.
- HDL code for parts of the model that are mapped to hardware nodes in the Concurrent Execution dialog box. HDL code generation requires an HDL Coder license. For more information, see “HDL Code Generation from Simulink” (HDL Coder).
- Code to handle data transfer between the concurrent tasks and triggers and to interface with the hardware and software components.

The generated C code contains one function for each task or trigger defined in the system. The task and trigger determines the name of the function:

```
void <TriggerName>_TaskName(void);
```

The content for each such function consists of target-independent C code, except for:

- Code corresponding to blocks that implement target-specific functionality
- Customizations, including those derived from “Custom Storage Classes” (Embedded Coder) or “Code Replacement Libraries” (Simulink Coder)
- Code that is generated to handle how data is transferred between tasks. In particular, Simulink Coder uses target-specific implementations of mutual exclusion primitives and data synchronization semaphores to implement the data transfer as described in the following table of pseudocode.

Data Transfer	Initialization	Reader	Writer
Data Integrity Only	BufferIndex = 0; Initialize Buffer[1] with IC	Begin mutual exclusion Tmp = 1 – BufferIndex; End mutual exclusiton Read Buffer[ Tmp ];	Write Buffer[ BufferIndex ]; Begin mutual exclusion BufferIndex = 1 – BufferIndex; End mutual exclusion
Ensure Determinism (Maximum Delay)	WriterIndex = 0; ReaderIndex = 1; Initialize Buffer[1] with IC	Read Buffer[ ReaderIndex ]; ReaderIndex = 1 – ReaderIndex;	Write Buffer[ WriterIndex ] WriterIndex = 1 – WriterIndex;
Ensure Determinism (Minimum Delay)	N/A	Wait dataReady; Read data; Post readDone;	Wait readDone; Write data; Post dataReady;
Data Integrity Only C-HDL interface	The Simulink Coder and HDL Coder products both take advantage of target-specific communication implementations and devices to handle the data transfer between hardware and software components.		

The generated HDL code contains one HDL project for each hardware node.

## Build on Desktop

Simulink Coder and Embedded Coder targets provide an example target to generate code for Windows, Linux and Mac OS operating systems. It is known as the *native threads example*, which is used to deploy your model to a desktop target. The desktop may not be your final target, but can help to profile and optimize your model before you deploy it on another target.

If you have specified an Embedded Coder target, make the following changes in the Configuration Parameters dialog box.

- 1 Select the **Code Generation > Templates > Generate an example main program** check box.
- 2 From the **Code Generation > Templates > Target Operating System** list, select **NativeThreadsExample**.
- 3 Click **OK** to save your changes and close the Configuration Parameters dialog box.
- 4 Apply these settings to all referenced models in your model.

Once you have set up your model, press **Ctrl-B** to build and deploy it to your desktop. The native threads example illustrates how Simulink Coder and Embedded Coder use target-specific threading APIs and data management primitives, as shown in “Threading APIs Used by Native Threads Example” on page 14-46. The data transfer between concurrently executing tasks behaves as described in Data Transfer Options. The coder products use the APIs on supported targets for this behavior, as described in “Data Protection and Synchronization APIs Used by Native Threads Example” on page 14-47.

### Threading APIs Used by Native Threads Example

Aspect of Concurrent Execution	Linux Implementation	Windows Implementation	Mac OS Implementation
Periodic triggering event	POSIX timer	Windows timer	Not applicable
Aperiodic triggering event	POSIX real-time signal	Windows event	POSIX non-real-time signal
Aperiodic trigger	For blocks mapped to an aperiodic task: thread waiting for a signal  For blocks mapped to an aperiodic trigger: signal action	Thread waiting for an event	For blocks mapped to an aperiodic task: thread waiting for a signal  For blocks mapped to an aperiodic trigger: signal action
Threads	POSIX	Windows	POSIX
Threads priority	Assigned based on sample time: fastest task has highest priority	Priority class inherited from the parent process.	Assigned based on sample time: fastest task has highest priority



Aspect of Concurrent Execution	Linux Implementation	Windows Implementation	Mac OS Implementation
		Assigned based on sample time: fastest task has highest priority for the first three fastest tasks. The rest of the tasks share the lowest priority.	
Example of overrun detection	Yes	Yes	No

### Data Protection and Synchronization APIs Used by Native Threads Example

API	Linux Implementation	Windows Implementation	Mac OS Implementation
Data protection API	<ul style="list-style-type: none"> <li>• pthread_mutex_init</li> <li>• pthread_mutex_ - destroy</li> <li>• pthread_mutex_lock</li> <li>• pthread_mutex_ - unlock</li> </ul>	<ul style="list-style-type: none"> <li>• CreateMutex</li> <li>• CloseHandle</li> <li>• WaitForSingleObject</li> <li>• ReleaseMutex</li> </ul>	<ul style="list-style-type: none"> <li>• pthread_mutex_init</li> <li>• pthread_mutex_ - destroy</li> <li>• pthread_mutex_lock</li> <li>• pthread_mutex_ - unlock</li> </ul>
Synchronization API	<ul style="list-style-type: none"> <li>• sem_init</li> <li>• sem_destroy</li> <li>• sem_wait</li> <li>• sem_post</li> </ul>	<ul style="list-style-type: none"> <li>• CreateSemaphore</li> <li>• CloseHandle</li> <li>• WaitForSingle-Object</li> <li>• ReleaseSemaphore</li> </ul>	<ul style="list-style-type: none"> <li>• sem_open</li> <li>• sem_unlink</li> <li>• sem_wait</li> <li>• sem_post</li> </ul>

## Profile and Evaluate on a Desktop

Profile the execution of your code on the multicore target using the **Profile Report** pane of the Concurrent Execution dialog box. You can profile using Simulink Coder (GRT) and Embedded Coder (ERT) targets. Profiling helps you identify the areas in your model that are execution bottlenecks. You can analyze the execution time of each task and find the task that takes most of the execution time. For example, you can compare the average

execution times of the tasks. If a task is computation intensive, or does not satisfy real-time requirements and overruns, you can break it into tasks that are less computation intensive and that can run concurrently.

When you generate a profile report, the software:

- 1 Builds the model.
- 2 Generates code for the model.
- 3 Adds tooling to the generated code to collect data.
- 4 Executes the generated code on the target and collects data.
- 5 Collates the data, generates an HTML file (*model\_name\_ProfileReport.html*) in the current folder, and displays that HTML file in the **Profile Report** pane of the Concurrent Execution dialog box.

---

**Note:** If an HTML profile report exists for the model, the **Profile Report** pane

displays that file. To generate a new profile report, click .

---

Section	Description
Summary	Summarizes model execution statistics, such as total execution time and profile report creation time. It also lists the total number of cores on the host machine.
Task Execution Time	Displays the execution time, in microseconds, for each task in a pie chart color coded by task.  Visible for Windows, Linux, and Mac OS platforms.
Task Affinitization to Processor Cores	Platform-dependent. For each time step and task, Simulink displays the processor core number the task started executing on at that time step, color coded by processor.  If there is no task scheduled for a particular time step, NR is displayed.  Visible for Windows and Linux platforms.

After you analyze the profile report, consider changing the mapping of Model blocks to efficiently use the concurrency available on your multicore system (see “Map Blocks to Tasks, Triggers, and Nodes” on page 14-34).

## Generate Profile Report

This topic assumes a previously configured model ready to be profiled for concurrent execution. For more information, see “Configure Your Model for Concurrent Execution” on page 14-24.

- 1 In the Concurrent Execution dialog box, click the **Profile report** node.

The profile tool looks for a file named `model_name_ProfileReport.html`. If such a file does not exist for the current model, the **Profile Report** pane displays the following.

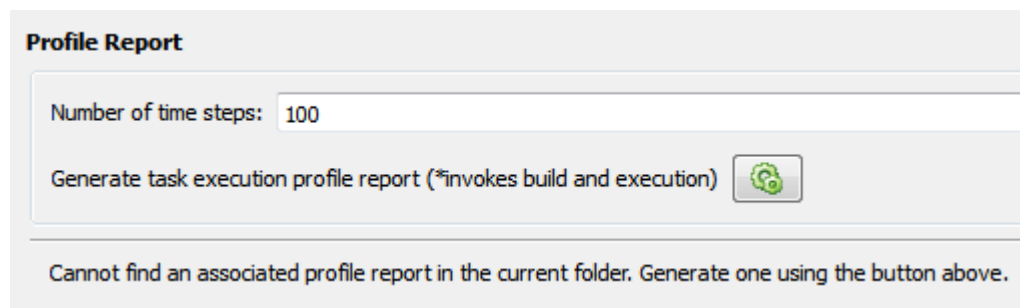

---

**Note:** If an HTML profile report exists for the model, the **Profile Report** pane displays that file. To generate a new profile report, click .

---

- 2 Enter the number of time steps for which you want the profiler to collect data for the model execution.
- 3 Click the **Generate task execution profile report** button.

This action builds the model, generates code, adds data collection tooling to the code, and executes it on the target, which also generates an HTML profile report. This process can take several minutes. When the process is complete, the contents of the profile report appear in the **Profile Report** pane. For example:

### Task Execution Profiling Report for slxMulticoreExample

1. Summary

Total simulation time [seconds]	9.9
Profile data created	Thu Nov 12 16:47:52 2015
Model name	slxMulticoreExample
Number of processor cores on the host machine	12

2. Task Execution Time

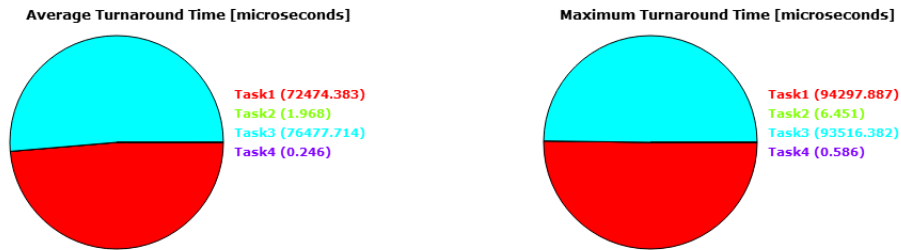

3. Task Affinitization to Processor Cores

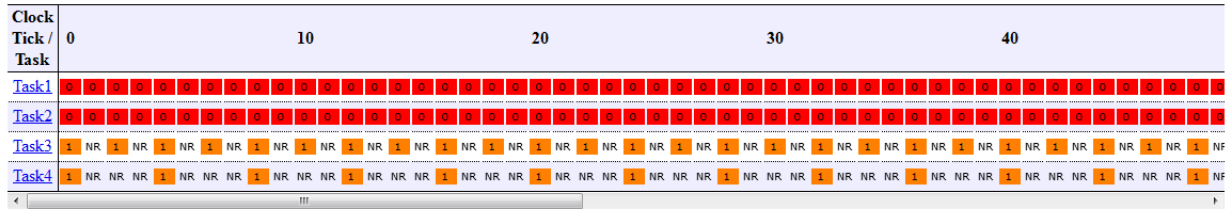

Legend  
NR - Not scheduled to run

The profiling report shows the summary, execution time for each task, and the mapping of each task to processor cores. We see that tasks 1 and 2 run on core 0, where tasks 3 and 4 run on core 1. The **Task Execution Time** section of the report indicates that task 1 and task 3 take the most amount of time to run. Note that the period of task 3 is twice that of tasks 1 and 2, and the period of task 4 is twice that of task 3.

- 4 Analyze the profile report. Create and modify your model or task mapping if needed, and regenerate the profile report.

### Generate Profile Report at Command Line

Alternatively, you can generate a profile report for a model configured for concurrent execution at the command line. Use the `Simulink.architecture.profile` function.

For example, to create a profile report for the model `slexMulticoreSolverExample`:

```
Simulink.architecture.profile('slexMulticoreSolverExample');
```

To create a profile report with a specific number of samples (100) for the model `slexMulticoreSolverExample`:

```
Simulink.architecture.profile('slexMulticoreSolverExample',120);
```

The function creates a profile report named `slexMulticoreSolverExample_ProfileReport.html` in your current folder.

### Customize the Generated C Code

The generated code is suitable for many different applications and development environments. To meet your needs, you can customize the generated C code as described in “Target Development” (Embedded Coder). In addition to those customization capabilities, for multicore and heterogeneous targets you can further customize the generated code as follows:

- You can register your preferred implementation of mutual exclusion and data synchronization primitives using the code replacement library.
- You can define a custom target architecture file that allows you to specify target specific properties for tasks and triggers in the Concurrent Execution dialog box. For more information, see “Define a Custom Architecture File” on page 14-27.

### Related Examples

- “Assigning Tasks to Cores for Multicore Programming”

### More About

- “Multicore Programming with Simulink” on page 14-10

## Concurrent Execution Models

The table contains models configured to work in a concurrent execution environment.

Model	Description
Modeling Concurrent Execution on Multicore Targets	Illustration of how to take advantage of a multicore computer for simulating a plant model. It requires Simulink Coder to generate multithreaded code.
Implement an FFT with Multicore and FPGA	Illustration in which you can accelerate parts of an algorithm by deploying on an FPGA using HDL Coder software. The rest of the algorithm is deployed on a multicore processor.
Assign Code to Cores	Illustration of how to assign code from parts of your model to cores of a multicore processor. It requires Simulink Coder to generate multithreaded code.

### More About

- “Multicore Programming with Simulink” on page 14-10
- “Supported Targets For Multicore Programming” on page 14-55
- “Implicit and Explicit Partitioning of Models” on page 14-37

## Programmatic Interface for Concurrent Execution

Use these functions to configure models for concurrent execution.

To	Use
Create or convert configuration for concurrent execution.	<code>Simulink.architecture.config</code>
Add triggers to the software node or add tasks to triggers.	<code>Simulink.architecture.add</code>
Delete triggers or tasks.	<code>Simulink.architecture.delete</code>
Find objects with specified parameter values.	<code>Simulink.architecture.find_system</code>
Get configuration parameters for target architecture.	<code>Simulink.architecture.get_param</code>
Import and select architecture.	<code>Simulink.architecture.importAndSelect</code>
Generate profile report for model configured for concurrent execution.	<code>Simulink.architecture.profile</code>
Add custom target architecture.	<code>Simulink.architecture.register</code>
Set properties for a concurrent execution object (such as task, trigger, or hardware node).	<code>Simulink.architecture.set_param</code>
Configure concurrent execution data transfers.	<code>Simulink.GlobalDataTransfer</code>

### Map Blocks to Tasks

To map blocks to tasks, use the `set_param` function.

Map a block to one task:

```
set_param(block, 'TargetArchitectureMapping', [bdroot 'CPU/PeriodicTrigger1/Task1']);
```

Map a block to multiple tasks:

```
set_param(block, 'TargetArchitectureMapping', ...  
{{bdroot 'CPU/PeriodicTrigger1/Task1'}}; ...  
[bdroot 'CPU/PeriodicTrigger1/Task2']});
```

Get the current mapping of a block:

```
get_param(block, 'TargetArchitectureMapping');
```

### More About

- “Multicore Programming with Simulink” on page 14-10
- “Supported Targets For Multicore Programming” on page 14-55



## Supported Targets For Multicore Programming

### Supported Multicore Targets

You can build and download concurrent execution models for the following multicore targets using system target files:

- Linux, Windows, and Mac OS using `ert.tlc` and `grt.tlc`.
- Simulink Real-Time using `slrt.tlc`.
- `idelink_ert.tlc`, `idelink_grt.tlc`, and `ert.tlc`, if it is supported for your hardware board.

---

#### Note:

- To build and download your model, you must have Simulink Coder software installed.
  - To build and download your model to a Simulink Real-Time system, you must have Simulink Real-Time software installed. You must also have a multicore target system supported by the Simulink Real-Time product.
  - Deploying to an embedded processor that runs Linux and VxWorks<sup>®</sup> operating systems requires the Embedded Coder product.
- 

### Supported Heterogeneous Targets

In addition to multicore targets, Simulink also supports building and downloading partitions of a model to heterogeneous targets that contain a multicore target and one or more field-programmable gate arrays (FPGAs).

Select the heterogeneous architecture using the Target architecture option in the Concurrent Execution dialog box **Concurrent Execution** pane:

Item	Description
Sample Architecture	Example architecture consisting of single CPU with multiple cores and two FPGAs. You can use this architecture to model for concurrent execution.

Item	Description
Simulink Real-Time	Simulink Real-Time target containing FPGA boards.
Xilinx Zynq ZC702 evaluation kit	Xilinx® Zynq® ZC702 evaluation kit target.
Xilinx Zynq ZC706 evaluation kit	Xilinx Zynq ZC706 evaluation kit target.
Xilinx Zynq Zedboard	Xilinx Zynq ZedBoard™ target.
Altera Cyclone V SoC development kit Rev. C	Altera® Cyclone® SoC Rev. C development kit target.
Altera Cyclone V SoC development kit Rev. D	Altera Cyclone SoC Rev. D development kit target.
Arrow SoCKit development board	Arrow® SoCKit development board target.

---

**Note:** Building HDL code and downloading it to FPGAs requires the HDL Coder product. You can generate HDL code if:

- You have an HDL Coder license
- You are building on Windows or Linux operating systems

You cannot generate HDL code on Macintosh systems.

---

## More About

- “Multicore Programming with Simulink” on page 14-10

## Limitations with Multicore Programming in Simulink

The following limitations apply when partitioning a model for concurrent execution.

- Configure the model to use the fixed-step solver.
- Do not use the following modes of simulation for models in the concurrent execution environment:
  - External mode
  - Logging to MAT-files (**All Parameters > MAT-file logging** check box selected). However, you can use the To Workspace and To File blocks.
  - If you are simulating your model using Rapid Accelerator mode, the top-level model cannot contain a root level Inport block that outputs function calls.
  - In the Configuration Parameters dialog box, set the **Diagnostics > Sample Time > Multitask conditionally executed subsystem** and **Diagnostics > Data Validity > Multitask data store** parameters to `error`.
  - In addition, use the model-level control to handle data transfer for rate transition or if you use Rate Transition blocks, then:
    - Select the **Ensure data integrity during data transfer** check box.
    - Clear the **Ensure deterministic data transfer (maximum delay)** check box.
- If you want to use explicit partitioning, your model must consist entirely of Model blocks, MATLAB System blocks, and virtual connectivity blocks at the root-level. The following are valid virtual connectivity blocks:
  - Goto and From blocks
  - Ground and Terminator blocks
  - Inport and Outport blocks
  - Virtual subsystem blocks that contain permitted blocks

### More About

- “Multicore Programming with Simulink” on page 14-10
- “Supported Targets For Multicore Programming” on page 14-55



# Modeling Best Practices

---

- “General Considerations when Building Simulink Models” on page 15-2
- “Model a Continuous System” on page 15-8
- “Best-Form Mathematical Models” on page 15-11
- “Model a Simple Equation” on page 15-15
- “Model Differential Algebraic Equations” on page 15-17
- “Componentization Guidelines” on page 15-29
- “Model Complex Logic” on page 15-46
- “Model Physical Systems” on page 15-47
- “Model Signal Processing Systems” on page 15-48

## General Considerations when Building Simulink Models

### In this section...

“Avoiding Invalid Loops” on page 15-2

“Shadowed Files” on page 15-4

“Model Building Tips” on page 15-6

### Avoiding Invalid Loops

You can connect the output of a block directly or indirectly (i.e., via other blocks) to its input, thereby, creating a loop. Loops can be very useful. For example, you can use loops to solve differential equations diagrammatically (see “Model a Continuous System” on page 15-8) or model feedback control systems. However, it is also possible to create loops that cannot be simulated. Common types of invalid loops include:

- Loops that create invalid function-call connections or an attempt to modify the input/output arguments of a function call (see “Function-Call Subsystems” on page 10-23 for a description of function-call subsystems)
- Self-triggering subsystems and loops containing non-latched triggered subsystems (see “Triggered Subsystems” on page 10-14 in the Using Simulink documentation for a description of triggered subsystems and **Inport** in the Simulink reference documentation for a description of latched input)
- Loops containing action subsystems

The Subsystem Examples block library in the Ports & Subsystems library contains models that illustrates examples of valid and invalid loops involving triggered and function-call subsystems. Examples of invalid loops include the following models:

- `simulink/Ports&Subsystems/sl_subsys_semantics/Triggered subsystem/sl_subsys_trigerr1 (sl_subsys_trigerr1)`
- `simulink/Ports&Subsystems/sl_subsys_semantics/Triggered subsystem/sl_subsys_trigerr2 (sl_subsys_trigerr2)`
- `simulink/Ports&Subsystems/sl_subsys_semantics/Function-call systems/sl_subsys_fcncallerr3 (sl_subsys_fcncallerr3)`

You might find it useful to study these examples to avoid creating invalid loops in your own models.

## Detecting Invalid Loops

To detect whether your model contains invalid loops, select **Update Diagram** from the model's **Simulation** menu. If the model contains invalid loops, the invalid loops are highlighted. This is illustrated in the following model ,

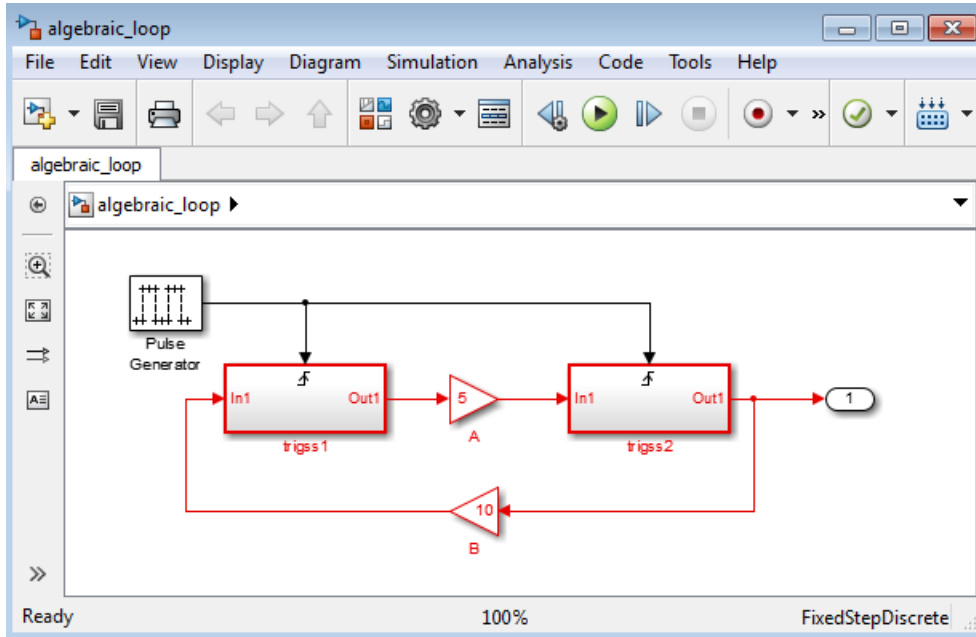

and displays an error message in the Diagnostic Viewer.

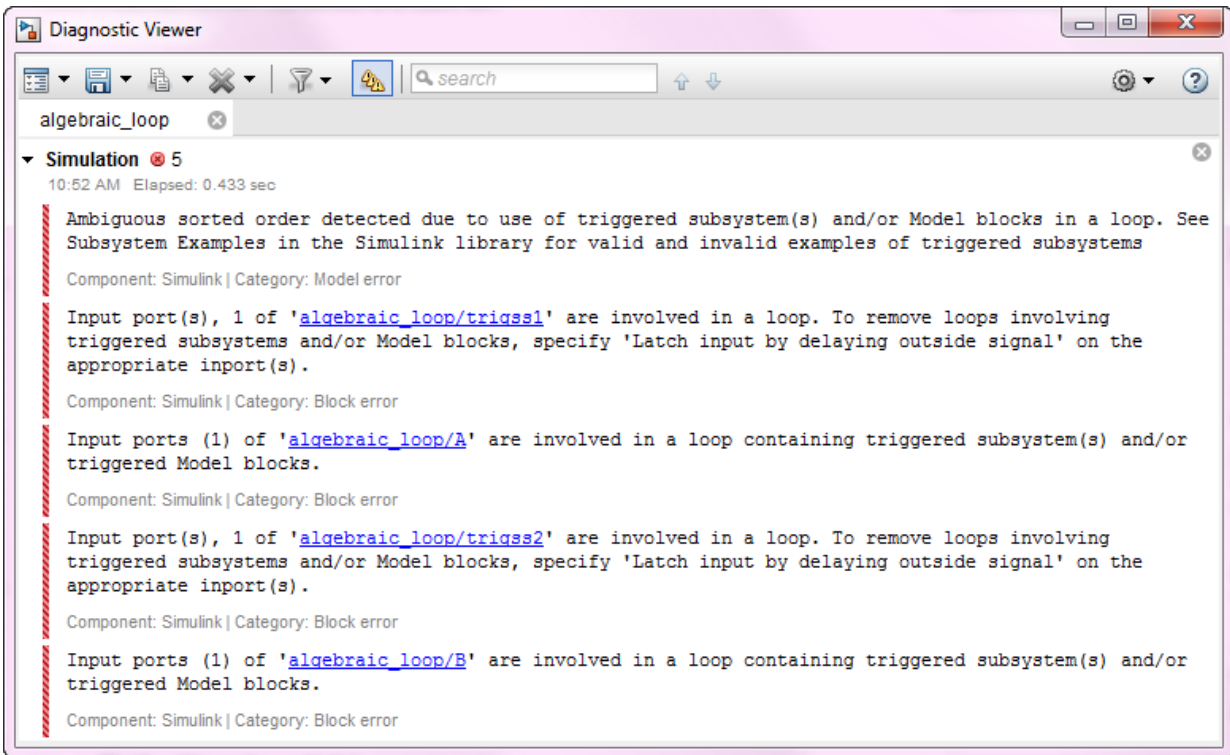

## Shadowed Files

If there are two Model files with the same name (e.g. `mylibrary.slx`) on the MATLAB path, the one higher on the path is loaded, and the one lower on the path is said to be "shadowed".

---

**Tip:** To help avoid problems with shadowed files, turn on the Simulink preference **Do not load models that are shadowed on the MATLAB path**. See “Do not load models that are shadowed on the MATLAB path”.

---

The rules Simulink software uses to find Model files are similar to those used by MATLAB software. See “What Is the MATLAB Search Path?” (MATLAB) in the MATLAB documentation. However, there is an important difference between how



Simulink block diagrams and MATLAB functions are handled: a loaded block diagram takes precedence over any unloaded ones, regardless of its position on the MATLAB path. This is done for performance reasons, as part of the Simulink software's incremental loading methodology.

The precedence of a loaded block diagram over any others can have important implications, particularly since a block diagram can be loaded without the corresponding Simulink window being visible.

### **Making Sure the Correct Block Diagram Is Loaded**

When using libraries and referenced models, you can load a block diagram without showing its window. If the MATLAB path or the current MATLAB folder changes while block diagrams are in memory, these block diagrams can interfere with the use of other files of the same name.

For example, open a model with a library called `mylib`, change to another folder, and then open another model with a library also called `mylib`. When you run the first model, it uses the library associated with the second model.

This can lead to problems including:

- Simulation errors
- "Unresolved Link" icons on blocks that are library links
- Wrong results

### **Detecting and Fixing Problems**

To help avoid problems with shadowed files, you can turn on the Simulink preference **Do not load models that are shadowed on the MATLAB path**. See “Do not load models that are shadowed on the MATLAB path”.

When updating a block diagram, the Simulink software checks the position of its file on the MATLAB path and will issue a warning if it detects that another file of the same name exists and is higher on the MATLAB path. The warning reads:

```
The file containing block diagram 'mylibrary' is shadowed
by a file of the same name higher on the MATLAB path.
This may indicate that the wrong file called mylibrary.slx is being used. To see which
file called mylibrary.slx is loaded into memory, enter:
```

```
which mylibrary
```

```
C:\work\Model1\mylibrary.slx
```

To see all the files called `mylibrary` which are on the MATLAB path, including MATLAB scripts, enter:

```
which -all mylibrary
```

```
C:\work\Model1\mylibrary.slx
```

```
C:\work\Model2\mylibrary.slx % Shadowed
```

To close the block diagram called `mylibrary` and let the Simulink software load the file which is highest on the MATLAB path, enter:

```
close_system('mylibrary')
```

## Model Building Tips

Here are some model-building hints you might find useful:

- Memory issues

In general, more memory will increase performance.

- Using hierarchy

More complex models often benefit from adding the hierarchy of subsystems to the model. Grouping blocks simplifies the top level of the model and can make it easier to read and understand the model. For more information, see “Create a Subsystem” on page 4-18. The Model Browser provides useful information about complex models (see “Explore the Model Hierarchy Using the Model Browser” on page 12-48).

- Cleaning up models

Well organized and documented models are easier to read and understand. Signal labels and model annotations can help describe what is happening in a model. For more information, see “Signal Names and Labels” on page 62-4 and “Describe Models Using Annotations” on page 4-3.

- Modeling strategies

If several of your models tend to use the same blocks, you might find it easier to save these blocks in a model. Then, when you build new models, just open this model and copy the commonly used blocks from it. You can create a block library by placing a collection of blocks into a system and saving the system. You can then access the system by typing its name in the MATLAB Command Window.

Generally, when building a model, design it first on paper, then build it using the computer. Then, when you start putting the blocks together into a model, add the blocks to the model window before adding the lines that connect them. This way, you can reduce how often you need to open block libraries.

## **Related Examples**

- “Model a Continuous System” on page 15-8
- “Best-Form Mathematical Models” on page 15-11
- “Model a Simple Equation” on page 15-15
- “Model Differential Algebraic Equations” on page 15-17
- “Model Complex Logic” on page 15-46
- “Model Physical Systems” on page 15-47
- “Model Signal Processing Systems” on page 15-48

## **More About**

- “Componentization Guidelines” on page 15-29

## Model a Continuous System

To model the differential equation

$$x' = -2x(t) + u(t),$$

where  $u(t)$  is a square wave with an amplitude of 1 and a frequency of 1 rad/sec, use an integrator block and a gain block. The Integrator block integrates its input  $x'$  to produce  $x$ . Other blocks needed in this model include a Gain block and a Sum block. To generate a square wave, use a Signal Generator block and select the Square Wave form but change the default units to radians/sec. Again, view the output using a Scope block. Gather the blocks and define the gain.

In this model, to reverse the direction of the Gain block, select the block, then use the **Diagram > Rotate & Flip > Flip Block** command. To create the branch line from the output of the Integrator block to the Gain block, hold down the **Ctrl** key while drawing the line. For more information, see “Branch a Connection” on page 1-28.

Now you can connect all the blocks.

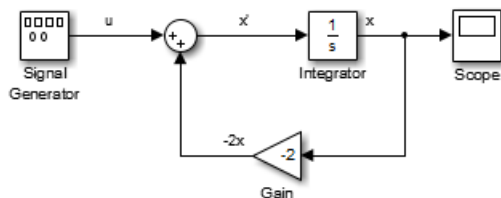

An important concept in this model is the loop that includes the Sum block, the Integrator block, and the Gain block. In this equation,  $x$  is the output of the Integrator block. It is also the input to the blocks that compute  $x'$ , on which it is based. This relationship is implemented using a loop.

The Scope displays  $x$  at each time step. For a simulation lasting 10 seconds, the output looks like this:

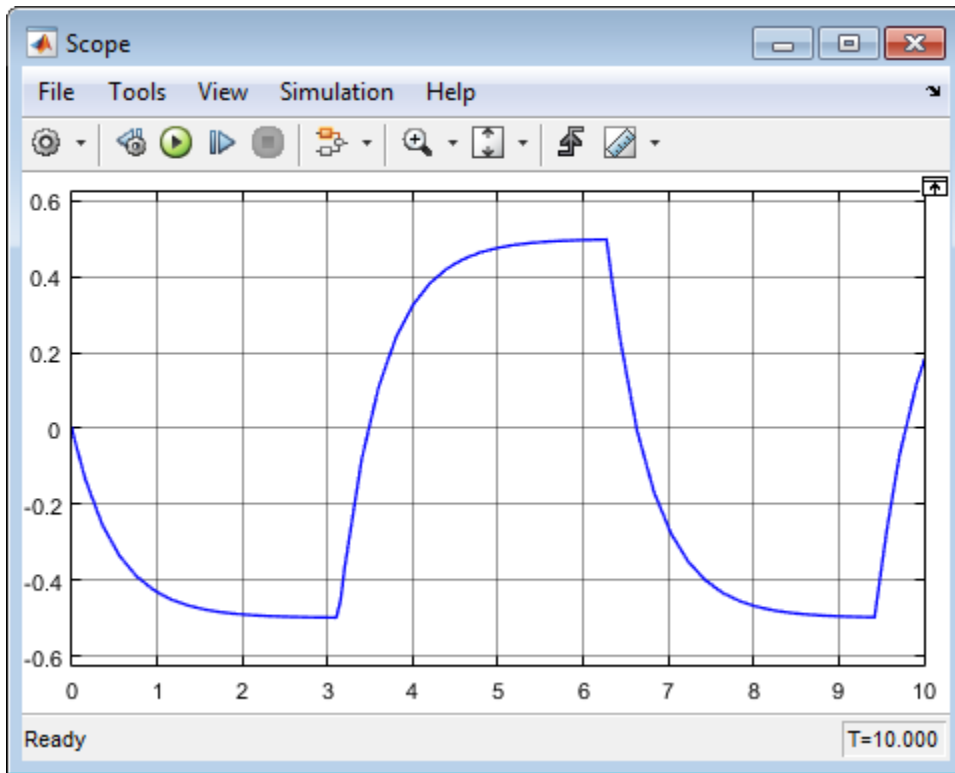

The equation you modeled in this example can also be expressed as a transfer function. The model uses the Transfer Fcn block, which accepts  $u$  as input and outputs  $x$ . So, the block implements  $x/u$ . If you substitute  $sx$  for  $x'$  in the above equation, you get  $sx = -2x + u$ .

Solving for  $x$  gives

$$x = u/(s + 2)$$

or,

$$x/u = 1/(s + 2).$$

The Transfer Fcn block uses parameters to specify the numerator and denominator coefficients. In this case, the numerator is 1 and the denominator is  $s+2$ . Specify both terms as vectors of coefficients of successively decreasing powers of  $s$ .

In this case the numerator is [ 1 ] (or just 1) and the denominator is [ 1 2 ].

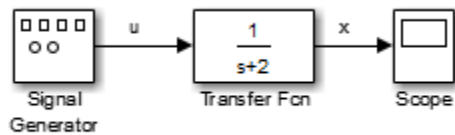

The results of this simulation are identical to those of the previous model.

### Related Examples

- “Model Physical Systems” on page 15-47
- “Model Signal Processing Systems” on page 15-48
- “Model Complex Logic” on page 15-46

### More About

- “General Considerations when Building Simulink Models” on page 15-2
- “Componentization Guidelines” on page 15-29

## Best-Form Mathematical Models

### In this section...

“Series RLC Example” on page 15-11

“Solving Series RLC Using Resistor Voltage” on page 15-12

“Solving Series RLC Using Inductor Voltage” on page 15-13

### Series RLC Example

You can often formulate the mathematical system you are modeling in several ways. Choosing the best-form mathematical model allows the simulation to execute faster and more accurately. For example, consider a simple series RLC circuit.

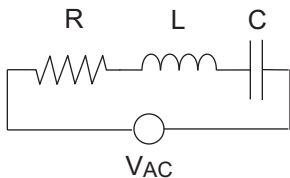

According to Kirchoff's voltage law, the voltage drop across this circuit is equal to the sum of the voltage drop across each element of the circuit.

$$V_{AC} = V_R + V_L + V_C$$

Using Ohm's law to solve for the voltage across each element of the circuit, the equation for this circuit can be written as

$$V_{AC} = Ri + L \frac{di}{dt} + \frac{1}{C} \int_{-\infty}^t i(t) dt$$

You can model this system in Simulink by solving for either the resistor voltage or inductor voltage. Which you choose to solve for affects the structure of the model and its performance.

## Solving Series RLC Using Resistor Voltage

Solving the RLC circuit for the resistor voltage yields

$$V_R = Ri$$

$$Ri = V_{AC} - L \frac{di}{dt} - \frac{1}{C} \int_{-\infty}^t i(t) dt$$

### Circuit Model

The following diagram shows this equation modeled in Simulink where  $R$  is 70,  $C$  is 0.00003, and  $L$  is 0.04. The resistor voltage is the sum of the voltage source, the capacitor voltage, and the inductor voltage. You need the current in the circuit to calculate the capacitor and inductor voltages. To calculate the current, multiply the resistor voltage by a gain of  $1/R$ . Calculate the capacitor voltage by integrating the current and multiplying by a gain of  $1/C$ . Calculate the inductor voltage by taking the derivative of the current and multiplying by a gain of  $L$ .

**Series RLC Circuit: Formulated to solve for resistor current**

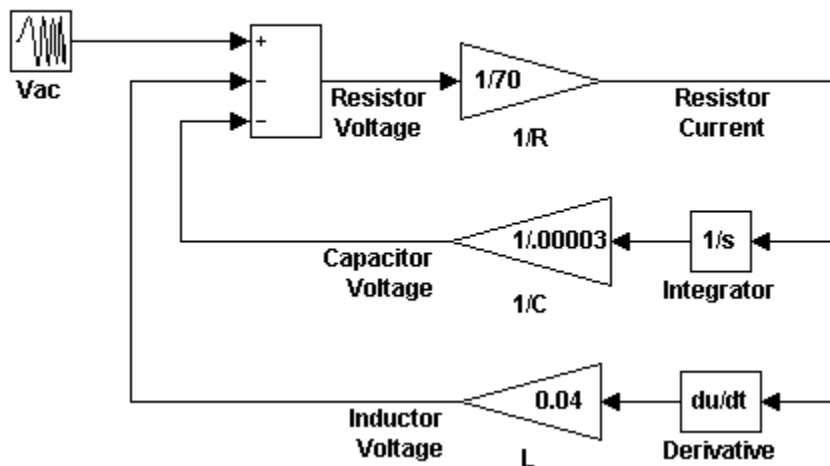

This formulation contains a Derivative block associated with the inductor. Whenever possible, you should avoid mathematical formulations that require Derivative blocks as they introduce discontinuities into your system. Numerical integration is used to solve the model dynamics through time. These integration solvers take small steps through



time to satisfy an accuracy constraint on the solution. If the discontinuity introduced by the Derivative block is too large, it is not possible for the solver to step across it.

In addition, in this model the Derivative, Sum, and two Gain blocks create an algebraic loop. Algebraic loops slow down the model's execution and can produce less accurate simulation results. See “Algebraic Loops” on page 3-38 for more information.

## Solving Series RLC Using Inductor Voltage

To avoid using a Derivative block, formulate the equation to solve for the inductor voltage.

$$V_L = L \frac{di}{dt}$$

$$L \frac{di}{dt} = V_{AC} - Ri - \frac{1}{C} \int_{-\infty}^t i(t) dt$$

### Circuit Model

The following diagram shows this equation modeled in Simulink. The inductor voltage is the sum of the voltage source, the resistor voltage, and the capacitor voltage. You need the current in the circuit to calculate the resistor and capacitor voltages. To calculate the current, integrate the inductor voltage and divide by  $L$ . Calculate the capacitor voltage by integrating the current and dividing by  $C$ . Calculate the resistor voltage by multiplying the current by a gain of  $R$ .

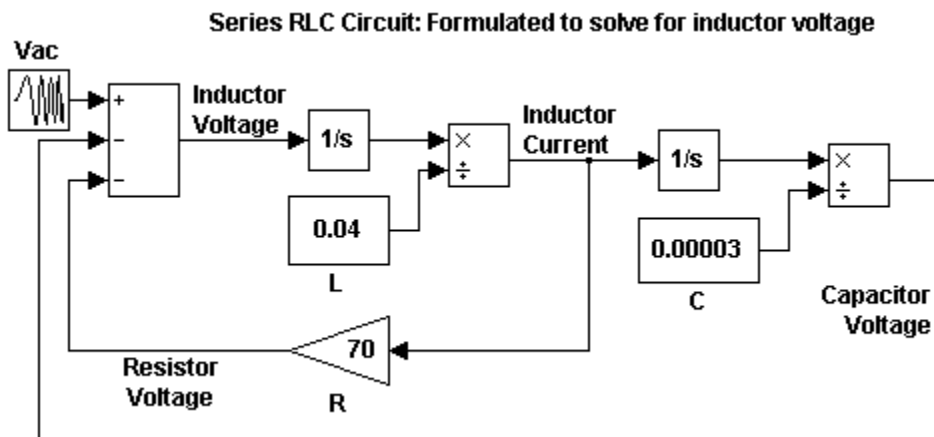

This model contains only integrator blocks and no algebraic loops. As a result, the model simulates faster and more accurately.

### **Related Examples**

- “Model a Simple Equation” on page 15-15
- “Model Differential Algebraic Equations” on page 15-17
- “Model Complex Logic” on page 15-46

### **More About**

- “General Considerations when Building Simulink Models” on page 15-2
- “Componentization Guidelines” on page 15-29

## Model a Simple Equation

To model the equation that converts Celsius temperature to Fahrenheit

$$T_F = 9/5(T_C) + 32$$

First, consider the blocks needed to build the model:

- A Ramp block to input the temperature signal, from the Sources library
- A Constant block to define a constant of 32, also from the Sources library
- A Gain block to multiply the input signal by 9/5, from the Math Operations library
- A Sum block to add the two quantities, also from the Math Operations library
- A Scope block to display the output, from the Sinks library

Next, gather the blocks into your model window.

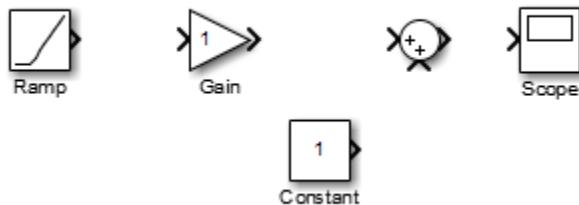

Assign parameter values to the Gain and Constant blocks by opening (double-clicking) each block and entering the appropriate value. Then, click the **OK** button to apply the value and close the dialog box.

Now, connect the blocks.

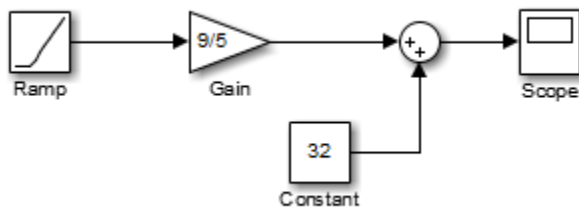

The Ramp block inputs Celsius temperature. Open that block and change the **Initial output** parameter to 0. The Gain block multiplies that temperature by the constant  $9/5$ . The Sum block adds the value 32 to the result and outputs the Fahrenheit temperature.

Open the Scope block to view the output. Now, choose **Run** from the **Simulation** menu to run the simulation. The simulation runs for 10 seconds.

### **Related Examples**

- “Best-Form Mathematical Models” on page 15-11
- “Model Differential Algebraic Equations” on page 15-17
- “Model Complex Logic” on page 15-46

### **More About**

- “General Considerations when Building Simulink Models” on page 15-2
- “Componentization Guidelines” on page 15-29

# Model Differential Algebraic Equations

## In this section...

“Overview of Robertson Reaction Example” on page 15-17

“Simulink Model from ODE Equations” on page 15-17

“Simulink Model from DAE Equations” on page 15-20

“Simulink Model from DAE Equations Using Algebraic Constraint Block” on page 15-23

## Overview of Robertson Reaction Example

Robertson [1] created a system of autocatalytic chemical reactions to test and compare numerical solvers for stiff systems. The reactions, rate constants ( $k$ ), and reaction rates ( $V$ ) for the system are given as follows:

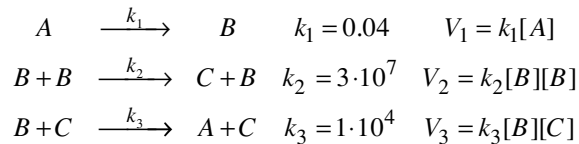

Because there are large differences between the reaction rates, the numerical solvers see the differential equations as stiff. For stiff differential equations, some numerical solvers cannot converge on a solution unless the step size is extremely small. If the step size is extremely small, the simulation time can be unacceptably long. In this case, you need to use a numerical solver designed to solve stiff equations.

## Simulink Model from ODE Equations

A system of ordinary differential equations (ODE) has the following characteristics:

- All of the equations are ordinary differential equations.
- Each equation is the derivative of a dependent variable with respect to one independent variable, usually time.
- The number of equations is equal to the number of dependent variables in the system.

Using the reaction rates, you can create a set of differential equations describing the rate of change for each chemical species. Since there are three species, there are three differential equations in the mathematical model.

$$A' = -0.04A + 1 \cdot 10^4 BC$$

$$B' = 0.04A - 1 \cdot 10^4 BC - 3 \cdot 10^7 B^2$$

$$C' = 3 \cdot 10^7 B^2$$

Initial conditions:  $A = 1$ ,  $B = 0$ , and  $C = 0$ .

### Build the Model

Create a model, or open the model `ex_hb1ode`.

- 1 Add three Integrator blocks to your model. Label the inputs  $A'$ ,  $B'$ , and  $C'$ , and the outputs  $A$ ,  $B$ , and  $C$  respectively.
- 2 Add Sum, Product, and Gain blocks to solve each differential variable. For example, to model the signal  $C'$ ,
  - a Add a Math Function block and connect the input to signal  $B$ . Set the **Function** parameter to **square**.
  - b Connect the output from the Math Function block to a Gain block. Set the **Gain** parameter to  $3e7$ .
  - c Continue to add the remaining differential equation terms to your model.
- 3 Model the initial condition of  $A$  by setting the **Initial condition** parameter for the  $A$  Integrator block to 1.
- 4 Add Out blocks to save the signals  $A$ ,  $B$ , and  $C$  to the MATLAB variable `yout`.

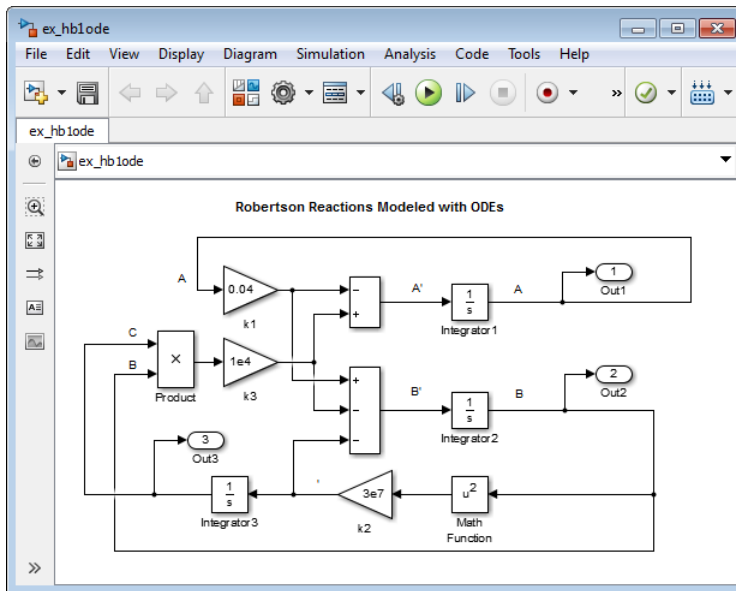

## Simulate the Model

Create a script that uses the `sim` command to simulate your model. This script saves the simulation results in the MATLAB variable `yout`. Since the simulation has a long time interval and `B` initially changes very fast, plotting values on a logarithmic scale helps to visually compare the results. Also, since the value of `B` is small relative to the values of `A` and `C`, multiply `B` by  $1 \cdot 10^4$  before plotting the values.

- 1 Enter the following statements in a MATLAB script. If you built your own model, replace `ex_hb1ode` with the name of your model.

```
sim('ex_hb1ode')
yout(:,2) = 1e4*yout(:,2);
figure;
semilogx(tout,yout);
xlabel('Time');
ylabel('Concentration');
title('Robertson Reactions Modeled with ODEs')
```

- 2 From the Simulink Editor menu, select **Simulation > Model Configuration Parameters**:

- In the Solver pane, set the **Stop time** to  $4e5$  and the **Solver** to `ode15s` (stiff/NDF).
  - In the Data Import pane, select the **Time** and **Output** check boxes.
- 3 Run the script. Observe that all of A is converted to C.

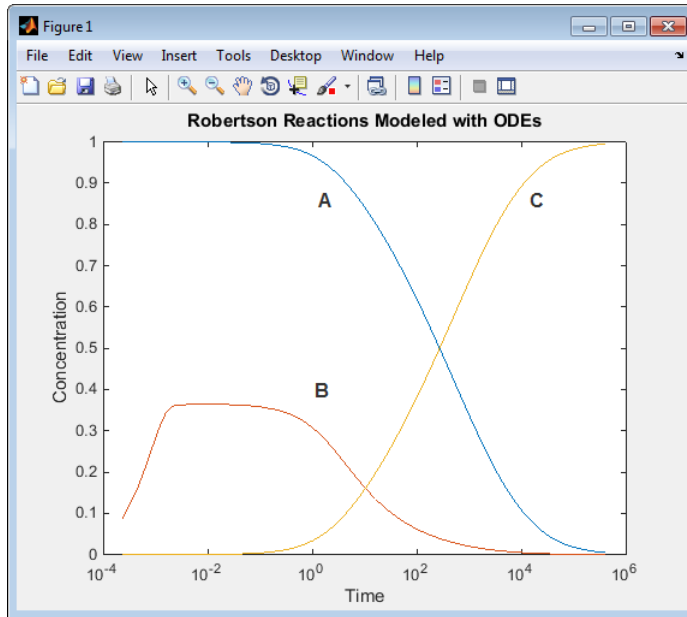

## Simulink Model from DAE Equations

A system of differential algebraic equations (DAE) has the following characteristics:

- It contains both ordinary differential equations and algebraic equations. Algebraic equations do not have any derivatives.
- Only some of the equations are differential equations defining the derivatives of some of the dependent variables. The other dependent variables are defined with algebraic equations.
- The number of equations is equal to the number of dependent variables in the system.



Some systems contain constraints due to conservation laws, such as conservation of mass and energy. If you set the initial concentrations to  $A = 1$ ,  $B = 0$ , and  $C = 0$ , the total concentration of the three species is always equal to 1 since  $A + B + C = 1$ . You can replace the differential equation for  $C'$  with the following algebraic equation to create a set of differential algebraic equations (DAEs).

$$C = 1 - A - B$$

The differential variables  $A$  and  $B$  uniquely determine the algebraic variable  $C$ .

$$A' = -0.04A + 1 \cdot 10^4 BC$$

$$B' = 0.04A - 1 \cdot 10^4 BC - 3 \cdot 10^7 B^2$$

$$C = 1 - A - B$$

Initial conditions:  $A = 1$  and  $B = 0$ .

### Build the Model

Make these changes to your model or to the model `ex_hb1ode`, or open the model `ex_hb1dae`.

- 1 Delete the Integrator block for calculating  $C$ .
- 2 Add a Sum block and set the **List of signs** parameter to  $+--$ .
- 3 Connect the signals  $A$  and  $B$  to the minus inputs of the Sum block.
- 4 Model the initial concentration of  $A$  with a Constant block connected to the plus input of the Sum block. Set the **Constant value** parameter to 1.
- 5 Connect the output of the Sum block to the branched line connected to the Product and Out blocks.

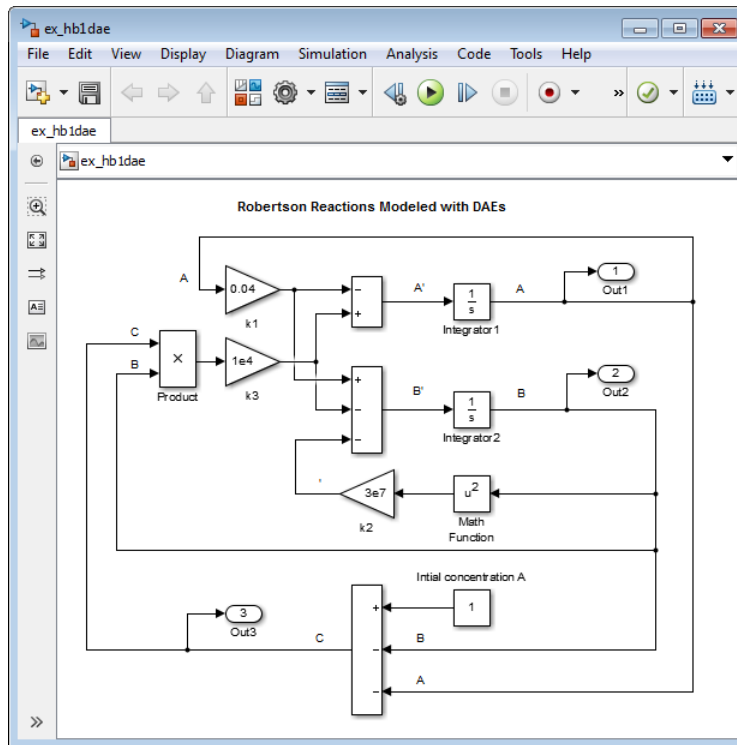

### Simulate the Model

Create a script that uses the `sim` command to simulate your model.

- 1 Enter the following statements in a MATLAB script. If you built your own model, replace `ex_hb1dae` with the name of your model.

```
sim('ex_hb1dae')
yout(:,2) = 1e4*yout(:,2);
figure;
semilogx(tout,yout);
xlabel('Time');
ylabel('Concentration');
title('Robertson Reactions Modeled with DAEs')
```

- 2 From the Simulink Editor menu, select **Simulation > Model Configuration Parameters**:

- In the Solver pane, set the **Stop time** to  $4e5$  and the **Solver** to `ode15s` (`stiff/NDF`).
  - In the Data Import pane, select the **Time** and **Output** check boxes.
- 3** Run the script. The simulation results when you use an algebraic equation are the same as for the model simulation using only differential equations.

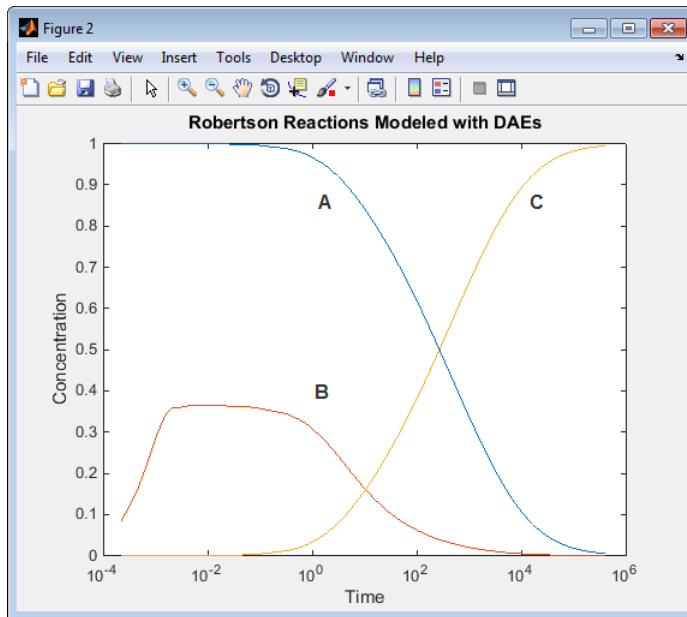

## Simulink Model from DAE Equations Using Algebraic Constraint Block

Some systems contain constraints due to conservation laws, such as conservation of mass and energy. If you set the initial concentrations to  $A = 1$ ,  $B = 0$ , and  $C = 0$ , the total concentration of the three species is always equal to 1 since  $A + B + C = 1$ .

You can replace the differential equation for  $C'$  with an algebraic equation modeled using an Algebraic Constraint block and a Sum block. The Algebraic Constraint block constrains its input signal  $F(z)$  to zero and outputs an algebraic state  $z$ . In other words, the block output is a value needed to produce a zero at the input. Use the following algebraic equation for input to the block.

$$0 = A + B + C - 1$$

The differential variables  $A$  and  $B$  uniquely determine the algebraic variable  $C$ .

$$A' = -0.04A + 1 \cdot 10^4 BC$$

$$B' = 0.04A - 1 \cdot 10^4 BC - 3 \cdot 10^7 B^2$$

$$C = 1 - A - B$$

Initial conditions:  $A = 1$ ,  $B = 0$ , and  $C = 1 \cdot 10^{-3}$ .

### Build the Model

Make these changes to your model or to the model `ex_hb1ode`, or open the model `ex_hb1dae_acb`.

- 1 Delete the Integrator block for calculating  $C$ .
- 2 Add an Algebraic Constraint block. Set the **Initial guess** parameter to `1e-3`.
- 3 Add a Sum block. Set the **List of signs** parameter to `-+++`.
- 4 Connect the signals  $A$  and  $B$  to plus inputs of the Sum block.
- 5 Model the initial concentration of  $A$  with a Constant block connected to the minus input of the Sum block. Set the **Constant value** parameter to `1`.
- 6 Connect the output of the Algebraic Constraint block to the branched line connected to the Product and Out block inputs.
- 7 Create a branch line from the output of the Algebraic Constraint block to the final plus input of the Sum block.

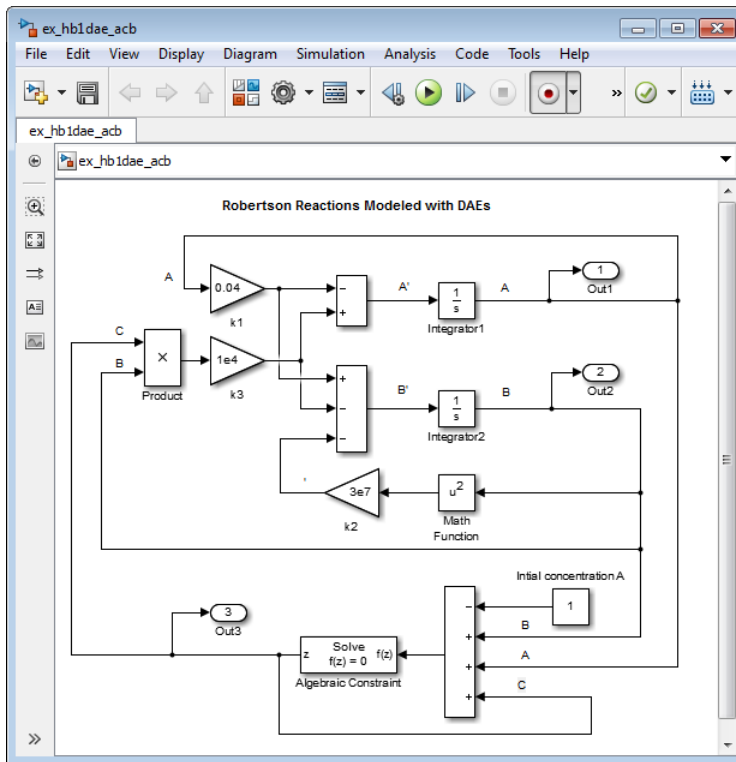

## Simulate the Model

Create a script that uses the `sim` command to simulate your model.

- 1 Enter the following statements in a MATLAB script. If you built your own model, replace `ex_hb1_acb` with the name of your model.

```
sim('ex_hb1dae_acb')
yout(:,2) = 1e4*yout(:,2);
figure;
semilogx(tout,yout);
xlabel('Time');
ylabel('Concentration');
title('Robertson Reactions Modeled with DAEs and Algebraic Constraint Block')
```

- 2 From the Simulink Editor menu, select **Simulation > Model Configuration Parameters**:

- In the Solver pane, set the **Stop time** to  $4e5$  and the **Solver** to `ode15s` (stiff/NDF).
  - In the Data Import pane, select the **Time** and **Output** check boxes.
- 3 Run the script. The simulation results when you use an Algebraic Constraint block are the same as for the model simulation using only differential equations.

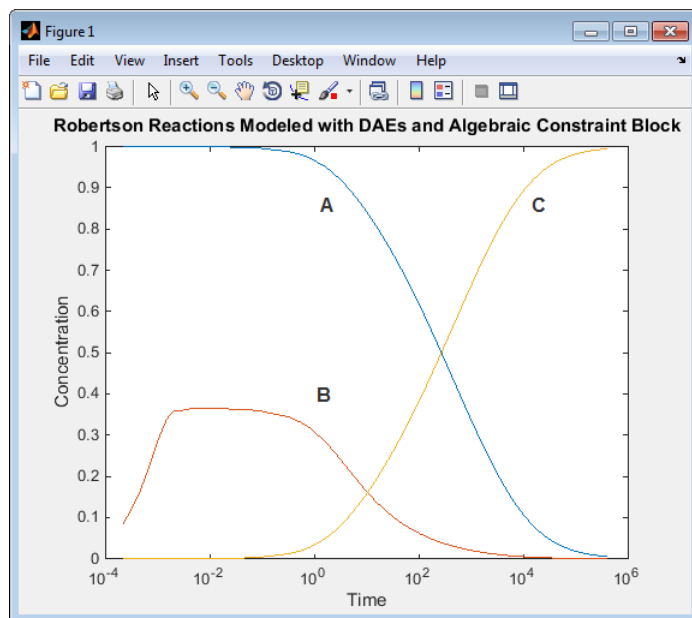

Using an Algebraic Constraint block creates an algebraic loop in a model, If you set the **Algebraic Loop** parameter to `warning` (**Simulation > Model Configuration Parameters > Diagnostics > Algebraic Loop**), the following message displays in the Diagnostic Viewer during simulation.

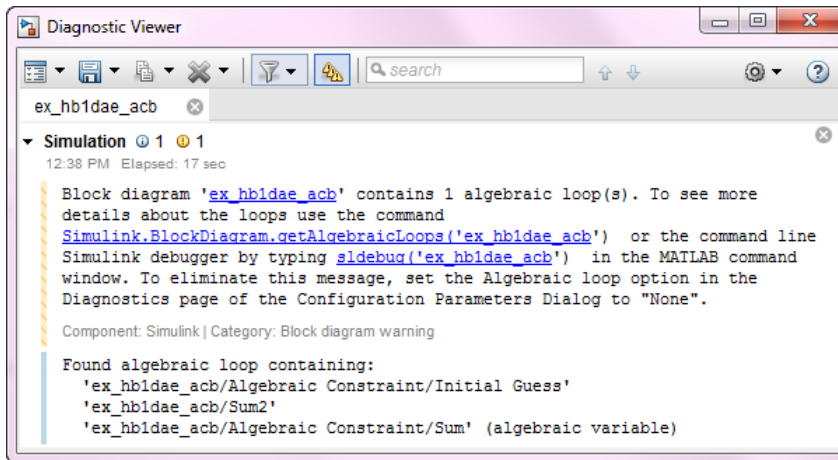

For this model, the algebraic loop solver was able to find a solution for the simulation, but algebraic loops don't always have a solution, and they are not supported for code generation. For more information about algebraic loops in Simulink models and how to remove them, see “Algebraic Loops” on page 3-38.

hb1odehb1dae

## References

- [1] Robertson, H. H. “The solution of a set of reaction rate equations.” *Numerical Analysis: An Introduction* (J. Walsh ed.). London, England:Academic Press, 1966, pp. 178–182.

## See Also

hb1dae | hb1ode

## Related Examples

- “Best-Form Mathematical Models” on page 15-11
- “Model Differential Algebraic Equations” on page 15-17
- “Model Complex Logic” on page 15-46

### **More About**

- “General Considerations when Building Simulink Models” on page 15-2
- “Componentization Guidelines” on page 15-29



# Componentization Guidelines

## Componentization

A component is a piece of your design, a unit level item, or a subassembly, that you can work on without needing the higher level parts of the model.

Componentization involves organizing your model into components. Componentization provides many benefits for organizations that develop large Simulink models that consist of many functional pieces. The benefits include:

- Meeting development process requirements, such as:
  - Component reuse
  - Team-based development
  - Intellectual property protection
  - Unit testing
- Improving performance for:
  - Model loading
  - Simulation speed
  - Memory usage

## Componentization Techniques

Key componentization techniques that you can use with Simulink include:

- Subsystems
- Libraries
- Model referencing

These componentization techniques support a wide range of modeling requirements for models that vary in size and complexity. Most large models use a combination of componentization techniques. For example, you can include subsystems in referenced models, and include referenced models in subsystems. As another example, a large model might use model reference Accelerator blocks at the top level component partitions and blend model reference Accelerator and atomic subsystem libraries at lower levels.

Simulink provides tools to convert from subsystems to model referencing. Because of the differences between subsystems and model referencing, switching from subsystems to model referencing can involve several steps (see *Converting a Subsystem to a Referenced Model* on page 8-17). Consider scalability and support for anticipated future modeling requirements, such as how a model is likely to grow in size and complexity and possible code generation requirements. Designing a scalable architecture can avoid later conversion costs.

## General Componentization Guidelines

This table provides high-level guidelines about the kinds of modeling goals and models for which subsystems, libraries, and model referencing are each particularly well suited.

Componentization Technique	Modeling Goals for Which the Technique Is Well Suited
Subsystems	<ul style="list-style-type: none"> <li>• Add hierarchy to organize and visually simplify a model.</li> <li>• Maximize design reuse with inherited attributes for context-dependent behavior.</li> </ul>
Libraries	<ul style="list-style-type: none"> <li>• Provide a frequently used, and infrequently changed, modeling utility.</li> <li>• Reuse components repeatedly in a model or in multiple models.</li> </ul>
Model referencing	<ul style="list-style-type: none"> <li>• Develop a referenced model independently from the models that use it.</li> <li>• Obscure the contents of a referenced model, allowing you to distribute it without revealing the intellectual property that it embodies.</li> <li>• Reference a model multiple times without having to make redundant copies.</li> <li>• Facilitate changes by multiple people, with defined interfaces for top-level components.</li> <li>• Improve the overall performance by using incremental model loading, update diagram, simulation, and code generation for large models (for example, a model with 10,000 blocks).</li> <li>• Perform unit testing.</li> </ul>

Componentization Technique	Modeling Goals for Which the Technique Is Well Suited
	<ul style="list-style-type: none"> <li>• Simplify debugging for large models.</li> <li>• Generate code that reflects the model structure.</li> </ul>

For a more detailed comparison of these modeling techniques, see “Summary of Componentization Techniques” on page 15-31.

## Summary of Componentization Techniques

This section compares subsystems, libraries, and model referencing. The table includes recommendations and notes about a range of modeling requirements and features.

To see more information about a specific requirement or feature, click a link in a table cell.

Modeling Requirement or Feature	Subsystems	Libraries	Model Referencing
<b>Development Process</b>			
Component reuse	Not supported	Well suited	Well suited
Team-based development	Not supported	Supported, with limitations	Well suited
Intellectual property protection	Not supported	Not supported	Well suited
Unit testing	Supported, with limitations	Supported, with limitations	Well suited
<b>Performance</b>			
Model loading speed	Supported, with limitations	Well suited	Well suited
Simulation speed for large models	Supported, with limitations	Supported, with limitations	Well suited
Memory	Supported, with limitations	Supported, with limitations	Well suited

<b>Modeling Requirement or Feature</b>	<b>Subsystems</b>	<b>Libraries</b>	<b>Model Referencing</b>
Artificial algebraic loop avoidance	Well suited	Well suited	Supported, with limitations
<b>Features</b>			
Signal property inheritance	Well suited	Well suited	Supported, with limitations
State initialization	Well suited	Well suited	Supported, with limitations
Buses	Well suited	Well suited	Supported, with limitations
S-functions	Well suited	Well suited	Supported, with limitations
Model configuration settings	Well suited	Well suited	Supported, with limitations
Tools	Well suited	Well suited	Supported, with limitations
Code generation	Supported, with limitations	Supported, with limitations	Well suited

For each modeling technique, you can see a summary table that includes the more detailed information included in the links in the above summary table of componentization techniques:

- “Subsystems Summary” on page 15-32
- “Libraries Summary” on page 15-36
- “Model Referencing Summary” on page 15-39

## Subsystems Summary

This section provides guidelines for using subsystems for each of the modeling requirements and features highlighted in the “Summary of Componentization Techniques” on page 15-31.

For additional information about subsystems, see:

- Creating Subsystems on page 4-18
- “Conditionally Executed Subsystems”

Modeling Requirement or Feature	Guidelines for Subsystems
<b>Development Process</b>	
Component reuse	<p><b>Not supported</b></p> <ul style="list-style-type: none"> <li>• Copy a subsystem to reuse it in a model.</li> <li>• Subsystem copies are independent of each other.</li> <li>• Save a subsystem by saving the model that contains the subsystem.</li> <li>• Configuration management for subsystems is difficult.</li> </ul>
Team-based development	<p><b>Not supported</b></p> <ul style="list-style-type: none"> <li>• For subsystems in a model, Simulink provides no direct interface with source control tools.</li> <li>• To create or change a subsystem, you need to open the parent model’s file. This can lead to file contention when multiple people want to work on multiple subsystems in a model.</li> </ul>
Intellectual property protection	<p><b>Not supported</b></p> <p>Use model referencing protected models instead.</p>
Unit testing	<p><b>Supported, with limitations</b></p> <ul style="list-style-type: none"> <li>• For coverage testing, use Signal Builder and source blocks.</li> <li>• Each time a subsystem changes, you need to copy the subsystem to a harness model.</li> <li>• The test harness may have different Simulink sort orders, due to virtual boundaries.</li> <li>• Test harness files require configuration management overhead.</li> </ul>
<b>Performance</b>	

Modeling Requirement or Feature	Guidelines for Subsystems
Model loading speed	<p><b>Supported, with limitations</b></p> <p>Loading a model loads all subsystems at one time. There is no incremental loading.</p>
Simulation speed for large models	<p><b>Supported, with limitations</b></p> <ul style="list-style-type: none"> <li>• To speed simulation, use Accelerator or Rapid Accelerator simulation mode.</li> <li>• Simulation mode applies to the whole model. Model referencing provides a finer level of control for simulation modes.</li> </ul>
Memory	<p><b>Supported, with limitations</b></p> <p>Memory use for simulation and code generation is comparable for subsystems and libraries. For models with over 500 blocks, model reference Accelerator mode can significantly reduce memory usage for simulation and code generation.</p>
Artificial algebraic loop avoidance	<p><b>Well suited</b></p> <ul style="list-style-type: none"> <li>• Virtual subsystems avoid artificial algebraic loops.</li> <li>• For nonvirtual subsystems, consider enabling the Subsystem block parameter <b>Minimize algebraic loop occurrences</b>.</li> </ul>
<b>Features</b>	
Signal property inheritance	<p><b>Well suited</b></p> <ul style="list-style-type: none"> <li>• Inheriting signal properties from outside of the subsystem boundary avoids your having to specify properties for every signal.</li> <li>• Propagation of signal properties can lead to Simulink using signal properties that you did not anticipate.</li> </ul>
State initialization	<p><b>Well suited</b></p> <p>You can initialize states of subsystems.</p>

Modeling Requirement or Feature	Guidelines for Subsystems
Tunability	<p><b>Well suited</b></p> <ul style="list-style-type: none"> <li>• Tune subsystems using a block parameterization or masked subsystems.</li> <li>• Control tunability in generated code using <b>Configuration Parameters &gt; Optimization &gt; Signals and Parameters &gt; Default parameter behavior</b>.</li> </ul>
Buses	<p><b>Well suited</b></p> <p>Subsystems do not require the use of bus objects for virtual buses.</p>
S-functions	<p><b>Well suited</b></p> <p>Subsystems support inlined or noninlined S-functions.</p>
Model configuration settings	<p><b>Well suited</b></p> <p>A subsystem uses the model configuration settings of the model that contains the subsystem.</p>
Tools	<p><b>Well suited</b></p> <p>Subsystems provide extensive support for Simulink tools.</p>
Code generation	<p><b>Supported, with limitations</b></p> <ul style="list-style-type: none"> <li>• To generate code for a subsystem by itself, right-click the Subsystem block and select a code generation option.</li> <li>• As an optimization, Simulink attempts to recognize identical subsystems. For detected identical subsystems, the generated code includes only one copy of code for the multiple subsystems.</li> <li>• For virtual subsystems, you cannot specify file or function code partitions for code generation.</li> </ul>

## Libraries Summary

This section provides guidelines for using libraries for each of the modeling requirements and features highlighted in the “Summary of Componentization Techniques” on page 15-31.

For additional information about libraries, see “Libraries”.

Modeling Requirement or Feature	Guidelines for Libraries
<b>Development Process</b>	
Component reuse	<p><b>Well suited</b></p> <ul style="list-style-type: none"> <li>• Access a collection of well-defined utility blocks.</li> <li>• Create a component once and reuse it in models.</li> <li>• Link to the same library block multiple times without creating multiple copies.</li> <li>• Link to the same library block from multiple models.</li> <li>• Restrict write access to library components.</li> <li>• Maintain one truth: propagate changes from a single library block to all blocks that link to that library.</li> <li>• Disable a link to allow independent changes to a linked block.</li> <li>• Managing library links adds some overhead.</li> <li>• Save library in a file similar to a Simulink model, but you cannot simulate the file contents.</li> </ul>
Team-based development	<p><b>Supported, with limitations</b></p> <ul style="list-style-type: none"> <li>• Place library files in source control for version control and configuration management.</li> <li>• Maintain one truth: propagate changes from a single library block to all blocks that link to that library.</li> <li>• To reduce file contention, use one subsystem per library.</li> <li>• Link to the same library block from multiple models.</li> <li>• Restrict write access to library component.</li> </ul>



Modeling Requirement or Feature	Guidelines for Libraries
	<ul style="list-style-type: none"> <li>• See General Reusability Limitations on page 8-101.</li> </ul>
Intellectual property protection	<p><b>Not supported</b></p> <p>Use model referencing protected models instead.</p>
Unit testing	<p><b>Supported, with limitations</b></p> <ul style="list-style-type: none"> <li>• For coverage testing, use Signal Builder and source blocks.</li> <li>• Test harness may have different Simulink sort orders, due to virtual boundaries.</li> <li>• Test harness files require configuration management overhead.</li> </ul>
<b>Performance</b>	
Model loading speed	<p><b>Well suited</b></p> <p>Simulink incrementally loads a library at the point needed during editing, updating a diagram, or simulating a model.</p>
Simulation speed for large models	<p><b>Supported, with limitations</b></p> <ul style="list-style-type: none"> <li>• To speed simulation, use Accelerator or Rapid Accelerator simulation mode.</li> <li>• Simulation mode applies to the whole model. Model referencing provides a finer level of control for simulation modes.</li> </ul>
Memory	<p><b>Supported, with limitations</b></p> <ul style="list-style-type: none"> <li>• Simulink incrementally loads libraries at the point needed during editing, updating a diagram, or simulating a model.</li> <li>• Simulink duplicates library block instances during block update.</li> <li>• Memory usage for simulation and code generation is comparable for subsystems and libraries. For models with over 500 blocks, model reference Accelerator mode can significantly reduce memory usage for simulation and code generation.</li> </ul>

Modeling Requirement or Feature	Guidelines for Libraries
Artificial algebraic loop avoidance	<p><b>Well suited</b></p> <ul style="list-style-type: none"> <li>• Virtual subsystems avoid artificial algebraic loops.</li> <li>• For nonvirtual subsystems, consider enabling the Subsystem block parameter <b>Minimize algebraic loop occurrences</b>.</li> </ul>
<b>Features</b>	
Signal property inheritance	<p><b>Well suited</b></p> <ul style="list-style-type: none"> <li>• Inheriting signal properties from outside of the library block boundary avoids your having to specify properties for every signal.</li> <li>• Propagation of signal properties can lead to Simulink using signal properties that you did not anticipate.</li> </ul>
State initialization	<p><b>Well suited</b></p> <p>You can initialize states of library blocks.</p>
Tunability	<p><b>Well suited</b></p> <ul style="list-style-type: none"> <li>• Tune library blocks using block parameterization or masked subsystems.</li> <li>• Control tunability in generated code using <b>Configuration Parameters &gt; Optimization &gt; Signals and Parameters &gt; Default parameter behavior</b>.</li> </ul>
Buses	<p><b>Well suited</b></p> <p>Libraries do not require the use of bus objects for virtual buses.</p>
S-functions	<p><b>Well suited</b></p> <p>Libraries support inlined and noninlined S-functions.</p>

<b>Modeling Requirement or Feature</b>	<b>Guidelines for Libraries</b>
Model configuration settings	<p><b>Well suited</b></p> <ul style="list-style-type: none"> <li>• Library models do not have model configuration settings.</li> <li>• A referenced library block uses the model configuration setting of the model that contains that block.</li> </ul>
Tools	<p><b>Supported, with limitations</b></p> <p>There are some limitations for using some Simulink tools, such as the Model Advisor, with libraries.</p>
Code generation	<p><b>Supported, with limitations</b></p> <ul style="list-style-type: none"> <li>• As an optimization, Simulink attempts to recognize identical subsystems. For detected identical subsystems, the generated code includes only one copy of code for the multiple subsystems.</li> <li>• For virtual subsystems, you cannot specify file or function code partitions for code generation.</li> </ul>

## Model Referencing Summary

This section provides guidelines for using model referencing for each of the modeling requirements and features highlighted in the “Summary of Componentization Techniques” on page 15-31.

For additional information about model referencing, see:

- “Model Referencing”
- Simulink Model Referencing Requirements on page 8-59
- Model Referencing Limitations on page 8-100

<b>Modeling Requirement or Feature</b>	<b>Guidelines for Model Referencing</b>
<b>Development Process Requirements</b>	
Component reuse	<b>Well suited</b>

Modeling Requirement or Feature	Guidelines for Model Referencing
	<ul style="list-style-type: none"> <li>• Create a standalone component once and reuse it in multiple models.</li> <li>• Reference the same model multiple times without creating multiple copies.</li> <li>• Reference the same model from multiple models.</li> <li>• Model referencing uses specified boundaries for preserving component integrity.</li> </ul>
Team-based development	<p><b>Well suited</b></p> <ul style="list-style-type: none"> <li>• For version control and configuration management, you can place model reference files in a source control system.</li> <li>• Design, create, simulate, and test a referenced model independently from the model that references it.</li> <li>• Link to the same model reference from multiple models.</li> <li>• Changes made to a referenced model apply to all instances of that referenced model.</li> <li>• Simulink does not limit access for changing a model reference.</li> <li>• You save a referenced model in a separate file from the model that references it. Using separate files helps to avoid file contention.</li> </ul>
Intellectual property protection	<p><b>Well suited</b></p> <ul style="list-style-type: none"> <li>• Use the protected model feature to obscure contents of a referenced model in a distributed model.</li> <li>• Creating a protected model feature requires a Simulink Coder license. Using a protected model does <i>not</i> require a Simulink Coder license.</li> </ul>

Modeling Requirement or Feature	Guidelines for Model Referencing
Unit testing	<p><b>Well suited</b></p> <ul style="list-style-type: none"> <li>• Test components independently to isolate behaviors, by simulating them standalone.</li> <li>• You can eliminate unit retest for unchanged components.</li> <li>• Use a data-defined test harness, with MATLAB test vectors and direct coverage collection.</li> <li>• For coverage testing, use root inports and outports.</li> </ul>
<b>Performance</b>	
Model loading speed	<p><b>Well suited</b></p> <ul style="list-style-type: none"> <li>• Simulink incrementally loads a referenced model at the point needed during editing, updating a diagram, or simulating a model.</li> <li>• If a simulation target build is required, first-time loading can be slow.</li> </ul>
Simulation speed for large models	<p><b>Well suited</b></p> <ul style="list-style-type: none"> <li>• Simulate a referenced model standalone.</li> <li>• The Model block has an option for specifying the simulation mode.</li> <li>• You can improve rebuild performance by selecting the appropriate setting for the <b>Configuration Parameters &gt; Model Referencing &gt; Rebuild</b> parameter.</li> <li>• Simulation through code generation can have a slow start-up time, which might be undesirable during prototyping.</li> <li>• See “Limitations on Normal Mode Referenced Models” on page 8-103, “Limitations on Accelerator Mode Referenced Models” on page 8-103, and “Limitations on SIL and PIL Mode Referenced Models” on page 8-107.</li> </ul>

Modeling Requirement or Feature	Guidelines for Model Referencing
Memory	<p><b>Well suited</b></p> <ul style="list-style-type: none"> <li>• Simulink loads a referenced model at the point that model is needed for navigation during editing, updating a diagram, or simulating a model.</li> <li>• Use model reference Accelerator mode to reduce memory usage, incrementally loading a compiled version of a referenced model.</li> </ul>
Artificial algebraic loop avoidance	<p><b>Supported, with limitations</b></p> <p>Consider enabling <b>Configuration Parameters &gt; Model Referencing &gt; Minimize algebraic loop occurrences.</b></p>
<b>Features</b>	
Signal property inheritance	<p><b>Supported, with limitations</b></p> <ul style="list-style-type: none"> <li>• Inherit sample time when the referenced model is sample-time independent. You cannot propagate a continuous sample time to a Model block that is sample-time independent.</li> <li>• Model block is context-independent, so it cannot inherit signal properties. Explicitly set input and output signal properties.</li> <li>• Use a bus object to define the signal data type of a bus signal that is passed into a referenced model.</li> <li>• Goto and From block lines cannot cross model referencing boundaries.</li> <li>• See Index Base Limitations on page 8-100.</li> </ul>

<b>Modeling Requirement or Feature</b>	<b>Guidelines for Model Referencing</b>
State initialization	<p><b>Supported, with limitations</b></p> <ul style="list-style-type: none"> <li>• You can initialize states from the top model.</li> <li>• Use either the structure format or structure with time format to initialize the states of a top model and the models that it references.</li> <li>• To use the <code>SimState</code> (simulation state) feature with model referencing, simulate all Model blocks in Normal mode.</li> <li>• See “State Information for Referenced Models” on page 59-265.</li> </ul>
Tunability	<p><b>Supported, with limitations</b></p> <ul style="list-style-type: none"> <li>• To have each instance of a referenced model use different values, use model arguments in the Model block.</li> <li>• To have each instance of a referenced model use the same values, use <code>Simulink.Parameter</code> objects.</li> <li>• By default, all other parameters are inlined in generated code.</li> </ul>
Buses	<p><b>Supported, with limitations</b></p> <p>You must use bus objects for bus signals that cross referenced model boundaries (for example, global data stores, root inports, root outports).</p>
S-functions	<p><b>Supported, with limitations</b></p> <p>Model referencing generally supports inlined or noninlined S-functions. See “S-Function Limitations” on page 8-105.</p>

Modeling Requirement or Feature	Guidelines for Model Referencing
Model configuration settings	<p><b>Supported, with limitations</b></p> <ul style="list-style-type: none"> <li>• To apply the same model configuration settings to all models in a model hierarchy, use a referenced configuration set.</li> <li>• Configuration settings for the root model and referenced models must be consistent. However, not all configuration settings need to be the same across the model hierarchy.</li> </ul>
Tools	<p><b>Supported, with limitations</b></p> <ul style="list-style-type: none"> <li>• There are some limitations for using some Simulink tools, such as the Simulink Debugger, with model referencing.</li> <li>• For details, see “Simulink Tool Limitations” on page 8-101.</li> </ul>
Code generation	<p><b>Well suited</b></p> <ul style="list-style-type: none"> <li>• By default, model referencing generates code incrementally.</li> <li>• You can improve rebuild performance by selecting the appropriate setting for the <b>Configuration Parameters &gt; Model Referencing &gt; Rebuild</b> parameter.</li> <li>• Model referencing requires the use of bus objects. For information, see “Bus Data Crossing Model Reference Boundaries” on page 63-142.</li> </ul>

## Related Examples

- Creating Subsystems on page 4-18
- Converting a Subsystem to a Referenced Model on page 8-17
- “Linked Blocks” on page 39-15
- “Create a Referenced Model” on page 8-9
- “Parameter Interfaces for Reusable Components” on page 35-20
- “Determine Where to Store Variables and Objects for Simulink Models” on page 57-85



## **More About**

- “Design Partitioning” on page 21-2
- “Interface Design” on page 21-13
- “Configuration Management” on page 21-18
- “Subsystem Advantages” on page 4-18
- “Conditionally Executed Subsystems”
- “Custom Libraries and Linked Blocks” on page 39-2
- “Overview of Model Referencing” on page 8-2
- “Simulink Model Referencing Requirements” on page 8-59
- “Model Referencing Limitations” on page 8-100

## Model Complex Logic

To model complex logic in a Simulink model, consider using Stateflow software.

Stateflow extends Simulink with a design environment for developing state transition diagrams and flow charts. Stateflow provides the language elements required to describe complex logic in a natural, readable, and understandable form. It is tightly integrated with MATLAB and Simulink products, providing an efficient environment for designing embedded systems that contain control, supervisory, and mode logic.

For more information on Stateflow software, see “Stateflow”.

### Related Examples

- “Model a Continuous System” on page 15-8
- “Best-Form Mathematical Models” on page 15-11
- “Model a Simple Equation” on page 15-15
- “Model Differential Algebraic Equations” on page 15-17
- “Model Physical Systems” on page 15-47
- “Model Signal Processing Systems” on page 15-48

### More About

- “General Considerations when Building Simulink Models” on page 15-2
- “Componentization Guidelines” on page 15-29

## Model Physical Systems

To model physical systems in the Simulink environment, consider using Simscape software.

Simscape extends Simulink with tools for modeling systems spanning mechanical, electrical, hydraulic, and other physical domains as physical networks. It provides fundamental building blocks from these domains to let you create models of custom components. The MATLAB based Simscape language enables text-based authoring of physical modeling components, domains, and libraries.

For more information on Simscape software, see “Simscape”.

### Related Examples

- “Model a Continuous System” on page 15-8
- “Best-Form Mathematical Models” on page 15-11
- “Model a Simple Equation” on page 15-15
- “Model Differential Algebraic Equations” on page 15-17
- “Model Complex Logic” on page 15-46
- “Model Signal Processing Systems” on page 15-48

### More About

- “General Considerations when Building Simulink Models” on page 15-2
- “Componentization Guidelines” on page 15-29

## Model Signal Processing Systems

To model signal processing systems in the Simulink environment, consider using DSP System Toolbox™ software.

DSP System Toolbox provides algorithms and tools for the design and simulation of signal processing systems. These capabilities are provided as MATLAB functions, MATLAB System objects, and Simulink blocks. The system toolbox includes design methods for specialized FIR and IIR filters, FFTs, multirate processing, and DSP techniques for processing streaming data and creating real-time prototypes. You can design adaptive and multirate filters, implement filters using computationally efficient architectures, and simulate floating-point digital filters. Tools for signal I/O from files and devices, signal generation, spectral analysis, and interactive visualization enable you to analyze system behavior and performance. For rapid prototyping and embedded system design, the system toolbox supports fixed-point arithmetic and C or HDL code generation.

For more information on DSP System Toolbox software, see “DSP System Toolbox”.

### More About

- “DSP System Toolbox”
- “General Considerations when Building Simulink Models” on page 15-2

# Simulink Project Setup

---

- “Organize Large Modeling Projects” on page 16-2
- “What Are Simulink Projects?” on page 16-3
- “Explore Simulink Project Tools with the Airframe Project” on page 16-5
- “Create a Project from a Model” on page 16-16
- “Create a New Project to Manage Existing Files” on page 16-18
- “Add Files to the Project” on page 16-20
- “Create a New Project from an Archived Project” on page 16-22
- “Create a New Project Using Templates” on page 16-23
- “Open Recent Projects” on page 16-24
- “Change the Project Name, Root, Description, and Startup Folder” on page 16-26
- “Specify Project Path” on page 16-27
- “What Can You Do With Project Shortcuts?” on page 16-29
- “Automate Startup Tasks with Shortcuts” on page 16-30
- “Automate Shutdown Tasks with Shortcuts” on page 16-32
- “Create Shortcuts to Frequent Tasks” on page 16-34
- “Use Shortcuts to Find and Run Frequent Tasks” on page 16-38
- “Create Templates for Standard Project Settings” on page 16-41

## Organize Large Modeling Projects

You can use Simulink Projects to help you organize your work. To get started with managing your files in a project:

- 1** Try an example project to see how the tools can help you organize your work. See “Explore Simulink Project Tools with the Airframe Project” on page 16-5.
- 2** Create a new project. See “Create a New Project to Manage Existing Files” on page 16-18.
- 3** Use the Dependency Analysis view to analyze your project and check required files. See “Run Dependency Analysis” on page 18-4.
- 4** Explore views of your files. See “Work with Project Files” on page 17-8.
- 5** Create shortcuts to save and run frequent tasks. See “Use Shortcuts to Find and Run Frequent Tasks” on page 16-38.
- 6** Run custom task operations on batches of files. See “Run a Simulink Project Custom Task and Publish Report” on page 17-43.
- 7** If you use a source control integration, you can use the **Modified Files** view to review changes, compare revisions, and commit modified files. If you want to use source control with your project, see “About Source Control with Projects” on page 19-2.

For guidelines on structuring projects, see “Componentization Guidelines” on page 15-29.

### More About

- “Design Partitioning” on page 21-2
- “Interface Design” on page 21-13
- “Configuration Management” on page 21-18

## What Are Simulink Projects?

You can use Simulink Projects to help you organize your work. Find all your required files; manage and share files, settings, and user-defined tasks; and interact with source control.

If your work involves any of the following:

- More than one model file
- More than one model developer
- More than one model version

— then Simulink Projects can help you organize your work. You can manage all the files you need in one place — all MATLAB and Simulink files, and any other file types you need such as data, requirements, reports, spreadsheets, tests, or generated files.

Projects can promote more efficient team work and individual productivity by helping you:

- Find all the files that belong with your project.
- Create standard ways to initialize and shut down a project.
- Create, store, and easily access common operations.
- View and label modified files for peer review workflows.
- Share projects using built-in integration with Subversion<sup>®</sup> (SVN) or Git<sup>™</sup>, external source control tools.

See the Web page <https://www.mathworks.com/discovery/simulink-projects.html> for the latest information, downloads, and videos.

To get started with managing your files in a project:

- 1** Try an example project to see how the tools can help you organize your work. See “Explore Simulink Project Tools with the Airframe Project” on page 16-5.
- 2** Create a new project. See “Create a New Project to Manage Existing Files” on page 16-18.
- 3** Analyze your project and check required files by using the Dependency Analysis view. See “Run Dependency Analysis” on page 18-4.
- 4** Explore views of your files. See “Work with Project Files” on page 17-8.

- 5 Create shortcuts to save and run frequent tasks. See “Use Shortcuts to Find and Run Frequent Tasks” on page 16-38.
- 6 Run custom task operations on batches of files. See “Run a Simulink Project Custom Task and Publish Report” on page 17-43.
- 7 If you use a source control integration, you can use the **Modified Files** view to review changes, compare revisions, and commit modified files. If you want to use source control with your project, see “About Source Control with Projects” on page 19-2.

For guidelines on structuring projects, see “Large-Scale Modeling”.

### **More About**

- “Design Partitioning” on page 21-2
- “Interface Design” on page 21-13
- “Configuration Management” on page 21-18



## Explore Simulink Project Tools with the Airframe Project

### In this section...

- “Explore the Airframe Project” on page 16-5
- “Set Up Project Files and Open Simulink Project” on page 16-6
- “View, Search, and Sort Project Files” on page 16-6
- “Understand Project Startup and Shutdown Tasks” on page 16-7
- “Create a Startup Shortcut” on page 16-9
- “Open and Run Frequently Used Files” on page 16-9
- “Review Changes in Modified Files” on page 16-10
- “Run Project Integrity Checks” on page 16-11
- “Run Dependency Analysis” on page 16-11
- “Commit Modified Files” on page 16-14
- “View Project and Source Control Information” on page 16-14

### Explore the Airframe Project

Try an example Simulink project to see how the tools can help you organize your work. Projects can help you manage:

- Your design (model and library files, `.m`, `.mat`, and other files, source code for S-functions, data)
- A set of actions to use with your project (run setup code, open models, simulate, build, run shutdown code)
- Working with files under source control (check out, compare revisions, tag or label, check in)

The Airframe example shows how to:

- 1 Set up and browse some example project files under source control.
- 2 Examine project shortcuts to run setup and shutdown tasks and access frequently used files and tasks.
- 3 Analyze dependencies in the example project and locate required files that are not yet in the project.

- 4 Modify some project files, find and review modified files, compare to an ancestor version, and commit modified files to source control.
- 5 Explore views of project files only, modified files, and all files under the project root folder.

### Set Up Project Files and Open Simulink Project

Run this command to create a working copy of the project files and open the project:

```
sldemo_slproject_airframe_svn
```

The project example copies files to your temporary folder so that you can edit them and put them under SVN source control.

The Simulink Project opens and loads the project. The project is configured to run some startup tasks, including changing the current working folder to the project root folder.

---

**Note:** Alternatively, you can try this example project using Git source control, by specifying `sldemo_slproject_airframe_git`. The following example shows the options when using SVN.

---

### View, Search, and Sort Project Files

- 1 In Simulink Project, examine the **Files** view to manage the files within your project. When **Project Files View** is selected, only the files in your project are shown.
- 2 To see all the files in your sandbox, click the **Project Files View** button and select **All Files View**. This view shows all the files that are under the project root, not just the files that are in the project. This view is useful for adding files to the project from your sandbox.
- 3 To find particular files or file types, in any file view, type in the search box or click the Filter button. You can also search inside files.

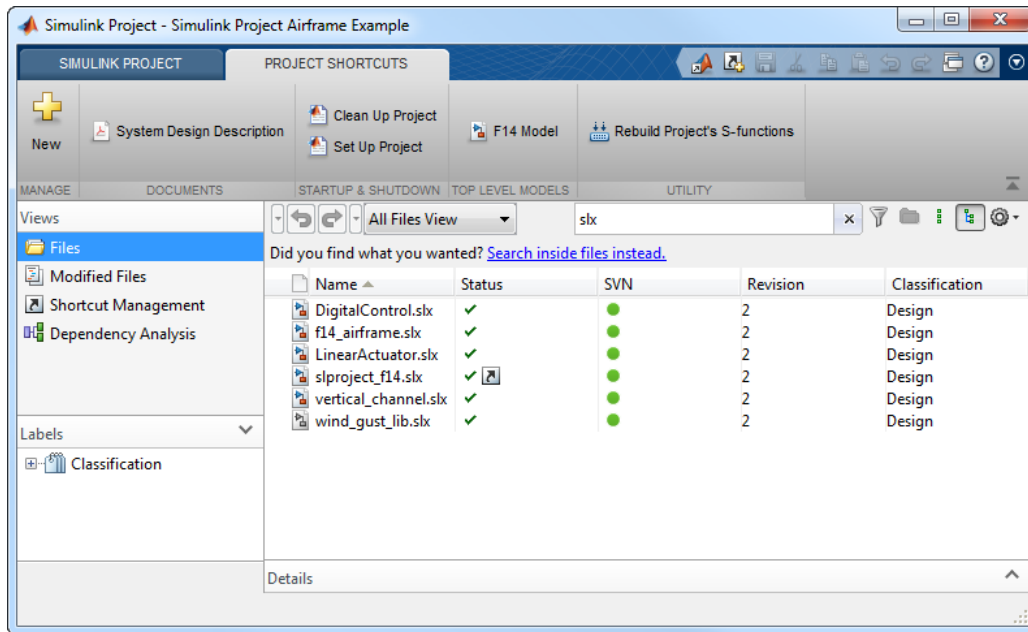

Click the x to clear the search.

- To view files as a list instead of a tree, click the List view button.



- To sort files and to customize the columns, click the Actions button at the far right of the search box.
- You can dock and undock the Simulink Project into the MATLAB Desktop. If you want to maximize space for viewing your project files, undock the Simulink Project. Drag the title bar to undock it.

## Understand Project Startup and Shutdown Tasks

You can use shortcuts to run automatically startup or shutdown tasks, and to find files within a large project.

You can view and run shortcuts on the Project Shortcuts toolbar. The shortcuts are organized into groups that you specify through the **Shortcut Management** view.

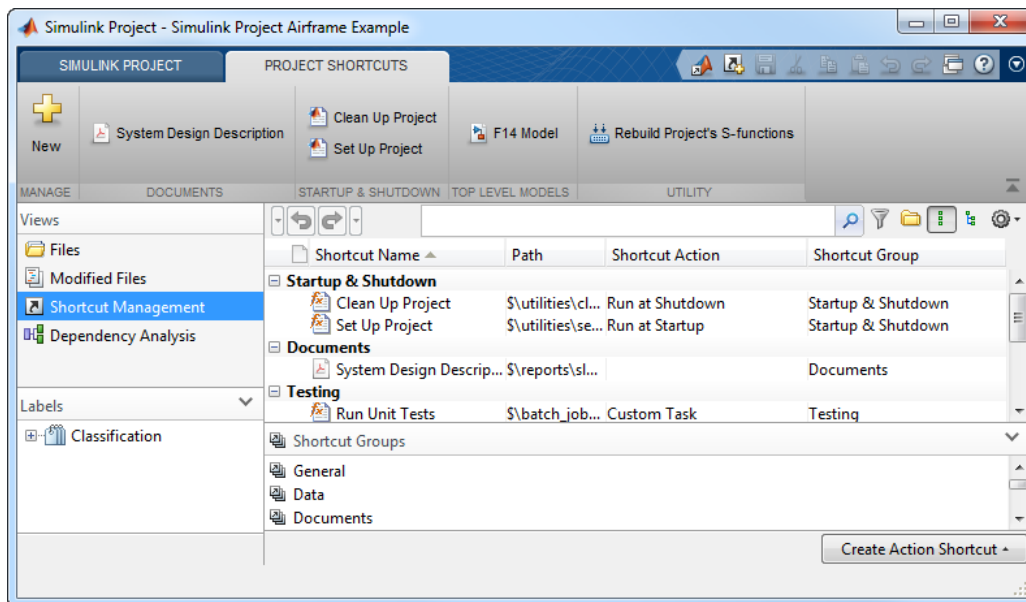

In this example, you can see that some files are set as **Run at Startup** shortcuts. Startup shortcut files automatically run, load, or open when you open the project. You can use these shortcuts to set up the environment for your project. The file `set_up_project.m` defines where to create the `slprj` folder.

- Open the **Set Up Project** shortcut to understand how it works. In the **Shortcut Management** view, double-click the shortcut, or right-click and select **Open**. The file `set_up_project.m` opens in the Editor. The following lines use the project API to get the current project and the root folder:

```
project = simulinkproject;
projectRoot = project.RootFolder;
```

- The shortcut **Clean Up Project** is set as a **Run at Shutdown** shortcut. This type of shortcut runs before the current project closes. In this example, `clean_up_project.m` resets the environment changes made by `set_up_project.m`.

## Create a Startup Shortcut

- 1 Select the **Files** view and change the all files view to the **Project Files View**.
- 2 Right-click a file, and select **Add Shortcut to > General**.
- 3 In the **Shortcut Management** view, right-click the shortcut you created and select **Set Shortcut Action > Startup** to make the file run, load, or open at startup.

When you open the project, the project performs the default action for startup shortcut files depending on their type:

- Run `.m` files.
- Load `.mat` files.
- Open Simulink models.

For details on shortcuts, see “Automate Startup Tasks with Shortcuts” on page 16-30.

## Open and Run Frequently Used Files

You can use shortcuts to make scripts easier to find in a large project. In this example, the script that regenerates S-functions is set as a shortcut so that a new user of the project can easily find it. You can also make the top-level model, or models, within a project easier to find. In this example, the top-level model, `slproject_f14.mdl`, is a shortcut.

Regenerate the S-functions.

- 1 On the Project Shortcuts tab in the toolbar, click the shortcut **Rebuild Project's S-functions**.

The shortcut file builds a MEX-file. If you do not have a compiler set up, follow the instructions to choose a compiler.

- 2 Open the `rebuild_s_functions.m` file to explore how it works.

Open the top model.

- On the Project Shortcuts tab, click the shortcut **F14 Model** to open the root model for this project. This model runs only after you compile the required S-function.
- To create shortcuts to access frequently used files, select the **Files** view, right-click a file, and select **Add Shortcut to > General** or any other *shortcutGroupName*. This action creates a basic shortcut with no startup or shutdown action.

## Review Changes in Modified Files

Open and make changes to files and review changes.

- 1 Select **Project Files View**. View folders using the tree view button, and then expand the **utilities** folder.
- 2 Either double-click to open the **set\_up\_project** file for editing from the Simulink Project, or right-click and select **Open**.
- 3 Make a change in the Editor, such as adding a comment, and save the file.
- 4 Under **Files**, select the **Modified Files** view. The files you changed appear in the list.
- 5 To review changes, right-click the **set\_up\_project** file in the **Modified Files** view and select **Compare > Compare to Ancestor**.

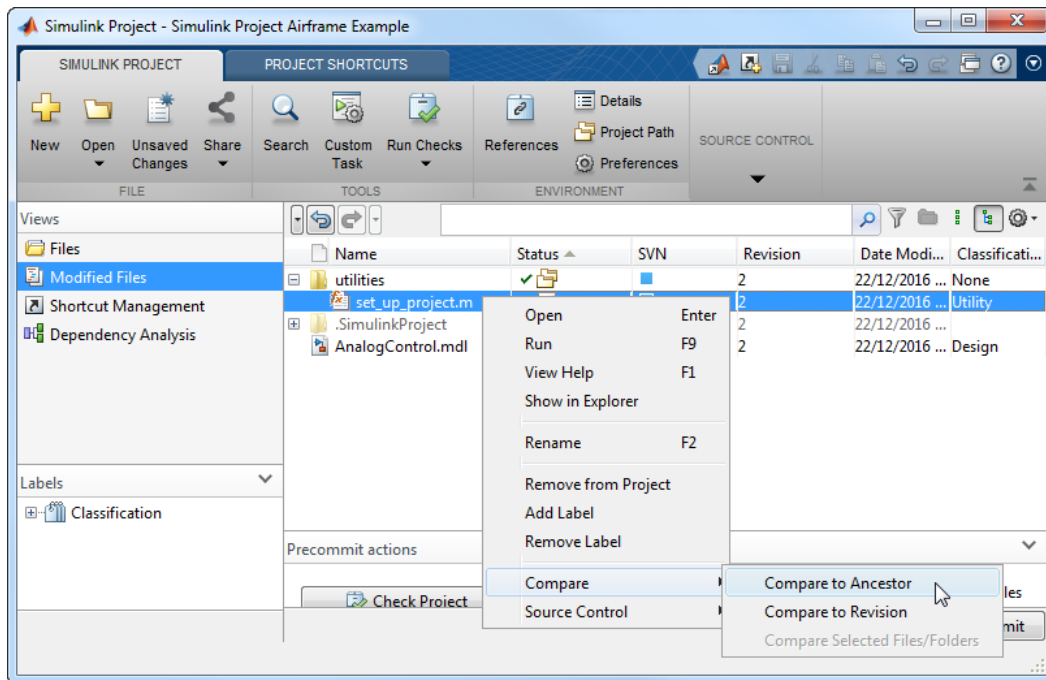

The MATLAB Comparison Tool opens a report comparing the modified version of the file in your sandbox against its ancestor stored in the version control tool. The comparison report type can differ depending on the file you select.

If you select a Simulink model to **Compare > Compare to Ancestor**, and you have Simulink Report Generator installed, this command runs a Simulink XML comparison.

If you have Simulink Report Generator, try the following example.

- 1 Select the **Files** view and expand the **models** folder.
- 2 Either double-click to open the **AnalogControl** file for editing from the Simulink Project, or right-click and select **Open**.
- 3 Make a change in the model, such as opening a block and changing some parameters, and then save the model.
- 4 To review changes, right-click the file in the **Modified Files** view and select **Compare > Compare to Ancestor**.

The Comparison Tool opens a report.

## Run Project Integrity Checks

In the **Modified Files** view, under **Precommit actions**, click **Check Project** to run the project integrity checks. The checks look for missing files, files to add to source control or retrieve from source control, and other issues. The checks dialog box can offer automatic fixes to problems found.

When you click a **Fix** button in the Checks dialog box, you can view recommended actions and decide whether to make the changes.

For an example using the project checks to fix issues, see “Upgrade Model Files to SLX and Preserve Revision History” on page 17-18.

## Run Dependency Analysis

To check that all required files are in the project, run a file dependency analysis on the modified files in your project.

- 1 From the Simulink Project tree, select **Dependency Analysis**.
- 2 Click **Analyze**.

The Impact graph displays the structure of all analyzed dependencies in the project. The right pane lists required toolboxes and any problem files.

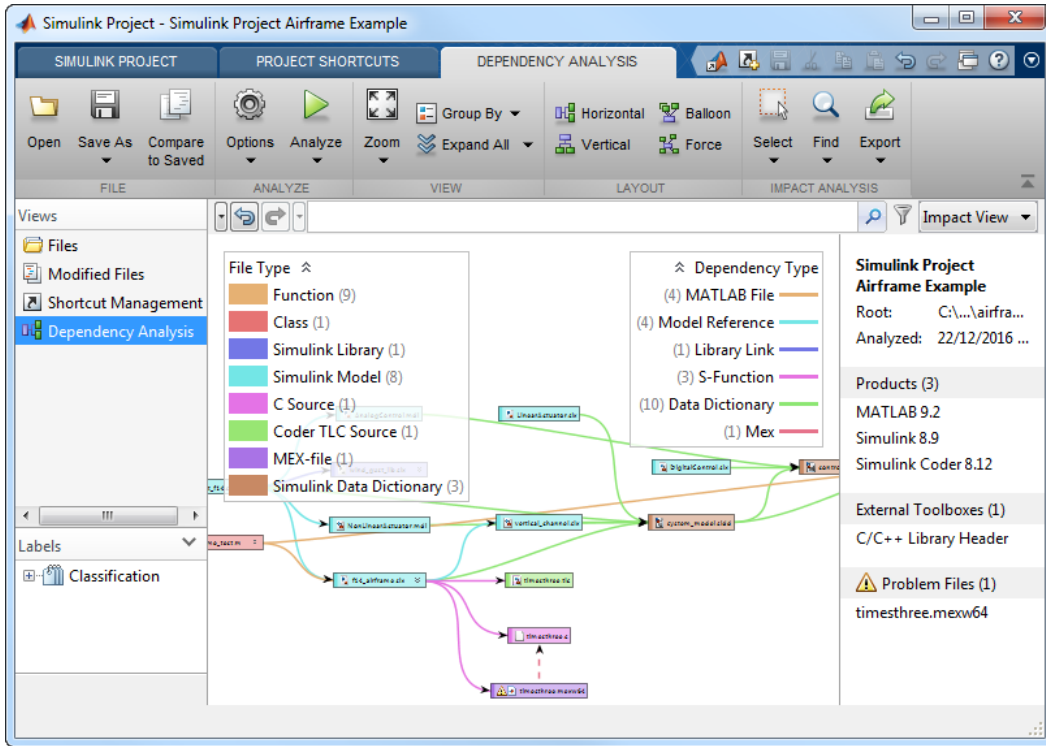

- 3 To view the files that use a problem file, hover over the problem file `timesthree.mexw64` and click Find Dependencies.

The graph updates to display only the problem file and its dependencies, and the problem message in the right panel. The file is not in the project.

- 4 Observe that `timesthree.mexw64` is an S-function binary file required by `f14_airframe.slx`. You can add binary files to your project or, as in this project, provide a utility script that regenerates them from the source code that is part of the project.



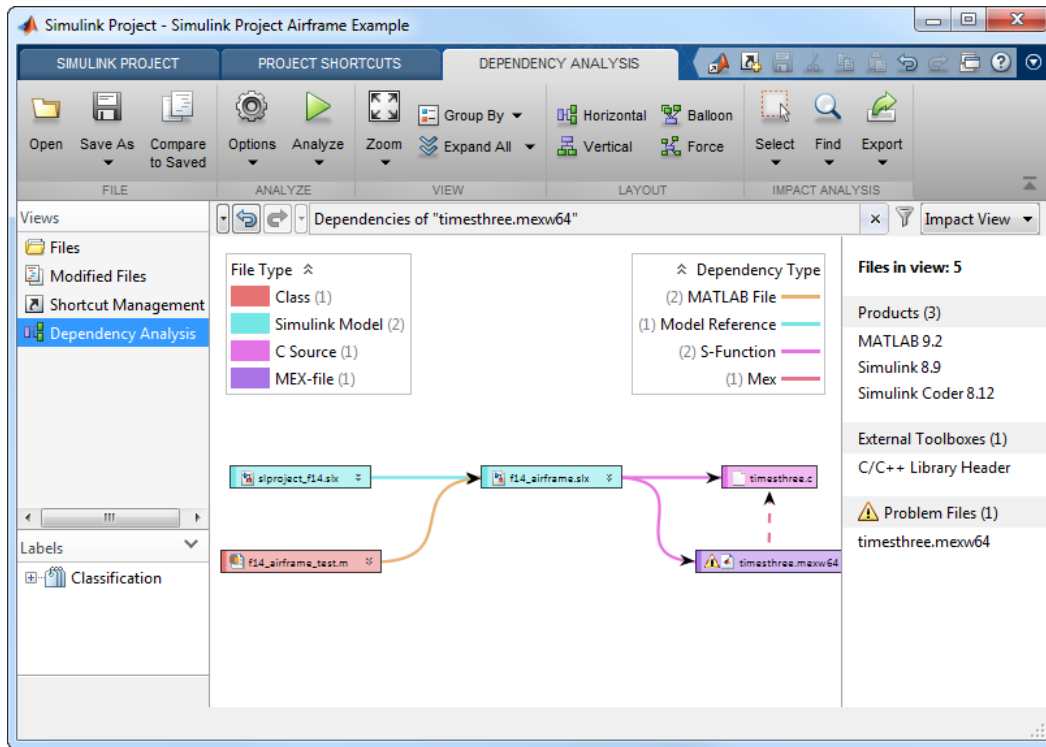

- 5 To remove the file from the problem files list, right-click the file and select **Add External File**. The next time you run a dependency analysis, the file does not appear as a problem file.

In this example, you do not want to add the binary file to the project, but instead use the script to regenerate the binary file from the source code in the project. Use **Add External File** to stop such files being marked as problems.

- 6 In the **Impact View**, on the **Dependency Analysis** tab, in the **Impact Analysis** section, select **Find > All Files**.
- 7 In the **Impact Analysis** section, choose **Select > Modified Files**.
- 8 To view dependencies of the modified files, in the **Impact Analysis** section, select **Find > All Dependencies of Selection**.

## Commit Modified Files

After you modify files and you are satisfied with the results of the checks, you can commit your changes to the source control repository.

- 1 In the **Modified Files** view, under **Precommit actions**, click **Check Project** to make sure that your changes are ready to commit.
- 2 Observe that the Modified Files list includes a `.SimulinkProject` folder. The files stored in the `.SimulinkProject` folder are internal project definition files generated by your changes. These definition files allow you to add a label to a file without checking it out. You do not need to view the definition files directly unless you need to merge them, but they are listed so you know about all the files being committed to the source control system. See “Project Definition Files” on page 19-42.
- 3 To commit your changes to source control, click **Commit**.
- 4 Enter a comment for your submission, and click **Submit**.

Watch the messages as the example source control commits your changes.

## View Project and Source Control Information

- To view the open project name, description, and the location of the project root folder, on the Simulink Project tab, in the Environment section, click **Details**.
- To view details about the source control integration and repository location, on the Simulink Project tab, in the Source Control section, click **SVN Details**. This Airframe example project is under the control of the SVN source control tool.

For next steps, see “Project Management”.

## Related Examples

- “Create a Project from a Model” on page 16-16
- “Create Shortcuts to Frequent Tasks” on page 16-34
- “Automate Startup Tasks with Shortcuts” on page 16-30
- “Perform Impact Analysis” on page 18-7
- “Add a Project to Source Control” on page 19-6
- “View Modified Files” on page 19-41

## **More About**

- “What Are Simulink Projects?” on page 16-3
- “What Can You Do With Project Shortcuts?” on page 16-29
- “What Is Dependency Analysis?” on page 18-2
- “Sharing Simulink Projects” on page 17-47
- “About Source Control with Projects” on page 19-2

## Create a Project from a Model

Create a project to organize your model and any dependent files. Simulink projects can help you organize your work and collaborate in teams. The project can help you to:

- Find all your required files
- Manage and share files, settings, and user-defined tasks
- Interact with source control.

- 1 In a Simulink model, select **File > Simulink Project > Create Project from Model**.

Simulink runs dependency analysis on your model to identify required files and a project root location that contains all dependencies.

- 2 In the New Simulink Project dialog box, edit any settings you want to change:
  - **Project name** — By default, the name of the suggested project root folder. Edit if desired.
  - **Project folder** — A folder that dependency analysis identified to contain all dependencies. If you want, click to select a different folder in the file system hierarchy between the file system root and the model folder.
  - **Files to include** — Files to include in the project. Files with selected check boxes are identified by dependency analysis. Select check boxes to specify all the files you want to include.

Any external dependencies are listed. If required files are outside your project root, then you cannot add these files to your project. An external dependency might not indicate a problem if the file is on your path and is a utility or other resource that is not part of your project.

- If you do not want to make a shortcut to the top-level file, or add all the folders to the project path, under **More Options**, clear the check boxes. Alternatively, you can edit these project settings later.
- 3 Click **Create** to create the Simulink project containing your model and any other specified files.

For an example showing what you can do with projects, see “Explore Simulink Project Tools with the Airframe Project” on page 16-5.

## **Related Examples**

- “Create a New Project to Manage Existing Files” on page 16-18
- “Create Shortcuts to Frequent Tasks” on page 16-34
- “Automate Startup Tasks with Shortcuts” on page 16-30
- “Open Recent Projects” on page 16-24
- “Explore Simulink Project Tools with the Airframe Project” on page 16-5

## **More About**

- “What Are Simulink Projects?” on page 16-3
- “What Can You Do With Project Shortcuts?” on page 16-29
- “Sharing Simulink Projects” on page 17-47
- “About Source Control with Projects” on page 19-2

## Create a New Project to Manage Existing Files

If you have many files that you want to organize into a project, with or without source control, use the following steps for a new project.

---

**Note:** If you have a model (with or without other dependent files) that you want to put in a project, see instead “Create a Project from a Model” on page 16-16.

If you want to retrieve a project from a source control repository, see instead “Retrieve a Working Copy of a Project from Source Control” on page 19-29.

---

To create a new project to manage your files:

- On the MATLAB **Home** tab, click **Simulink** or select **New > Simulink Project**.
  - From the Model Editor, select **File > New > Project**.
  - From the Simulink Project, on the **Simulink Project** tab, click **New**.
- 1 In the Simulink start page, click a template in the list to read the description. If you selected a new project option to open the start page, the list shows only project templates, or you can filter the list for Project Templates using the list next to the Search box.
    - Select the **Blank Project** template if you are creating a project in a folder with existing files. The **Blank Project** template creates a Simulink project in your selected folder and leaves any other files untouched. The project helps you manage all your files as a unit.
    - Try the **Simple Project** template if you are creating a project in a new folder and want a blank model. The **Simple Project** template creates a simple Simulink project containing a blank model and some utilities. The model is a shortcut so you can open it from the toolstrip. The project manages your path and the location of the temporary files (slprj folder) with startup and shutdown shortcuts when you open and close the project. You can modify any of these files, folders, and settings later. As your project grows, the project helps you manage all your files as a unit.
    - You can create your own templates. See “Using Templates to Create Standard Project Settings” on page 16-41.
  - 2 In the start page, select a template and click **Create Project**.

- 3 In the Create Project dialog box, specify your project folder and edit the project name, and click **Create Project**.

The Simulink Project displays the Project Files view for the specified project root.

You can control the default folder for new projects using the project preferences.

For next steps, see “Add a Project to Source Control” on page 19-6 or “Add Files to the Project” on page 16-20.

## Related Examples

- “Create a Project from a Model” on page 16-16
- “Add Files to the Project” on page 16-20
- “Work with Project Files” on page 17-8
- “Create Shortcuts to Frequent Tasks” on page 16-34
- “Add a Project to Source Control” on page 19-6

## More About

- “What Can You Do With Project Shortcuts?” on page 16-29

## Add Files to the Project

After creating a new Simulink Project, unless you created the project from a model, then the **Files** node in the **Project** tree shows the empty Project Files view. Files under your chosen project root are not included in your project until you add them. If you created your project from a model, you already specified initial files to include in the project.

To display all files in your project folder (or `projectroot`), in the **Files** view, click the **Project Files View** button and select **All Files View**. You might not want to include all files in your project. For example, you might want to exclude some files under `projectroot` from your project, such as SVN or CVS source control folders.

To add existing files to your project, use any of these methods:

- In **All Files View**, select files or folders, right-click, and select **Add to Project** or **Add to Project (including child files)**.
- To add files to your project, cut and paste or drag and drop files from a file browser or the Current Folder browser onto the **Project Files** view. If you drag a file from outside the project root, this moves the file and adds it to your project. You can drag files within project root to move them.
- Add and remove project files at the command line using `addFile`.

To create new files or folders in the project, right-click a white space in the **Files** view and select **New Folder** or **New File**. The new files are added to the project.

To learn how to set up your project with all required files, see “Run Dependency Analysis” on page 18-4.

To add or remove project folders from the MATLAB search path, see “Specify Project Path” on page 16-27.

To configure your project to automatically run startup and shutdown tasks, see “Automate Startup Tasks with Shortcuts” on page 16-30.

You can access your recent projects direct from MATLAB. See “Open Recent Projects” on page 16-24.

If you want to add source control, see “Add a Project to Source Control” on page 19-6.

### Related Examples

- “Work with Project Files” on page 17-8



- “Create Shortcuts to Frequent Tasks” on page 16-34
- “Add a Project to Source Control” on page 19-6

## **More About**

- “What Can You Do With Project Shortcuts?” on page 16-29

## Create a New Project from an Archived Project

To create a new project from an archived project:

- 1 From MATLAB, on the **Home** tab, in the **File** section, select **New > Simulink Project**.
- 2 In the start page, under **Projects** in the left list, click **Archive**.
- 3 In the Extract Project from Zip File dialog box, specify:
  - In the **Zip file** field, the location of the archived project.
  - In the **Project folder** field, the location of the new project. For example, `C:\myNewProject`.
- 4 Click **Extract**.

The new project opens. The current working folder, for example, `C:\myNewProject`, contains the imported project folders.

If the archived project contains referenced projects, Simulink Project imports files into two subfolders, `main`s and `ref`s. The current working folder, for example, `C:\myNewProject\main` contains the project folders and `C:\myNewProject\ref`s contains the referenced project folders.

### Related Examples

- “Archive Projects in Zip Files” on page 17-53

### More About

- “Sharing Simulink Projects” on page 17-47

## Create a New Project Using Templates

In Simulink Project, you can use templates to create and reuse a standard project structure.

- 1 To browse for templates, on the Simulink Project tab, click **New**.
- 2 In the Simulink start page, click a template in the list to read the description. For example, click **Simple Project**.
- 3 The start page shows all project templates (\*.sltx) on the MATLAB path. If your templates do not appear, locate them by clicking **Open**. In the Open dialog box, make \*.sltx files visible by changing the file type list **Model Files** to **All MATLAB files**, and browse to your template.
- 4 In the start page, select a template and click **Create Project**.
- 5 In the Create Project dialog box, specify your project folder and edit the project name, and click **Create Project**.

### Use Project Templates from R2014a or Before

To use project templates created in R2014a or earlier (.zip files), upgrade them to .sltx files using `Simulink.exportToTemplate`.

After you upgrade the templates to .sltx and put them on the MATLAB path, you can use the templates from the start page.

### Related Examples

- “Create Templates for Standard Project Settings” on page 16-41
- “Create a Template from a Project Under Version Control” on page 16-42
- “Edit a Template” on page 16-42
- “Explore the Example Templates” on page 16-43
- “Create a Template from a Model” on page 4-2

### More About

- “Using Templates to Create Standard Project Settings” on page 16-41

## Open Recent Projects

---

**Note:** You can have one project open at a time, to avoid conflicts. If you open another project, any currently open project closes.

---

You can use any of these methods to open recent Simulink projects:

- On the MATLAB **Home** tab, click **Simulink**, and select your project in the recent projects list.

If you select a recent model that is part of a project, you can choose to also open the project.

- On the MATLAB **Home** tab, click the **Open** arrow and select your project under the **Recent Simulink Projects** list.
- From the Current Folder browser, double-click the `.prj` file.
- In the Simulink Editor, if an open model, library, or chart belongs to a project, you can select **File > Simulink Project > Open Project**.

Alternatively, open Simulink Project by entering `simulinkproject`, or in the Simulink Editor, select **View > Simulink Project**. When Simulink Project is open, you can open projects with these methods:

- On the **Simulink Project** tab, click the **Open** arrow and select your project under the **Recent** list.
- For projects created or saved in Release 2012b or later, select **Open > Open Project File**. Browse and select your project `.prj` file.
- For projects saved in Release 2012a or earlier, select **Open > Open Project by Folder**. Navigate to the folder containing the `.SimulinkProject` folder, and click **OK** to load the project. After you load this project once, then you can use **Open Project File** to open the project.

---

**Tip:** Create a MATLAB shortcut for opening or giving focus to the Simulink Project by dragging this command to the toolstrip from the Command History or Command Window:

`simulinkproject`

---

When you open a project, you are prompted if loaded files shadow your project model files. To avoid working on the wrong files, close the shadowing files. See “Manage Shadowed and Dirty Model Files” on page 17-10.

### **Related Examples**

- “Work with Project Files” on page 17-8

## Change the Project Name, Root, Description, and Startup Folder

On the Simulink Project tab, in the Environment section, click **Details**. Use the Project Details dialog box to edit the project name or add a description. If you edit the name or description, click **OK** to save your changes.

You can view the project root folder, and click **Set as Current Folder** to change the current working folder to your project root. You can change your project root by moving your entire project on your file system, and reopening your project in its new location. All project file paths are stored as relative paths.

The check box option **Change current folder to project root on start up** is selected by default. Clear the check box if you do not want to change to the project root folder on startup.

You can also configure startup shortcut scripts that set the current folder and perform other setup tasks. If you configure startup shortcuts to set the current folder, your shortcut setting takes precedence over the check box at the Project node. To set up shortcuts, see “Automate Startup Tasks with Shortcuts” on page 16-30.

If your project is under source control, view source control information by clicking the details button for your source control in the Source Control section of the Simulink Project tab, e.g., **SVN Details**. See “Add a Project to Source Control” on page 19-6.

### Related Examples

- “Automate Startup Tasks with Shortcuts” on page 16-30
- “Add a Project to Source Control” on page 19-6

## Specify Project Path

When Simulink Project:

- Opens your project, it adds the project path to the MATLAB search path before applying startup shortcuts.
- Closes your project, it removes the project path from the MATLAB search path after applying shutdown shortcuts.

You can add or remove folders from the project path. Add project folders to ensure dependency analysis detects project files. On the **Simulink Project** tab, in the **Environment** section, click **Project Path**:

- To add a folder (without subfolders) to the project path, click **Add Folder**. If you want to add a folder and its subfolders, click **Add with Subfolders** instead. Then use the Open dialog box to add the new folder.
- To remove a folder from the project path, from the display list, select the folder. Then click **Remove**.

In the **Project > Files** view, you can use the context menu to add or remove folders from the project path. Right-click a folder and select **Project Path > Add to Project Path**, or **Add to the Project Path (Including Subfolders)**, or one of the options to remove the folder from the path.

Folders on the project path display the project path icon in the **Status** column.

Name ^	Status	SVN	Revision	Type	Classification
batch_jobs			2	Folder	None
data			2	Folder	None
models			2	Folder	None
reports			2	Folder	None
src			2	Folder	None
tests			2	Folder	None
utilities			2	Folder	None
work				Folder	

src (Folder)

If you want to set the startup folder, see the check box option at the root project node:  
**Change current folder to project root on start up.**

### Related Examples

- “Change the Project Name, Root, Description, and Startup Folder” on page 16-26

### More About

- “What Is the MATLAB Search Path?” (MATLAB)
- “What Can You Do With Project Shortcuts?” on page 16-29



## What Can You Do With Project Shortcuts?

In Simulink Project, use shortcuts to make it easy for any project user to find and access important files and operations. You can use shortcuts to make top models or scripts easier to find in a large project. You can group shortcuts to organize them by type and annotate them to use meaningful names instead of cryptic file names.

You can automate shortcuts to perform startup and shutdown tasks. Startup shortcuts help you set up the environment for your project. Shutdown shortcuts help you clean up the environment for the current project when you close it.

In the Shortcut Management view, you can execute, group, annotate, or automate shortcuts. You can specify Startup, Shutdown, or basic shortcuts.

- Startup shortcuts run when you open your project.
- Shutdown shortcuts run when you close your project.
- Basic shortcuts run when you execute them manually from the context menu or Project Shortcuts tab in the toolstrip.

### Related Examples

- “Automate Startup Tasks with Shortcuts” on page 16-30
- “Automate Shutdown Tasks with Shortcuts” on page 16-32
- “Create Shortcuts to Frequent Tasks” on page 16-34
- “Use Shortcuts to Find and Run Frequent Tasks” on page 16-38
- “Specify Project Path” on page 16-27

## Automate Startup Tasks with Shortcuts

In Simulink Project, startup shortcuts help you set up the environment for your project.

Startup shortcut files are automatically run (.m and .p files), loaded (.mat files), and opened (Simulink models) when you open the project.

---

**Note:** Files named `startup.m` on the MATLAB path run when you start MATLAB. If your `startup.m` file calls the project with `simulinkproject`, an error appears because no project is loaded yet. To avoid the error, rename `startup.m` and use it as a project startup shortcut instead.

---

Projects warn if you have more than one startup shortcut. Startup shortcuts run in alphabetical order. If execution order is important, consider creating one script that calls all the others, and use that script as your only startup shortcut.

Configure an existing file as a shortcut to run when you open your project.

- 1 In the **Files** view, right-click the project file and select **Add Shortcut to > General**, or if you have created a shortcut group you want to use, then select **Add Shortcut to > GroupName**. You can change shortcut group later.
- 2 Select **Shortcuts Management**.
- 3 Right-click the shortcut file and select **Set Shortcut Action > Startup**.

The **Shortcut Action** column displays **Run at Startup**.

Create a new startup shortcut file.

- 1 In the **Shortcut Management** view, click **Create Action Shortcut > Startup Script**.
- 2 Name and save the file. Startup shortcut scripts can have any name. You do not need to use `startup.m`.

The tool adds the new file to the project and sets it to **Run at Startup**.

- 3 Right-click the file and select **Open**.
- 4 Write the shortcut script using the Editor.
- 5 Click **Save**.

---

**Note:** Shortcuts are included when you commit modified files to source control. Any startup shortcuts you create run for all other project users.

---

To stop a shortcut running at startup, change back to a basic shortcut using **Set Shortcut Action > None**.

If you want to set the start up folder, see the check box option at the root project node: **Change current folder to project root on start up**. See “Change the Project Name, Root, Description, and Startup Folder” on page 16-26.

## Related Examples

- “Specify Project Path” on page 16-27
- “Automate Shutdown Tasks with Shortcuts” on page 16-32
- “Create Shortcuts to Frequent Tasks” on page 16-34
- “Use Shortcuts to Find and Run Frequent Tasks” on page 16-38

## More About

- “What Can You Do With Project Shortcuts?” on page 16-29

## Automate Shutdown Tasks with Shortcuts

In Simulink Project, shutdown shortcuts help you clean up the environment for the current project when you close it. Shutdown shortcuts should undo the settings applied in startup shortcuts. You can view an example in the `sldemo_slproject_airframe` project.

Configure an existing file as a shortcut to run when you close your project.

- 1 Right-click the file in the **Project Files View** and select **Add Shortcut to > General**, or if you have created a shortcut group you want to use, then select **Add Shortcut to > GroupName**. You can change shortcut group later.
- 2 Click the Shortcut Management node.
- 3 Right-click the shortcut file and select **Set Shortcut Action > Shutdown**.

The Action column displays `Run at Shutdown`.

Create a new shutdown shortcut file.

- 1 In the Shortcut Management view, click **Create Action Shortcut > Shutdown Script**.
- 2 Name and save the file.

The tool adds the new file to the project and sets it to `Run at Shutdown`.

- 3 Right-click the file and select **Open**.
- 4 Write the shortcut script using the Editor.
- 5 Click **Save**.

---

**Note:** Shortcuts are included when you commit modified files to source control. Any shutdown shortcuts you create run for all other project users.

---

To stop a shortcut running at shutdown, change back to a basic shortcut using **Set Shortcut Action > None**.

### Related Examples

- “Automate Startup Tasks with Shortcuts” on page 16-30

- “Specify Project Path” on page 16-27
- “Create Shortcuts to Frequent Tasks” on page 16-34
- “Use Shortcuts to Find and Run Frequent Tasks” on page 16-38

### **More About**

- “What Can You Do With Project Shortcuts?” on page 16-29

## Create Shortcuts to Frequent Tasks

### In this section...

“Create Shortcuts” on page 16-34

“Group Shortcuts” on page 16-35

“Annotate Shortcuts to Use Meaningful Names” on page 16-36

“Customize Shortcut Icons” on page 16-37

### Create Shortcuts

In Simulink Project, create shortcuts for common project tasks and to make it easy to find and access important files and operations. For example, find and open top models, run startup code (for example, to load data), simulate models, or run shutdown code.

To create a shortcut to an existing project file, use any of the following methods:

- Right-click the file in the **Project Files View** and select **Add Shortcut to > General**, or **ShortcutGroupName**.
- Click **New** on the Project Shortcuts tab on the toolstrip and browse to select a file.

The shortcut appears on the Project Shortcuts tab on the toolstrip.

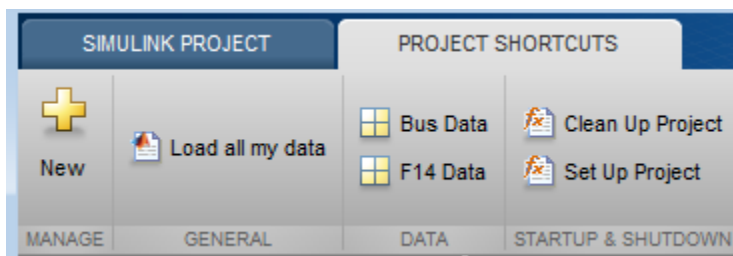

You can create new shortcuts interactively only in the Simulink Project, but you can get and view your shortcuts at the command line. For details, see .

---

**Note:** Shortcuts are included when you commit your modified files to source control, so you can share shortcuts with other project users.

---

## Group Shortcuts

You can group shortcuts to organize them by type. For example, you can group shortcuts for loading data, opening models, generating code, and running tests.

By default, new shortcuts appear in the General group on the Project Shortcuts toolbar tab and in the Shortcut Management view.

Create new shortcut groups to organize your shortcuts:

- Right-click in the Shortcut Groups pane and select **Create New Shortcut Group**. Enter a name for the group and click **OK**.

The new shortcut group appears in the Shortcut Groups pane.

- Alternatively, click **New** in the Project Shortcuts tab. Right-click in the Select a Shortcut Group pane to create a new group.

To organize your shortcuts by group, either:

- In the **Project Files View**, right-click a file and select **Add Shortcut to > ShortcutGroupName**.
- In the Shortcut Management view, drag a shortcut group onto a file from the Shortcut Groups pane, or right-click a file and select **Set Shortcut Group > ShortcutGroupName**.

The shortcuts are organized by group in the Project Shortcuts toolbar tab and in the Shortcut Management view.

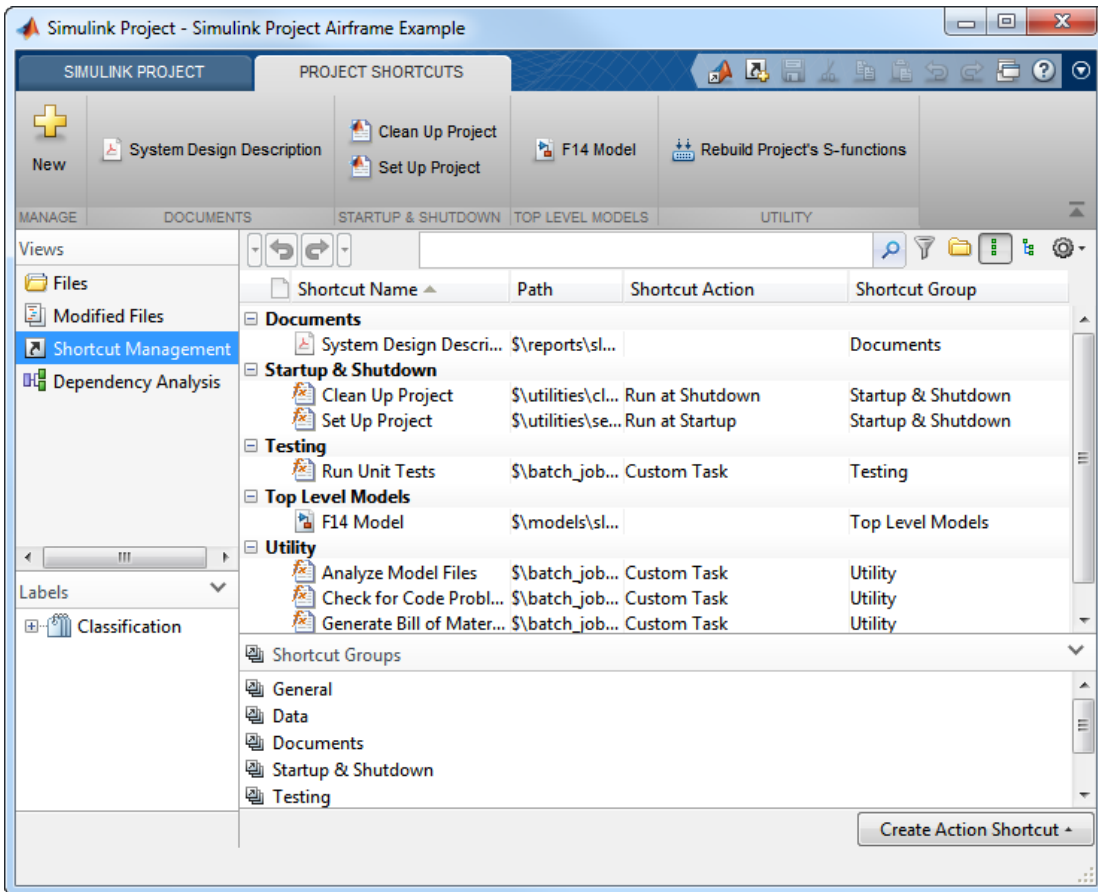

To change shortcut group, in the Shortcut Management view, drag a different group onto the file, or right-click and select **Set Shortcut Group > GroupName**.

## Annotate Shortcuts to Use Meaningful Names

Annotating shortcuts makes their purpose visible, without changing the file name or location of the script or model the shortcut points to. For example, you can change a cryptic file name to a descriptive name for the shortcut. To put shortcuts in a workflow order on the toolbar, prefix the shortcut names with numbers.



In the Shortcut Management view, right-click and select **Rename** to edit the **Shortcut Name** column. The **Shortcut Name** does not affect the file name or location.

Your specified **Shortcut Name** appears on the Project Shortcuts tab, to make it easier to find your shortcuts.

## Customize Shortcut Icons

You can specify an icon to use for your shortcut buttons on the Project Shortcuts tab. Icons such as "build" can aid other project users to recognize frequent tasks.

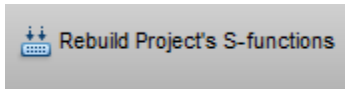

- 1 In the Shortcut Management view, right-click a shortcut and select **Set Custom Icon**.
- 2 Select an image file. Images must be exactly 16 pixels square, and a png or a gif file.

## Related Examples

- “Use Shortcuts to Find and Run Frequent Tasks” on page 16-38
- “Automate Startup Tasks with Shortcuts” on page 16-30

## More About

- “What Can You Do With Project Shortcuts?” on page 16-29

## Use Shortcuts to Find and Run Frequent Tasks

In Simulink Project, use shortcuts to make it easy for any project user to find and access important files and operations. You can use shortcuts to make top models or scripts easier to find in a large project. Shortcuts are available from any file view via the toolbar.

If your project does not yet contain any shortcuts, see “Create Shortcuts to Frequent Tasks” on page 16-34.

To use shortcuts:

- In the Project Shortcuts toolbar tab, click the shortcut. Clicking a shortcut in the toolbar performs the default action for the file type, for example, run `.m` files, load `.mat` files, and open models. Hover over a shortcut to view the full path.
- Alternatively, select the Shortcut Management view, right-click the shortcut file, and select an action, such as **Open** or **Run**.

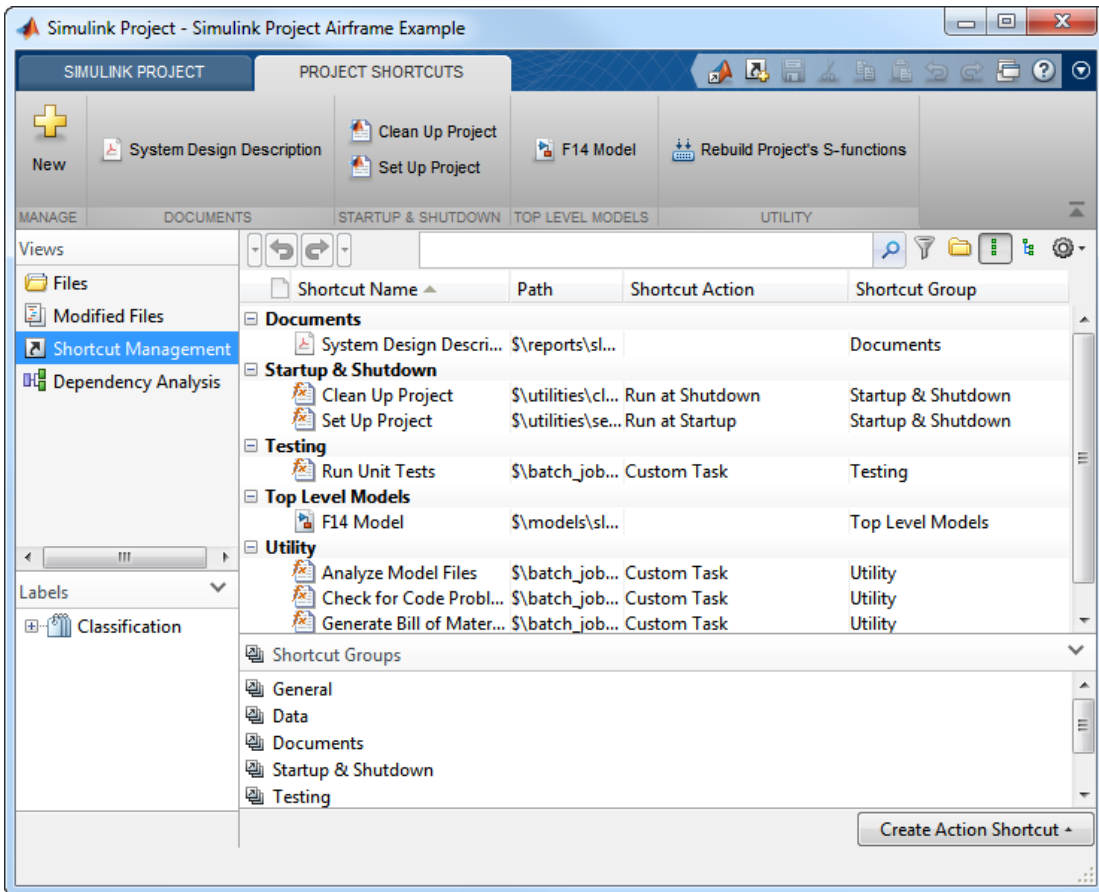

- To make a shortcut available in the Custom Task list without browsing for the file, select **Set Shortcut Action > Custom Task**.

Choose which behavior you want when running shortcuts:

- If the script is not on the path, and you want to switch to the parent folder and run the script without being prompted, then right-click and select **Run Shortcut** in the Shortcut Management view or click the shortcut in the Project Shortcuts toolbar tab. If you use this option, the result of `pwd` in the script is the parent folder of the script.
- If you select **Run** in the **Files** view context menu, and the script is not on the path, then MATLAB asks if you want to change folder or add the folder to the path. This is

the same behavior as running from the Current Folder browser. If you use this option, the result of `pwd` in the script is the current folder when you run the script.

### **Related Examples**

- “Create Shortcuts” on page 16-34
- “Group Shortcuts” on page 16-35
- “Annotate Shortcuts to Use Meaningful Names” on page 16-36
- “Create Shortcuts to Custom Task Job Functions” on page 17-42
- “Automate Startup Tasks with Shortcuts” on page 16-30

### **More About**

- “What Can You Do With Project Shortcuts?” on page 16-29

## Create Templates for Standard Project Settings

### In this section...

“Using Templates to Create Standard Project Settings” on page 16-41

“Create a Template from the Current Project” on page 16-41

“Create a Template from a Project Under Version Control” on page 16-42

“Edit a Template” on page 16-42

“Explore the Example Templates” on page 16-43

### Using Templates to Create Standard Project Settings

In Simulink Project, use templates to create and reuse a standard project structure. Templates help you make consistent projects across teams. You can use templates to create new projects that:

- Use a standard folder structure.
- Set up a company standard environment, for example, with company libraries on the path.
- Have access to tools such as company Model Advisor checks.
- Use company standard startup and shutdown scripts.
- Share labels and categories.

You can use templates to share information and best practices. You or your colleagues can create templates.

Create a template from a project when it is useful to reuse or share with others. You can use the template when creating new projects.

### Create a Template from the Current Project

In Simulink Project, when you create a template, it contains the structure and all the contents of the current project, enabling you to reuse scripts and other files for your standard project setup. You can choose whether to include the contents of referenced projects in the template.

- 1 Before creating the template, create a copy of the project, and edit the copy to contain only the files you want to reuse. Use the copy as the basis for the template.

---

**Note:** If the project is under version control, see instead “Create a Template from a Project Under Version Control” on page 16-42.

---

- 2** On the **Simulink Project** tab, in the **File** section, select **Share > Template**.
- 3** On the Create Template dialog box, edit the name and author, add a description to help template users.
- 4** If you have referenced projects and want to export the referenced project files, then select the **Include referenced projects in template** check box.
- 5** Click **Save As**. Choose a file location and click **Save**

## Create a Template from a Project Under Version Control

- 1** Get a new working copy of the project. See “Retrieve a Working Copy of a Project from Source Control” on page 19-29.
- 2** To avoid accidentally committing changes to your project meant only for the template, stop using source control with this sandbox as you work on the template. In the Source Control view, under **Available Source Control Integrations**, select **No Source Control Integration** and click **Reload**.
- 3** Remove the files that you do not want in the template. For example, you might want to reuse only the utility functions, startup and shutdown scripts, and labels. In the **Files** view, right-click unwanted files and select **Remove from Project**.
- 4** On the **Simulink Project** tab, in the **File** section, select **Share > Template** and use the dialog box to name and save the file.

To verify that your template behaves as you expect, create a new project that uses your new template. See “Create a New Project Using Templates” on page 16-23.

## Edit a Template

- 1** Create a new project that uses the template you want to modify. See “Create a New Project Using Templates” on page 16-23.
- 2** Make the changes.
- 3** On the **Simulink Project** tab, in the **File** section, select **Share > Template**.

Use the dialog box to create a new template or overwrite the existing one.

## Explore the Example Templates

Example templates are supplied with Simulink Project. You can use these templates as example structures for a new project. The templates include:

- The **Blank Project** template, which creates an empty project. Use this to manage existing files. As your project grows, the project helps you manage all your files as a unit. For example, the project can keep track of files as you add them, manage the path, provide shortcuts, run startup and shutdown scripts, help you rename and move files, warn you about shadowed files and unsaved changes, and optionally, add source control.
- The **Simple Project** template, which creates a simple project containing a blank model. After you use the template to create the project, the model has a shortcut so that you can open it from the toolstrip. The project manages your path and the location of the temporary files (slprj folder) when you open and close the project. As your project grows, the project helps you manage all your files as a unit.
- The **Code Generation** template, which shows how to get started with production code generation using plant and controller models. The controller settings are optimized for code efficiency. After you create the project, run the project shortcut "Generate Controller Code" to generate code and display a report.

---

**Tip:** If you want model templates suitable for code generation instead of the project template, try entering "code generation" in the start page search box.

---

This template requires Simulink Coder and Embedded Coder.

You can explore the templates using the Simulink start page. See "Create a New Project Using Templates" on page 16-23.

## Related Examples

- "Create a New Project Using Templates" on page 16-23
- "Compare Project or Model Templates" (Simulink Report Generator)





# Simulink Project File Management

---

- “Group and Sort File Views” on page 17-2
- “Search Inside Project Files and Filter File Views” on page 17-4
- “Work with Project Files” on page 17-8
- “Manage Shadowed and Dirty Model Files” on page 17-10
- “Move, Rename, Copy, or Delete Project Files” on page 17-12
- “Back Out Changes” on page 17-17
- “Upgrade Model Files to SLX and Preserve Revision History” on page 17-18
- “Create Labels” on page 17-24
- “Add Labels to Files” on page 17-25
- “View and Edit Label Data” on page 17-26
- “Automate Simulink Project Tasks Using Scripts” on page 17-28
- “Create a Custom Task Function” on page 17-41
- “Create Shortcuts to Custom Task Job Functions” on page 17-42
- “Run a Simulink Project Custom Task and Publish Report” on page 17-43
- “Sharing Simulink Projects” on page 17-47
- “Share Project by Email” on page 17-49
- “Share Project as a MATLAB Toolbox” on page 17-50
- “Share Project on GitHub” on page 17-51
- “Archive Projects in Zip Files” on page 17-53
- “Upgrade All Project Models” on page 17-55

## Group and Sort File Views

In Simulink Project, to group and sort the views in the Files view:

- Use the List view or Tree view buttons to switch between a flat list of files and a hierarchical tree of files.

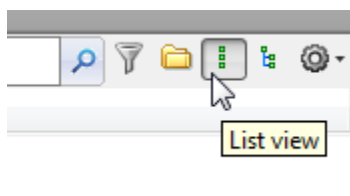

In a list view, you can click the **Hide Folders** button if you want to view only files.

- Click the Actions button  to specify display columns and sort order. For example, you can display columns for label categories that you created and sort files by label category.

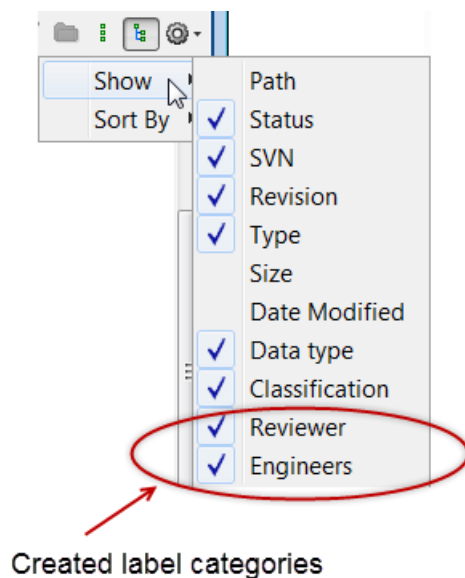

## **Related Examples**

- “Search Inside Project Files and Filter File Views” on page 17-4

## Search Inside Project Files and Filter File Views

### In this section...

“Project-Wide Search” on page 17-4

“Filter Project File Views” on page 17-6

“More Ways to Search” on page 17-7

### Project-Wide Search

In Simulink Project, you can search inside all your models and supporting files. You can find matches inside model files, MATLAB files, and other project files such as PDF and Microsoft Word files. You search only the current project. If you want to search referenced project files, open the referenced project.

- 1 On the Simulink Project tab, click **Search**. Alternatively, type in the file filter box, and the project provides a link to try searching inside files instead.

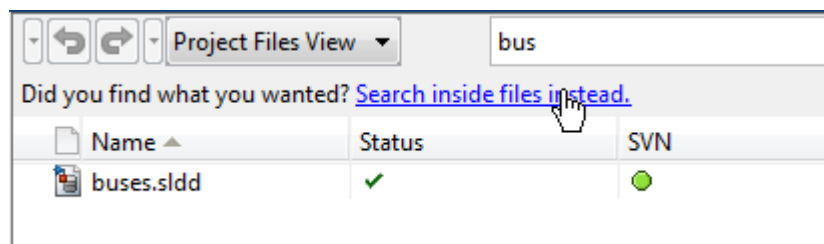

- 2 In the Search Inside Simulink Project Files dialog box, enter some characters to search for. Do not use quotes around phrases, or hyphens.
- 3 Expand files in the list to see results inside the file. Double-click results to locate specific items, e.g., highlight blocks in Simulink models, or highlight specific lines in MATLAB files.

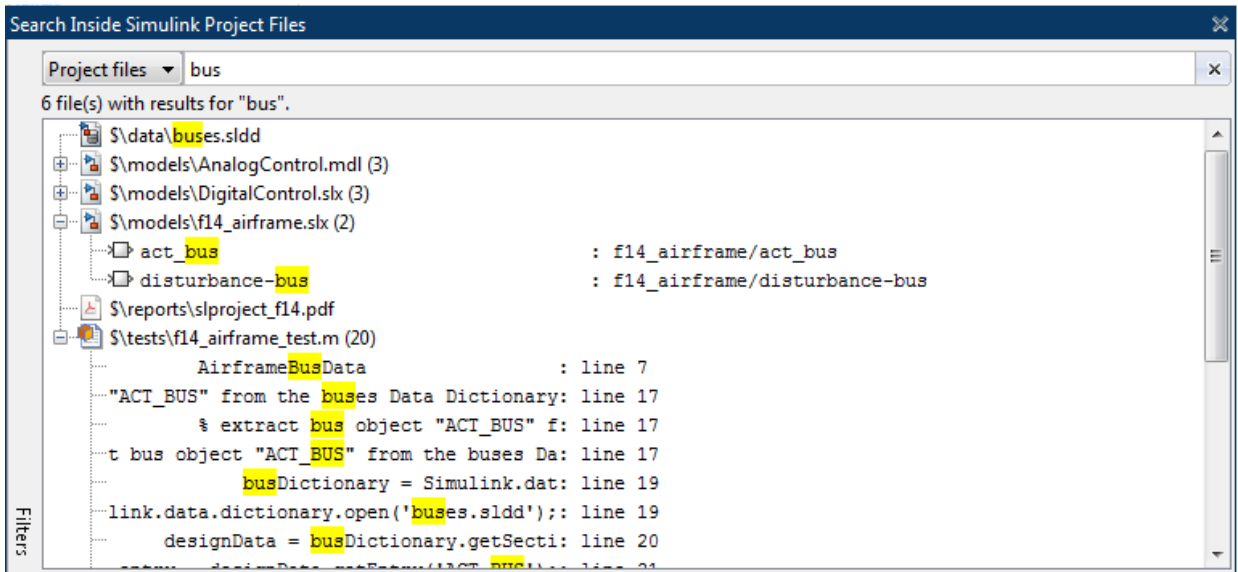

4 Click **Filters** to refine results by file type, status, or label.

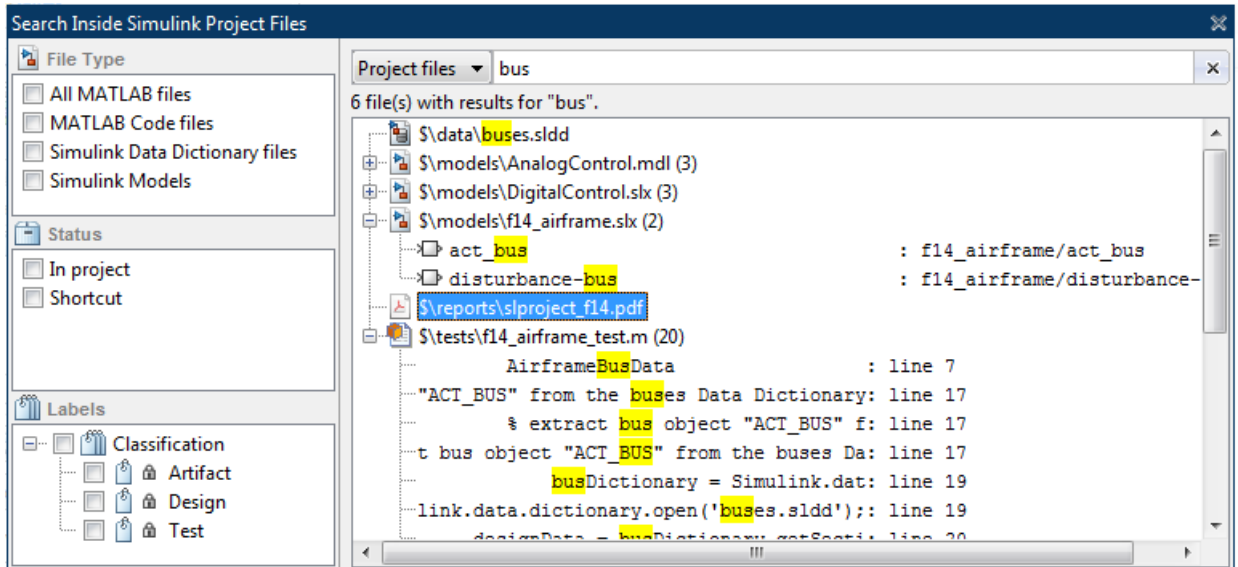

## Filter Project File Views

In the Simulink Project Files and Dependency Analysis views, and in the Custom Task dialog box, you can use the search box and filtering tools to specify file display.

- To view files, select the **Files** node. When **Project Files View** is selected, only the files in your project are shown. To see all the files in your sandbox, click the **Project Files View** button and select **All Files View**. This view shows all the files that are under the project root, not just the files that are in the project.
- To search, type a search term in the search box, for example, part of a file name or a file extension. You can use wildcards, for example, `*.m`, or `*.m*`.



Click **X** to clear the search.

- To build a filter for the current view, click the filter button .

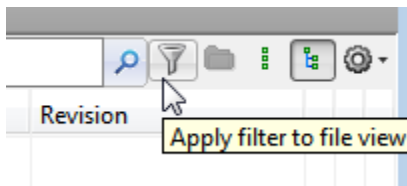

In the Filter Builder dialog box you can select multiple filter criteria to apply using names, file types, project status, and labels.

The dialog box reports the resulting filter at the bottom, for example:

Filter = file type is 'Model files (\*.slx, \*.mdl)' AND project status is 'In project' AND has label 'Engine Type:Diesel'

When you click **Apply**, the search box shows the filter that you are applying.

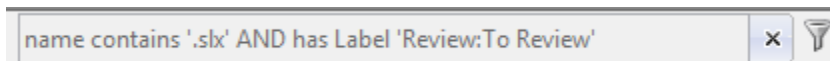

## More Ways to Search

You can also search:

- Model contents without loading the models into memory. On the MATLAB **Home** tab, in the **File** section, click **Find Files**. You can search a folder or the entire path. However, you cannot highlight results in models from the results in the Find Files dialog box the same way you do with project search. See “Advanced Search for Files” (MATLAB).
- A model hierarchy. In the Simulink Editor, select **Edit > Find**. Select options to look inside masks, links, and references. This search loads the models into memory. See “Find Model Elements in Simulink Models” on page 12-48
- For variables, block parameter values, or search a model hierarchy and contents using more options, using the Model Explorer. This search loads the models into memory. Use the Model Explorer to search for variables in workspaces and data dictionaries, and variable usage in a model. See “Edit and Manage Workspace Variables Used by Models” on page 57-92

## Related Examples

- “Group and Sort File Views” on page 17-2
- “Find Model Elements in Simulink Models” on page 12-48
- “Edit and Manage Workspace Variables Used by Models” on page 57-92

## Work with Project Files

In Simulink Project, in the **Files** view, use the context menus to perform actions on the files that you are viewing. Right-click a file (or selected multiple files) to perform project options such as:

- Open files.
- Add and remove files from the project.
- Add, change, and remove labels. See “Add Labels to Files” on page 17-25.
- Create entry point shortcuts (for example, code to run at startup or shutdown, open models, simulate, or generate code). See “Create Shortcuts to Frequent Tasks” on page 16-34.
- If a source control interface is enabled, you can also:
  - Refresh source control status.
  - Update from source control.
  - Check for modifications.
  - Revert.
  - Compare against revision (select a version to compare).

See “About Source Control with Projects” on page 19-2.

In the **Files** view, if you select, for example a model file, the bottom right-hand pane displays file information, a model preview, and file labels.



Name	Status	SVN	Revision	Classification
batch_jobs	✓	●	2	None
data	✓	●	2	None
models	✓	●	2	None
AnalogControl.mdl	✓	●	2	Design
DigitalControl.slx	✓	●	2	Design
<b>f14_airframe.slx</b>	✓	●	2	Design
LinearActuator.slx	✓	●	2	Design
NonLinearActuator.mdl	✓	●	2	Design
slproject_f14.slx	✓	●	2	Design
vertical_channel.slx	✓	●	2	Design
wind_gust_lib.slx	✓	●	2	Design
reports	✓	●	2	None
src	✓	●	2	None
tests	✓	●	2	None
utilities	✓	■	2	None

f14\_airframe.slx (Simulink Model) 1 labels

<b>Model version:</b> 1.25 <b>Saved in Simulink version:</b> R2015b <b>Last modified by:</b> The MathWorks Inc. (no description available)	<b>Preview:</b> 	<b>Classification:</b> Design Drag labels here
--	---------------------	--

## Related Examples

- “Open Recent Projects” on page 16-24
- “Add Files to the Project” on page 16-20
- “Move, Rename, Copy, or Delete Project Files” on page 17-12
- “Back Out Changes” on page 17-17
- “Group and Sort File Views” on page 17-2
- “Search Inside Project Files and Filter File Views” on page 17-4
- “Create a Custom Task Function” on page 17-41

## More About

- “What Can You Do With Project Shortcuts?” on page 16-29
- “About Source Control with Projects” on page 19-2

## Manage Shadowed and Dirty Model Files

### In this section...

“Identify Shadowed Project Files When Opening a Project” on page 17-10

“Find Models and MATLAB Files With Unsaved Changes” on page 17-11

“Manage Open Models When Closing a Project” on page 17-11

### Identify Shadowed Project Files When Opening a Project

If there are two model files with the same name on the MATLAB path, then the one higher on the path is loaded, and the one lower on the path is shadowed. This shadowing applies to all models and libraries (SLX and MDL files).

A loaded model always takes precedence over unloaded ones, regardless of its position on the MATLAB path. Loaded models can interfere when you try to use other files of the same name, especially when models are loaded but not visible. Simulink warns when you try to load a shadowed model, because the other model is already loaded and can cause conflicts. Simulink Project checks for shadowed files when you open a project.

- 1 When you open a Simulink project, it warns you if any models of the same names as your project models are already loaded. This check enables you to find and avoid shadowed files before opening any project models.

The Configuring Project Environment dialog box reports the **Identify shadowed project files** check fails. Click **Details**.

- 2 In the dialog box, you can choose to show or close individual files, or close all potentially shadowing files, by clicking the hyperlinks. To avoid working on the wrong files, close the loaded models.
- 3 After deciding whether to show or close the loaded models, click **OK** to return to the Configuring Project Environment dialog box.
- 4 Inspect the other project loading tasks, then click **Continue** to view the project.

---

**Tip:** To help avoid problems with shadowed files, turn on the Simulink preference **Do not load models that are shadowed on the MATLAB path**. See “Do not load models that are shadowed on the MATLAB path”.

---

To learn more about shadowed files, see “Shadowed Files” on page 15-4.

## Find Models and MATLAB Files With Unsaved Changes

You can check your project for models and MATLAB files with unsaved changes. On the **Simulink Project** tab, in the **Tools** section, click **Unsaved Changes**.

In the Unsaved Changes dialog box, you can see all dirty project models and MATLAB files. If you have referenced projects, files are grouped by project. You can save or discard all changes.

## Manage Open Models When Closing a Project

When you close a project, it closes any project models that are open, unless they are dirty.

When you close a project, if there are model files with unsaved changes, a message prompts you to save or discard changes. You can see all dirty files, grouped by project if you have referenced projects. To avoid losing work, you can save or discard changes by file, by project, or globally.

Control this behavior using the Simulink project shutdown preferences.

## Related Examples

- “Do not load models that are shadowed on the MATLAB path”
- “Shadowed Files” on page 15-4

## Move, Rename, Copy, or Delete Project Files

<b>In this section...</b>
“Move or Add Files” on page 17-12
“Automatic Updates When Renaming, Deleting, or Removing Files” on page 17-12

### Move or Add Files

To move or add project files, you can drag them to Simulink Project, or use clipboard operations.

- To add files to your project, you can paste files or drag them from your operating system file browser or the MATLAB Current Folder browser onto the Project Files View in Simulink Project. When you drag a file to the Project Files View, you add the file to the project. For projects under source control, you also add the file to source control.
- To move files within your project, cut and paste or drag files in the Simulink Project.

See also “Add Files to the Project” on page 16-20.

### Automatic Updates When Renaming, Deleting, or Removing Files

When you rename, delete, or remove files or folders in a Simulink project, the project checks for impact in other project files. You can find and fix impacts such as changed library links, model references, and model callbacks. You can avoid refactoring pain tracking down other affected files. Automatic renaming helps to prevent errors that result from changing names or paths manually and overlooking or mistyping one or more instances of the name.

For example:

- When renaming a library, the project offers to automatically update all library links to the renamed library.
- When renaming a class, the project offers to automatically update all classes that inherit from it. If you rename a `.m` or `.mlx` file, the project offers to automatically update any files and callbacks that call it.
- When deleting files or removing them from the project, the project prompts you if other files refer to them. You must decide how to fix the affected files manually.

- When renaming a C file, the project prompts you to update the S-function that uses it.

To use automatic updates:

- 1 Rename a model, library, or MATLAB file in a Simulink project.

The project runs a dependency analysis to look for impacts in other files.

- 2 In the Rename dialog box, you can examine impacted files, choose to rename and update, just rename, or cancel renaming the file.
- 3 If you choose automatic updates, you can examine the results in updated files.

### Automatic Renaming Using the Power Window Project

- 1 Open the power window example project by entering in MATLAB:

```
slexPowerWindowStart
```

The project opens the top model, some scopes, and an animation window.

- 2 In Simulink Project, expand the `model` folder, and rename the `slexPowerWindowControl.slx` model to `slexPowerWindowControlSystem.slx`.

The project runs a dependency analysis to look for impacts in other files, and then the Rename dialog box reports impacted files.

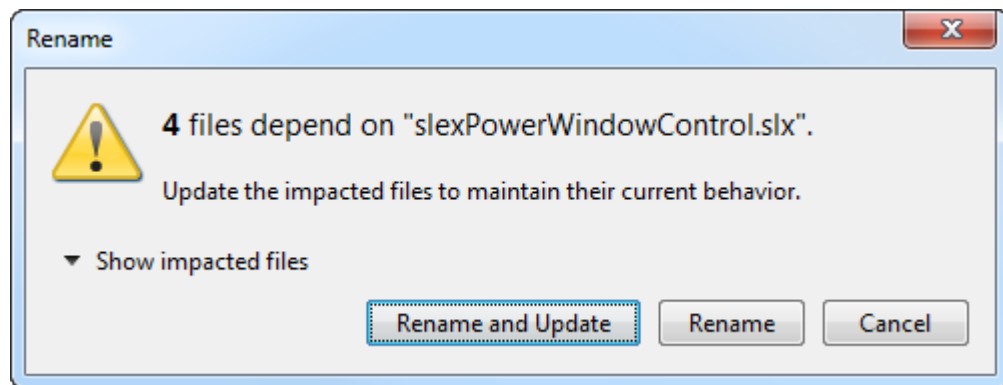

- 3 In the Rename dialog box, click **Show impacted files**. Expand the last impacted file to view the dependency, which is a model reference.

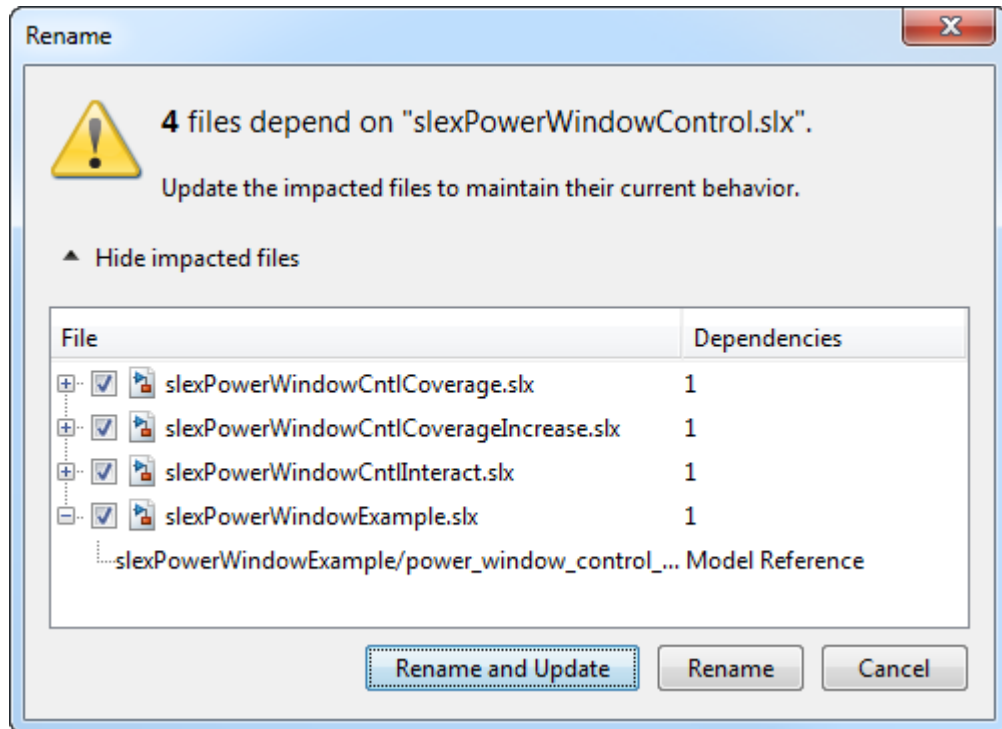

- 4 To view the dependency highlighted in the model, double-click the last **Model Reference** line in the Rename dialog box. Observe the model name on the highlighted control block, slexPowerWindowControl.

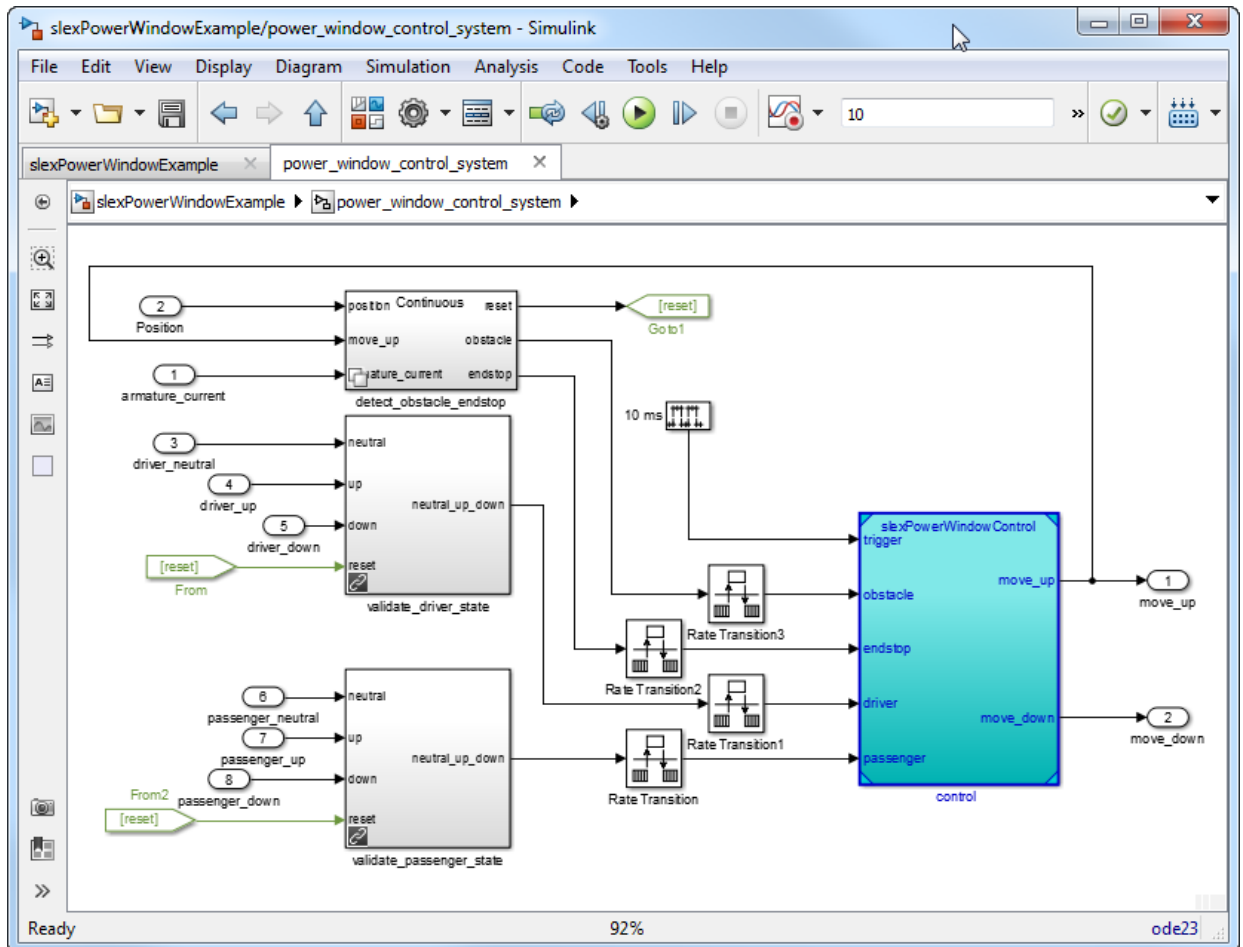

- 5 In the Rename dialog box, click **Rename and Update**.

The project updates the impact files to use the new model name in model references. When the project can automatically rename items, it reports success with a check mark. With some impacts, you must decide how to fix the affected files manually.

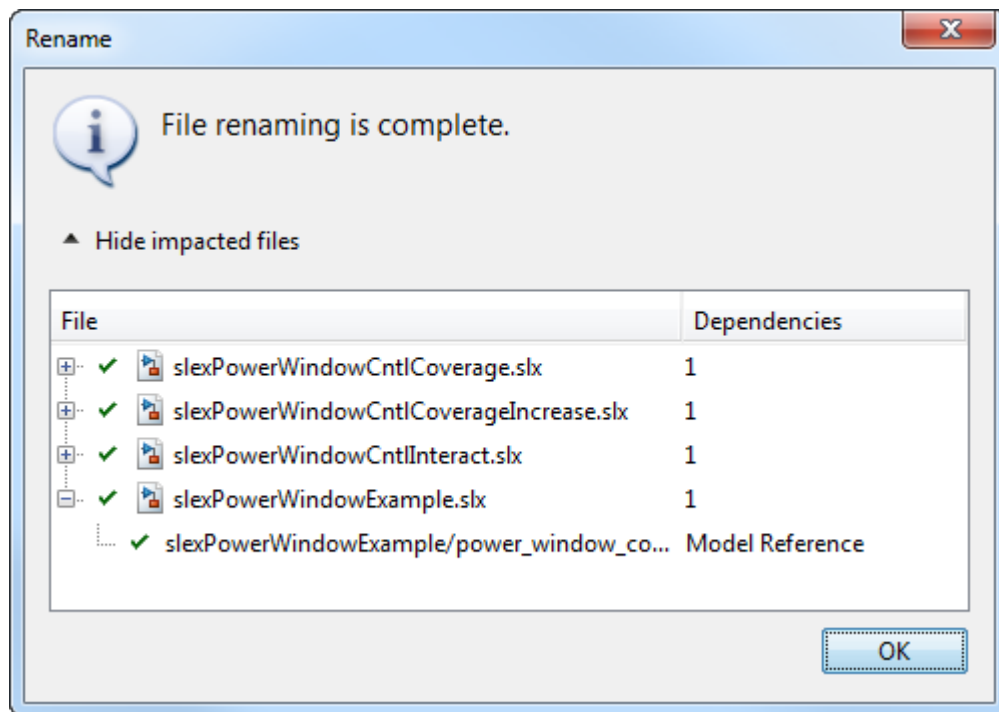

- 6 Examine the results by double-clicking items in the Rename dialog box. Double-click the last **Model Reference** line. Check if the model name on the highlighted control block is updated to `slxPowerWindowControlSystem`.

## Related Examples

- “Work with Project Files” on page 17-8



## Back Out Changes

Similar to many applications, Simulink Project enables you to Undo and Redo, to back out recent changes.

- 1 Click the arrow next to the Undo or Redo button.
- 2 Select the actions you want to undo or redo. You can select multiple actions. Hover over each action to view details in a tooltip.

If you are using source control, you can revert to particular versions of files or projects. See “Revert Changes” on page 19-51.

### Related Examples

- “Revert Changes” on page 19-51

## Upgrade Model Files to SLX and Preserve Revision History

### In this section...

“Project Tools for Migrating Model Files to SLX” on page 17-18

“Upgrade the Model and Commit the Changes” on page 17-18

“Verify Changes After Upgrade to SLX” on page 17-21

### Project Tools for Migrating Model Files to SLX

Simulink Project helps you upgrade model files from MDL format to SLX format. You can use the project integrity checks to automatically add the new SLX file to your project, remove the MDL file from the project, and preserve the revision history of your MDL file with the new SLX file. You can then commit your changes to source control and maintain the continuity of your model file history.

The following example shows how to use project checks to fix your project after manually saving a model as SLX.

### Upgrade the Model and Commit the Changes

- 1 Open a new copy of the `airframe` project.  
`sldemo_slproject_airframe`
- 2 In the Project Files View, right-click the model file `AnalogControl.mdl`, and select **Open**.
- 3 Select **File > Save As**.
- 4 Ensure that **Save as type** is SLX, and click **Save**. SLX is the default unless you change your preferences.
- 5 To see the results, in the Files view, click the **Project Files View** button and change the selection to the **All Files View**. Expand the `models` folder.

Simulink saves the model in SLX format, and creates a backup file by renaming the MDL file to `AnalogControl.mdl.releasename`. The project also reports the original name of the MDL file as missing.

Name	Status
batch_jobs	✓
data	✓
models	✓
AnalogControl.mdl	✗
AnalogControl.mdl.r2014b	·
AnalogControl.slx	·

- 6 To resolve these issues, on the Simulink Project tab, click **Check Project** to run the project integrity checks. The checks look for MDL files converted to SLX, and offer automatic fixes if that check fails.
- 7 Click the **Fix** button to view recommended actions and decide whether to make the changes.

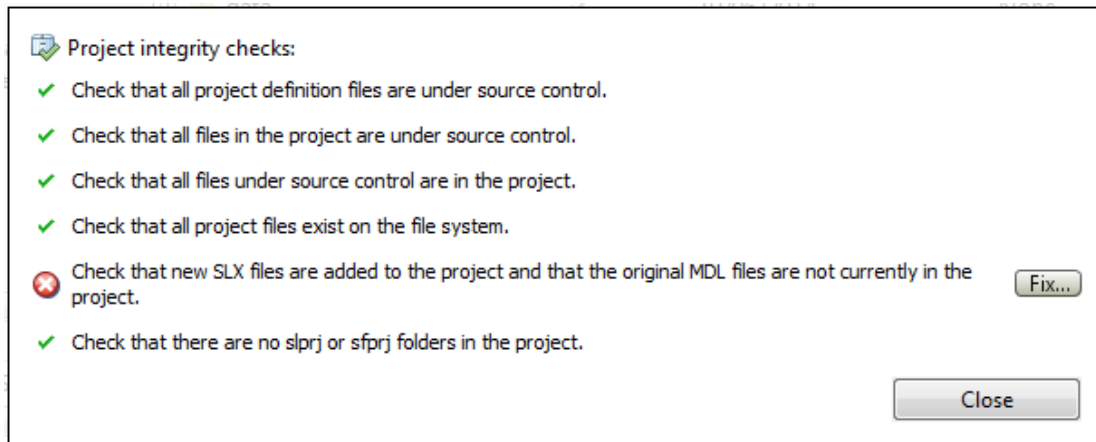

When you click **Fix**, the Missing Files dialog box offers to remove the missing MDL file from the project and add the new SLX file to the project.

- 8 Click **Yes** to perform the fix.

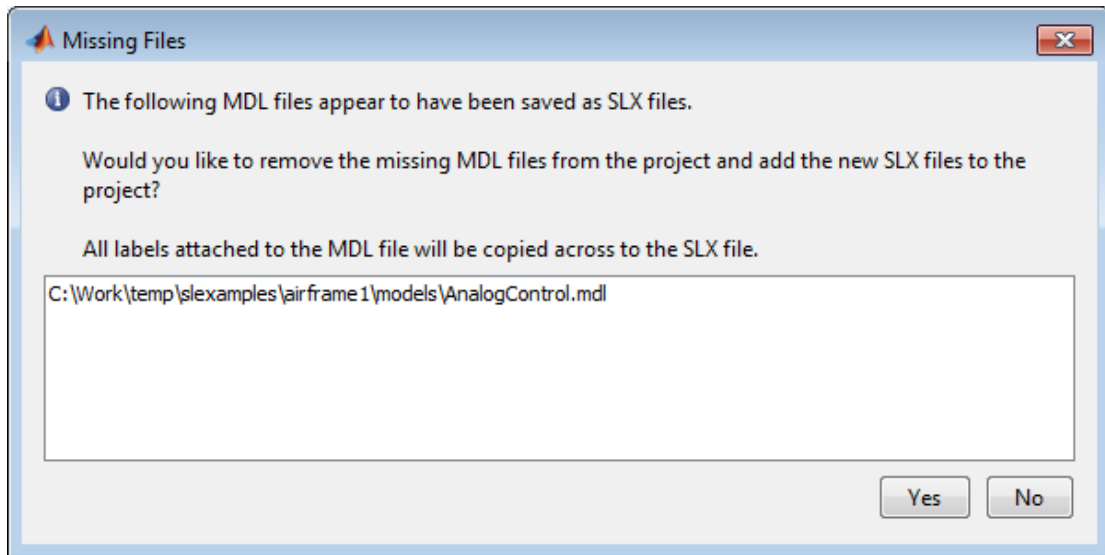

Project checks rerun after you click **Yes** to perform the fix.

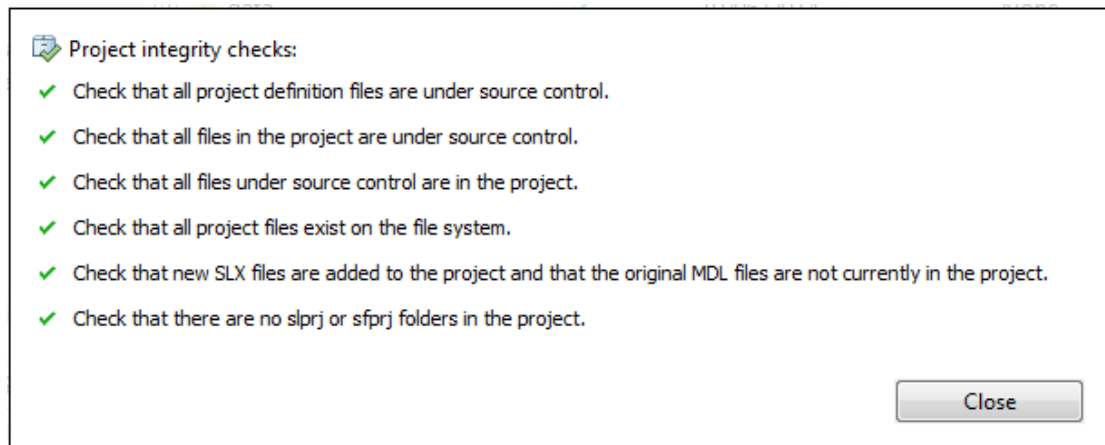

Close the Project Integrity Checks dialog box.

- 9 Select the Modified Files view. Expand the `models` folder and check the Modifications column to see that the newly created SLX file has been added to the project, and the original MDL file is scheduled for removal.

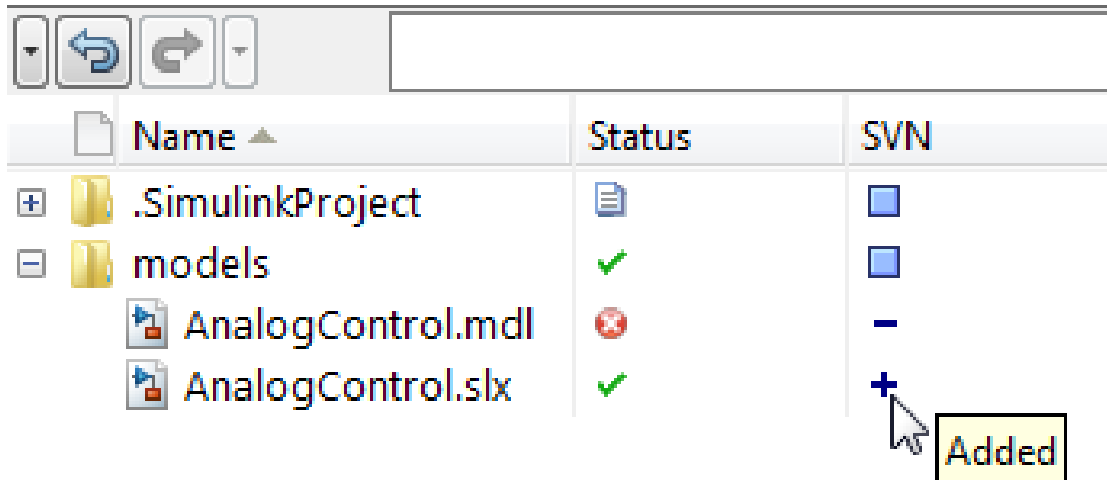

- 10 Click **Commit Modified Files**. Enter a comment for your submission in the dialog box, for example, Convert to SLX, and click **Submit**.

## Verify Changes After Upgrade to SLX

- 1 In the Files view, ensure the **All Files View** is selected. Check that the backup file `AnalogControl.mdl.r2012b` is still present, along with the new SLX file. Click the Actions button to customize the columns to show, such as **Date Modified**.

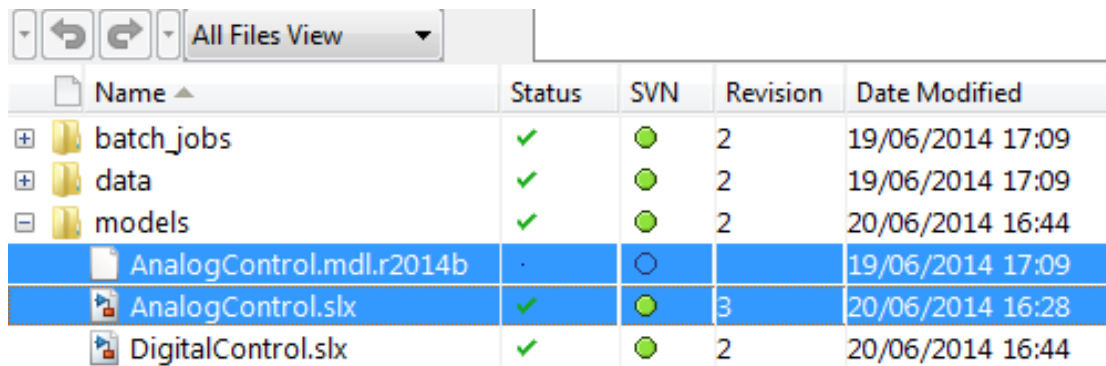

Name	Status	SVN	Revision	Date Modified
batch_jobs	✓	●	2	19/06/2014 17:09
data	✓	●	2	19/06/2014 17:09
models	✓	●	2	20/06/2014 16:44
AnalogControl.mdl.r2014b	·	○		19/06/2014 17:09
AnalogControl.slx	✓	●	3	20/06/2014 16:28
DigitalControl.slx	✓	●	2	20/06/2014 16:44

- 2 In the Files view, click the **All Files View** button and change the selection to the **Project Files View**. Check that only the new SLX file is included in the project, and the backup file is not included in the project.

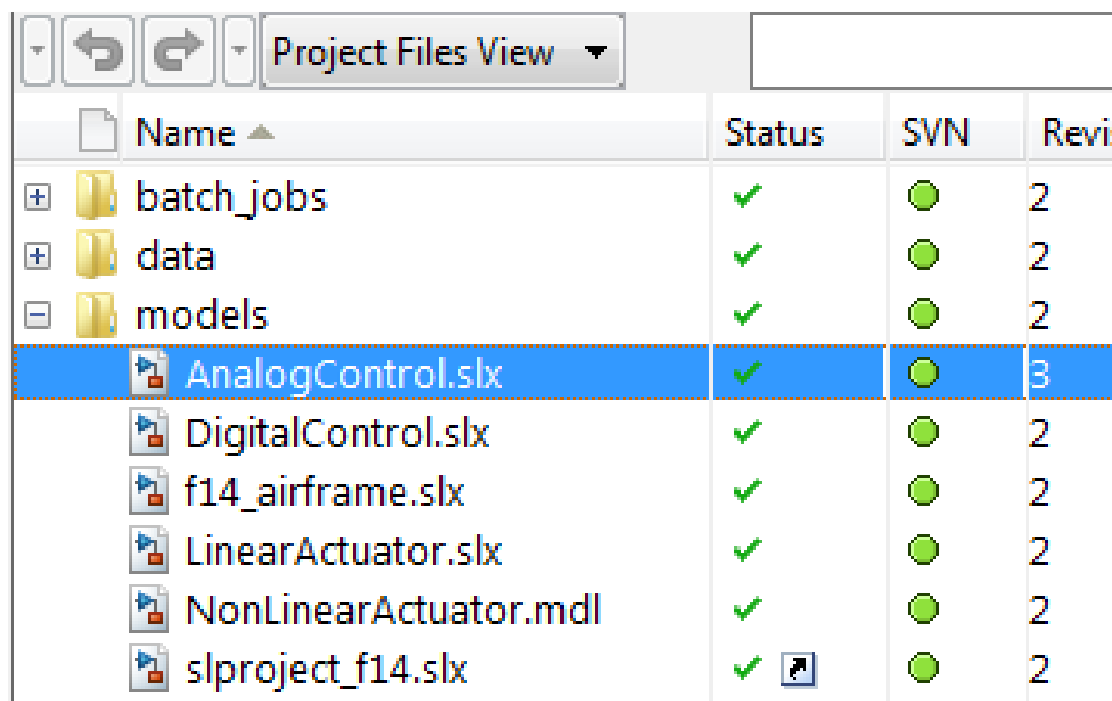

Name	Status	SVN	Revision
batch_jobs	✓	●	2
data	✓	●	2
models	✓	●	2
AnalogControl.slx	✓	●	3
DigitalControl.slx	✓	●	2
f14_airframe.slx	✓	●	2
LinearActuator.slx	✓	●	2
NonLinearActuator.mdl	✓	●	2
slproject_f14.slx	✓	●	2

- 3 Right-click the model file `AnalogControl.slx` and select **Show Revisions**.

- 4 In the File Revisions dialog box, verify that the previous revision is `AnalogControl.mdl`. The revision history of the previous model file is preserved with the new SLX file.

For an example showing commands to find and upgrade all model files in the project to SLX, see [Converting from MDL to SLX Model File Format in a Simulink Project](#).

---

**Note:** For an example showing how to programmatically upgrade a whole project using `upgradeadvisor`, see instead:

`sldemo_slproject_upgrade`

---

## Related Examples

- “Run Project Checks” on page 19-47

## Create Labels

In Simulink Project, use labels to organize files and communicate information to project users. You can create these types of label categories:

- Single-valued — You can attach only one label from the category to a file.
- Multi-valued — You can attach multiple labels from the category to a file.

The **Labels** tree has built-in labels in the single-valued **Classification** category:

- You cannot rename or delete **Artifact**, **Convenience**, **Derived**, **Design**, **None**, **Test**, and **Other**.
- You can rename or delete **Utility**.
- You cannot annotate built-in labels.

To create a label category:

- 1 In Simulink Project, right-click the **Labels** pane. Then select **Create New Category**.
- 2 In the Create Category dialog box, enter a name for the new category.
- 3 If you require a single-valued label category, select the **Single Valued** check box. The default is multi-valued.
- 4 If you want to specify a data type for the label other than **String**, from the **Type** list, select **Double**, **Integer**, **Logical**, or **None**.
- 5 Click **Create**.

To create a label in a category:

- 1 In the **Labels** pane, right-click the label category and select **Create New Label**.
- 2 In the Create Label dialog box, enter a name for the new label and click **OK**.

To rename or delete a category or label, right-click it and select **Rename** or **Remove**.

To create new labels at the command line, see .

## Related Examples

- “Add Labels to Files” on page 17-25
- “View and Edit Label Data” on page 17-26



## Add Labels to Files

In Simulink Project, use labels to organize files and communicate information to project users.

To add a label to a file, use one of these methods:

- Drag the label from the **Labels** pane onto the file.
- In the Files view, select the file. Then, drag the label from the **Labels** pane into the label editor.

To add a label to multiple files, in the Files view or Impact graph, select the files that require the label. Then right-click and select **Add Label**. Use the dialog box to specify the label.

To add labels programmatically, for example, in custom task functions, see .

---

**Note:** After you add a label to a file, the label persists across file revisions.

---

After you add labels, you can organize files by label in the Files view and Impact graph. See “Group and Sort File Views” on page 17-2 and “Perform Impact Analysis” on page 18-7.

If the project is under SVN source control, adding tags to all your project files enables you to mark versions. See “Tag and Retrieve Versions of Project Files” on page 19-34.

### Related Examples

- “Create Labels” on page 17-24
- “View and Edit Label Data” on page 17-26

## View and Edit Label Data

When you select a file in the Simulink Project Files view, the file labels appear in the label editor view.

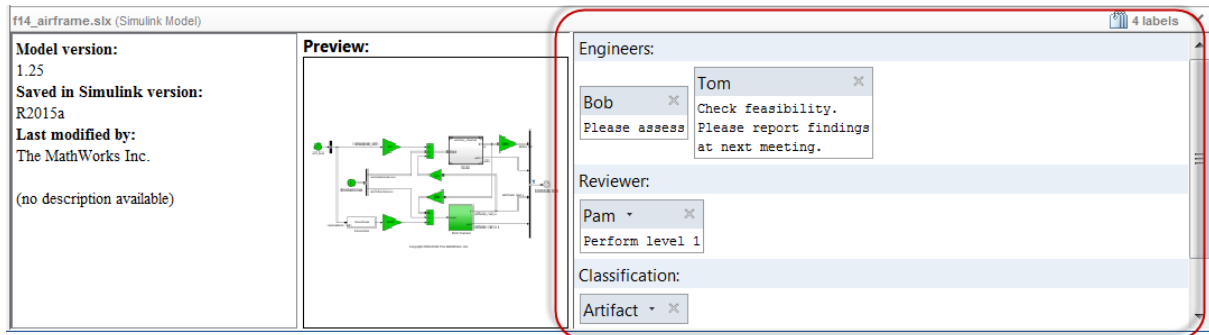

To change a label that belongs to a single-valued category, select the new value from the label list.

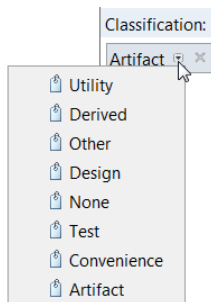

You can annotate labels from categories that you create. In the label, insert or modify text. Then, click **Apply**.

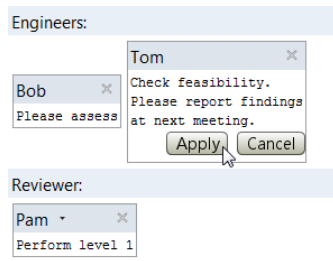

## Related Examples

- "Create Labels" on page 17-24
- "Add Labels to Files" on page 17-25

## Automate Simulink Project Tasks Using Scripts

This example shows how to use the Simulink project API to automate project tasks manipulating files, including working with modified files, dependencies, shortcuts, and labels.

### Get Simulink Project at the Command Line

Open the Airframe project and use `simulinkproject` to get a project object to manipulate the project at the command line. You must open a project in Simulink Project to perform command-line operations on the project.

```
sldemo_slproject_airframe
proj = simulinkproject

Creating sandbox for project.
Created example files in "C:\slexamples\airframe21"
Initializing: Project Path
Identifying shadowed project files
Running: C:\slexamples\airframe21\utilities\set_up_project.m
Building with 'MinGW64 Compiler C '.
MEX completed successfully.

proj =

    ProjectManager with properties:

        Name: 'Simulink Project Airframe Example'
        Information: [1x1 slproject.Information]
        Dependencies: [1x1 slproject.Dependencies]
        Shortcuts: [1x9 slproject.Shortcut]
        ProjectPath: [1x7 slproject.PathFolder]
        ProjectReferences: [1x0 slproject.ProjectReference]
        Categories: [1x1 slproject.Category]
        Files: [1x33 slproject.ProjectFile]
        RootFolder: 'C:\slexamples\airframe21'
```

### Find Project Commands

Find out what you can do with your project.

```
methods(proj)
```

Methods for class `slproject.ProjectManager`:

```

addFile                                isLoaded
addFolderIncludingChildFiles           listModifiedFiles
close                                  refreshSourceControl
createCategory                         reload
export                                 removeCategory
findCategory                           removeFile
findFile
getFilesRequiredBy

```

### Examine Project Files

After you get a project object, you can examine project properties such as files.

```
files = proj.Files
```

```
files =
```

```
    1×33 ProjectFile array with properties:
```

```

    Path
    Labels
    Revision
    SourceControlStatus

```

Use indexing to access files in this list. The following command gets file number 14. Each file has properties describing its path and attached labels.

```
proj.Files(14)
```

```
ans =
```

```
ProjectFile with properties:
```

```

    Path: 'C:\slexamples\airframe21\models\AnalogControl.mdl'
    Labels: [1×1 slproject.Label]
    Revision: '2'
    SourceControlStatus: Unmodified

```

Examine the labels of the 14th file.

```
proj.Files(14).Labels
```

```
ans =
```

```
Label with properties:
```

```
File: 'C:\slexamples\airframe21\models\AnalogControl.mdl'  
DataType: 'none'  
Data: []  
Name: 'Design'  
CategoryName: 'Classification'
```

Get a particular file by name.

```
myfile = findFile(proj, 'models/AnalogControl.mdl')
```

```
myfile =
```

```
ProjectFile with properties:
```

```
Path: 'C:\slexamples\airframe21\models\AnalogControl.mdl'  
Labels: [1x1 slproject.Label]  
Revision: '2'  
SourceControlStatus: Unmodified
```

Find out what you can do with the file.

```
methods(myfile)
```

```
Methods for class slproject.ProjectFile:
```

```
addLabel findLabel removeLabel
```

### Get Modified Files

Modify a project model file by adding an arbitrary block.

```
open_system('AnalogControl')  
add_block('built-in/SubSystem', 'AnalogControl/test')
```

```
save_system('AnalogControl')
```

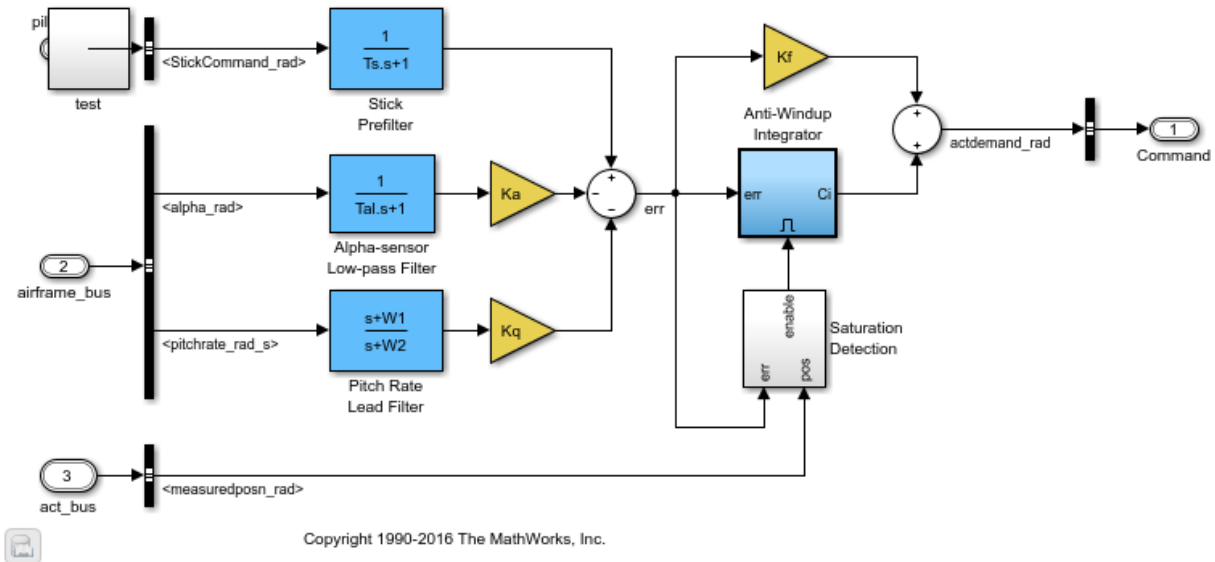

Get all the modified files in the project. Observe two modified files. Compare with the Modified Files view in Simulink Project, where you can see a modified model file, and the corresponding .SimulinkProject definition file.

```
modifiedfiles = listModifiedFiles(proj)
```

```
modifiedfiles =
```

```
1x2 ProjectFile array with properties:
```

```
Path
Labels
Revision
SourceControlStatus
```

Get the second modified file. Observe the file `SourceControlStatus` property is `Modified`. Similarly, `listModifiedFiles` returns any files that are added, conflicted, deleted, etc., that show up in the Modified Files view in Simulink Project.

```
modifiedfiles(2)
```

```
ans =
```

```
ProjectFile with properties:
```

```
    Path: 'C:\slexamples\airframe21\models\AnalogControl.mdl'  
    Labels: [1x1 slproject.Label]  
    Revision: '2'  
    SourceControlStatus: Modified
```

Refresh source control status before querying individual files. You do not need to do before using `listModifiedFiles`.

```
refreshSourceControl(proj)
```

Get all the project files with a particular source control status. For example, get the files that are `Unmodified`.

```
proj.Files(ismember([proj.Files.SourceControlStatus], matlab.sourcecontrol.Status.Unmodified))
```

```
ans =
```

```
1x32 ProjectFile array with properties:
```

```
    Path  
    Labels  
    Revision  
    SourceControlStatus
```

### Get File Dependencies

Update the file dependencies. The project runs a dependency analysis to update the known dependencies between project files.

```
update(proj.Dependencies)
```

Examine the dependencies in the project object. The `dependencies` property of the project object contains the graph of dependencies between project files in a MATLAB digraph object. You can view the same dependency analysis graph in the Impact view of Simulink



Project. If you want to plot the graph, instead of working with the digraph object, save the impact view to an image file.

```
proj.Dependencies
```

```
ans =
```

```
Dependencies with properties:
```

```
Graph: [1×1 digraph]
```

Get the graph dependencies. You can use digraph methods to get information from the graph.

```
g = proj.Dependencies.Graph
```

```
g =
```

```
digraph with properties:
```

```
Edges: [24×1 table]
```

```
Nodes: [25×1 table]
```

Get the files required by a model.

```
requiredFiles = bfsearch(g, which('AnalogControl'))
```

```
requiredFiles =
```

```
3×1 cell array
```

```
'C:\slexamples\airframe21\models\AnalogControl.mdl'
```

```
'C:\slexamples\airframe21\data\controller.sldd'
```

```
'C:\slexamples\airframe21\data\buses.sldd'
```

Get the top-level files of all types in the graph.

```
top = g.Nodes.Name(indegree(g)==0);
```

Get the top-level files that have dependencies.

```
top = g.Nodes.Name(indegree(g)==0 & outdegree(g)>0)

top =
    7×1 cell array

    'C:\slexamples\airframe21\models\DigitalControl.slx'
    'C:\slexamples\airframe21\models\LinearActuator.slx'
    'C:\slexamples\airframe21\models\slproject_f14.slx'
    'C:\slexamples\airframe21\tests\f14_airframe_test.m'
    'C:\slexamples\airframe21\utilities\rebuild_s_functions.m'
    'C:\slexamples\airframe21\utilities\set_up_project.m'
    'C:\slexamples\airframe21\utilities\upgrade_project.m'
```

Find impacted (or "upstream") files by creating a transposed graph.

```
transposed = flippedge(g)
impacted = bfsearch(transposed, which('vertical_channel'))
```

```
transposed =
    digraph with properties:
        Edges: [24×1 table]
        Nodes: [25×1 table]
```

```
impacted =
    4×1 cell array

    'C:\slexamples\airframe21\models\vertical_channel.slx'
    'C:\slexamples\airframe21\models\f14_airframe.slx'
    'C:\slexamples\airframe21\models\slproject_f14.slx'
    'C:\slexamples\airframe21\tests\f14_airframe_test.m'
```

Find files impacted by a data dictionary.

```
impacted2 = bfsearch(transposed, which('buses.sldd'))
```

```

impacted2 =

    11x1 cell array

    'C:\slexamples\airframe21\data\buses.slidd'
    'C:\slexamples\airframe21\data\controller.slidd'
    'C:\slexamples\airframe21\data\system_model.slidd'
    'C:\slexamples\airframe21\tests\f14_airframe_test.m'
    'C:\slexamples\airframe21\models\AnalogControl.mdl'
    'C:\slexamples\airframe21\models\DigitalControl.slx'
    'C:\slexamples\airframe21\models\f14_airframe.slx'
    'C:\slexamples\airframe21\models\LinearActuator.slx'
    'C:\slexamples\airframe21\models\NonLinearActuator.mdl'
    'C:\slexamples\airframe21\models\slproject_f14.slx'
    'C:\slexamples\airframe21\models\vertical_channel.slx'

```

Get information on your files, such as the number of dependencies and orphans.

```

averageNumDependencies = mean(outdegree(g));
numberOfOrphans = sum(indegree(g)+outdegree(g)==0);

```

If you want to make changes to a model hierarchy, starting from the bottom up, find the topological order.

```

ordered = g.Nodes.Name(flip(toposort(g)));

```

### Query Shortcuts

Examine the project's Shortcuts property. You can automate startup and shutdown tasks using shortcuts, or use them to save frequent tasks and frequently accessed files.

```

shortcuts = proj.Shortcuts

```

```

shortcuts =

```

```

    1x9 Shortcut array with properties:

```

```

    File
    RunAtStartup
    RunAtShutdown

```

Examine a shortcut in the array.

```
shortcuts(9)
```

```
ans =
```

```
Shortcut with properties:
```

```
File: 'C:\slexamples\airframe21\utilities\set_up_project.m'
RunAtStartup: 1
RunAtShutdown: 0
```

The RunAtStartup property is set to 1, so this shortcut file is set to run at project startup. At the command line, you can view but not change the RunAtStartup and RunAtShutdown properties. To set these properties, use the shortcut tools Simulink Project. Get the file path of a shortcut.

```
shortcuts(6).File
```

```
ans =
```

```
1×50 char array
```

```
C:\slexamples\airframe21\reports\slproject_f14.pdf
```

Examine all the files in the shortcuts cell array.

```
{shortcuts.File}'
```

```
ans =
```

```
9×1 cell array
```

```
'C:\slexamples\airframe21\batch_jobs\billOfMaterials.m'
'C:\slexamples\airframe21\batch_jobs\checkCodeProblems.m'
'C:\slexamples\airframe21\batch_jobs\runUnitTest.m'
'C:\slexamples\airframe21\batch_jobs\saveModelFiles.m'
'C:\slexamples\airframe21\models\slproject_f14.slx'
'C:\slexamples\airframe21\reports\slproject_f14.pdf'
'C:\slexamples\airframe21\utilities\clean_up_project.m'
'C:\slexamples\airframe21\utilities\rebuild_s_functions.m'
'C:\slexamples\airframe21\utilities\set_up_project.m'
```

Create a logical array that shows the shortcuts set to run at startup.

```
idx = [shortcuts.RunAtStartup]

idx =

    1×9 logical array

    0    0    0    0    0    0    0    0    1
```

Use the logical array to get only the startup shortcuts.

```
startupshortcuts = shortcuts(idx)

startupshortcuts =

    Shortcut with properties:

                File: 'C:\slexamples\airframe21\utilities\set_up_project.m'
        RunAtStartup: 1
        RunAtShutdown: 0
```

Get the path of the startup shortcut by accessing the File property.

```
startupshortcuts.File

ans =

    1×51 char array

C:\slexamples\airframe21\utilities\set_up_project.m
```

### Label files

Create a new category of labels, of type char. In Simulink Project, the new Engineers category appears in the Labels pane.

```
createCategory(proj, 'Engineers', 'char')
```

```
ans =  
  
    Category with properties:  
  
        Name: 'Engineers'  
    SingleValued: 0  
        DataType: 'char'  
    LabelDefinitions: [1×0 slproject.LabelDefinition]
```

Find out what you can do with the new category.

```
category = findCategory(proj, 'Engineers');  
methods(category)
```

```
Methods for class slproject.Category:  
  
createLabel  findLabel  removeLabel
```

Define a new label in the new category.

```
createLabel(category, 'Bob');
```

Get a label definition.

```
ld = findLabel(category, 'Bob')
```

```
ld =  
  
    LabelDefinition with properties:  
  
        Name: 'Bob'  
    CategoryName: 'Engineers'
```

Attach a label to the retrieved file, myfile. If you select the file in Simulink Project, you can see this label in the label editor pane.

```
addLabel(myfile, 'Engineers', 'Bob');
```

Get a particular label and attach data to it, for example, some text.

```
label = findLabel(myfile, 'Engineers', 'Bob');
label.Data = 'Please assess'
```

```
label =
```

```
Label with properties:
```

```
File: 'C:\slexamples\airframe21\models\AnalogControl.mdl'
DataType: 'char'
Data: 'Please assess'
Name: 'Bob'
CategoryName: 'Engineers'
```

You can specify a variable for the label data, for example:

```
mydata = label.Data
```

```
mydata =
```

```
1×13 char array
```

```
Please assess
```

Create a new label category with numeric data type.

```
createCategory(proj, 'Assessors', 'double');
category = findCategory(proj, 'Assessors');
createLabel(category, 'Sam');
```

Attach the new label to a specified file and assign data value 2 to the label.

```
myfile = proj.Files(14);
addLabel(myfile, 'Assessors', 'Sam', 2)
```

```
ans =
```

```
Label with properties:
```

```
File: 'C:\slexamples\airframe21\models\AnalogControl.mdl'
DataType: 'double'
Data: 2
```

```
Name: 'Sam'  
CategoryName: 'Assessors'
```

### Close Project

Closing the project at the command line is the same as closing the project using the Simulink Project tool. For example, the project runs shutdown scripts and checks for unsaved models.

```
close(proj)
```

```
Running: C:\slexamples\airframe21\utilities\clean_up_project.m  
Closing Project Models  
Clearing: Project Path
```

### More Information

For more details on using the API, enter: `doc simulinkproject`.

To automate start and shutdown tasks, see “Automate Startup Tasks with Shortcuts”.

### See Also

```
addLabel | createCategory | createLabel | listModifiedFiles |  
refreshSourceControl | simulinkproject
```

### Related Examples

- “Perform Impact Analysis” on page 18-7
- “Automate Startup Tasks with Shortcuts” on page 16-30
- “View Modified Files” on page 19-41
- “Create Labels” on page 17-24
- “Add Labels to Files” on page 17-25
- “View and Edit Label Data” on page 17-26
- Automate Label Management in a Simulink Project



## Create a Custom Task Function

In Simulink Project, you can create functions and run them on selected project files.

For example custom task functions, see “Running Custom Tasks with a Simulink Project”.

To create a custom task function:

- 1** In the Simulink Project, click **Custom Task**.
- 2** In the Custom Task dialog box, click **Create**. Name and save the file on your MATLAB path. Simulink Project adds the file to the project and makes it a shortcut so it is easy to reuse.
- 3** The MATLAB Editor opens the new file containing a simple example custom task function for you to edit. Edit the function to perform the desired action on each file. The instructions guide you to create a custom task with the correct function signature. Save the file.
- 4** In the Custom Task dialog box, select project files to include using the check boxes, and click **Run Task**.
- 5** After your custom task function runs, view the results in the Custom Task Report.
- 6** To save the results in a file, click **Publish Report**.

Similarly, you can create a custom task in the Shortcut Management view by selecting **Create Action Shortcut > Custom Task Function**.

To make existing custom task functions into shortcuts, see “Create Shortcuts to Custom Task Job Functions” on page 17-42.

### Related Examples

- “Run a Simulink Project Custom Task and Publish Report” on page 17-43

## Create Shortcuts to Custom Task Job Functions

You can make existing custom task functions in the project easier to find and reuse by making them shortcuts. These shortcuts are available in the Custom Task list without browsing for the file.

- 1 In the Project Files view, right-click the custom task function and select **Create Shortcut**.
- 2 In the Shortcut Management view, right-click the custom task function and select **Set Shortcut Action > Custom Task**.
- 3 In the Custom Task dialog box, click the **Custom task** drop-down arrow to choose from a list of custom task shortcuts and recently used shortcuts.

### Related Examples

- “Create a Custom Task Function” on page 17-41
- “Run a Simulink Project Custom Task and Publish Report” on page 17-43

## Run a Simulink Project Custom Task and Publish Report

- 1 In Simulink Project, click **Custom Task**, and then select the check boxes of project files you want to include in the custom task.

---

**Tip:** If the function can identify the files to operate on, include all files. For example, the custom task function `saveModelFiles` in the `airframe` project checks that the file is a Simulink model and does nothing if it is not.

---

To select multiple files, **Shift** or **Ctrl**+click, and then right-click a file and select **Include** or **Exclude**.

- 2 Specify the custom task function to run in the **Custom task** box. Enter the name, or click **Browse**, or choose from a list of custom task shortcuts and recently used shortcuts.

If your project does not yet contain any custom task functions, see “Create a Custom Task Function” on page 17-41.

- 3 Click **Run Task**.

Simulink Project displays the results.

- 4 To view details of results for the currently selected file, click a file and check the Results pane.

You can publish a report of your custom task results. For example, try this custom task:

- 1 Open an example project by entering `sldemo_slproject_batchjobs`.
- 2 In Simulink Project, click **Custom Task**.
- 3 In the Custom Task dialog box, click the **Custom task** drop-down arrow to choose from a list of shortcuts, and select **Generate Bill of Materials Report**.

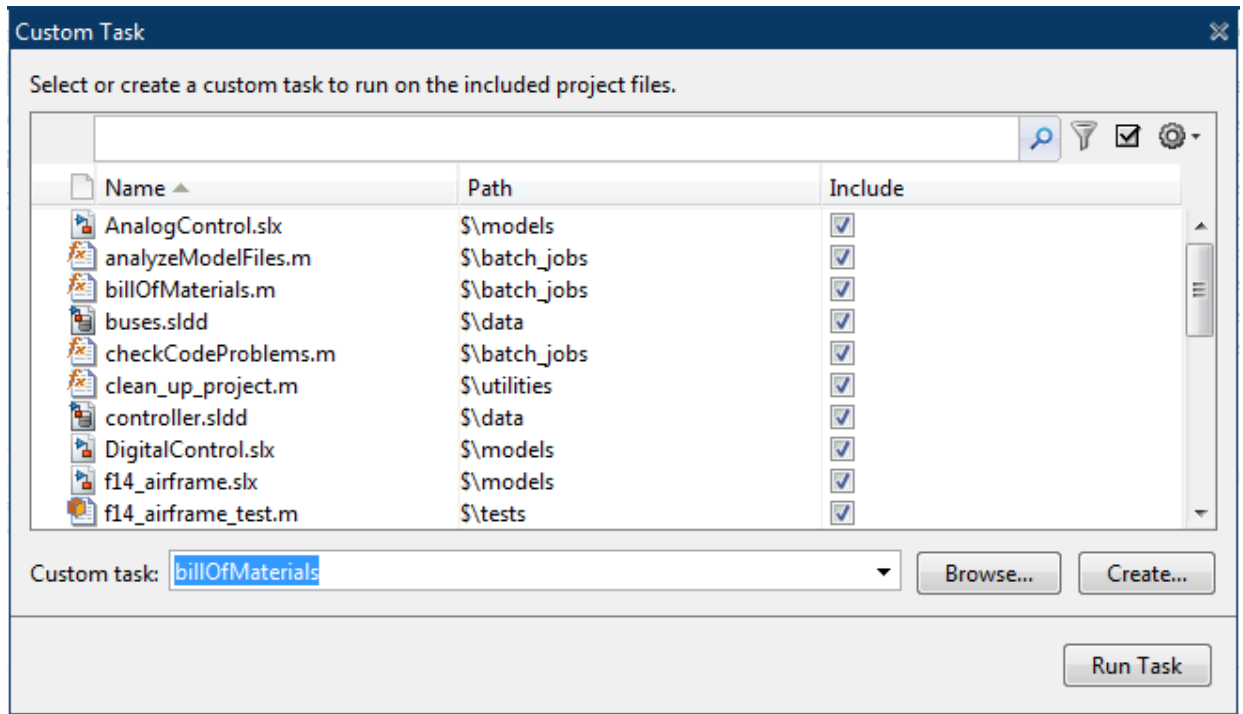

- 4 Click **Run Task**. Results appear.

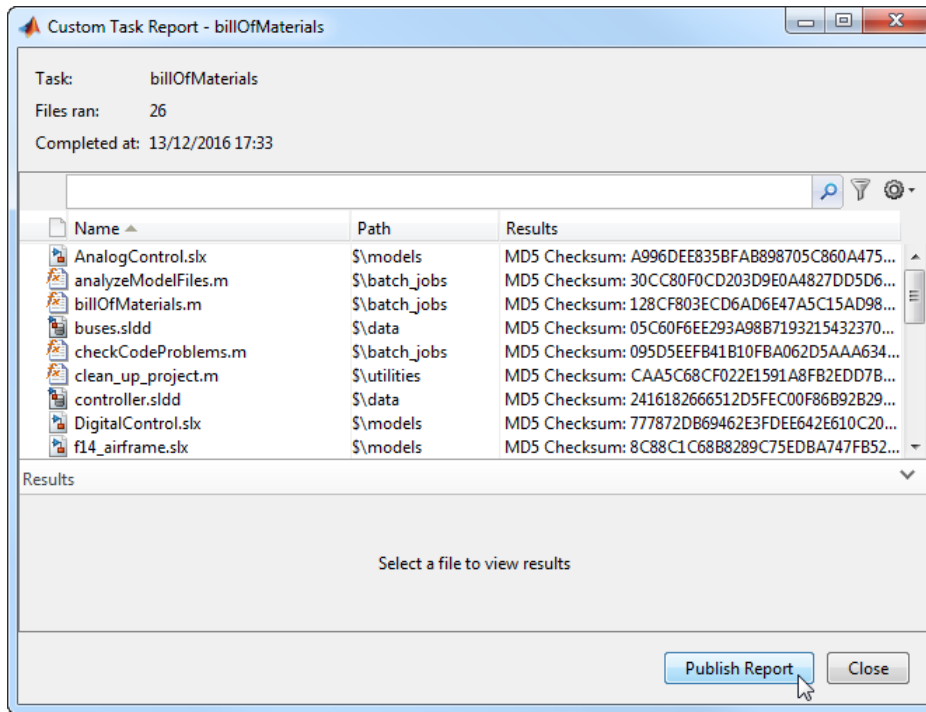

- 5 Click **Publish Report**.
- 6 In the file browser, specify a name and location for the report, and choose a file type from HTML or Microsoft Word. If you have MATLAB Report Generator, you can also choose PDF.
- 7 View the results in the report.

The example custom task function **Generate Bill of Materials Report** creates a list of project files, their source control status, revision numbers, and MD5 checksums. You can view the code for this custom task in the file `billOfMaterials.m`.

- 8 To see the report file and add it to your project, switch to the **All Files View**.

---

**Tip:** To try example custom tasks in a project, see the example “Running Custom Tasks with a Simulink Project”.

---

### **Related Examples**

- “Create a Custom Task Function” on page 17-41
- “Running Custom Tasks with a Simulink Project”
- Perform Impact Analysis with a Simulink Project

## Sharing Simulink Projects

Simulink projects help you collaborate. Use the **Share** menu to share your project in these ways:

- Archive your project in a zip file.
- Share your project by email (Windows only).
- Create a template from your project.
- Package your project as a MATLAB toolbox.
- Make your project publicly available on GitHub.

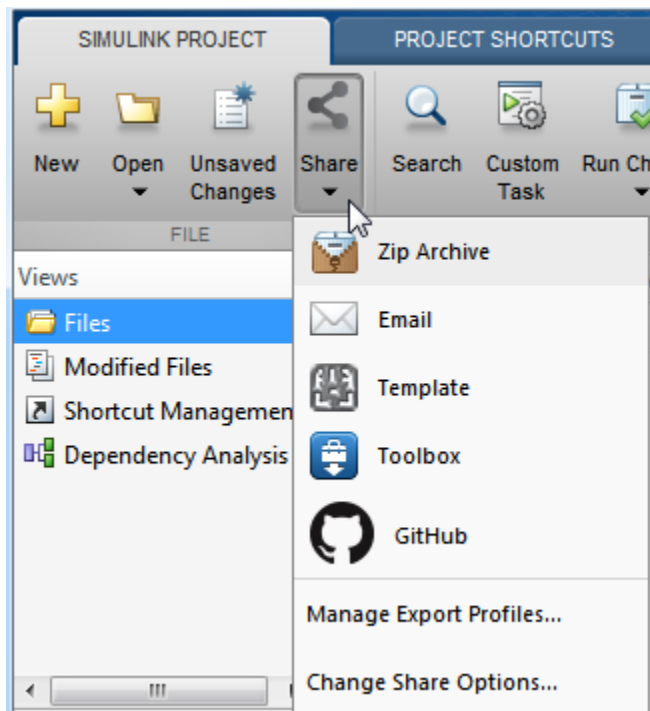

You can also collaborate by using source control within Simulink projects.

### Related Examples

- “Archive Projects in Zip Files” on page 17-53

- “Create Templates for Standard Project Settings” on page 16-41
- “Share Project by Email” on page 17-49
- “Share Project as a MATLAB Toolbox” on page 17-50
- “Share Project on GitHub” on page 17-51

### **More About**

- “About Source Control with Projects” on page 19-2



## Share Project by Email

To package and share Simulink project files on Windows, you can email your project as a zip file attachment. For example, you can share the project with people who do not have access to the connected source control tool.

- 1 With a project loaded, on the **Simulink Project** tab, select **Share > Email**.

The project opens a new email in your default email client with the project attached as a zip file.

- 2 Edit and send the email.

### Related Examples

- “Create a New Project from an Archived Project” on page 16-22
- “Archive Projects in Zip Files” on page 17-53

### More About

- “Sharing Simulink Projects” on page 17-47

## Share Project as a MATLAB Toolbox

To package and share Simulink project files, you can create a MATLAB toolbox from your project.

- 1 With a project loaded, on the **Simulink Project** tab, select **Share > Toolbox**.

The packager adds all project files to the toolbox and opens the Package a Toolbox dialog box.

- 2 The **Toolbox Information** fields are populated with the project name, author, and description. Edit the information if needed.
- 3 If you want to include files not already included in the project files, edit the excluded files and folders.
- 4 Click **Package**.

### Related Examples

- “Create and Share Toolboxes” (MATLAB)

### More About

- “Sharing Simulink Projects” on page 17-47

## Share Project on GitHub

To share your Simulink project, you can make your project publicly available on GitHub. First, create a login on GitHub.

You can share any project. Sharing adds Git source control to the open project. If your project is already under source control, sharing replaces the source control configuration with Git, and the project's remote repository is GitHub.

---

**Note:** If you do not want to change your current source control in the open project, share a copy of the project instead. To create a copy to share, see “Archive Projects in Zip Files” on page 17-53.

---

- 1 With a project loaded, on the **Simulink Project** tab, select **Share > Get More**.
- 2 Add the **GitHub** option to your **Share** menu. In the Manage Sharing dialog box, select **GitHub** and click **Close**.
- 3 Select **Share > GitHub**.
- 4 In the Create GitHub Repository dialog box, enter your GitHub user name and password, and edit the name for the new repository. Click **Create**.

A warning prompts you to confirm that you want to create a public repository and modify the current project's remote repository location. To continue, click **Yes**.

- 5 The Create GitHub Repository dialog box displays the URL address for your new repository. Click the link to view the new repository on the GitHub website. The repository contains the initial check-in of your project files.
- 6 The source control in your current project now references the new repository on GitHub as the remote repository. To use the project with the new repository, in the Create GitHub Repository dialog box, click **Reload Project**.

In the project, you can find the URL address for your remote repository at the top project node, under **Source Control**, in the **Repository location** field.

If you have not already set up Git, you need some additional setup steps before you can merge branches. You can use other Git functionality without any additional installation. See “Set Up Git Source Control” on page 19-20.

### **Related Examples**

- “Archive Projects in Zip Files” on page 17-53
- “Set Up Git Source Control” on page 19-20

### **More About**

- “Sharing Simulink Projects” on page 17-47

## Archive Projects in Zip Files

To package and share project files, you can export all project files to a zip file. For example, you can share a zipped project with people who do not have access to the connected source control tool.

- 1 With a project loaded, on the **Simulink Project** tab, select **Share > Zip Archive**.
- 2 Use the file browser to specify a file path in the **Zip file** field. By default, the file *myProjectName.zip* is created in the current working folder.
- 3 If you have referenced projects and want to export the referenced project files, then select the **Include referenced projects in archive** check box.
- 4 Click **Archive**.

If you want to exclude files from the archive, create an export profile to exclude files with particular labels.

- 1 Create labels and add them to the project files you want to exclude. See “Create Labels” on page 17-24.
- 2 Specify an export profile. On the **Simulink Project** tab, select **Share > Manage Export Profiles**.
  - a Click **+** and specify a name for the export profile.
  - b In the Files pane, click **+** and select the labels for the files you do not want to export, and click **OK**. You can also choose not to export custom labels.
  - c Click **Apply** and close the Manage Export Profiles dialog box.
- 3 When you share the project to an archive, in the **Export** list, select the name of your export profile to export only the specified files.

Before sharing projects with other users, it can be useful to examine the required toolboxes for your project. See “Find Required Toolboxes” on page 18-9.

### Related Examples

- “Create a New Project from an Archived Project” on page 16-22
- “Export a Subset of a Simulink Project Using an Export Profile”
- “Share Project by Email” on page 17-49

## **More About**

- “Sharing Simulink Projects” on page 17-47

## Upgrade All Project Models

---

**Tip:** Before upgrading, if you put your project under source control, you can easily revert changes later if you want. See “Add a Project to Source Control” on page 19-6.

---

Upgrade all models in your Simulink project to the latest release using a simple workflow. The Upgrade Project tool can apply all fixes automatically when possible, upgrade all model hierarchies in the project at once, and produce a report. You do not need to open the Upgrade Advisor.

- 1 On the Simulink Project tab, select **Run Checks > Upgrade**.

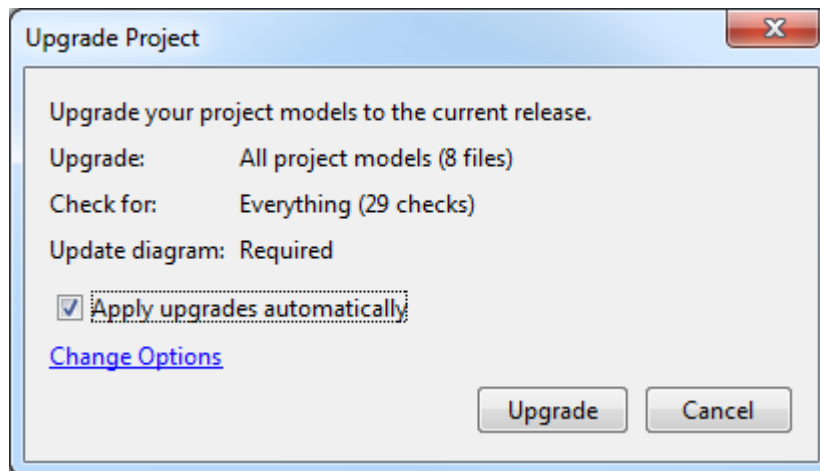

- 2 In the Upgrade Project dialog box, to upgrade all models, run all checks, and apply fixes automatically where possible, click **Upgrade**. If you want to change the settings, use these options before clicking **Upgrade**:
  - If you want to run upgrade checks but not apply fixes automatically where possible, clear the check box **Apply upgrades automatically**.
  - If you want to change which models to upgrade and which checks to run, click **Change Options**. In the Upgrade Options dialog box, clear check boxes for models and checks you want to exclude from the upgrade. For example, you might want to exclude checks that require an **Update Diagram**.

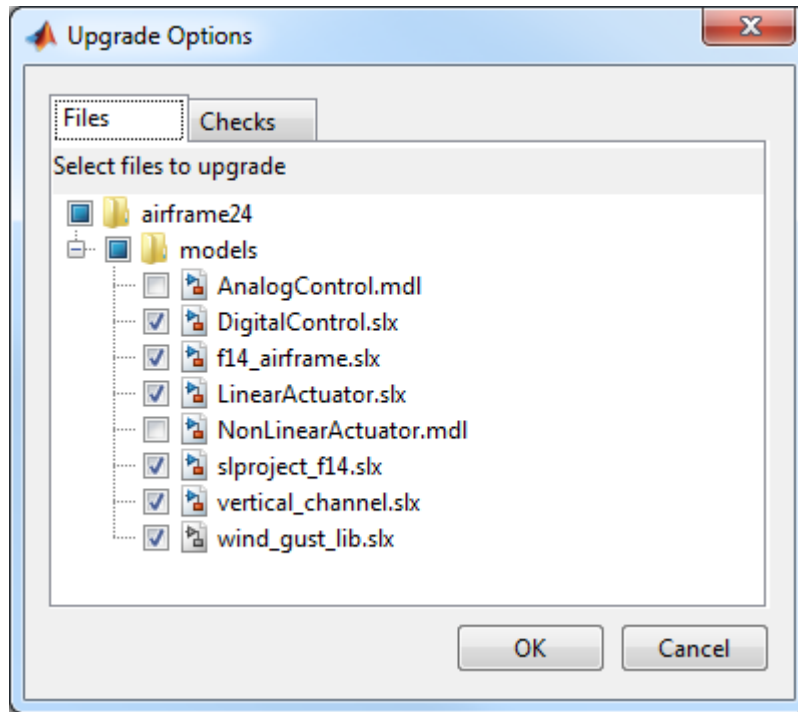

When you click **Upgrade**, the tool runs the checks and applies fixes if specified. Upgrading can take several minutes.

- 3 Examine the Upgrade Project Report. The summary at the top shows how many files passed and how many files require attention.



**Upgrade Project Report**

12% Passed

Passed 1 file  
Need attention 7 files

Show files: **Need Attention**

File	Status	Checks
vertical_channel.slx	Passed	25
<b>DigitalControl.slx</b>	Need attention	4
f14_airframe.slx	Passed	25
slproject_f14.slx	Passed	25
NonLinearActuator.mdl	Passed	25
AnalogControl.mdl	Passed	25
LinearActuator.slx	Passed	25

**DigitalControl.slx** (25 checks passed, 4 checks need attention)

Check Name	Result
Check model for block upgrade issues	Passed
<b>Check usage of function-call connections</b>	Need attention
Check for calls to slDataTypeAndScale()	Passed
Identify configurable subsystem blocks for converting to variant subsystem blocks	Passed
Check and update masked blocks in library to use promoted parameters	Passed
Check and update mask image display commands with unnecessary imread() function...	Passed
Check rapid accelerator signal logging	Passed
Check get_param calls for block CompiledSampleTime	Passed

**Check usage of function-call connections**

**Check 'Invalid function-call connection' setting**  
Verify that the **Invalid function-call connection** diagnostic is set to error.

Upgrade completed on 12/12/2016 14:53

Publish Report Finish

- Select files in the left list to view check results on the right. By default, the left list shows any files that need attention. Show instead all files, files that passed, or files that passed with fixes, by using the **Show files** control.
- Select checks in the right list to read details of results and any applied fixes in the lower pane.

- 4 To save a report of the upgrade results, click **Publish Report** and choose a file name and location.
- 5 To close the interactive report, click **Finish**.

### See Also

upgradeadvisor

### More About

- “What Are Simulink Projects?” on page 16-3
- “About Source Control with Projects” on page 19-2

# Simulink Project Dependency Analysis

---

- “What Is Dependency Analysis?” on page 18-2
- “Run Dependency Analysis” on page 18-4
- “Perform Impact Analysis” on page 18-7
- “Check Dependency Results and Resolve Problems” on page 18-17
- “Find Requirements Documents in a Project” on page 18-22
- “Save, Open, and Compare Dependency Analysis Results” on page 18-23
- “Analyze Model Dependencies” on page 18-25

## What Is Dependency Analysis?

### Project Dependency Analysis

In Simulink Project, you can analyze project structure and discover files required by your project in the Dependency Analysis view.

- To help you set up your project with all required files, you can use dependency analysis.

In a Simulink model, select **File > Simulink Project > Create Project from Model**.

Simulink runs dependency analysis on your model to identify required files and a project root location that contains all dependencies. See “Create a Project from a Model” on page 16-16.

Alternatively, you can manually add models to your project, analyze the model dependencies, and then add all dependent files to your project. See “Run Dependency Analysis” on page 18-4.

- You can use the Impact graph view of a dependency analysis to analyze the structure of a project visually. You can perform impact analysis to find the impact of changing particular files. In the graph, you can examine your project structure; find required toolboxes for the whole project or for selected files; open, edit, and run files; add labels and export files. See “Perform Impact Analysis” on page 18-7.

Impact analysis can show you how a change affects other files before you make the change. For example:

- Investigate the potential impact of a change in requirements by finding the design files linked to the requirements document.
- Investigate change set impact by finding upstream and downstream dependencies of modified files before committing the changes. Finding these dependencies can help you identify design and test files that need modification and help you find the tests you need to run.
- You can run dependency analysis at any point in your workflow when you want to check that the project has all required files. For example, check dependencies before submitting a version of your project to source control. To work with results, see “Check Dependency Results and Resolve Problems” on page 18-17.

- You can search for requirements documents in a project. See “Find Requirements Documents in a Project” on page 18-22.
- After performing dependency analysis, you can open or label the files, export the results as workspace variables, images, or reloadable files, or send files for custom task processing. Exporting the results enables further processing or archiving of impact analysis results. You can add the exported list of files to reports or artifacts that describe the impact of a change. See “Save, Open, and Compare Dependency Analysis Results” on page 18-23.

---

**Tip:** For an example showing how to perform file-level impact analysis to find and run the tests affected by modified files, see Perform Impact Analysis with a Simulink Project.

---

## Model Dependency Analysis

Simulink Project can analyze file dependencies for your entire project. For detailed dependency analysis of a *specific* model, use the manifest tools to control more options. Use the manifest tools if you want to:

- Analyze a model that is not in a project.
- Save the list of the model dependencies to a manifest file.
- Create a report to identify where dependencies arise.
- Control the scope of dependency analysis.

See “Analyze Model Dependencies” on page 18-25.

## Related Examples

- “Run Dependency Analysis” on page 18-4
- “Check Dependency Results and Resolve Problems” on page 18-17
- “Perform Impact Analysis” on page 18-7
- “Find Requirements Documents in a Project” on page 18-22
- “Analyze Model Dependencies” on page 18-25

## Run Dependency Analysis

---

**Note:** You can analyze only files that are in your Simulink project. If your project is new, add files to the project before running a dependency analysis. See “Add Files to the Project” on page 16-20.

---

- 1 In the Simulink Project tree, select **Dependency Analysis**.
- 2 If you want to analyze the dependencies of external toolboxes, select **Options > Analyze External Toolboxes**.

After you run the first dependency analysis of your project, subsequent analyses are incremental updates. However, if you update external toolboxes and want to discover dependency changes in them, you must perform a complete analysis. In this case, turn off **Options > Perform Incremental Updates** before running the dependency analysis.

- 3 To analyze all files in your project, on the **Dependency Analysis** tab or view, select **Analyze**.

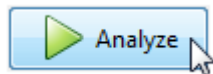

If you want to analyze specific files, on the **Dependency Analysis** tab, click **Analyze > Select Files to Analyze**. In the Dependency Analysis dialog box, select files for analysis, and click **Analyze**.

---

**Note:** In the Simulink Editor, if an open model, library, or chart belongs to a project, you can find file dependencies. Select **File > Simulink Project > Find Dependencies**. Simulink Project analyzes the whole project and shows upstream and downstream dependencies for the file.

---

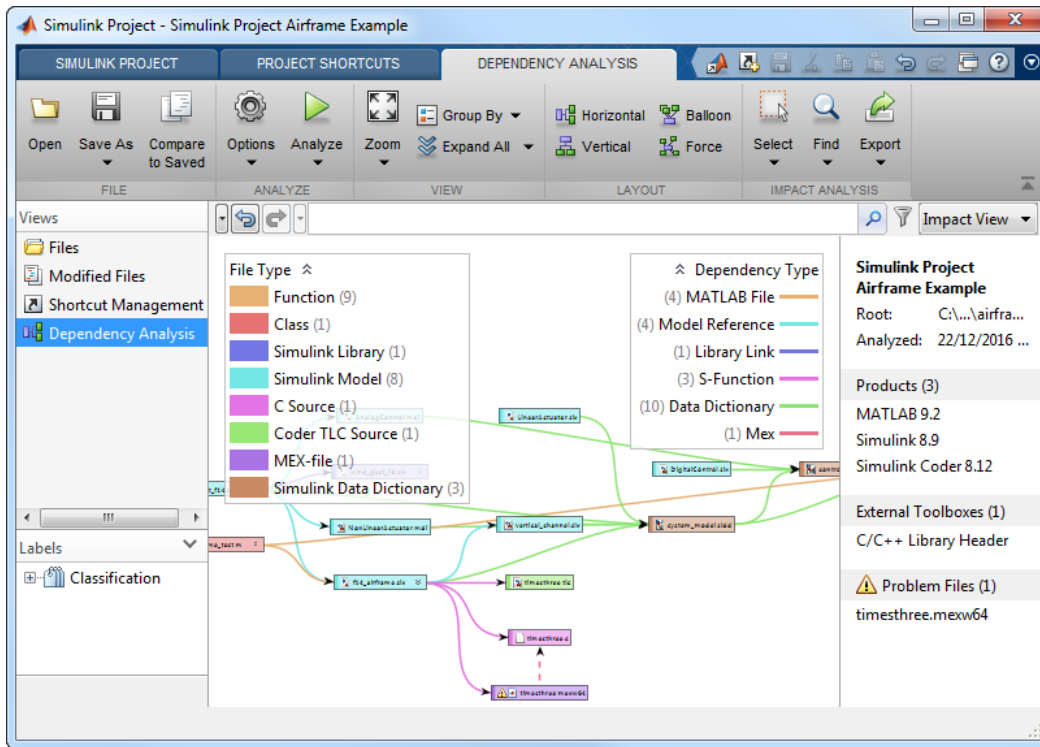

For next steps, see:

- “Find Required Toolboxes” on page 18-9
- “Find Dependencies of Selected Files” on page 18-12
- “Select, Edit, and Export File Dependencies” on page 18-13
- “Check Dependency Results and Resolve Problems” on page 18-17

**Tip:** To try a dependency analysis on example files, see Perform Impact Analysis with a Simulink Project.

## Related Examples

- “Check Dependency Results and Resolve Problems” on page 18-17
- “Perform Impact Analysis” on page 18-7

- “Save, Open, and Compare Dependency Analysis Results” on page 18-23
- “Find Requirements Documents in a Project” on page 18-22



# Perform Impact Analysis

**In this section...**

“About Impact Analysis” on page 18-7

“Run Dependency Analysis” on page 18-7

“Find Required Toolboxes” on page 18-9

“Find Dependencies of Selected Files” on page 18-12

“Select, Edit, and Export File Dependencies” on page 18-13

## About Impact Analysis

In Simulink Project, you can use impact analysis to find out the impact of changing particular files. Investigate dependencies visually and explore the structure of your project. Analyze selected or modified files to find their required files and the files they affect. Impact analysis can show you how a change affects other files before you make the change. For example, you can:

- Investigate the potential impact of a change in requirements by finding the design files linked to the requirements document.
- Investigate change set impact by finding upstream and downstream dependencies of modified files before committing the changes. Finding these dependencies can help you identify design and test files that need modification, and help you find the tests you need to run.

After performing dependency analysis, you can open or label the files, export the results as workspace variables, images, or reloadable files, or send files for custom task processing. Exporting the results enables further processing or archiving of impact analysis results. You can add the exported list of files to reports or artifacts that describe the impact of a change.

---

**Tip:** For an example showing how to perform file-level impact analysis to find and run the tests affected by modified files, see [Perform Impact Analysis with a Simulink Project](#).

---

## Run Dependency Analysis

To investigate dependencies, run a dependency analysis on your project.

- 1 In the Simulink Project tree, select **Dependency Analysis**. If you want to analyze the dependencies of external toolboxes, select **Options > Analyze External Toolboxes**.
- 2 Click **Analyze**.

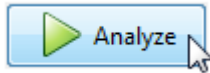

The **Impact View** graph displays the structure of all analyzed dependencies in the project. Project files that are not detectable dependencies of the analyzed files do not appear on the graph.

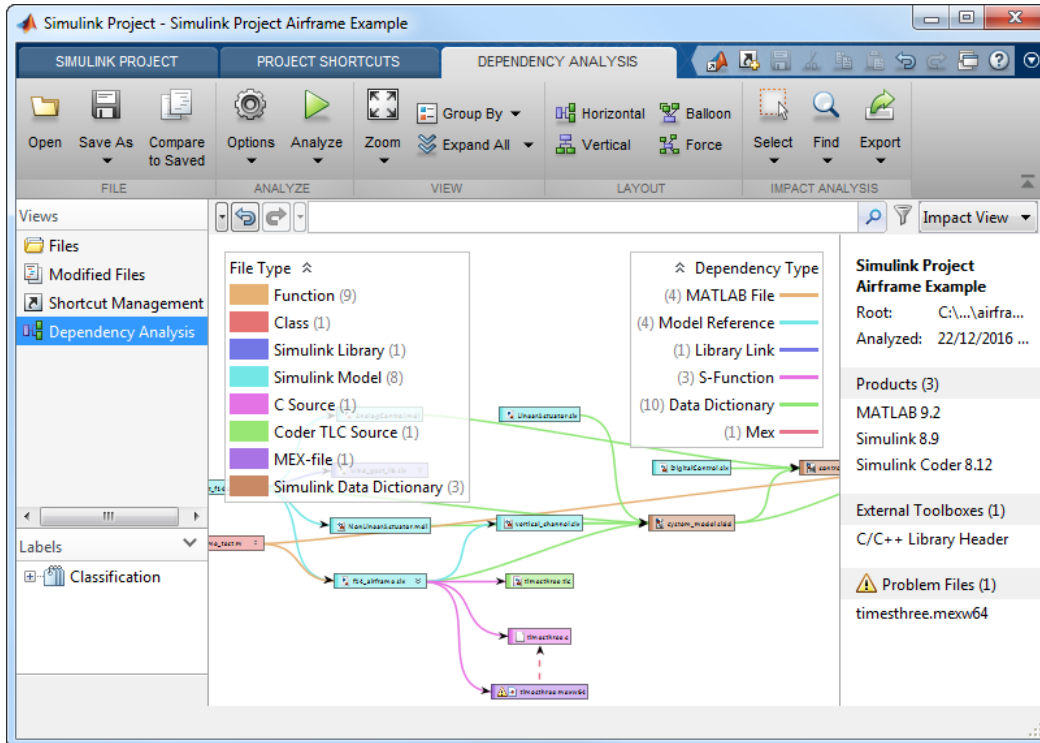

After you run the first dependency analysis of your project, clicking **Analyze** again produces incremental updates. If you want to analyze changes in external toolboxes, turn off the incremental update option.

After performing dependency analysis, the Impact view shows:

- A graph of your project structure and its file dependencies, showing how files such as models, libraries, functions, data files, and source and derived files relate to each other.
- Required products and toolboxes.
- Relationships between source and derived files (such as `.m` and `.p` files, `.slx` and `.slxp`, `.ssc` and `.sscp`, `.c` and `.mex` files), and between C/C++ source and header files.
- Warnings about problem files, such as missing files, files not in the project, unsaved changes, and out-of-date derived files.

For next steps:

- “Find Required Toolboxes” on page 18-9
- “Find Dependencies of Selected Files” on page 18-12
- “Select, Edit, and Export File Dependencies” on page 18-13
- “Check Dependency Results and Resolve Problems” on page 18-17

---

**Tip:** To try a dependency analysis on example files, see Perform Impact Analysis with a Simulink Project.

---

## Find Required Toolboxes

After running dependency analysis in a Simulink project, the Impact view shows the required toolboxes for the whole project or for selected files. You can see which products a new team member requires to use the project, or find which file is introducing a product dependency.

- 1 After running dependency analysis, view the required products for the whole project listed in the right pane.
- 2 To find which file is introducing a product dependency, hover over the product name and click **Find Usages**.

**Simulink Project Airframe Example**

Root: C:\slexamples\airframe8

Products (3)  
MATLAB 9.1  
Simulink 8.8  
Simulink Coder 8... Find Usages →  
External Toolboxes (1)  
C/C++ Library Header  
⚠ Problem Files (1)  
timesthree

The graph updates to show only the files using the selected product.

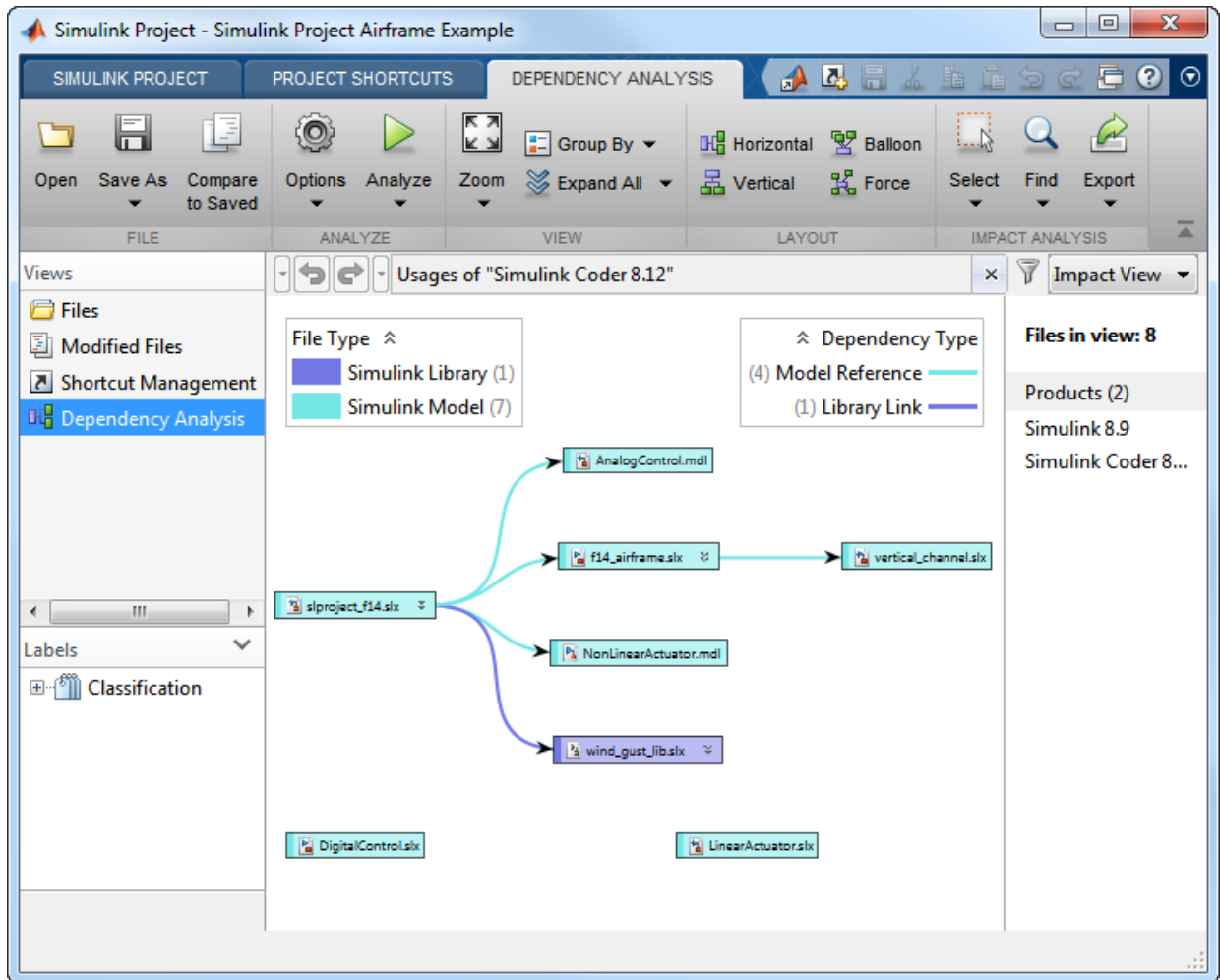

To return to the full project view, clear the filter in the search box (e.g., **Usages of “productname”**).

- 3 To view required products of selected files, select some files by clicking the graph or a legend.

If a required product is missing, the product list labels it **Missing**. See “Check Dependency Results and Resolve Problems” on page 18-17.

## Find Dependencies of Selected Files

After a dependency analysis, to find out the impact of particular files, in the **Impact View** use controls in the **View** and **Impact Analysis** sections of the **Dependency Analysis** tab.

- 1 Select files to investigate using one of these methods:
  - Select files in the graph or select groups of files by clicking the legend. For example, select all model files by clicking **Simulink Model** in the **File Type** legend. Change the legend, in the **View** section of the toolbar, using the **Group By** menu, for example to show problem types, status, or labels.
  - To select modified files, problem files or external files, use the **Select** menu in the **Impact Analysis** section of the toolbar.
- 2 In the **Impact Analysis** section, select **Find** and then specify the range of dependencies you want to display: **All Dependencies of Selection**, **Files Impacted by Selection**, or **Files Required by Selection**.

The graph shows the selected files and their file dependencies.

- 3 To see the blocks that have dependencies, expand individual files in the graph by clicking the arrows next to the file names.

The Impact graph expands the dependent file. You can see the subsystems that have dependencies. You can view dependent blocks, models, libraries, and library blocks.

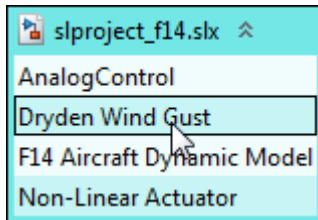

To highlight a dependent block in the model, double-click the block name in the expanded file.

To expand all files in the graph, in the **View** section, click **Expand All**.

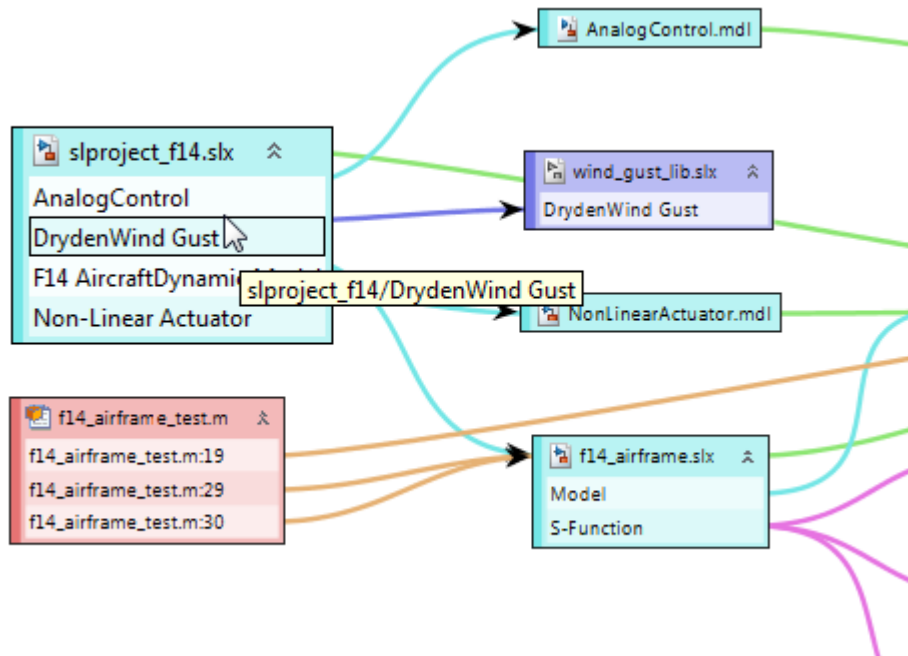

- To investigate changes in modified files, right-click and select **Compare to Ancestor** or **Compare to Revision**. See “Compare Revisions” on page 19-44.

---

**Tip:** To reset the graph to show all analyzed dependencies in the project, on the **Dependency Analysis** tab, in the **Impact Analysis** section, select **Find > All Files**.

---

## Select, Edit, and Export File Dependencies

To highlight or select groups of files:

- Click a legend item to select all files of that type. For example, to select all model files, in the **File Type** legend, click **Simulink Model**. Selected files display a blue box.
- To choose a legend, on the **Dependency Analysis** tab, in the **View** section, use the **Group By** control. Choose a category such as file type, project status, source control status, labels, project, and problem type. Files in the graph are colored to indicate the legend category on each file.

For example:

- If your project is under source control, to show modified files, select **Group By > SVN** (or **Git**).
- To identify whether files are in your project or a referenced project, select **Group By > Project**.

To perform file operations:

- Take actions to resolve problem files. For example, right-click a problem file and select **Add to Project** or **Add External File**. For advice on resolving problem files, see “Check Dependency Results and Resolve Problems” on page 18-17.

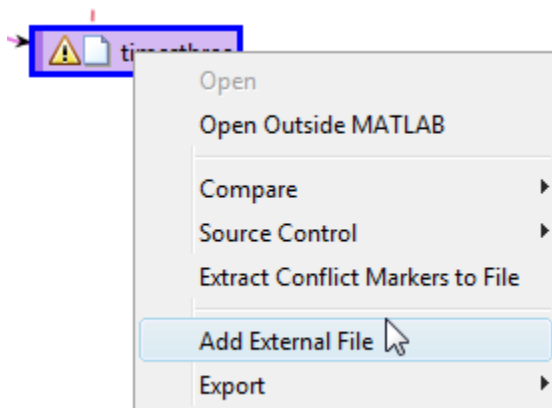

- Hover over a file to read the file name in the tooltip at any zoom level. Double-click to open the file. Expand or collapse files in the graph by clicking the arrows next to the file names. View dependent blocks under an expanded file, and double-click a dependent block to highlight it in the model.
- Right-click files in the graph to use commands such as **Open**, **Compare**, or **Source Control** operations.



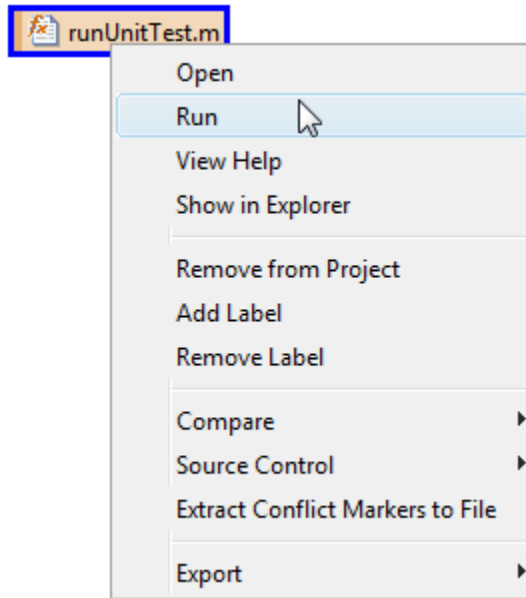

You can perform file operations on multiple files. To fit the view to the currently selected files, press **F**.

- Export selected files using the **Export** menu. You can switch to the files or custom task views with the files selected, or send the file paths to a workspace variable. You can also save and reload graph layouts, and save the graph as an image file, using **Save As**. Your graph layout is saved with the project. See “Save, Open, and Compare Dependency Analysis Results” on page 18-23.

Alternatively, you can work with the graph information programmatically. See “Automate Simulink Project Tasks Using Scripts” on page 17-28.

## Related Examples

- “Run Dependency Analysis” on page 18-4
- “Check Dependency Results and Resolve Problems” on page 18-17
- “Save, Open, and Compare Dependency Analysis Results” on page 18-23
- “Find Requirements Documents in a Project” on page 18-22
- “Automate Simulink Project Tasks Using Scripts” on page 17-28

- Perform Impact Analysis with a Simulink Project

## Check Dependency Results and Resolve Problems

In the Simulink Project tree, select **Dependency Analysis**. If you have not yet run an analysis, click **Analyze**. After you run a dependency analysis, you see the Impact graph for the whole project in **Impact View**. The project dependency analysis identifies problem files, such as missing files, files not in the project, unsaved changes, and out-of-date derived files. You can examine problem files and resolve issues using the **Impact View** or the **Table View**.

Problem Message	Description	Fix
Not in project	The file is not in the project.	<p>Add it to the project.</p> <p>You do not need to add all required files to the project. For example, you can exclude derived S-Function binary files that the source code in your project generates. See “Work with Derived Files in Projects” on page 19-69.</p> <p>To remove a file from the problem list without adding it to the project, right-click the file and select <b>Add External File</b>.</p>
Missing	The file is in the project but does not exist on disk.	Create the file, or recover it using source control.
Outside project root	The file is outside the project root folder.	<p>If this is OK, set the file as an external file. Otherwise move it under the project root.</p> <p>If you need a file that is outside the project root to be in your project, copy or move the file within the project root, and add it to the project and the path. Remove the original file location from the path.</p>

Problem Message	Description	Fix
		If required files are outside your project root, you cannot add these files to your project. This dependency might not indicate a problem if the file is on your path and is a utility or resource that is not part of your project. Use dependency analysis to ensure that you understand the design dependencies.
In unreferenced project	The file is within a project that is not referenced by the current project.	Add the project containing the file as a project reference.
Missing variable or file not on MATLAB path	The file or variable could not be found.	If this status is acceptable, set the file as an external file.
Unsaved changes	The file has unsaved changes in the MATLAB or Simulink editors	Save the file.
Derived file out of date	The derived file is older than the source file it was derived from.	<p>Regenerate the derived file. If it is a P-file, you can regenerate automatically by running the project checks.</p> <p>On the Simulink Project tab, click <b>Check Project</b> and follow prompts to rebuild files.</p> <p>If you rename a source file, the project detects impact in the derived file and prompts you to update it.</p>

Problem Message	Description	Fix
Missing product	The project has a dependency on a missing product.	<p>Fix models by installing missing products.</p> <p>If you open a model that contains built-in blocks or library links from missing products, you see labels and links to help you fix the problem.</p> <ul style="list-style-type: none"> <li>• Blocks are labeled with missing products (for example, <b>SimEvents not installed</b>)</li> <li>• Tooltips include the name of the missing product</li> <li>• Messages provide links to open Add-On Explorer and install the missing products</li> </ul> <p>To find a link to open Add-On Explorer and install the product:</p> <ul style="list-style-type: none"> <li>• For built-in blocks, open the Diagnostic Viewer, and click the link in the warning.</li> <li>• For unresolved library links, double-click the block to view details and click the link.</li> </ul> <p>Product dependencies can occur in many other ways, for example in callbacks, so in this case you cannot easily see where the missing product is referenced. Fix models by installing missing products.</p>

## Investigate Problem Files in Impact View

Use the **Impact View** to investigate your project dependencies graphically.

- 1 In the Impact view, to see problem files for the whole project, clear any file selections by clicking a blank area of the graph. View any problem files listed in the right panel.
- 2 To view the files that use a problem file, hover over the problem file and click **Find Dependencies**.

### Simulink Project Airframe Example

Root: C:\slexamples\airframe8

#### Products (3)

MATLAB 9.1

Simulink 8.8

Simulink Coder 8.11

#### External Toolboxes (1)

C/C++ Library Header

#### ⚠ Problem Files (1)

timesthree... Find Dependencies ➡

The graph updates to display only the problem file and its dependencies, and the problem message in the right panel.

- 3 Take actions to resolve the problem file. For example, right-click the file and select **Add to Project** or **Add External File**.
- 4 Click a problem file and check the path shown on the right. Check if required files are outside your project root.
- 5 Examine or edit dependencies by opening referencing components (such as a block or line of MATLAB code that references a problem file). To open a referencing component, expand a file in the graph, and double-click an item in the list.

MATLAB files open in the MATLAB Editor, and Simulink models open in the Simulink Editor with the referencing component block highlighted.

- 6 To return to the full project view, clear the filter in the search box (e.g., **Dependencies of “filename”**).

For more ways to work with the Impact view, see “Perform Impact Analysis” on page 18-7.

## Investigate Problem Files in Table View

- 1 Select **Table View** and sort by the Problem Description column.
- 2 Click each file in the problem list.

The lower pane, under **Upstream Dependencies: filename**, displays the files that use the selected file.

Check the message in the **Problem Description** column.

- 3 In the dependencies table, check the problem description and project status of dependent files.
- 4 To open the referencing component for editing, right-click a file **Upstream Dependencies: filename** table and select **Open**.
- 5 Check the path, where \$ indicates the project root. Check if required files are outside your project root.
- 6 To remove a file from the problem list without adding it to the project, right-click the file and select **Add External File**. The file disappears from the problem list. The next time you run a dependency analysis, this file does not appear in the problem list.
- 7 Clear the search box to view all identified dependencies, not just problem files.

## Related Examples

- “Run Dependency Analysis” on page 18-4
- “Perform Impact Analysis” on page 18-7
- “Save, Open, and Compare Dependency Analysis Results” on page 18-23

## Find Requirements Documents in a Project

In Simulink Project, a dependency analysis finds requirements documents linked using the Requirements Management Interface.

- You can view and navigate to and from the linked requirements documents.
- You can create or edit Requirements Management links only if you have Simulink Verification and Validation.

- 1 From the Simulink Project tree, select **Dependency Analysis**.
- 2 Click the **Analyze** button.

The Impact graph displays the structure of all analyzed dependencies in the project. Project files that are not detectable dependencies of the analyzed files are not visible in the graph.

- 3 To highlight requirements documents in the graph, in the Dependency Type legend, click **Requirements Link**. Arrows connect requirements documents to the files with the requirement links.
- 4 To find the specific block containing a requirement link, expand the model file in the graph. Click **Expand All** or click the arrows next to the file name. View the arrow connecting the block containing the requirement link to the requirements document file.
- 5 To open a requirements document, double-click the document in the graph.

### Related Examples

- “Run Dependency Analysis” on page 18-4
- “Check Dependency Results and Resolve Problems” on page 18-17
- “Perform Impact Analysis” on page 18-7
- “Save, Open, and Compare Dependency Analysis Results” on page 18-23
- “View Linked Requirements in Models and Blocks” on page 12-61



## Save, Open, and Compare Dependency Analysis Results

In Simulink Project, you can save the results of a dependency analysis. You can view the saved results later, without having to repeat the analysis. You can also save results separately in named files and reload them.

Save, open, and compare dependency analysis results from the **File** section of the **Dependency Analysis** tab.

- To save your results as a `.graphml` file, click **Save As** and choose a file name and location.
- To open saved dependency analysis results, click **Open**.
- To compare results with previously saved results, click **Compare to Saved**. Select a `.graphml` file. Inspect the differences in the comparison report.

You can save reports that include more detailed results by using model dependency analysis. For more information about choosing model or project dependency analysis, see “What Is Dependency Analysis?” on page 18-2.

### Export Impact Graph Results to Files or Images

To export impact analysis results, on the **Dependency Analysis** tab, in the **Impact Analysis** section, use the **Export** controls, or use the **Export** context menu on selected files.

#### Select Files to Export

To export all the files in the current view, check that no files are selected. (Click the graph background to clear the selection on all files.) Click **Export** to display **Files in view: *number of files***.

Select a subset of files in the graph to export. Click **Export** to see how many files are selected: **Selected files: *number of files***.

#### Export Files

- To save the selected file paths to a variable, select **Export > Save to Workspace**.
- To open the Custom Task dialog box with the files selected, select **Export > Send to Custom Task**.

- To switch to the Files view with the files selected, select **Export > Show in Files View**.

### **Export Graph to Image File**

To export the Impact graph as an image file for sharing or archiving, you can either:

- Save an image file. On the **Dependency Analysis** tab, in the **File** section, select **Save As > Save As Image**. Use the Save dialog box to specify the name, file type, and location. The default file type is SVG, which supports image scaling.
- Copy the image to the clipboard using the keyboard. You can paste the clipboard contents into other documents.

### **Export Reloadable Results**

To export the impact results to a `.graphml` file that you can reload in Simulink Project, click **Save As** and choose a file name and location..

### **Related Examples**

- “What Is Dependency Analysis?” on page 18-2
- “Perform Impact Analysis” on page 18-7

## Analyze Model Dependencies

### In this section...

“What Are Model Dependencies?” on page 18-25

“Generate Manifests” on page 18-26

“Command-Line Dependency Analysis” on page 18-31

“Edit Manifests” on page 18-34

“Compare Manifests” on page 18-37

“Export Files in a Manifest” on page 18-38

“Scope of Dependency Analysis” on page 18-40

“Best Practices for Dependency Analysis” on page 18-43

“Use the Model Manifest Report” on page 18-44

## What Are Model Dependencies?

Each Simulink model requires a set of files to run successfully. These files can include referenced models, data files, S-functions, and other files the model cannot run without. These required files are called *model dependencies*.

Dependency Analysis Requirements	Tools to Choose
Find required files for an entire project.	Use dependency analysis from the Simulink Project. See “Dependency Analysis”.
Perform dependency analysis of a specific model with control of more options.	Use the manifest tools from your model. See “Generate Manifests” on page 18-26.  Generate a manifest if you want to: <ul style="list-style-type: none"> <li>• Analyze a model that is not in a project.</li> <li>• Save the list of the model dependencies to a manifest file.</li> <li>• Create a report to identify where dependencies arise.</li> </ul>

Dependency Analysis Requirements	Tools to Choose
	<ul style="list-style-type: none"> <li>Control the scope of dependency analysis.</li> </ul>

After you generate a manifest for a model to determine its dependencies, you can:

- View the files required by your model in a manifest file.
- Trace dependencies using the report to understand why a particular file or toolbox is required by a model.
- Package the model with its required files into a zip file to send to another Simulink user.
- Compare older and newer manifests for the same model.
- Save a specific version of the model and its required files in a revision control system.

You can also view the libraries and models referenced by your model in a graphical format using the Model Dependency Viewer. See “Model Dependency Viewer” on page 12-56.

## Generate Manifests

Generating a manifest performs the dependency analysis and saves the list of model dependencies to a manifest file. You must generate the manifest before using any of the other Simulink Manifest Tools.

---

**Note:** The model dependencies identified in a manifest depend upon the **Analysis Scope** options you specify. For example, performing an analysis without selecting **Find Library Links** might not find all the Simulink blocksets that your model requires, because they are often included in a model as library links. See “Manifest Analysis Scope Options” on page 18-29.

---

To generate a manifest:

- 1 Select **Analysis > Model Dependencies > Generate Manifest**.

The Generate Model Manifest dialog box appears.

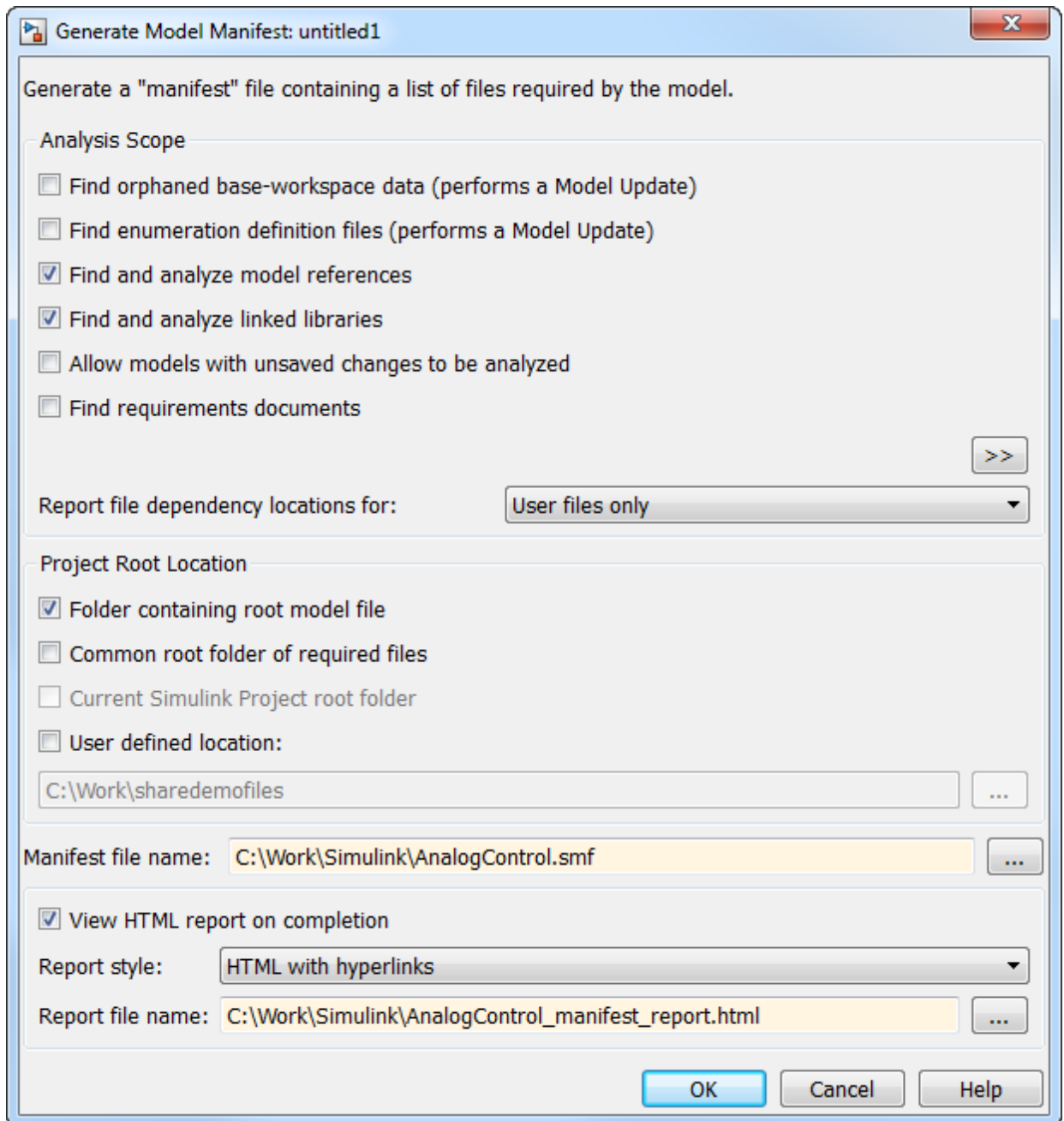

- 2 Click **OK** to generate a manifest and report using the default settings.

Alternatively you can first change the following settings:

- Select the **Analysis scope** check boxes to specify the type of dependencies you want to detect (see “Manifest Analysis Scope Options” on page 18-29).
- Control whether to report file dependency locations by selecting **Report file dependency locations for:**
  - **User files only** (default) — only report locations where dependencies are upon user files. Use this option if you want to understand the interdependencies of your own code and do not care about the locations of dependencies on MathWorks products. This option speeds up report creation and streamlines the report.
  - **All files** — report all locations where dependencies are introduced, including all dependencies on MathWorks products. This is the slowest option and the most verbose report. Use this option if you need to trace all dependencies to understand why a particular file or toolbox is required by a model. If you need to analyze many references, it can be helpful to sort the results by clicking the report column headers.
  - **None** — do not report any dependency locations. This is the fastest option and the most streamlined report. Use this option if you want to discover and package required files and do not require all the information about file references.
- If desired, change the **Project Root Location**. If the model is in a project, you can select **Current Simulink Project root folder**. Other check box options are: **Folder containing root model file** (the default), **Common root folder of required files**, or **User-defined location** — for this option, enter a path in the edit box, or browse to a location.
- If desired, edit the **Manifest file name** and location in which to save the file.
- Use the check box **View HTML report on completion** to specify if you want to generate a report when you generate the manifest. You can edit the **Report file name** or leave the default, *mymodelname\_manifest\_report.html*. You can set the **Report style** to Plain HTML or HTML with Hyperlinks.

When you click **OK** Simulink generates a manifest file containing a list of the model dependencies. If you selected **View HTML report on completion**, the Model Manifest Report appears after Simulink generates the manifest. See “Use the Model Manifest Report” on page 18-44 for an example.

The manifest is an XML file with the extension `.smf` located (by default) in the same folder as the model itself.

### Manifest Analysis Scope Options

The Simulink Manifest Tools allow you to specify the scope of analysis when generating the manifest. The dependencies identified by the analysis depend upon the scope you specify.

---

**Tip:** You can select analysis options that perform a Model Update. If Model Update fails you see an error message. Either clear those analysis options to generate a manifest without a Model Update, or try a manual Model Update to find out more about the problem. For example your model might require variables that are not present in the workspace (for example, if a block parameter defines a variable that you forgot to load manually).

---

The following table describes the Analysis Scope options.

Check Box Option	Description
<b>Find orphaned base workspace data (performs a Model Update)</b>	Searches for base workspace variables the model requires, that are not defined in any file in this Manifest.
<b>Find enumeration definition files (performs a Model Update)</b>	Searches for enumeration definition files. Turn on this option to detect enumerated datatypes used as part of a bus object definition.
<b>Find and analyze model references</b>	Searches for Model blocks in the model, and identifies any referenced models as dependencies.
<b>Find and analyze linked libraries</b>	Searches for links to library blocks in the model, and identifies any library links as dependencies.
<b>Allow models with unsaved changes to be analyzed</b>	Select this check box only if you want to allow analysis of unsaved changes.
<b>Find requirements documents</b>	Searches for requirements documents linked using the Requirements Management Interface. Note that requirements links created with IBM Rational DOORS software are not included in manifests. For more information, see “Find Requirements Documents in a Project” on page

Check Box Option	Description
	18-22 and “Requirements Management Interface Setup” (Simulink Verification and Validation) in the Simulink Verification and Validation documentation.
Click the >> button on the right to show the following advanced analysis options.	
<b>Find S-functions</b>	Searches for S-Function blocks in the model, and identifies S-function files (MATLAB code and C) as dependencies. See the source code item in “Special Cases” on page 18-42.
<b>Analyze model and block callbacks (including Interpreted MATLAB Function blocks)</b>	Searches for file dependencies introduced by the code in Interpreted MATLAB Function blocks, block callbacks, and model callbacks. For more detail on how callbacks are analyzed, see “Code Analysis” on page 18-41.
<b>Find files required for code generation</b>	Searches for file dependencies introduced by Simulink Coder custom code, and Embedded Coder templates. If you do not have a code generation product, this check is off by default, and produces a warning if you select it. This includes analysis of all configuration sets (not just the Active set) and <i>STF_make_rtw_hook</i> functions, and locates system target files and Code Replacement Library definition files (.m or .mat). See also “Required Toolboxes” on page 18-45, and the source code item in “Special Cases” on page 18-42.
<b>Find data files (e.g. in “From File” blocks)</b>	Searches for explicitly referenced data files, such as those in From File blocks, and identifies those files as dependencies. See “Special Cases” on page 18-42.
<b>Analyze Stateflow charts</b>	Searches for file dependencies introduced by using syntax such as <code>ml.mymean(myvariable)</code> in models that use Stateflow.



Check Box Option	Description
Analyze code in MATLAB Functions blocks	Searches for MATLAB Function blocks in the model, and identifies any file dependencies (outside toolboxes) introduced in the code. Toolbox dependencies introduced by a MATLAB Function block are not detected.
Analyze files in “user toolboxes”	Searches for file dependencies introduced by files in user-defined toolboxes. See “Special Cases” on page 18-42.
Analyze MATLAB files	Searches for file dependencies introduced by MATLAB files called from the model. For example, if this option is selected and you have a callback to <code>mycallback.m</code> , then the referenced file <code>mycallback.m</code> is also analyzed for further dependencies. See “Code Analysis” on page 18-41.
Store MATLAB code analysis warnings in manifest	Saves any warnings in the manifest.

See also “Scope of Dependency Analysis” on page 18-40 for more information.

## Command-Line Dependency Analysis

- “Check File Dependencies” on page 18-31
- “Check Toolbox Dependencies” on page 18-32

### Check File Dependencies

To programmatically check for file dependencies, use the function `dependencies.fileDependencyAnalysis` as follows.

```
[files, missing, depfile, manifestfile] =
dependencies.fileDependencyAnalysis('modelName', 'manifestfile')
```

This returns the following:

- *files* — a cell array of character vectors containing the full-paths of all existing files referenced by the model *modelName*.
- *missing* — a cell array of character vectors containing the names all files that are referenced by the model *modelName*, but cannot be found.

- *depfile* — returns the full path of the user dependencies (.smd) file, if it exists, that stores the names of any files you manually added or excluded. Simulink uses the .smd file to remember your changes the next time you generate a manifest. See “Edit Manifests” on page 18-34.
- *manifestfile* — (optional input) specify the name of the manifest file to create. The suffix .smf is always added to the user-specified name.

If you specify the optional input, *manifestfile*, then the command creates a manifest file with the specified name and path *manifestfile*. *manifestfile* can be a full-path or just a file name (in which case the file is created in the current folder).

If you try this analysis on an example model, it returns an empty list of required files because the standard MathWorks installation includes all the files required for the example models.

### Check Toolbox Dependencies

To check which toolboxes are required, use the function `dependencies.toolboxDependencyAnalysis` as follows:

```
[names,dirs] = dependencies.toolboxDependencyAnalysis(files_in)
```

*files\_in* must be a cell array of character vectors containing .m or model files on the MATLAB path. Simulink model names (without file extension) are also allowed.

This returns the following:

- *names* — a cell-array of toolbox names required by the files in *files\_in*.
- *dirs* — a cell-array of the toolbox folders.

---

**Note:** The method `toolboxDependencyAnalysis` looks for toolbox dependencies of the files in *files\_in* but does *not* analyze any subsequent dependencies.

---

If you want to find all detectable toolbox dependencies of your model *and* the files it depends on:

- 1 Call `fileDependencyAnalysis` on your model.

For example:

```
[files, missing, depfile, manifestfile] = dependencies.fileDependencyAnalysis('mymodel')

files =
    'C:\Work\manifest\foo.m'
    'C:\Work\manifest\mymodel'
missing =
    []
depfile =
    []
manifestfile =
    []
```

- 2 Call `toolboxDependencyAnalysis` on the `files` output of step 1.

For example:

```
tbxes = dependencies.toolboxDependencyAnalysis(files)

tbxes =
[1x24 char]    'MATLAB'    'Simulink Coder'    'Simulink'
```

To view long product names examine the `tbxes` cell array as follows:

```
tbxes{:}

ans =
Image Processing Toolbox

ans =
MATLAB

ans =
Simulink Coder

ans =

Simulink
```

For command-line dependency analysis, the analysis uses the default settings for analysis scope to determine required toolboxes. For example, if you have code generation products, then the check **Find files required for code generation** is on by default and Simulink Coder is always reported as required. See “Required Toolboxes” on page 18-45 for more examples of how your installed products and analysis scope settings can affect reported toolbox requirements.

## Edit Manifests

After you generate a manifest, you can view the list of files identified as dependencies, and manually add or delete files from the list.

To edit the list of required files in a manifest:

- 1 Select **Analysis > Model Dependencies > Edit Manifest Contents**.

Alternatively, if you are viewing a manifest report you can click **Edit** in the top **Actions** box, or you can click **View and Edit Manifest** in the Export Manifest dialog box.

The View and Edit Manifest dialog box appears, showing the latest manifest for the current model.

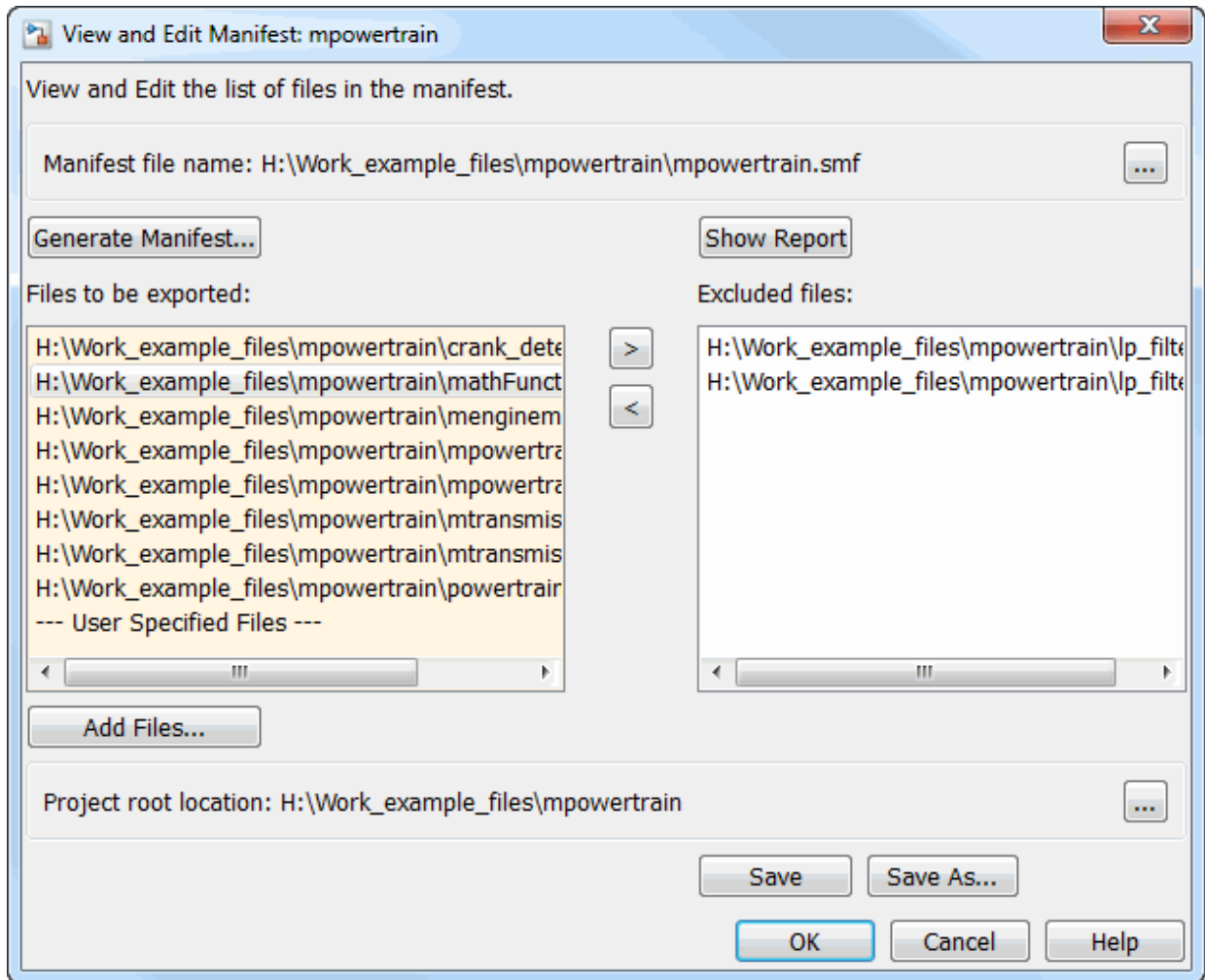

**Note:** You can open a different manifest by clicking the Browse for manifest file

button . If you have not generated a manifest, select **Generate Manifest** to open the Generate Model Manifest dialog box (see “Generate Manifests” on page 18-26).

- 2 Examine the **Files to be exported** list on the left side of the dialog box. This list shows the files identified as dependencies.
- 3 To add a file to the manifest:

- a Click **Add Files**.

The Add Files to Manifest dialog box opens.

- b Select the file you want to add, then click **Open**.

The selected file is added to the **Files to be exported** list.

- 4 To remove a file from the manifest:

- a Select the file you want to remove from the **Files to be exported** list.

- b Click the Exclude selected files button .

The selected file is moved to the **Excluded files** list.

---

**Note:** If you add a file to the manifest and then exclude it, that file is removed from the dialog box (it is not added to the **Excluded files** list). Only files detected by the Simulink Manifest Tools are included in the Excluded files list.

---

- 5 If desired, change the **Project Root Location**.
- 6 Click **Save** to save your changes to the manifest file.

Simulink saves the manifest (.smf) file, and creates a user dependencies (.smd) file that stores the names of any files you manually added or excluded. Simulink uses the .smd file to remember your changes the next time you generate a manifest, so you do not need to repeat manual editing. For example, you might want to exclude source code or include a copyright document every time you generate a manifest for exporting to a customer. The user dependencies (.smd) file has the same name and folder as the model. By default, the user dependencies (.smd) file is also included in the manifest.

---

**Note:** If the user dependencies (.smd) file is read-only, a warning is displayed when you save the manifest.

---

- 7 To view the Model Manifest Report for the updated manifest, click **Show Report**.

An updated Model Manifest Report appears, listing the required files and toolboxes, and details of references to other files. See “Use the Model Manifest Report” on page 18-44 for an example.

- 8 When you are finished editing the manifest, click **OK**.

## Compare Manifests

You can compare two manifests to see how the list of model dependencies differs between two models, or between two versions of the same model. You can also compare a manifest with a folder or a ZIP file.

To compare manifests:

- 1 From the Current Folder browser, right-click a manifest file and select **Compare Against > Choose**.

Alternatively, from your model, select **Analysis > Model Dependencies > Compare Manifests**.

The dialog box Select Files or Folders for Comparison appears.

- 2 In the dialog box Select Files or Folders for Comparison, select files to compare, and the comparison type.
  - a Use the drop-down lists or browse to select manifest files to compare.
  - b Select the **Comparison type**. For two manifests you can select:
    - **Simulink manifest comparison** — Select for a manifest file list comparison reporting new, removed, and changed files. The report contains links to open files and compare files that differ. You can use a similar file **List comparison** for comparing a manifest to a folder or a ZIP file.
    - **Simulink manifest comparison (printable)** — Select for a printable Model Manifest Differences Report without links. The report provides details about each manifest file, and lists the differences between the files.
- 3 View the report in the Comparison Tool comparing the file names, dates, and sizes stored in the manifests.

Be aware the details stored in the manifest might differ from the files on disc. If you click a “compare” link in the report, you see warnings if there are problems such as size mismatches, or if the tool cannot find those files on disc.

For more information on the Comparison Tool, see “Comparing Files and Folders” (MATLAB) in the MATLAB Data and File Management documentation.

## **Export Files in a Manifest**

You can export copies of the files listed in the manifest to a ZIP file. Exporting the files allows you to package the model with its required files into a single ZIP file, so you can easily send it to another user or save it in a revision control system.

To export your model with its required files:

- 1** Select **Analysis > Model Dependencies > Export Files in Manifest**.

Alternatively, if you are viewing a manifest report you can click **Export** in the top **Actions** box.

The Export Files in Manifest dialog box appears, showing the latest manifest for the current model.



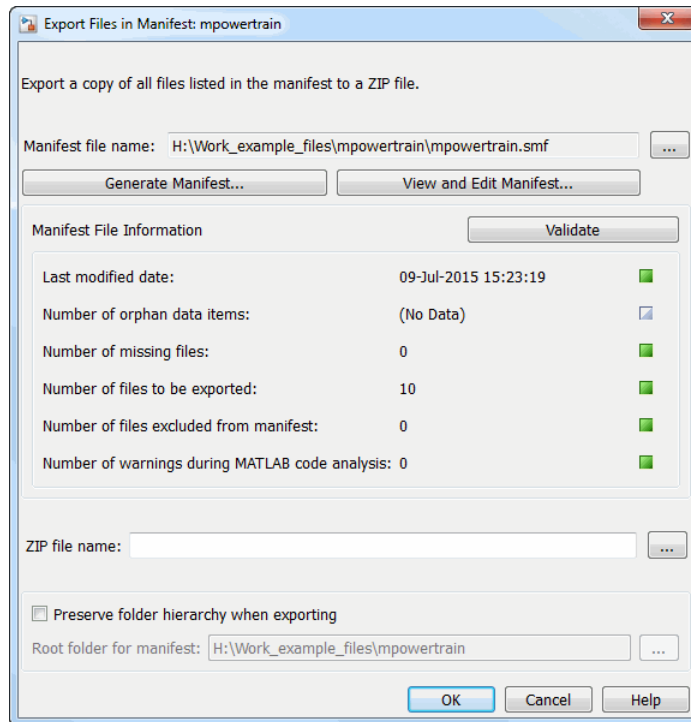

**Note:** You can export a different manifest by clicking the Browse for manifest file button . If you have not generated a manifest, select **Generate Manifest** to open the Generate Model Manifest dialog box (see “Generate Manifests” on page 18-26).

- 2 If you want to view or edit the manifest before exporting it, click **View and Edit Manifest** to view or change the list of required files. See “Edit Manifests” on page 18-34. When you close the View and Edit Manifest dialog box, you return to the Export Files in Manifest dialog box.
- 3 Click **Validate** to check the manifest. Validation reports information about possible problems such as missing files, warnings, and orphaned base workspace data.
- 4 Enter the ZIP file name to which you want to export the model.

- 5 Select **Preserve folder hierarchy when exporting** if you want to keep folder structure for your exported model and files. Then, select the root folder to use for this structure (usually the same as the **Project Root Location** on the Generate Manifest dialog box).

---

**Note:** You must select **Preserve folder hierarchy** if you are exporting a model that uses an `.m` file inside a MATLAB class (to maintain the folder structure of the class), or if the model refers to files in other folders (to ensure the exported files maintain the same relative paths).

---

- 6 Click **OK**.

The model and its file dependencies are exported to the specified ZIP file.

## Scope of Dependency Analysis

The Simulink Manifest Tools identify required files and list them in an XML file called a *manifest*. When Simulink generates a manifest file, it performs a static analysis on your model, which means that the model does not need to be capable of performing an “update diagram” operation (see “Update Diagram and Run Simulation” on page 1-65). The only exception to this is when you select the analysis option **Find orphaned base workspace data (performs a Model Update)**.

You can specify the type of dependencies you want to detect when you generate the manifest. See “Manifest Analysis Scope Options” on page 18-29.

For more information on what the tool analyzes, refer to the following sections:

- “Analysis Limitations” on page 18-40
- “Code Analysis” on page 18-41
- “Special Cases” on page 18-42

### Analysis Limitations

The analysis might not find all files required by your model (for examples, see “Code Analysis” on page 18-41).

The analysis might not report certain blocksets or toolboxes required by a model. You should be aware of this limitation when sending a model to another user. Blocksets that do not introduce dependence on any files (such as Fixed-Point Designer™) cannot

be detected. Some SimEvents blocks do not introduce a detectable dependence on SimEvents.

To include dependencies that the analysis cannot detect, you can add additional file dependencies to a manifest file using the View/Edit Manifest Contents option (see “Edit Manifests” on page 18-34).

## Code Analysis

When the Simulink dependency analysis encounters MATLAB code, for example in a model or block callback, or in a `.m` file S-function, the analysis attempts to identify the files it references. If those files contain MATLAB code, *and* the analysis scope option **Analyze MATLAB files** is selected, the referenced files are also analyzed. This function is similar to `matlab.codetools.requiredFilesAndProducts` but with some enhancements:

- Character vectors passed into calls to `eval`, `evalc`, and `evalin` are analyzed.
- File names passed to `load`, `fopen`, `xlsread`, `importdata`, `dlmread`, and `imread` are identified.

Files that are in MathWorks toolboxes are not analyzed.

File names passed to `load`, etc., are identified only if they are literal character vectors, for example:

```
load('mydatafile')
load mydatafile
```

If you define a file name as a variable and pass that to a function, the file is a hidden dependency. The following example, and anything more complicated, does not identify the dependency because the file name is inside a variable:

```
str = 'mydatafile';
load(str);
```

Similarly, arguments to `eval`, etc., are analyzed only if they are literal character vectors.

The Simulink dependency analysis looks inside MAT-files to find the names of variables to be loaded. This enables them to distinguish reliably between variable names and function names in block callbacks.

If a model depends upon a file for which both `.m` and `.p` files exist, then the manifest reports both, and, if the **Analyze MATLAB files** option is selected, the `.m` file is analyzed.

## Special Cases

The following list contains more information about specific cases:

- If your model references a data class created using MATLAB syntax, for example called *MyPackage.MyClass*, all files inside the folder *MyPackage* and its subfolders are added to the manifest.

---

**Warning:** The analysis adds all files in the class, which includes any source control files such as `.svn` or `.cvs`. You might want to edit the manifest to remove these files.

---

- A user-defined toolbox must have a properly configured `Contents.m` file. The Simulink Manifest Tools search user-defined toolboxes as follows:
  - If you have a `Contents.m` file in folder X, any file inside a subfolder of X is considered part of your toolbox.
  - If you have a `Contents.m` file in folder X/X, any file inside all subfolders of the “outer” folder X is considered part of your toolbox.

For more information on the format of a `Contents.m` file, see `ver`.

- If your S-functions require TLC files, these are detected.
- If you have Simscape, your Simscape components are analyzed. See also “Required Toolboxes” on page 18-45 for other effects of your installed products on manifests.
- If you create a UI using GUIDE and add this to a model callback, then the dependency analysis detects the `.m` and `.fig` file dependencies.
- If you have a dependence on source code, such as `.c`, `.h` files, these files are not analyzed at all to find any files that they depend upon. For example, subsequent `#include` calls inside `.h` files are not detected. To make such files detectable, you can add them as dependent files to the “header file” section of the Custom Code pane of the Simulink Coder section of the Configuration Parameters dialog box (or specify them with `rtwmakecfg`). Alternatively, to include dependencies that the analysis cannot detect, you can add additional file dependencies to a manifest file using the View/Edit Manifest Contents option (see “Edit Manifests” on page 18-34).
- Various blocksets and toolboxes can introduce a dependence on a file through their additional source blocks. If the analysis scope option **Find data files (e.g. in “From File” blocks)** is selected, the analysis detects file dependencies introduced by the following blocks:

Product	Blocks
DSP System Toolbox	From Wave File (Obsolete) block (Microsoft Windows operating system only)  From Multimedia File block (Windows only)
Computer Vision System Toolbox™	Image From File block  Read Binary File block
Simulink 3D Animation™	VR Sink block

The option **Find data files** also detects dependencies introduced by setting a "Model Workspace" for a model to either **MAT-File** or **MATLAB Code**, and model dependencies specified on the Model Referencing pane of the Configuration Parameters dialog box.

## Best Practices for Dependency Analysis

The starting point for dependency analysis is the model itself. Make sure that the model refers to any data files it needs, even if you would normally load these manually. For example, add code to the model's `PreLoadFcn` to load them automatically, like this example:

```
load mydatafile
load('my_other_data_file.mat')
```

This way, the Simulink Manifest Tools can add them to the manifest. For more detail on callback analysis, see the notes on code analysis (see "Code Analysis" on page 18-41).

More generally, ensure that the model creates or loads any variables it uses, either in model callbacks or in scripts called from model callbacks. This reduces the possibility of the Simulink Manifest Tools confusing variable names with function names when analyzing block callbacks.

If you plan to export the manifest after creating it, ensure that the model does not refer to any files by their absolute paths, for example:

```
load C:\mymodel\mydata\mydatafile.mat
```

Absolute paths can become invalid when you export the model to another machine. If referring to files in other folders, do it by relative path, for example:

```
load mydata\mydatafile.mat
```

Select **Preserve folder hierarchy** when exporting, so that the exported files are in the same locations relative to each other. Also, choose a root folder so that all the files listed in the manifest are inside it. Otherwise, any files outside the root are copied into a new folder called `external` underneath the root, and relative paths to those files become invalid.

If you are exporting a model that uses a `.m` file inside a MATLAB class (in a folder called `@myclass`, for example), you must select the **Preserve folder hierarchy** check box when exporting, to maintain the folder structure of the class.

Always test exported ZIP files by extracting the contents to a new location on your computer and testing the model. Be aware that in some cases required files might be on your path but not in the ZIP file, if your path contains references to folders other than MathWorks toolboxes.

## Use the Model Manifest Report

- “Report Sections” on page 18-44
- “Required Toolboxes” on page 18-45
- “Example Model Manifest Report” on page 18-46

### Report Sections

If you selected **View HTML report on completion** in the Generate Model Manifest dialog box, the Model Manifest Report appears after Simulink generates the manifest. The report shows:

- Analysis date
- **Actions** pane — Provides links to regenerate, edit, or compare the manifest, and export the files in the manifest to a ZIP file.
- **Model Reference and Library Link Hierarchy** — Links you can click to open models.
- **Files used by this model** — Required files, with paths relative to the `projectroot`.

You can sort the results by clicking the report column headers.

- **Toolboxes required by this model**. For details, see “Required Toolboxes” on page 18-45.

- **References in this model** — This section provides details of references to other files so you can identify where dependencies arise. You control the scope of this section with the **Report file dependency locations** options on the Generate Manifest dialog box. You can choose to include references to user files only, all files, or no files. See “Generate Manifests” on page 18-26. Use this section of the report to trace dependencies to understand why a particular file or toolbox is required by a model. If you need to analyze many references, it can be helpful to sort the results by clicking the report column headers.
- **Folders referenced by this model**
- **Orphaned base workspace variables** — If you selected the analysis option **Find orphaned base workspace data**, this section reports any base workspace variables the model requires that are not defined in a file in this manifest.
- **Warnings generated while analyzing MATLAB code** — You can opt out of this section by clearing the **Store MATLAB code analysis warnings in manifest** analysis option.
- **Dependency analysis settings** — Records the details of the analysis scope options.

See the examples shown in “Example Model Manifest Report” on page 18-46.

### Required Toolboxes

In the report, the “Toolboxes required by this model” section lists all products required by the model *that the analysis can detect*. Be aware that the analysis might not report certain blocksets or toolboxes required by a model, e.g., blocksets that do not introduce dependence on any files (such as Fixed-Point Designer) cannot be detected. Some MathWorks files under toolbox/shared can report only requiring MATLAB instead of their associated toolbox.

The results reported can be affected by your analysis scope settings and your installed products. For example:

- If you have code generation products and select the scope option “**Find files required for code generation**”, then:
  - Simulink Coder software is always reported as required.
  - If you also have an `.ert` system target file selected, then Embedded Coder software is always reported as required.
- If you clear the **Find library links** option, then the analysis cannot find a dependence on, for example, `someBlockSet`, and so no dependence is reported upon the block set.

- If you clear the **Analyze MATLAB files** option, then the analysis cannot find a dependence upon `fuzzy.m`, and so no dependence is reported upon the Fuzzy Logic Toolbox™.

### Example Model Manifest Report

You should always check the **Dependency analysis settings** section in the Model Manifest Report to see the scope of analysis settings used to generate it.

Following are portions of a sample report.

### Model Manifest Report:mpowertrain

Actions
<ul style="list-style-type: none"> <li>• <a href="#">Re-generate this manifest</a></li> <li>• <a href="#">Edit this manifest</a></li> <li>• <a href="#">Compare this manifest with another one</a></li> <li>• <a href="#">Export the files in this manifest to a ZIP file</a></li> </ul>

Analysis performed:09-Jul-2013 14:30:49

#### Model Reference and Library Link hierarchy

- [mpowertrain](#)
  - [menginemodel](#)
  - [mtransmission](#)
    - [mtransmission\\_ratio](#)
    - [mpowertrainlib](#)
  - [mpowertrainlib](#)

#### Files used by this model

Root folder for this manifest: C:\Work\SimulinkFiles\manifestanalysis\mpowertrain\mpowertrain\_1

Click on a column header to sort the table

File Name	Size	Last Modified Date	Will be Exported
\$Projectroot\crank_detect.m <a href="#">(open)</a>	11613bytes	2009-06-03 10:26:38	true
\$Projectroot\lp_filter.c <a href="#">(open)</a>	17bytes	2006-10-27 17:11:58	true
\$Projectroot\lp_filter.h <a href="#">(open)</a>	20bytes	2006-10-27 17:12:00	true
\$Projectroot\mathFunctions.lib <a href="#">(open)</a>	4bytes	2006-10-27 17:12:00	true
\$Projectroot\menginemodel.mdl <a href="#">(open)</a>	19260bytes	2006-08-08 14:13:10	true
\$Projectroot/mpowertrain.mdl <a href="#">(open)</a>	58077bytes	2009-06-03 10:25:14	true
\$Projectroot/mpowertrainlib.mdl <a href="#">(open)</a>	34759bytes	2006-08-08 14:13:14	true
\$Projectroot/mtransmission.mdl <a href="#">(open)</a>	36071bytes	2009-06-03 10:29:10	true
\$Projectroot/mtransmission_ratio.mdl <a href="#">(open)</a>	24761bytes	2009-06-03 10:26:46	true
\$Projectroot/powertrain_data.mat	1976bytes	2006-10-27 17:12:02	true

#### Toolboxes required by this model

- MATLAB (8.2)
- Simulink (8.2)
- Simulink Coder (8.5)
- Stateflow (8.2)



## References in this model

Use the table below to determine where in a model a dependence upon a particular file or toolbox originates.

Click on a column header to sort the table

Reference Type	Reference Location	File Name	Toolbox
Model Reference	mpowertrain/engine model ( <a href="#">show</a> )	\$projectroot/menginemodel.mdl ( <a href="#">open</a> )	(not in a toolbox)
Library Link	mpowertrain/Library Shift Logic ( <a href="#">show</a> )	\$projectroot/mpowertrainlib.mdl ( <a href="#">open</a> )	(not in a toolbox)
Model Reference	mpowertrain/transmission ( <a href="#">show</a> )	\$projectroot/mtransmission.mdl ( <a href="#">open</a> )	(not in a toolbox)
Model Callback, PreLoadFcn	mpowertrain ( <a href="#">show</a> )	\$projectroot/powertrain_data.mat	(not in a toolbox)
Simulink Coder, Configuration, Custom Code	mtransmission ( <a href="#">show</a> )	\$projectroot/lp_filter.c ( <a href="#">open</a> )	(not in a toolbox)
Simulink Coder, Configuration, Custom Code	mtransmission ( <a href="#">show</a> )	\$projectroot/lp_filter.h ( <a href="#">open</a> )	(not in a toolbox)
Simulink Coder, Configuration, Custom Code	mtransmission ( <a href="#">show</a> )	\$projectroot/mathFunctions.lib ( <a href="#">open</a> )	(not in a toolbox)
Library Link	mtransmission/Grouped Unit Delay ( <a href="#">show</a> )	\$projectroot/mpowertrainlib.mdl ( <a href="#">open</a> )	(not in a toolbox)
Library Link	mtransmission/Torque Converter/Torque Conversion ( <a href="#">show</a> )	\$projectroot/mpowertrainlib.mdl ( <a href="#">open</a> )	(not in a toolbox)
Model Reference	mtransmission/transmission ratio ( <a href="#">show</a> )	\$projectroot/mtransmission_ratio.mdl ( <a href="#">open</a> )	(not in a toolbox)
MATLAB S-Function	mtransmission_ratio/CrankSpeedSmoothing ( <a href="#">show</a> )	\$projectroot/crank_detect.m ( <a href="#">open</a> )	(not in a toolbox)

## Orphaned base workspace variables

Use the table below to determine what base workspace variables the model requires, that are not defined in a file in this Manifest

Click on a column header to sort the table

Variable Name	Class	Reference Location
manual	logical	mpowertrain/Model Variants ( <a href="#">show</a> )
trans_type_auto	Simulink.Variant	mpowertrain/Model Variants ( <a href="#">show</a> )
trans_type_manual	Simulink.Variant	mpowertrain/Model Variants ( <a href="#">show</a> )

## Warnings generated while analyzing MATLAB code

(No warnings were generated)

### Dependency analysis settings:

- Detect orphaned workspace variables: **true**
- Find model references: **true**
- Find library links: **true**
- Allow models with unsaved changes to be analyzed: **false**
- Find S-functions: **true**
- Analyze model and block callbacks: **true**
- Find code-generation files: **true**
- Find data files: **true**
- Analyze Stateflow charts: **true**
- Analyze Embedded MATLAB code: **true**
- Find Requirements documents: **false**
- Analyze files in user-defined toolboxes: **true**
- Analyze MATLAB files: **true**
- Reporting of file dependence locations: **user files only**
- Store warnings: **true**

## Related Examples

- “What Is Dependency Analysis?” on page 18-2
- “Run Dependency Analysis” on page 18-4

- “Check Dependency Results and Resolve Problems” on page 18-17
- “Perform Impact Analysis” on page 18-7
- “Find Requirements Documents in a Project” on page 18-22

# Simulink Project Source Control

---

- “About Source Control with Projects” on page 19-2
- “Add a Project to Source Control” on page 19-6
- “Register Model Files with Source Control Tools” on page 19-10
- “Set Up SVN Source Control” on page 19-11
- “Set Up Git Source Control” on page 19-20
- “Disable Source Control” on page 19-26
- “Change Source Control” on page 19-27
- “Write a Source Control Integration with the SDK” on page 19-28
- “Retrieve a Working Copy of a Project from Source Control” on page 19-29
- “Tag and Retrieve Versions of Project Files” on page 19-34
- “Refresh Status of Project Files” on page 19-36
- “Check for Modifications” on page 19-37
- “Update Revisions of Project Files” on page 19-38
- “Get SVN File Locks” on page 19-40
- “View Modified Files” on page 19-41
- “Compare Revisions” on page 19-44
- “Run Project Checks” on page 19-47
- “Commit Modified Files to Source Control” on page 19-49
- “Revert Changes” on page 19-51
- “Pull, Push, and Fetch Files with Git” on page 19-54
- “Branch and Merge Files with Git” on page 19-59
- “Resolve Conflicts” on page 19-64
- “Work with Derived Files in Projects” on page 19-69
- “Customize External Source Control to Use MATLAB for Diff and Merge” on page 19-70

## About Source Control with Projects

You can use Simulink Project to work with source control. You can perform operations such as update, commit, merge changes, and view revision history directly from the Simulink Project environment.

Simulink Project has interfaces to:

- Subversion (SVN) — See “Set Up SVN Source Control” on page 19-11.
- Git— See “Set Up Git Source Control” on page 19-20.
- Software Development Kit (SDK) — You can use the SDK to integrate Simulink Projects with third-party source control tools. See “Write a Source Control Integration with the SDK” on page 19-28.

---

**Tip:** You can check for updated source control integration downloads on the Simulink Projects Web page: <https://www.mathworks.com/discovery/simulink-projects.html>

---

To use source control in your project, use any of the following workflows:

- Add source control to a project. See “Add a Project to Source Control” on page 19-6.
- Retrieve files from an existing repository and create a new project. See “Retrieve a Working Copy of a Project from Source Control” on page 19-29.
- Create a new project in a folder already under source control and click **Detect**. See “Create a New Project to Manage Existing Files” on page 16-18.
- Make your project publicly available on GitHub. See “Share Project on GitHub” on page 17-51.

When your project is under source control, you can:

- “Retrieve a Working Copy of a Project from Source Control” on page 19-29
- “Compare Revisions” on page 19-44
- “Commit Modified Files to Source Control” on page 19-49

---

**Caution:** Before using source control, you must register model files with your source control tools to avoid corrupting models. See “Register Model Files with Source Control Tools” on page 19-10.

---

To view an example project under source control, see “Explore Simulink Project Tools with the Airframe Project” on page 16-5.

## Classic and Distributed Source Control

This diagram represents the classic source control workflow (for example, using SVN).

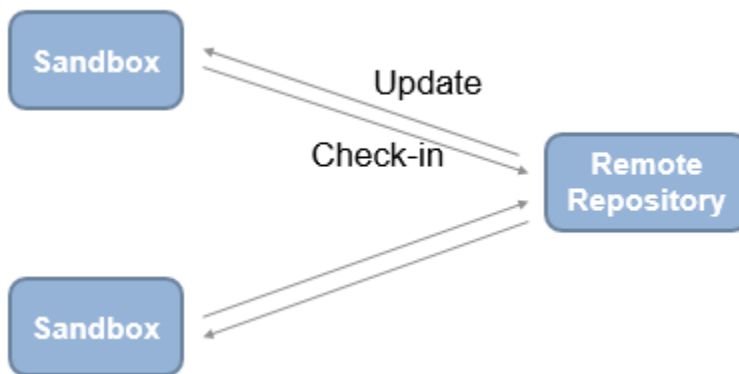

Benefits of classic source control:

- Locking and user permissions on a per-file basis (e.g., you can enforce locking of model files)
- Central server, reducing local storage needs
- Simple and easy to learn

This diagram represents the distributed source control workflow (for example, using Git).

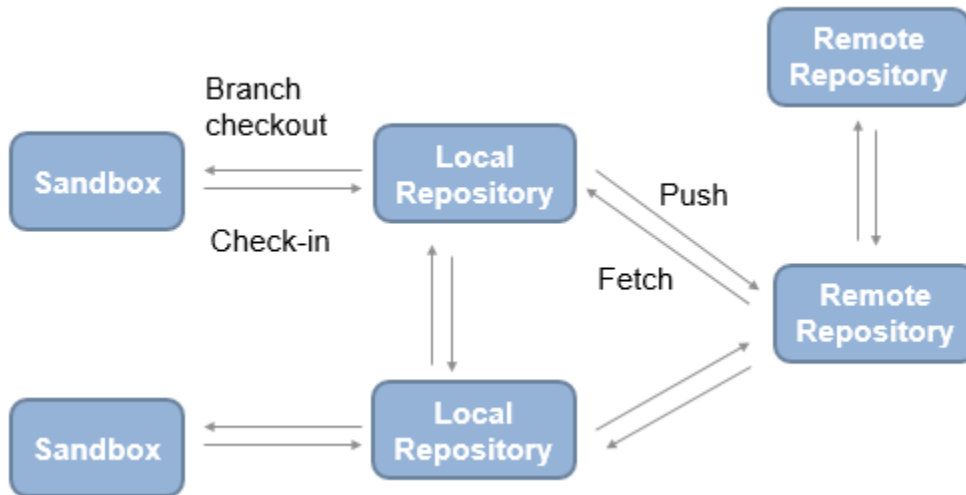

Benefits of distributed source control:

- Offline working
- Local repository, which provides full history
- Branching
- Multiple remote repositories, enabling large-scale hierarchical access control

To choose classic or distributed source control, consider these tips.

Classic source control can be helpful if:

- You need file locks.
- You are new to source control.

Distributed source control can be helpful if:

- You need to work offline, commit regularly, and need access to the full repository history.
- You need to branch locally.

## Related Examples

- “Set Up SVN Source Control” on page 19-11

- “Set Up Git Source Control” on page 19-20
- “Add a Project to Source Control” on page 19-6
- “Retrieve a Working Copy of a Project from Source Control” on page 19-29
- “Register Model Files with Source Control Tools” on page 19-10

## Add a Project to Source Control

<b>In this section...</b>
“Add a Project to Git Source Control” on page 19-6
“Add a Project to SVN Source Control” on page 19-7

### Add a Project to Git Source Control

If you want to add version control to your Simulink project files without sharing with another user, it is quickest to create a local Git repository in your sandbox.

- 1 On the Simulink Project tab, in the Source Control section, click **Use Source Control**.
- 2 In the Source control information dialog box, click **Add project to source control**.
- 3 In the Add to Source Control dialog box, in the **Source control integration** list, select **Git** to use the Git source control integration provided by Simulink Project.
- 4 Click **Convert** to finish adding the project to source control.

Git creates a local repository in your sandbox project root folder. The project runs integrity checks.

- 5 Click **Open Project** to return to your project.

The Project node displays the source control name **Git** and the repository location **Local Repository: *yoursandboxpath***.

- 6 Select the Modified Files view and click **Commit** to commit the first version of your files to the new repository.

In the dialog box, enter a comment if you want, and click **Submit**.

You need some additional setup steps only if you want to merge branches with Git. See “Install Command-Line Git Client” on page 19-22.

---

**Tip:** If you want to use Git and share with other users:

- To clone an existing remote Git repository, see “Retrieve a Working Copy of a Project from Source Control” on page 19-29.





- To connect an existing project to a remote repository, on the Simulink Project tab, in the Source Control section, click **Remote** and specify a single remote repository for the origin branch.
  - To make your project publicly available on GitHub, see “Share Project on GitHub” on page 17-51.
- 

## Add a Project to SVN Source Control

**Caution:** Before you start, check that your sandbox folder is on a local hard disc. Using a network folder with SVN is slow and unreliable.

---

This procedure adds a project to the built-in SVN integration that comes with Simulink Project. If you want to use a different version of SVN, see “Set Up SVN Source Control” on page 19-11.

- 1 On the Simulink Project tab, in the Source Control section, click **Use Source Control**.
- 2 In the Source control information dialog box, click **Add project to source control**.
- 3 In the Add to Source Control dialog box, leave the default **Source control integration** selected to use **Built-In SVN Integration**.
- 4 Next to **Repository path**, click **Change**.
- 5 In the Specify SVN Repository URL dialog box, select an existing repository or create a new one.
  - To specify an existing repository, click Generate URL from folder  to browse for your repository, paste a URL into the box, or use the list to select a recent repository.
  - To create a new repository, click Create an SVN repository in a folder . Using the file browser, create a folder where you want to create the new repository and click **Select Folder**. Do not place the new repository inside the existing project folder.

Simulink Project creates a repository in your folder, and you return to the Specify SVN Repository URL dialog box. The URL of the new repository is in the **Repository URL** box, and the project automatically selects the **trunk** folder.

---

**Caution:** Specify `file://` URLs and create new repositories for single users only. For multiple users, see “Share a Subversion Repository” on page 19-17.

---

- 6 Click **Validate** to check the path to the selected repository.

When the path is valid, you can browse the repository folders. For example, select the **trunk** folder, and verify the selected URL at the bottom of the dialog box, as shown.

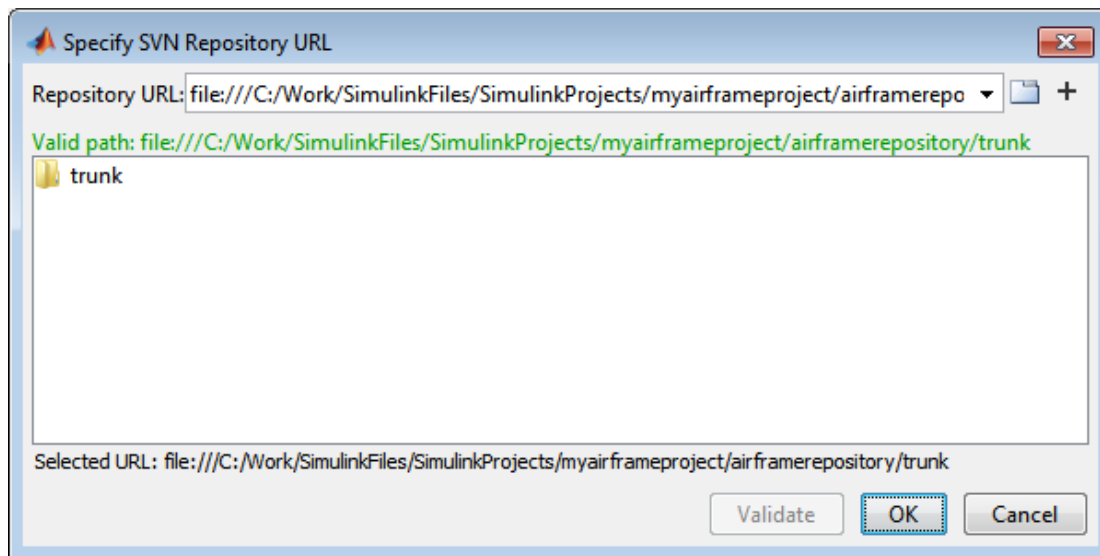

- 7 Click **OK** to return to the Add to Source Control dialog box.

If your repository has a file URL, a warning appears that file URLs are for single users. Click **OK** to continue.

- 8 Click **Convert** to finish adding the project to source control.

The project runs integrity checks.

- 9 After the integrity checks run, click **Open Project** to return to your project.

The Project node displays details of the current source control tool and the repository location.

- 10** If you created a new repository, select the Modified Files view and click **Commit** to commit the first version of your files to the new repository. In the dialog box, enter a comment if you want, and click **Submit**.

---

**Caution:** Before using source control, you must register model files with your source control tools to avoid corrupting models. See “Register Model Files with Subversion” on page 19-13.

---

## Related Examples

- “Set Up SVN Source Control” on page 19-11
- “Set Up Git Source Control” on page 19-20
- “Register Model Files with Source Control Tools” on page 19-10
- “Retrieve a Working Copy of a Project from Source Control” on page 19-29
- “Get SVN File Locks” on page 19-40
- “Work with Project Files” on page 17-8
- “View Modified Files” on page 19-41
- “Commit Modified Files to Source Control” on page 19-49

## More About

- “About Source Control with Projects” on page 19-2

## Register Model Files with Source Control Tools

If you use third-party source control tools, you must register your model file extensions (.mdl and .slx) as binary formats. If you do not, these third-party tools can corrupt your model files when you submit them, by changing end-of-line characters, expanding tokens, substituting keywords, or attempting to automerge. Corruption can occur whether you use the source control tools outside of Simulink or if you try submitting files from Simulink Project without first registering your file formats.

Also check that other file extensions are registered as binary to avoid corruption at check-in for files such as .mat, .mlx, .mdl, .slxp, .sldd, .p, MEX-files, .xlsx, .jpg, .pdf, .docx, etc.

For instructions with SVN, see “Register Model Files with Subversion” on page 19-13. You must register model files if you use SVN, including the Built-In SVN Integration provided by Simulink Project.

For instructions with Git, see “Register Model Files with Git” on page 19-23.

### Related Examples

- “Register Model Files with Subversion” on page 19-13
- “Register Model Files with Git” on page 19-23

## Set Up SVN Source Control

### In this section...

“Set Up SVN Integration Provided with Simulink Project” on page 19-11

“Set Up SVN Integration for SVN Version Already Installed” on page 19-12

“Set Up SVN Integration for SVN Version Not Yet Provided with Simulink Project” on page 19-12

“Register Model Files with Subversion” on page 19-13

“Enforce SVN Locking Model Files Before Editing” on page 19-16

“Share a Subversion Repository” on page 19-17

“Manage SVN Externals” on page 19-18

### Set Up SVN Integration Provided with Simulink Project

Simulink Project provides **Built-In SVN Integration** for use with Subversion (SVN) sandboxes and repositories at version 1.8. You do not need to install SVN to use this integration because it includes an implementation of SVN.

---

**Note:** This integration ignores any existing SVN installation.

The **Built-In SVN Integration** supports secure logins.

---

To use the version of SVN provided with Simulink Project, when you add a project to source control or retrieve from source control, select **Built-In SVN Integration** in the **Source control integration** list. For instructions, see

- “Add a Project to Source Control” on page 19-6, or
- “Retrieve a Working Copy of a Project from Source Control” on page 19-29.

---

**Caution:** Place your project sandbox folder on a local hard disc. Using a network folder with SVN is slow and unreliable. If you use a Windows network drive, SVN move operations can result in incorrect "not existing" status for files visible in file browsers.

---

When you create a new sandbox using the Simulink Project **Built-In SVN Integration**, the new sandbox uses the latest version of SVN provided by Simulink Project.

When your project is under source control, you can use these project features:

- “Retrieve a Working Copy of a Project from Source Control” on page 19-29
- “Compare Revisions” on page 19-44
- “Commit Modified Files to Source Control” on page 19-49

You can check out from a branch, but the project Built-In SVN Integration does not support branch merging. Use an external tool such as TortoiseSVN to perform branch merging. You can use the project tools for comparing and merging by configuring TortoiseSVN to generate an XML comparison report when you perform a diff on model files. See “Compare XML from Models Managed with Subversion” (Simulink Report Generator).

## Set Up SVN Integration for SVN Version Already Installed

If you want to use Simulink Project with an earlier SVN version you already have installed, create a new project in a folder already under SVN source control. The project detects SVN.

For example:

- 1 Create the sandbox using TortoiseSVN from Windows Explorer.
- 2 Use Simulink Project to create a new project in that folder. The project detects the existing source control. If the sandbox is version 1.6, for example, it remains a version 1.6 sandbox.

---

**Note:** Before using source control, you must register model files with the tools. See “Register Model Files with Subversion” on page 19-13.

---

## Set Up SVN Integration for SVN Version Not Yet Provided with Simulink Project

If you need to use a later version of SVN than 1.8, you can use **Command-Line SVN Integration (compatibility mode)**, but you must also install a command-line SVN client.

---

**Note:** Select **Command-Line SVN Integration (compatibility mode)** only if you need to use a later version of SVN than 1.8. Otherwise, use **Built-In SVN Integration** instead, for more features, improved performance, and no need to install an additional command-line SVN client.

---

Command-line SVN integration communicates with any Subversion (SVN) client that supports the command-line interface.

- 1 Install an SVN client that supports the command-line interface.

---

**Note:** TortoiseSVN does not support the command-line interface unless you choose the option to install command-line tools. Alternatively, you can continue to use TortoiseSVN from Windows Explorer after installing another SVN client that supports the command-line interface. Ensure that the major version numbers match, for example, both clients are SVN 1.7.

---

You can find Subversion clients on this Web page:

<http://subversion.apache.org/packages.html>

- 2 In Simulink Project, select **Command-Line SVN Integration (compatibility mode)**.

With **Command-Line SVN Integration (compatibility mode)**, if you try to rename a file in a project and the folder name contains an @ character, an error appears because command-line SVN treats all characters after the @ symbol as a peg revision value.

---

**Tip:** You can check for updated source control integration downloads on the Simulink Projects Web page: <https://www.mathworks.com/discovery/simulink-projects.html>

---

## Register Model Files with Subversion

You must register model files if you use SVN, including the **Built-In SVN Integration** provided by Simulink Project.

If you do not register your model file extension as binary, SVN might add annotations to conflicted Simulink files and attempt automerge. This corrupts model files so you cannot load the models in Simulink.

To avoid this problem when using SVN, register file extensions.

- 1 Locate your SVN config file. Look for the file in these locations:
  - C:\Users\myusername\AppData\Roaming\Subversion\config or C:\Documents and Settings\myusername\Application Data\Subversion\config on Windows
  - In ~/.subversion on Linux or Mac OS X
- 2 If you do not find a config file, create a new one. See “Create SVN Config File” on page 19-14.
- 3 If you find an existing config file, you have previously installed SVN. Edit the config file. See “Update Existing SVN Config File” on page 19-15.

### Create SVN Config File

- 1 If you do not find an SVN config file, create a text file containing these lines:

```
[miscellany]
enable-auto-props = yes
[auto-props]
*.mdl = svn:mime-type=application/octet-stream
*.mat = svn:mime-type=application/octet-stream
*.slx = svn:mime-type= application/octet-stream
*.mlx = svn:mime-type=application/octet-stream
```
- 2 Check for other file types you use in your projects that you also need to register as binary to avoid corruption at check-in. Check for files such as .mat, .mdl, .slx, .p, MEX-files (.mexa64, .mexmaci64, .mexw64), .xlsx, .jpg, .pdf, .docx, etc. Add a line to the attributes file for each file type you need. Examples:

```
*.mdl = svn:mime-type=application/octet-stream
*.slx = svn:mime-type=application/octet-stream
*.sldd = svn:mime-type=application/octet-stream
*.p = svn:mime-type=application/octet-stream
*.mexa64 = svn:mime-type=application/octet-stream
*.mexw64 = svn:mime-type=application/octet-stream
*.mexmaci64 = svn:mime-type=application/octet-stream
*.xlsx = svn:mime-type=application/octet-stream
*.docx = svn:mime-type=application/octet-stream
```



```
*.pdf = svn:mime-type=application/octet-stream
*.jpg = svn:mime-type=application/octet-stream
*.png = svn:mime-type=application/octet-stream
```

**3** Name the file `config` and save it in the appropriate location:

- `C:\Users\myusername\AppData\Roaming\Subversion\config` or `C:\Documents and Settings\myusername\Application Data\Subversion\config` on Windows
- `~/.subversion` on Linux or Mac OS X

After you create the SVN config file, SVN treats new model files as binary.

If you already have models in repositories, see “Register Models Already in Repositories” on page 19-16.

### Update Existing SVN Config File

If you find an existing `config` file, you have previously installed SVN. Edit the `config` file to register files as binary.

- 1** Edit the `config` file in a text editor.
- 2** Locate the `[miscellany]` section, and verify the following line enables `auto-props` with `yes`:

```
enable-auto-props = yes
```

Ensure that this line is not commented (that is, that it does not start with a `#`).

Config files can contain example lines that are commented out. If there is a `#` character at the beginning of the line, delete it.

- 3** Locate the `[auto-props]` section. Ensure that `[auto-props]` is not commented. If there is a `#` character at the beginning, delete it.
- 4** Add the following lines at the end of the `[auto-props]` section:

```
*.mdl = svn:mime-type= application/octet-stream
*.mat = svn:mime-type=application/octet-stream
*.slx = svn:mime-type= application/octet-stream
*.mlx = svn:mime-type=application/octet-stream
```

These lines prevent SVN from adding annotations to MATLAB and Simulink files on conflict and from automerging.

- 5** Check for other file types you use in your projects that you also need to register as binary to avoid corruption at check-in. Check for files such as `.mat`, `.mdl`, `.slx`,

.p, MEX-files (.mexa64, .mexmaci64, .mexw64), .xlsx, .jpg, .pdf, .docx, etc. Add a line to the config file for each file type you need.

Examples:

```
*.mdl  = svn:mime-type=application/octet-stream
*.slxp = svn:mime-type=application/octet-stream
*.sldd = svn:mime-type=application/octet-stream
*.p    = svn:mime-type=application/octet-stream
*.mexa64 = svn:mime-type=application/octet-stream
*.mexw64 = svn:mime-type=application/octet-stream
*.mexmaci64 = svn:mime-type=application/octet-stream
*.xlsx  = svn:mime-type=application/octet-stream
*.docx  = svn:mime-type=application/octet-stream
*.pdf   = svn:mime-type=application/octet-stream
*.jpg   = svn:mime-type=application/octet-stream
*.png   = svn:mime-type=application/octet-stream
```

## 6 Save the config file.

After you create or update the SVN config file, SVN treats new model files as binary.

If you already have models in repositories, register them as described next.

### Register Models Already in Repositories

---

**Caution:** Changing your SVN config file does not affect model files already committed to an SVN repository. If a model is not registered as binary, use `svn propset` to manually register models as binary.

---

To manually register a file in a repository as binary, use the following command with command-line SVN:

```
svn propset svn:mime-type application/octet-stream modelfilename
```

If you need to install a command-line SVN client, see “Set Up SVN Integration for SVN Version Not Yet Provided with Simulink Project” on page 19-12.

### Enforce SVN Locking Model Files Before Editing

To ensure users remember to get a lock on model files before editing, you can configure SVN to make specified file extensions read only. To locate your SVN config file, see “Register Model Files with Subversion” on page 19-13.

After this setup, SVN sets model files to read only when you open the project, so you need to select **Source Control > Get File Lock** before you can edit them. Doing so helps prevent editing of models without getting the file lock. When the file has a lock, other users know the file is being edited, and you can avoid merge issues.

- 1 To make SLX files read only, add a property to your SVN config file. Find this line in the [ auto-props ] section that registers slx files as binary:  

```
*.slx = svn:mime-type= application/octet-stream
```
- 2 Add the `needs-lock` property to the end of the existing `slx` line, separated by a semicolon, so the line looks like this:  

```
*.slx = svn:mime-type=application/octet-stream;svn:needs-lock=yes
```

You can combine properties in any order, but multiple entries (e.g., for `slx`) must be on a single line separated by semicolons.
- 3 Recreate the sandbox for the config to take effect.
- 4 You need to select **Get File Lock** before you can edit model files. See “Get SVN File Locks” on page 19-40.

If you need to resolve merge issues, see “Resolve Conflicts” on page 19-64.

## Share a Subversion Repository

You can specify a repository location using the `file://` protocol. However, Subversion documentation strongly recommends only single users access a repository directly via `file://` URLs. See the Web page:

<http://svnbook.red-bean.com/en/1.7/svn-book.html#svn.serverconfig.choosing.recommendations>

---

**Caution:** Do not allow multiple users to access a repository directly via `file://` URLs or you risk corrupting the repository. Use `file://` URLs only for single-user repositories.

---

Be aware of this caution with these workflows:

- If you specify a repository with a `file://` URL, or
- If you use Simulink Projects to create a repository, this uses the `file://` protocol. Creating new repositories is provided for local single-user access only, for testing and debugging.

Also, accessing a repository via `file://` URLs is slower than using a server.

When you want to share a repository, you need to set up a server. You can use `svnserve` or the Apache™ SVN module. See the Web page references:

<http://svnbook.red-bean.com/en/1.7/svn-book.html#svn.serverconfig.svnservice>  
<http://svnbook.red-bean.com/en/1.7/svn-book.html#svn.serverconfig.httpd>

### **Standard Repository Structure**

Create your repository with the standard `tags`, `trunk`, and `branches` folders, and check out files from `trunk`. The Subversion project recommends this structure. See the Web page:

<http://svn.apache.org/repos/asf/subversion/trunk/doc/user/svn-best-practices.html>

If you use Simulink Project to create an SVN repository, it creates the standard repository structure. To enable tagging, the repository must have `trunk/` and `tags/` folders.

After you create a repository with this structure, to add tags to all your project files, on the Simulink Project tab, in the Source Control section, click **Tag**. See “Tag and Retrieve Versions of Project Files” on page 19-34.

### **Manage SVN Externals**

To get files into your project from another repository or from a different part of the same repository, use SVN externals.

- 1** In Simulink Project, right-click a project folder and select **Source Control > Manage Externals**.
- 2** In the Manage Externals dialog box, click **Add entry**. You can browse to and validate a repository location, specify the relative reference format, specify the subfolder, choose the revision, e.g., the `HEAD` node, etc.
- 3** After specifying the externals, click **OK**. The project displays the externals definition in the Manage Externals dialog box.

Alternatively, enter or paste an `svn:external` definition in the Manage Externals dialog box. The project applies an SVN version 1.6 compliant externals definition.

- 4** Click **Set** to validate and apply your changes.
- 5** To retrieve the external files, click **Update** to update the sandbox.

If two users modify the `svn:external` for a folder, you can get a conflict. To resolve the conflict, in the All Files View, locate the `.prej` file and examine the conflict details. Open the Manage Externals dialog box and specify the desired `svn:external`, mark the folder conflict resolved, and then commit the changes.

## Related Examples

- “Retrieve a Working Copy of a Project from Source Control” on page 19-29
- “Get SVN File Locks” on page 19-40

## More About

- “About Source Control with Projects” on page 19-2

## Set Up Git Source Control

### In this section...

“About Git Source Control” on page 19-20

“Use Git Source Control in Simulink Project” on page 19-21

“Install Command-Line Git Client” on page 19-22

“Register Model Files with Git” on page 19-23

“Add Git Submodules” on page 19-24

### About Git Source Control

If you want to manage your models and source code using Git, you can integrate with Simulink Project.

Git integration with Simulink Project provides distributed source control with support for creating and merging branches. Git is a distributed source control tool, so you can commit changes to a local repository and later synchronize with other remote repositories.

Git supports distributed development because every sandbox contains a complete repository. The full revision history of every file is saved locally. This enables working offline, because you do not need to contact remote repositories for every local edit and commit, only when pushing batches of changes. In addition, you can create your own branches and commit local edits. Doing so is fast, and you do not need to merge with other changes on each commit.

Capabilities of Git source control:

- Branch management
- Local full revision history
- Local access that is quicker than remote access
- Offline working
- Tracking of file names and contents separately
- Enforcing of change logs for tracing accountability
- Integration of batches of changes when ready

These capabilities do not suit every situation. If your project is not appropriate for offline working or your repository is too large for a full local revision history, for example, Git is not the ideal source control. In addition, if you need to enforce locking of files before editing, Git does not have this ability. In that situation, SVN is the better choice.

When you use Git in Simulink Project, you can:

- Create local Git repositories.
- Pull and fetch files from remote Git repositories.
- Create and switch branches.
- Merge branches locally.
- Commit locally.
- Push files to remote Git repositories.

This diagram represents the distributed Git workflow.

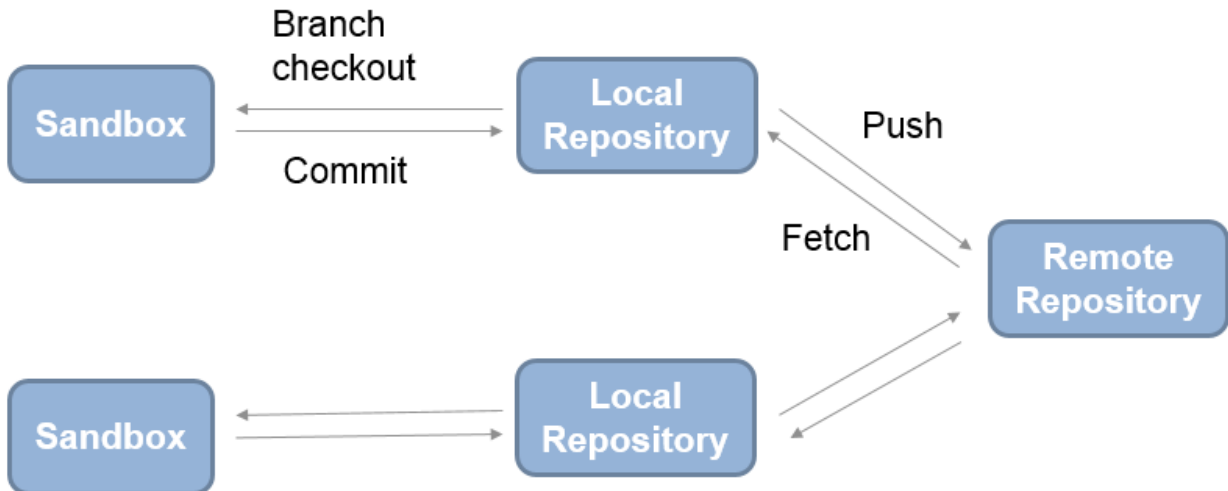

## Use Git Source Control in Simulink Project

To use the version of Git provided with Simulink Project, when you add a project to source control or retrieve from source control, select **Git** in the **Source control integration** list.

- If you add an existing project to Git source control, you create a local Git repository in that sandbox. You can specify a remote repository later. See “Add a Project to Source Control” on page 19-6
- If you want to clone a remote Git repository to create a project, select **New > Simulink Project** on the MATLAB Home tab, and then in the start page, click **Source Control**. After you specify a remote repository to retrieve from, a local repository is created. You can also pull, fetch, and push changes from and to the remote repository. See “Retrieve a Working Copy of a Project from Source Control” on page 19-29.

---

**Note:** You cannot add empty folders to Git source control. Use **Check Project** instead. See “Pull, Push, and Fetch Files with Git” on page 19-54.

---

To use a Git server for your remote repository, you can set up your own Apache Git server or use a Git server hosting solution. If you cannot set up a server and must use a remote repository via the file system using the `file:///` protocol, make sure that it is a bare repository with no checked out working copy.

- To make your project publicly available on GitHub, see “Share Project on GitHub” on page 17-51. Sharing adds Git source control to the open project and the project’s remote repository is GitHub.

## Install Command-Line Git Client

If you want to use Git to merge branches in Simulink Project, you must also install a command-line Git client that is available systemwide. You can use other Git functionality without any additional installation.

Some clients are not available systemwide, including the `mingw32` environment provided by GitHub (**Git Shell** on the **Start** menu). Installing command-line Git makes it available systemwide, and then Simulink Project can locate standard `ssh` keys.

Check if Git is available by using the command `!git` in MATLAB. If Git is not available, install it.

On Windows:

- 1 Download the Git installer and run it. You can find command-line Git at:

<http://msysgit.github.io/>



- 2 In the section on adjusting your PATH, choose the install option to **Use Git from the Windows Command Prompt**. This option adds Git to your PATH variable, so that the Simulink Project can communicate with Git.
- 3 In the section on configuring the line-ending conversions, choose the option **Checkout as-is, commit as-is** to avoid converting any line endings in files.

On Linux, Git is available for most distributions. Install Git for your distribution. For example, on Debian<sup>®</sup>, install Git by entering:

```
sudo apt-get install git
```

On Mac, on Mavericks (10.9) or above, try to run `git` from the Terminal. If you do not have Git installed already, it will prompt you to install Xcode Command Line Tools. For more options, see <http://git-scm.com/doc>.

---

**Caution:** To avoid corrupting models, before using Git to merge branches, register model files. See “Register Model Files with Git” on page 19-23.

---

## Register Model Files with Git

After you install a command-line Git client, you can prevent Git from corrupting your Simulink models by inserting conflict markers. To do so, edit your `.gitattributes` file to register model files as binary. For details, see:

<http://git-scm.com/docs/gitattributes>

- 1 If you do not already have a `.gitattributes` file in your project root folder, create one by entering in MATLAB:

```
edit .gitattributes
```

- 2 Add these lines to the `.gitattributes` file:

```
*.slx -crlf -diff -merge  
*.mdl -crlf -diff -merge  
*.mat -crlf -diff -merge  
*.mlx -crlf -diff -merge
```

These lines specify not to try automatic line feed, diff, and merge attempts for MATLAB and Simulink files.

- 3 Check for other file types you use in your projects that you also need to register as binary to avoid corruption at check-in. Check for files such as `.mat`, `.mdl`, `.slx`,

.p, MEX-files (.mexa64, .mexmaci64, .mexw64), .xlsx, .jpg, .pdf, .docx, etc. Add a line to the attributes file for each file type you need.

Examples:

```
*.mdl -crlf -diff -merge
*.slxp -crlf -diff -merge
*.sldd -crlf -diff -merge
*.p -crlf -diff -merge
*.mexa64 -crlf -diff -merge
*.mexw64 -crlf -diff -merge
*.mexmaci64 -crlf -diff -merge
*.xlsx -crlf -diff -merge
*.docx -crlf -diff -merge
*.pdf -crlf -diff -merge
*.jpg -crlf -diff -merge
*.png -crlf -diff -merge
```

- 4 Restart MATLAB so you can start using the Git client with Simulink Project.

After you have installed a command-line Git client and registered your model files as binary, you can use the merging features of Git in Simulink Project.

## Add Git Submodules

To reuse code from another repository, you can specify Git submodules to include in your project.

To clone an external Git repository as a submodule:

- 1 On the Simulink Project tab, in the Source Control section, click **Submodules**.
- 2 In the Submodules dialog box, click the **+** button.
- 3 In the Add Submodule dialog box, in the **Remote** box, specify a repository location. Optionally, click **Validate**.
- 4 In the **Path** box, specify a location for the submodule in your project and click **OK**. The Submodules dialog box displays the status and details of the submodule.
- 5 Check the status message, and click **Close** to return to your project.

### Use Fetch to Get Latest Submodule Version

When you want to manage the added submodule, open the Submodules dialog box.

- 1 To get the latest version of a submodule, in the Submodules dialog box, click **Fetch**.
- 2 After fetching, you must merge. Check the **Status** message in the Submodules dialog box for information about your current branch relative to the remote tracking branch in the repository. When you see the message **Behind**, you need to merge in changes from the repository to your local branch.
- 3 Click **Branches** and merge in the origin changes to your local branch using the Branches dialog box. See “Pull, Fetch, and Merge” on page 19-55.

### Use Push to Send Changes to the Submodule Repository

If you make changes in your submodule and want to send changes back to the repository:

- 1 Perform a local commit in the parent project.
- 2 Open the Submodules dialog box and click **Push**.

If you want other project users to obtain your changes in the submodule when they clone the parent project, make sure the index and head match.

- 1 In the Submodules dialog box, check the index and head values. The index points to the head commit at the time you first cloned the submodule, or when you last committed the parent project repository. If the index and head do not match, you must update the index.
- 2 To update the index, commit your changes in the parent project, and then click **Push** in the Submodules dialog box. This action makes the index and head the same.

### Related Examples

- “Branch and Merge Files with Git” on page 19-59

## Disable Source Control

Disabling source control is useful when you are preparing a project to create a template from it, and you want to avoid accidentally committing unwanted changes.

- 1 On the Simulink Project tab, in the Source Control section, click the **Details** button for your source control. For example, **SVN Details** or **Git Details**.
- 2 Change the selection from the current source control to `No source control integration`.
- 3 Click **Reload**.

---

**Note:** Source control tools create files in the project folders (for example, SVN creates an `.svn` folder), so you can put the project back under the same source control only by selecting your previous source control from the list.

---

### Related Examples

- “Change Source Control” on page 19-27
- “Create a Template from a Project Under Version Control” on page 16-42
- “Add a Project to Source Control” on page 19-6

## Change Source Control

Changing source control is useful when you want to create a new local repository for testing and debugging.

- 1 Prepare your project by checking for any updates from the existing source control tool repository and committing any local changes.
- 2 On the **Simulink Project** tab, click **Share > Zip Archive** to save a zip file containing the project without any source control information.
- 3 On the **Simulink Project** tab, click **New**, and then in the start page, click **Archive** to create a new project from the archived project.
- 4 On the Simulink Project tab, in the Source Control section, click **Use Source Control**.
- 5 Click **Add project to source control** and then select a new source control. For details, see “Add a Project to Source Control” on page 19-6.

---

**Tip:** To avoid accidentally committing changes to the previous source control, delete the original sandbox.

---

### Related Examples

- “Disable Source Control” on page 19-26
- “Add a Project to Source Control” on page 19-6

## Write a Source Control Integration with the SDK

Simulink provides a Software Development Kit (SDK) that you can use to integrate Simulink Projects with third-party source control tools.

The SDK provides instructions for writing an integration to a source control tool that has a published API you can call from Java<sup>®</sup>.

You must create a `.jar` file that implements a collection of Java interfaces and a Java Manifest file, that defines a set of required properties.

The SDK provides example source code, Javadoc, and files for validating, building, and testing your source control integration. Build and test your own interfaces using the example as a guide. Then you can use your source control integration with Simulink Projects.

- 1 Extract the contents of the SDK.

```
run(fullfile(matlabroot, 'toolbox', 'shared', 'cmlink', 'adapterSDK', 'extractSDK'))
```

Select a folder to place the `cm_adapter_SDK` folder and files in, and click **OK**.

- 2 Locate the new folder `cm_adapter_SDK`, and open the file `cm_adapter_SDK_guide.pdf` for instructions.

After you write a source control integration, see “Add a Project to Source Control” on page 19-6.

### More About

- “About Source Control with Projects” on page 19-2

## Retrieve a Working Copy of a Project from Source Control

Create a new local copy of a project by retrieving files from source control.

- 1 From MATLAB, on the **Home** tab, click **Simulink**, or select **New > Simulink Project**.

Alternatively, on the **Simulink Project** tab, in the **File** section, click **New**.

- 2 In the start page, under **Projects** in the left list, click **Source Control**.
- 3 In the Project Retriever dialog box, select the source control interface from the **Source control integration** list.
  - To use SVN, leave the default **Built-In SVN Integration**.
  - To use Git, select **Git**.
- 4 If you know your repository location, you can paste it into the **Repository Path** box and proceed to step 8. Click **Change** to browse for and validate the repository path to retrieve files from.
- 5 In the dialog box, specify the repository URL by entering or pasting a URL in the box, using the list of recent repositories, or by using the **Generate URL from folder** button .

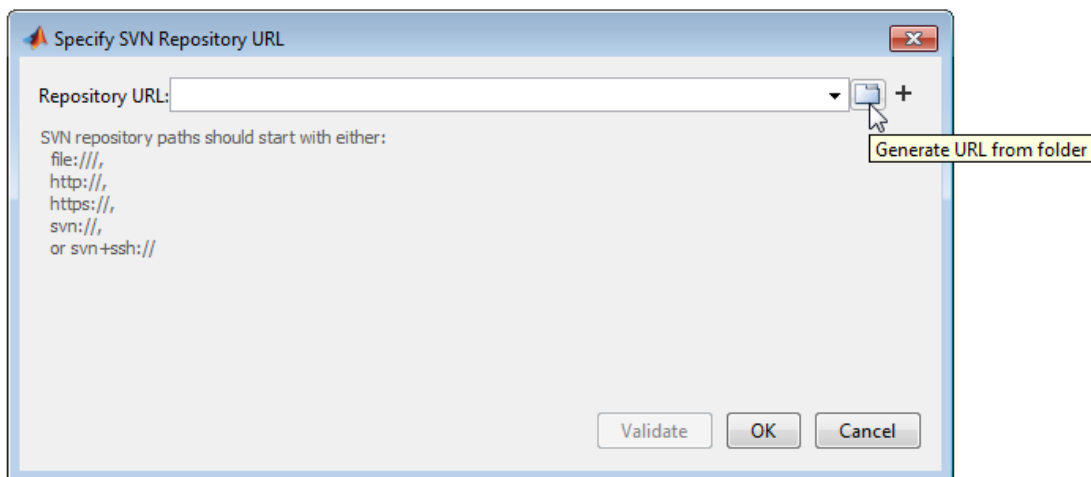

**Caution:** Use `file://` URLs only for single-user repositories. For more information, see “Share a Subversion Repository” on page 19-17.

- 6 Click **Validate** to check the repository path.

If the path is invalid, check the URL against your source control repository browser.

- 7 If you see an authentication dialog box for your repository, enter login information to continue.
- 8 If necessary, select a deeper folder in the repository tree. You might want to check out from `trunk` or from a branch folder under `tags`, if your repository contains tagged versions of files. The example shows `trunk` selected, and the **Selected URL** displays at the bottom of the dialog box. The retriever uses this URL when you click **OK**.

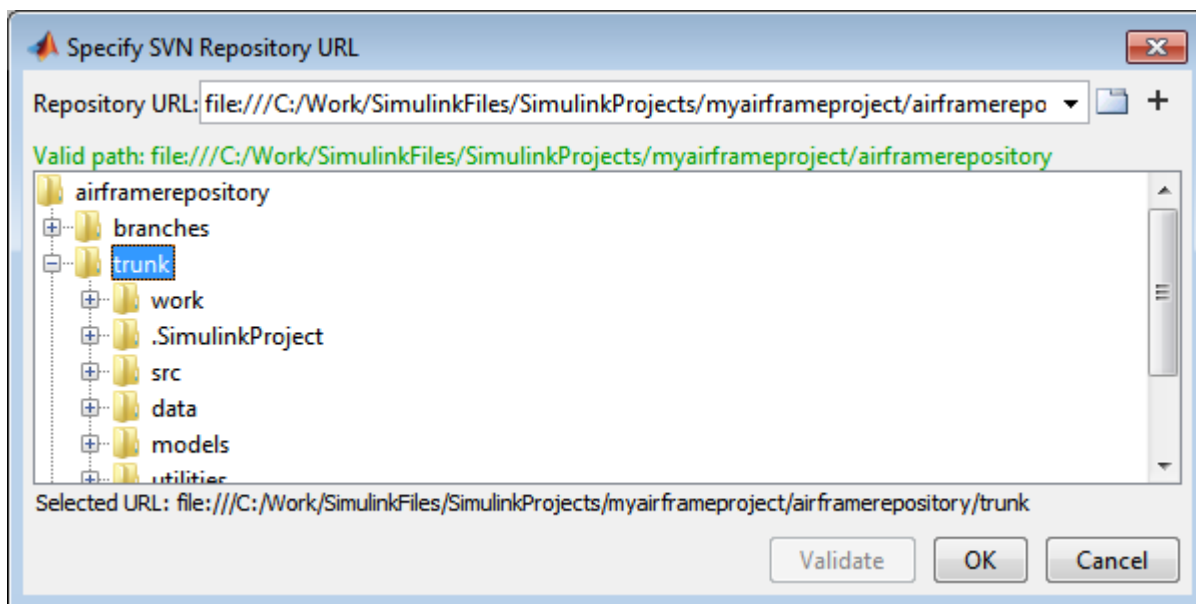

- 9 When you have finished specifying the URL path you want to retrieve, click **OK**.
- 10 In the Project Retriever, select the sandbox folder where you want to put the retrieved files for your new project, and click **Retrieve**.



**Caution:** Use local sandbox folders. Using a network folder with SVN is slow.

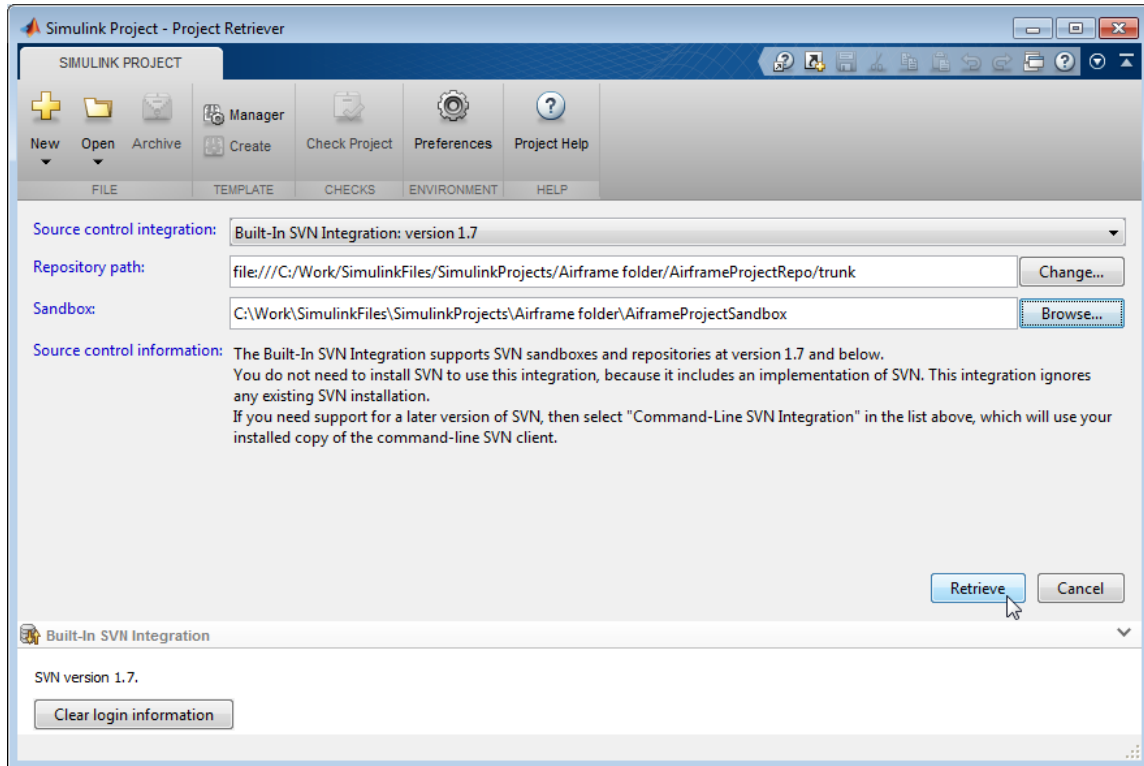

The source control pane (for example, **Built-In SVN Integration** or **Git**) displays messages as the project retrieves the files from source control.

If your repository already contains a Simulink project, the project is ready when the tool finishes retrieving files to your selected sandbox folder.

- 11 If your sandbox does not yet contain a Simulink project, then a dialog box prompts you to check whether you want to create a project in the folder. Click **Yes** to continue creating the project.

The new project controls appear.

- a** In the new project controls, enter a project name.
- b** Click **Create** to finish creating the new project in your new sandbox.

Simulink Project displays the empty Project Files list for the chosen project root. The project does not yet contain any files. For next steps, see “Add Files to the Project” on page 16-20.

---

**Note:** To update an existing project sandbox from source control, see “Update Revisions of Project Files” on page 19-38.

---

## Troubleshooting

If you encounter errors like `OutOfMemoryError: Java heap space`, for example when cloning big Git repositories, then edit your MATLAB preferences to increase the heap size.

- 1** On the **Home** tab, in the **Environment** section, click **Preferences**.
- 2** Select **MATLAB > General > Java Heap Memory**.
- 3** Move the slider to increase the heap size, and then click **OK**.
- 4** Restart MATLAB.

## Related Examples

- “Set Up SVN Source Control” on page 19-11
- “Set Up Git Source Control” on page 19-20
- “Get SVN File Locks” on page 19-40
- “Work with Project Files” on page 17-8
- “Tag and Retrieve Versions of Project Files” on page 19-34
- “Refresh Status of Project Files” on page 19-36
- “Check for Modifications” on page 19-37
- “Update Revisions of Project Files” on page 19-38
- “View Modified Files” on page 19-41
- “Commit Modified Files to Source Control” on page 19-49

## **More About**

- “About Source Control with Projects” on page 19-2

## Tag and Retrieve Versions of Project Files

With SVN, you can use tags to identify specific revisions of all project files. Not every source control has the concept of tags. To use tags with SVN, you need the standard folder structure in your repository and you need to check out your files from `trunk`. See “Standard Repository Structure” on page 19-18.

- 1 On the Simulink Project tab, in the Source Control section, click **Tag**.
- 2 Specify the tag text and click **OK**. The tag is added to every project file.

Errors appear if you do not have a `tags` folder in your repository.

---

**Note:** You can retrieve a tagged version of your project files from source control, but you cannot tag them again with a new tag. You must check out from `trunk` to create new tags.

---

To retrieve the tagged version of your project files from source control:

- 1 On the **Simulink Project** tab, click **New**, and then in the start page, click **Source Control**.
- 2 Click **Change** to select the Repository Path that you want to retrieve files from.

The Specify Repository URL dialog box opens.

- a Select a recent repository from the **Repository URL** list, or click the **Generate URL from folder** button  to browse for the repository location.
  - b Click **Validate** to show the repository browser.
  - c Expand the `tags` folder in the repository tree, and select the tag version you want. Verify there is a `.SimulinkProject` folder under the chosen tag subfolder.
  - d Click **OK** to continue and return to the Project Retriever.
- 3 Select the sandbox folder to receive the tagged files. You must use an empty sandbox folder. (If you try to retrieve tagged files into an existing sandbox, an error appears.)
  - 4 Click **Retrieve**.

Alternatively, you can use labels to apply any metadata to files and manage configurations. You can group and sort by labels, and create batch jobs to export files by label. See “Add Labels to Files” on page 17-25.

With Git, you can switch branches. See “Branch and Merge Files with Git” on page 19-59.

### **Related Examples**

- “Standard Repository Structure” on page 19-18
- “Add Labels to Files” on page 17-25
- “Branch and Merge Files with Git” on page 19-59

## Refresh Status of Project Files

To check for locally modified project files, on the Simulink Project tab, in the Source Control section, click **Refresh**.

Refresh queries the local sandbox state and checks for changes made with another tool outside of MATLAB.

---

**Note:** For SVN, **Refresh** does not contact the repository. To check the repository for later revisions, use **Check for Modifications** instead. To get the latest revisions, use **Update** instead. See “Check for Modifications” on page 19-37 and “Update Revisions of Project Files” on page 19-38.

---

The buttons in the Source Control section of the Simulink Project tab apply to the whole project.

**Refresh** refreshes the view of the source control status for all files under `projectroot`. Clicking **Refresh** updates the information shown in the **Revision** column and the source control status column (for example, **SVN**, or **Git** columns). Hover over the icon to see the tooltip showing the source control status of a file, e.g., **Modified**.

### Related Examples

- “Check for Modifications” on page 19-37
- “Update Revisions of Project Files” on page 19-38
- “Revert Changes” on page 19-51

## Check for Modifications

To check the status of individual files for modifications, right-click files in Simulink Project and select **Source Control > Check for Modifications**. Use this to find out if the repository version has moved ahead.

With SVN, this option contacts the repository to check for external modifications. Simulink Project compares the revision numbers of the local file and the repository version. If the revision number in the repository is larger than that in the local sandbox folder, then Simulink Project displays (**not latest**) next to the revision number of the local file.

If your local file is not the latest version, get the latest revisions from the repository by clicking **Update**. See “Update Revisions of Project Files” on page 19-38. You might need to resolve conflicts after updating. See “Resolve Conflicts” on page 19-64 and “Compare Revisions” on page 19-44.

To check for locally modified files, use **Refresh** instead. See “Refresh Status of Project Files” on page 19-36.

### Related Examples

- “Refresh Status of Project Files” on page 19-36
- “Update Revisions of Project Files” on page 19-38
- “Compare Revisions” on page 19-44
- “Revert Changes” on page 19-51

## Update Revisions of Project Files

In this section...
“Update Revisions with SVN” on page 19-38
“Update Revisions with Git” on page 19-38
“Update Selected Files” on page 19-39

### Update Revisions with SVN

In Simulink Project, to get the latest revisions of all project files from the source control repository, click **Update** in the source control section of the Simulink Project tab.

Use **Update** to get other people’s changes from the repository and find out about any conflicts. If you want to back out local changes, use **Revert Project** instead. See “Discard Local Changes” on page 19-51.

After you update, the project displays a dialog box listing all the files that have changed on disk. You can control this behavior using the project preference **Show changes on source control update**.

When your project uses SVN source control, **Update** calls `svn update` to bring changes from the repository into your working copy. If there are other people’s changes in your modified files, SVN adds conflict markers to the file. SVN preserves your modifications.

---

**Caution:** Ensure you have registered SLX files as binary with SVN before using **Update**. If you do not, SVN conflict markers can corrupt your SLX file. Simulink Project warns you about this when you first click **Update** to ensure you protect your model files. See “Register Model Files with Subversion” on page 19-13.

---

You must resolve any conflicts before you can commit. See “Resolve Conflicts” on page 19-64.

### Update Revisions with Git

If you are using Git source control, click **Pull** in the source control pane.



---

**Caution:** Ensure you have registered SLX files as binary with Git before using **Pull**. If you do not, conflict markers can corrupt your SLX file. See “Set Up Git Source Control” on page 19-20.

---

Pull fetches the latest changes and merges them into your current branch. If you are not sure what is going to come in from the repository, use fetch to examine the changes first and then merge the changes manually.

Pull might fail if you have conflicts. With a complicated change you might want to create a branch from the origin, make some compatibility changes, then merge that branch into the main tracking branch. For next steps, see “Pull, Push, and Fetch Files with Git” on page 19-54.

## Update Selected Files

To update selected files, right-click and select the **Update** command for the source control system you are using. For example, if you are using SVN, select **Source Control > Update from SVN** to get fresh local copies of the selected files from the repository.

## Related Examples

- “Register Model Files with Source Control Tools” on page 19-10
- “Resolve Conflicts” on page 19-64
- “Discard Local Changes” on page 19-51

## Get SVN File Locks

To ensure users remember to get a lock on model files before editing, you can configure SVN to make model files read only. Follow the steps in “Enforce SVN Locking Model Files Before Editing” on page 19-16. After you configure SVN to make files with certain extensions read only, then users must get a lock on these read-only files before editing.

- 1 In Simulink Project, in any Files view, select the files you want to check out.
- 2 Right-click the selected files and select **Source Control > Get File Lock**.

**Get File Lock** is for SVN. This option does not modify the file in your local sandbox. Git does not have locks.

A lock symbol appears in the SVN source control column. Other users cannot see the lock symbol in their sandboxes, but they cannot get a file lock or check in a change when you have the lock.

---

**Note:** To get a fresh local copy of the file from the repository, select **Update from SVN**.

---

In the Simulink Editor, if an open model belongs to a project under SVN, you can get a lock by selecting **File > Simulink Project > Get File Lock**.

If you see an SVN message reporting a **working copy locked** error, remove stale locks by clicking **SVN Cleanup** in the Source Control section on the Simulink Project tab. SVN uses working copy locks internally and they are not the file locks you control using **Get File Lock**.

### Related Examples

- “Work with Project Files” on page 17-8
- “Enforce SVN Locking Model Files Before Editing” on page 19-16
- “View Modified Files” on page 19-41
- “Commit Modified Files to Source Control” on page 19-49

### More About

- “About Source Control with Projects” on page 19-2

## View Modified Files

In Simulink Project, select the Modified Files view. The Modified Files node is visible only if you are using source control integration with your project.

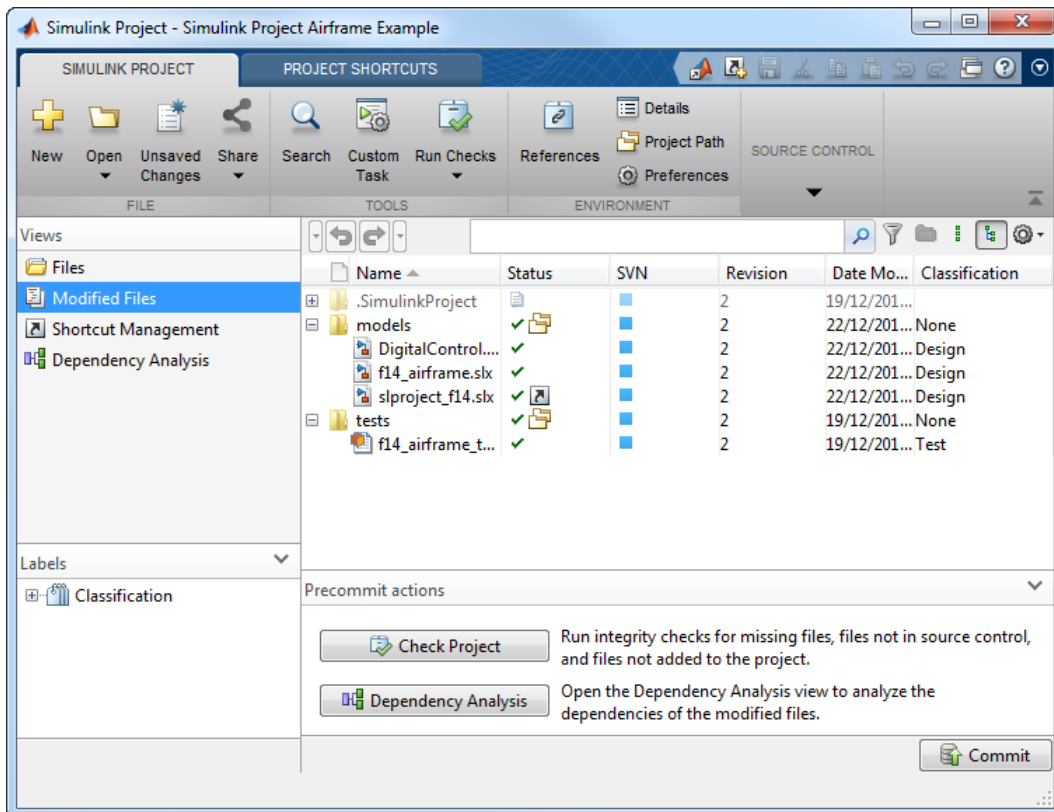

If you need to update the modified files list, click **Refresh** in the source control section of the Simulink Project tab.

Use the Modified Files view to review, analyze, label, and commit modified files. Lists of modified files are sometimes called changesets. You can perform the same operations in the Modified Files view as you can in other file views.

**Tip:** In the Modified Files view, it can be useful to switch to List view by clicking the List

button 

---

You can identify modified or conflicted folder contents using the source control summary status. In the Files views, folders display rolled-up source control status. This makes it easier to locate changes in files, particularly conflicted files. You can hover over the source control status (e.g., the **SVN** or **Git** column) for a folder to view a tooltip displaying how many files inside are modified, conflicted, added or deleted.

## Project Definition Files

The files in `.SimulinkProject` are project definition files generated by your changes. The project definition files allow you to add metadata to files without checking them out, for example, by creating shortcuts, adding labels, and adding a project description. Project definition files also define the files that are added to your project.

Any changes you make to your project (for example, to shortcuts, labels, categories, or files in the project) generate changes in the `.SimulinkProject` folder. These files store the definition of your project in XML files whose format is subject to change.

You do not need to view project definition files directly, except when the source control tool requires a merge. The files are shown so that you know about all the files being committed to the source control system. See “Resolve Conflicts” on page 19-64.

If you want to change project definition file from the type used when the project was created, see `export`.

If you want to use projects with configurations that do not allow folder names to start with “.”, then you can choose an underscore instead. Use the project preferences to change the project definition folder for new projects to `_SimulinkProject`.

## Related Examples

- “Compare Revisions” on page 19-44
- “Run Project Checks” on page 19-47
- “Refresh Status of Project Files” on page 19-36
- “Check for Modifications” on page 19-37
- “Resolve Conflicts” on page 19-64

- “Discard Local Changes” on page 19-51
- “Commit Modified Files to Source Control” on page 19-49

## **More About**

- “About Source Control with Projects” on page 19-2

## Compare Revisions

To review changes in modified files in Simulink Project, select the Modified Files view.

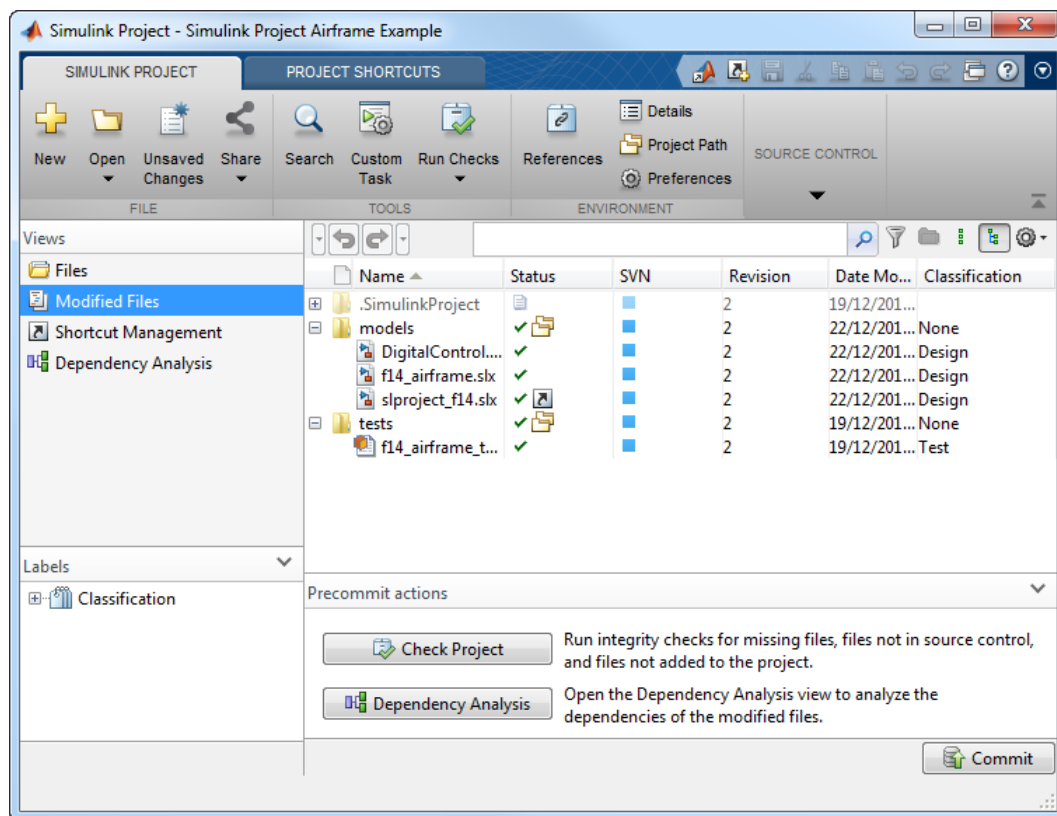

If you need to update the modified files list, click **Refresh** in the source control section of the Simulink Project tab.

To review changes in modified files, right-click selected files in any view in Simulink Project and:

- Select **Compare > Compare to Ancestor** to run a comparison with the last checked-out version in the sandbox (SVN) or against the local repository (Git). The Comparison Tool displays a report.

- To compare other revisions of a file, select **Compare > Compare to Revision**. In the Compare to Revisions dialog box, you can view information about who previously committed the file, when they committed it, and the log messages. To view a comparison report, select the revisions you want to compare. You can either:
  - Select a revision and click **Compare to Local**.
  - Select two revisions and click **Compare Selected**.
- To browse the revision history of a file, select **Source Control > Show Revisions**. In the File Revisions dialog box, view information about who previously committed the file, when they committed it, and the log messages.

---

**Note:** In the Simulink Editor, if an open model, library, or chart belongs to a project under source control, you can view changes by selecting **File > Simulink Project > Compare to Ancestor** or **Compare to Revision**.

---

When you compare to a revision or ancestor, the MATLAB Comparison Tool opens a report comparing the modified version of the file in your sandbox with the selected revision or against its ancestor stored in the version control tool.

Comparison type depends on the file you select. If you select a Simulink model, and you have Simulink Report Generator installed, this command runs a Simulink XML comparison.

When reviewing changes, you can merge Simulink models from the Comparison Tool report (requires Simulink Report Generator). See “Merge Text Files” on page 19-66 and “Merge Models” on page 19-67.

To examine the dependencies of modified files, see “Perform Impact Analysis” on page 18-7.

## Related Examples

- “Resolve Conflicts” on page 19-64
- “Run Project Checks” on page 19-47
- “Perform Impact Analysis” on page 18-7
- “Commit Modified Files to Source Control” on page 19-49
- “Revert Changes” on page 19-51

- “Customize External Source Control to Use MATLAB for Diff and Merge” on page 19-70

### **More About**

- “About Source Control with Projects” on page 19-2



## Run Project Checks

In Simulink Project, you can run checks from any project view by clicking **Run Checks > Check Project** on the **Simulink Project** tab. The project checks can find problems with project integrity such as missing files, unsaved files, or files not under source control.

For details on problems the checks can fix, see “Work with Derived Files in Projects” on page 19-69, “Upgrade Model Files to SLX and Preserve Revision History” on page 17-18, and “Check Dependency Results and Resolve Problems” on page 18-17.

The Precommit actions pane in the Modified Files view contains tools to use before committing your changes to source control, including **Check Project**.

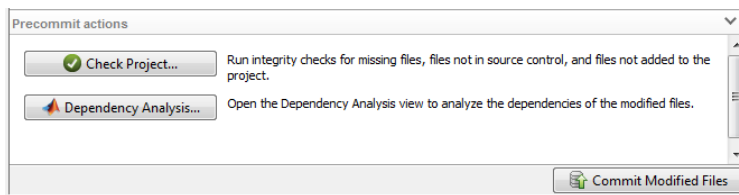

- Click **Check Project** to check the integrity of the project. For example, is everything under source control in the project? Are all project files under source control? A dialog box reports results. You can click for details and follow prompts to fix problems.

For an example showing how the checks can help you, see “Upgrade Model Files to SLX and Preserve Revision History” on page 17-18.

- If you want to check for required files, click **Dependency Analysis** to analyze the dependencies of the modified files.

Use the dependency tools to analyze the structure of your project. See “Perform Impact Analysis” on page 18-7.

---

**Note:** The files in `.SimulinkProject` are project definition files generated by your changes. See “Project Definition Files” on page 19-42.

---

### Related Examples

- “Find Models and MATLAB Files With Unsaved Changes” on page 17-11
- “Commit Modified Files to Source Control” on page 19-49

- “Work with Derived Files in Projects” on page 19-69
- “Upgrade Model Files to SLX and Preserve Revision History” on page 17-18
- “Check Dependency Results and Resolve Problems” on page 18-17

### **More About**

- “About Source Control with Projects” on page 19-2
- “What Is Dependency Analysis?” on page 18-2
- “Project Definition Files” on page 19-42

## Commit Modified Files to Source Control

Before you commit modified files, review changes and consider precommit actions. See “Compare Revisions” on page 19-44 and “Run Project Checks” on page 19-47.

- 1 In Simulink Project, select the Modified Files view.

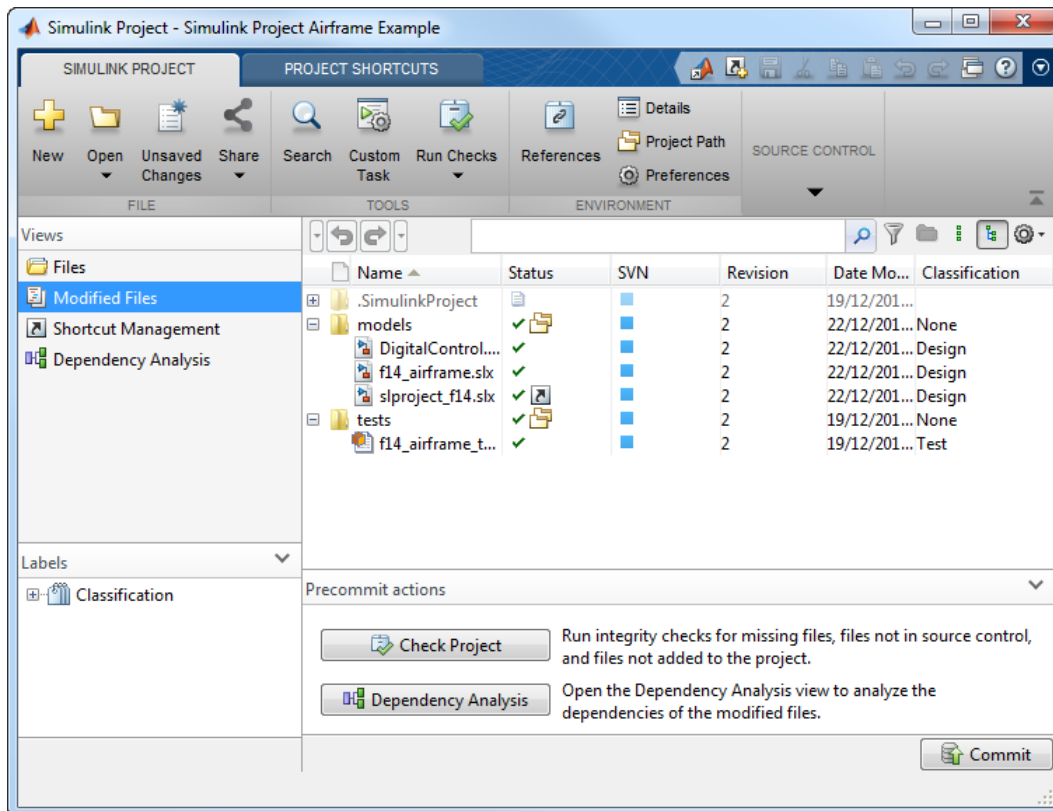

If you need to update the modified files list, click **Refresh** in the source control section of the Simulink Project tab.

- 2 Click **Commit** to check in all files in the modified files list. You can click **Commit** in either the modified files view or on the Simulink Project tab.

If you are using SVN source control, this commits changes to your repository.

If you are using Git source control, this commits to your local repository. To commit to the remote repository, see “Pull and Push” on page 19-54.

- 3** Enter comments in the dialog box if you want, and click **Submit**.
- 4** A message appears if you cannot commit because the repository has moved ahead. Before you can commit the file, you must update its revision up to the current HEAD revision. If you are using SVN source control, click **Update**. If you are using Git source control, click **Pull**. Resolve any conflicts before you commit.

---

**Note:** You can commit individual files using the context menu, by selecting **Source Control > Commit**. However if you commit individual files, you risk not committing the related project definition files that keep track of your files. Instead, use the Modified Files view to commit all related changes.

---

## Related Examples

- “Refresh Status of Project Files” on page 19-36
- “View Modified Files” on page 19-41
- “Run Project Checks” on page 19-47
- “Update Revisions of Project Files” on page 19-38
- “Pull, Push, and Fetch Files with Git” on page 19-54
- “Resolve Conflicts” on page 19-64
- “Revert Changes” on page 19-51

## More About

- “About Source Control with Projects” on page 19-2

## Revert Changes

### In this section...

“Discard Local Changes” on page 19-51

“Revert a File to a Specified Revision” on page 19-51

“Revert the Project to a Specified Revision” on page 19-52

### Discard Local Changes

With SVN, if you want to roll back local changes in a particular file, in Simulink Project, right-click the file and select **Source Control > Discard Local Changes and Release Locks** to release locks and revert to the version in the last sandbox update (that is, the last version you synchronized or retrieved from the repository).

In the Simulink Editor, if an open model belongs to a project under source control, you can revert changes by selecting **File > Simulink Project > Discard Local Changes and Release Locks**.

To abandon all local changes, in Simulink Project select all the files in the Modified Files list, then right-click and select **Discard Local Changes and Release Locks**.

With Git, right-click a file and select **Source Control > Revert Local Changes**. Git does not have locks. To remove all local changes, click **Branches** in the **Git** pane and click **Revert to Head**.

### Revert a File to a Specified Revision

- 1 Right-click a file and select **Source Control > Revert using SVN** or **Source Control > Revert using Git**.
- 2 In the Revert Files dialog box, choose a revision to revert to. Select a revision to view information about the change such as the author, date, log message, and the list of modified files also in the change set.
- 3 Click **Revert**.

Simulink Project reverts the selected file.

- 4 If you revert a file to an earlier revision and then make changes, you cannot commit the file until you resolve the conflict with the repository history.

With SVN, if you try to commit the file, you see a message that it is out of date. Before you can commit the file, you must update its revision up to the current HEAD revision. click **Update** in the source control section on the Simulink Project tab.

The project marks the file as conflicted because you have made changes to an earlier version of the file than the version in the repository.

- 5 With either SVN or Git, to examine conflicts, right-click and select **View Conflicts**.

Decide how to resolve the conflict or to keep your changes to the reverted file. See “Resolve Conflicts” on page 19-64.

- 6 After you have resolved the conflict, mark the conflict resolved, either by using the merge tool or manually by right-clicking the file and selecting **Source Control > Mark Conflict Resolved**.
- 7 Select the Modified Files view and click **Commit**.

## Revert the Project to a Specified Revision

With SVN, inspect the project revision information by clicking **Show Log** in the in Source Control section on the Simulink Project tab. In the Log dialog box, each revision in the list is a change set of modified files. Select a revision to view information about the change such as the author, date, log message and the list of modified files.

To revert the project:

- 1 On the Simulink Project tab, in the Source Control section, click **Revert Project**.
- 2 In the Revert Files dialog box, choose a revision to revert to.

Each revision in the list is a change set of modified files. Select a revision to view information about the change such as the author, date, log message and the list of modified files.

- 3 Click **Revert**.

Simulink Project displays progress messages in the SVN pane as it restores the project to the state it was in when the selected revision was committed. Depending on the change set you selected, all files do not necessarily have a particular revision number or matching revision numbers. For example, if you revert a project to revision 20, all files will show their revision numbers when revision 20 was committed (20 or lower).

With Git, you can switch branches. See “Branch and Merge Files with Git” on page 19-59.

### **Related Examples**

- “Resolve Conflicts” on page 19-64

## Pull, Push, and Fetch Files with Git

### In this section...

“Pull and Push” on page 19-54

“Pull, Fetch, and Merge” on page 19-55

“Push Empty Folders” on page 19-58

### Pull and Push

Use this workflow to work with a Git project connected to a remote repository. With Git, there is a two-step workflow: commit local changes, and then push to the remote repository. In Simulink Project, the only access to the remote repository is through the **Pull**, **Push**, and **Fetch** buttons. All other actions use the local repository (such as **Check for Modifications**, **Compare to Ancestor**, and **Commit**). This diagram represents the Git workflow.

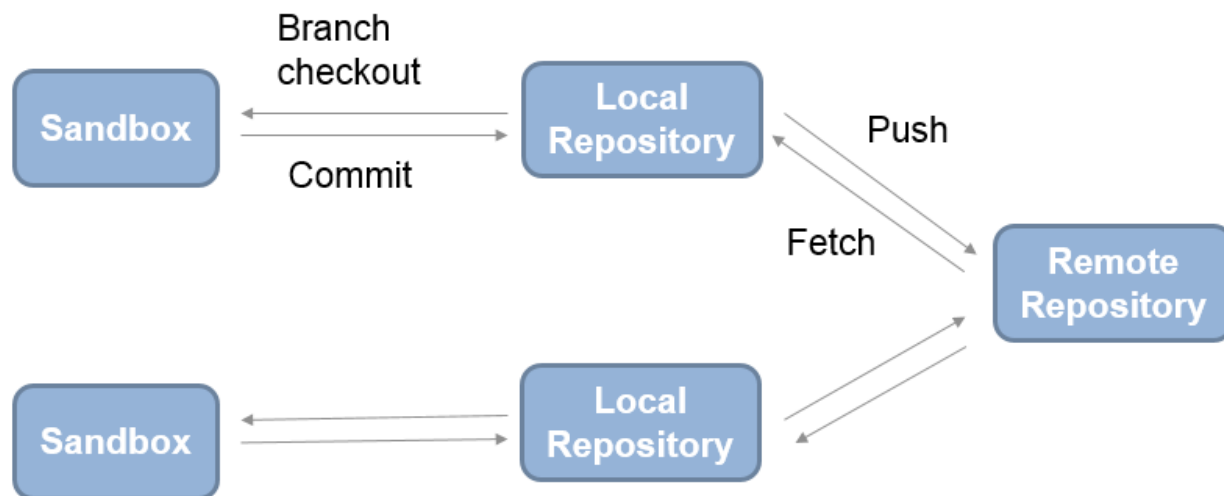

- 1 To get the latest changes, on the Simulink Project tab, in the Source Control section, click **Pull**. Pull fetches the latest changes and merges them into your current branch.



---

**Note:** Before you can merge, you must install command-line Git on your system path and register model files as binary to prevent Git from inserting conflict markers. See “Install Command-Line Git Client” on page 19-22.

---

- 2 To create branches to work on, on the Simulink Project tab, in the Source Control section, click **Branches**. Create branches in the Branches dialog box, as described in “Branch and Merge Files with Git” on page 19-59.
- 3 When you want to commit changes, select the Modified Files view and click **Commit**. The changes are committed to your current branch in your local repository. Check the **Git** pane for information about the current branch. You see the message **Ahead** when you commit local changes that have moved ahead of the remote tracking branch.

Current branch: master  
Branch status: SAFE  
Ahead of /origin/master

- 4 To send your local commits to the remote repository, on the Simulink Project tab, in the Source Control section, click **Push**.
- 5 A message appears if you cannot push your changes directly because the repository has moved on. Click **Fetch** to fetch changes from the remote repository. Merge branches and resolve conflicts, and then you can push your changes. See “Pull, Fetch, and Merge” on page 19-55.

## Pull, Fetch, and Merge

Use **Fetch** to get changes and merge manually. Use **Pull** instead to fetch the latest changes and merge them into your current branch.

---

**Note:** Before you can merge branches, you must install command-line Git on your system path and register model files as binary to prevent Git from inserting conflict markers. See “Install Command-Line Git Client” on page 19-22.

---

Pull fetches the latest changes and merges them into your current branch. If you are not sure what is going to come in from the repository, use fetch instead to examine the changes, and then merge the changes manually.

Pull might fail if you have conflicts. With a complicated change you might want to create a branch from the origin, make some compatibility changes, then merge that branch into the main tracking branch.

To fetch changes from the remote repository, click **Fetch** on the Simulink Project tab.

Fetch updates all of the origin branches in the local repository.

---

**Note:** When you click **Fetch**, your sandbox files are not changed. To see others' changes, you need to merge in the origin changes to your local branches.

---

Check the Git pane for information about your current branch relative to the remote tracking branch in the repository. When you see the message **Behind**, you need to merge in changes from the repository to your local branch.

For example, if you are on the master branch and want to get changes from the master branch in the remote repository:

- 1 Click **Fetch**.

Observe the message in the Git pane, **Behind /origin/master**. You need to merge in the changes from the repository to your local branch, using **Branches**.

```
Current branch: master  
Branch status: SAFE  
Behind /origin/master
```

- 2 Click **Branches**.
- 3 In the Branches dialog box, in the **Branches** list, select **origin/master**.

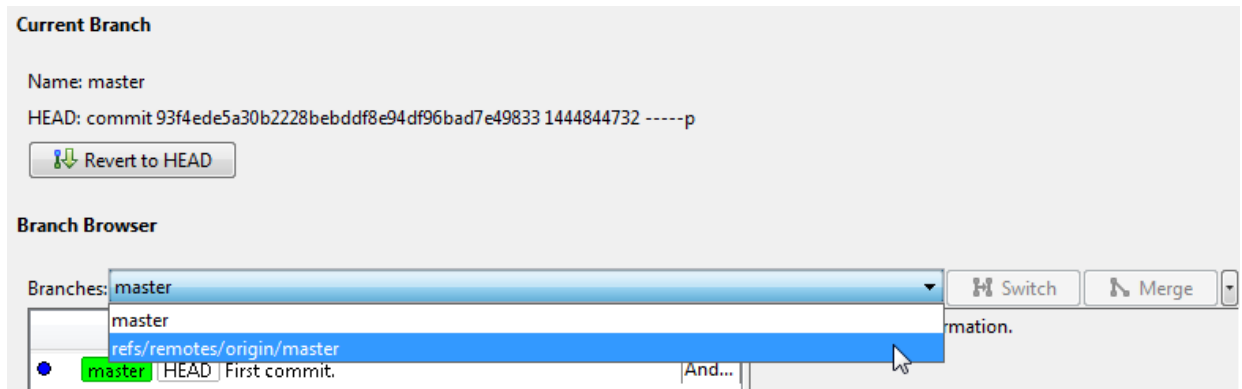

- 4 Click **Merge**. This merges the origin branch changes into the master branch in your sandbox.

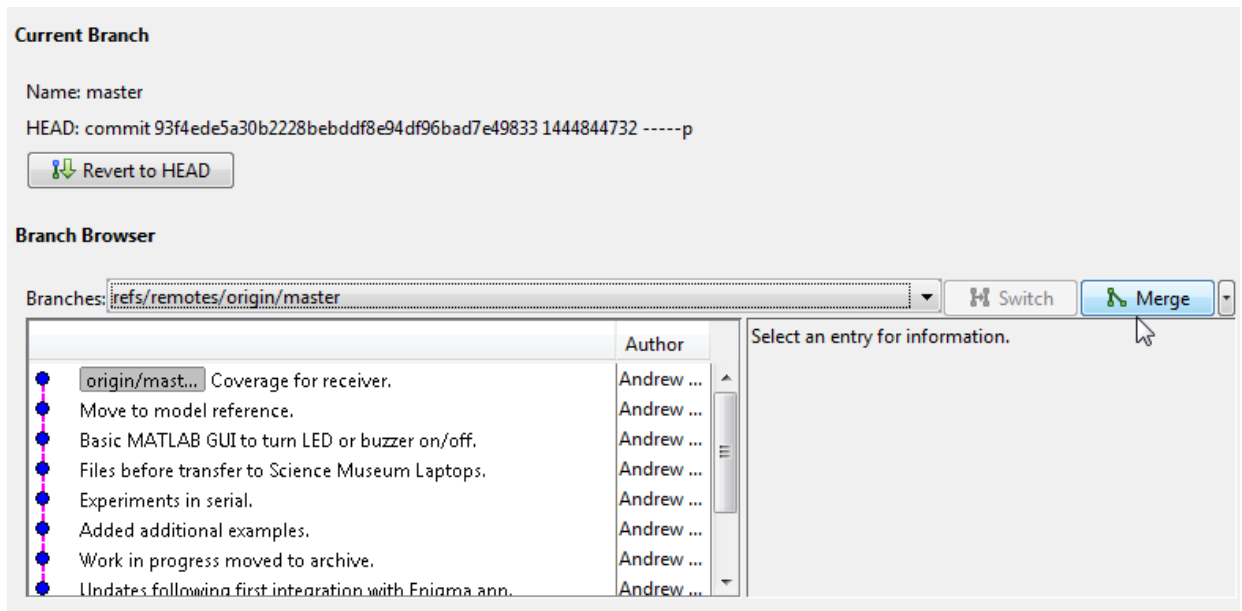

- 5 Close the Branches dialog box. Observe the message in the Git pane now says **Coincident with /origin/master**. You can now view the changes fetched and merged from the remote repository in your local sandbox files.

When you fetch and merge, you might need to resolve conflicting changes. If the branch merge causes a conflict that Git cannot resolve automatically, an error dialog box reports that automatic merge failed. Resolve the conflicts before proceeding. See “Resolve Conflicts” on page 19-64.

## Push Empty Folders

Using Git, you cannot add empty folders to source control, so you cannot select **Push** and then clone an empty folder. You can create an empty folder in Simulink Project, but if you push changes and then sync a new sandbox, then the empty folder does not appear in the new sandbox. You can instead run **Check Project** which creates the empty folder for you.

Alternatively, to push empty folders to the repository for other users to sync, create a `gitignore` file in the folder and then push your changes.

## Related Examples

- “Set Up Git Source Control” on page 19-20
- “Branch and Merge Files with Git” on page 19-59
- “Resolve Conflicts” on page 19-64

## More About

- “About Source Control with Projects” on page 19-2

## Branch and Merge Files with Git

### In this section...

“Create a Branch” on page 19-59

“Switch Branch” on page 19-61

“Merge Branches” on page 19-61

“Revert to Head” on page 19-62

“Delete Branches” on page 19-62

### Create a Branch

- 1 In a Simulink Project using Git source control, click **Branches** on the Simulink Project tab. The Branches dialog box appears, where you can view, switch, create, and merge branches.

---

**Tip:** You can inspect information about each commit node. Select a node in the Branch Browser diagram to view the author, date, commit message, and changed files.

---

The **Branches** pane in this figure shows an example branch history.

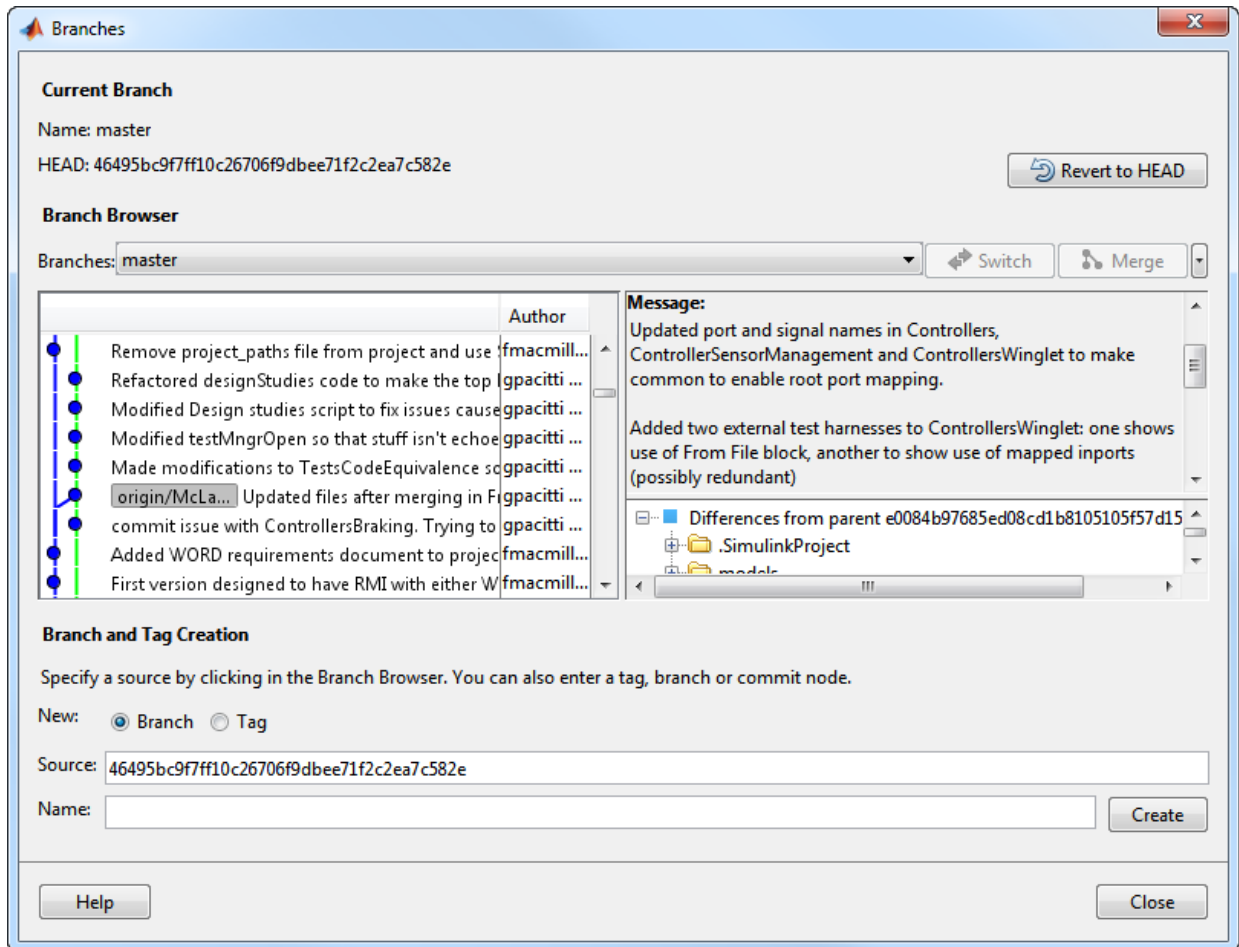

- 2 Select a source for the new branch. Click a node in the Branch Browser diagram, or enter a unique identifier in the Source text box. You can enter a tag, branch name, or a unique prefix of the SHA1 hash (for example, 73c637 to identify a specific commit). Leave the default to create a branch from the head of the current branch.
- 3 Enter a name in the **Branch name** text box and click **Create**.
- 4 To work on the files on your new branch, switch your project to the branch.

In the **Branches** drop-down list, select the branch you want to switch to and click **Switch**.

- 5 Close the Branches dialog box to return to Simulink Project and work on the files on your branch.

For next steps, see “Pull, Push, and Fetch Files with Git” on page 19-54.

## Switch Branch

- 1 In Simulink Project, click **Branches**.
- 2 In the Branches dialog box, select the branch you want to switch to in the **Branches** list and click **Switch**.
- 3 Close the Branches dialog box to return to Simulink Project and work on the files on the selected branch.

## Merge Branches

Before you can merge branches, you must install command-line Git on your system path and register model files as binary to prevent Git from inserting conflict markers. See “Install Command-Line Git Client” on page 19-22.

---

**Tip:** After you use **Fetch**, you must merge. See “Pull, Fetch, and Merge” on page 19-55.

---

To merge any branches:

- 1 In Simulink Project, click **Branches**.
- 2 In the Branches dialog box, from the **Branches** drop-down list, select a branch you want to merge into the current branch, and click **Merge**.
- 3 Close the Branches dialog box to return to Simulink Project and work on the files on the current branch.

If the branch merge causes a conflict that Git cannot resolve automatically, an error dialog box reports that automatic merge failed. The Branch status in the **Git** pane displays **MERGING**. Resolve the conflicts before proceeding.

---

**Caution:** Do not move or delete files outside of MATLAB because this can cause errors on merge.

---

### Keep Your Version

- 1 To keep your version of the file, right-click the file and select **Mark Conflict Resolved**. The Branch status in **Git** pane displays `MERGE_RESOLVED`. The Modified Files list is empty, because you have not changed any file contents. The local repository index version and your branch version are identical.
- 2 Click **Commit** to commit your change that marks the conflict resolved.

### Compare Branch Versions

If you merge a branch and there is a conflict in a model file, Git marks the file as conflicted and does not modify the contents. Right-click the file and select **View Conflicts**. Simulink Project opens a comparison report showing the differences between the file on your branch and the branch you want to merge into. Decide how to resolve the conflict. See “Resolve Conflicts” on page 19-64.

### Revert to Head

To remove all local changes, in the Branches dialog box, click **Revert to Head**.

### Delete Branches

- 1 In the Branches dialog box, from the **Branches** drop-down list, select a branch you want to delete. You cannot delete the current branch.
- 2 On the far right, click the down arrow and select **Delete Branch**.

---

**Caution:** You cannot undo deleting a branch.

---

### Related Examples

- “Set Up Git Source Control” on page 19-20
- “Pull, Push, and Fetch Files with Git” on page 19-54
- “Resolve Conflicts” on page 19-64



## **More About**

- “About Source Control with Projects” on page 19-2

## Resolve Conflicts

### In this section...

“Resolve Conflicts” on page 19-64

“Merge Text Files” on page 19-66

“Merge Models” on page 19-67

“Extract Conflict Markers” on page 19-67

## Resolve Conflicts

If you and another user change the same file in different sandboxes or on different branches, a conflict message appears when you try to commit your modified files. Extract conflict markers if necessary, compare the differences causing the conflict, and resolve the conflict.

- 1 Look for conflicted files in the Modified Files view.

Identify conflicted folder contents using source control summary status. Folders display rolled-up source control status. This makes it easier to locate changes in files, particularly conflicted files. You can hover over the source control status for a folder to view a tooltip displaying how many files inside are modified, conflicted, added or deleted.



---

**Tip:** Use the List view  to view files without needing to expand folders.

---

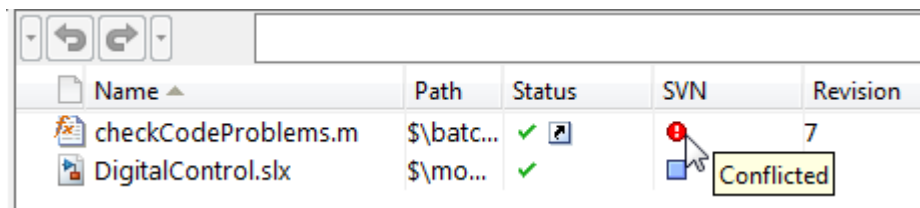
- 2 Check the source control status column (**SVN** or **Git**) for files with a red warning symbol, which indicates a conflict.



Name	Path	Status	SVN	Revision
checkCodeProblems.m	\$_\batc...	✓		7
DigitalControl.slx	\$_\mo...	✓		

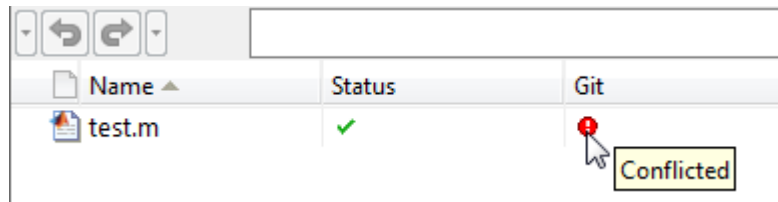

- 3 Right-click the conflicted file and select **View Conflicts** to compare versions.
- 4 Examine the conflict. Simulink Project opens a comparison report showing the differences between the conflicted files.
  - For SVN, the comparison shows the differences between the file and the version of the file in conflict.
  - For Git, the comparison shows the differences between the file on your branch and the branch you want to merge into.
  - For model files, see “Merge Models” on page 19-67.
- 5 Use the comparison report to determine how to resolve the conflict.

To resolve conflicts you can:

- Use the report to merge changes between revisions.
- Decide to overwrite one set of changes with the other.
- Make changes manually from the project by editing files, changing labels, or editing the project description.

For details on using the Comparison Tool to merge changes between revisions, see “Merge Text Files” on page 19-66 and “Merge Models” on page 19-67.

- 6 When you have resolved the changes and want to commit the version in your sandbox, in Simulink Project, right-click the file and select **Source Control > Mark Conflict Resolved**. You can use the merge tool to mark the conflict resolved, or you can choose to manually mark the conflict resolved in the project.

For Git, the Branch status in the **Git** pane changes from MERGING to SAFE.

- 7 Select the Modified Files view and click **Commit**.

## Merge Text Files

When comparing text files, you can merge changes from one file to the other. Merging changes is useful when resolving conflicts between different versions of files.

Conflict markers appear in a text comparison report like this:

```
<<<<<<< .mine
```

If your comparison report contains conflict markers, extract them before merging, as described in “Extract Conflict Markers” on page 19-67.

---

**Tip:** You can merge only from left to right. When comparing to another version in source control, the right file is the version in your sandbox. The left file is either a temporary copy of the previous version or another version causing a conflict (e.g., *filename\_theirs*). Observe the file paths of the left and right file at the top of the comparison report. Merge differences from the left (temporary copy) file to the right file to resolve conflicts.

---

- 1 In the Comparison Tool report, select a difference in the report and click **Merge**. The selected difference is copied from the left file to the right file.

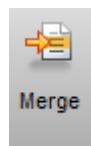

Merged differences display gray row highlighting and a green merge arrow.

```
1 function [len,dims] = lengthofline(hline)      function [len,dims] = lengthofline(hline)  2
```

The merged file name at the top of the report displays the dirty flag (*filename.m\**) to show you that the file contains unsaved changes.

- 2 Click **Save Merged File** to save the file on the right. Check the file path of the right file in the comparison report. (To save to a different file, select **Save Merged File > Save Merged File As**). To resolve conflicts, save the merged file over the conflicted file.
- 3 If you want to inspect the files in the editor, click the line number links in the report.

---

**Note:** If you make any further changes in the editor, the comparison report does not update to reflect changes and report links can become incorrect.

---

- 4 After merging to resolve conflicts, mark the conflict resolved and commit the changes, as described in “Resolve Conflicts” on page 19-64.

## Merge Models

In the Comparison Tool report, you can merge changes between revisions. To use this capability on models, you must have Simulink Report Generator installed. For details, see “Merge Simulink Models from the Comparison Report” (Simulink Report Generator).

After merging to resolve conflicts, the merge tool can mark the conflict resolved for you, or you can choose to manually mark the conflict resolved. Then commit the changes, as described in “Resolve Conflicts” on page 19-64.

## Extract Conflict Markers

- “What Are Conflict Markers?” on page 19-67
- “Extract Conflict Markers” on page 19-68

### What Are Conflict Markers?

Source control tools can insert conflict markers in files that you have not registered as binary (e.g., text files). You can use Simulink Project tools to extract the conflict markers and compare the files causing the conflict. This process helps you to decide how to resolve the conflict.

---

**Caution:** Register model files with source control tools to prevent them from inserting conflict markers and corrupting models. See “Register Model Files with Source Control Tools” on page 19-10. If your model already contains conflict markers, the project tools can help you to resolve the conflict, but only if you open the model from the project. Opening a model that contains conflict markers from the Current Folder or from a file explorer can fail because Simulink does not recognize conflict markers.

---

Conflict markers have the following form:

```
<<<<<<["mine" file descriptor]
["mine" file content]
=====
["theirs" file content]
<<<<<<["theirs" file descriptor]
```

If you try to open a file marked conflicted that contains conflict markers, the Conflict Markers Found dialog box opens. Follow the prompts to fix the file by extracting the conflict markers. After you extract the conflict markers, resolve the conflicts as described in “Resolve Conflicts” on page 19-64.

To view the conflict markers, in the Conflict Markers Found dialog box, click **Load File**. Do not try to load model files, because Simulink does not recognize conflict markers. Instead, click **Fix File** to extract the conflict markers.

By default, the project checks only conflicted files for conflict markers. You can change this preference to check all files or no files. Click **Preferences** in the Simulink Project tab to change the setting.

### Extract Conflict Markers

When you open a conflicted file or select **View Conflicts**, the project checks files for conflict markers and offers to extract the conflict markers. The project checks only conflicted files for conflict markers unless you change your preferences setting.

However, some files that are not marked conflicted can still contain conflict markers. This can happen if you or another user marked a conflict resolved without removing the conflict markers and then committed the file. If you see conflict markers in a file that is not marked conflicted, you can remove the conflict markers.

- 1 In Simulink Project, right-click the file and select **Source Control > Extract Conflict Markers to File**.
- 2 Leave the default option to copy the “mine” revision over the conflicted file. Leave the **Compare** check box selected. Click **Extract**.
- 3 Use the Comparison Tool report as usual to continue to resolve the conflict.

### Related Examples

- “Register Model Files with Source Control Tools” on page 19-10
- “Merge Simulink Models from the Comparison Report” (Simulink Report Generator)

## Work with Derived Files in Projects

Best practice is to omit derived and temporary files from your project or exclude them from source control. Use **Check Project** in the Precommit Actions pane or the **Simulink Project** tab to check the integrity of the project. If you add the `slprj` folder to a project, the project checks advise you to remove this from the project and offer to make the fix.

Best practice is to exclude derived files, such as `.mex*`, the contents of the `slprj` folder, `sccprj` folder, or other code generation folders from source control, because they can cause problems. For example:

- With a source control that can do file locking, you can encounter conflicts. If `slprj` is under source control and you generate code, most of the files under `slprj` change and become locked. Other users cannot generate code because of file permission errors. The `slprj` folder is also used for simulation via code generation (for example, with model reference or Stateflow), so locking these files can have an impact on a team. The same problems arise with binaries, such as `.mex*`.
- Deleting `slprj` is often required. However, deleting `slprj` causes problems such as “not a working copy” errors if the folder is under some source control tools (for example, SVN).
- If you want to check in the generated code as an artifact of the process, it is common to copy some of the files out of the `slprj` cache folder and into a separate location that is part of the project. That way, you can delete the temporary cache folder when you need to. See `packNGo` to discover the list of generated code files, and use the project API to add to the project with appropriate metadata.
- The `slprj` folder can contain many small files. This can affect performance with some source control tools when each of those files is checked to see if it is up-to-date.

### See Also

`packNGo` | `simulinkproject`

### Related Examples

- “Add Files to the Project” on page 16-20
- “Run Project Checks” on page 19-47

## Customize External Source Control to Use MATLAB for Diff and Merge

You can customize external source control tools to use the MATLAB Comparison Tool for diff and merge. If you want to compare MATLAB files such as live scripts, MAT, SLX, or MDL files from your source control tool, then you can configure your source control tool to open the MATLAB Comparison Tool.

MATLAB Comparison Tool provides useful merge tools for MathWorks files and is compatible with all popular software configuration management and version control systems.

Set up your source control tool to use MATLAB as the application for diff and merge for the file extensions you want, for example, `.mlx`, `.mat`, `.slx`, or `.mdl`, by following these steps:

- 1 To get the required file paths and set the preference to reuse open MATLAB sessions, run this command in MATLAB:

```
comparisons.ExternalSCMLink.setup()
```

This command sets the MATLAB preference, under **Comparison**, called **Allow external source control tools to use open MATLAB sessions for diffs and merges**.

The command also displays the file paths you will copy and paste into your source control tool setup:

- On Windows:

```
matlabroot\bin\win64\mlDiff.exe
```

```
matlabroot\bin\win64\mlMerge.exe
```

- On Linux:

```
matlabroot/bin/glnxa64/mlDiff
```

```
matlabroot/bin/glnxa64/mlMerge
```

On Mac:

```
matlabroot/bin/maci64/mlDiff
```



```
matlabroot/bin/maci64/mlMerge
```

Where *matlabroot* is replaced with the full path to your installation, for example, C:\Program Files\MATLAB\R2016b.

## 2 Set up diff.

- a** In the MATLAB Command Window, copy the file path to `mlDiff`, for example, C:\Program Files\MATLAB\R2016b\bin\win64\mlDiff.exe.
- b** In your source control tool, locate the diff setting, and add an entry to specify what to do with a particular file extension (for example, `.slx`). Paste in the file path to `mlDiff` that you copied from the MATLAB Command Window.
- c** After the path to the script, or in the arguments box, add arguments to specify the input files. Look up the argument names specific to your source control tool. Specify the inputs for diffs, in this order: *leftFile*, *rightFile*.

For example, for Tortoise SVN:

```
"C:\Program Files\MATLAB\R2016b\bin\win64\mlDiff.exe" %base %mine
```

For Perforce® P4V:

```
"C:\Program Files\MATLAB\R2016b\bin\win64\mlDiff.exe" %1 %2
```

## 3 Set up merge.

- a** In the MATLAB Command Window, copy the file path to `mlMerge`.
- b** In your source control tool, locate the merge setting, and add an entry to specify what to do with a particular file extension (for example, `.slx`). Paste in the file path to `mlMerge` that you copied from the MATLAB Command Window.
- c** After the path to the script, or in the arguments box, add arguments to specify the input files. Look up the argument names specific to your source control tool. Specify the inputs for merges, in this order: *base*, *mine*, *theirs*, and *merged* target file.

For example, for Tortoise SVN:

```
"C:\Program Files\MATLAB\R2016b\bin\win64\mlMerge.exe" %base %mine %theirs %merged
```

For Perforce P4V:

```
"C:\Program Files\MATLAB\R2016b\bin\win64\mlMerge.exe" %b %2 %1 %r
```

- 4** After this setup, when you use diff or merge, your external source control tool opens a report in MATLAB Comparison Tool. Use the report to view changes and resolve merges.

Your diff and merge operations use open MATLAB sessions if available, and only open MATLAB when necessary. The comparison only uses the specified MATLAB installation.

### **Related Examples**

- “Comparing Text and Live Scripts” (MATLAB)
- “Comparing MAT-Files” (MATLAB)
- “Comparing Variables” (MATLAB)
- “Merge Simulink Models from the Comparison Report” (Simulink Report Generator)

# Project Reference

---

- “Componentization Using Referenced Projects” on page 20-2
- “Add or Remove a Reference to Another Project” on page 20-5
- “View or Run Referenced Project Files” on page 20-7
- “Open a Referenced Project” on page 20-8
- “Extract a Folder to Create a Referenced Project” on page 20-9
- “Manage Referenced Project Changes Using Checkpoints” on page 20-11

## Componentization Using Referenced Projects

For a large modeling project, organizing the project into components facilitates:

- Component reuse
- Modular, team-based development
- Unit testing
- Independent release of components

Simulink Project supports large-scale project componentization by allowing you to reference other projects from a parent project. A collection of parent and referenced projects constitutes a project reference hierarchy. Project referencing provides these benefits:

- A parent project has access to a referenced project's project paths, entry-point shortcuts, and source control information. For example, from a parent project, you can use referenced project shortcuts to view and run files that belong to the referenced project.
- Through a referenced project, your team can develop a component independent of other components.
- In a referenced project, you can test the component separately.
- In a parent project, you can set a checkpoint and then compare the referenced project against the checkpoint to detect any changes.

This project hierarchy illustrates the use of parent and referenced projects as components of a large project.

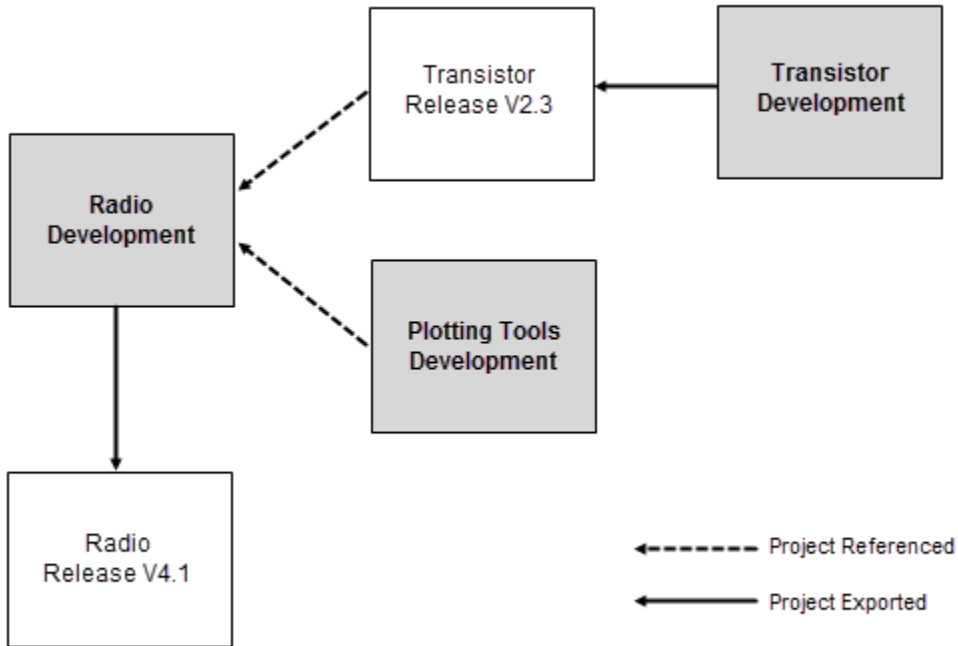

Through the Transistor Development project, a team independently creates and tests a library of blocks. The team makes the library available to other developers by exporting release versions, for example, version 2.3.

Through the Radio Development project, another team develops and tests the Radio system. This team requires:

- Version 2.3 of the Transistor component. The team sets up the Radio Development project to reference the Transistor Release V2.3 project.
- Tools to plot signals, for example, MATLAB files that are not distributed to customers. The team sets up the Radio Development project to reference the Plotting Tools Development project.

When the Radio system is ready for customers, the team exports a release version, for example, version 4.1.

### **Related Examples**

- “Componentization Guidelines” on page 15-29
- “Organize Large Modeling Projects” on page 16-2
- “Design Partitioning” on page 21-2
- “Add or Remove a Reference to Another Project” on page 20-5
- “View or Run Referenced Project Files” on page 20-7
- “Open a Referenced Project” on page 20-8
- “Extract a Folder to Create a Referenced Project” on page 20-9
- “Manage Referenced Project Changes Using Checkpoints” on page 20-11
- Airframe Project Reference Example

## Add or Remove a Reference to Another Project

Add new components to your project by referencing other projects. The addition of referenced projects creates a project hierarchy. When Simulink Project loads a referenced project in a project hierarchy, it:

- Adds project paths from the referenced project to the MATLAB search path.
- Runs startup shortcuts from the referenced project.

To reference a project:

- 1 On the Simulink Project tab, in the **Environment** section, click **References**.
- 2 In the Referenced Projects dialog box, click the **Add a reference to another project** button .

- If your project hierarchy has a well-defined root relative to your project root, for example, a folder under source control, select **Add Relative Reference**.
- If the project you want to reference is in a location accessible to your computers, for example, a network drive, select **Add Absolute Reference**.

- 3 Using the Open dialog box, navigate to the project location and select the project folder.

On the **Project Shortcuts** tab, the **Referenced Projects** section displays the newly added project.

To remove a referenced project from your project hierarchy:

- 1 On the Simulink Project tab, in the **Environment** section, click **References**.
- 2 In the Referenced Projects dialog box, select the project that you want to remove and click the **Remove reference to selected project** button .

### Related Examples

- “Componentization Using Referenced Projects” on page 20-2
- “View or Run Referenced Project Files” on page 20-7
- “Open a Referenced Project” on page 20-8
- “Extract a Folder to Create a Referenced Project” on page 20-9

- Airframe Project Reference Example



## View or Run Referenced Project Files

In a Simulink Project hierarchy, from a parent project, use referenced project shortcuts to view and run files that belong to the referenced project.

- 1 Within the referenced project, create shortcuts for the files that you want to view or run from the parent project.
- 2 From the parent project, on the **Project Shortcuts** tab, in the **Referenced Projects** section, click the referenced project button arrow.

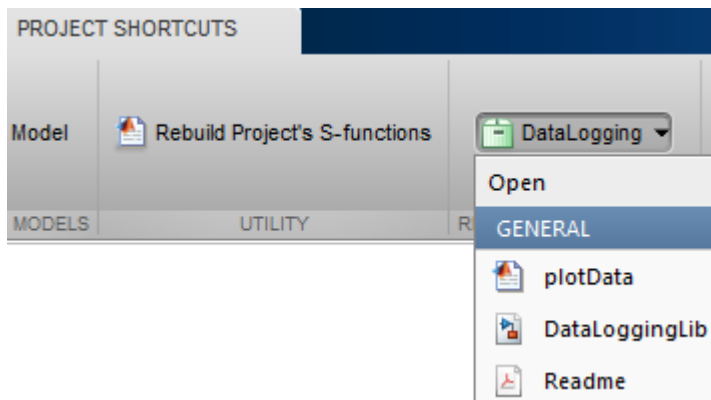

- 3 From the list, select the file that you want to view or run.

### Related Examples

- “Create Shortcuts to Frequent Tasks” on page 16-34
- “Componentization Using Referenced Projects” on page 20-2
- “Add or Remove a Reference to Another Project” on page 20-5
- “Extract a Folder to Create a Referenced Project” on page 20-9
- Airframe Project Reference Example

## Open a Referenced Project

In Simulink Project, you can open a referenced project from a parent project.

---

**Note:** Opening a referenced project closes the parent project.

---

- 1 On the **Project Shortcuts** tab, in the **Referenced Projects** section, click the referenced project button arrow.

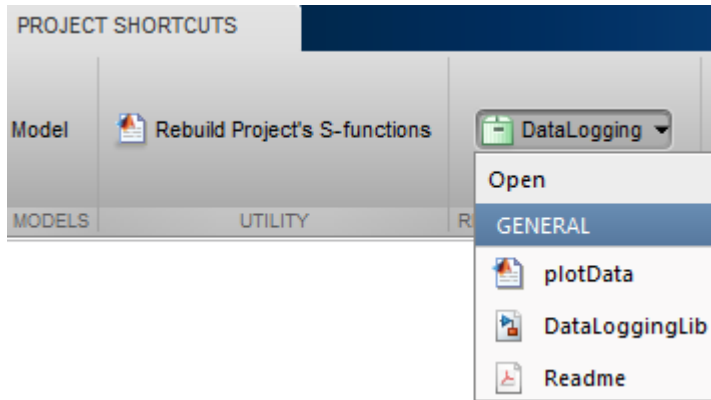

- 2 From the list, select **Open**.
- 3 In the Warning dialog box, click **Continue**.

### Related Examples

- “Componentization Using Referenced Projects” on page 20-2
- “Add or Remove a Reference to Another Project” on page 20-5
- “Extract a Folder to Create a Referenced Project” on page 20-9
- Airframe Project Reference Example

## Extract a Folder to Create a Referenced Project

In Simulink Project, you can partition a large project into components through the use of project references.

Consider the Airframe example project. Suppose you create a folder `Trial` and carry out development work within the folder. You produce:

- Shortcuts to a Simulink library, a MATLAB file, and a `Readme` document
- Design and source code folders
- Data files

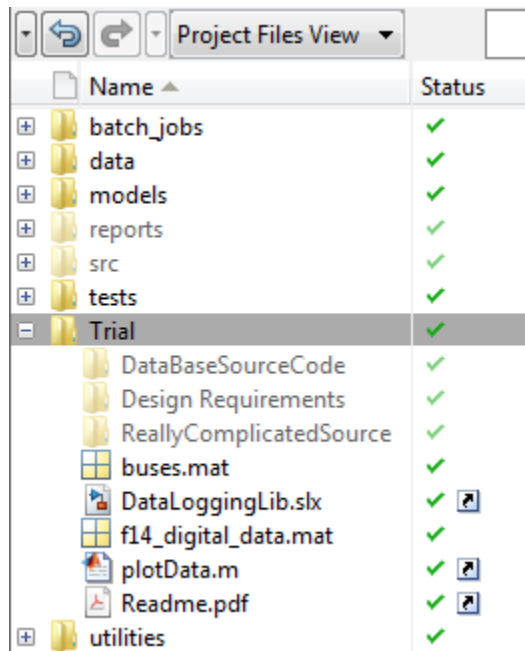

For easier management, you want to convert the `Trial` folder into a separate component. In addition, you want access to the folder contents, for example, shortcuts to key files. To fulfill these requirements, extract the folder from the project and convert the folder into a referenced project.

- 1 With `Project Files View` selected, right-click the `Trial` folder and select **Extract to Referenced Project**.

- 2 In the Extract Folder to New Project dialog box, specify these options:
  - **New Project Name** — For example, DataLogging.
  - **New Project Location** – For example, C:\Work\DataLogging.
  - **Reference Type** – The default is **Relative** reference. Use the default if you specify the new project location with reference to the current project root. If you specify the full path for the new location, which is, for example, on a network drive, select **Absolute** reference.
- 3 Click **More Options**. If you want to disable any of the default content migration actions, clear the corresponding check box.
- 4 Click **Extract**.
- 5 In the Warning dialog box, click **Continue**.

The folder **Trial** and its contents are removed from the project. On the **Project Shortcuts** tab, the **Referenced Projects** section displays a new **DataLogging** button.

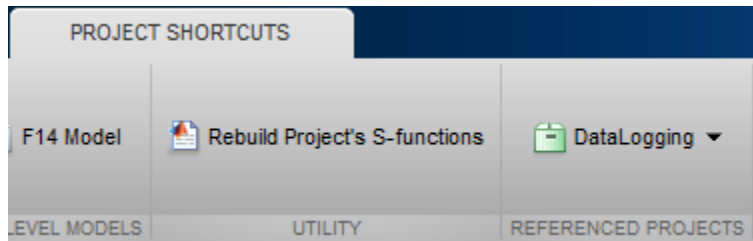

## Related Examples

- “Componentization Using Referenced Projects” on page 20-2
- “Add or Remove a Reference to Another Project” on page 20-5
- “View or Run Referenced Project Files” on page 20-7
- “Open a Referenced Project” on page 20-8
- Airframe Project Reference Example

## Manage Referenced Project Changes Using Checkpoints

In Simulink Project, you can create a checkpoint for a referenced project. You can then compare the referenced project against the checkpoint to detect any changes.

- 1 In a Simulink Project containing referenced projects, on the Simulink Project tab, click **References**.
- 2 In the Referenced Projects dialog box, select a referenced project, and click **Set Checkpoint**.

The Referenced Projects dialog box displays the timestamp of the checkpoint.

- 3 In future, to detect changes in the referenced project, click **Show Changes** in the Referenced Projects dialog box. The Difference to Checkpoint dialog box shows files that have changed on disk since you set the checkpoint.

### Related Examples

- “Componentization Using Referenced Projects” on page 20-2
- Airframe Project Reference Example



# Large-Scale Modeling

---

- “Design Partitioning” on page 21-2
- “Interface Design” on page 21-13
- “Configuration Management” on page 21-18

## Design Partitioning

### In this section...

“When to Partition a Design” on page 21-2

“When Not to Partition a Design” on page 21-3

“Plan for Componentization in Model Design” on page 21-4

“Guidelines for Component Size and Functionality” on page 21-4

“Choose Components for Team-Based Development” on page 21-8

“Partition an Existing Design” on page 21-10

“Manage Components Using Libraries” on page 21-11

### When to Partition a Design

Partition a design when it becomes too complex for one person to know all of the details. Complexity increases with design size and team size, for example,

- Design size and complexity:
  - Thousands of blocks
  - Hundreds of logical decisions
  - Hundreds of inputs and outputs
  - Hundreds of times larger industry examples in some cases
  - Multiple variant configurations of the same functionality
- Team integration:
  - Multiple people working on the design
  - People located in different places
  - People from different companies

Partitioning your design into components helps you to work with large-scale designs. Partitioning a design into components gives modularity to help you reduce complexity, collaborate on development, test and reuse components, and to succeed with large-scale model-based design. Component-based modeling helps:

- Enable efficient and robust system development.



- Reduce overall design complexity by solving smaller problems.
- Gain performance benefits that scale.
- Reuse components across multiple projects.
- Facilitate collaboration
  - Partition algorithms, physical models, and tests. Define architecture in terms of structural and functional partitioning of the design using defined interfaces.
  - Collaborate with teams across organizational boundaries on product development. Teams can elaborate individual components independently to do plant modeling, algorithm design, and developing of test harnesses.
  - Manage design with source control tools.
- Improved iteration, elaboration, and verification workflows
  - Iterate faster via more efficient testing and reuse.
  - Eliminate retesting for unchanged components.
  - Reuse environment models and algorithm designs in different projects.
  - Create variants of designs.
  - Elaborate components independently through well-defined interfaces.
  - Manage design evolution with configuration management tools.

Component-based modeling requires:

- Mechanisms for partitioning models and specifying interfaces
- Tools and processes for managing data, models, and environment

Use the following techniques for component-based modeling.

## When Not to Partition a Design

Componentization provides benefits for large-scale designs, but is not needed for small designs. Partitioning your design into components requires design work and can increase time taken to update diagrams. Use separate components only when your design is large enough to benefit from componentization.

To decide whether your design needs partitioning, see the recommendations in “Guidelines for Component Size and Functionality” on page 21-4.

## Plan for Componentization in Model Design

After models grow large and complex over time, it is difficult to split them into components to allow multiple engineers to work on them in parallel. Splitting a Simulink model into components is easier if the model is designed for componentization from the start. Designing for componentization in the first place can help you avoid these difficulties:

- If a single engineer develops a model from the bottom up, adding blocks and grouping them into subsystems as the model complexity increases, it is hard to later split the model into components. The subsystems within the model are often “virtual” and nonatomic. When you convert these to atomic subsystems and then to model reference components, you can introduce unwanted algebraic loops that are hard to diagnose and solve.
- Subsystems grown over time do not always represent the best way to partition the model. “Best” here might mean the most useful structure for reusable components in other models, or for generating code that integrates with legacy functionality, or for performing Hardware-in-the-Loop tests, etc.
- If you try to expand to parallel development without componentizing models, it is difficult to share work in teams without time-consuming and error-prone merging of subsystems.

These problems are analogous to taking a large piece of code (C, Java, or MATLAB code) and trying to break it down into a number of separate functions. Significant effort is required and can require extensive modifications to some parts of the code, if the code was not designed to be modular in the first place. The same is true for Simulink models.

Lack of componentization causes common failure modes when trying to place Simulink models into configuration management as they grow and you want more than one engineer to work on it in parallel. The best way to avoid these issues is to design for components from the start. You can use the following features of Simulink to design a model suitable for componentization.

If you already have a design that you want to divide into components, see “Partition an Existing Design” on page 21-10.

## Guidelines for Component Size and Functionality

To set up your project for a team to work on, consider the following model architecture guidelines for components. Useful components:

- Have well-defined interface I/O boundaries.
- Perform a defined set of functions (actions), defined by requirements.
- Form part of a larger system.
- Have the “right” size:
  - Large enough to be reusable
  - Small enough to be tested
  - Only one engineer is likely to want to edit each model at a time

The right size can depend on team size. You can have larger components if only one person is working on each, but if you need to share components between several people, you probably need to divide the design into smaller logical pieces. This aids two goals: understanding the design, and reducing file contention and time spent on merging.

Recommendations:

- In most cases, if you have fewer than 100 blocks, do not divide the design into components. Instead, use subsystems if you want to create a visual hierarchy. For example, the example model `vdp` is not large enough to benefit from componentization.
- If you have 500–1000 blocks, consider creating a model reference to contain that component in a separate file. The cost of verification can reduce the size for components. For example, if you have a small component of 100 blocks with high testing costs and frequent changes, consider separating that component into a separate file to make verification easier.

Consider dividing the model based on:

- Physical components (e.g., plant and controller, for code generation)
- Algorithm logic
- Reusability in other models
- Testability, for example, for performing Hardware-in-the-Loop tests
- Sample rate; consider grouping components that have the same sample rate
- Simulation speed; using different solvers for components with different numerical properties can increase simulation speed
- Accessibility to other teams or others on your team.

While you cannot always plan on model size, if you expect multiple people to work on the design, you can benefit from componentization techniques. Consider controlling

configuration management using Simulink Project and partitioning the design using Model Reference so that the team can work on separate files concurrently.

Component Size	Recommended Componentization Techniques	Notes
Small <500 blocks	Create visual hierarchy using subsystems.	Small designs do not benefit from dividing into separate files. However, larger teams that cause file contention or high cost of verification can make it worth partitioning smaller components into separate files instead of using subsystems.
Large >500 blocks	Separate components into separate files using Model Reference or Libraries.	For multiple engineers or teams working on a design, best practice is one file per component. To reduce file contention, aim for components in which only one engineer needs to edit each model at a time.
Small <500 blocks, but expected to grow over time	Use atomic subsystems for functional block grouping instead of virtual subsystems. Atomic subsystems are easier to migrate to separate file components later.	If possible, plan your components from the start to avoid migration pain.

If your design or team is large enough to benefit from separating components into separate files, this table summarizes when to apply each technique.

Component Characteristics	Technique	Benefits	Costs
Small, low-level utility functions, reused in	Library model containing a single reusable	<ul style="list-style-type: none"> <li>Context-dependent: can adapt to various interfaces with different data types, sample time, and dimensions,</li> </ul>	<ul style="list-style-type: none"> <li>Cannot use independently to simulate or generate code. Requires a parent model.</li> </ul>

Component Characteristics	Technique	Benefits	Costs
many places in a design	atomic subsystem	<p>in different contexts, without changing the design.</p> <ul style="list-style-type: none"> <li>• Can be reused in other models</li> <li>• Stored as a separate file, can apply version control, but each instance adapts to context of parent model, so generated code can differ in each instance.</li> </ul>	<ul style="list-style-type: none"> <li>• Context adaptation not desirable for big components in large-scale models where interfaces are managed and locked down to specific data type and dimension. In these cases, you might not want code generated for the library block to differ in each instance.</li> <li>• Requires link management to avoid problems with broken, disabled, or parameterized links. See “Manage Components Using Libraries” on page 21-11.</li> </ul>
Groups of blocks for sharing among users	<p>Library for grouping and storing Simulink blocks</p> <p>Library <i>palette</i> of links to components</p>	<ul style="list-style-type: none"> <li>• Libraries are useful for storing blocks to share among a number of users</li> <li>• To reduce file contention, use library palettes of links to individual components in separate files. Store each component in a model reference file or a single subsystem in a separate library.</li> </ul>	<ul style="list-style-type: none"> <li>• Causes file contention if multiple components reside in a single library file. File contention is a problem only if blocks need frequent updates or multi-user access. Palettes can help.</li> <li>• Requires link management to avoid problems with broken, disabled, or parameterized links. See “Manage Components Using Libraries” on page 21-11.</li> </ul>

Component Characteristics	Technique	Benefits	Costs
<p>Top-level components for large-scale models: &gt;500 blocks</p> <p>Large components: starting at ~ 500–5000 blocks for one or a few reusable instances, or smaller if many instances</p> <p>Components at any level of model hierarchy where teams need to work independently</p>	<p>Model Referencing</p>	<ul style="list-style-type: none"> <li>• Components are independent model files and part of a larger model. You can simulate and generate code in the component.</li> <li>• Independent of context—good for large-scale model components where interfaces are managed and locked down.</li> <li>• Stored as a separate file—can apply version control to a component independently of the models that use it.</li> <li>• Possible to use Accelerator mode generated code to reduce memory requirements when loading models and increase simulation speed, compared to subsystems or libraries. Useful for top-level component partitions.</li> </ul>	<p>Performance can reduce slightly when updating a model (update diagram) because each reference model is checked for changes to enable incremental builds. When components are large enough (&gt;500 blocks), update diagram is faster in most cases.</p> <p>See “Partition a Design Using Model Reference” on page 21-10.</p>

## Choose Components for Team-Based Development

To perform parallel development, you need component-based modeling. Best practice for successful team-based development is to partition the models within the project so that only one user works on each part at a time. Componentization enables you to avoid or minimize time-consuming merging. To set up your project for work by a team, consider the following model architecture guidelines.

This table compares subsystems, libraries, and model referencing for team-based development.

Modeling Development Process	Subsystems	Libraries	Model Referencing
Team-based development	<p>Not supported</p> <p>For subsystems in a model, Simulink provides no direct interface with source control tools.</p> <p>To create or change a subsystem, you need to open the parent model's file. This can lead to file contention when multiple people want to work on multiple subsystems in a model.</p> <p>Merging subsystems is slow and errorprone, so best avoided as a workflow process. However, Simulink Report Generator provides tools to help you merge subsystems. See "Merge Simulink Models from the Comparison Report" (Simulink Report Generator).</p>	<p>Supported, with limitations</p> <p>You can place library files in source control for version control and configuration management. You can use Simulink Project to interact with source control.</p> <p>You can maintain one truth, by propagating changes from a single library block to all blocks that link to that library.</p> <p>To reduce file contention, use one subsystem per library.</p> <p>You can link to the same library block from multiple models.</p> <p>You can restrict write access to library components.</p>	<p>Well suited</p> <p>You can place model reference files in source control for version control and configuration management. You can use Simulink Project to interact with source control.</p> <p>You save a referenced model in a separate file from the model that references it. Using separate files helps to avoid file contention.</p> <p>You can design, create, simulate, and test a referenced model independently from the model that references it.</p> <p>Simulink does not limit access for changing a model reference.</p>

Most large models use a combination of componentization techniques. No single approach is suitable for the wide range of users of Simulink. The following advice describes some

typical processes to show what you can do with MathWorks tools to perform team-based development.

### **One File Per Component for Parallel Development**

To perform efficient parallel development, break a large model into a number of individual files, so that team members can work independently and you can place each file under revision control. Componentization enables you to avoid or minimize time-consuming merging. To set up your project for work by a team, consider the advice in “Guidelines for Component Size and Functionality” on page 21-4.

A key goal of component-based modeling is to allow parallel development, where different engineers can work on components of a larger system in parallel. You can achieve this if each component is a single file. You can then control and trace the changes in each component using source control in Simulink Project. See “Configuration Management” on page 21-18.

### **Partition an Existing Design**

If you already have a design that you want to divide into components, first decide where to partition the model. Existing subsystems that grow over time are not always the best way to partition the model. Consider dividing the model based on the advice in “Guidelines for Component Size and Functionality” on page 21-4.

Agreeing on an interface is a useful first step in deciding how to break down the functionality of a large system into subcomponents. You can group signals and partition data. See “Interface Design” on page 21-13.

After you decide how to partition your design, Simulink tools can help you divide an existing model into components.

Simulink can help you partition models by converting subsystems to files. You can convert to files using Model Reference or Libraries. See “Guidelines for Component Size and Functionality” on page 21-4 for suggestions on when to apply each technique.

### **Partition a Design Using Model Reference**

Use Model Reference to divide the components into separate files so that the team can work on separate files concurrently. You can also reuse the models in other models. To partition a model using model reference, see “Create a Referenced Model” on page 8-9 or “Convert a Subsystem to a Referenced Model” on page 8-17.



## Manage Components Using Libraries

- Use Libraries containing a single subsystem to contain a component in a single file. Use libraries to store blocks you can reuse in models. The linked blocks inherit attributes from the surrounding models, such as data types and sample rate. Using this technique for componentization has the management overhead of library links, described below.
- Use Libraries to reuse blocks in multiple models. Libraries work well for grouping and storing Simulink blocks to share. Best practice for libraries is to use them for storing blocks to share with multiple users, and blocks that are updated infrequently. As a rough guideline, it is appropriate to use a Simulink library if its contents are updated once every few months. If you update it more frequently, then the library is probably being used to perform configuration management. In this case, take care to avoid the common problems described in “Library Link Management” on page 21-11.
- To make library blocks available for reuse while reducing file contention and applying revision control, use library palettes. A palette is a library containing links to other components. If each component is a single subsystem in a separate library, or a model reference file, you can achieve the one-file-per-component best practice for component-based modeling. You can use separate version control for each component, and you can also control the palette.

When you drag a block from the library palette into your model, Simulink follows the link back to the file where the subsystem or model reference is implemented. The models that use the component contain a link to the component and not to the palette.

### Library Link Management

Library links can introduce management overhead if you use them for configuration management. Take care to manage:

- Disabled links — Can cause merge conflicts, and failure to update all instances of the same model component. In a hierarchy of links, you can accidentally disable all links without being aware of it, and only restore one link while leaving others disabled.
- Broken links — Accidentally broken links are a hard problem to solve, because, by design, you cannot detect what the broken link linked to previously.
- Parameterized link data — It can be useful to change the value of parameter data, such as the value of a gain within a gain block, without disabling the library link. This generates “link data” for that instance only. However for configuration management this can cause a problem, if you assume all instances are identical, as one now has different properties.

Simulink tools help you manage library links to avoid problems:

- Lock links to prevent editing. See “Lock Links to Blocks in a Library” on page 39-29.
- Use diagnostic options to check library link integrity whenever you save a model. You can set the checks to warn, error, or ignore that a model has disabled or parameterized library links. You select these settings per model. In the Configuration Parameters dialog box, see **Diagnostics > Saving**.

See the diagnostic settings “Block diagram contains disabled library links” and “Block diagram contains parameterized library links”.

- Use Model Advisor checks to report on library link integrity. The advisor checks for disabled and parameterized links within a model. You can use the resulting report as an artifact to check into a configuration management system.

See the Model Advisor checks:

- “Identify disabled library links”
- “Identify parameterized library links”
- “Identify unresolved library links”
- Use the Links Tool to view and restore disabled and edited links. See “Restore Disabled or Parameterized Links” on page 39-31.

---

**Caution:** These link management tools can detect link problems but cannot prevent editing the wrong files. If this is a problem, then use Model Reference as the partitioning mechanism to avoid the risks associated with disabled, broken, and parameterized links.

---

### More About

- “Interface Design” on page 21-13
- “Configuration Management” on page 21-18

# Interface Design

**In this section...**

“Why Interface Definitions Are Important” on page 21-13

“Recommendations for Interface Design” on page 21-13

“Partitioning Data” on page 21-15

“Configure Data Interface for Component” on page 21-15

## Why Interface Definitions Are Important

Defining the “interface” of a software component, such as a C or MATLAB code function or a Simulink subsystem, is a key first step before others can use it, for these reasons:

- Agreeing on an interface is a useful first step in deciding how to break down the functionality of a large system into subcomponents.
- After you define interfaces between a number of components, you can develop the components in parallel. If the interface remains stable, then it is easy to integrate those components into a larger system.
- Changing the interface between components is expensive. It requires changes to at least two components (the source and any sinks) and to any test harnesses. It also makes all previous versions of those components incompatible with the current and future versions.

When you need to change an interface, doing so is much easier if the components are stored under configuration management. You can track configurations of compatible component versions to prevent incompatible combinations of components.

## Recommendations for Interface Design

Suggestions for defining the interfaces of components for a new project:

- Base the boundaries of the components upon those of the corresponding real systems. This is especially useful when the model contains:
  - Both physical (plant and environment) and control systems
  - Algorithms that run at different rates

- Consider future model elaboration. If you intend to add models of sensors, then put them in from the start as an empty subsystem that passes signals straight through or performs a unit delay and/or name conversion.
- Consider future component reuse.
- Consider using a signal naming convention.
- Use data objects for :
  - Defining component interfaces
  - Precise control over data attributes
- Simplify interface design by grouping signals into buses. Signal buses are well suited for use at the high levels of models, where components often have a large number of signals going in and out, and do not use all the signals available. Using buses can simplify modifying the interface to a component. For example, if you need to add or remove signals used by a component, it can be simpler to modify a bus than to add or remove inports or outports to that component. However, using a bus that crosses model reference boundaries requires using a bus object.

Best practices for using Simulink bus signals and bus objects:

- Make buses virtual, except for model reference component boundaries.
- Use nonvirtual buses when defining interfaces between components. However, this requires associating the bus with a bus object. Bus objects completely define the properties of the signals on a bus, giving an unambiguous interface definition.

Include bus objects in a data dictionary, or save bus objects as a `.mat` or `.m` file, in order to place them under revision control.

- Pass only required signals to each component to reduce costly passing of unnecessary data. Signal buses allow the full set of input and output signals to be defined, but not necessarily used or created.
- Make sure that the interface specifies exactly what the component uses.
- Use a rigorous naming convention for bus objects. Unless you use a data dictionary, bus objects are stored in the base workspace.
- At the lower levels of a model, consider using inports and outports for each signal. At lower levels of a model, where components typically implement algorithms rather than serve as containers for other components, it can increase readability if you use individual inports and outports for components, instead of using signal buses. However, creating interfaces in this way has a greater risk of connection

problems, because it is difficult to check the validity of connections, other than their data type, size, etc.

- To package signals or parameters into structures that correspond to a `struct` type definition that your external C code defines, import the type as a bus object and use the object as a data type for bus signals and MATLAB structures. To create the object, use the `Simulink.importExternalTypes` function.

## Partitioning Data

Explicitly control the scope of data for your components. Some techniques:

- Global parameters — A common approach in the automotive world is to completely separate the problem of parameter storage from model storage. The parameters for a model come from a database of calibration data, and the specific calibration file used becomes part of the configuration. The calibration data is treated as global data, and resides in the base MATLAB workspace. You can migrate base workspace data to a data dictionary for more control.
- Nonglobal parameters — Combining a number of components that somehow store their own parameter data has the risk of parameter name collisions. If you do not use a naming convention for parameters or, alternatively, a list of unique parameter names and definitions, then there is the risk that two components use a parameter with the same name but with different meanings.

Methods for storing local parameter data include:

- Partition data into reference dictionaries for each component.
- With Model Reference, you can use model workspaces.
- Use parameter files (`.m` or `.mat`) and callbacks of the individual Simulink models (e.g., `preload` function).

You can also automatically load required data using Simulink Project shortcuts.

- Mask workspaces, with or without the use of mask initialization functions.
- For subsystems, you can control the scope of data for a subsystem using the Subsystem Parameters, Permit Hierarchical Resolution dialog box.

## Configure Data Interface for Component

Whether you use referenced models or subsystems to break a large system into components, the components can exchange signal data through Inport and Outport

blocks. You can explicitly configure design attributes (such as data type and numeric complexity) of the interface to prevent modeling errors and make integrating the components easier.

After you create the Inport and Outport blocks, you can use the Model Data Editor and the interface display to configure the design attributes (such as data type and numeric complexity) of the blocks. Use this technique to view the component interface in its entirety at once and to trace the pieces of the interface to usage points in the internal block algorithm. You can also use this technique to configure the interface of a component before you develop the internal algorithm, in which case the component contains unconnected Inport and Outport blocks.

The example model `sldemo_fuelsys_dd` contains two components which are referenced models:

- A plant component, `sldemo_fuelsys_dd_plant`.
- A controller component, `sldemo_fuelsys_dd_controller`.

Use the Model Data Editor and the interface display to examine and configure the interface of the plant component.

- 1 Open the plant component.

`sldemo_fuelsys_dd_plant`

- 2 Select **Display > Interface**.
- 3 Select **View > Model Data**.

By default, in the Model Data Editor, the **Inports/Outports** tab is selected. Each row in the table represents an Inport or Outport block. By default, the **Change View** drop-down list is set to **Design**.

---

**Tip:** To view only the Inport and Outport blocks at the root level of the model (by excluding the blocks inside the subsystems), deactivate the **Change Scope** button.

---

- 4 Use the columns in the Model Data Editor to explicitly configure the design attributes of the interface. For example, specify minimum and maximum values for each Inport and Outport block by using the **Min** and **Max** columns.

To configure code generation settings for the interface of a controller component, in the Model Data Editor, set the **Change View** drop-down list to **Code**.

For more information about using the interface display, see “Trace Connections Using Interface Display” on page 12-69. For more information about the Model Data Editor, see “Configure Data Properties by Using a Table” on page 57-123.

## **Related Examples**

- “Trace Connections Using Interface Display” on page 12-69
- “Map Bus Objects to Models” on page 63-88
- “Composite Signals”
- “Partition Data for Model Reference Hierarchy Using Data Dictionaries” on page 61-37
- “Parameter Interfaces for Reusable Components” on page 35-20
- “Design Data Interface by Configuring Inport and Outport Blocks” (Simulink Coder)

## **More About**

- “Overview of Composite Signal Techniques” on page 63-3
- “Buses” on page 63-3
- “When to Use Bus Objects” on page 63-59
- “Design Partitioning” on page 21-2
- “Configuration Management” on page 21-18

## Configuration Management

**In this section...**

“Manage Designs Using Source Control” on page 21-18

“Determine the Files Used by a Component” on page 21-19

“Manage Model Versions” on page 21-19

“Create Configurations” on page 21-20

### Manage Designs Using Source Control

Simulink projects can help you work with configuration management tools for team collaboration. You can use projects to help you manage all the models and associated files for model-based design.

You can control and trace the changes in each component using source control in Simulink Project. Using source control directly from Simulink Project provides these benefits:

- Engineers do not have to remember to use two separate tools, avoiding the common mistake of beginning work in Simulink without checking out the required files first.
- You can perform analysis within MATLAB and Simulink to determine the dependencies of files upon each other. Third-party tools are unlikely to understand such dependencies.
- You can compare revisions and use tools to merge models (requires Simulink Report Generator).

If each component is a single file, you can achieve efficient parallel development, where different engineers can work on the different components of a larger system in parallel. Componentization enables you to avoid or minimize time-consuming merging. See “One File Per Component for Parallel Development” on page 21-10. One file per component is not strictly necessary to perform configuration management, but it makes parallel development much easier.

If you break down a model into a number of components, it is easier to reuse those components in different projects. If the components are kept under revision control and configuration management, then you can reuse components in a number of projects simultaneously.



To find out about source control support in Simulink, see “Source Control in Simulink Project”.

## Determine the Files Used by a Component

You can use Simulink Project to determine the set of files you need to place under configuration management. You can analyze the set of files that are required for the model to run, such as model references, library links, block and model callbacks (`preload` functions, `init` functions, etc.), S-functions, From Workspace blocks, etc. Any MATLAB code found is also analyzed to determine additional file dependencies. You can use the Simulink manifest tools to report which toolboxes are required by a model, which can be a useful artifact to store.

You can also perform a file dependency analysis of a model programmatically from MATLAB using `dependencies.fileDependencyAnalysis` to get a cell array of paths to required files.

For more information, see “Dependency Analysis”.

## Manage Model Versions

Simulink can help you to manage multiple versions of a model.

- Use Simulink Projects to manage your project files, connect to source control, review modified files, and compare revisions. See “Project Management”.
- Simulink notifies you if a model has changed on disk when updating, simulating, editing, or saving the model. Models can change on disk, for example, with source control operations and multiple users. Control this notification with the Model File Change Notification preference. See “Model File Change Notification” on page 4-61.
- As you edit a model, Simulink generates version information about the model, including a version number, who created and last updated the model, and an optional comments history log. Simulink saves these version properties with the model.
  - Use the Model Properties dialog box to view and edit some of the version information stored in the model and specify history logging.
  - The Model Info block lets you display version information as an annotation block in a model diagram.
- Use `Simulink.MDLInfo` class to extract information from a model file without loading the block diagram into memory. You can use `MDLInfo` to query model version and

Simulink version, find the names of referenced models without loading the model into memory, and attach arbitrary metadata to your model file.

## Create Configurations

You can use Simulink Project to work with the revision control parts of the workflow: retrieving files, adding files to source control, checking out files, and committing edited files to source control.

To define configurations of files, you can label a number of files as a new mutually consistent configuration. Other users can get this set of files from the revision control system.

Configurations are different from revisions. Individual components can have revisions that work together only in particular configurations.

Tools for creating configurations in Simulink:

- Variant modeling. See “Variant Systems”.
- Tools in Simulink Project:
  - Label — Label project files. Use labels to apply metadata to files. You can group and sort by labels, label folders for adding to the path using shortcut functions, or create batch jobs to export files by label, for example, to manage files with the label **Diesel**. You cannot retrieve from source control by label, and labels persist across revisions.
  - Revision Log — Use Revert Project to choose a revision to revert to (SVN source control only).
  - Branch — Create branches of file versions, and switch to any branch in the repository (Git source control only).
  - Tag — You can tag all project files (SVN source control only) to identify a particular configuration of a project, and retrieve tagged versions from source control. However, continued development is limited. That is, you cannot tag again, and you must check out from `trunk` to apply tags.
  - Archive — Package all project files in a Zip file that you can create a new project from. However, this packaging removes all source control information, because archiving is for exporting, sharing, and changing to another source control. You can commit the new Zip file to source control.

## **More About**

- “What Are Simulink Projects?” on page 16-3
- “Design Partitioning” on page 21-2
- “Interface Design” on page 21-13



# Power Window Example

---

## Power Window

In this section...
“Study Power Windows” on page 22-2
“MathWorks Software Used in This Example” on page 22-3
“Quantitative Requirements” on page 22-4
“Simulink Power Window Controller in Simulink Project” on page 22-13
“Simulink Power Window Controller” on page 22-15
“Create Model Using Model-Based Design” on page 22-34
“Automatic Code Generation for Control Subsystem” on page 22-56
“References” on page 22-57

### Study Power Windows

Automobiles use electronics for control operations such as:

- Opening and closing windows and sunroof
- Adjusting mirrors and headlights
- Locking and unlocking doors

These systems are subject to stringent operation constraints. Failures can cause dangerous and possibly life-threatening situations. As a result, careful design and analysis are needed before deployment.

This example focuses on the design of a power window system of an automobile, in particular, the passenger-side window. A critical aspect of this system is that it cannot exert a force of more than 100 N on an object when the window closes. When the system detects such an object, it must lower the window by about 10 cm.

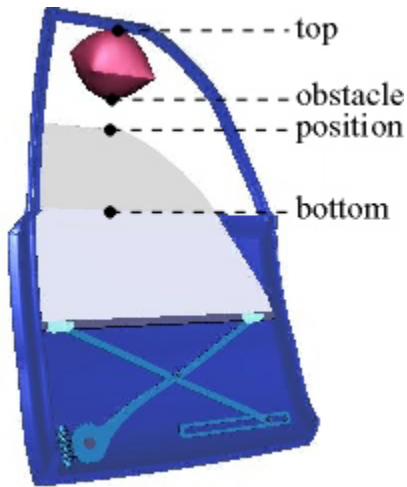

As part of the design process, the example considers:

- Quantitative requirements for the window control system, such as timing and force requirements
- System requirements, captured in activity diagrams
- Data definitions for the signals used in activity diagrams

Other aspects of the design process that this example contains are:

- Managing the components of the system
- Building the model
- Validating the results of system simulation
- Generating code

## MathWorks Software Used in This Example

In addition to Simulink, this example uses these additional MathWorks products:

- DSP System Toolbox
- Fixed-Point Designer
- Simscape Multibody
- Simscape Power Systems™

- Simscape
- Simulink 3D Animation
- Simulink Real-Time
- Simulink Verification and Validation
- Stateflow

## Quantitative Requirements

Quantitative requirements for the control are:

- The window must fully open and fully close within 4 s.
- If the up is issued for between 200 ms and 1 s, the window must fully open. If the down command is issued for between 200 ms and 1 s, the window must fully close.
- The window must start moving 200 ms after the command is issued.
- The force to detect when an object is present is less than 100 N.
- When closing the window, if an object is in the way, stop closing the window and lower the window by approximately 10 cm.

## Capturing Requirements in Activity and Context Diagrams

Activity diagrams help you graphically capture the specification and understand how the system operates. A hierarchical structure helps with analyzing even large systems. At the top level, a context diagram describes the system environment and its interaction with the system under study in terms of data exchange and control operations. Then you can decompose the system into an activity diagram with processes and control specifications (CSPEC).

The processes guide the hierarchical decomposition. You specify each process using another activity diagram or a primitive specification (PSPEC). You can specify a PSPEC in a number of representations with a formal semantic, such as a Simulink block diagram. In addition, context diagrams graphically capture the context of system operation.

### Context Diagram: Power Window System

The figure represents the context diagram of a power window system. The square boxes capture the environment, in this case, the driver, passenger, and window. Both the driver and passenger can send commands to the window to move it up and down. The controller infers the correct command to send to the window actuator (e.g., the driver command has



priority over the passenger command). In addition, diagram monitors the state of the window system to establish when the window is fully opened and closed and to detect if there is an object between the window and frame.

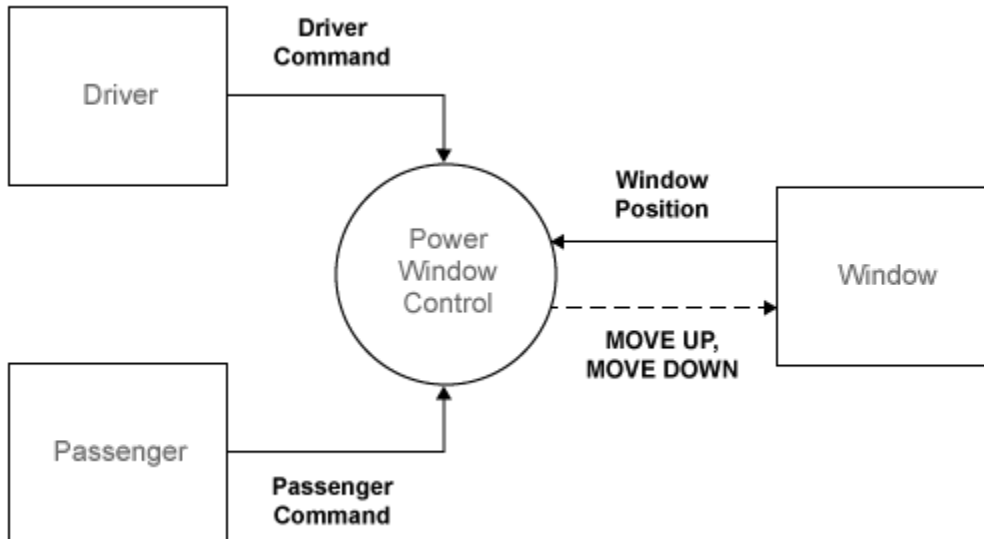

The circle (also known as a bubble) represents the power window controller. The circle is the graphical notation for a process. Processes capture the transformation of input data into output data. Primitive process might also generate. CSPECs typically consist of combinational or sequential logic to infer output control signals from input control.

For implementation in the Simulink environment, see “Implementation of Context Diagram: Power Window System” on page 22-35.

### Activity Diagram: Power Window Control

The power window control consists of three processes and a CSPEC. Two processes validate the driver and passenger input to ensure that their input is meaningful given the state of the system. For example, if the window is completely opened, the MOVE DOWN command does not make sense. The remaining process detects if the window is completely opened or completely closed and if an object is present. The CSPEC takes the control signals and infers whether to move the window up or down (e.g., if an object is present, the window moves down for about one second or until it reaches an endstop).

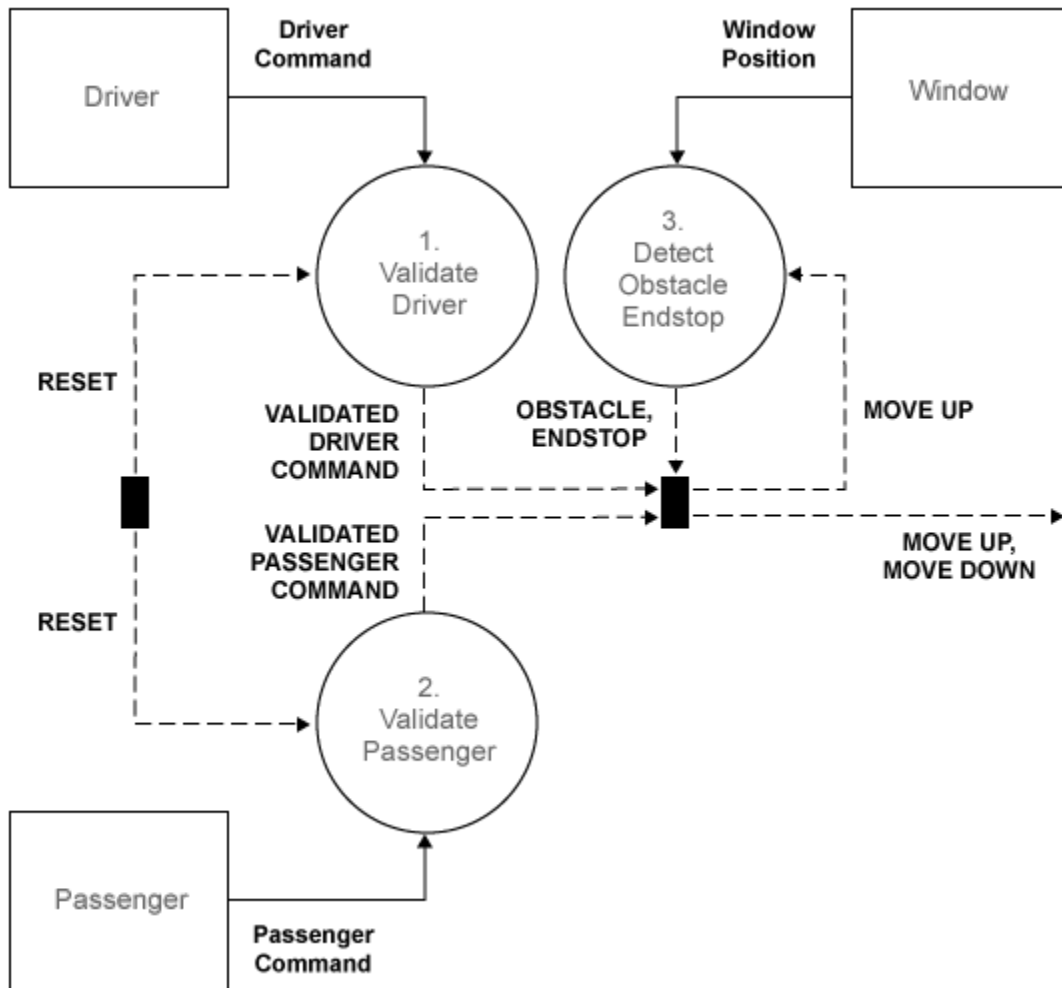

For implementation in the Simulink environment, see “Implementation of Activity Diagram: Power Window Control” on page 22-15.

**Activity Diagram: Validate Driver**

Each process in the VALIDATE DRIVER activity chart is primitive and specified by the following PSPEC. In the MAKE EXCLUSIVE PSPEC, for safety reasons the DOWN command takes precedence over the UP command.

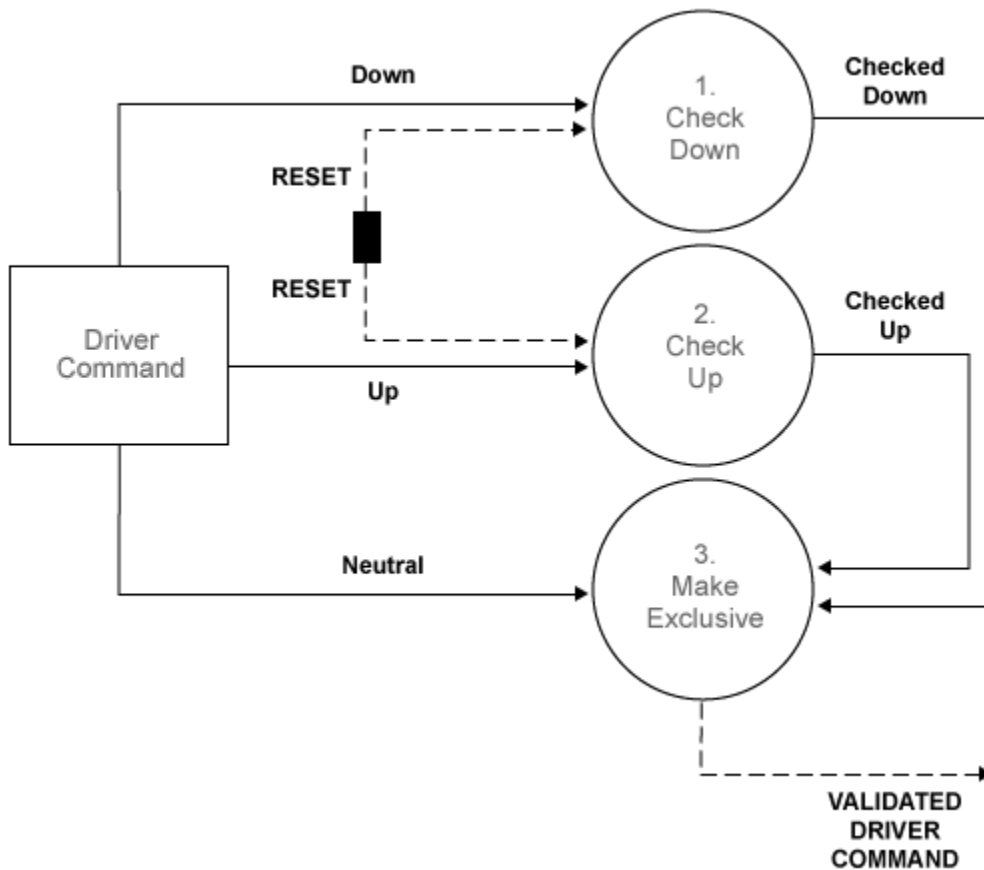

PSPEC 1.1.1: CHECK DOWN

CHECKED\_DOWN = DOWN and not RESET

PSPEC 1.1.2: CHECK UP

CHECKED\_UP = UP and not RESET

PSPEC 1.1.3: MAKE EXCLUSIVE

VALIDATED\_DOWN = CHECKED\_DOWN

VALIDATED\_UP = CHECKED\_UP and not CHECKED\_DOWN

VALIDATED\_NEUTRAL = (NEUTRAL and not (CHECKED\_UP and not CHECKED\_DOWN))  
or not (CHECKED\_UP or CHECKED\_DOWN)

For implementation in the Simulink environment, see “Implementation of Activity Diagram: Validate” on page 22-36.

**Activity Diagram: Validate Passenger**

The internals of the VALIDATE PASSENGER process are the same as the VALIDATE DRIVER process. The only difference is the different input and output.

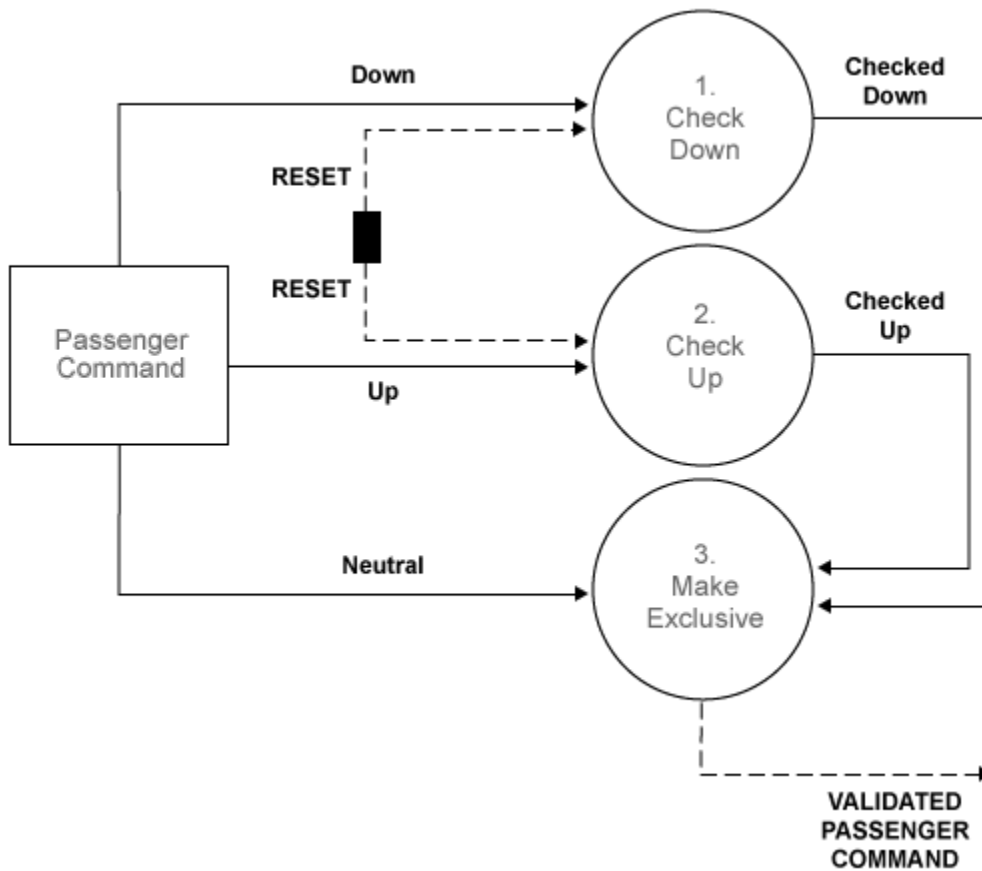

PSPEC 1.2.1: CHECK DOWN  
 CHECKED\_DOWN = DOWN and not RESET

PSPEC 1.2.2: CHECK UP  
CHECKED\_UP = UP and not RESET

PSPEC 1.2.3: MAKE EXCLUSIVE  
VALIDATED\_DOWN = CHECKED\_DOWN  
VALIDATED\_UP = CHECKED\_UP and not CHECKED\_DOWN  
VALIDATED\_NEUTRAL = (NEUTRAL and not (CHECKED\_UP and not CHECKED\_DOWN))  
or not (CHECKED\_UP or CHECKED\_DOWN)

For implementation in the Simulink environment, see “Activity Diagram: Validate Passenger” on page 22-8.

### **Activity Diagram: Detect Obstacle Endstop**

The third process in the POWER WINDOW CONTROL activity diagram detects the presence of an obstacle or when the window reaches its top or bottom (ENDSTOP). The detection mechanism is based on the armature current of the window actuator. During normal operation, this current is within certain bounds. When the window reaches its top or bottom, the electromotor draws a large current (more than 15 A or less than -15 A) to try and sustain its angular velocity. Similarly, during normal operation the current is about 2 A or -2 A (depending on whether the window is opening or closing). When there is an object, there is a slight deviation from this value. To keep the window force on the object less than 100 N, the control switches to its emergency operation when it detects a current that is less than -2.5 A. This operations is necessary only when the window is rolling up, which corresponds to a negative current in the particular wiring of this model. The DETECT OBSTACLE ENDSTOP activity diagram embodies this functionality.

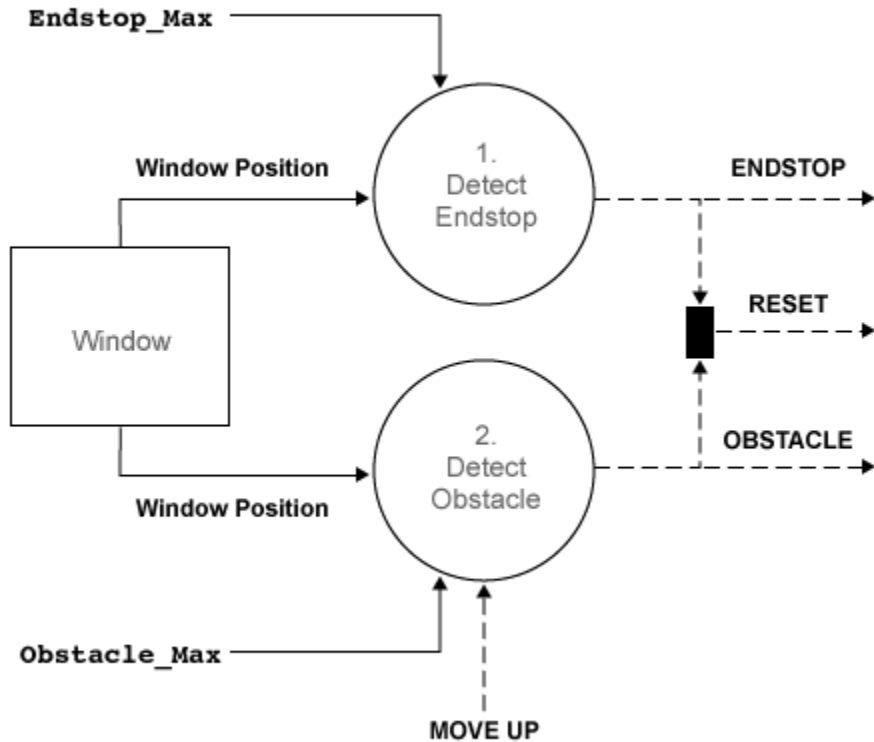

CSPEC 1.3: DETECT OBSTACLE ENDSTOP  
 RESET = OBSTACLE or ENDSTOP

PSPEC 1.3.1: DETECT ENDSTOP  
 ENDSTOP = WINDOW\_POSITION > ENDSTOP\_MAX

PSPEC 1.3.2: DETECT OBSTACLE  
 OBSTACLE = (WINDOW\_POSITION > OBSTACLE\_MAX) and MOVE\_UP for 500 ms

For implementation in the Simulink environment, see “Activity Diagram: Detect Obstacle Endstop” on page 22-9.

### Data Definitions

The functional decomposition unambiguously specifies each process by its decomposition or primitive specification (PSPEC). In addition, it must also formally specify the signals in the activity diagrams. Use data definitions for these specifications.

The following tables are data definitions for the signals used in the activity diagrams.

For the associated activity diagram, see “Context Diagram: Power Window System” on page 22-4.

#### Context Diagram: Power Window System Data Definitions

Signal	Information Type	Continuous/ Discrete	Data Type	Values
DRIVER_COMMAND	Data	Discrete	Aggregate	Neutral, up, down
PASSENGER_COMMAND	Data	Discrete	Aggregate	Neutral, up, down
WINDOW_POSITION	Data	Continuous	Real	0 to 0.4 m
MOVE_UP	Control	Discrete	Boolean	'True', 'False'
MOVE_DOWN	Control	Discrete	Boolean	'True', 'False'

For the associated activity diagram, see “Activity Diagram: Power Window Control” on page 22-5.

#### Activity Diagram: Power Window Control Data Definitions

Signal	Information Type	Continuous/ Discrete	Data Type	Values
DRIVER_COMMAND	Data	Discrete	Aggregate	Neutral, up, down
PASSENGER_COMMAND	Data	Discrete	Aggregate	Neutral, up, down
WINDOW_POSITION	Data	Continuous	Real	0 to 0.4 m
MOVE_UP	Control	Discrete	Boolean	'True', 'False'

Signal	Information Type	Continuous/ Discrete	Data Type	Values
MOVE_DOWN	Control	Discrete	Boolean	'True', 'False'

For the associated activity diagram, see “Activity Diagram: Validate Driver” on page 22-6.

**Activity Diagram: Validate Driver Data Definitions**

Signal	Information Type	Continuous/ Discrete	Data Type	Values
DRIVER_COMMAND	Data	Discrete	Aggregate	Neutral, up, down
PASSENGER_COMMAND	Data	Discrete	Aggregate	Neutral, up, down
WINDOW_POSITION	Data	Continuous	Real	0 to 0.4 m
MOVE_UP	Control	Discrete	Boolean	'True', 'False'
MOVE_DOWN	Control	Discrete	Boolean	'True', 'False'

For the associated activity diagram, see “Activity Diagram: Validate Passenger” on page 22-8.

**Activity Diagram: Validate Passenger Data Definitions**

Signal	Information Type	Continuous/ Discrete	Data Type	Values
NEUTRAL	Data	Discrete	Boolean	'True', 'False'
UP	Data	Discrete	Boolean	'True', 'False'
DOWN	Data	Discrete	Boolean	'True', 'False'
CHECKED_UP	Data	Discrete	Boolean	'True', 'False'



Signal	Information Type	Continuous/ Discrete	Data Type	Values
CHECKED_DOWN	Data	Discrete	Boolean	'True', 'False'

For the associated activity diagram, see “Activity Diagram: Detect Obstacle Endstop” on page 22-9.

### Activity Diagram: Detect Obstacle Endstop Data Definitions

Signal	Information Type	Continuous/ Discrete	Data Type	Values
ENDSTOP_MIN	Data	Constant	Real	0.0 m
ENDSTOP_MAX	Data	Constant	Real	0.4 m
OBSTACLE_MAX	Data	Constant	Real	0.3 m

The model design iterates as we examine more detailed implementations. For information about how the model design iterates as you introduce more detail, see “Iterate on the Design” on page 22-46.

## Simulink Power Window Controller in Simulink Project

MATLAB and Simulink support Model-Based Design for embedded control design, from initial specification to code generation. To organize large projects and share your work with others, use Simulink Projects.

The Power Window Control Project example shows how you can use MathWorks tools and the Model-Based Design process to go from concept through implementation for an automobile power window system. It uses Simulink Projects to organize the files and other model components.

In addition, this example shows how to link models to system documentation.

### Explore the Power Window Controller Project

- 1 To open the Power Window Controller project, in the MATLAB Command Window, type:

```
slexPowerWindowStart
```

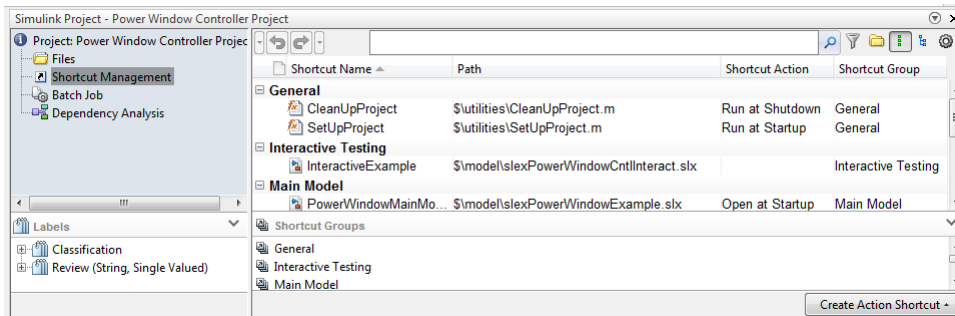

2 Explore the project folders. In particular, note the **task** folders. This folder contains scripts that run frequent tasks for a model. For the Power Window Controller Project, these scripts:

- Set up the model to control window movement on a controller area network (CAN).
- Set up the model to use the Stateflow and Simulink software to model discrete-event reactive behavior and continuous time behavior, with a low-order plant model.
- Set up the model with a more detailed plant model that includes power effects in the electrical and mechanical domains. The plant model validates the force exerted by the window on a trapped object.
- Set up the model with a model that includes other effects that may change the model, such as quantization of the measurements.

---

**Note:** These scripts also simulate the model. To only configure the model, see the scripts in the **configureModel** folder.

---

3 The **Shortcut Management** section contains quick-access commands that you can double-click to perform common tasks such as:

- Set up and clean up projects.
- Add projects to MATLAB paths.
- Perform interactive testing.
- Validate model testing with model coverage.

- Open the main model.
- Simulate the model with various configurations.
- Generate a model coverage report for increased coverage of the model.
- Open the model used for increasing model coverage.

## Simulink Power Window Controller

- “Implementation of Activity Diagram: Power Window Control” on page 22-15
- “Interactive Testing” on page 22-17
- “Experimental Results from Interactive Testing” on page 22-20
- “Model Coverage” on page 22-29

### Implementation of Activity Diagram: Power Window Control

This topic describes the high-level discrete-event control specification for a power window control.

You can model the discrete-event control of the window with a Stateflow chart. A Stateflow chart is a finite state machine with hierarchy and parallelism. This state machine contains the basic states of the power window system: up, auto-up, down, auto-down, rest, and emergency. It models the state transitions and accounts for the precedence of driver commands over the passenger commands. It also includes emergency behavior that activates when the software detects an object between the window and the frame while moving up.

The initial Simulink model for the power window control, `slexPowerWindowControl`, is a discrete-event controller that runs at a given sample rate.

In this implementation, open the power window control subsystem and observe that the Stateflow chart with the discrete-event control forms the CSPEC, represented by the tilted thick bar in the bottom right corner. The `detect_obstacle_endstop` subsystem encapsulate the threshold detection mechanisms.

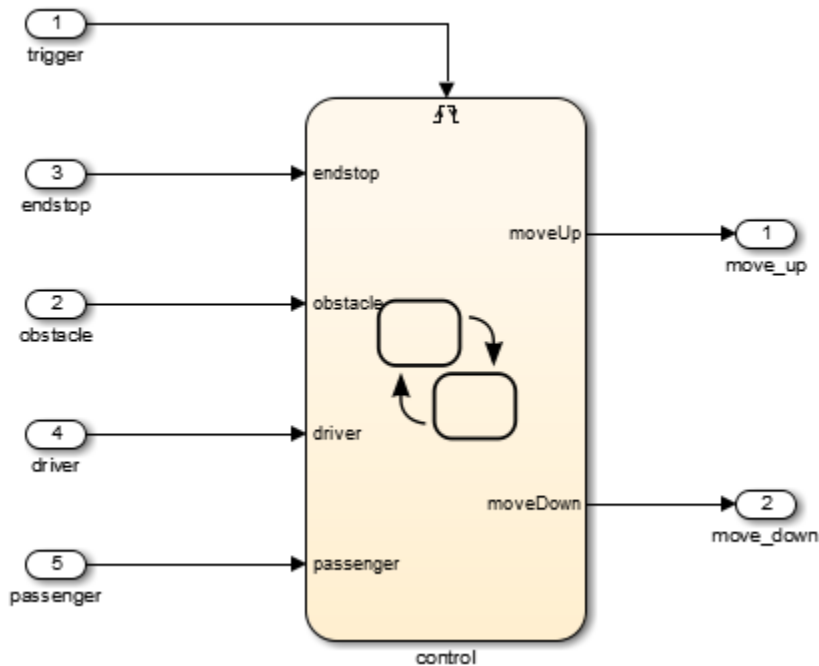

The discrete-event control is a Stateflow model that extends the state transition diagram notion with hierarchy and parallelism. State changes because of passenger commands are encapsulated in a *super state* that does not correspond to an active driver command.

Consider the control of the passenger window. The passenger or driver can move this window up and down.

This state machine contains the basic states of the power window system: up, auto-up, down, auto-down, rest, and emergency.

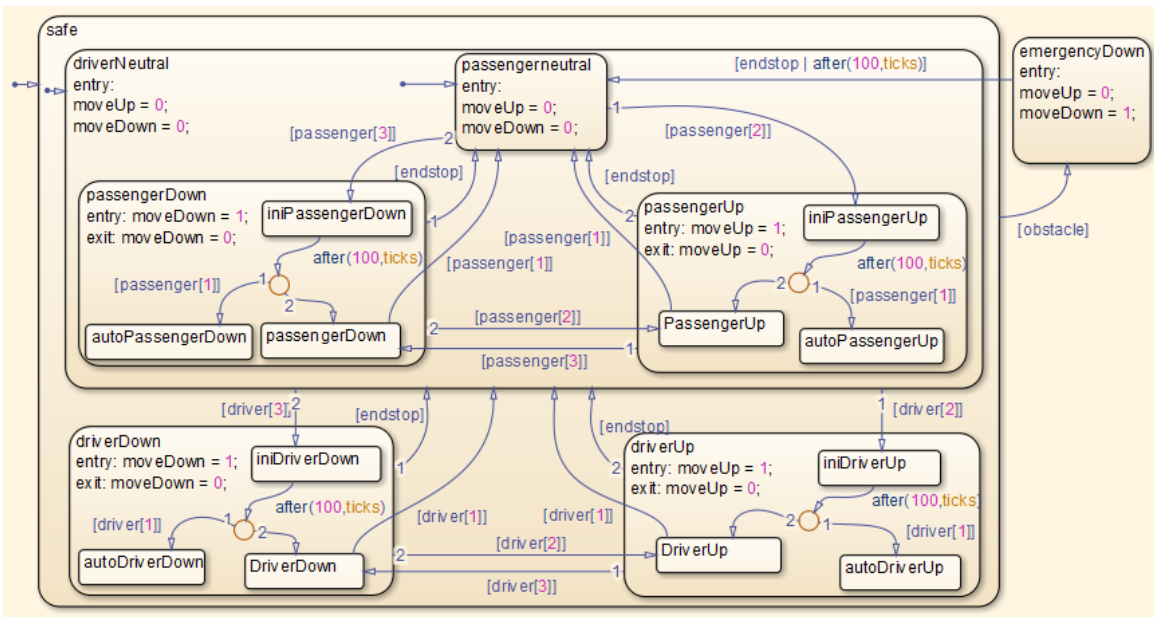

## Interactive Testing

### Control Input

The `slexPowerWindowCntlInteract` model includes this control input as switches. Double-click these switches to manually operate them.

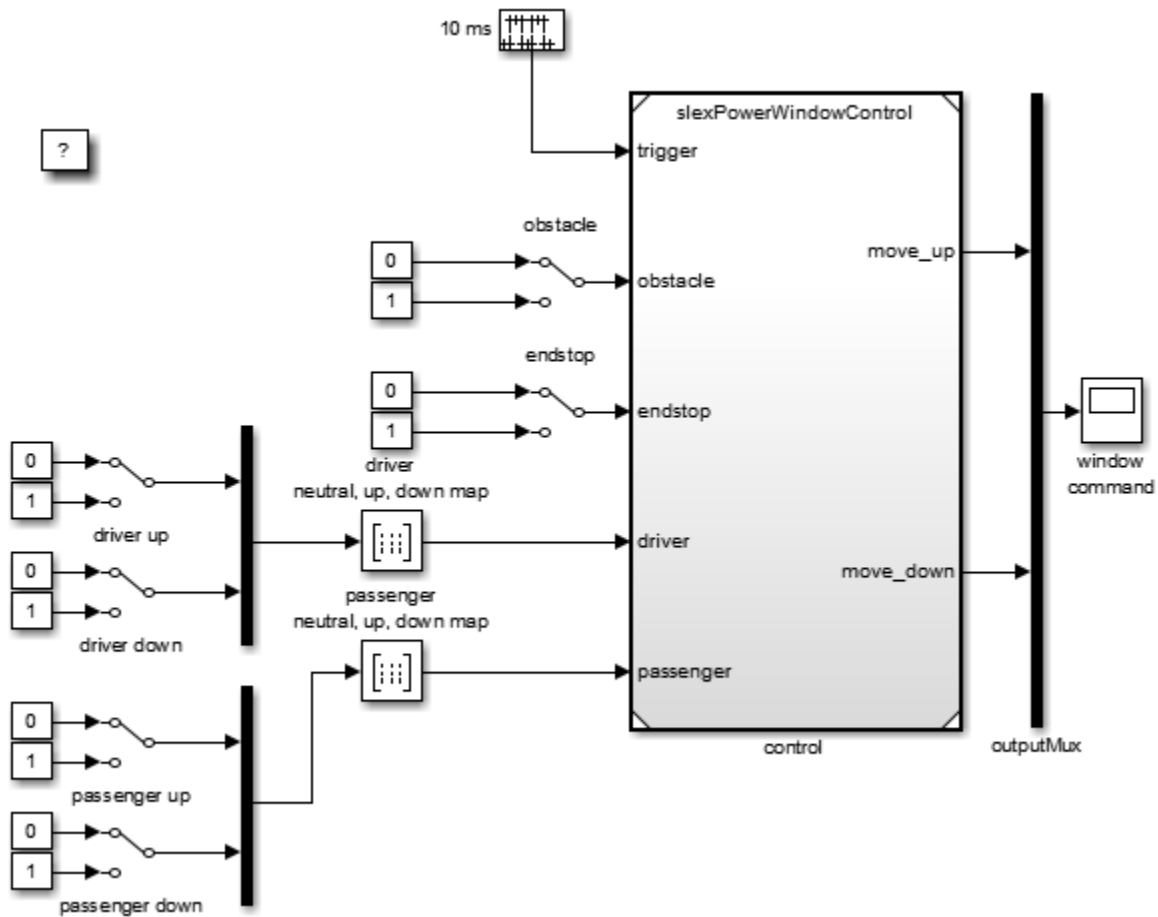

Test the state machine that controls a power window by running the input test vectors and checking that it reaches the desired internal state and generates output. The power window has the following external inputs:

- Passenger input
- Driver input
- Window up or down
- Obstacle in window

Each input consists of a vector with these inputs.

**Passenger Input**

Element	Description
neutral	Passenger control switch is not depressed.
up	Passenger control switch generates the up signal.
down	Passenger control switch generates the down signal.

**Driver Input**

Element	Description
neutral	Driver control switch is not depressed.
up	Driver control switch generates the up signal.
down	Driver control switch generates the down signal.

**Window Up or Down**

Element	Description
0	Window moves freely between top or bottom.
1	Window is stuck at the top or bottom because of physical limitations.

**Obstacle in Window**

Element	Description
0	Window moves freely between top or bottom.
1	Window has obstacle in the frame.

Generate the passenger and driver input signals by mapping the up and down signals according to this table:

Inputs		Outputs		
up	down	up	down	neutral
0	0	0	0	1
0	1	0	1	0
1	0	1	0	0
1	1	0	0	1

The inputs explicitly generate the **neutral** event from the **up** and **down** events, generated by pressing a power window control switch. The inputs are entered as a truth table in the passenger neutral, up, down map and the driver neutral, up, down map.

### Experimental Results from Interactive Testing

#### Case 1: Window Up

To observe the state machine behavior:

- 1 Open the `slexPowerWindowCntlInteract` model.
- 2 Run the simulation and then double-click the passenger up switch.



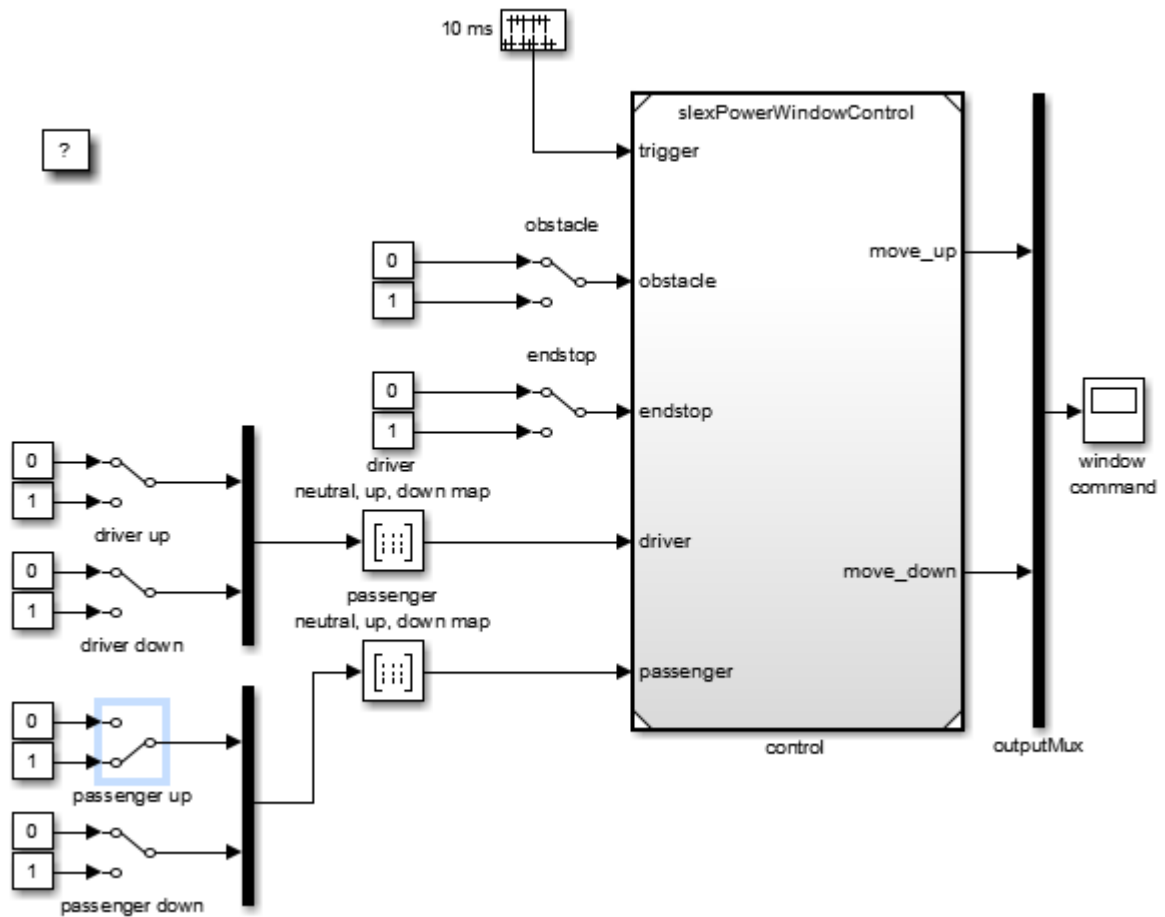

If you press the physical window switch for more than one second, the window moves up until the up switch is released (or the top of the window frame is reached and the endstop event is generated).

- 3 Double-click the selected passenger up switch to release it.

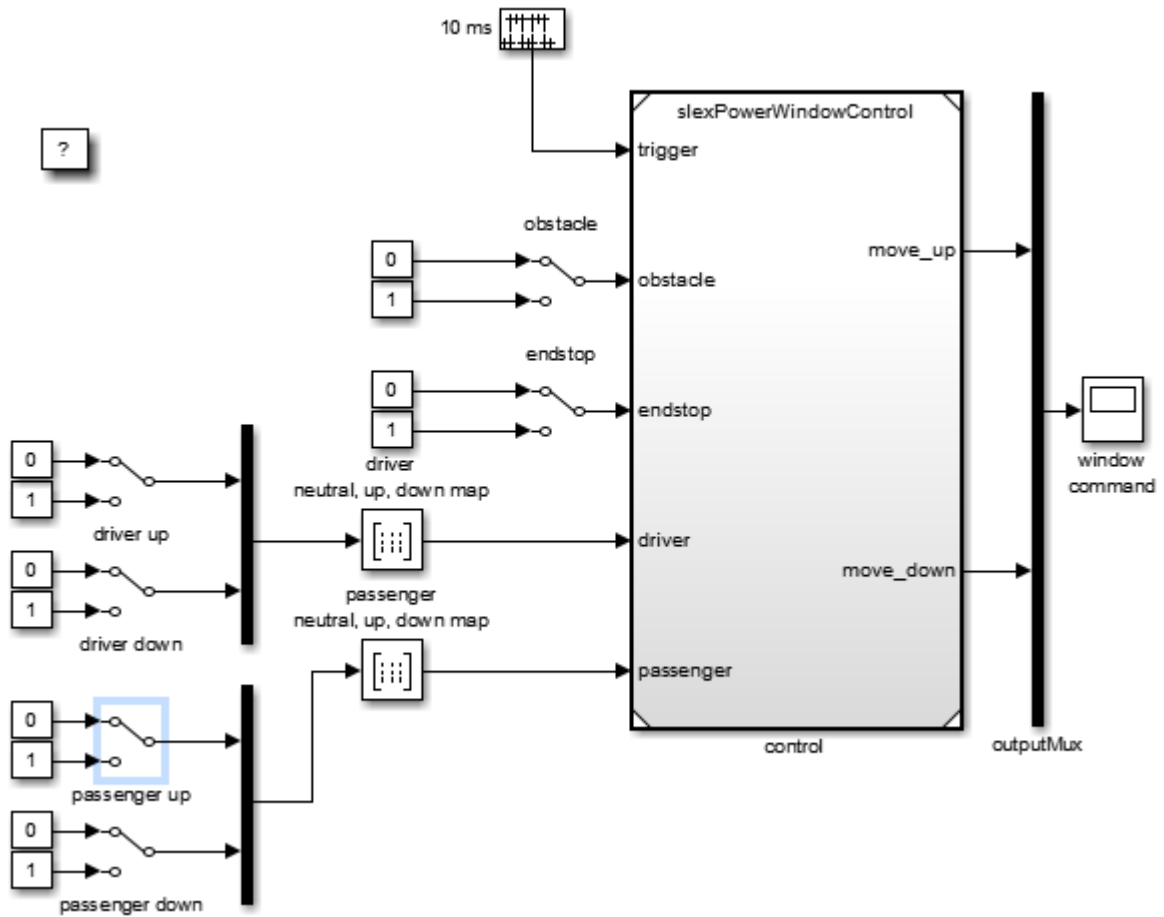

4 Simulate the model.

Setting the endstop switch generates the endstop event.

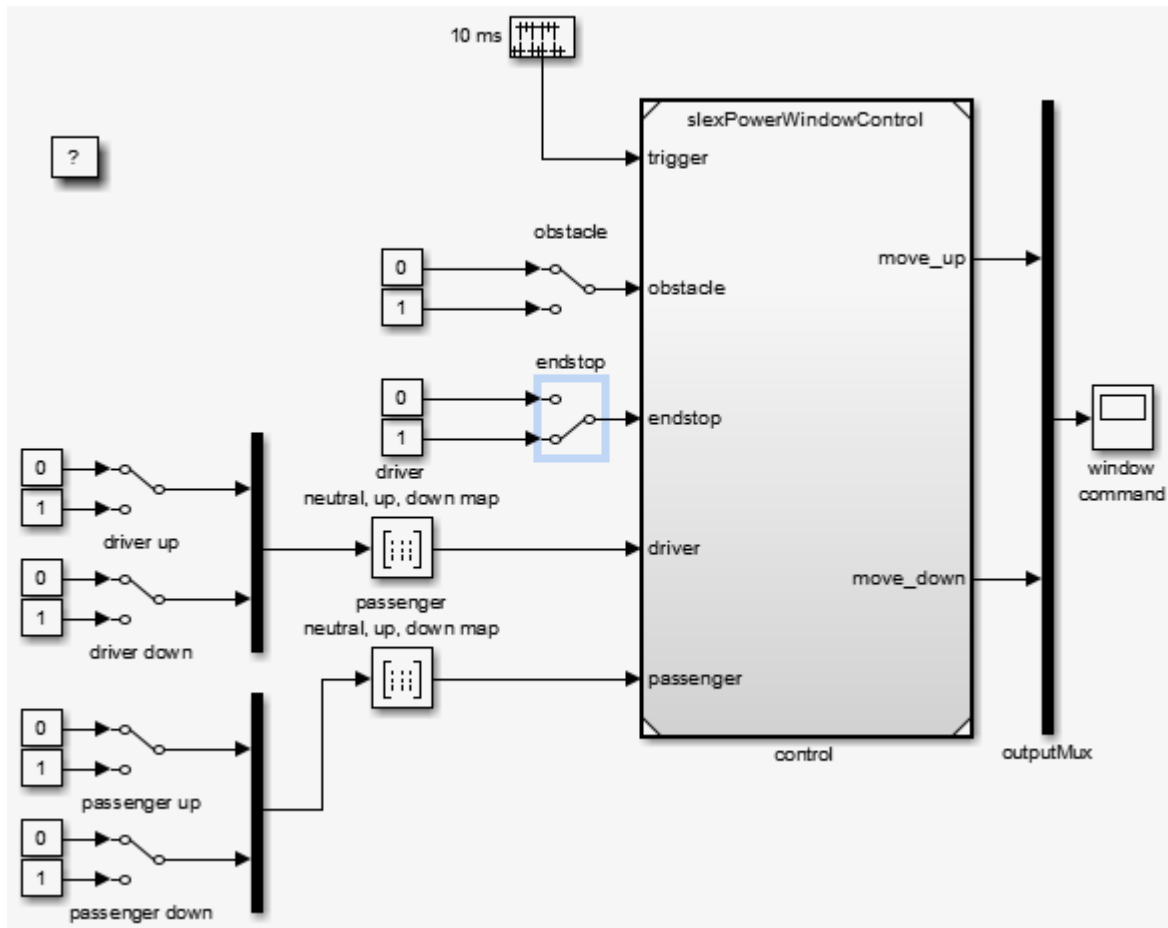

### Case 2: Window Auto-Up

If you press the physical passenger window up switch for a short period of time (less than a second), the software activates auto-up behavior and the window continues to move up.

- 1 Press the physical passenger window up switch for a short period of time (less than a second).

Ultimately, the window reaches the top of the frame and the software generates the `endstop` event. This event moves the state machine back to its neutral state.

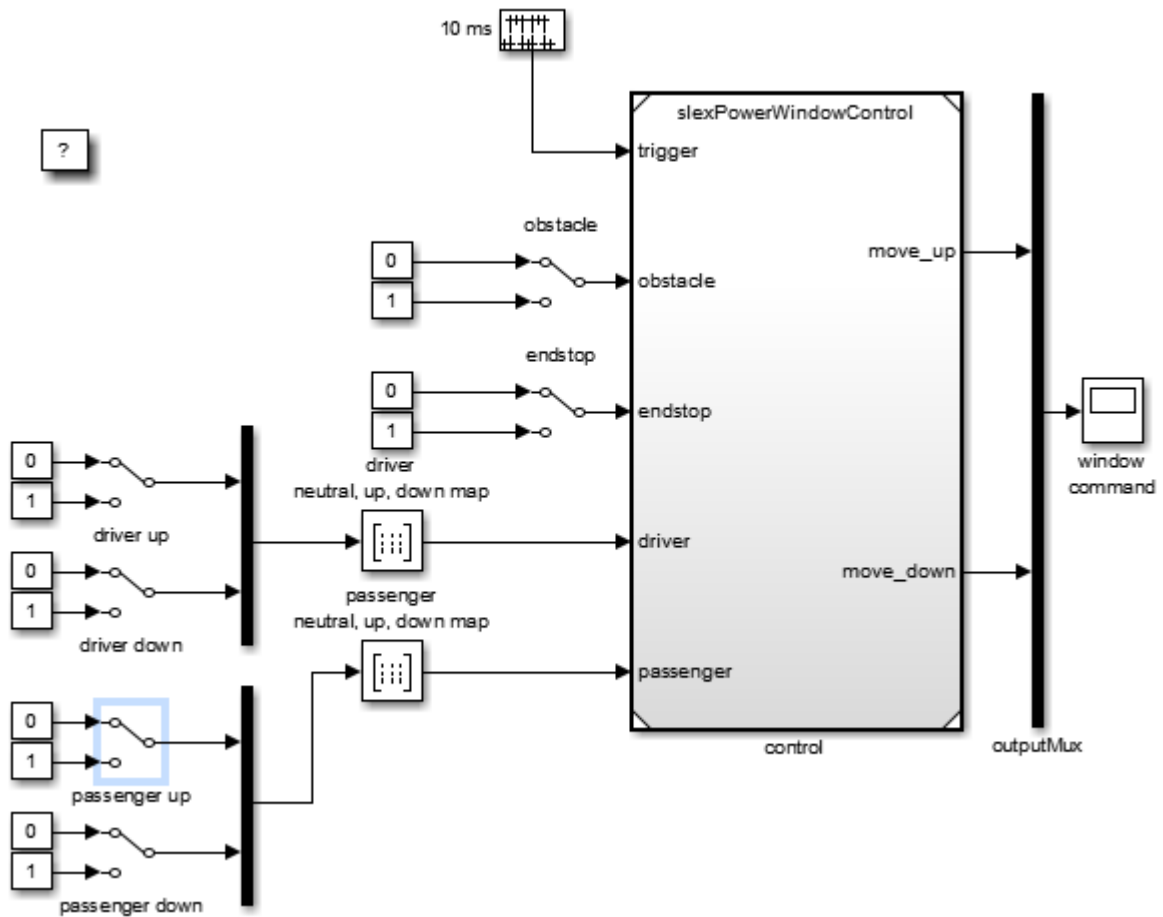

2 Simulate the model.

**Case 3: Driver-Side Precedence**

The driver switch for the passenger window takes precedence over the driver commands. To observe the state machine behavior in this case:

- 1 Run the simulation, and then move the system to the **passenger up** state by double-clicking the passenger window up switch.

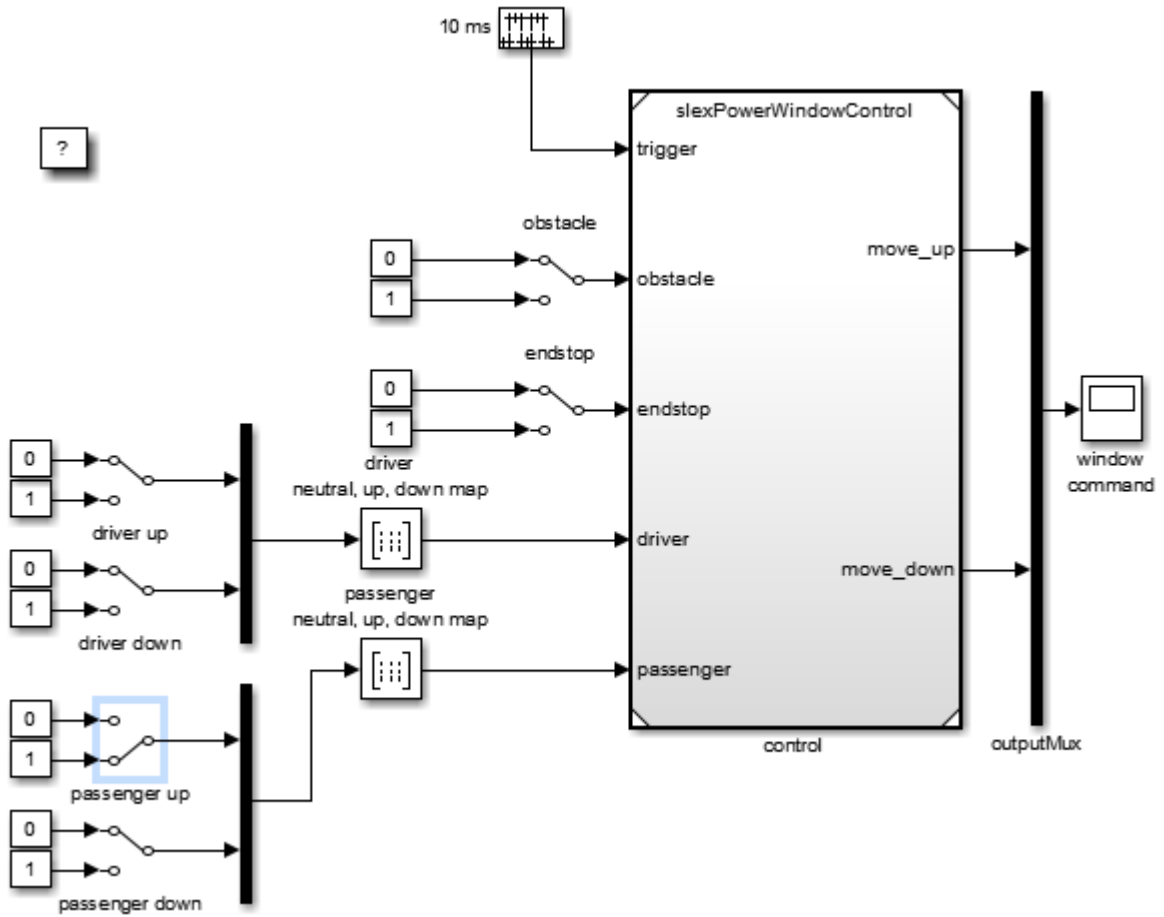

2 Double-click the driver down switch.

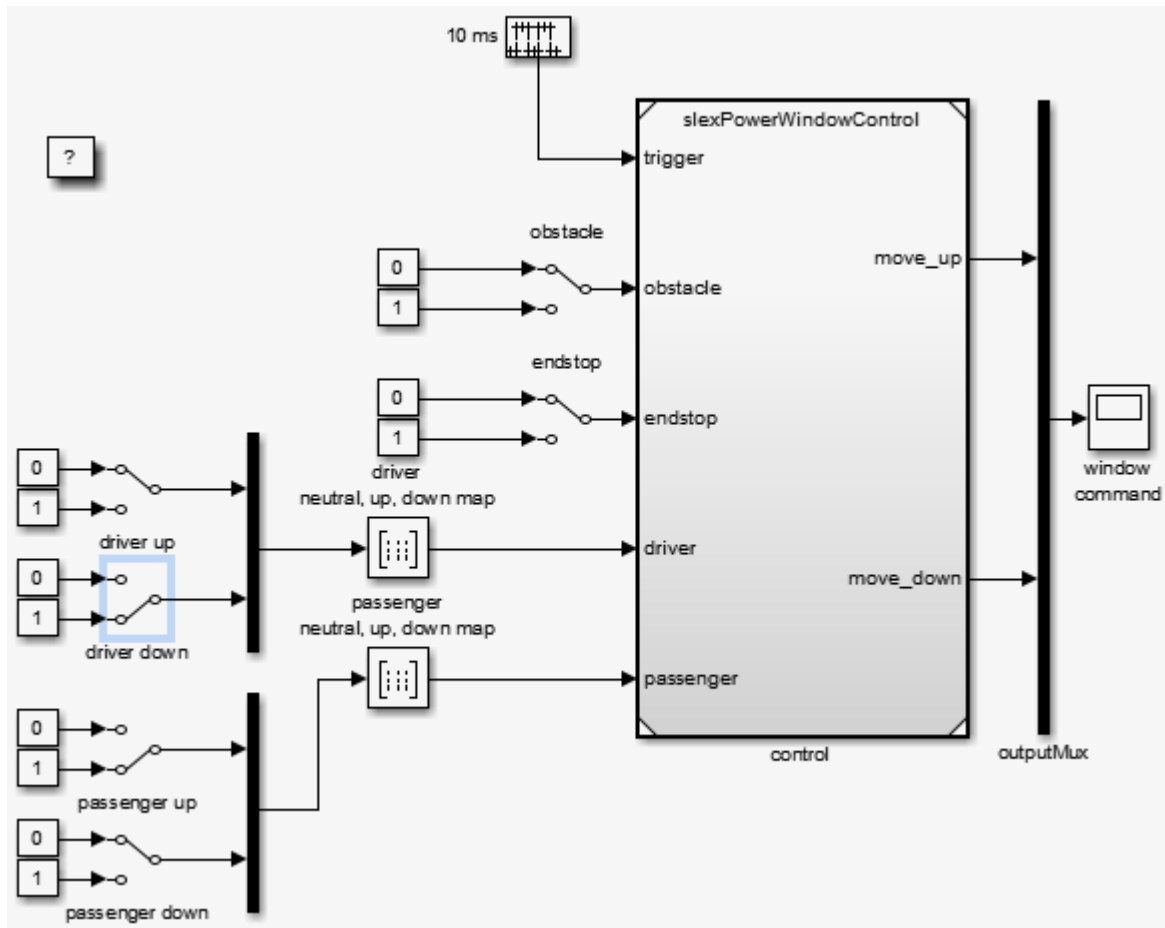

- 3 Simulate the model.
- 4 Notice how the state machine moves to the driver control part to generate the window down output instead of the window up output.
- 5 Double-click the driver control to driver up. Double-click the driver down switch.

The driver window up state is reached, which generates the window up output again, i.e.,  $windowUp = 1$ .

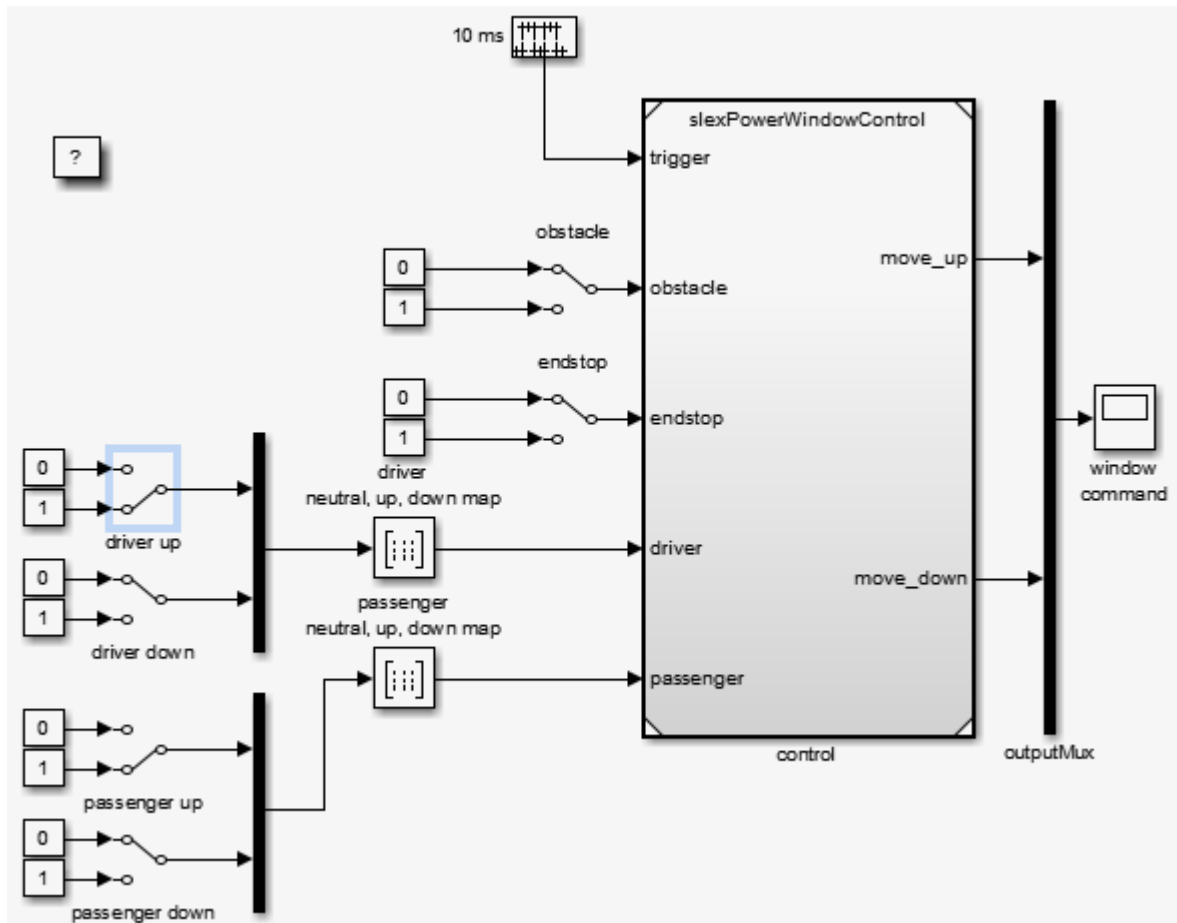

- 6 To observe state behavior when an object is between the window and the frame, double-click the obstacle switch.

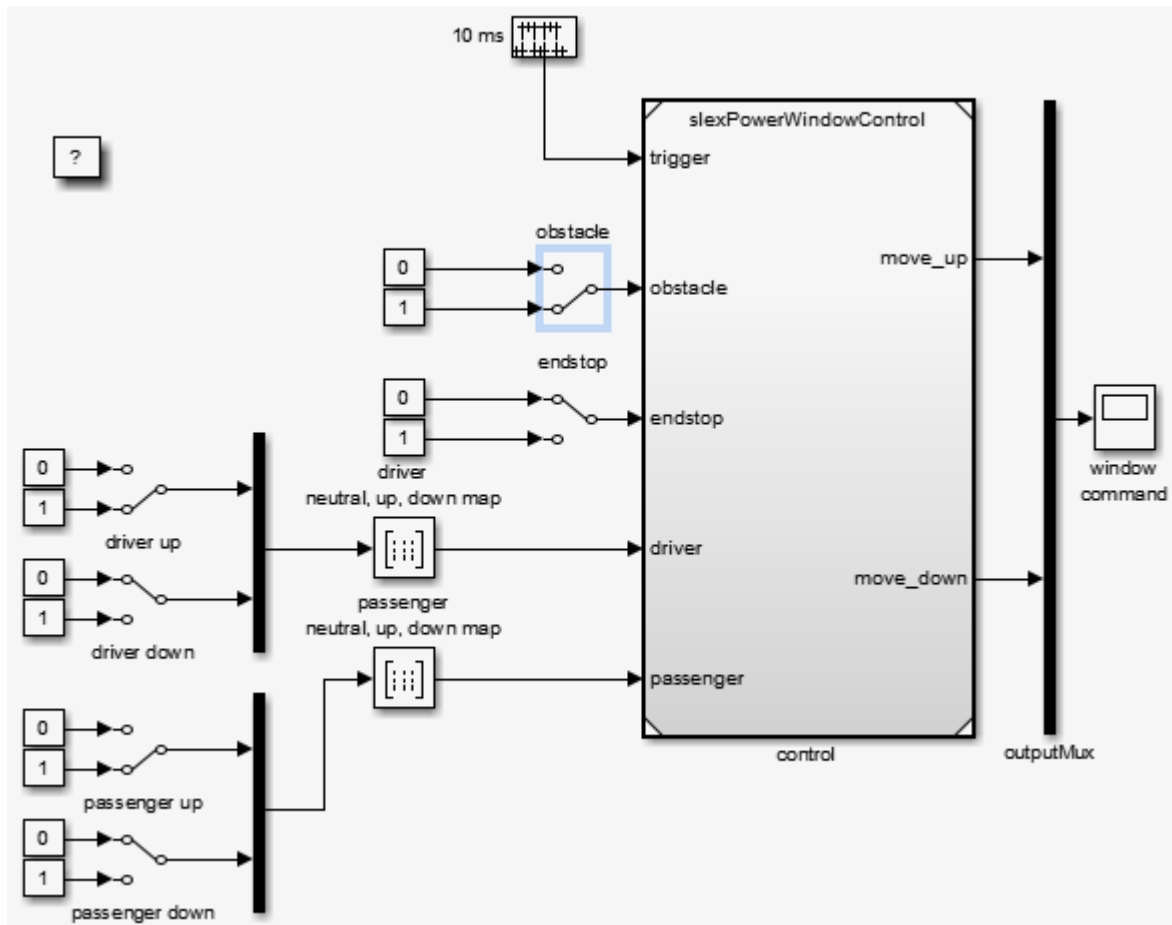

### 7 Simulate the model.

On the next sample time, the state machine moves to its **emergencyDown** state to lower the window a few inches. How far the software lowers the window depends on how long the state machine is in the **emergencyDown** state. This behavior is part of the next analysis phase.

If a driver or passenger window switch is still active, the state machine moves into the up or down states upon the next sample time after leaving the emergency state.



If the obstacle switch is also still active, the software again activates the emergency state at the next sample time.

## Model Coverage

### Validation of the Control Subsystem

Validate the discrete-event control of the window using the model coverage tool. This tool helps you determine the extent to which a model test case exercises the conditional branches of the controller. It helps evaluate whether all transitions in the discrete-event control are taken, given the test case, and whether all clauses in a condition that enables a particular transition have become true. Multiple clauses can enable one transition, e.g., the transition from emergency back to neutral occurs when either 100 ticks have occurred or if the endstop is reached.

To achieve full coverage, each clause evaluates to true and false for the test cases used. The percentage of transitions that a test case exercises is called its *model coverage*. Model coverage is a measure of how thoroughly a test exercises a model.

Using Simulink Verification and Validation software, you can apply the following test to the power window controller.

Position	Step						
	0	1	2	3	4	5	6
Passenger up	0	0	0	0	0	0	0
Passenger down	0	0	0	1	0	1	1
Driver up	0	0	1	0	1	0	1
Driver down	0	1	0	0	1	1	0

With this test, all switches are inactive at time 0. At regular 1 s steps, the state of one or more switches changes. For example, after 1 s, the driver down switch becomes active. To automatically run these input vectors, replace the manual switches by prescribed sequences of input. To see the preconstructed model:

- 1 In the MATLAB Command Window, type:

```
slexPowerWindowCntlCoverage
```

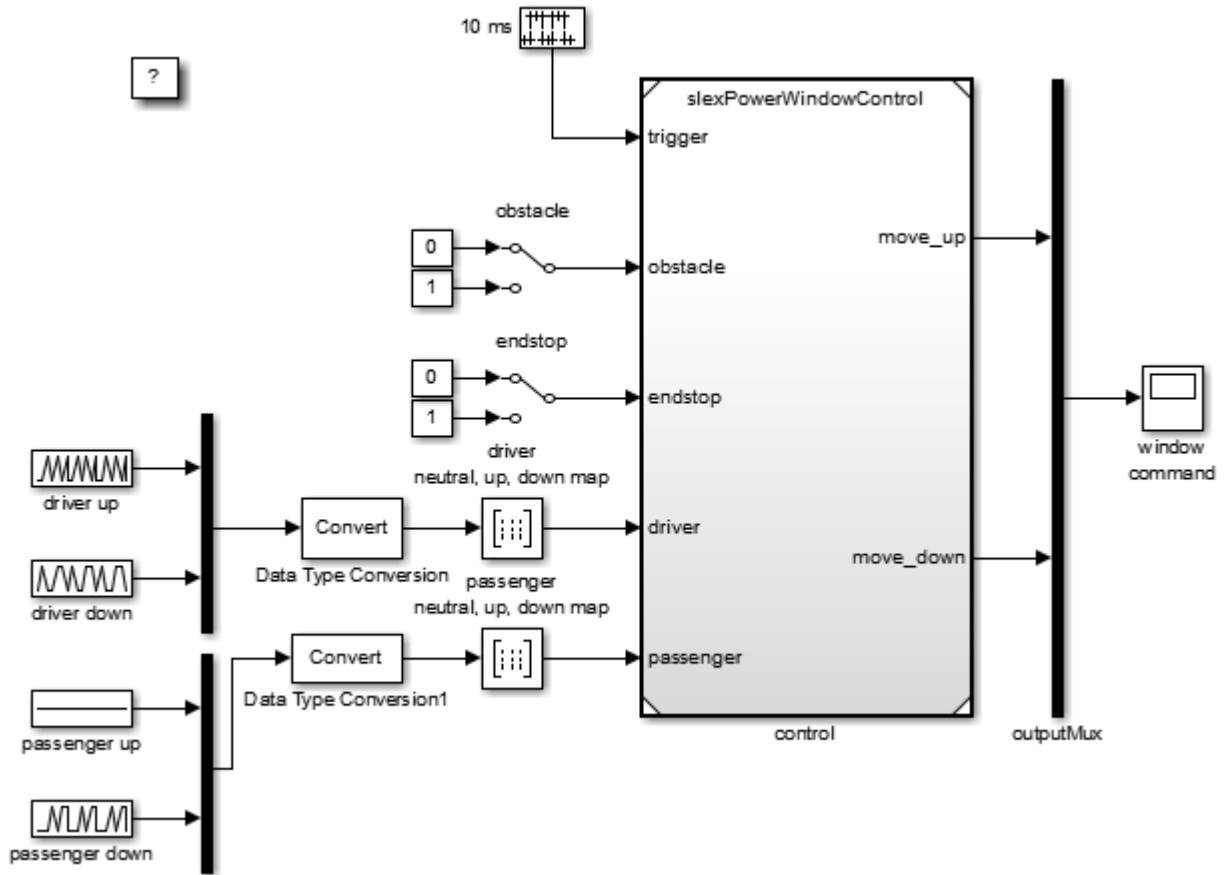

- 2 Simulate the model to generate the Simulink Verification and Validation coverage report.

For the `slexPowerWindowCntrlCoverage` model, the report reveals that this test handles 100% of the decision outcomes from the driver neutral, up, down map. However, the test achieves only 50% coverage for the passenger neutral, up, down map block. This coverage means the overall coverage for `slexPowerWindowCntrlCoverage` is 45% while the overall coverage for the `slexPowerWindowControl` model is 42%. A few of the contributing factors for the coverage levels are:

- Passenger up block does not change.

- Endstop and obstacle blocks do not change.

### Increase Model Coverage

To increase total coverage to 100%, you need to take into account all possible combinations of driver, passenger, obstacle, and endstop settings. When you are satisfied with the control behavior, you can create the power window system. For more information, see “Create Model Using Model-Based Design” on page 22-34.

This example increases the model coverage for the validation of the discrete-event control of the window. To start, the example uses inputs from `slexPowerWindowCntlCoverage` as a baseline for the model coverage. Next, to further exercise the discrete-event control of the window, it creates more input sets. The spreadsheet file, `inputCntlCoverageIncrease.xlsx`, contains these input sets using one input set per sheet.

In the example, the `slexPowerWindowSpreadsheetGeneration` utility function, which creates a spreadsheet template from the controller model, `slexPowerWindowControl`, creates the `inputCntlCoverageIncrease.xlsx`. In `inputCntlCoverageIncrease.xlsx`, the function uses the block names in the controller model as signal names. `slexPowerWindowSpreadsheetGeneration` defines the sheet names. The `slexWindowSpreadsheetAddInput` utility function populates `inputCntlCoverageIncrease.xlsx` with signal data.

The sheet names of these input sets and their descriptions are:

Sheet Name	Description
Logged	Inputs logged from <code>slexPowerWindowCntlCoverage</code>
LoggedObstacleOffEndStopOn	Inputs logged from <code>slexPowerWindowCntlCoverage</code> with ability to hit endstop
LoggedObstacleOnEndStopOff	Inputs logged from <code>slexPowerWindowCntlCoverage</code> with obstacle in window
LoggedObstacleOnEndStopOn	Inputs logged from <code>slexPowerWindowCntlCoverage</code> with obstacle in window and ability to hit endstop
DriverLoggedPassengerNeutral	Inputs logged from <code>slexPowerWindowCntlCoverage</code> for driver only and passenger takes no action
DriverDownPassengerNeutral	Driver is putting down window and passenger takes no action

Sheet Name	Description
DriverUpPassengerNeutral	Driver is putting up window and passenger takes no action
DriverAutoDownPassengerNeutral	Driver is putting down window for one second (auto-down) and passenger takes no action
DriverAutoUpPassengerNeutral	Driver is putting up window for one second (auto-up) and passenger takes no action
PassengerAutoDownDriverNeutral	Passenger is putting down window for one second (auto-down) and driver takes no action
PassengerAutoUpDriverNeutral	Passenger is putting up window for one second (auto-up) and driver takes no action

To automatically run these input vectors, replace the inputs to the discrete-event control with the From Spreadsheet block using the file, `inputCntlCoverageIncrease.xlsx`. This file contains the multiple input sets. To see the preconstructed model:

- 1 In the MATLAB Command Window, type:  
  
`slexPowerWindowCntlCoverageIncrease`

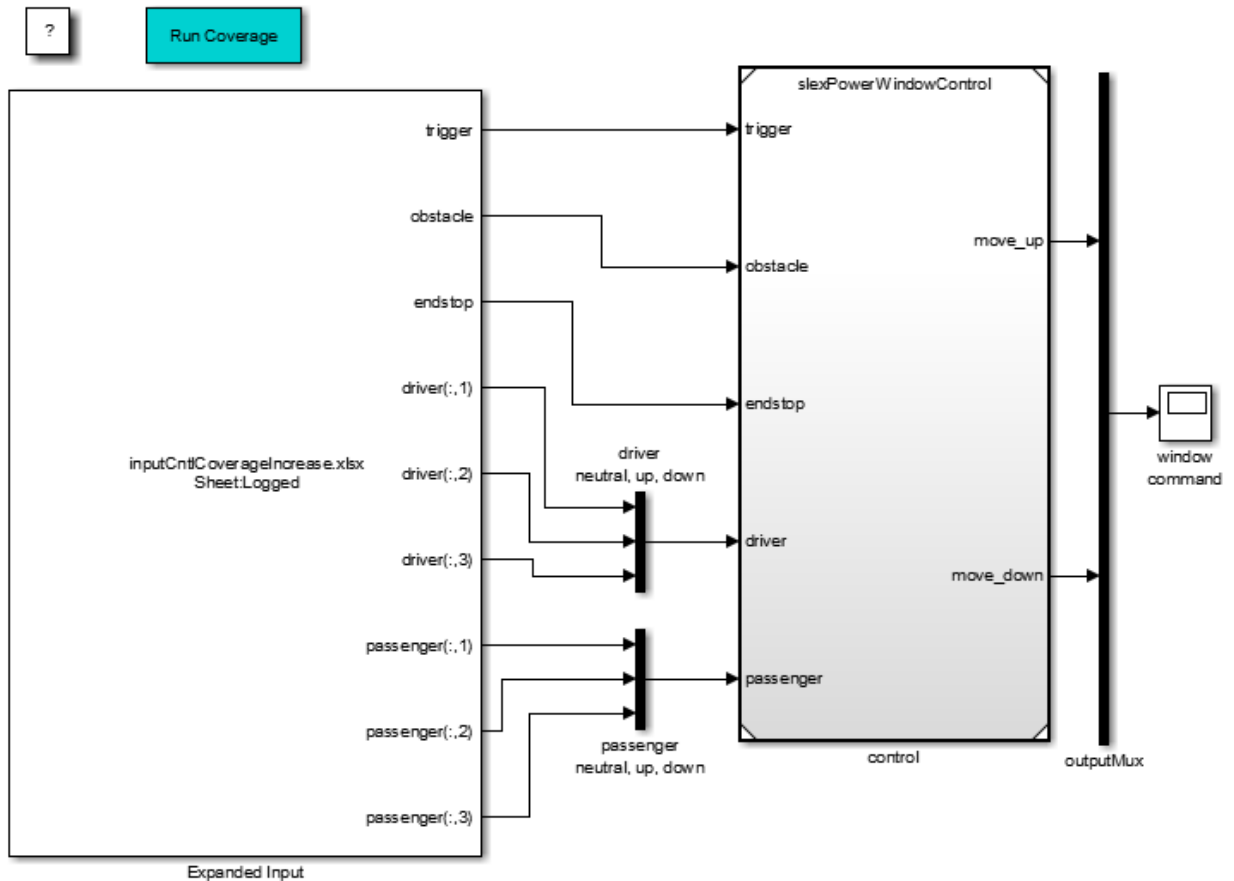

- 2 To generate the Simulink Verification and Validation coverage report for multiple input set, double click the Run Coverage subsystem in the model.

For the `slxPowerWindowCtrlCoverageIncrease` model, the report reveals that using multiple input sets has successfully raised the overall coverage for the `slxPowerWindowControl` model from 42% to 78%. Coverage levels are less than 100% because of missing input sets for:

- Passenger up state
- Driver up and down states

- Passenger automatic down and automatic up states

## **Create Model Using Model-Based Design**

- “Why Use Model-Based Design?” on page 22-34
- “Implementation of Context Diagram: Power Window System” on page 22-35
- “Implement Power Window Control System” on page 22-36
- “Implementation of Activity Diagram: Validate” on page 22-36
- “Implementation of Activity Diagram: Detect Obstacle Endstop” on page 22-38
- “Hybrid Dynamic System: Combine Discrete-Event Control and Continuous Plant” on page 22-39
- “Detailed Modeling of Power Effects” on page 22-43
- “Control Law Evaluation” on page 22-49
- “Visualization of the System in Motion” on page 22-50
- “Realistic Armature Measurement” on page 22-53
- “Communication Protocols” on page 22-55

### **Why Use Model-Based Design?**

In Model-Based Design, a system model is at the center of the development process, from requirements development, through design, implementation, and testing. Use Model-Based Design to:

- Use a common design environment across project teams.
- Link designs directly to requirements.
- Integrate testing with design to continuously identify and correct errors.
- Refine algorithms through multidomain simulation.
- Automatically generate embedded software code.
- Develop and reuse test suites.
- Automatically generate documentation for the model.
- Reuse designs to deploy systems across multiple processors and hardware targets.

For more information, see “Model-Based Design”.

## Implementation of Context Diagram: Power Window System

For requirements presented as a context diagram, see “Context Diagram: Power Window System” on page 22-4.

Create a Simulink model to resemble the context diagram.

- 1 Place the plant behavior into one subsystem.
- 2 Create two subsystems that contain the driver and passenger switches.
- 3 Add a control mechanism to conveniently switch between the presence and absence of the object.
- 4 Put the control in one subsystem.
- 5 Connect the new subsystems.
- 6 To see an implementation of this model, in the MATLAB Command Window, type:

```
slexPowerWindowStart
```

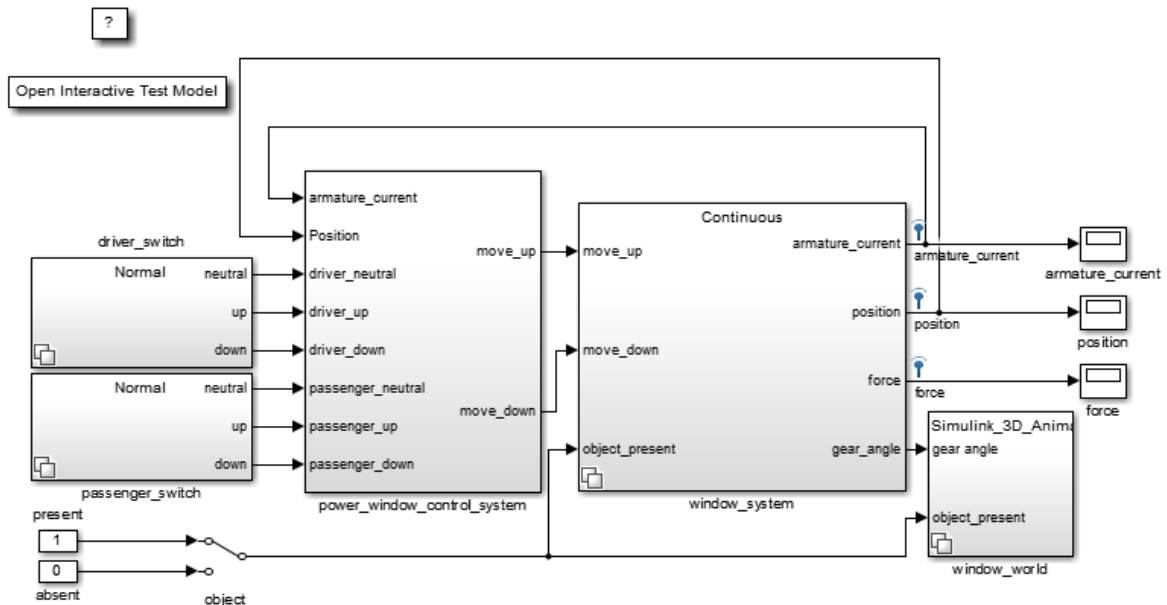

You can use the power window control activity diagram (“Activity Diagram: Power Window Control” on page 22-5) to decompose the power window controller of the

context diagram into parts. This diagram shows the input and output signals present in the context diagram for easier tracing to their origins.

### Implement Power Window Control System

To satisfy full requirements, the power window control must work with the validation of the driver and passenger inputs and detect the endstop.

For requirements presented as an activity diagram, see “Activity Diagram: Power Window Control” on page 22-5.

Double-click the slxPowerWindowExample/power\_window\_control\_system block to open the following subsystem:

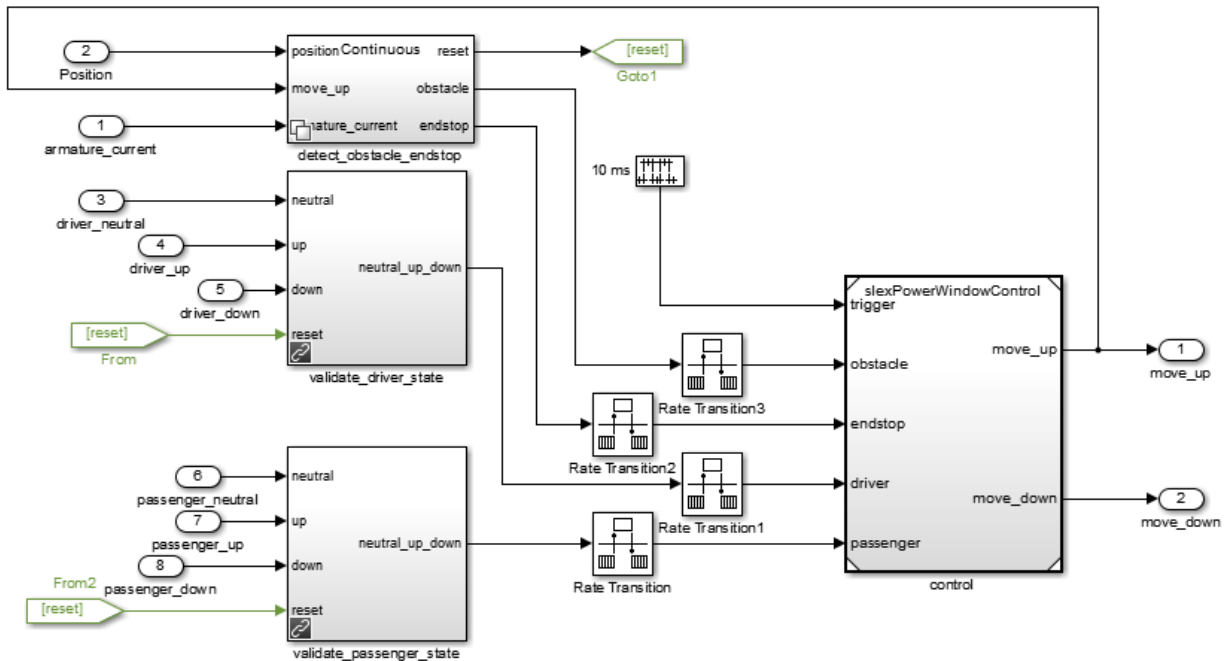

### Implementation of Activity Diagram: Validate

For requirements presented as activity diagrams, see “Activity Diagram: Validate Driver” on page 22-6 and “Activity Diagram: Validate Passenger” on page 22-8.



The activity diagram adds data validation functionality for the driver and passenger commands to ensure correct operation. For example, when the window reaches the top, the software blocks the up command. The implementation decomposes each validation process in new subsystems. Consider the validation of the driver commands (validation of the passenger commands is similar). Check if the model can execute the up or down commands, according to the following:

- The model allows the **down** command only when the window is not completely opened.
- The model allows the **up** command only when the window is not completely closed and no object is detected.

The third activity diagram process checks that the software sends only one of the three commands (**neutral**, **up**, **down**) to the controller. In an actual implementation, both **up** and **down** can be simultaneously true (for example, because of switch bouncing effects).

From the `power_window_control_system` subsystem, this is the `validate_driver_state` subsystem:

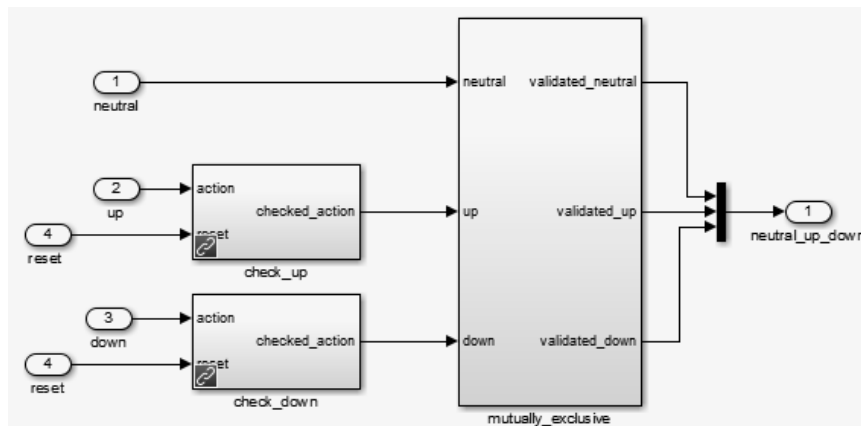

From the `power_window_control_system` subsystem, this is the `validate_passenger_state` subsystem:

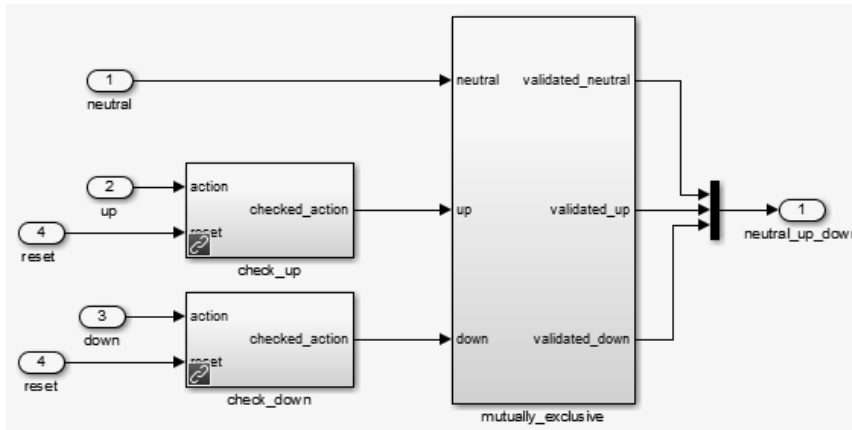

### Implementation of Activity Diagram: Detect Obstacle Endstop

For requirements presented as an activity diagram, see “Activity Diagram: Detect Obstacle Endstop” on page 22-9.

In the `slexPowerWindowExample` model, the `power_window_control_system/detect_obstacle_endstop` block implements this activity diagram in the continuous variant of the Variant Subsystem block. During design iterations, you can add additional variants.



Double-click the `slexPowerWindowExample` model `power_window_control_system/detect_obstacle_endstop/Continuous/verify_position` block:

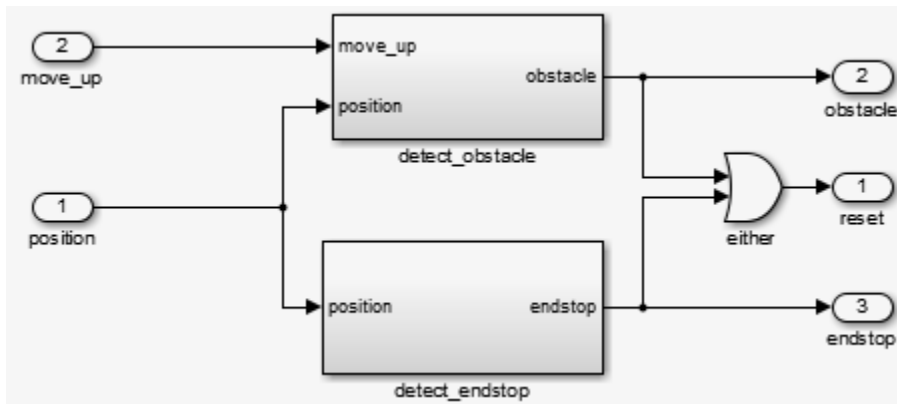

### Hybrid Dynamic System: Combine Discrete-Event Control and Continuous Plant

After you have designed and verified the discrete-event control, integrate it with the continuous-time plant behavior. This step is the first iteration of the design with the simplest version of the plant.

In Simulink Project, navigate to **Files** and click **Project Files**. In the **configureModel** folder, run the `slexPowerWindowContinuous` utility to open and initialize the model.

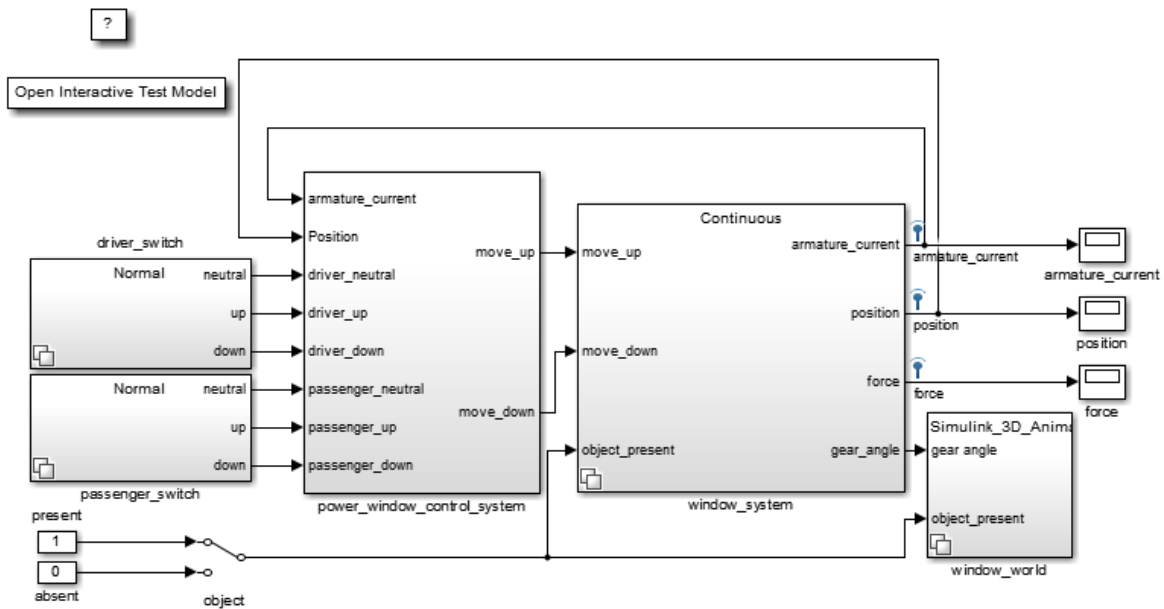

The window\_system block uses the Variant Subsystem block to allow for varying levels of fidelity in the plant modeling. Double-click the window\_system/Continuous/2nd\_order\_window\_system block to see the continuous variant.

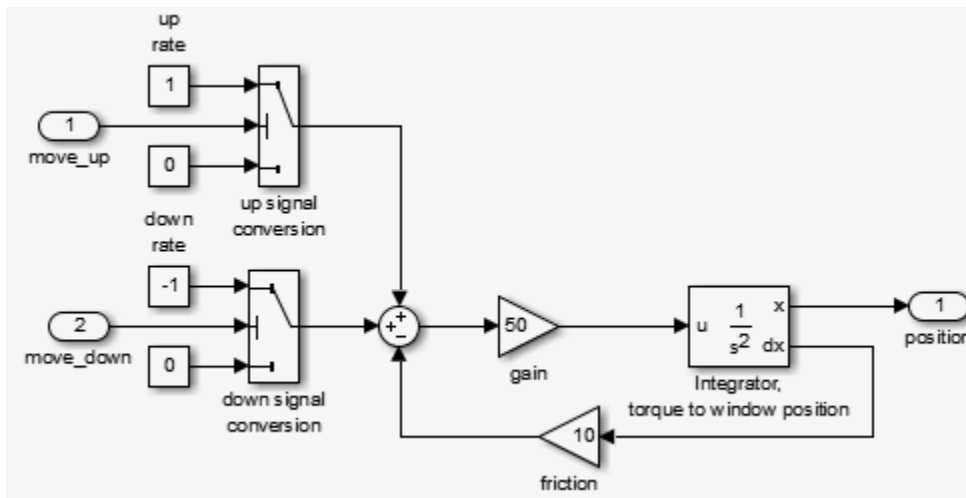

The plant is modeled as a second-order differential equation with step-wise changes in its input:

- When the Stateflow chart generates `windowUp`, the input is 1.
- When the Stateflow chart generates `windowDown`, the input is  $-1$ .
- Otherwise, the input is 0.

This phase allows analysis of the interaction between the discrete-event state behavior, its sample rate, and the continuous behavior of the window movement. There are threshold values to generate the window frame top and bottom:

- `endStop`
- Event when an obstacle is present, that is, `obstacle`
- Other events

Double-click the `slexPowerWindowExample` model `power_window_control_system/-detect_obstacle_endstop/Continuous/verify_position` block to see the continuous variant.

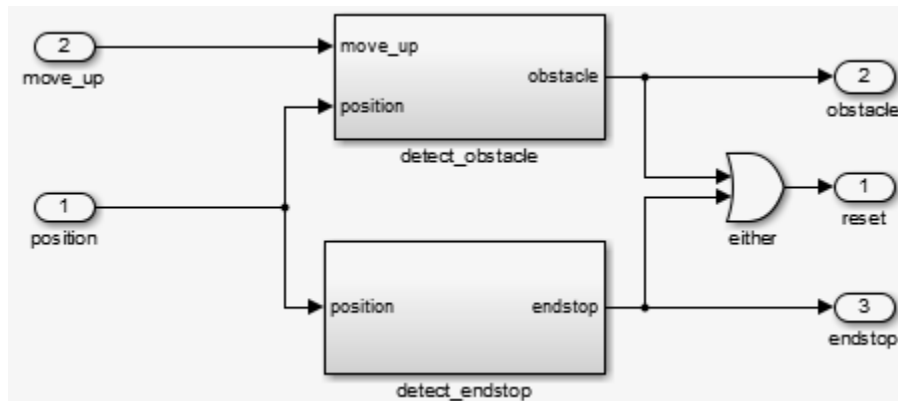

When you run the `slexPowerWindowContinuous` `configureModel` utility, the model uses the continuous time solver `ode23` (Bogacki-Shampine).

A structure analysis of a system results in:

- A functional decomposition of the system
- Data definitions with the specifics of the system signals

- Timing constraints

A structure analysis can also include the implementation architecture (outside the scope of this discussion).

The implementation also adds a control mechanism to conveniently switch between the presence and absence of the object.

### Expected Controller Response

To view the window movement, in Simulink Project in the **Shortcut Management** section, right-click `SimHybridPlantLowOrder`, and select **Run**. Alternatively, you can run the task `slexPowerWindowContinuousSim`.

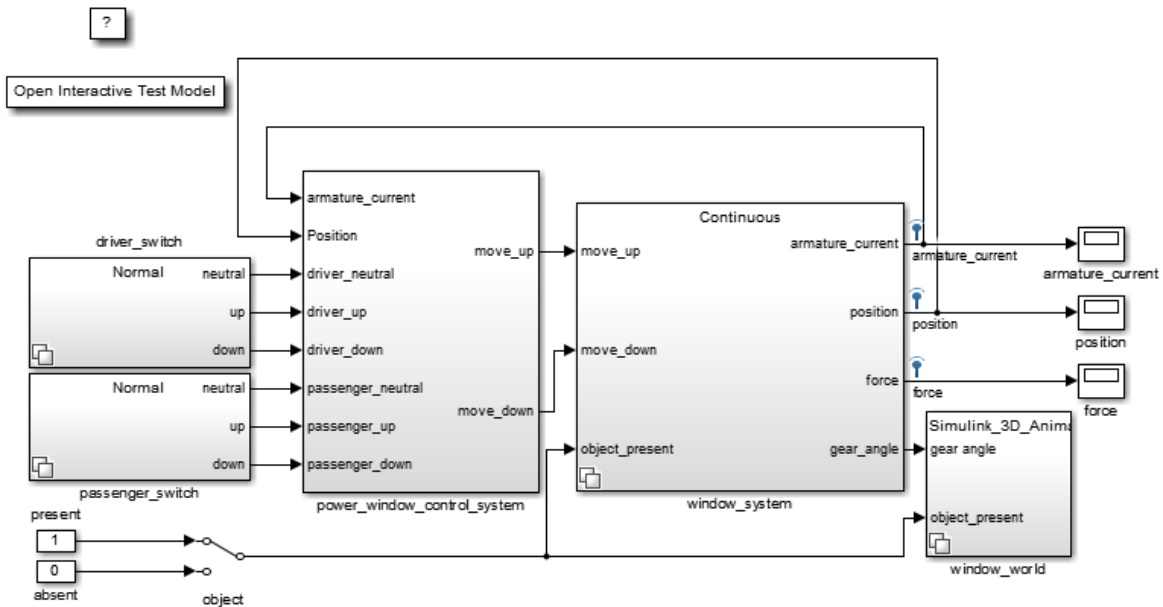

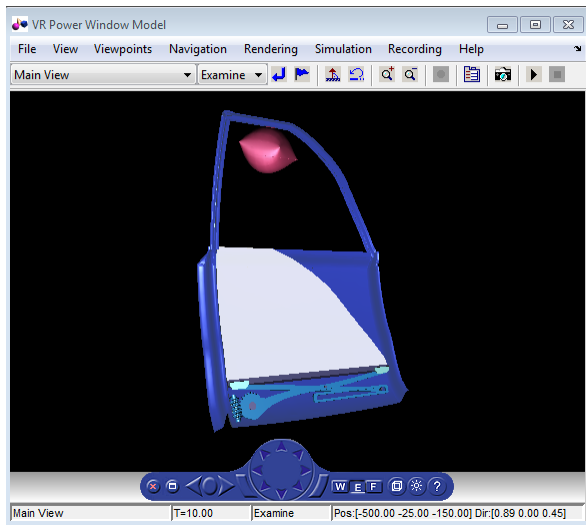

The position scope shows the expected result from the controller. After 30 cm, the model generates the **obstacle** event and the Stateflow chart moves into its **emergencyDown** state. In this state, **windowDown** is output until the window lowers by about 10 cm. Because the passenger window up switch is still on, the window starts moving up again and this process repeats. Stop the simulation and open the position scope to observe the oscillating process. In case of an emergency, the discrete-event control rolls down the window approximately 10 cm.

### Detailed Modeling of Power Effects

After an initial analysis of the discrete-event control and continuous dynamics, you can use a detailed plant model to evaluate performance in a more realistic situation. It is best to design models at such a level of detail in the power domain, in other words, as energy flows. Several domain-specific MathWorks blocksets can help with this.

To take into account energy flows, add a more detailed variant consisting of power electronics and a multibody system to the `window_system` variant subsystem.

To open the model and explore the more detailed plant variant, in Simulink Project, run `configureModel slxPowerWindowPowerEffects`.

Double-click the `slxPowerWindowExample` model `window_system/Power Effects - Visualization/detailed_window_system` block.

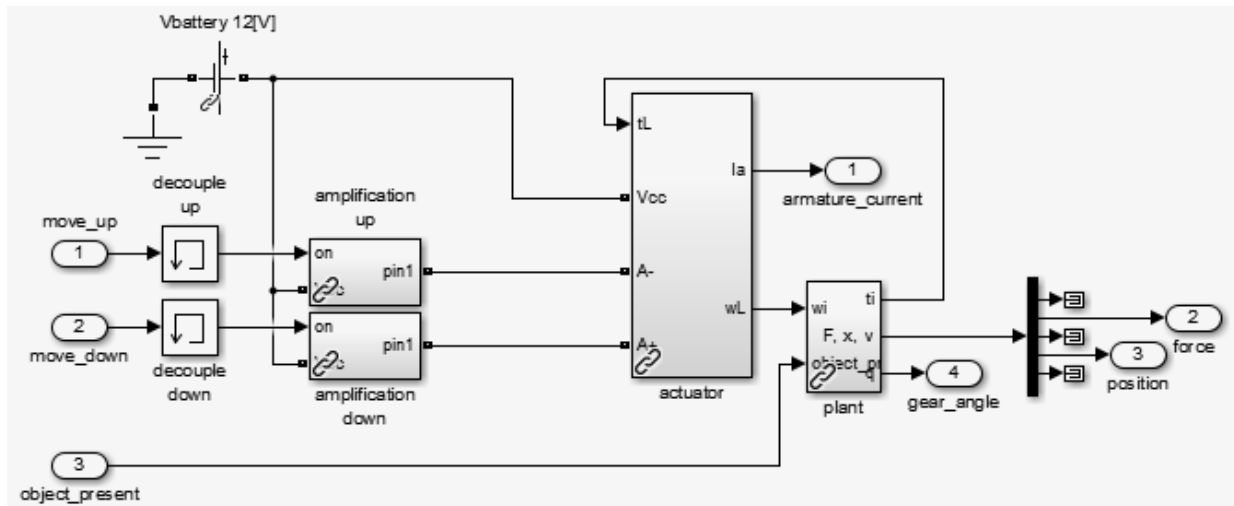

### Power Electronics Subsystem

The model must amplify the control signals generated by the discrete-event controller to be powerful enough to drive the DC motor that moves the window.

The amplification modules model this behavior. They show that a switch either connects the DC motor to the battery voltage or ground. By connecting the battery in reverse, the system generates a negative voltage and the window can move up, down, or remain still. The window is always driven at maximum power. In other words, no DC motor controller applies a prescribed velocity.

To see the implementation, double-click the `slxPowerWindowExample` model `window_system/Power Effects - Visualization/detailed_window_system/amplification_up` block.



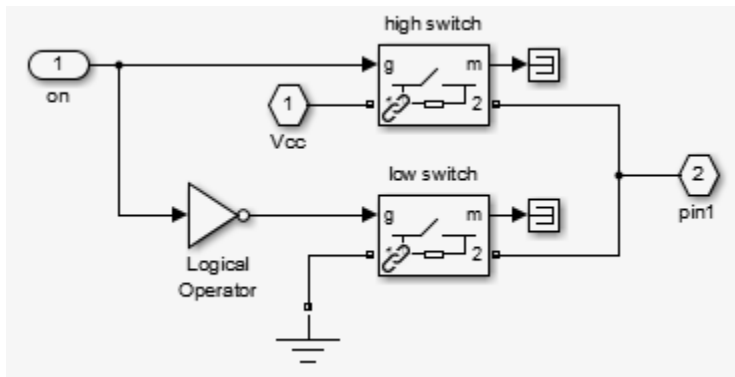

### Multibody System

This implementation models the window using Simscape Multibody multibody blocks.

To see the actuator implementation, double-click the `slexPowerWindowExample` model `window_system/Power Effects - Visualization/detailed_window_system/actuator` block.

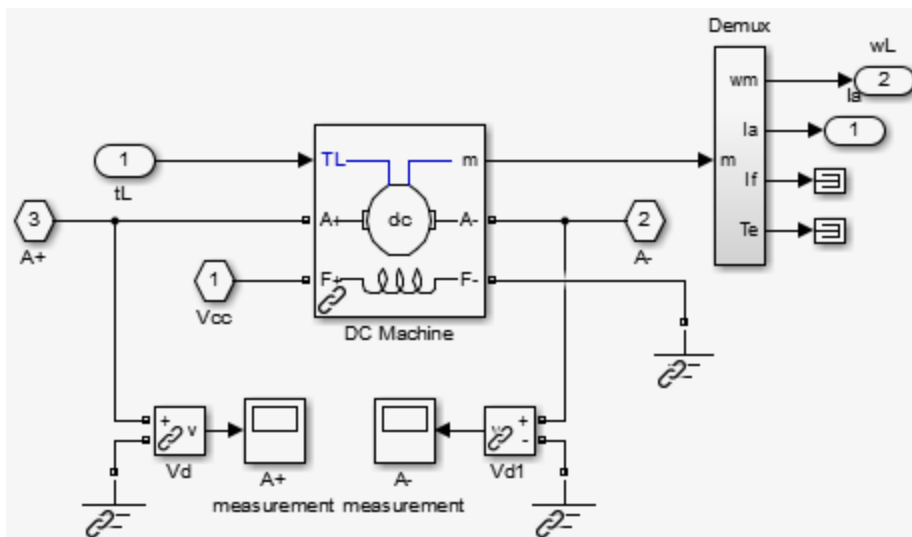

To see the window implementation, double-click the `slexPowerWindowExample` model `window_system/Power Effects - Visualization/detailed_window_system/plant` block.

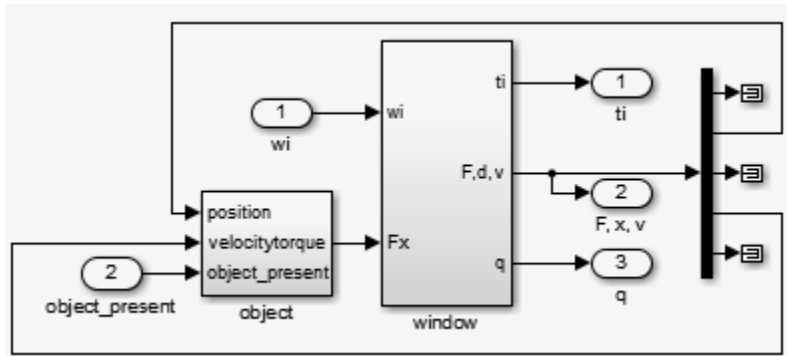

This implementation uses Simscape Multibody multibody blocks for bodies, joints, and actuators. The window model consists of:

- A worm gear
- A lever to move the window holder in the vertical direction

The figure shows how the mechanical parts move.

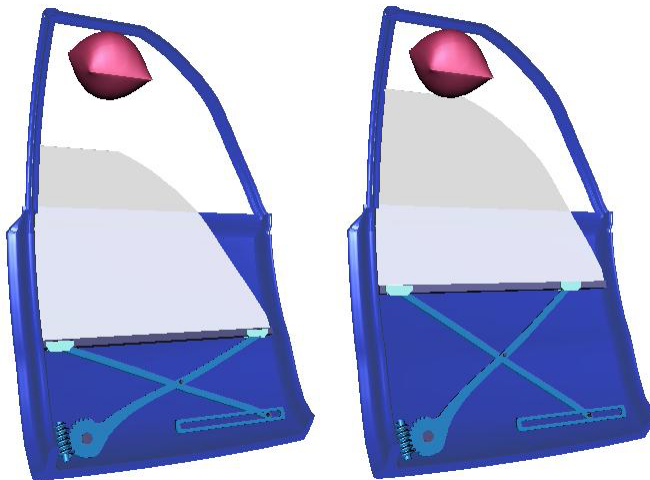

### Iterate on the Design

An important effect of the more detailed implementation is that there is no window position measurement available. Instead, the model measures the DC motor current and uses it to detect the endstops and to see if an obstacle is present. The next stage of the

system design analyzes the control to make sure that it does not cause excessive force when an obstacle is present.

In the original system, the design removes the obstacle and endstop detection based on the window position and replaces it with a current-based implementation. It also connects the process to the controller and position and force measurements. To reflect the different signals used, you must modify the data definition. In addition, observe that, because of power effects, the units are now amps.

PSPEC 1.3.1: DETECT ENDSTOP  
 $\text{ENDSTOP} = \text{ARMATURE\_CURRENT} > \text{ENDSTOP\_MAX}$

PSPEC 1.3.2: DETECT OBSTACLE  
 $\text{OBSTACLE} = (\text{ARMATURE\_CURRENT} > \text{OBSTACLE\_MAX})$  and MOVE\_UP for 500 ms

PSPEC 1.3.3: ABSOLUTE VALUE  
 $\text{ABSOLUTE\_ARMATURE\_CURRENT} = \text{abs}(\text{ARMATURE\_CURRENT})$

This table lists the additional signal for the Context Diagram: Power Window System data definitions.

#### Context Diagram: Power Window System Data Definition Changes

Signal	Information Type	Continuous/ Discrete	Data Type	Values
ARMATURE_CURRENT	Data	Continuous	Real	-20 to 20 A

This table lists the changed signals for the Activity Diagram: Detect Obstacle Endstop data definitions.

#### Activity Diagram: Detect Obstacle Endstop Data Definition Changes

Signal	Information Type	Continuous/ Constant	Data Type	Values
ABSOLUTE_ARMATURE_CURRENT	Data	Continuous	Real	0 to 20 A
ENDSTOP_MAX	Data	Constant	Real	15 A
OBSTACLE_MAX	Data	Constant	Real	2.5 A

To see the window subsystem, double-click the `slexPowerWindowExample` model `window_system/Power Effects - Visualization/detailed_window_system/plant/window` block.

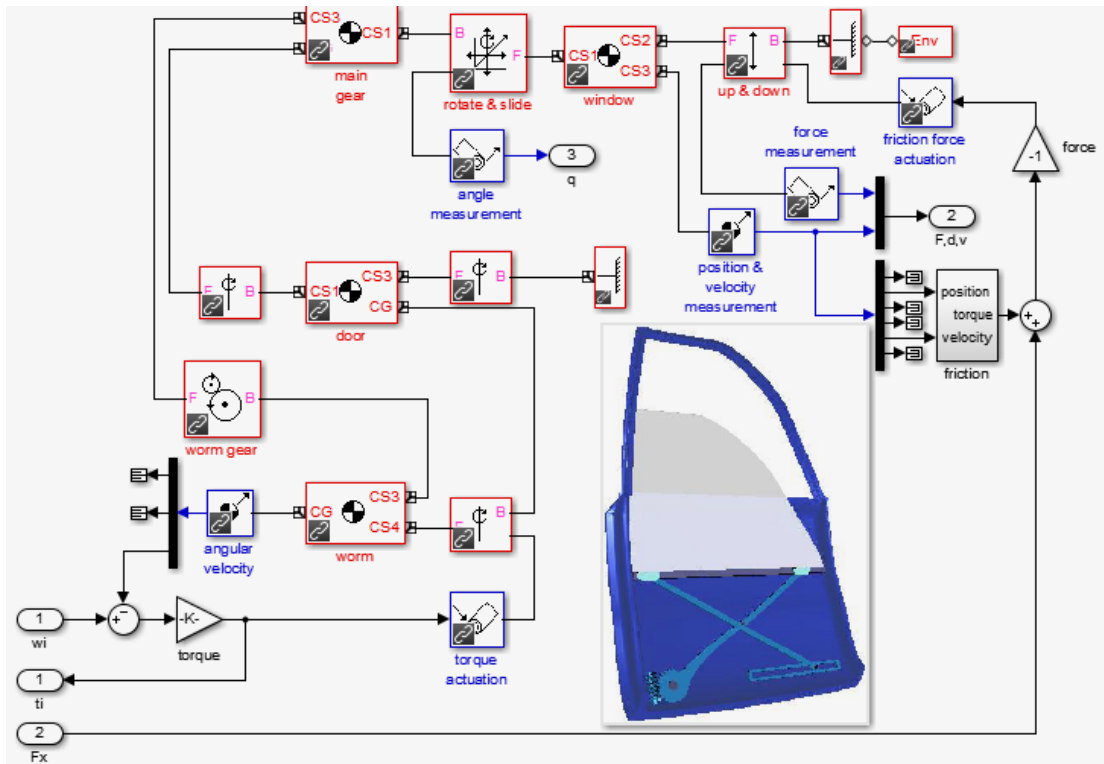

The implementation uses a lookup table and adds noise to allow evaluation of the control robustness. To see the implementation of the friction subsystem, double-click the `slexPowerWindowExample` model `window_system/Power Effects - Visualization/detailed_window_system/plant/window/friction` block.

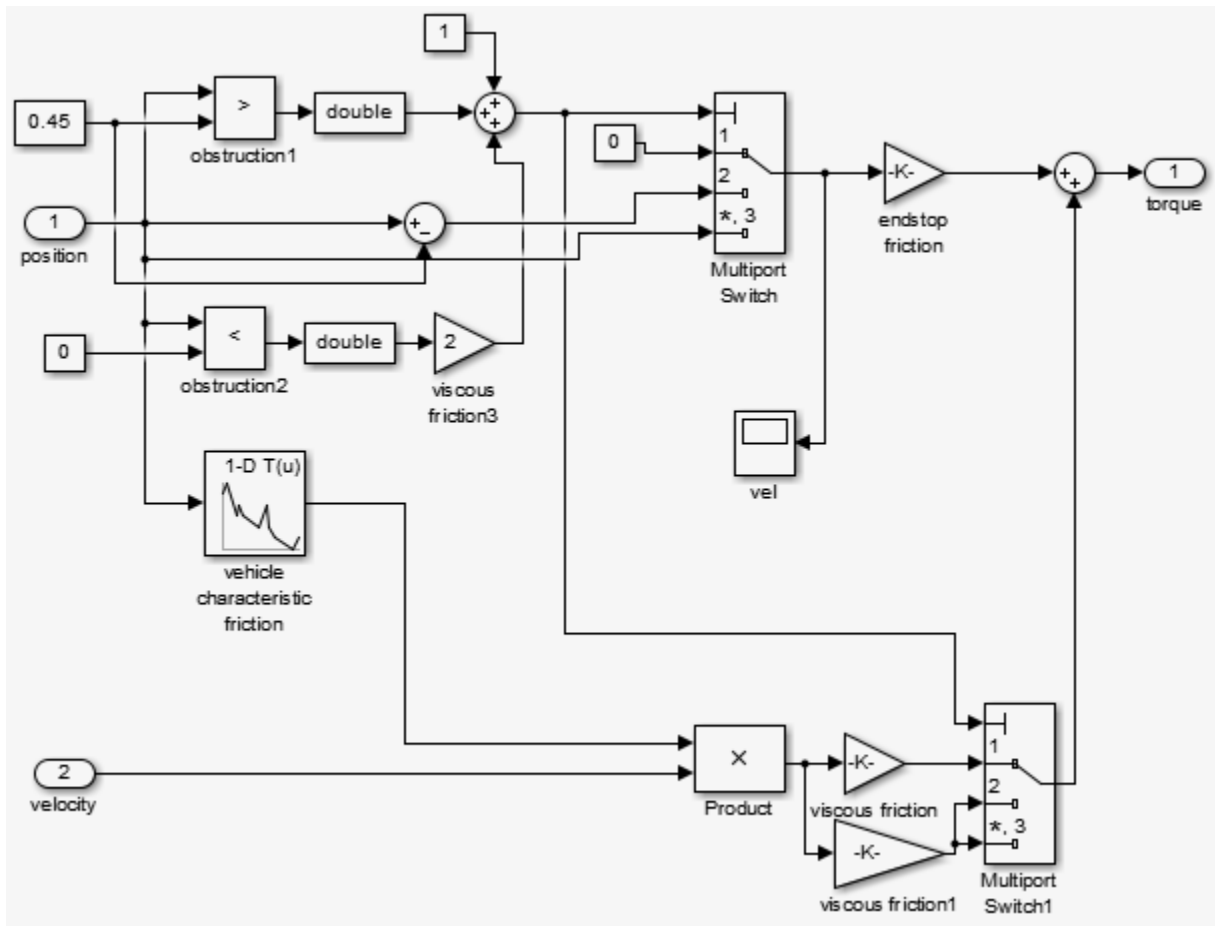

### Control Law Evaluation

The idealized continuous plant allows access to the window position for `endStop` and `obstacle` event generation. In the more realistic implementation, the model must generate these events from accessible physical variables. For power window systems, this physical variable is typically the armature current,  $I_a$ , of the DC motor that drives the worm gear.

When the window is moving, this current has an approximate value of 2 A. When you switch the window on, the model draws a transient current that can reach a value

of approximately 10 A. When the current exceeds 15 A, the model activates endstop detection. The model draws this current when the angular velocity of the motor is kept at almost 0 despite a positive or negative input voltage.

Detecting the presence of an object is more difficult in this setup. Because safety concerns restrict the window force to no more than 100 N, an armature current much less than 10 A should detect an object. However, this behavior conflicts with the transient values achieved during normal operation.

Implement a control law that disables object detection during achieved transient values. Now, when the system detects an armature current more than 2 A, it considers an object to be present and enters the **emergencyDown** state of the discrete-event control. Open the force scope window (measurements are in newtons) to check that the force exerted remains less than 100 N when an object is present and the window reverses its velocity.

In reality, far more sophisticated control laws are possible and implemented. For example, you can implement neural-network-based learning feedforward control techniques to emulate the friction characteristic of each individual vehicle and changes over time.

### **Visualization of the System in Motion**

If you have Simulink 3D Animation software installed, you can view the geometrics of the system in motion via a virtual reality world. If the VR Sink block is not yet open, in the `slexPowerWindowExample/window_world/Simulink_3D_Animation View` model, double-click the VR Sink block.

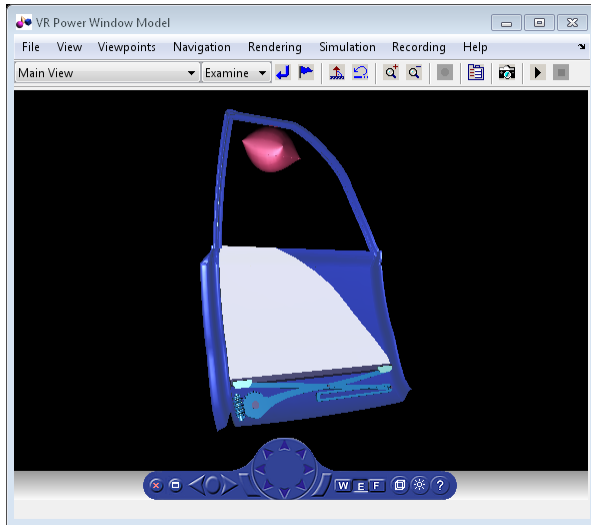

To simulate the model with a stiff solver:

- 1 In Simulink Project, run the task, `slexPowerWindowPowerEffectsSim`. This batch job sets the solver to `ode23tb` (stiff/TR-BDF2).
- 2 In the `slexPowerWindowExample` model `passenger_switch/Normal` block, set the passenger up switch to on.
- 3 In the `slexPowerWindowExample` model `driver_switch/Normal` block, set the driver up switch to off.
- 4 Simulate the model.
- 5 Between 10 ms and 1 s in simulation time, switch off the `slexPowerWindowExample/passenger_switch/Normal` block passenger up switch to initiate the auto-up behavior.

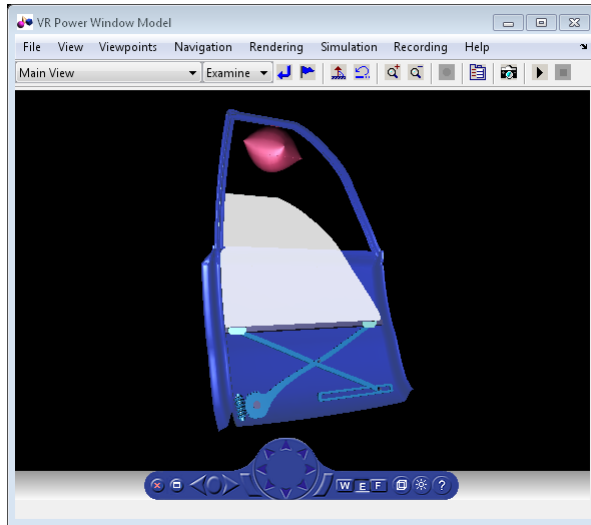

- 6 Observe how the window holder starts to move vertically to close the window. When the model encounters the object, it rolls the window down.
- 7 Double-click the `slexPowerWindowExample` model `passenger_switch/Normal` block driver down switch to roll down the window completely and then simulate the model. In this block, at less than one second simulation time, switch off the driver down switch to initiate the auto-down behavior.



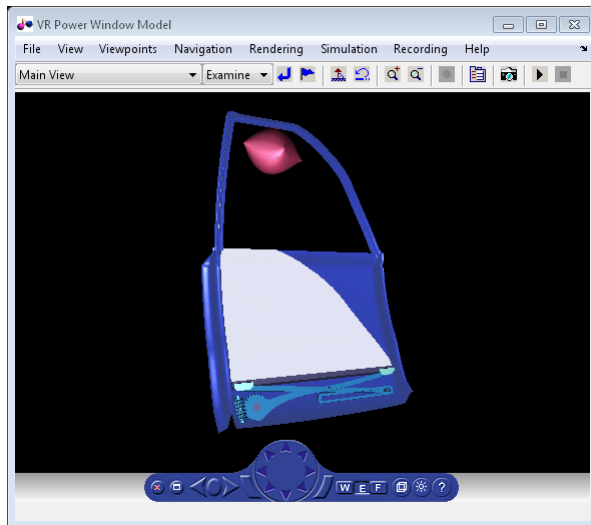

- 8 When the window reaches the bottom of the frame, stop the simulation.
- 9 Look at the position measurement (in meters) and at the armature current ( $I_a$ ) measurement (in amps).

---

**Note:** The absolute value of the armature current transient during normal behavior does not exceed 10 A. The model detects the obstacle when the absolute value of the armature current required to move the window up exceeds 2.5 A (in fact, it is less than  $-2.5$  A). During normal operation, this is about 2 A. You might have to zoom into the scope to see this measurement. The model detects the window endstop when the absolute value of the armature current exceeds 15 A.

---

Variation in the armature current during normal operation is due to friction that is included by sensing joint velocities and positions and applying window specific coefficients.

### Realistic Armature Measurement

The armature current as used in the power window control is an ideal value that is accessible because of the use of an actuator model. In a more realistic situation, data acquisition components must measure this current value.

To include data acquisition components, add the more realistic measurement variant to the window\_system variant subsystem. This realistic measurement variant contains a signal conditioning block in which the current is derived based on a voltage measurement.

To open a model and configure the realistic measurement, in Simulink Project, run the configureModel task `slexPowerWindowRealisticArmature`.

To view the contents of the Realistic Armature - Communications Protocol block, double-click the `SlexPowerWindowExample` model `window_system/Realistic Armature - Communications Protocol/detailed_window_system_with_DAQ`.

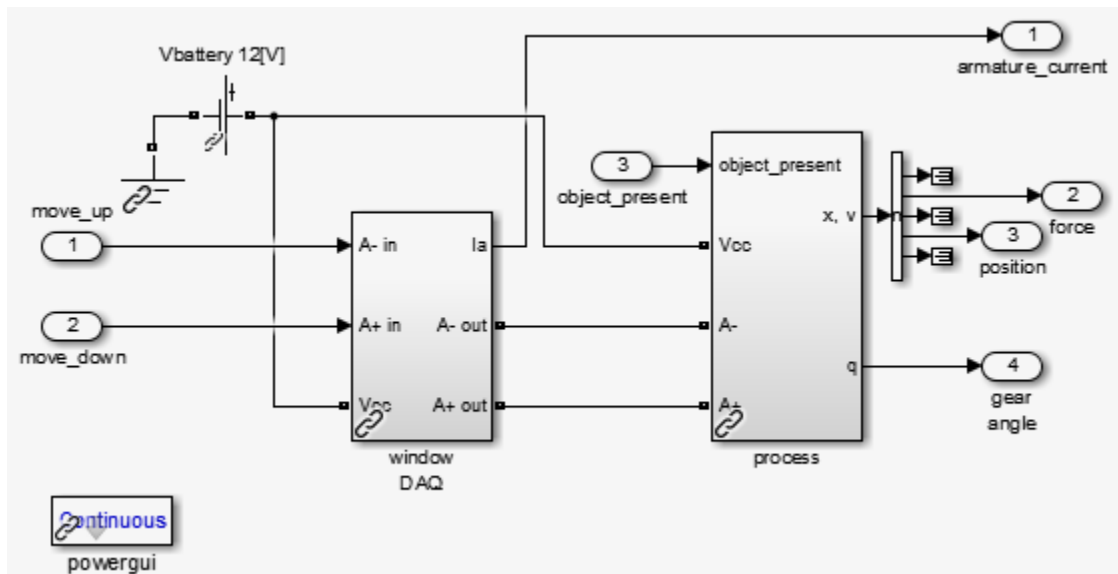

The measurement voltage is within the range of an analog-to-digital converter (ADC) that discretizes based on a given number of bits. You must scale the resulting value based on the value of the resistor and the range of the ADC.

Include these operations as fixed-point computations. To achieve the necessary resolution with the given range, 16 bits are required instead of 8.

Study the same scenario:

- 1 In the `slexPowerWindowExample/passenger_switch/Normal` block, set the passenger up switch.

- 2 Run the simulation.
- 3 After some time, in the `slexPowerWindowExample/passenger_switch/Normal` block, switch off the passenger up switch.
- 4 When the window has been rolled down, click the `slexPowerWindowExample/passenger_switch/Normal` block driver down switch.
- 5 After some time, switch off the `slexPowerWindowExample/passenger_switch/Normal` block driver down switch.
- 6 When the window reaches the bottom of the frame, stop the simulation.
- 7 Zoom into the `armature_current` scope window and notice the discretized appearance.

### Communication Protocols

Similar to the power window output control, hardware must generate the input events. In this case, the hardware is the window control switches in the door and center control panels. Local processors generate these events and then communicate them to the window controller via a CAN bus.

To include these events, add a variant containing input from a CAN bus and switch components that generate the events delivered on the CAN bus to the driver switch and passenger switch variant subsystems. To open the model and configure the CAN communication protocols, run the `configureModel` task, `slexPowerWindowCommunicationProtocolsSim`.

To see the implementation of the switch subsystem, double-click the `slexPowerWindowExample/driver_switch/Communication Protocol/driver window control switch` block.

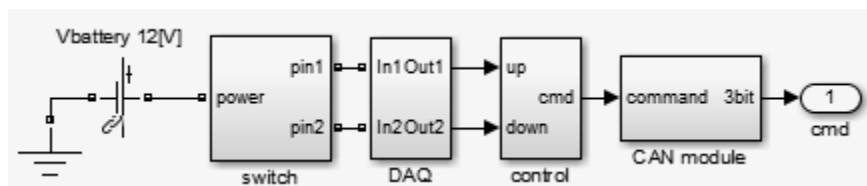

Observe a structure that is very similar to the window control system. This structure contains a:

- Plant model that represents the control switch

- Data acquisition subsystem that includes, among other things, signal conditioning components
- Control module to map the commands from the physical switch to logical commands
- CAN module to post the events to the vehicle data bus

You can add communication effects, such as other systems using the CAN bus, and more realism similar to the described phases. Each phase allows analysis of the discrete-event controller in an increasingly realistic situation. When you have enough detail, you can automatically generate controller code for any specific target platform.

## Automatic Code Generation for Control Subsystem

You can generate code for the designed control model, `slexPowerWindowExample`.

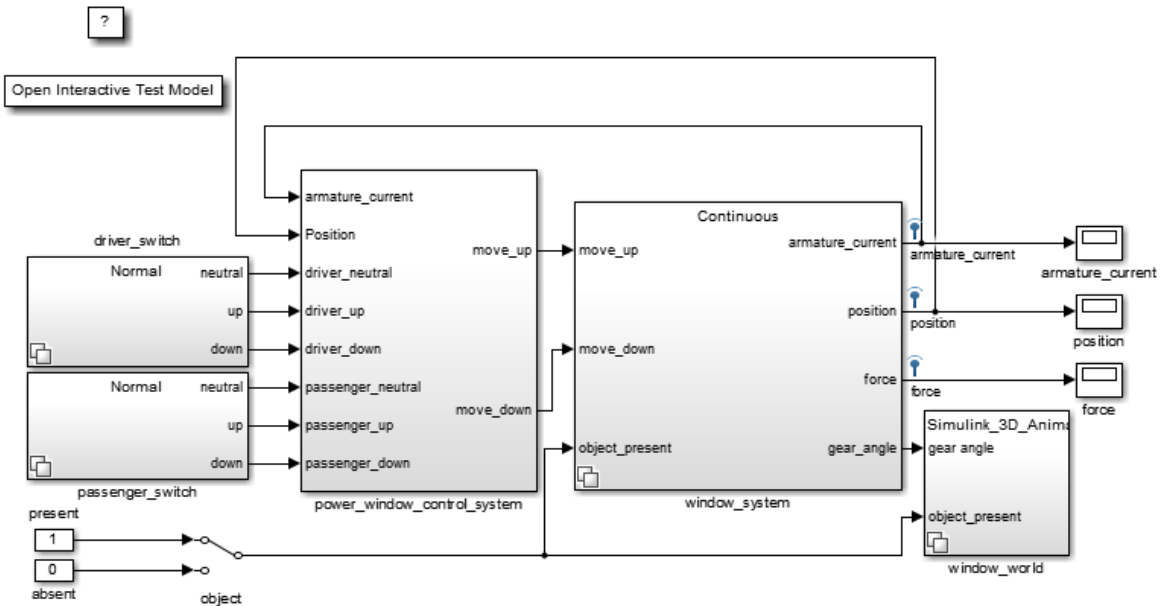

- 1 Display the sample rates of the controller. In the Simulink Editor, select **Display > Sample Time > Colors**. Observe that the controller runs at a uniform sample rate.

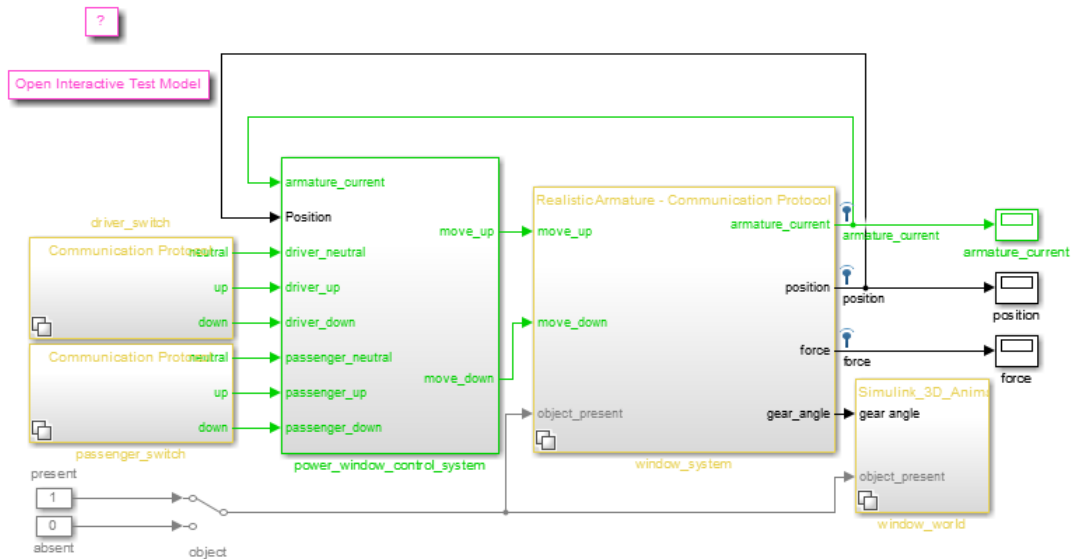

- 2 Right-click the `power_window_control_system` block and select **C/C++ Code > Build This Subsystem**.

## References

Mosterman, Pieter J., Janos Sztipanovits, and Sebastian Engell, “Computer-Automated Multiparadigm Modeling in Control Systems Technology,” *IEEE Transactions on Control Systems Technology*, Vol. 12, Number 2, 2004, pp. 223–234.

## Related Examples

- Power Window Control Project

## More About

- “Project Management”



# Simulating Dynamic Systems





# Running Simulations

---

- “Simulate a Model Interactively” on page 23-2
- “Specify Simulation Start and Stop Time” on page 23-6
- “About Solvers” on page 23-7
- “Choose a Solver” on page 23-9
- “Use Auto Solver to Select a Solver” on page 23-34
- “Save and Restore Simulation State as SimState” on page 23-37
- “View Diagnostics” on page 23-45
- “Systematic Diagnosis of Errors and Warnings” on page 23-51
- “Suppress Diagnostic Messages Programmatically” on page 23-56
- “Customize Diagnostic Messages” on page 23-65
- “Report Diagnostic Messages Programmatically” on page 23-68

## Simulate a Model Interactively

### Simulation Basics

You can simulate a model in the Simulink Editor using **Simulation > Run** or the **Run** button  on the toolbar. The **Run** button also appears in tools within the Simulink Editor. You can simulate from any tool that includes the button, such as the Scope viewer.

Before you start a simulation, you can specify options like simulation start time, stop time, and the solver for solving the model. (See “About Solvers” on page 23-7) You specify these options in the Configuration Parameters dialog box, which you can open from the **Simulation** menu or using the **Model Configuration Parameters** button  on the toolbar. These settings are saved with the model in a *configuration set*. You can create multiple configuration sets for each model and switch between them to see the effects of different settings. See “Configuration Reuse”.

After you set your model configuration parameters, you can start the simulation. You can pause, resume, and stop simulation using toolbar controls. You can also simulate more than one model at a time, so you can start another simulation while one is running.

During simulation, you cannot make changes to the structure of the model, such as adding or deleting lines or blocks. However, you can make these changes while a simulation is running:

- Modify some configuration parameters, including the stop time and the maximum step size.
- Modify the parameters of a block, as long as you do not cause a change in:
  - Number of states, inputs, or outputs
  - Sample time
  - Number of zero crossings
  - Vector length of any block parameters
  - Length of the internal block work vectors
  - Dimension of any signals

You can also examine the model visually as it simulates. For example, you can click a line to see the signal carried on that line on a Floating Scope or Display block. You can

also display port values as a model simulates. See “Display Port Values for Debugging” on page 34-16.

## Run, Pause, and Stop a Simulation

To start simulating your model, click the **Run** button . You can pause, resume, or stop a simulation using the corresponding controls on the toolbar.

The model starts simulating at the specified start time and runs until the specified end time. While the simulation is running, information at the bottom of the editor shows the percentage of simulation completed and the current simulation time.

- If an error occurs, simulation stops and a message appears. If a warning condition occurs, simulation completes. In both cases, click the diagnostics link at the bottom of the editor to see the message, which helps you to locate errors.
- Pausing takes effect after the current time step finishes executing. Resuming a paused simulation occurs at the next time step.
- If you stop a simulation, the current time step completes, and then simulation stops.
- If the model outputs to a file or to the workspace, stopping or pausing simulation writes the data.

## Use Blocks to Stop or Pause a Simulation

### Stop Simulation Using Stop Simulation Blocks

You can use the Stop Simulation block to stop a simulation when the input to the block is nonzero. If the block input is a vector, any nonzero element stops the simulation.

- 1 Add a Stop Simulation block to your model.
- 2 Connect the Stop Simulation block to a signal whose value becomes nonzero at the specified stop time.

For example, this model stops the simulation when the simulation time reaches 10.

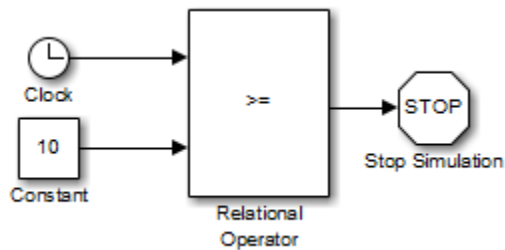

### Pause Simulation Using Assertion Blocks

You can use an Assertion block to pause the simulation when the input signal to the block is zero. The Assertion block uses the `set_param` command to pause the simulation. See “Control Simulations Programmatically” on page 24-8 for more information on using the `set_param` command to control the execution of a Simulink model.

- 1 Add an Assertion block to your model.
- 2 Connect the Assertion block to a signal whose value becomes zero at the desired pause time.
- 3 In the Assertion block dialog box, clear the **Stop simulation when assertion fails** check box. Enter this command as the value of **Simulation callback when assertion fails**:

```
set_param(bdroot,'SimulationCommand','pause'),
disp(sprintf('\nSimulation paused.'))
```

This model uses an Assertion block with these settings to pause the simulation when the simulation time reaches 5.

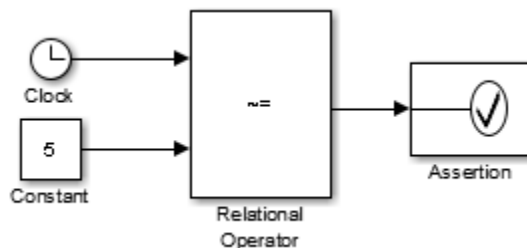

When the simulation pauses, a message appears that shows the time the block paused the simulation.

You can resume the simulation using **Continue** as you can for any paused simulation.

## See Also

Assertion | `sim` | Stop Simulation

## Related Examples

- “Systematic Diagnosis of Errors and Warnings” on page 23-51
- “Specify Simulation Start and Stop Time” on page 23-6

## More About

- “Run Individual Simulations Programmatically”
- “About Solvers” on page 23-7

## Specify Simulation Start and Stop Time

By default, simulations start at 0.0 s and end at 10.0 s.

---

**Note:** In the Simulink software, time and all related parameters (such as sample times) are implicitly in seconds. If you choose to use a different time unit, scale all parameters accordingly.

---

The **Solver** configuration pane allows you to specify other start and stop times for the currently selected simulation configuration. See “Solver Pane” for more information. On computers running the Microsoft Windows operating system, you can also specify the simulation stop time in the **Simulation** menu.

---

**Note** Simulation time and actual clock time are not the same. For example, if running a simulation for 10 s usually does not take 10 s as measured on a clock. The amount of time it actually takes to run a simulation depends on many factors including the complexity of the model, the step sizes, and the computer speed.

---

### More About

- “Run Individual Simulations Programmatically”
- “About Solvers” on page 23-7

## About Solvers

You simulate a dynamic system by computing its states at successive time steps over a specified time span. This computation uses information provided by a model of the system. The time steps are time intervals when the computation happens. The size of this time interval is called the *step size*. The process of computing the states of a model in this manner is known as solving the model. No single method of solving a model applies to all systems. Simulink provides a set of programs called *solvers*. Each solver embodies a particular approach to solving a model.

A solver applies a numerical method to solve the set of ordinary differential equations that represent the model. Through this computation, it determines the time of the next simulation step. In the process of solving this initial value problem, the solver also satisfies the accuracy requirements that you specify.

Solvers are broadly classified using these criteria:

- The type of step size used in the computation
  - Fixed-step solvers solve the model at step sizes from the beginning to the end of the simulation. You can specify the step size or let the solver choose the step size. Generally, decreasing the step size increases the accuracy of the results and increases the time required to simulate the system.
  - Variable-step solvers vary the step size during the simulation. They reduce the step size to increase accuracy when the states of a model change rapidly and during zero-crossing events. They increase the step size to avoid taking unnecessary steps when the states of a model change slowly. Computing the step size adds to the computational overhead at each step. However, it can reduce the total number of steps, and hence the simulation time required to maintain a specified level of accuracy for models with piecewise continuous or rapidly changing states.
- The nature of states in the model
  - Continuous solvers use numerical integration to compute continuous states of a model at the current time step based on the states at previous time steps and the state derivatives. Continuous solvers rely on individual blocks to compute the values of the discrete states of the model at each time step.
  - Discrete solvers are primarily for solving purely discrete models. They compute only the next simulation time step for a model. When they perform this

computation, they rely on each block in the model to update its individual discrete state. They do not compute continuous states.

When you choose a solver for simulating a model, consider:

- The dynamics of the system
- The stability of the solution
- The speed of computation
- The robustness of the solver

A solver might not completely satisfy all of your requirements, so use an iterative approach when choosing one. Compare simulation results from several solvers and select one that offers the best performance with minimal tradeoffs.

There are two ways to select a solver for your model:

- Use auto solver. New models have their solver selection set to auto solver by default. Auto solver recommends a fixed-step or variable-step solver for your model as well as maximum step size.
- If you are not satisfied with simulation results using auto solver, select a solver in the **Solver** pane in the model configuration parameters.

### Related Examples

- “Use Auto Solver to Select a Solver” on page 23-34

### More About

- “Choose a Solver” on page 23-9



## Choose a Solver

### In this section...

“Solver Classification Criteria” on page 23-11

“Choose a Fixed-Step Solver” on page 23-15

“Choose a Variable-Step Solver” on page 23-20

“Choose a Jacobian Method for an Implicit Solver” on page 23-27

The Simulink library of solvers has two main types—fixed-step and variable-step solvers. You can see the solvers under each type in the **Solver** pane of model configuration parameters.

When you build and simulate a model, you can choose either type of solver based on the dynamics of the model. A model that contains several switches, like an inverter power system, needs a fixed-step solver. A variable-step solver is better suited for purely continuous models, like the dynamics of a mass spring damper system.

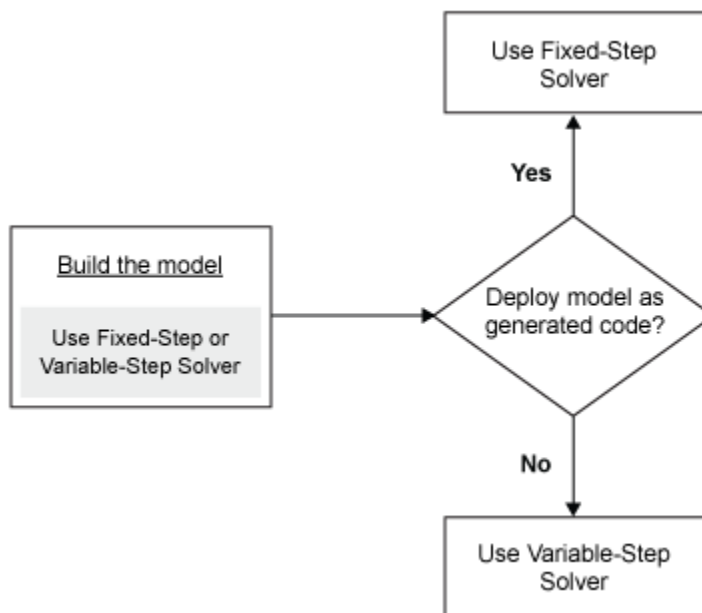

When you deploy a model as generated code, you can use only a fixed-step solver. If you selected a variable-step solver during simulation, use it to calculate the step size required for the fixed-step solver that you need at deployment.

This chart provides a broad classification of solvers in the Simulink library.

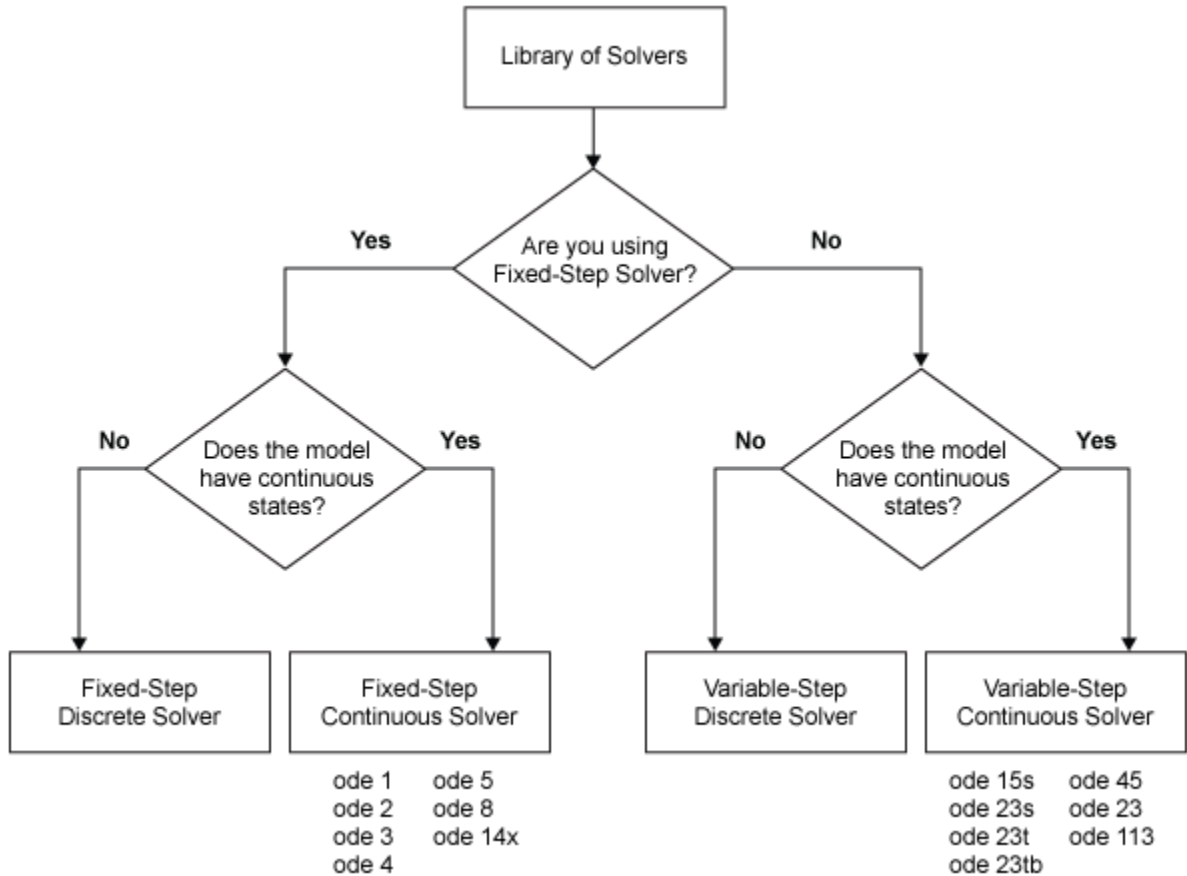

You can use auto solver to select a solver for a model. Auto solver can pick a fixed-step or variable-step solver for your model and also suggest the maximum step size to use. For more information, see “Use Auto Solver to Select a Solver” on page 23-34.

To tailor the selected solver to your model, see “Check and Improve Simulation Accuracy” on page 29-11.

Ideally, the solver you select should:

- Solve the model successfully.
- Provide a solution within the tolerance limits you specify.
- Solve the model in a reasonable duration.

A single solver might not meet all of these requirements. Try simulating with several solvers before making a selection.

## Solver Classification Criteria

The Simulink library provides several solvers, all of which can work with the algebraic loop solver.

		Discrete	Continuous	Variable-Order
Fixed-Step	Explicit	Not Applicable	“Fixed-Step Continuous Explicit Solvers” on page 23-17	Not Applicable
	Implicit	Not Applicable	“Fixed-Step Continuous Implicit Solvers” on page 23-19	Not Applicable
Variable-Step	Explicit	“Choose a Variable-Step Solver” on page 23-20	“Variable-Step Continuous Explicit Solvers” on page 23-21	“Single-Order Versus Variable-Order Continuous Solvers” on page 23-15
	Implicit		“Variable-Step Continuous Implicit Solvers” on page 23-22	“Single-Order Versus Variable-Order Continuous Solvers” on page 23-15

In the **Solver** pane of model configuration parameters, the Simulink library of solvers is divided into two major types. See “Fixed-Step Versus Variable-Step Solvers” on page 23-12.

You can further categorize the solvers of each type:

- “Discrete Versus Continuous Solvers” on page 23-13
- “Explicit Versus Implicit Continuous Solvers” on page 23-13
- “One-Step Versus Multistep Continuous Solvers” on page 23-14

- “Single-Order Versus Variable-Order Continuous Solvers” on page 23-15

### Fixed-Step Versus Variable-Step Solvers

Fixed-step and variable-step solvers compute the next simulation time as the sum of the current simulation time and a quantity known as the *step size*. The **Type** control on the **Solver** configuration pane allows you to select the type of solver. With a fixed-step solver, the step size remains constant throughout the simulation. With a variable-step solver, the step size can vary from step to step, depending on the model dynamics. In particular, a variable-step solver increases or reduces the step size to meet the error tolerances that you specify.

The choice between these types depends on how you plan to deploy your model and the model dynamics. If you plan to generate code from your model and run the code on a real-time computer system, choose a fixed-step solver to simulate the model. You cannot map the variable-step size to the real-time clock.

If you do not plan to deploy your model as generated code, the choice between a variable-step and a fixed-step solver depends on the dynamics of your model. A variable-step solver might shorten the simulation time of your model significantly. A variable-step solver allows this saving because, for a given level of accuracy, the solver can dynamically adjust the step size as necessary. This approach reduces the number of steps required. The fixed-step solver must use a single step size throughout the simulation, based on the accuracy requirements. To satisfy these requirements throughout the simulation, the fixed-step solver typically requires a small step.

This model shows how a variable-step solver can shorten simulation time for a multirate discrete model.

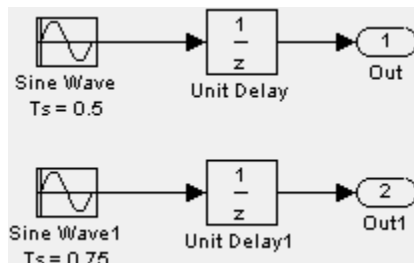

The model generates outputs at two different rates: every 0.5 s and every 0.75 s. To capture both outputs, the fixed-step solver must take a time step every 0.25 s (the *fundamental sample time* for the model).

[0.0 0.25 0.5 0.75 1.0 1.25 1.5 ...]

By contrast, the variable-step solver has to take a step only when the model generates an output.

[0.0 0.5 0.75 1.0 1.5 ...]

This scheme significantly reduces the number of time steps required to simulate the model.

### **Discrete Versus Continuous Solvers**

When you select a solver type, you can also select a specific solver. Both sets of solvers include two types: discrete and continuous. Discrete and continuous solvers rely on the model blocks to compute the values of any discrete states. Blocks that define discrete states are responsible for computing the values of those states at each time step. However, unlike discrete solvers, continuous solvers use numerical integration to compute the continuous states that the blocks define. When choosing a solver, determine first whether to use a discrete solver or a continuous solver.

If your model has no continuous states, then Simulink switches to either the fixed-step discrete solver or the variable-step discrete solver. If your model has only continuous states or a mix of continuous and discrete states, choose a continuous solver from the remaining solver choices based on the dynamics of your model. Otherwise, an error occurs.

The solver library contains two discrete solvers—a fixed-step discrete solver and a variable-step discrete solver. The fixed-step solver by default chooses a step size and simulation rate fast enough to track state changes in the fastest block in your model. The variable-step solver adjusts the simulation step size to keep pace with the actual rate of discrete state changes in your model. This adjustment can avoid unnecessary steps and shorten simulation time for multirate models (see “Sample Times in Systems” on page 7-28 for more information.)

---

**Note:** The fixed-step discrete solvers do not solve for discrete states. Each block calculates its discrete states independent of the solver.

---

### **Explicit Versus Implicit Continuous Solvers**

You represent an explicit system by the system of equation

$$\dot{x} = f(x)$$

. For any given value of  $x$ , you can compute  $\dot{x}$  by substituting  $x$  in  $f(x)$  and evaluating the equation.

Equations of the form

$$F(\dot{x}, x) = 0$$

are considered to be implicit. For any given value of  $x$ , you must solve this equation to calculate  $\dot{x}$ .

A linearly implicit system can be represented by the equation

$$M(x).\dot{x} = f(x)$$

.  $M(x)$  is called the mass matrix and  $f(x)$  is the forcing function. A system becomes linearly implicit when you use physical modeling blocks in the model.

While you can apply an implicit or explicit continuous solver to solve all these systems, implicit solvers are designed specifically for solving stiff problems. Explicit solvers solve nonstiff problems. An ordinary differential equation problem is said to be stiff if the desired solution varies slowly, but there are closer solutions that vary rapidly. The numerical method must then take small time steps to solve the system. Stiffness is an efficiency issue. The more stiff a system, the longer it takes for the explicit solver to perform a computation. A stiff system has both slowly and quickly varying continuous dynamics.

When compared to explicit solvers, implicit solvers provide greater stability for oscillatory behavior. However, implicit solvers are also computationally more expensive. They generate the Jacobian matrix and solve the set of algebraic equations at every time step using a Newton-like method. To reduce this extra cost, the implicit solvers offer a `Solver Jacobian method` parameter that allows you to improve the simulation performance of implicit solvers. See “Choose a Jacobian Method for an Implicit Solver” on page 23-27 for more information. Implicit solvers are more efficient than explicit solvers when you solve a linearly implicit system.

### **One-Step Versus Multistep Continuous Solvers**

The Simulink solver library provides both one-step and multistep solvers. The one-step solvers estimate  $y(t_n)$  using the solution at the immediately preceding time point,

$y(t_{n-1})$ , and the values of the derivative at multiple points between  $t_n$  and  $t_{n-1}$ . These points are minor steps.

The multistep solvers use the results at several preceding time steps to compute the current solution. Simulink provides one explicit multistep solver, `ode113`, and one implicit multistep solver, `ode15s`. Both are variable-step solvers.

### Single-Order Versus Variable-Order Continuous Solvers

This distinction is based on the number of orders that the solver uses to solve the system of equation. Two variable-order solvers, `ode15s` and `ode113`, are part of the solver library. They use multiple orders to solve the system of equations. Specifically, the implicit, variable-step `ode15s` solver uses first-order through fifth-order equations while the explicit, variable-step `ode113` solver uses first-order through thirteenth-order. For `ode15s`, you can limit the highest order applied via the `Maximum Order` parameter. For more information, see “Maximum Order” on page 23-23.

## Choose a Fixed-Step Solver

### The Fixed-Step Discrete Solver

The fixed-step discrete solver computes the time of the next simulation step by adding a fixed step size to the current time. The accuracy and the length of time of the resulting simulation depends on the size of the steps taken by the simulation: the smaller the step size, the more accurate the results are but the longer the simulation takes. By default, Simulink chooses the step size or you can choose the step size yourself. If you choose the default setting of `auto`, and if the model has discrete sample times, then Simulink sets the step size to the fundamental sample time of the model. Otherwise, if no discrete rates exist, Simulink sets the size to the result of dividing the difference between the simulation start and stop times by 50.

---

**Note** If you try to use the fixed-step discrete solver to update or simulate a model that has continuous states, an error message appears. Thus, selecting a fixed-step solver and then updating or simulating a model is a quick way to determine whether the model has continuous states.

---

### **Fixed-Step Continuous Solvers**

The fixed-step continuous solvers, like the fixed-step discrete solver, compute the next simulation time by adding a fixed-size time step to the current time. For each of these steps, the continuous solvers use numerical integration to compute the values of the continuous states for the model. These values are calculated using the continuous states at the previous time step and the state derivatives at intermediate points (minor steps) between the current and the previous time step. The fixed-step continuous solvers can, therefore, handle models that contain both continuous and discrete states.

---

**Note** In theory, a fixed-step continuous solver can handle models that contain no continuous states. However, that would impose an unnecessary computational burden on the simulation. Consequently, Simulink uses the fixed-step discrete solver for a model that contains no states or only discrete states, even if you specify a fixed-step continuous solver for the model.

---

Simulink provides two types of fixed-step continuous solvers — explicit and implicit.



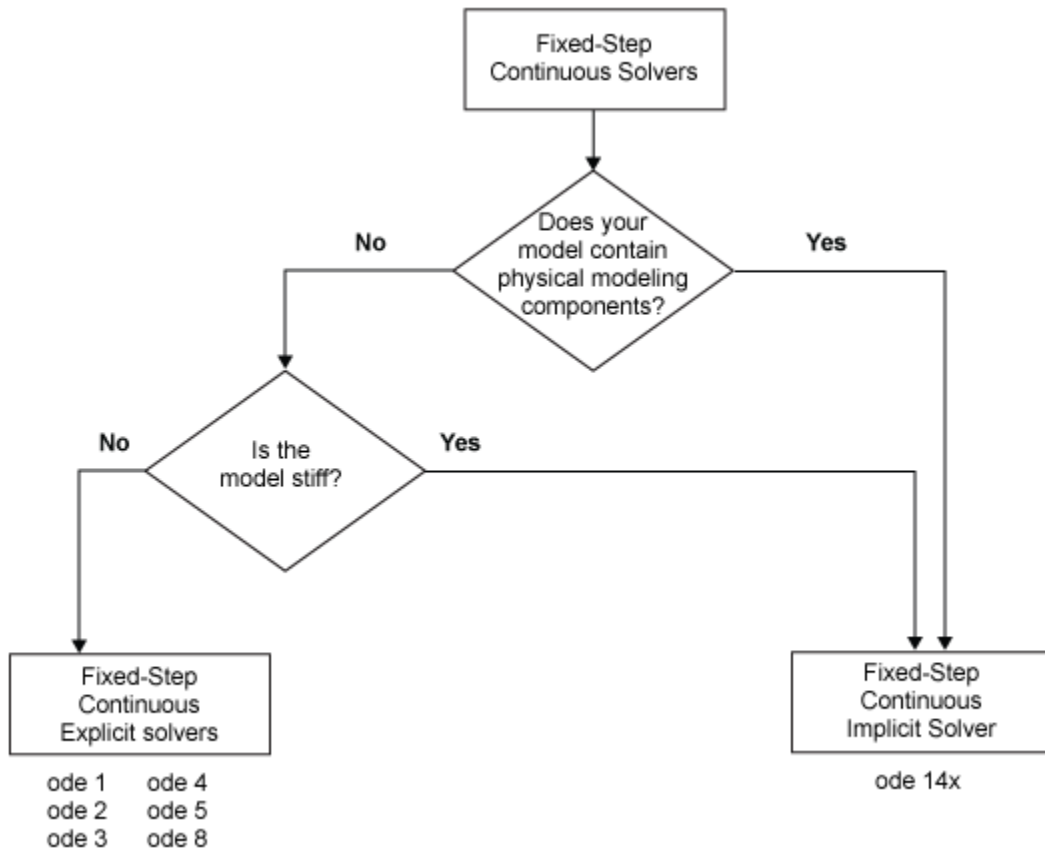

The difference between these two types lies in the speed and the stability. An implicit solver requires more computation per step than an explicit solver but is more stable. Therefore, the implicit fixed-step solver that Simulink provides is more adept at solving a stiff system than the fixed-step explicit solvers. For more information, see “Explicit Versus Implicit Continuous Solvers” on page 23-13.

### Fixed-Step Continuous Explicit Solvers

Explicit solvers compute the value of a state at the next time step as an explicit function of the current values of both the state and the state derivative. A fixed-step explicit solver is expressed mathematically as:

$$x(n+1) = x(n) + h * Dx(n)$$

where  $x$  is the state,  $Dx$  is a solver-dependent function that estimates the state derivative,  $h$  is the step size, and  $n$  indicates the current time step.

Simulink provides a set of fixed-step continuous explicit solvers. The solvers differ in the specific numerical integration technique that they use to compute the state derivatives of the model. This table lists each solver and the integration technique it uses. The table lists the solvers in order of the computational complexity of the integration methods they use, from the least complex (ode1) to the most complex (ode8).

Solver	Integration Technique	Order of Accuracy
ode1	Euler's Method	First
ode2	Heun's Method	Second
ode3	Bogacki-Shampine Formula	Third
ode4	Fourth-Order Runge-Kutta (RK4) Formula	Fourth
ode5	Dormand-Prince (RK5) Formula	Fifth
ode8	Dormand-Prince RK8(7) Formula	Eighth

None of these solvers has an error control mechanism. Therefore, the accuracy and the duration of a simulation depend directly on the size of the steps taken by the solver. As you decrease the step size, the results become more accurate, but the simulation takes longer. Also, for any given step size, the more computationally complex the solver is, the more accurate are the simulation results.

If you specify a fixed-step solver type for a model, then by default, Simulink selects the `FixedStepAuto` solver. Auto solver then selects an appropriate fixed-step solver that can handle both continuous and discrete states with moderate computational effort. As with the discrete solver, if the model has discrete rates (sample times), then Simulink sets the step size to the fundamental sample time of the model by default. If the model has no discrete rates, Simulink automatically uses the result of dividing the simulation total duration by 50. Consequently, the solver takes a step at each simulation time at which Simulink must update the discrete states of the model at its specified sample rates. However, it does not guarantee that the default solver accurately computes the continuous states of a model. Therefore, you may need to choose another solver, a different fixed step size, or both to achieve acceptable accuracy and an acceptable simulation time.

### Fixed-Step Continuous Implicit Solvers

An implicit solver computes the state at the next time step as an implicit function of the state at the current time step and the state derivative at the next time step. In other words:

$$x(n+1) - x(n) - h * Dx(n+1) = 0$$

Simulink provides one fixed-step implicit solver: `ode14x`. This solver uses a combination of Newton's method and extrapolation from the current value to compute the value of a state at the next time step. You can specify the number of Newton's method iterations and the extrapolation order that the solver uses to compute the next value of a model state (see “Fixed-step size (fundamental sample time)”). The more iterations and the higher the extrapolation order that you select, the greater the accuracy you obtain. However, you simultaneously create a greater computational burden per step size.

### How to Choose a Fixed-Step Continuous Solver

Any of the fixed-step continuous solvers in the Simulink product can simulate a model to any desired level of accuracy, given a small enough step size. Unfortunately, it is not possible or practical to decide without trial, the combination of solver and step size that will yield acceptable results for the continuous states in the shortest time. Determining the best solver for a particular model generally requires experimentation.

To select a fixed-step continuous solver,

- 1 Choose error tolerances. For more information, see “Error Tolerances for Variable-Step Solvers” on page 23-24.
- 2 Use one of the variable-step solvers to simulate your model to the level of accuracy that you want. Start with `ode45`. If your model runs slowly, your problem may be stiff and need an implicit solver. The results of this step give a good approximation of the correct simulation results and the appropriate fixed step size.
- 3 Use `ode1` to simulate your model at the default step size for your model. Compare the simulation results for `ode1` with the simulation for the variable-step solver. If the results are the same for the specified level of accuracy, you have found the best fixed-step solver for your model, namely `ode1`. You arrive at this conclusion because `ode1` is the simplest of the fixed-step solvers and hence yields the shortest simulation time for the current step size.
- 4 If `ode1` does not give satisfactory results, repeat the preceding steps with the other fixed-step solvers until you find one that gives accurate results with the least

computational effort. The most efficient way to perform this task is to use a binary search technique:

- a** Try `ode3`.
- b** If `ode3` gives accurate results, try `ode2`. If `ode2` gives accurate results, it is the best solver for your model; otherwise, `ode3` is the best.
- c** If `ode3` does not give accurate results, try `ode5`. If `ode5` gives accurate results, try `ode4`. If `ode4` gives accurate results, select it as the solver for your model; otherwise, select `ode5`.
- d** If `ode5` does not give accurate results, reduce the simulation step size and repeat the preceding process. Continue in this way until you find a solver that solves your model accurately with the least computational effort.

## Choose a Variable-Step Solver

When you set the **Type** control of the **Solver** configuration pane to **Variable-step**, the **Solver** control allows you to choose one of the variable-step solvers. As with fixed-step solvers, the set of variable-step solvers comprises a discrete solver and a subset of continuous solvers. However, unlike the fixed-step solvers, the step size varies dynamically based on the local error.

The choice between the two types of variable-step solvers depends on whether the blocks in your model define states and, if so, the type of states that they define. If your model defines no states or defines only discrete states, select the discrete solver. If a model has no states or only discrete states, Simulink uses the discrete solver to simulate the model even if you specify a continuous solver. If the model has continuous states, the continuous solvers use numerical integration to compute the values of the continuous states at the next time step.

### Variable-Step Continuous Solvers

Variable-step solvers dynamically vary the step size during the simulation. Each of these solvers increases or reduces the step size using its local error control to achieve the tolerances that you specify. Computing the step size at each time step adds to the computational overhead. However, it can reduce the total number of steps, and the simulation time required to maintain a specified level of accuracy.

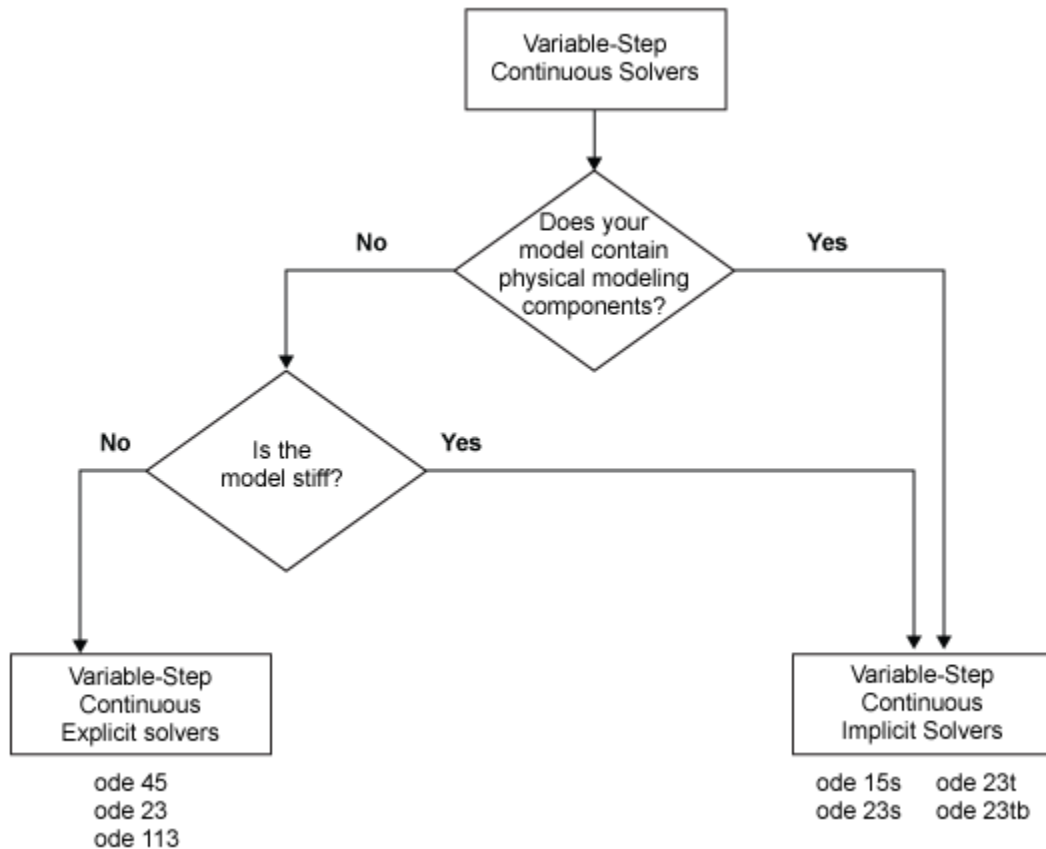

You can further categorize the variable-step continuous solvers as: one-step or multistep, single-order or variable-order, and explicit or implicit. (See “Solver Classification Criteria” on page 23-11 for more information.)

### Variable-Step Continuous Explicit Solvers

The variable-step explicit solvers are designed for nonstiff problems. Simulink provides three such solvers:

- ode45
- ode23
- ode113

ODE Solver	One-Step Method	Multistep Method	Order of Accuracy	Method
ode45	X		Medium	Runge-Kutta, Dormand-Prince (4,5) pair
ode23	X		Low	Runge-Kutta (2,3) pair of Bogacki & Shampine
ode113		X	Variable, Low to High	PECE Implementation of Adams-Bashforth-Moulton

ODE Solver	Tips on When to Use
ode45	<p>In general, the <code>ode45</code> solver is the best to apply as a first try for most problems. For this reason, <code>ode45</code> is the default solver for models with continuous states. This Runge-Kutta (4,5) solver is a fifth-order method that performs a fourth-order estimate of the error. This solver also uses a fourth-order “free” interpolant, which allows for event location and smoother plots.</p> <p>The <code>ode45</code> is more accurate and faster than <code>ode23</code>. If the <code>ode45</code> is computationally slow, your problem may be stiff and thus in need of an implicit solver.</p>
ode23	<p>The <code>ode23</code> can be more efficient than the <code>ode45</code> solver at crude error tolerances and in the presence of mild stiffness. This solver provides accurate solutions for “free” by applying a cubic Hermite interpolation to the values and slopes computed at the ends of a step.</p>
ode113	<p>For problems with stringent error tolerances or for computationally intensive problems, the Adams-Bashforth-Moulton PECE solver can be more efficient than <code>ode45</code>.</p>

### Variable-Step Continuous Implicit Solvers

If your problem is stiff, try using one of the variable-step implicit solvers:

- `ode15s`
- `ode23s`
- `ode23t`
- `ode23tb`

ODE Solver	One-Step Method	Multistep Method	Order of Accuracy	Solver Reset Method	Max. Order	Method
ode15s		X	Variable, Low to Medium	X	X	Numerical Differentiation Formulas (NDFs)
ode23s	X		Low			Second-order, modified Rosenbrock formula
ode23t	X		Low	X		Trapezoidal rule using a “free” interpolant
ode23tb	X		Low	X		TR-BDF2

### Solver Reset Method

For three of the stiff solvers — `ode15s`, `ode23t`, and `ode23tb`— a drop-down menu for the **Solver reset method** appears on the **Solver Configuration** pane. This parameter controls how the solver treats a reset caused, for example, by a zero-crossing detection. The options allowed are **Fast** and **Robust**. **Fast** specifies that the solver does not recompute the Jacobian for a solver reset, whereas **Robust** specifies that the solver does. Consequently, the **Fast** setting is computationally faster but it may use a small step size in certain cases. To test for such cases, run the simulation with each setting and compare the results. If there is no difference, you can safely use the **Fast** setting and save time. If the results differ significantly, try reducing the step size for the fast simulation.

### Maximum Order

For the `ode15s` solver, you can choose the maximum order of the numerical differentiation formulas (NDFs) that the solver applies. Since the `ode15s` uses first-through fifth-order formulas, the **Maximum order** parameter allows you to choose 1 through 5. For a stiff problem, you may want to start with order 2.

### Tips for Choosing a Variable-Step Implicit Solver

The following table provides tips relating to the application of variable-step implicit solvers. For an example comparing the behavior of these solvers, see `sldemo_solvers`.

ODE Solver	Tips on When to Use
ode15s	<code>ode15s</code> is a variable-order solver based on the numerical differentiation formulas (NDFs). NDFs are related to, but are more efficient than the backward differentiation formulas (BDFs), which are also known as Gear's method. The <code>ode15s</code> solver numerically generates the Jacobian matrices.

ODE Solver	Tips on When to Use
	If you suspect that a problem is stiff, or if <code>ode45</code> failed or was highly inefficient, try <code>ode15s</code> . As a rule, start by limiting the maximum order of the NDFs to 2.
<code>ode23s</code>	<code>ode23s</code> is based on a modified Rosenbrock formula of order 2. Because it is a one-step solver, it can be more efficient than <code>ode15s</code> at crude tolerances. Like <code>ode15s</code> , <code>ode23s</code> numerically generates the Jacobian matrix for you. However, it can solve certain kinds of stiff problems for which <code>ode15s</code> is not effective.
<code>ode23t</code>	The <code>ode23t</code> solver is an implementation of the trapezoidal rule using a “free” interpolant. Use this solver if your model is only moderately stiff and you need a solution without numerical damping. (Energy is not dissipated when you model oscillatory motion.)
<code>ode23tb</code>	<code>ode23tb</code> is an implementation of TR-BDF2, an implicit Runge-Kutta formula with two stages. The first stage is a trapezoidal rule step while the second stage uses a backward differentiation formula of order 2. By construction, the method uses the same iteration matrix in evaluating both stages. Like <code>ode23s</code> , this solver can be more efficient than <code>ode15s</code> at crude tolerances.

---

**Note** For a *stiff* problem, solutions can change on a time scale that is very small as compared to the interval of integration, while the solution of interest changes on a much longer time scale. Methods that are not designed for stiff problems are ineffective on intervals where the solution changes slowly because these methods use time steps small enough to resolve the fastest possible change. For more information, see Shampine, L. F., *Numerical Solution of Ordinary Differential Equations*, Chapman & Hall, 1994.

---

### Support for Zero-Crossing Detection

The variable-step discrete and continuous solvers use zero-crossing detection (see “Zero-Crossing Detection” on page 3-24) to handle continuous signals.

### Error Tolerances for Variable-Step Solvers

#### Local Error

The variable-step solvers use standard control techniques to monitor the local error at each time step. During each time step, the solvers compute the state values at the end



of the step and determine the *local error*—the estimated error of these state values. They then compare the local error to the *acceptable error*, which is a function of both the relative tolerance (*rtol*) and the absolute tolerance (*atol*). If the local error is greater than the acceptable error for *any one* state, the solver reduces the step size and tries again.

- The *Relative tolerance* measures the error relative to the size of each state. The relative tolerance represents a percentage of the state value. The default, 1e-3, means that the computed state is accurate to within 0.1%.
- *Absolute tolerance* is a threshold error value. This tolerance represents the acceptable error as the value of the measured state approaches zero.

The solvers require the error for the *i*th state,  $e_i$ , to satisfy:

$$e_i \leq \max(\text{rtol} \times |x_i|, \text{atol}_i).$$

The following figure shows a plot of a state and the regions in which the relative tolerance and the absolute tolerance determine the acceptable error.

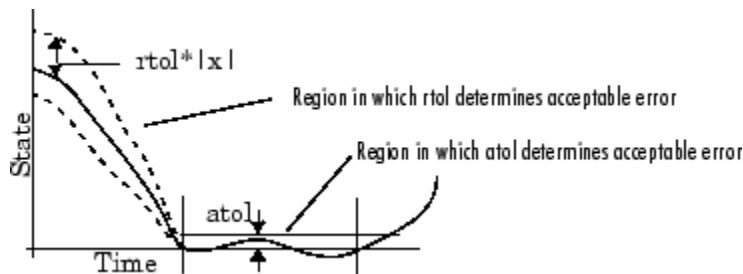

### Absolute Tolerances

Your model has a global absolute tolerance that you can set on the Solver pane of the Configuration Parameters dialog box. This tolerance applies to all states in the model. You can specify `auto` or a real scalar. If you specify `auto` (the default), Simulink initially sets the absolute tolerance for each state to 1e-6. As the simulation progresses, the absolute tolerance for each state resets to the maximum value that the state has assumed so far, times the relative tolerance for that state. Thus, if a state changes from 0 to 1 and `reltol` is 1e-3, then by the end of the simulation, `abstol` becomes 1e-3 also. If a state goes from 0 to 1000, then `abstol` changes to 1.

If the computed setting is not suitable, you can determine an appropriate setting yourself. You might have to run a simulation more than once to determine an appropriate value for the absolute tolerance.

Several blocks allow you to specify absolute tolerance values for solving the model states that they compute or that determine their output:

- Integrator
- Second-Order Integrator, Second-Order Integrator Limited
- Variable Transport Delay
- Transfer Fcn
- State-Space
- Zero-Pole

The absolute tolerance values that you specify for these blocks override the global settings in the Configuration Parameters dialog box. You might want to override the global setting if, for example, the global setting does not provide sufficient error control for all of your model states because they vary widely in magnitude. You can set the block absolute tolerance to:

- `auto`
- `-1` (same as `auto`)
- `positive scalar`
- `real vector` (having a dimension equal to the number of corresponding continuous states in the block)

### **Tips**

If you do choose to set the absolute tolerance, keep in mind that too low of a value causes the solver to take too many steps in the vicinity of near-zero state values. As a result, the simulation is slower.

On the other hand, if you set the absolute tolerance too high, your results can be inaccurate as one or more continuous states in your model approach zero.

Once the simulation is complete, you can verify the accuracy of your results by reducing the absolute tolerance and running the simulation again. If the results of these two simulations are satisfactorily close, then you can feel confident about their accuracy.

## Choose a Jacobian Method for an Implicit Solver

### The Solver Jacobian

For implicit solvers, Simulink must compute the *solver Jacobian*, which is a submatrix of the Jacobian matrix associated with the continuous representation of a Simulink model. In general, this continuous representation is of the form:

$$\begin{aligned}\dot{x} &= f(x, t, u) \\ y &= g(x, t, u).\end{aligned}$$

The Jacobian,  $J$ , formed from this system of equations is:

$$J = \begin{pmatrix} \frac{\partial f}{\partial x} & \frac{\partial f}{\partial u} \\ \frac{\partial g}{\partial x} & \frac{\partial g}{\partial u} \end{pmatrix} = \begin{pmatrix} A & B \\ C & D \end{pmatrix}.$$

In turn, the solver Jacobian is the submatrix,  $J_x$ .

$$J_x = A = \frac{\partial f}{\partial x}.$$

### Sparsity of Jacobian

For many physical systems, the solver Jacobian  $J_x$  is *sparse*, meaning that many of the elements of  $J_x$  are zero.

Consider the following system of equations:

$$\begin{aligned}\dot{x}_1 &= f_1(x_1, x_3) \\ \dot{x}_2 &= f_2(x_2) \\ \dot{x}_3 &= f_3(x_2).\end{aligned}$$

From this system, you can derive a sparsity pattern that reflects the structure of the equations. The pattern, a Boolean matrix, has a 1 for each  $x_i$  that appears explicitly on the right-hand side of an equation. Therefore, you attain:

$$J_{x,pattern} = \begin{pmatrix} 1 & 0 & 1 \\ 0 & 1 & 0 \\ 0 & 1 & 0 \end{pmatrix}$$

As discussed in “Full and Sparse Perturbation Methods” on page 23-31 and “Full and Sparse Analytical Methods” on page 23-32 respectively, the Sparse Perturbation Method and the Sparse Analytical Method may be able to take advantage of this sparsity pattern to reduce the number of computations necessary and improve performance.

### **Solver Jacobian Methods**

When you choose an implicit solver from the **Solver** pane of the configuration parameters dialog box, a parameter called **Solver Jacobian method** and a drop-down menu appear. This menu has five options for computing the solver Jacobian:

- **auto**
- **Sparse perturbation**
- **Full perturbation**
- **Sparse analytical**
- **Full analytical**

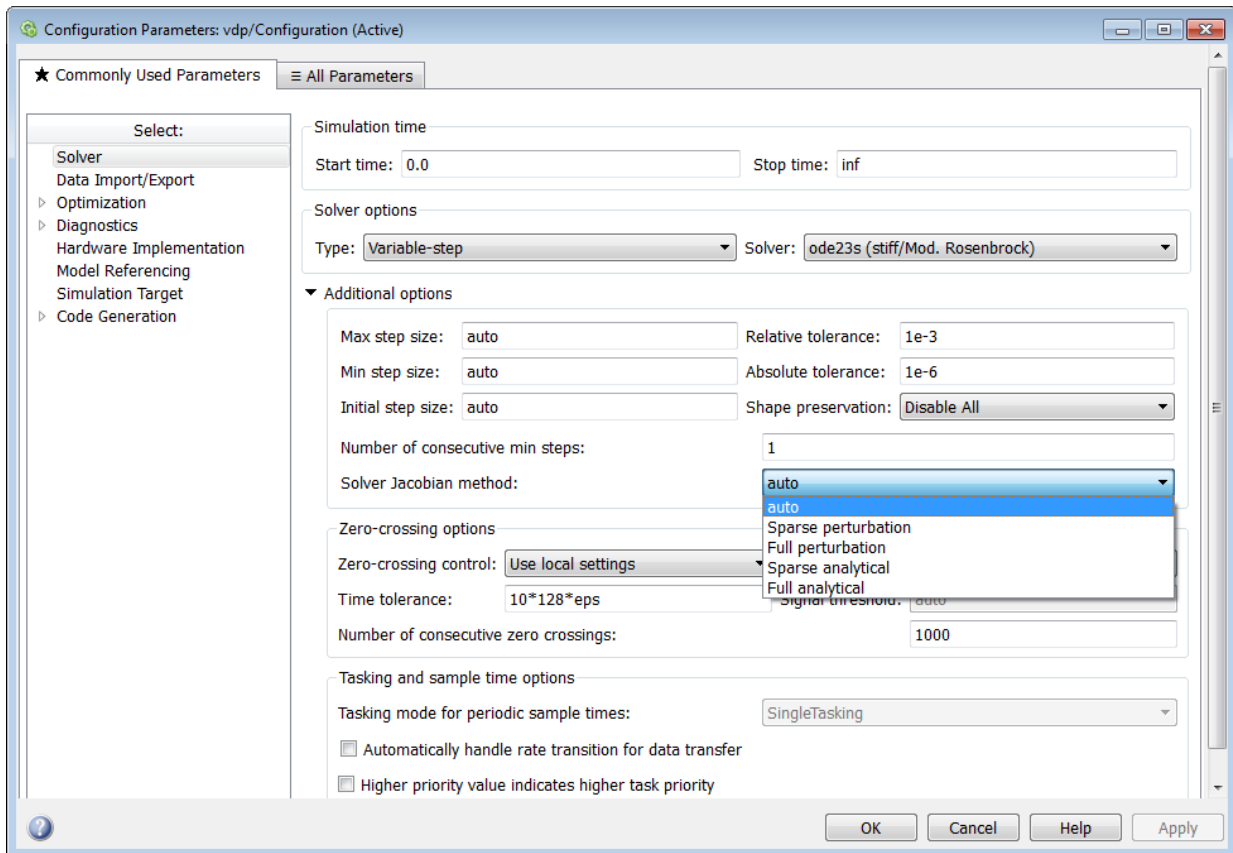

---

**Note:** If you set **Automatic solver parameter selection** to **warning** or **error** in the Solver Diagnostics pane, and you choose a different solver method than Simulink, you may receive a warning or an error.

---

### Limitations

The solver Jacobian methods have the following limitations associated with them.

- If you select an analytical Jacobian method, but one or more blocks in the model do not have an analytical Jacobian, then Simulink applies a perturbation method.

- If you select sparse perturbation and your model contains data store blocks, Simulink applies the full perturbation method.

### Heuristic 'auto' Method

The default setting for the Solver Jacobian method is auto. Selecting this choice causes Simulink to perform a heuristic to determine which of the remaining four methods best suits your model. This algorithm is depicted in the following flow chart.

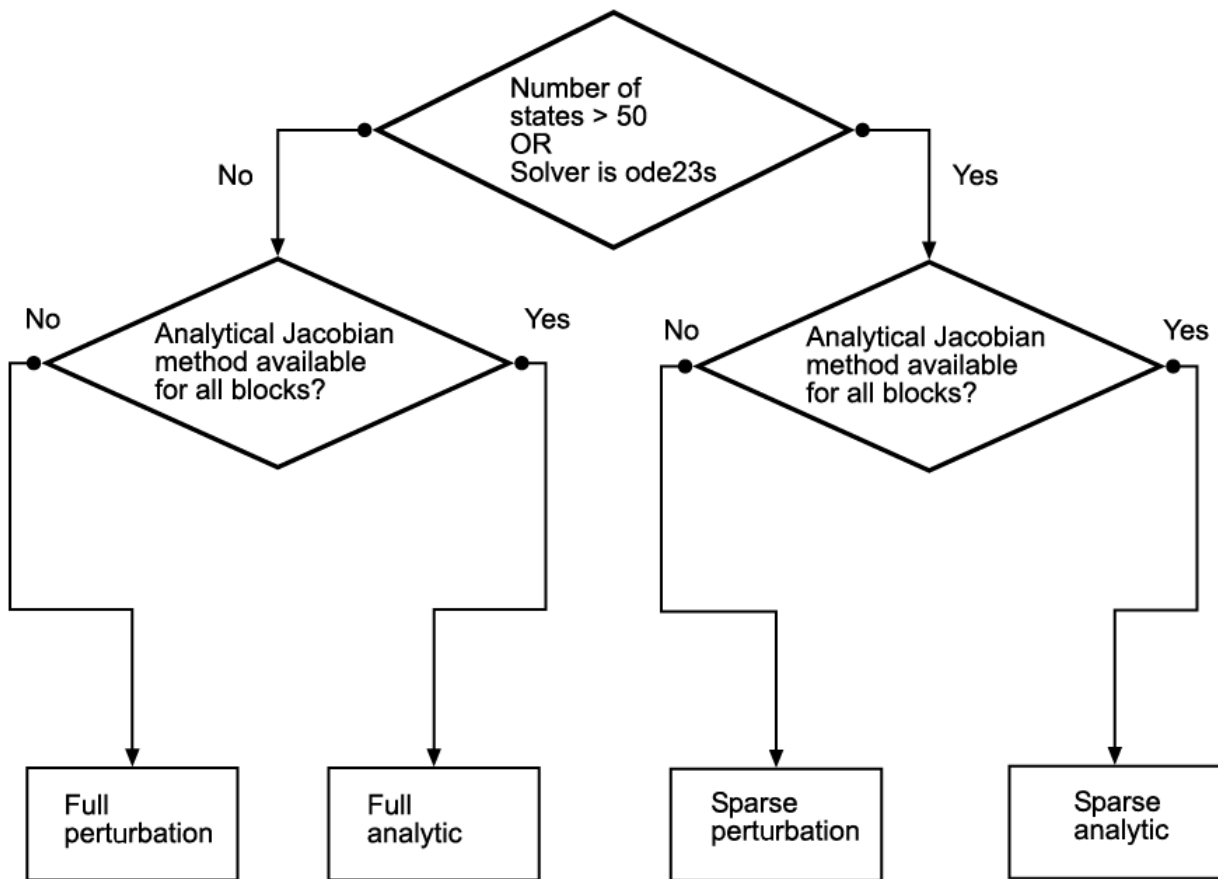

Because sparse methods are beneficial for models having a large number of states, if 50 or more states exist in your model, the heuristic chooses a sparse method. The logic also

leads to a sparse method if you specify `ode23s` because, unlike other implicit solvers, `ode23s` generates a new Jacobian at every time step. A sparse analytical or a sparse perturbation method is, therefore, highly advantageous. The heuristic also ensures that the analytical methods are used only if every block in your model can generate an analytical Jacobian.

### Full and Sparse Perturbation Methods

The full perturbation method was the standard numerical method that Simulink used to solve a system. For this method, Simulink solves the full set of perturbation equations and uses LAPACK for linear algebraic operations. This method is costly from a computational standpoint, but it remains the recommended method for establishing baseline results.

The sparse perturbation method attempts to improve the run-time performance by taking mathematical advantage of the sparse Jacobian pattern. Returning to the sample system of three equations and three states,

$$\begin{aligned}\dot{x}_1 &= f_1(x_1, x_3) \\ \dot{x}_2 &= f_2(x_2) \\ \dot{x}_3 &= f_3(x_2).\end{aligned}$$

The solver Jacobian is:

$$J_x = \begin{pmatrix} \frac{\partial f_1}{\partial x_1} & \frac{\partial f_1}{\partial x_2} & \frac{\partial f_1}{\partial x_3} \\ \frac{\partial f_2}{\partial x_1} & \frac{\partial f_2}{\partial x_2} & \frac{\partial f_2}{\partial x_3} \\ \frac{\partial f_3}{\partial x_1} & \frac{\partial f_3}{\partial x_2} & \frac{\partial f_3}{\partial x_3} \end{pmatrix} = \begin{pmatrix} \frac{f_1(x_1 + \Delta x_1, x_2, x_3) - f_1}{\Delta x_1} & \frac{f_1(x_1, x_2 + \Delta x_2, x_3) - f_1}{\Delta x_2} & \frac{f_1(x_1, x_2, x_3 + \Delta x_3) - f_1}{\Delta x_3} \\ \frac{f_2(x_1 + \Delta x_1, x_2, x_3) - f_2}{\Delta x_1} & \frac{f_2(x_1, x_2 + \Delta x_2, x_3) - f_2}{\Delta x_2} & \frac{f_2(x_1, x_2, x_3 + \Delta x_3) - f_2}{\Delta x_3} \\ \frac{f_3(x_1 + \Delta x_1, x_2, x_3) - f_3}{\Delta x_1} & \frac{f_3(x_1, x_2 + \Delta x_2, x_3) - f_3}{\Delta x_2} & \frac{f_3(x_1, x_2, x_3 + \Delta x_3) - f_3}{\Delta x_3} \end{pmatrix}$$

It is, therefore, necessary to perturb each of the three states three times and to evaluate the derivative function three times. For a system with  $n$  states, this method perturbs the states  $n$  times.

By applying the sparsity pattern and perturbing states  $x_1$  and  $x_2$  together, this matrix reduces to:

$$J_x = \begin{pmatrix} \frac{f_1(x_1 + \Delta x_1, x_2 + \Delta x_2, x_3) - f_1}{\Delta x_1} & 0 & \frac{f_1(x_1, x_2, x_3 + \Delta x_3) - f_1}{\Delta x_3} \\ 0 & \frac{f_2(x_1 + \Delta x_1, x_2 + \Delta x_2, x_3) - f_2}{\Delta x_2} & 0 \\ 0 & \frac{f_3(x_1 + \Delta x_1, x_2 + \Delta x_2, x_3) - f_3}{\Delta x_2} & 0 \end{pmatrix}$$

The solver can now solve columns 1 and 2 in one sweep. While the sparse perturbation method saves significant computation, it also adds overhead to compilation. It might even slow down the simulation if the system does not have a large number of continuous states. A tipping point exists for which you obtain increased performance by applying this method. In general, systems having a large number of continuous states are usually sparse and benefit from the sparse method.

The sparse perturbation method, like the sparse analytical method, uses UMFPACK to perform linear algebraic operations. Also, the sparse perturbation method supports both RSim and Rapid Accelerator mode.

### Full and Sparse Analytical Methods

The full and sparse analytical methods attempt to improve performance by calculating the Jacobian using analytical equations rather than the perturbation equations. The sparse analytical method, also uses the sparsity information to accelerate the linear algebraic operations required to solve the ordinary differential equations.

### Sparsity Pattern

For details on how to access and interpret the sparsity pattern in MATLAB, see `sldemo_metro`.



### **Support for Code Generation**

While the sparse perturbation method supports RSim, the sparse analytical method does not. Consequently, regardless of which sparse method you select, any generated code uses the sparse perturbation method. This limitation applies to Rapid Accelerator mode as well.

### **Related Examples**

- “Use Auto Solver to Select a Solver” on page 23-34

### **More About**

- “About Solvers” on page 23-7

## Use Auto Solver to Select a Solver

### In this section...

“Use Auto Solver with vdp Model” on page 23-34

“Auto Solver Heuristics” on page 23-35

When you want Simulink to select a solver for simulating the model, use auto solver. Auto solver chooses a suitable solver and sets the maximum step size of the simulation.

For new models, Simulink selects auto solver and sets the type to variable-step by default. For an existing model, you can use auto solver to select a solver.

### Use Auto Solver with vdp Model

- 1 Open vdp and click the solver link in the lower-right corner. The **Solver information** pane opens.

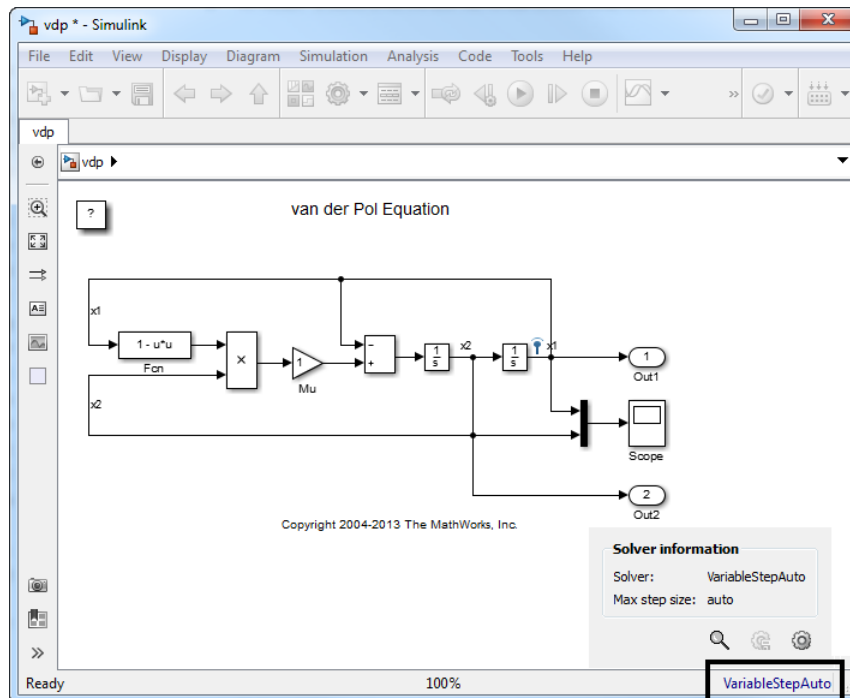

- 2 In the pane, click the **View solver settings** button  to open the **Solver** pane of the model configuration parameters.
- 3 Under **Solver options**, set **Type** to fixed or variable-step according to your preference and set **Solver** to auto.
- 4 When you simulate the model, auto solver selects a fixed-step or variable-step solver according to your preference and calculates the maximum step size it recommends. To see the results, open the **Solver information** pane.

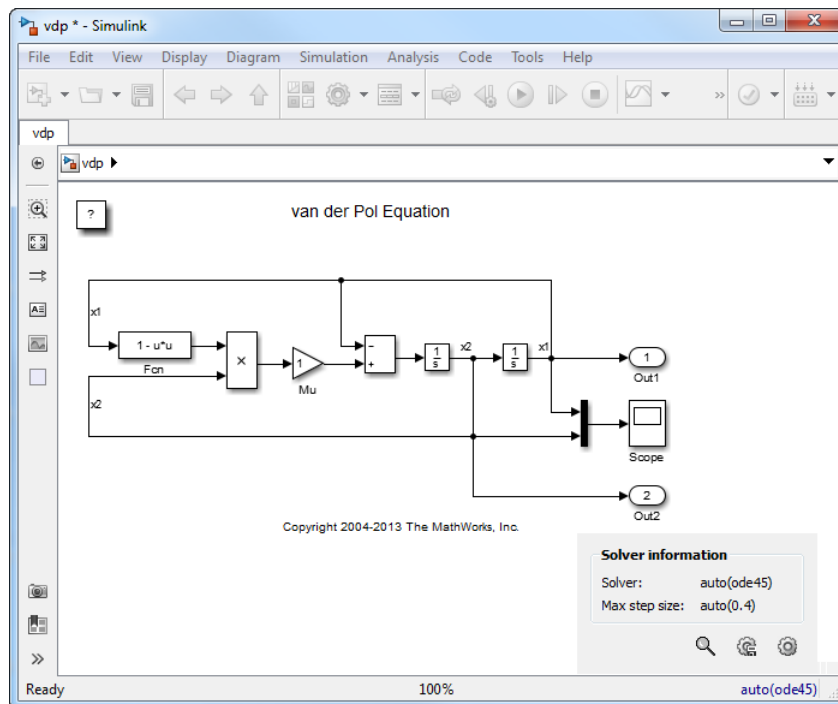

- 5 Click the **Accept suggested settings** button  to apply the recommendations of auto solver. To select different settings, click the **View solver settings** button and make changes in the configuration parameters **Solver** pane.

## Auto Solver Heuristics

This chart describes the heuristics of auto solver.

Auto Solver Heuristics

The system has The solver type is		Only discrete states	Continuous states		
			The system is an ordinary differential equation (ODE)	The system has differential algebraic equations (DAE)	
Fixed-Step	FixedStepDiscrete		ode3	ode14x	
			<table border="1"> <tr> <th>The model is stiff</th> <th>The model is non-stiff</th> </tr> <tr> <td>ode15s</td> <td>ode45</td> </tr> </table>	The model is stiff	The model is non-stiff
The model is stiff	The model is non-stiff				
ode15s	ode45				

- For Simscape Power Systems models, auto solver selects `ode23tb`. These systems can have circuits with nonlinear models, especially circuit breakers and power electronics. Such nonlinear models require a stiff solver.
- If the number of continuous states in the model exceeds the `NumStatesForStiffnessChecking` value, auto solver uses `ode15s`. It does not calculate the stiffness of the model. The default value for this parameter is 1000. You can change this value using `set_param`.
- If the number of continuous states in the model is less than the `NumStatesForStiffnessChecking` value, auto solver calculates the stiffness of the model. A model is stiff if the stiffness exceeds the `StiffnessThreshold` value. The default value for this parameter is 1000. You can change this value using `set_param`.

More About

- “Choose a Solver” on page 23-9

## Save and Restore Simulation State as SimState

### In this section...

- “SimState and Repetitive Simulations” on page 23-37
- “Information Saved in a SimState” on page 23-38
- “Benefits of Using SimState” on page 23-38
- “When You Can Save a SimState” on page 23-39
- “Save SimState” on page 23-39
- “Restore SimState” on page 23-40
- “Change the States of a Block Within SimState” on page 23-41
- “S-Functions” on page 23-41
- “Model Changes and SimState” on page 23-41
- “Limitations of SimState” on page 23-42

### SimState and Repetitive Simulations

When designing a system, you simulate a model repeatedly to analyze the behavior of a system for different inputs, boundary conditions, or operating conditions. In many applications, a startup phase with significant dynamic behavior is common to multiple simulations. For example, the cold start takeoff of a gas turbine engine occurs before each set of aircraft maneuvers. Ideally, you:

- 1 Simulate the startup phase once.
- 2 Save the simulation state at the end of the start-up phase.
- 3 Use this state as the initial state for each set of conditions or maneuvers.

In this type of situation, use SimState to save the state of a simulation. For future simulations, you can restore the SimState and use it to set initial conditions for simulations going forward.

A SimState includes both the logged and internal states of every block (e.g., continuous states, discrete states, work vectors, zero-crossing states) and the internal state of the Simulink engine (e.g., the data of the ODE solver).

---

**Note:** You can also use the **Final states** option in the Configuration Parameters **Data Import/Export** pane to save a simulation state. However, this option saves only *logged*

states—the continuous and discrete states of blocks. These states are only subsets of the complete simulation state of the model. They do not include information about hidden states of certain blocks — information that is not included in logged states but is still required for the proper execution of the block. Hence you cannot use **Final states** to save and restore the complete simulation state as the initial state of a new simulation.

---

## Information Saved in a SimState

A `SimState` contains information about:

- Logged states
- State of the solver and execution engine
- Zero-crossing signals for blocks that register zero crossings
- Output values of certain blocks in the model

Simulink analyzes block connections and other information to determine whether it is using the output values effectively as state information.

`SimState` also stores the hidden states of these blocks:

- Transport Delay
- Variable Transport Delay
- From Workspace
- For Each subsystem
- Conditionally executed subsystems
- Stateflow
- MATLAB System
- Simscape Multibody Second Generation

By storing this information, `SimState` ensures that the result of a simulation that starts from `SimState` is the same as a simulation that runs from the beginning.

## Benefits of Using SimState

- When `SimState` saves the state of a simulation, it saves information in addition to the logged states in the model. You need to restore all of this information to ensure

that the simulation matches the uninterrupted simulation. For example, if solver information affected the simulation, then changing the state of a block without using `SimState` can produce different results.

- You can save several `SimStates` during a simulation. You can then resume a simulation from any of those states.
- `SimState` can help to restore the state of blocks such as the Transport Delay block, which is typically difficult to restore to a particular state. The state of the Transport Delay block is not saved in the structure format or the array format when you log data using the **Final states** configuration parameter without using `Simstate`. The blocks with hidden states are particularly difficult to restore, and `SimState` enables you to do so.

## When You Can Save a SimState

You can save a `SimState`:

- At the final **Stop time**
- When you interrupt a simulation with the **Pause** or **Stop** button
- When you use `get_param` or a block, like the Stop block, to stop a simulation

## Save SimState

Save a `SimState` at the beginning of the final step using one of these options.

### Interactive

- 1 In the Configuration Parameters dialog box, in the **Data Import/Export** pane, select the **Final states** check box. The **Save complete SimState in final state** check box becomes available.
- 2 Select the **Save complete SimState in final state** check box.
- 3 In the **Final states** text box, enter a variable name for the `SimState`.
- 4 Simulate the model.

### From the MATLAB Command Prompt

Use the `sim` command with `set_param`. Set the `SaveCompleteFinalSimState` parameter to `on`.

```
set_param mdl, 'SaveFinalState', 'on', 'FinalStateName', ...  
    [mdl 'SimState'], 'SaveCompleteFinalSimState', 'on')  
simOut = sim mdl, 'StopTime', tstop  
set_param mdl, 'SaveFinalState', 'off')
```

## Restore SimState

The **Start time** does not change from the value in the simulation that generated `SimState`. It is a reference value for all time and time-dependent variables in both the original and the current simulation. For example, a block can save and restore the number of sample time hits that occurred since the beginning of simulation as its `SimState`.

Consider a model that you ran from 0–100 s and that you now want to run from 100–200 s. The **Start time** is 0 s for both the original simulation (0–100 s) and for the current simulation (100–200 s). The initial time of the current simulation is 100 s. Also, if the block had 10 sample time hits during the original simulation, Simulink recognizes that the next sample time hit is the 11th, relative to 0, not 100 s.

---

**Note:** If you change **Start time** before restoring a `SimState`, Simulink overwrites the **Start time** with the value saved in the `SimState`.

---

Restore a `SimState` using one of these options.

### Interactive

- 1 In the Configuration Parameters dialog box, in the **Data Import/Export** pane, under **Load from workspace**, select the **Initial state** check box. The text box becomes available.
- 2 Enter the name of the variable containing the `SimState` in the text box.
- 3 Set **Stop time** to a value greater than the time at which the `SimState` was saved.

### From the MATLAB Command Prompt

Use `set_param` to specify the initial condition as the `SimState`.

```
set_param mdl, 'LoadInitialState', 'on', 'InitialState', ...  
    [mdl 'xFinal']);  
simOut.get([mdl 'SimState']);
```



## Restore SimState Saved in an Earlier Version of Simulink

You can use `SimState` objects saved in releases starting with R2010a to restore the `SimState` of a model. However, this option restores only the logged states of the model. To see the version of Simulink used to save the `SimState`, examine the **version** parameter of the `SimState` object.

Simulink detects if the `SimState` object you provided as the initial state was saved in the current release. By default, Simulink displays an error message if the `SimState` was not saved in the current release. You can configure the diagnostic to allow Simulink to display the message as a warning and try to restore as many of the values as possible.

To enable this best-effort restoration, in the Configuration Parameters dialog box, in the **All Parameters** pane, set the message for **SimState object from earlier release** to warning.

## Change the States of a Block Within SimState

- Use `loggedStates` to get or set the states of blocks. If `xout` is the state log that Simulink exports to the workspace, then the `loggedStates` field has the same structure as `xout.signals`.
- You cannot change the states that are not logged. Simulink does not allow this modification as it could cause the state to be inconsistent with the simulation.

## S-Functions

You can use APIs for C and Level-2 MATLAB S-functions to enable S-functions to work with `SimState`. For information on how to implement these APIs within S-functions, see “S-Function Compliance with the `SimState`”.

S-functions that have P-work vectors but do not declare their `SimState` compliance level or declare it to be unknown or disallowed do not support `SimState`. For more information, see “S-Function Compliance with the `SimState`”.

## Model Changes and SimState

- You cannot make any structural changes to the model between the time you save the `SimState` and the time you restore the simulation using the `SimState`. For example, you cannot add or remove a block after saving the `SimState` without repeating the simulation and saving the new `SimState`.

- The `SimState` interface checksum is primarily based on the configuration settings in a model. You can make some nonstructural changes to the model between saving and restoring a `SimState`. In the Configuration Parameters dialog box, in the **Diagnostics** pane, use the **SimState interface checksum mismatch** diagnostic to track such changes. You can then find out if the interface checksum of the restored `SimState` matches the current interface checksum.

Mismatches can occur when you try to simulate using a solver that is different from the one that generated the saved `SimState`. Simulink permits solver changes. For example, you can use the `ode15s` solver to solve the initial stiff portion of a simulation and save the final `SimState`. You can then continue the simulation with the restored `SimState` using `ode45`. In other words, this diagnostic helps you see the solver changes but does not signal a problem with the simulation.

- When you use a variable-step solver with the maximum step size set to `auto`, Simulink uses the maximum step size from the restored `SimState` for the new simulation. To ensure that the concatenated `SimState` trajectory of two simulations matches that of an uninterrupted simulation, specify a value for the maximum step size.

## Limitations of SimState

---

**Note:** In some cases, saving partial state information avoids some of the limitations of using `SimState`. For a comparison of the two ways to save state data, see “Comparison of `SimState` and Final State Logging” on page 59-262.

---

### Block Support

The following blocks do not support `SimState`:

- In the Stack and Queue blocks, the default setting for the **Push full stack** option is **Dynamic reallocation**. This default setting does not support `SimState`. Other settings (**Ignore**, **Warning** and **Error**) support `SimState`.
- Simscape Multibody First Generation blocks
- `SimEvents` blocks

Simulink tries to save the output of a block as part of a `SimState`. For S-functions, this happens even if the functions declare that no `SimState` is required. If the block output

is of custom type, Simulink cannot save the `SimState` and displays an error. For more information about `SimState` use with S-functions, see “S-Functions” on page 23-41.

Model reference offers partial support for `SimState`. For details, see “Model Referencing” on page 23-43.

### **Simulation**

- You can save `SimState` only at the final stop time or at the execution time at which you pause or stop the simulation.
- You can use only the Normal or the Accelerator simulation mode.
- You cannot save `SimState` in Normal mode and restore it in Accelerator mode, or vice versa.
- You cannot change the states of certain blocks that are not logged. For more information, see “Change the States of a Block Within `SimState`” on page 23-41.

### **Code Generation**

The `SimState` feature does not support Simulink Coder or Embedded Coder code generation.

### **Model Referencing**

- You cannot modify logged states of blocks that are inside a referenced model in Accelerator mode.
- The following blocks do not support `SimState` when included in a model referenced in Accelerator mode:
  - Level 2 MATLAB S-Function
  - MATLAB System
  - n-D Lookup Table
  - S-Function (with custom `SimState` or `PWork` vectors)
  - To File
  - Simscape blocks
- For additional information, see “State Information for Referenced Models” on page 59-265.

### **Model Function**

You cannot input the `SimState` to the `model` function.

### **More About**

- “Benefits of Using SimState” on page 23-38
- “Model Changes and SimState” on page 23-41
- “Limitations of SimState” on page 23-42

## View Diagnostics

You can view and diagnose errors and warnings generated by your model using the **Diagnostic Viewer**. The **Diagnostic Viewer** displays three types of diagnostic messages: errors, warnings, and information. A model generates these messages during a runtime operation, like model load, simulation, or update diagram.

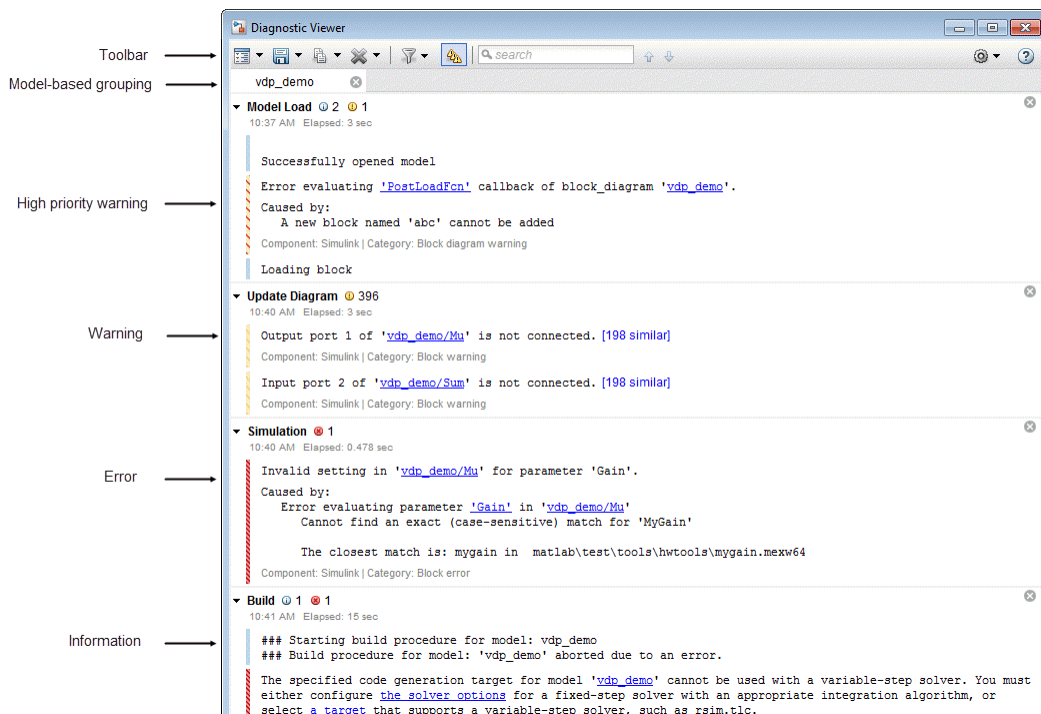









The diagnostic viewer window is divided into:

- **Toolbar menu:** Displays various commands to help you manage the diagnostic messages. For more information, see “Toolbar” on page 23-46.
- **Diagnostic Message pane:** Displays the error, warning, and information messages. For more information, see “Diagnostic Message Pane” on page 23-46.
- **Suggested Actions:** Displays suggestions and fixes to correct the diagnostic errors and warnings. For more information, see. “Suggested Actions” on page 23-48.

## Toolbar

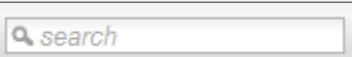
To manage the diagnostic messages, use the **Diagnostic Viewer** toolbar.

Button	Action
	Expand or collapse messages
	Save all or latest messages in a log file
	Copy all or latest messages
	Clear all or all but latest messages
	Filter out errors, warning, and information messages
	Group similar type of messages
	Search messages for specific keywords and navigate between messages
	Set maximum number of models to display in tabbed panes and the maximum number of events to display per model



## Diagnostic Message Pane

The diagnostic message pane displays the error, warning, and information messages in a tabbed format. These messages are color-coded for distinction and are hierarchical.

A new stage is generated for each successive event, you can save or clear stage. Each stage represents a single event such as model load, update diagram, or simulation.

Different types of diagnostic messages are:

- Information message: Displays the information related to a model load. Information messages are marked as .

- High priority warning: Displays the errors encountered during model load as a high priority warning. Any subsequent operation, like update on the model without rectifying the high priority warning messages are marked as errors. High priority warnings are marked as .
- Warning: Displays the warnings associated during an operation on a model. Warnings are marked as .
- Error: Displays the errors associated during an operation on a model. Errors are marked as .

**Tip:** To locate the source of error, click the hyperlink in the message. The source of error in the model is highlighted.

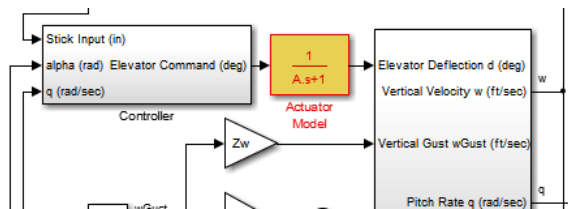

## Suppress Warnings

The Diagnostic viewer provides a **Suppress** button for certain diagnostics. This button allows you to suppress certain numerical warnings (for example, overflow, saturation, precision loss) for specific objects in your model. Click the **Suppress** button next to the warning in the Diagnostic viewer to suppress the warning from the specified source. You can restore the warning from the source by clicking **Restore**. Diagnostic suppressions are saved with the model and persist across sessions.

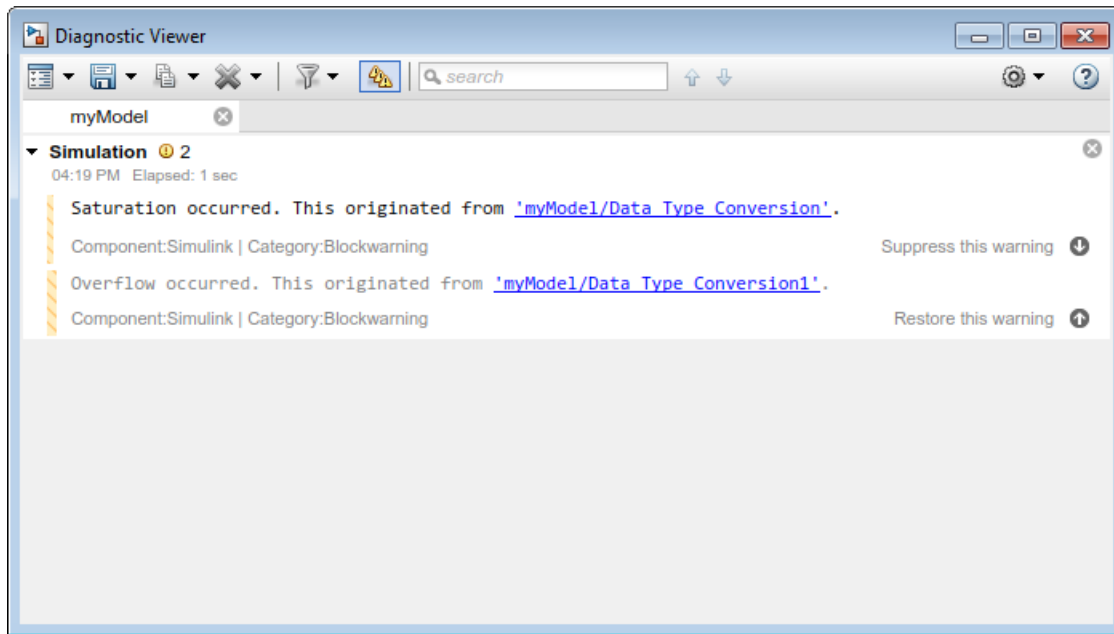

You can also control the suppression of warnings from the command line. For more information, see “Suppress Diagnostic Messages Programmatically” on page 23-56.

## Suggested Actions

Diagnostic viewer provides suggestions and fixes for diagnostic error and warning messages. These suggestions and fixes are provided in the **Suggested Actions** section of diagnostic message pane.

A diagnostic error or warning can have multiple fixes and suggestions. Each fix is associated with a **Fix** button.

You can click the **Fix** button for the most suitable fix to rectify the error automatically.



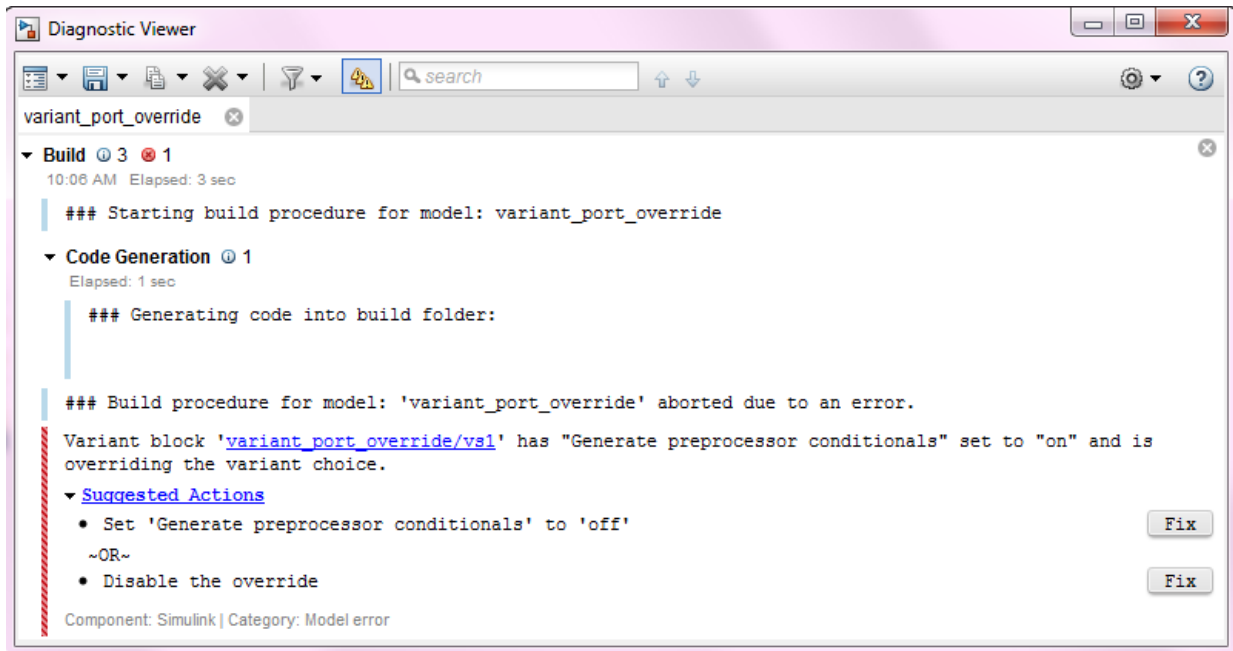

The **Fix** buttons for a diagnostic error or warning are no longer available after a fix is successfully applied. If a fix was unsuccessful, a failure message is displayed in the **Suggested Actions** section.

Suggestions are provided for errors and warnings that cannot be fixed automatically.

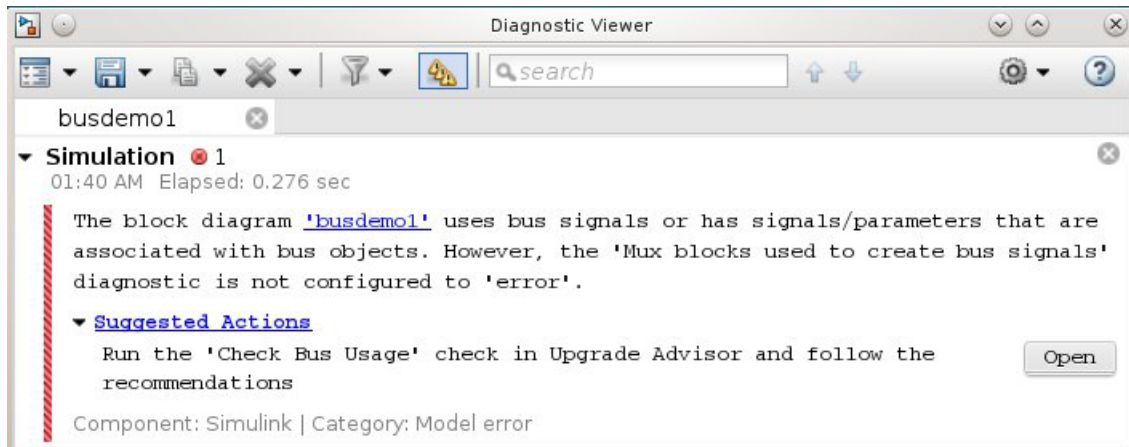

---

**Note:** The **Suggested Actions** section is available only for the diagnostic errors or warnings that have a predefined fix.

---

## Related Examples

- “Systematic Diagnosis of Errors and Warnings” on page 23-51
- “Customize Diagnostic Messages” on page 23-65
- “Report Diagnostic Messages Programmatically” on page 23-68

## Systematic Diagnosis of Errors and Warnings

This example shows how to use the Diagnostic Viewer to identify and locate simulation errors and warnings systematically.

- 1 Open your model.

If your model contains errors related to callback functions, the **Diagnostic Viewer** opens and displays the following errors in **Model Load** stage.

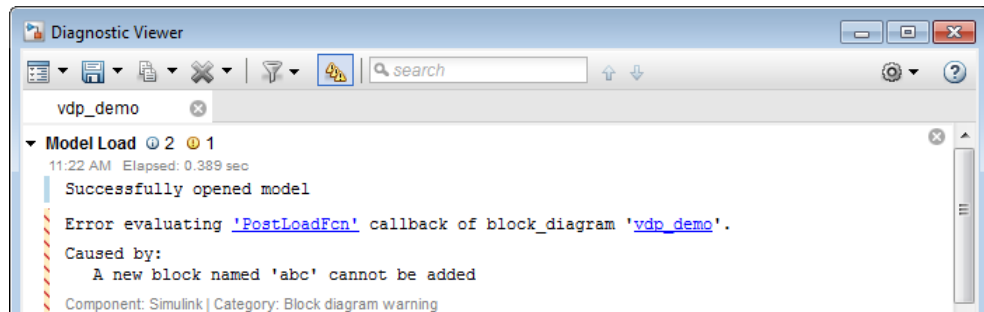

**Tip:** To open the **Diagnostic Viewer** window, click **View > Diagnostic Viewer** or click **View warnings** in the Simulink Editor.

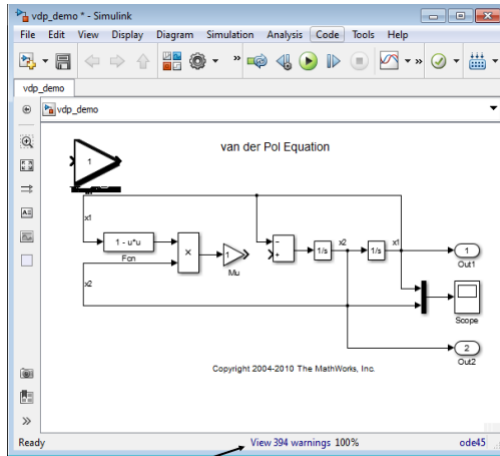

View warning

- 2 In the Simulink Editor, click **File > Model Properties > Model Properties**, and examine the callback error.

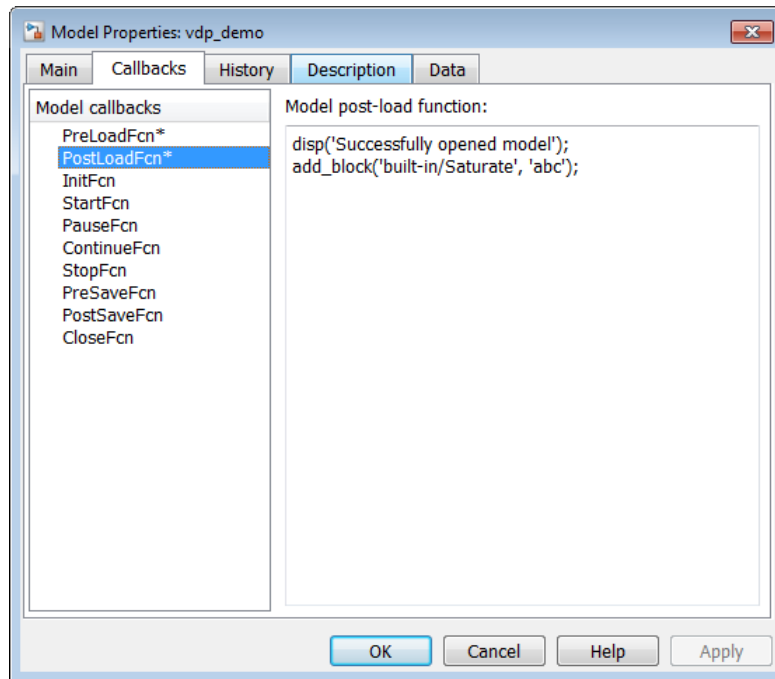

- 3 After fixing any callback errors, simulate the model to diagnose simulation errors and warnings.

**Diagnostic Viewer** lists errors and warnings in stages. Each stage in **Diagnostic Viewer** represents a single event such as model load, update diagram, simulation, or build.

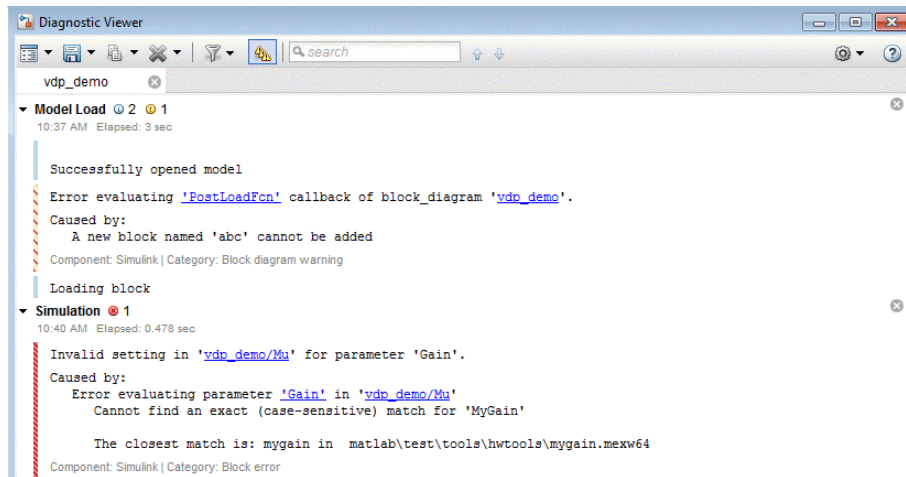

- 4 Filter out warnings by clicking  so that you can address errors first.
- 5 To locate the source of the error, click the hyperlink in the message. The model in the source is highlighted. If a block has multiple ports, you can hover over each port to see the port number.

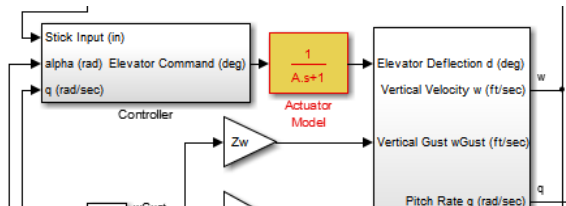

- 6 After fixing all errors, simulate your model again and view the **Diagnostic Viewer** to identify remaining problems.

---

**Note:** If an error or warning has a predefined fix, the diagnostic message pane displays a **Suggested Actions** section. You can use the **Fix** button provided in this section to rectify the related error or warning. For more information see, “Suggested Actions” on page 23-48.

---

- 7 If an object in your model generates a warning that you do not want to be notified of, sometimes, you can suppress the warning from the specified source using the **Suppress** button. You can restore the warning from that source using the **Restore**

button. For example, if a Counter Free-Running block generates an overflow warning that is intentional in your design, you can suppress only overflow warnings from this particular block, without sacrificing notification of other overflows in your model.

- 8 To generate code for your model, click **Code** > **C/C++ Code** > **Build Model**.

**Note:** If there is a failure during code generation, Diagnostic Viewer provides hyperlinks for easy navigation to the source of the error or warning message.

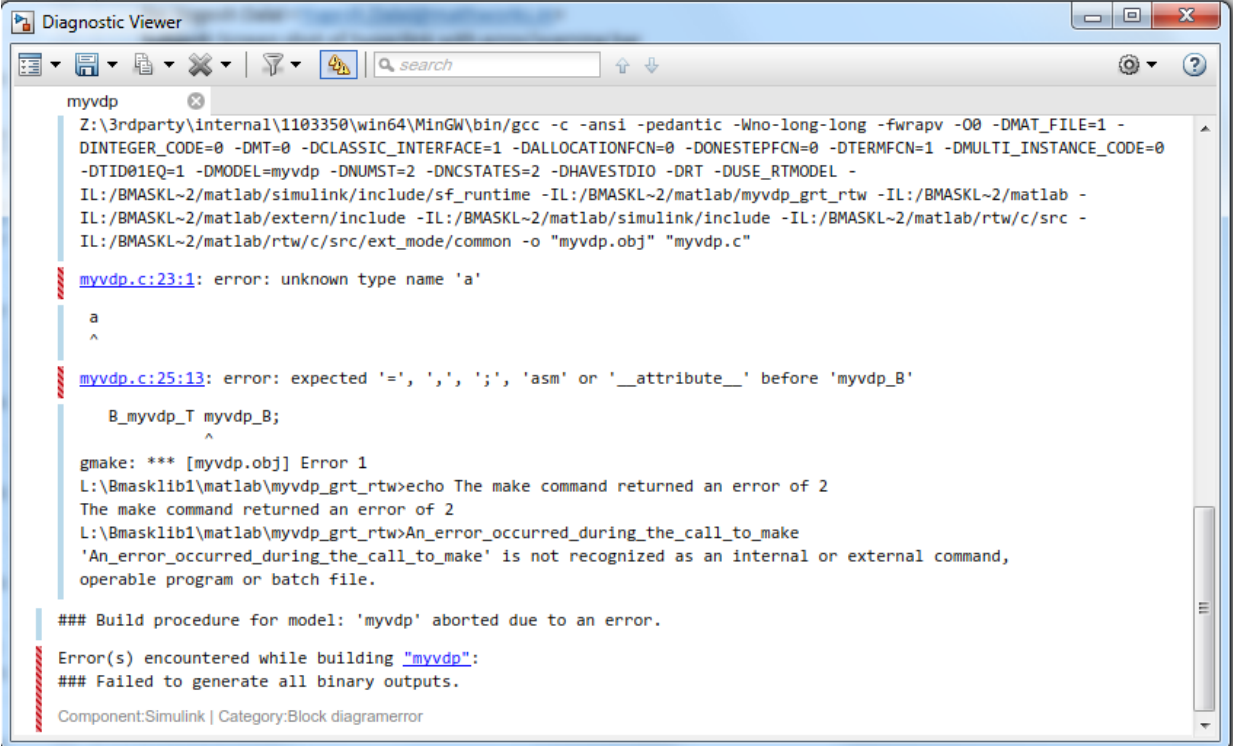

```

Diagnostic Viewer
myvdp
Z:\3rdparty\internal\1103350\win64\MinGW\bin/gcc -c -ansi -pedantic -Wno-long-long -fwrapv -O0 -DMAT_FILE=1 -
DINTEGER_CODE=0 -DMT=0 -DCLASSIC_INTERFACE=1 -DALLOCATIONFCN=0 -DONESTEPFCN=0 -DTERMFCN=1 -DMULTI_INSTANCE_CODE=0
-DTID01EQ=1 -DMODEL=myvdp -DNUMST=2 -DNCSTATES=2 -DHAVESTDIO -DRT -DUSE_RTMODEL -
IL:/BMSKAL~2/matlab/simulink/include/sf_runtime -IL:/BMSKAL~2/matlab/myvdp_grt_rtw -IL:/BMSKAL~2/matlab -
IL:/BMSKAL~2/matlab/extern/include -IL:/BMSKAL~2/matlab/simulink/include -IL:/BMSKAL~2/matlab/rtw/c/src -
IL:/BMSKAL~2/matlab/rtw/c/src/ext_mode/common -o "myvdp.obj" "myvdp.c"

myvdp.c:23:1: error: unknown type name 'a'
a
^

myvdp.c:25:13: error: expected '=', ',', ';', 'asm' or '__attribute__' before 'myvdp_B'
B_myvdp_T myvdp_B;
^

gmake: *** [myvdp.obj] Error 1
L:\Bmasklib1\matlab\myvdp_grt_rtw>echo The make command returned an error of 2
The make command returned an error of 2
L:\Bmasklib1\matlab\myvdp_grt_rtw>An_error_occurred_during_the_call_to_make
'An_error_occurred_during_the_call_to_make' is not recognized as an internal or external command,
operable program or batch file.

### Build procedure for model: 'myvdp' aborted due to an error.

Error(s) encountered while building "myvdp":
### Failed to generate all binary outputs.

Component:Simulink | Category:Block diagramerror
  
```

## Related Examples

- “Customize Diagnostic Messages” on page 23-65
- “Report Diagnostic Messages Programmatically” on page 23-68

## Suppress Diagnostic Messages Programmatically

The following examples show how to manage diagnostic suppressions programmatically.

### In this section...

“Suppress Diagnostic Messages Programmatically” on page 23-56

“Suppress Diagnostic Messages of a Referenced Model” on page 23-61

## Suppress Diagnostic Messages Programmatically

This example shows how to access simulation metadata to manage diagnostic suppressions and to restore diagnostic messages programmatically.

### Create a New Folder and Copy Relevant Files

- 1 Create a local working folder, for example, `c:\diadnostic_suppressor_demo`.
- 2 Change to the `docroot\toolbox\simulink\examples` folder. At the MATLAB command line, enter:

```
cd(fullfile(docroot, 'toolbox', 'simulink', 'examples'))
```

- 3 Copy the `getDiagnosticObjects.m`, `suppressor_script.m`, and `Suppressor_CLI_Demo.slx` files to your local working folder.

The `getDiagnosticObjects.m` function queries the simulation metadata to access diagnostics that were thrown during simulation. The `suppressor_script.m` script contains the commands for suppressing and restoring diagnostics to the `Suppressor_CLI_Demo` model.

### `getDiagnosticObjects.m`

```
function y = getDiagnosticObjects(in)
Warningdata = in.getSimulationMetadata.ExecutionInfo.WarningDiagnostics;
Errordata = in.getSimulationMetadata.ExecutionInfo.ErrorDiagnostic;

index = 1;

for i = 1 : numel(Warningdata)
    y(index) = Warningdata(i).Diagnostic;
    index = index + 1;
end
```



```

end

for i = 1 : numel(Errordata)
    y(index) = Errordata(i).Diagnostic;
    index = index + 1;
end
    
```

### Open and Simulate the Model

Open the model. To access Simulink.SimulationMetadata, set the ReturnWorkspaceOutputs parameter value to 'on'. Simulate the model.

```

model = 'Suppressor_CLI_Demo';
open_system(model);
set_param(model, 'ReturnWorkspaceOutputs', 'on');
out = sim(model);
    
```

### Fixed-Point to Fixed-Point Conversion

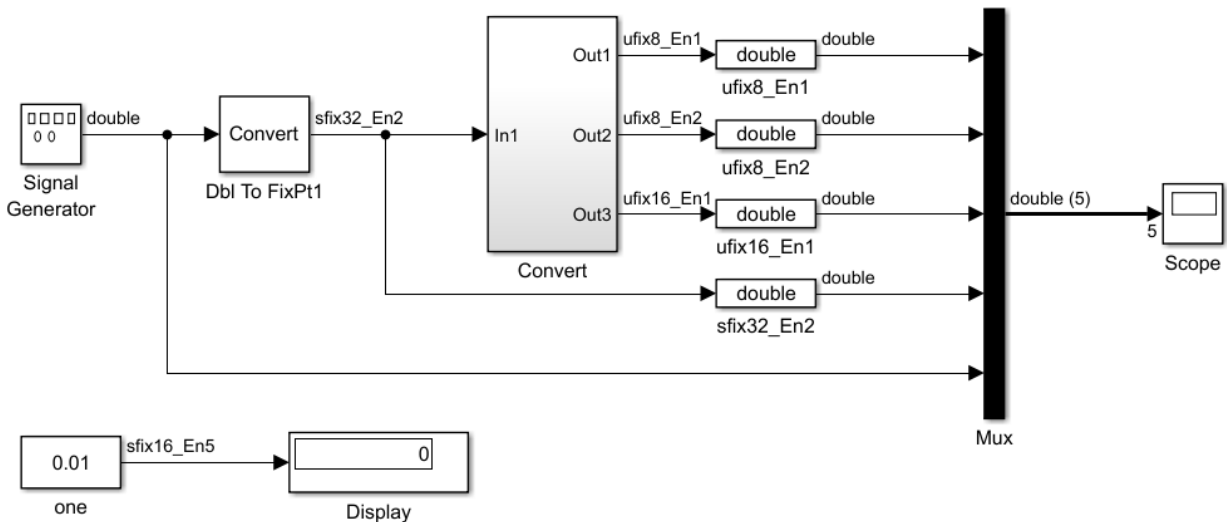

### Get Message Identifiers from Simulation Metadata

Find the names of diagnostic message identifiers using the simulation metadata stored in the MSLDiagnostic object.

```
if (exist('out', 'var'))
    diag_objects = getDiagnosticObjects(out);
end
```

Several warnings were generated during simulation, including a saturation of the Data Type Converter block. Query the `diag_objects` variable to get more information on the identifiers.

```
diag_objects(5)
```

```
ans =
```

```
MSLDiagnostic with properties:
```

```
    identifier: 'SimulinkFixedPoint:util:Saturationoccurred'
    message: 'Saturation occurred. This originated from 'Suppressor_CLI_Demo/Con...'
    paths: {'Suppressor_CLI_Demo/Convert/FixPt To FixPt3'}
    cause: {}
    stack: [0x1 struct]
```

### Suppress Saturation Diagnostic on a Block

Use the `Simulink.suppressDiagnostic` function to suppress the saturation diagnostic on the data type conversion block only. Simulate the model.

```
Simulink.suppressDiagnostic('Suppressor_CLI_Demo/Convert/FixPt To FixPt3', 'SimulinkFixedPoint:util:Saturationoccurred');
set_param(model, 'SimulationCommand', 'start');
```

### Restore the Saturation Diagnostic

Use the `Simulink.restoreDiagnostic` function to restore the saturation diagnostic of the same block.

```
Simulink.restoreDiagnostic('Suppressor_CLI_Demo/Convert/FixPt To FixPt3', 'SimulinkFixedPoint:util:Saturationoccurred');
set_param(model, 'SimulationCommand', 'start');
```

### Suppress Multiple Diagnostics on a Source

You can suppress multiple warnings on a single source by creating a cell array of message identifiers. Suppress the precision loss and parameter underflow warnings of the Constant block, `one`, in the model.

```
diags = {'SimulinkFixedPoint:util:fxpParameterPrecisionLoss', 'SimulinkFixedPoint:util:fxpParameterUnderflow'};
Simulink.suppressDiagnostic('Suppressor_CLI_Demo/one', diags);
set_param(model, 'SimulationCommand', 'start');
```

## Restore All Diagnostics on a Block

Restore all diagnostics on a specified block using the `Simulink.restoreDiagnostic` function.

```
Simulink.restoreDiagnostic('Suppressor_CLI_Demo/one');
set_param(model, 'SimulationCommand', 'start');
```

## Suppress a Diagnostic on Many Blocks

You can suppress one or more diagnostics on many blocks. For example, use the `find_system` function to create a cell array of all Data Type Converter blocks in a system, and suppress all saturation warnings on the specified blocks.

```
dtc_blocks = find_system('Suppressor_CLI_Demo/Convert', 'BlockType', 'DataTypeConversion');
Simulink.suppressDiagnostic(dtc_blocks, 'SimulinkFixedPoint:util:Saturationoccurred');
set_param(model, 'SimulationCommand', 'start');
```

## Restore All Diagnostics Inside a Subsystem

You can also use the `Simulink.restoreDiagnostic` function to restore all diagnostics inside a specified subsystem.

```
Simulink.restoreDiagnostic('Suppressor_CLI_Demo/Convert', 'FindAll', 'On');
set_param(model, 'SimulationCommand', 'start');
```

## Add Comments and User Information to a Suppression

A `SuppressedDiagnostic` object contains information on the source of the suppression and the suppressed diagnostic message identifier. You can also include comments, and the name of the user who last modified the suppression.

```
Object = Simulink.SuppressedDiagnostic('Suppressor_CLI_Demo/Convert/FixPt To FixPt1',
Object.Comments = 'Reviewed: John Doe';
Object.LastModifiedBy = 'Joe Schmoe';
set_param(model, 'SimulationCommand', 'start');
```

```
Object =
```

```
SuppressedDiagnostic with properties:
```

```
    Source: 'Suppressor_CLI_Demo/Convert/FixPt To FixPt1'
    Id: 'SimulinkFixedPoint:util:Saturationoccurred'
    LastModifiedBy: 'Joe Schmoe'
    Comments: 'Reviewed: John Doe'
```

```
LastModified: '2016-Jun-21 18:23:01'
```

### **Get Suppression Data**

To get suppression data for a certain subsystem or block, use the `Simulink.getSuppressedDiagnostics` function.

```
Object = Simulink.getSuppressedDiagnostics('Suppressor_CLI_Demo/Convert/FixPt To FixPt');  
set_param(model, 'SimulationCommand', 'start');
```

### **Restore All Diagnostics on a Model**

When a model contains many diagnostic suppressions, and you want to restore all diagnostics to a model, use the `Simulink.getSuppressedDiagnostics` function to return an array `Simulink.SuppressedDiagnostic` objects. Then use the `Simulink.SuppressedDiagnostic.restore` method as you iterate through the array.

```
Objects = Simulink.getSuppressedDiagnostics('Suppressor_CLI_Demo');  
for iter = 1:numel(Objects)  
    restore(Objects(iter));  
end  
set_param(model, 'SimulationCommand', 'start');
```

## Suppress Diagnostic Messages of a Referenced Model

This example shows how to suppress a diagnostic when the diagnostic originates from a referenced model. By accessing the `MSLDiagnostic` object of the specific instance of the warning, you can suppress the warning only for instances when the referenced model is simulated from the specified top model.

This example model contains two instances of the same referenced model, `RefModel`. The model `RefModel` references yet another model, `RefModel_Low`. `RefModel_Low` contains two Gain blocks that each produce a wrap on overflow warning during simulation. Suppress one of the four instances of this warning in the model by accessing the `MSLDiagnostic` object associated with the wrap on overflow produced by one of the Gain blocks in the `RefModel_Low` model only when it is referenced by `Ref_block1`.

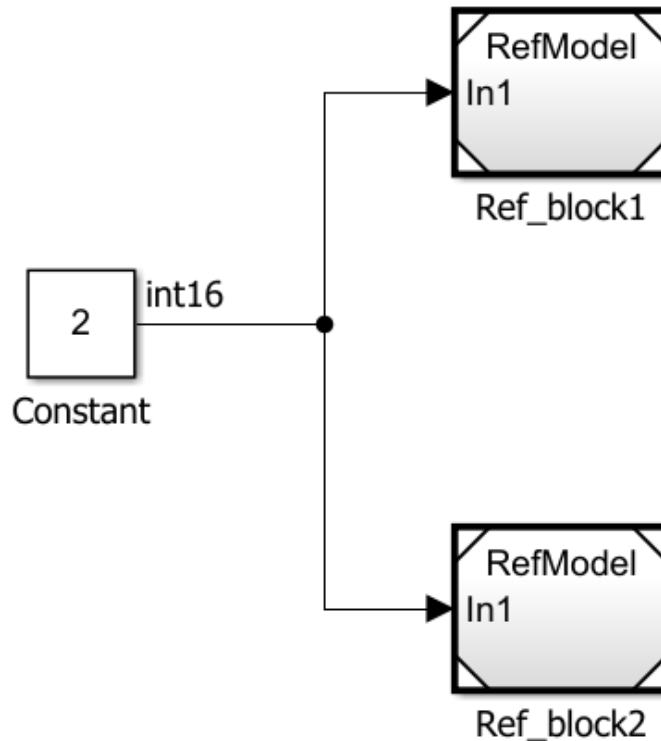

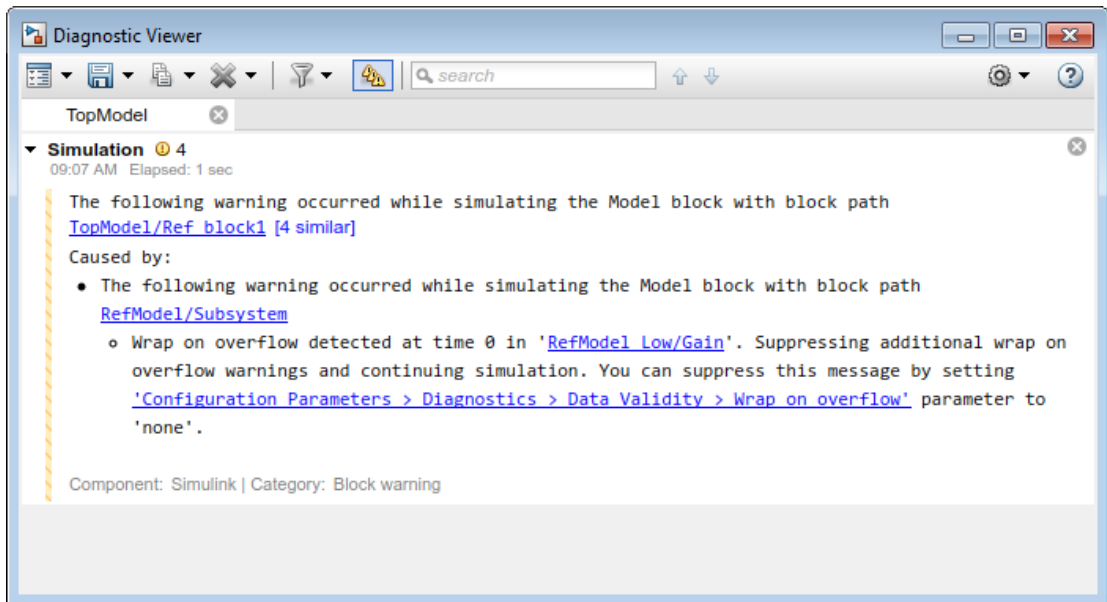
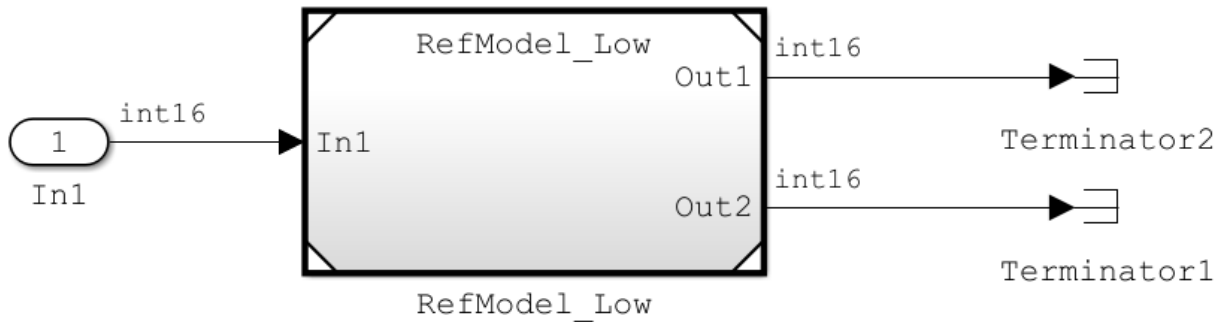

Open the top model. Simulate the model and store the output in a variable, out.

```
out = sim('TopModel');
```

Access the simulation metadata stored in the MSLDiagnostic object.

```
diag = getDiagnosticObjects(out)

diag =

    1×4 MSLDiagnostic array with properties:

        identifier
        message
        paths
        cause
        stack
```

You can view the diagnostics and their causes in the Diagnostic Viewer or at the command-line.

```
for i = 1 : numel(diag)
    disp(diag(i));
    disp(diag(i).cause{1});
end
```

Suppress one of the wrap on overflow warnings from `RefModel_Low` only when it is simulated from `TopModel/Ref_block1` by accessing the specific diagnostic. Simulate the model.

```
Simulink.suppressDiagnostic(diag(1));
out = sim('TopModel')
```

Access the simulation metadata. This simulation produced only three warnings.

```
diag = getDiagnosticObjects(out)

diag =

    1×3 MSLDiagnostic array with properties:

        identifier
        message
        paths
        cause
        stack
```

Restore the diagnostic to the model.

```
Simulink.restoreDiagnostic(diag(1));
```

### **See Also**

[Simulink.SuppressedDiagnostic.restore](#) | [Simulink.SuppressedDiagnostic](#) | [Simulink.SimulationMetadata](#) | [Simulink.getSuppressedDiagnostics](#) | [Simulink.restoreDiagnostic](#) | [Simulink.suppressDiagnostic](#)



## Customize Diagnostic Messages

### In this section...

“Display Custom Text” on page 23-65

“Create Hyperlinks to Files, Folders, or Blocks” on page 23-66

“Create Programmatic Hyperlinks” on page 23-66

The **Diagnostic Viewer** displays the output of MATLAB error functions executed during simulation.

You can customize simulation error messages in the following ways by using MATLAB error functions in callbacks, S-functions, or MATLAB Function blocks.

### Display Custom Text

This example shows how to can customize the MATLAB function `check_signal` to display the text `Signal is negative`.

- 1 Open the MATLAB Function for editing.

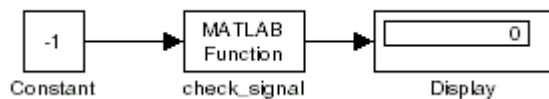

- 2 In the MATLAB Editor, create a function to display custom text.

```

function y = check_signal(x)
    if x < 0
        error('Signal is negative');
    else
        y = x;
    end
  
```

- 3 Simulate the model.

A runtime error appears and you are prompted to start the debugger. Click **OK**.

- 4 To view the following error in **Diagnostic Viewer**, close the debugger.

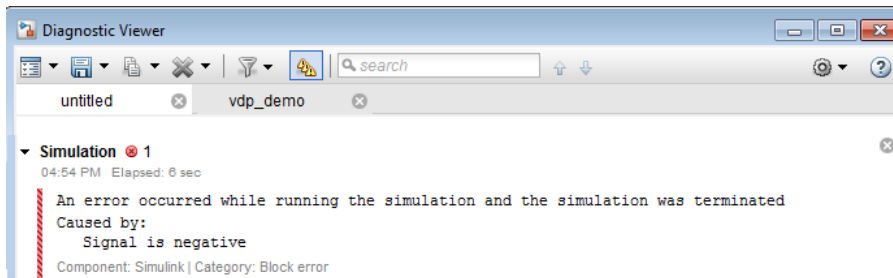

## Create Hyperlinks to Files, Folders, or Blocks

To create hyperlinks to files, folders, or blocks in an error message, include the path to these items within customized text.

Example error message	Hyperlink
<code>error('Error reading data from "C:/Work/designData.mat"')</code>	Opens <code>designData.data</code> in the MATLAB Editor.
<code>error('Could not find data in folder "C:/Work"')</code>	Opens a Command Window and sets <code>C:\Work</code> as the working folder.
<code>error('Error evaluating parameter in block "myModel/Mu"')</code>	Displays the block <code>Mu</code> in model <code>myModel</code> .

## Create Programmatic Hyperlinks

This example shows how to can customize the MATLAB function `check_signal` to display a hyperlink to the documentation for `find_system`.

- 1 Open the MATLAB Function for editing.

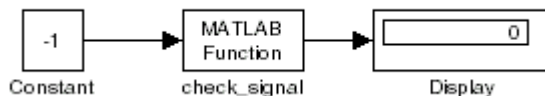

- 2 In the MATLAB Editor, create a function to display custom text.

```
function y = check_signal(x)
    if x < 0
```

```
    error('See help for <a href="matlab:doc find_system">find_system</a>');  
else  
    y = x;  
end
```

- 3 Simulate the model.

A runtime error appears and you are prompted to start the debugger. Click **OK**.

- 4 To view the following error in **Diagnostic Viewer**, close the debugger.

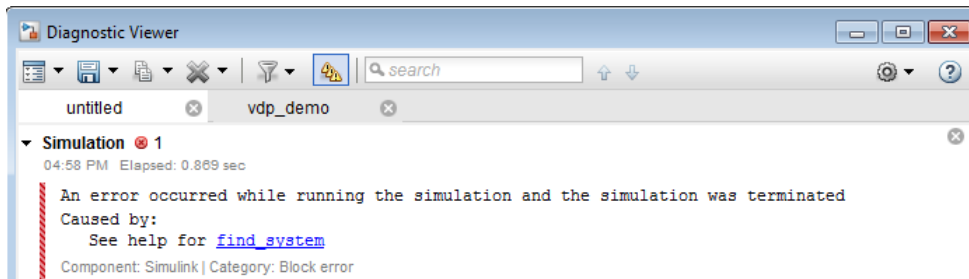

## Related Examples

- “Systematic Diagnosis of Errors and Warnings” on page 23-51
- “Report Diagnostic Messages Programmatically” on page 23-68

## Report Diagnostic Messages Programmatically

The `sldiagviewer` functions enable you to generate, display, and log diagnostic messages in the Diagnostic Viewer.

You can use these functions to report the diagnostic messages programmatically:

- Function to create a stage: `sldiagviewer.createStage`
- Functions to report diagnostic messages:
  - `sldiagviewer.reportError`
  - `sldiagviewer.reportWarning`
  - `sldiagviewer.reportInfo`
- Function to log the diagnostics: `sldiagviewer.diary`

### Create Diagnostic Stages

In the Diagnostic Viewer, errors, warnings, and information messages are displayed in groups based on the operation, such as model load, simulation, and build. These groups are called stages. The `sldiagviewer.createStage` function enables you to create stages. You can also create child stages for a stage object. A parent stage object must be active to create a child stage. When you create a stage object, Simulink initializes a stage. When you close the stage object, Simulink ends the stage. If you delete a parent stage object, the corresponding parent and its child stage close in the Diagnostic Viewer. The syntax for creating a stage is:

```
stageObject =  
sldiagviewer.createStage(StageName, 'ModelName', ModelNameValue)
```

In this syntax,

- `StageName` specifies the name of a stage and is a required argument, for example, 'Analysis'.
- Use the 'ModelName', `ModelNameValue` pair to specify the model name of a stage, for example 'ModelName', 'vdp'. All the child stages inherit the model name from their parent.

#### Example to Create Stage

```
my_stage = sldiagviewer.createStage('Analysis', 'ModelName', 'vdp');
```

## Report Diagnostic Messages

You can use the `sldiagviewer` functions to report error, warning, or information messages in the Diagnostic Viewer. The syntaxes for reporting diagnostic messages are:

- `sldiagviewer.reportError(Message)`: Reports the error messages.
- `sldiagviewer.reportWarning(Message)`: Reports the warnings.
- `sldiagviewer.reportInfo(Message)`: Reports the information messages.

`Message` describes the error, warning, or build information and is a required argument. `Message` can have values in these formats:

- String
- `MSLException` or `MException` object

Optionally, you can use the '`Component`' argument and its corresponding value in the syntax to specify the component or product that generates the message, for example, '`Simulink`' and '`Stateflow`'.

### Example to Report Diagnostics

```
% Create a Stage to display all the messages

my_stage = sldiagviewer.createStage('Analysis', 'ModelName', 'vdp');

% Catch the error introduced in vdp as an exception.

try
sim('vdp');
catch error
end

% Report the caught exception as warning

sldiagviewer.reportWarning(error);

% Report a custom info message to Diagnostic Viewer

sldiagviewer.reportInfo('My Info message');
```

## Log Diagnostic Messages

You can use the `sldiagviewer.diary` function to log the simulation warning, error, and build information to a file. The syntaxes for generating log files are:

- `sldiagviewer.diary`: Intercepts the build information, warnings, and errors transmitted to the Diagnostic Viewer and logs them to a text file `diary.txt` in the current directory.
- `sldiagviewer.diary(filename)`: Toggles the logging state of the text file specified by `filename`.
- `sldiagviewer.diary(toggle)`: Toggles the logging ability. Valid values are 'on' and 'off'. If you have not specified a log file name, the toggle setting applies to the last file name that you specified for logging or to the `diary.txt` file.
- `sldiagviewer.diary(filename, 'UTF-8')`: Specifies the character encoding for the log file.

In this syntax,

- `filename` specifies the file to log the data to.
- `toggle` specifies the logging state 'on' or 'off'.

### Example to Log Diagnostic Messages

```
% Log messages using sldiagviewer.diary

sldiagviewer.diary
open_system('vdp')
rtwbuild('vdp')

% Open diary.txt to view logs.

### Starting build procedure for model: vdp
### Build procedure for model: 'vdp' aborted due to an error.
...
% Log messages using sldiagviewer.diary(filename)

sldiagviewer.diary('C:\MyLogs\log1.txt')

% Log messages using sldiagviewer.diary(toggle)

sldiagviewer.diary('C:\MyLogs\log1.txt') % Start logging
open_system('vdp')
```

```
rtwbuild('vdp')

sldiagviewer.diary('off') % Switch off logging
open_system('sldemo_fuelsys')
rtwbuild('sldemo_fuelsys')

sldiagviewer.diary('on') % Resume logging

% Log messages using sldiagviewer.diary(filename,'UTF-8')

sldiagviewer.diary('C:\MyLogs\log1.txt','UTF-8')
```

## More About

- “View Diagnostics” on page 23-45
- “Systematic Diagnosis of Errors and Warnings” on page 23-51





# Running a Simulation Programmatically

---

- “Run Simulations Programmatically” on page 24-2
- “Control Simulations Programmatically” on page 24-8
- “Run Parallel Simulations” on page 24-11
- “Error Handling in Simulink Using MSLException” on page 24-28

## Run Simulations Programmatically

You can programmatically simulate a model with the `sim` function, using various techniques to specify parameter values. In addition to simulation using the `sim` function, these examples show you how to enable simulation timeouts, capture simulation errors, and access simulation metadata when your simulation is complete.

### In this section...

“Specify Parameter Name-Value Pairs” on page 24-2

“Specify a Configuration Set” on page 24-3

“Enable Simulation Timeouts” on page 24-4

“Capture Simulation Errors” on page 24-4

“Access Simulation Metadata” on page 24-5

### Specify Parameter Name-Value Pairs

This example shows how to programmatically simulate a model, specifying parameters as name-value pairs.

Simulate the `vdp` model with parameter values specified as consecutive name-value pairs.

```
simOut = sim('vdp','SimulationMode','normal','AbsTol','1e-5',...
            'SaveState','on','StateSaveName','xout',...
            'SaveOutput','on','OutputSaveName','yout',...
            'SaveFormat','Dataset');
outputs = simOut.get('yout')
```

```
outputs =
```

```
Simulink.SimulationData.Dataset
Package: Simulink.SimulationData
```

```
Characteristics:
  Name: 'yout'
  Total Elements: 2
```

```
Elements:
  1 : 'x1'
  2 : 'x2'
```

- Use `getElement` or `getElement` to access elements by index or name.
- Use `addElement` or `setElement` to add or modify elements.

You simulate the model in **Normal** mode, specifying an absolute tolerance for solver error. The `sim` function returns `SimOut`, a single `Simulink.SimulationOutput` object that contains all of the simulation outputs (logged time, states, and signals). The `sim` function *does not* return simulation values to the workspace.

Plot the output signal values against time.

```
x1=(outputs.get('x1').Values);  
x2=(outputs.get('x2').Values);  
plot(x1); hold on;  
plot(x2);  
title('VDP States')  
xlabel('Time'); legend('x1','x2')
```

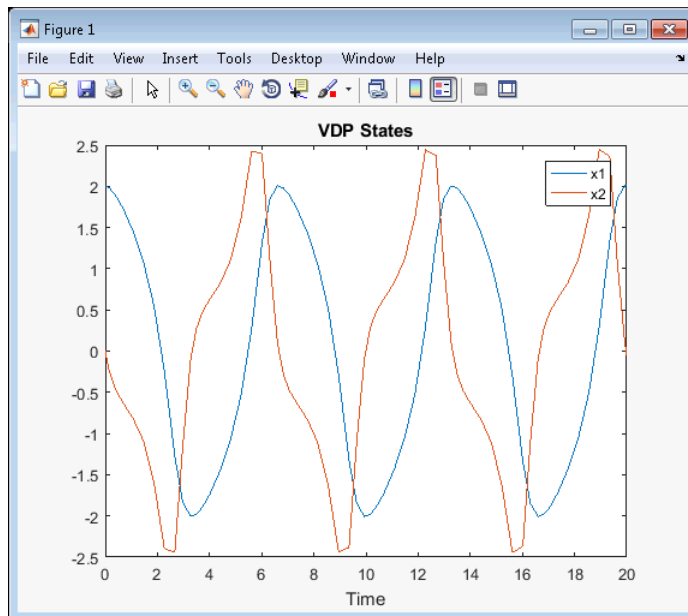

## Specify a Configuration Set

This example shows how to specify parameter values in a new configuration set.

Create a new configuration set by copying the active configuration set and changing it using `set_param`. Then, use `sim` to simulate the model with the new configuration set.

```
model = 'vdp';
load_system(model)
cs = getActiveConfigSet(model);
model_cs = cs.copy;
set_param(model_cs, 'AbsTol', '1e-5', ...
    'SaveState', 'on', 'StateSaveName', 'xout', ...
    'SaveOutput', 'on', 'OutputSaveName', 'yout')
simOut = sim(model, model_cs);
```

## Enable Simulation Timeouts

If you are running multiple simulations in a loop and are using a variable-step solver, consider using `sim` with the `timeout` parameter. If, for some reason, a simulation hangs or begins to take unexpectedly small time steps, it will time out. Then, the next simulation can run. Example syntax is shown below.

```
N = 100;
simOut = repmat(Simulink.SimulationOutput, N, 1);
for i = 1:N
    simOut(i) = sim('vdp', 'timeout', 1000);
end
```

## Capture Simulation Errors

If an error causes your simulation to stop, you can see the error in the simulation metadata. In this case, `sim` captures simulation data in the simulation output object up to the time it encounters the error, enabling you to do some debugging of the simulation without rerunning it. To enable this feature, use the `CaptureErrors` parameter with the `sim` function.

Example syntax and resulting output for capturing errors with `sim` is:

```
simOut = sim('my_model', 'CaptureErrors', 'on');
simOut.getSimulationMetadata.ExecutionInfo

ans =

    struct with fields:
```

```

        StopEvent: 'DiagnosticError'
    StopEventSource: []
    StopEventDescription: 'Division by zero in 'my_model/Divide''
    ErrorDiagnostic: [1×1 struct]
    WarningDiagnostics: [0×1 struct]

```

Another advantage of this approach is that the simulation error does not also cause `sim` to stop. Therefore, if you are using `sim` in a `for` loop for example, subsequent iterations of the loop will still run.

## Access Simulation Metadata

This example shows you how to access simulation metadata once your simulation is complete.

Run the simulation as described in “Specify Parameter Name-Value Pairs” on page 24-2.

```

simOut = sim('vdp','SimulationMode','normal','AbsTol','1e-5',...
            'SaveState','on','StateSaveName','xoutNew',...
            'SaveOutput','on','OutputSaveName','youtNew',...
            'SaveFormat','StructureWithTime');

```

Access the `ModelInfo` property, which has some basic information about the model and solver.

```
simOut.getSimulationMetadata.ModelInfo
```

```
ans =
```

```
struct with fields:
```

```

        ModelName: 'vdp'
    ModelVersion: '1.6'
    ModelFilePath: 'C:\MyWork'
        UserID: 'User'
        MachineName: 'MyMachine'
        Platform: 'PCWIN64'
    ModelStructuralChecksum: [4×1 uint32]
    SimulationMode: 'normal'
        StartTime: 0
        StopTime: 20
    SolverInfo: [1×1 struct]

```

```
SimulinkVersion: [1×1 struct]
LoggingInfo: [1×1 struct]
```

Inspect the solver information.

```
simOut.getSimulationMetadata.ModelInfo.SolverInfo
```

```
ans =
```

```
struct with fields:
    Type: 'Variable-Step'
    Solver: 'ode45'
    MaxStepSize: 0.4000
```

Review timing information for your simulation, such as when your simulation started and finished, and the time the simulation took to initialize, execute, and terminate.

```
simOut.getSimulationMetadata.TimingInfo
```

```
ans =
```

```
struct with fields:
    WallClockTimestampStart: '2016-06-17 10:26:58.433686'
    WallClockTimestampStop: '2016-06-17 10:26:58.620687'
    InitializationElapsedWallTime: 0.1830
    ExecutionElapsedWallTime: 1.0000e-03
    TerminationElapsedWallTime: 0.0030
    TotalElapsedWallTime: 0.1870
```

Add notes to your simulation.

```
simOut=simOut.setUserString('Results from simulation 1 of 10');
simOut.getSimulationMetadata
```

```
ans =
```

```
SimulationMetadata with properties:
    ModelInfo: [1×1 struct]
    TimingInfo: [1×1 struct]
    ExecutionInfo: [1×1 struct]
    UserString: 'Results from simulation 1 of 10'
    UserData: []
```

You can also add your own custom data using the `UserData` property.

## See Also

`Simulink.SimulationMetadata` | `Simulink.SimulationOutput`  
| `Simulink.SimulationOutput.getSimulationMetadata` |  
`Simulink.SimulationOutput.setUserData` | `Simulink.SimulationOutput.setUserString`

## Related Examples

- “Control Simulations Programmatically” on page 24-8
- “Run Multiple Simulations” on page 25-2

## Control Simulations Programmatically

These examples show you how to use `set_param` and `get_param` to programmatically control a model simulation, check the status of a running simulation, and control simulations using block callbacks.

### In this section...

“Control and Check Status of Simulation” on page 24-8

“Automate Simulation Tasks Using Block Callbacks” on page 24-9

### Control and Check Status of Simulation

This example shows how to use `set_param` to control and check the status of your simulation.

Start a simulation.

```
set_param('vdp', 'SimulationCommand', 'start')
```

When you start a simulation using `set_param` and the `'start'` argument, you must use the `'stop'` argument to stop it.

Pause, continue, and stop a simulation.

```
set_param('vdp', 'SimulationCommand', 'pause')
set_param('vdp', 'SimulationCommand', 'continue')
set_param('vdp', 'SimulationCommand', 'stop')
```

When you use `set_param` to start, pause, continue or stop a simulation, the commands are requests for such actions and the simulation doesn't execute them immediately. Simulink first completes uninterruptable work, such as solver steps and other commands that preceded the `set_param` command. Then, simulation starts, pauses, continues or stops as specified by the `set_param` command.

Check the status of a simulation.

```
get_param('vdp', 'SimulationStatus')
```

The software returns `'stopped'`, `'initializing'`, `'running'`, `'paused'`, `'compiled'`, `'updating'`, `'terminating'`, or `'external'` (used with the Simulink Coder product).



Update changed workspace variables dynamically while a simulation is running.

```
set_param('vdp','SimulationCommand','update')
```

Write all data-logging variables to the base workspace.

```
set_param('vdp','SimulationCommand','WriteDataLogs')
```

## Automate Simulation Tasks Using Block Callbacks

A callback executes when you perform various actions on your model, such as starting, pausing, or stopping a simulation. You can use callbacks to execute a MATLAB script or other MATLAB commands. For more information, see “Callbacks for Customized Model Behavior” on page 4-46 and “Block Callback Parameters” on page 4-52.

This example shows how to use the model `StartFcn` callback to automatically execute MATLAB code before the simulation starts.

Write a MATLAB script that finds Scope blocks in your model and opens them in the foreground when you simulate the model.

```
% openscopes.m
% Brings scopes to forefront at beginning of simulation.

blocks = find_system(bdroot,'BlockType','Scope');

% Finds all of the scope blocks in the top level of your
% model. To find scopes in subsystems, provide the subsystem
% names. Type help find_system for more on this command.

for i = 1:length(blocks)
    set_param(blocks{i},'Open','on')
end

% Loops through all of the scope blocks and brings them
% to the forefront.
```

Set the `StartFcn` parameter for the model to call the script.

```
set_param('my_model','StartFcn','openscopes')
```

## Related Examples

- “Run Simulations Programmatically” on page 24-2

- “Run Multiple Simulations” on page 25-2

## Run Parallel Simulations

---

**Note:** Running parallel simulations using the `sim` function within a `parfor` loop is no longer recommended. To learn how to run parallel simulations using the `parsim` function, see “Run Multiple Simulations” on page 25-2.

---

### In this section...

“Overview of Calling `sim` from Within `parfor`” on page 24-11

“Simulink and Parallel Computing Toolbox Software” on page 24-15

“Simulink and MATLAB Distributed Computing Server Software” on page 24-16

“`sim` in `parfor` with Normal Mode” on page 24-16

“`sim` in `parfor` with Normal Mode and MATLAB Distributed Computing Server Software” on page 24-18

“`sim` in `parfor` with Rapid Accelerator Mode” on page 24-19

“Workspace Access Issues” on page 24-21

“Resolving Workspace Access Issues” on page 24-21

“Data Concurrency Issues” on page 24-24

“Resolving Data Concurrency Issues” on page 24-25

### Overview of Calling `sim` from Within `parfor`

The `parfor` command allows you to run parallel (simultaneous) Simulink simulations of your model (design). In this context, parallel runs mean multiple model simulations at the same time on different workers. Calling `sim` from within a `parfor` loop often helps for performing multiple simulation runs of the same model for different inputs or for different parameter settings. For example, you can save simulation time performing parameter sweeps and Monte Carlo analyses by running them in parallel. Note that running parallel simulations using `parfor` does not currently support decomposing your model into smaller connected pieces and running the individual pieces simultaneously on multiple workers.

Normal, Accelerator, and Rapid Accelerator simulation modes are supported by `sim` in `parfor`. (See “Choosing a Simulation Mode” on page 33-12 for details on selecting a simulation mode and “Design Your Model for Effective Acceleration” on page 33-18

for optimizing simulation run times.) For other simulation modes, you need to address any workspace access issues and data concurrency issues to produce useful results. Specifically, the simulations need to create separately named output files and workspace variables. Otherwise, each simulation overwrites the same workspace variables and files, or can have collisions trying to write variables and files simultaneously.

For information on code regeneration and parameter handling in Rapid Accelerator mode, see “Parameter Tuning in Rapid Accelerator Mode” on page 33-9.

Also, see `parfor`.

---

**Note:** If you open models inside a `parfor` statement, close them again using `bdclose all` to avoid leaving temporary files behind.

---

### **Computationally Intensive Simulations**

To further improve the performance of multiple simulations of the same model, you can use:

- Multiple designated workers (MATLAB computational engines) using the Parallel Computing Toolbox software

## Multicore Desktop

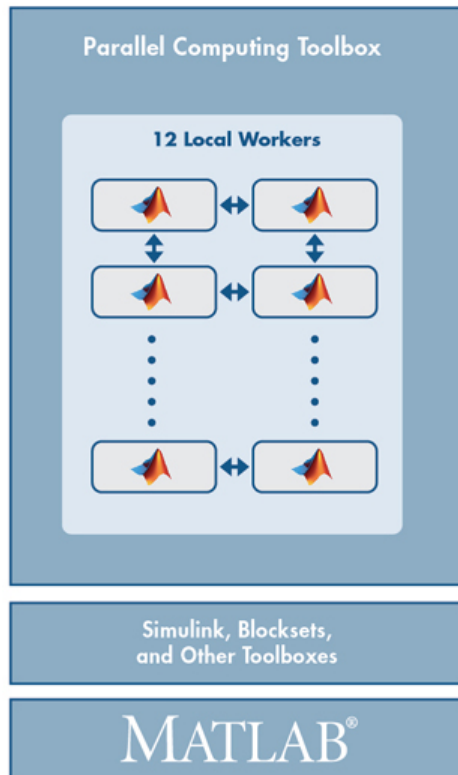

- Multiple computer clusters, clouds, and grids using the MATLAB Distributed Computing Server software

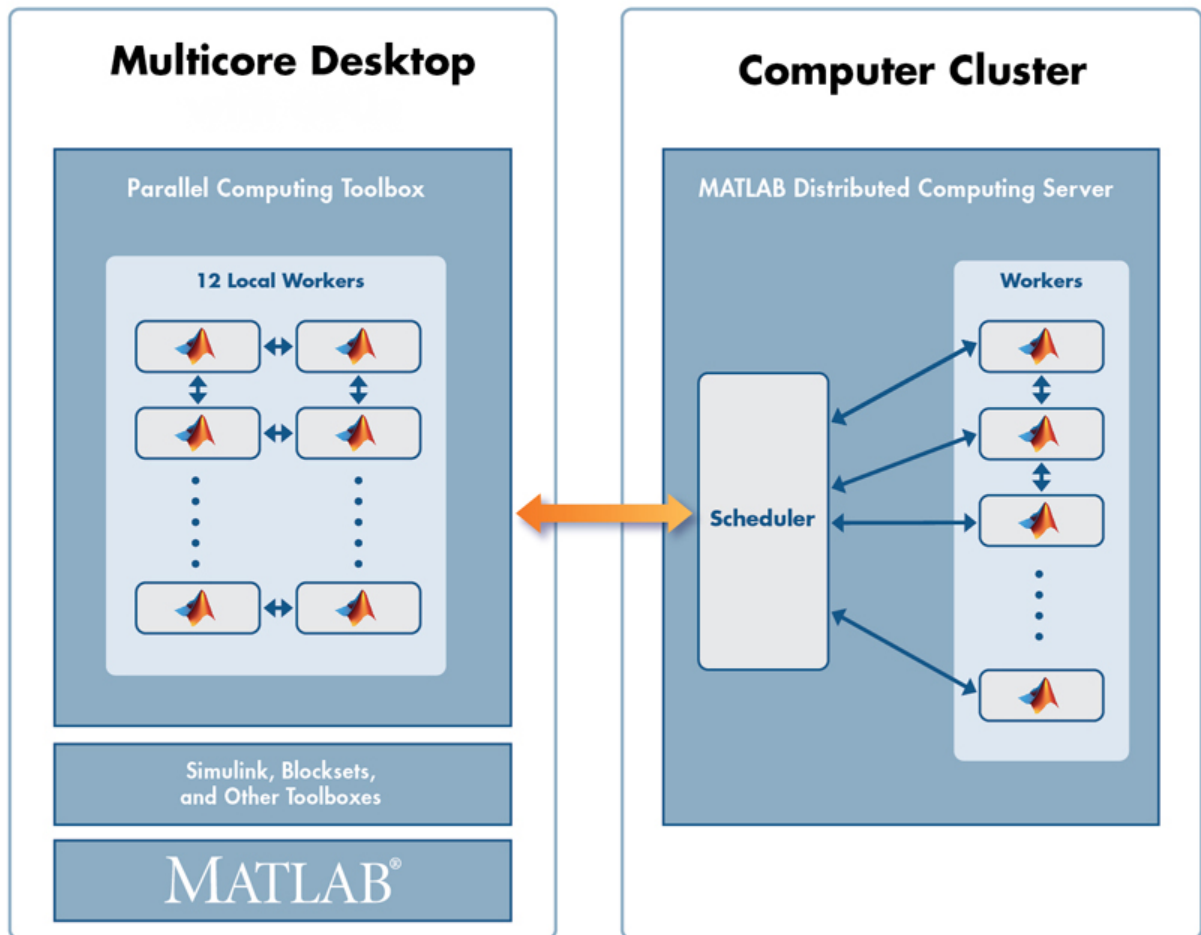

To take advantage of these environments, you can:

- 1 Simulate your model on a single computer.
- 2 When satisfied with single simulation, run multiple simulations in parallel on multiple designated workers on a local multicore desktop.
- 3 When satisfied with multiple simulations on local multicore desktop, run simulations in parallel remotely on computer clusters, clouds, and grids.

Consider the following:

Action	Required Software*			
	MATLAB	Simulink	Parallel Computing Toolbox	MATLAB Distributed Computing Server
Run a single simulation.	✓	✓		
Run multiple simulations simultaneously on your computer.	✓	✓	✓	
Run multiple simulations remotely on a server.	✓	✓	✓	✓

\* And other required and optional software

## Simulink and Parallel Computing Toolbox Software

Before you run simulations in the Parallel Computing Toolbox environment, see “Parallel Computing Toolbox”. You can use the Parallel Computing Toolbox software to run simulations on a local multicore computer or on multiple remote computers.

- 1 Have a Parallel Computing Toolbox license.
- 2 Run `sim` in `parfor` for your model.

For an example of using `sim` in `parfor` using Normal mode, see “`sim` in `parfor` with Normal Mode” on page 24-16.

For an example of using `sim` in `parfor` using Rapid Accelerator, see “`sim` in `parfor` with Rapid Accelerator Mode” on page 24-19.

---

**Note:** Code generation operations for the same model overwrite each other. If you want each worker to generate its own copy of code, attach and distribute the folder to each worker.

---

You can also use Parallel Computing Toolbox software to run simulations on multiple remote computers or in a nonhomogeneous environment. For these cases, you can use the Parallel Computing Toolbox software with the MATLAB Distributed Computing Server software.

## Simulink and MATLAB Distributed Computing Server Software

Before you run simulations in the MATLAB Distributed Computing Server environment, see “MATLAB Distributed Computing Server”.

- 1 Have Parallel Computing Toolbox and MATLAB Distributed Computing Server licenses.
- 2 Select and configure your cluster configuration.
- 3 Use the “Parallel Computing Toolbox” software to create, import, and select a default parallel cluster profile.
- 4 Use the Parallel Computing Toolbox software to run `sim` in `parfor` for your model.

For an example of `sim` in `parfor` with Normal mode using MATLAB Distributed Computing Server software, see “`sim` in `parfor` with Normal Mode and MATLAB Distributed Computing Server Software” on page 24-18.

You can also use `sim` in `parfor` with Rapid Accelerator and MATLAB Distributed Computing Server software (see “`sim` in `parfor` with Rapid Accelerator Mode” on page 24-19). In that example, you build the code once and distribute that generated code to the other local workers. You can adapt “`sim` in `parfor` with Rapid Accelerator Mode” on page 24-19 example for a remote cluster environment by:

- Calling `parpool` with a cluster name as input
- Attaching required files

For an example of how to adapt to a remote cluster environment, see “`sim` in `parfor` with Normal Mode and MATLAB Distributed Computing Server Software” on page 24-18.

### `sim` in `parfor` with Normal Mode

This code fragment shows how you can use `sim` and `parfor` in Normal mode. Save changes to your model before simulating in `parfor`. The saved copy of your model is distributed to parallel workers when simulating in `parfor`.

```
% 1) Load model and initialize the pool.  
model = 'sldemo_suspn_3dof';
```



```
load_system(model);
parpool;

% 2) Set up the iterations that we want to compute.
Cf = evalin('base', 'Cf');
Cf_sweep = Cf*(0.05:0.1:0.95);
iterations = length(Cf_sweep);
simout(iterations) = Simulink.SimulationOutput;

% 3) Need to switch all workers to a separate tempdir in case
% any code is generated for instance for StateFlow, or any other
% file artifacts are created by the model.
spmd
    % Setup tempdir and cd into it
    currDir = pwd;
    addpath(currDir);
    tmpDir = tempname;
    mkdir(tmpDir);
    cd(tmpDir);
    % Load the model on the worker
    load_system(model);
end

% 4) Loop over the number of iterations and perform the
% computation for different parameter values.
parfor idx=1:iterations
    set_param([model ' /Road-Suspension Interaction'], 'MaskValues', ...
        {'Kf', num2str(Cf_sweep(idx)), 'Kr', 'Cr'});
    simout(idx) = sim(model, 'SimulationMode', 'normal');
end

% 5) Switch all of the workers back to their original folder.
spmd
    cd(currDir);
    rmdir(tmpDir, 's');
    rmpath(currDir);
    close_system(model, 0);
end

close_system(model, 0);
delete(gcf('ncreate'));
```

## sim in parfor with Normal Mode and MATLAB Distributed Computing Server Software

This code fragment is identical to the one in “sim in parfor with Normal Mode” on page 24-16

. Modify it as follows for using `sim` and `parfor` in Normal mode:

- In item 1, modify the `parpool` command as follows to create an object and use it to call a cluster name.

```
p = parpool('clusterProfile');  
% 'clusterProfile' is the name of the distributed cluster
```

- In item 1, find files on which the model depends and attach those files to the model for distribution to cluster workers on remote machines.

```
files = dependencies.fileDependencyAnalysis(modelName);  
p.addAttachedFiles(files);
```

- If you do not have a MATLAB Distributed Computing Server cluster, use your local cluster. For more information, see “Discover Clusters and Use Cluster Profiles” (Parallel Computing Toolbox).

Start your cluster before running the code.

```
% 1) Load model and initialize the pool.  
model = 'sldemo_susp3dof';  
load_system(model);  
parpool;
```

```
% 2) Set up the iterations that we want to compute.  
Cf = evalin('base', 'Cf');  
Cf_sweep = Cf*(0.05:0.1:0.95);  
iterations = length(Cf_sweep);  
simout(iterations) = Simulink.SimulationOutput;
```

```
% 3) Need to switch all workers to a separate tempdir in case  
% any code is generated for instance for StateFlow, or any other  
% file artifacts are created by the model.  
spmd  
    % Setup tempdir and cd into it  
    addpath(pwd);  
    currDir = pwd;  
    addpath(currDir);
```

```

    tmpDir = tempname;
    mkdir(tmpDir);
    cd(tmpDir);
    % Load the model on the worker
    load_system(model);
end

% 4) Loop over the number of iterations and perform the
% computation for different parameter values.
parfor idx=1:iterations
    set_param([model '/Road-Suspension Interaction'],'MaskValues',...
        {'Kf',num2str(Cf_sweep(idx)),'Kr','Cr'});
    simout(idx) = sim(model, 'SimulationMode', 'normal');
end

% 5) Switch all of the workers back to their original folder.
spmd
    cd(currDir);
    rmdir(tmpDir,'s');
    rmpath(currDir);
    close_system(model, 0);
end

close_system(model, 0);
delete(gcp('nocreate'));

```

## sim in parfor with Rapid Accelerator Mode

Running Rapid Accelerator simulations in `parfor` combines speed with automatic distribution of a prebuilt executable to the `parfor` workers. As a result, this mode eliminates duplication of the update diagram phase.

To run parallel simulations in Rapid Accelerator simulation mode using the `sim` and `parfor` commands:

- Configure the model to run in Rapid Accelerator simulation mode.
- Save changes to your model before simulating in `parfor`. The saved copy of your model is distributed to parallel workers when simulating in `parfor`.
- Ensure that the Rapid Accelerator target is already built and up to date.
- Disable the Rapid Accelerator target up-to-date check by setting the `sim` command option `RapidAcceleratorUpToDateCheck` to `'off'`.

To satisfy the second condition, you can change parameters only between simulations that do not require a model rebuild. In other words, the structural checksum of the model must remain the same. Hence, you can change only tunable block diagram parameters and tunable run-time block parameters between simulations. For a discussion on tunable parameters that do not require a rebuild subsequent to their modifications, see “Determine If the Simulation Will Rebuild” on page 33-9.

To disable the Rapid Accelerator target up-to-date check, use the `sim` command, as shown in this sample.

```
parpool;
% Load the model and set parameters
model = 'vdp';
load_system(model);
% Build the Rapid Accelerator target
rtp = Simulink.BlockDiagram.buildRapidAcceleratorTarget(model);
% Run parallel simulations
parfor i=1:4
    simOut{i} = sim(model,'SimulationMode', 'rapid',...
        'RapidAcceleratorUpToDateCheck', 'off',...
        'SaveTime', 'on',...
        'StopTime', num2str(10*i));
    close_system(model, 0);
end

close_system(model, 0);
delete(gcp('nocreate'));
```

In this example, the call to the `buildRapidAcceleratorTarget` function generates code once. Subsequent calls to `sim` with the `RapidAcceleratorUpToDateCheck` option `off` guarantees that code is not regenerated. Data concurrency issues are thus resolved.

When you set `RapidAcceleratorUpToDateCheck` to `'off'`, changes that you make to block parameter values in the model (for example, by using block dialog boxes, by using the `set_param` function, or by changing the values of MATLAB variables) do not affect the simulation. Instead, use `RapidAcceleratorParameterSets` to pass new parameter values directly to the simulation.

## Workspace Access Issues

### Workspace Access for MATLAB worker sessions

By default, to run `sim` in `parfor`, a parallel pool opens automatically, enabling the code to run in parallel. Alternatively, you can also first open MATLAB workers using the `parpool` command. The `parfor` command then runs the code within the `parfor` loop in these MATLAB worker sessions. The MATLAB workers, however, do not have access to the workspace of the MATLAB client session where the model and its associated workspace variables have been loaded. Hence, if you load a model and define its associated workspace variables outside of and before a `parfor` loop, then neither is the model loaded, nor are the workspace variables defined in the MATLAB worker sessions where the `parfor` iterations are executed. This is typically the case when you define model parameters or external inputs in the base workspace of the client session. These scenarios constitute workspace access issues.

### Transparency Violation

When you run `sim` in `parfor` with `srcWorkspace` set to `current`, Simulink uses the `parfor` workspace, which is a transparent workspace. Simulink then displays an error for transparency violation. For more information on transparent workspaces, see “Ensure Transparency in `parfor`-Loops” (Parallel Computing Toolbox).

### Data Dictionary Access

When a model is linked to a data dictionary (see “What Is a Data Dictionary?” on page 61-2), to write code in `parfor` that accesses a variable or object that you store in the dictionary, you must use the functions `Simulink.data.dictionary.setupWorkerCache` and `Simulink.data.dictionary.cleanupWorkerCache` to prevent access issues. For an example, see “Sweep Variant Control Using Parallel Simulation” on page 24-23.

## Resolving Workspace Access Issues

When a Simulink model is loaded into memory in a MATLAB client session, it is only visible and accessible in that MATLAB session; it is not accessible in the memory of the MATLAB worker sessions. Similarly, the workspace variables associated with a model that are defined in a MATLAB client session (such as parameters and external inputs) are not automatically available in the worker sessions. You must therefore ensure that the model is loaded and that the workspace variables referenced in the model are defined in the MATLAB worker session by using the following two methods.

- In the `parfor` loop, use the `sim` command to load the model and to set parameters that change with each iteration. (Alternative: load the model and then use the `g(s)et_param` command(s) to set the parameters in the `parfor` loop)
- In the `parfor` loop, use the MATLAB `evalin` and `assignin` commands to assign data values to variables.

Alternatively, you can simplify the management of workspace variables by defining them in the model workspace. These variables will then be automatically loaded when the model is loaded into the worker sessions. There are, however, limitations to this method. For example, you cannot store parameter objects that use a storage class other than `Auto` in a model workspace. For a detailed discussion on the model workspace, see “Model Workspaces” on page 57-106.

### Specifying Parameter Values Using the `sim` Command

Use the `sim` command in the `parfor` loop to set parameters that change with each iteration.

```
%Specifying Parameter Values Using the sim Command
```

```
model = 'vdp';  
load_system(model)  
  
%Specifying parameter values.  
paramName = 'StopTime';  
paramValue = {'10', '20', '30', '40'};  
  
% Run parallel simulations  
parfor i=1:4  
    simOut{i} = sim(model, ...  
                   paramName, paramValue{i}, ...  
                   'SaveTime', 'on'); %#ok  
end  
  
close_system(model, 0);
```

An equivalent method is to load the model and then use the `set_param` command to set the `paramName` in the `parfor` loop.

### Specifying Variable Values Using the `assignin` Command

You can pass the values of model or simulation variables to the MATLAB workers by using the `assignin` or the `evalin` command. The following example illustrates how to

use this method to load variable values into the appropriate workspace of the MATLAB workers.

```
parfor i = 1:4
    assignin('base', 'extInp', paramValue{i})%#ok
    % 'extInp' is the name of the variable in the base
    % workspace which contains the External Input data
    simOut{i} = sim(model, 'ExternalInput', 'extInp'); %#ok
end
```

### Sweep Variant Control Using Parallel Simulation

To use parallel simulation to sweep a variant control (a `Simulink.Parameter` object whose value influences the variant condition of a `Simulink.Variant` object) that you store in a data dictionary, use this code as a template. Change the names and values of the model, data dictionary, and variant control to match your application.

To sweep block parameter values or the values of workspace variables that you use to set block parameters, use `Simulink.SimulationInput` objects instead of the programmatic interface to the data dictionary. See “Optimize, Estimate, and Sweep Block Parameter Values” on page 35-50.

You must have a Parallel Computing Toolbox license to perform parallel simulation.

```
% For convenience, define names of model and data dictionary
model = 'mySweepMdl';
dd = 'mySweepDD.slidd';

% Define the sweeping values for the variant control
CtrlValues = [1 2 3 4];

% Grant each worker in the parallel pool an independent data dictionary
% so they can use the data without interference
spmd
    Simulink.data.dictionary.setupWorkerCache
end

% Determine the number of times to simulate
numberOfSims = length(CtrlValues);

% Prepare a nondistributed array to contain simulation output
simOut = cell(1,numberOfSims);

parfor index = 1:numberOfSims
```

```
% Create objects to interact with dictionary data
% You must create these objects for every iteration of the parfor-loop
dictObj = Simulink.data.dictionary.open(dd);
sectObj = getSection(dictObj, 'Design Data');
entryObj = getEntry(sectObj, 'MODE');
% Suppose MODE is a Simulink.Parameter object stored in the data dictionary

% Modify the value of MODE
temp = getValue(entryObj);
temp.Value = CtrlValues(index);
setValue(entryObj, temp);

% Simulate and store simulation output in the nondistributed array
simOut{index} = sim(model);

% Each worker must discard all changes to the data dictionary and
% close the dictionary when finished with an iteration of the parfor-loop
discardChanges(dictObj);
close(dictObj);
end

% Restore default settings that were changed by the function
% Simulink.data.dictionary.setupWorkerCache
% Prior to calling cleanupWorkerCache, close the model

spmd
    bdclose(model)
    Simulink.data.dictionary.cleanupWorkerCache
end
```

---

**Note:** If data dictionaries are open, you cannot use the command `Simulink.data.dictionary.cleanupWorkerCache`. To identify open data dictionaries, use `Simulink.data.dictionary.getOpenDictionaryPaths`.

---

## Data Concurrency Issues

Data concurrency issues refer to scenarios for which software makes simultaneous attempts to access the same file for data input or output. In Simulink, they primarily occur as a result of the nonsequential nature of the `parfor` loop during simultaneous execution of Simulink models. The most common incidences arise when code is generated or updated for a simulation target of a Stateflow, Model block or MATLAB Function



block during parallel computing. The cause, in this case, is that Simulink tries to concurrently access target data from multiple worker sessions. Similarly, To File blocks may simultaneously attempt to log data to the same files during parallel simulations and thus cause I/O errors. Or a third-party blockset or user-written S-function may cause a data concurrency issue while simultaneously generating code or files.

A secondary cause of data concurrency is due to the unprotected access of network ports. This type of error occurs, for example, when a Simulink product provides blocks that communicate via TCP/IP with other applications during simulation. One such product is the HDL Verifier™ for use with the Mentor Graphics® ModelSim® HDL simulator.

## Resolving Data Concurrency Issues

The core requirement of `parfor` is the independence of the different iterations of the `parfor` body. This restriction is not compatible with the core requirement of simulation via incremental code generation, for which the simulation target from a prior simulation is reused or updated for the current simulation. Hence during the parallel simulation of a model that involves code generation (such as Accelerator mode simulation), Simulink makes concurrent attempts to access (update) the simulation target. However, you can avoid such data concurrency issues by creating a temporary folder within the `parfor` loop and then adding several lines of MATLAB code to the loop to perform the following steps:

- 1 Change the current folder to the temporary, writable folder.
- 2 In the temporary folder, load the model, set parameters and input vectors, and simulate the model.
- 3 Return to the original, current folder.
- 4 Remove the temporary folder and temporary path.

In this manner, you avoid concurrency issues by loading and simulating the model within a separate temporary folder. Following are examples that use this method to resolve common concurrency issues.

### **A Model with Stateflow, MATLAB Function Block, or Model Block**

In this example, either the model is configured to simulate in Accelerator mode or it contains a Stateflow, a MATLAB Function block, or a Model block (for example, `sf_bounce`, `sldemo_autotrans`, or `sldemo mdlref_basic`). For these cases, Simulink generates code during the initialization phase of simulation. Simulating such a model in `parfor` would cause code to be generated to the same files, while the

initialization phase is running on the worker sessions. As illustrated below, you can avoid such data concurrency issues by running each iteration of the `parfor` body in a different temporary folder.

```
parfor i=1:4
    cwd = pwd;
    addpath(cwd)
    tmpdir = tempname;
    mkdir(tmpdir)
    cd(tmpdir)
    load_system(model)
    % set the block parameters, e.g., filename of To File block
    set_param(someBlkInMdl, blkParamName, blkParamValue{i})
    % set the model parameters by passing them to the sim command
    out{i} = sim(model, mdlParamName, mdlParamValue{i});
    close_system(model,0);
    cd(cwd)
    rmdir(tmpdir,'s')
    rmpath(cwd)
end
```

Note the following:

- You can also avoid other concurrency issues due to file I/O errors by using a temporary folder for each iteration of the `parfor` body.
- On Windows platforms, consider inserting the `evalin('base', 'clear mex');` command before `rmdir(tmpdir, 's')`. This sequence closes MEX-files first before calling `rmdir` to remove `tmpdir`.

```
evalin('base', 'clear mex');
rmdir(tmpdir, 's')
```

### A Model with To File Blocks

If you simulate a model with To File blocks from inside of a `parfor` loop, the nonsequential nature of the loop may cause file I/O errors. To avoid such errors during parallel simulations, you can either use the temporary folder idea above or use the `sim` command in Rapid Accelerator mode with the option to append a suffix to the file names specified in the model To File blocks. By providing a unique suffix for each iteration of the `parfor` body, you can avoid the concurrency issue.

```
rtp = Simulink.BlockDiagram.buildRapidAcceleratorTarget(model);
parfor idx=1:4
```

```
sim(model, ...  
    'ConcurrencyResolvingToFileSuffix', num2str(idx),...  
    'SimulationMode', 'rapid',...  
    'RapidAcceleratorUpToDateCheck', 'off');  
end
```

## Related Examples

- “Optimize, Estimate, and Sweep Block Parameter Values” on page 35-50
- “Sweep Variant Control Using Parallel Simulation” on page 24-23

## Error Handling in Simulink Using MSLException

### Error Reporting in a Simulink Application

Simulink allows you to report an error by throwing an exception using the `MSLException` object, which is a subclass of the MATLAB `MException` class. As with the MATLAB `MException` object, you can use a `try-catch` block with a `MSLException` object construct to capture information about the error. The primary distinction between the `MSLException` and the `MException` objects is that the `MSLException` object has the additional property of `handles`. These handles allow you to identify the object associated with the error.

### The MSLException Class

The `MSLException` class has five properties: `identifier`, `message`, `stack`, `cause`, and `handles`. The first four of these properties are identical to those of `MException`. For detailed information about them, see “Properties of the `MException` Class” (MATLAB). The fifth property, `handles`, is a cell array with elements that are double array. These elements contain the handles to the Simulink objects (blocks or block diagrams) associated with the error.

### Methods of the MSLException Class

The methods for the `MSLException` class are identical to those of the `MException` class. For details of these methods, see `MException`.

### Capturing Information about the Error

The structure of the Simulink `try-catch` block for capturing an exception is:

```
try
    Perform one or more operations
catch E
    if isa(E, 'MSLException')
    ...
end
```

If an operation within the `try` statement causes an error, the `catch` statement catches the exception (*E*). Next, an `if isa` conditional statement tests to determine if the

exception is Simulink specific, i.e., an `MSLEException`. In other words, an `MSLEException` is a type of `MException`.

The following code example shows how to get the handles associated with an error.

```
errHndls = [];
try
    sim('modelName', ParamStruct);
catch e
    if isa(e, 'MSLEException')
        errHndls = e.handles{1}
    end
end
```

You can see the results by examining `e`. They will be similar to the following output:

```
e =
MSLEException

Properties:
    handles: {[7.0010]}
    identifier: 'Simulink:Parameters:BlkParamUndefined'
    message: [1x87 char]
    cause: {0x1 cell}
    stack: [0x1 struct]

Methods, Superclasses
```

To identify the name of the block that threw the error, use the `getfullname` command. For the present example, enter the following command at the MATLAB command line:

```
getfullname(errHndls)
```

If a block named `Mu` threw an error from a model named `vdp`, MATLAB would respond to the `getfullname` command with:

```
ans =
vdp/Mu
```

## Related Examples

- “Run Simulations Programmatically” on page 24-2
- “Run Multiple Simulations” on page 25-2



# Multiple Simulations

---

- “Run Multiple Simulations” on page 25-2
- “Example of Parallel Simulations Workflow” on page 25-5

## Run Multiple Simulations

### Overview

For workflows that involve multiple parallel simulations and logging of large amounts of data, you can create simulation sets by using an array of `SimulationInput` objects. This is useful in situations such as model testing, design of experiments, Monte Carlo analysis, and model optimization.

Use of arrays of `SimulationInput` objects simplify running multiple simulations and running them in parallel. With the Parallel Computing Toolbox license, you can use the `parsim` command to run the simulations in parallel. The `parsim` command distributes each simulation to your workers to decrease your overall simulation time. The `parsim` command runs simulations in parallel. The `parsim` command automates the creation of a parallel pool, identifying file dependencies and managing build artifacts for Accelerator and Rapid Accelerator simulations.

In the absence of the Parallel Computing Toolbox license, the `parsim` command behaves like the `sim` command. The simulations will run in serial.

You can make changes to your model using the `SimulationInput` object and run multiple simulations with those changes. When you make changes to the `SimulationInput` object, it overrides the values in the model. The simulation uses the values in the `SimulationInput` object rather than the values defined in the model. This way, you can change the model without dirtying it. The `SimulationInput` object allows you to change these settings in your model:

- Initial state
- External inputs
- Model parameters
- Block parameters
- Variables

Through the `Simulink.SimulationInput` object, you can also specify MATLAB functions to run at the start and the end of each simulation by using `in.PreSimFcn` and `in.PostSimFcn` respectively.

When you use `SimulationInput` objects, the model's parameters get restored after the simulation ends.



**Note:** When the parallel pool is not already open and simulations are run for the first time, they take an additional time to start. Subsequent parallel simulations are faster.

---

## Other Advantages

- Outputs errors in the simulation output object for easier debugging
- Compatible with Rapid Accelerator and Fast Restart
- Compatible with file logging (to facilitate big data)
- Compatible with MATLAB Distributed Computing Server in addition to local parallel pools
- Capable of transferring base workspace variables to workers
- Avoids transparency errors

## Data Logging For Multiple Simulations

The resulting `Simulink.SimulationOutput` object, which contains the simulation outputs, captures error messages and the simulation metadata. When you select the **Log Dataset data to file** configuration parameter, Simulink creates a `Simulink.SimulationData.DatasetRef` object for each `Dataset` stored in the resulting MAT file. You can use the `DatasetRef` object to access the data for a `Dataset` element. For simulations which are run using the `SimulationInput` objects, the `DatasetRef` object will be returned as part of the `SimulationOutput` object. This provides quicker access and avoids the need for you to create these objects.

Parallel simulations can produce more logged data than MATLAB memory can hold. Consider logging to persistent storage for parallel simulations to reduce the memory requirement. When you select the **Data Import/Export > Log Dataset data to file** configuration parameter (`LoggingToFile`), for parallel simulations Simulink:

- Stores data logged in Dataset format in a MAT-file
- Creates a `Simulink.SimulationData.DatasetRef` object for each `Dataset` element (for example, `logout`) for each simulation

You can use `DatasetRef` objects to access data for a specific signal. You can create `matlab.io.datasetore.SimulationDatastore` objects to use for streaming logged data from persistent storage into a model.

## See Also

`in.applyToModel` | `in.ExternalInput` | `in.InitialState` | `in.PostSimFcn`  
| `in.PreSimFcn` | `in.setBlockParameter` | `in.setModelParameter` |  
`in.setVariable` | `in.validate` | `parsim` | `Simulink.SimulationInput`

## More About

- “Working with Big Data for Simulations” on page 59-46
- “Log Data to Persistent Storage” on page 59-49
- “Load Big Data for Simulations” on page 59-54
- “Analyze Big Data from a Simulation” on page 59-62

## Example of Parallel Simulations Workflow

This example shows how to use a `SimulationInput` object to change block and model parameters and run simulations in parallel with those changes.

The example model `sldemo_househeat` is a system that models the thermal characteristics of the house, the outdoor environment and the house heating system.

This model uses a `Constant` block to specify a temperature setpoint that must be maintained indoors. The default value of setpoint value is 70 degrees Farenhite. Simulate the model in parallel using different values of `Set Point`.

Open the example model.

```
open_system('sldemo_househeat');
```

Define a set of values for “Set Point”.

```
SetPointValues = 65:2:85;
```

Create an array of `SimulationInput` objects. Use these `SimulationInput` objects to specify the values to “Set Point”.

```
for i = 1:length(SetPointValues)
in(i) = Simulink.SimulationInput('sldemo_househeat');
in(i) = in(i).setBlockParameter('sldemo_househeat/Set Point','Value',num2str(SetPointValues(i)));
end
```

This example produces an array of 10 `SimulationInput` objects, each corresponding to a different value of `Set Point`.

Model parameters such as `Stop` and `Start Time` can also be changed using the `setModelParameters` method on `SimulationInput` object.

Now, run these multiple simulations in parallel using the command `parsim`. The argument `ShowProgress` when set to `true` shows the progress of the simulations.

```
out = parsim(in,'ShowProgress','true')
```

The output is generated as a `Simulink.SimulationOutput` object.

In the absence of the Parallel Computing Toolbox licenses, the `parsim` command behaves like the `sim` command. The simulations will run in serial.

### See Also

`in.applyToModel` | `in.ExternalInput` | `in.InitialState` |  
`in.setBlockParameter` | `in.setModelParameter` | `in.setVariable` |  
`in.validate` | `parsim` | `Simulink.SimulationInput`

# Visualizing and Comparing Simulation Results

---

- “Prototype and Debug Models with Scopes” on page 26-2
- “Scope Blocks and Scope Viewer Overview” on page 26-8
- “Debugging a Model with Scope Blocks” on page 26-14
- “Scope Trace Selection Panel” on page 26-15
- “Scope Triggers Panel” on page 26-16
- “Scope Cursor Measurements Panel” on page 26-30
- “Scope Signal Statistics Panel” on page 26-33
- “Scope Bilevel Measurements Panel” on page 26-35
- “Scope Peak Finder Panel” on page 26-49
- “Scope Tasks” on page 26-54
- “Floating Scope and Scope Viewer Tasks” on page 26-69
- “Signal Generator Tasks” on page 26-75
- “Signal and Scope Manager” on page 26-77
- “Signal Selector” on page 26-81
- “Control Scopes Programmatically” on page 26-85

## Prototype and Debug Models with Scopes

Simulink Scope blocks and Scope viewers offer a quick and lightweight way to visualize your simulation data over time. If you are prototyping a model design, you can attach signals to a Scope block. After simulating the model, you can use the results to validate your design. See “Scope Blocks and Scope Viewer Overview” on page 26-8 and “Integrate a House Heating Model”.

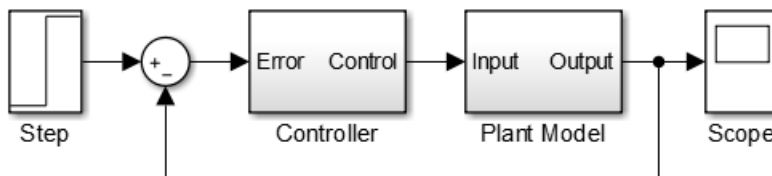

A Scope block or Scope viewer opens to a Scope window where you can display and evaluate simulation data.

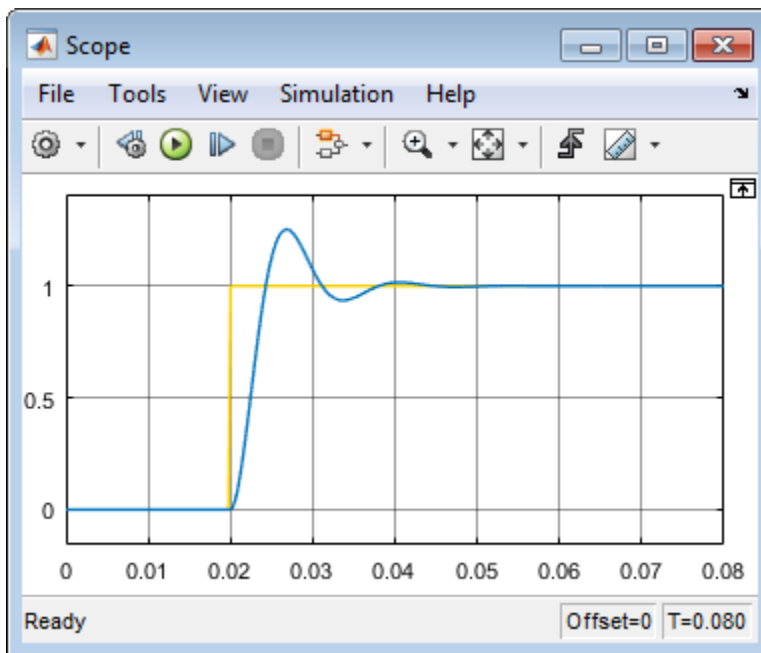

The toolbar contains controls for starting, stopping, and stepping forward through a simulation . You can use these controls to debug a model by viewing signal data at each time interval. See “How Stepping Through a Simulation Works” on page 2-3.

Connect signal lines to a Scope block using multiple input ports. See “Number of input ports” in Scope block reference.

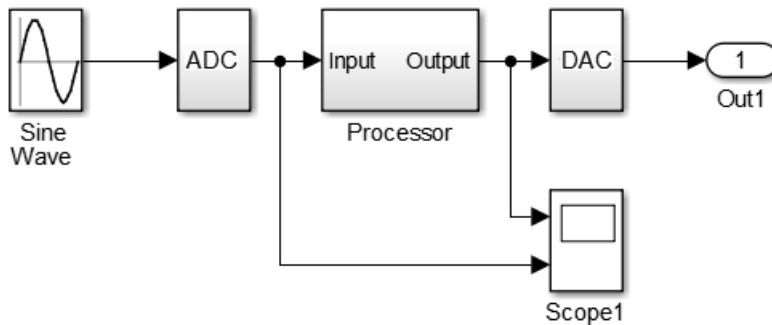

Attach signals to a Floating Scope block or signal viewer using a signal selector tool that hierarchically displays all signals in a model. See “Signal Selector” on page 26-81.

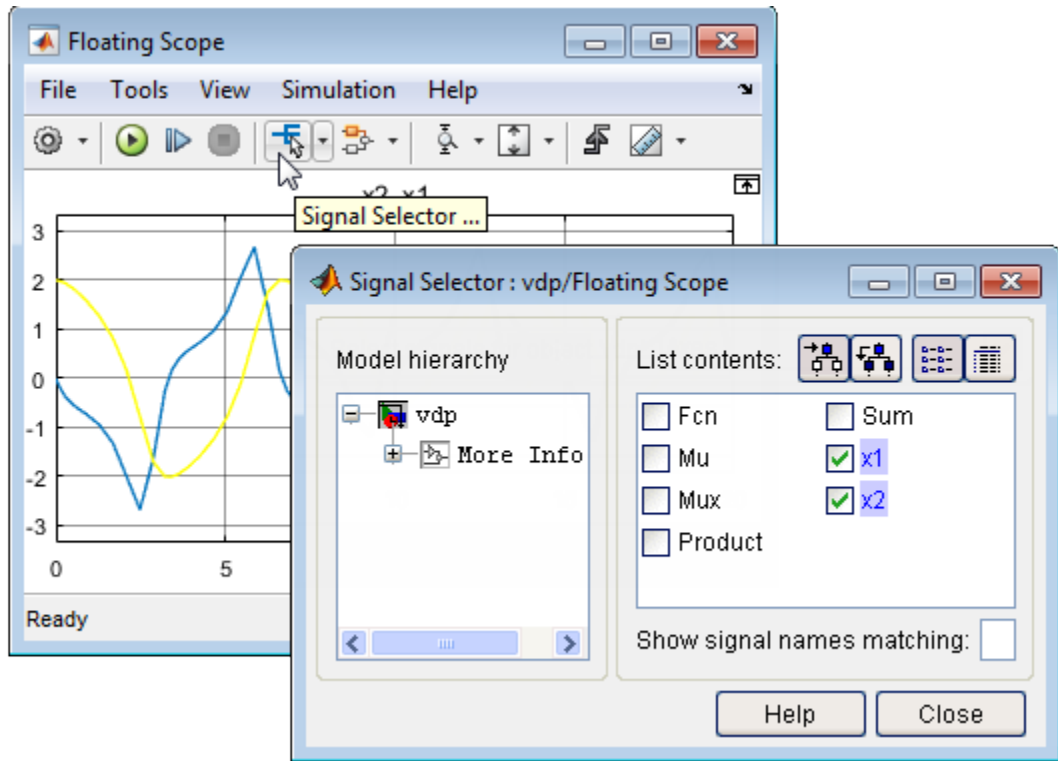

Use the oscilloscope-like tools available with a scope to debug your model. Set triggers to capture events, use interactive cursors to measure signal values at various points, and review signal statistics such as maximum and mean values. See “Scope Triggers Panel” on page 26-16 and “Scope Cursor Measurements Panel” on page 26-30.



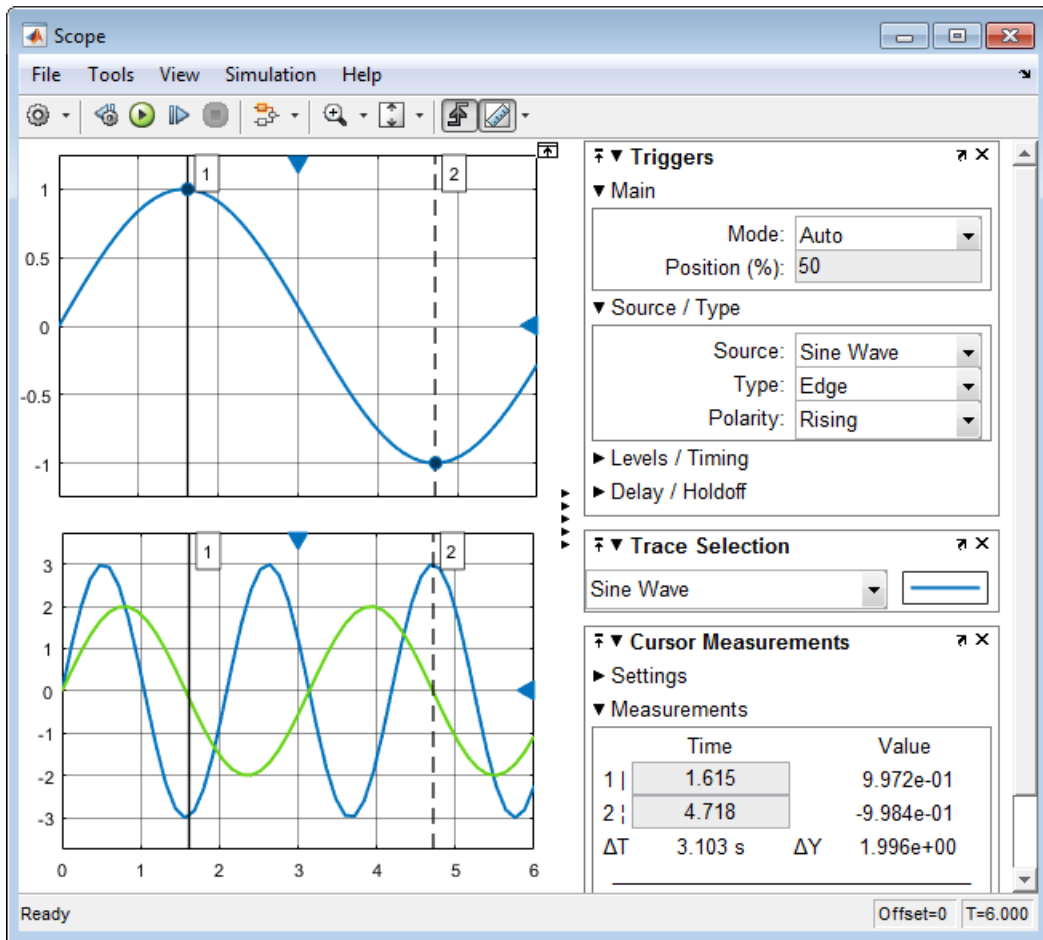

Save or log signal data to the MATLAB workspace, and then plot data in a MATLAB figure window. Use MATLAB functions or your own scripts to analyze the data. See “Save Simulation Data Using Floating Scope Block” on page 26-71.

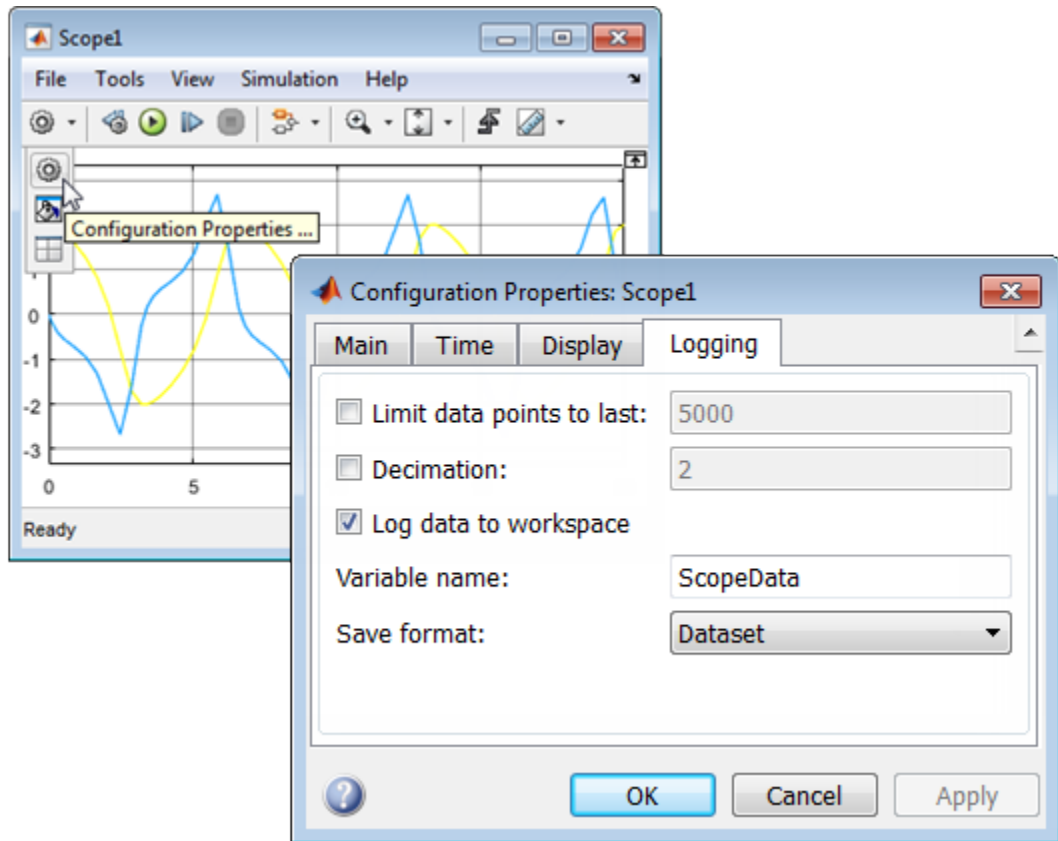

## See Also

Floating Scope | Scope | Scope Viewer

## Related Examples

- “Scope Tasks” on page 26-54
- “Floating Scope and Scope Viewer Tasks” on page 26-69
- “Scope Triggers Panel” on page 26-16
- “Scope Cursor Measurements Panel” on page 26-30
- “Control Scopes Programmatically” on page 26-85

## **More About**

- “Scope Blocks and Scope Viewer Overview” on page 26-8
- “Signal and Scope Manager” on page 26-77
- “Signal Selector” on page 26-81

## Scope Blocks and Scope Viewer Overview

### In this section...

“Overview of Methods” on page 26-8

“Simulink Scope Versus Floating Scope” on page 26-9

“Simulink Scope Versus DSP System Toolbox Time Scope” on page 26-11

### Overview of Methods

Simulink scopes provide several methods for displaying simulation data and capturing the data for later analysis. Symbols on your block diagram represent the various data display and data capture methods.

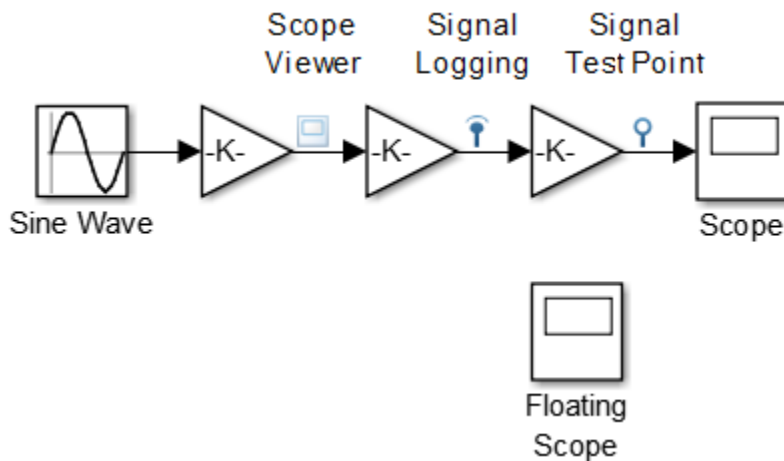

For more information about these methods:

- Scope and Floating Scope blocks — Scope, Floating Scope, “Scope Tasks” on page 26-54, “Floating Scope and Scope Viewer Tasks” on page 26-69.
- Scope Viewer — “Signal and Scope Manager” on page 26-77, “Floating Scope and Scope Viewer Tasks” on page 26-69.
- Signal Logging — “Save Simulation Data Using Floating Scope Block” on page 26-71.
- Signal Test Point — “Test Points” on page 62-56.

## Simulink Scope Versus Floating Scope

Scope blocks and Floating Scope blocks both display simulation results, but they differ in how you attach signals and save data. Simulation behavior for a Floating Scope and a Scope Viewer is identical, but you manage them differently in your model.

Capability	Simulink Scope	Simulink Floating Scope	Simulink Scope Viewer
Attaching signals	Connect signal lines to a Scope block using input ports.	Attach signals using the Signal Selector. See “Signal Selector” on page 26-81.  Attach signals interactively from the model before and during a simulation. See “View Signals on a Floating Scope Quickly” on page 26-73.	Attach signals using the Signal Selector or signal line context menu.
Access to signals	Because signals lines are connected to a Scope block, access signals at different levels of a model hierarchy using GoTo blocks.	Because signals are attached without signal lines, you do not have to route lines to a Floating Scope block.  You can access most signals inside the model hierarchy, including referenced models and Stateflow charts. You cannot access optimized signals.	Scope viewers are attached to signal lines.
Data logging	Save data to a MATLAB variable as	Save data to a MATLAB variable as an object.	

Capability	Simulink Scope	Simulink Floating Scope	Simulink Scope Viewer
	an array, structure, or object.		
Simulation control	Run, forward, and back toolbar buttons.	Run and forward toolbar buttons.  A Floating Scope window does not have a toolbar Back button. If you use the Back button from your model, stepping back appears to work due to the data buffer, but it does not work in all cases.	Run, forward, and back toolbar buttons.
Scale axes after simulation	Toolbar buttons to Scale X-axis and Y-axis limits  <b>Axes scaling</b> set to Auto for the X-axis and Y-axis.	Toolbar button to scale only the Y-axis limits, and  <b>Axes scaling</b> set to Auto for only the Y-axis.	Toolbar buttons to Scale X-axis and Y-axis limits  <b>Axes scaling</b> set to Auto for the X-axis and Y-axis.
Add to model	Add block from Simulink sinks library.	Add block from Simulink sinks library.	Add using Signal & Scope Manager. See “Signal and Scope Manager” on page 26-77.
Visual indication in model		Floating Scope block not attached to any signal lines.	Viewer icons located above signal lines for all attached signals.
Manage scopes centrally	No.	No.	Use the Signal & Scope Manager to add or delete viewers, and attach or remove signals.

Capability	Simulink Scope	Simulink Floating Scope	Simulink Scope Viewer
Manage scopes locally	Attach signal lines to Scope block in ports.	Attach signals from the Floating Scope window.	Add viewers and attach additional signals within a model hierarchy using the context menus.
Simulink Report Generator support	Yes.	Yes.	No.
Connecting Constant block with <b>Sample time</b> set to <code>inf</code> (constant sample time)		Plots all data values.	Plots the data value at the first time step and anytime you tune a parameter.

## Simulink Scope Versus DSP System Toolbox Time Scope

If you have Simulink and a DSP System Toolbox license, you can use either the Simulink Scope or DSP System Toolbox Time Scope. Choose the scope based on your application requirements, how the blocks work, and the default values of each block.

If you have a DSP System Toolbox license and you have been using Time Scopes, continue to do so in your applications. Using the Time Scope block requires a DSP System Toolbox license.

Feature	Scope	Time Scope
Location in block library	Simulink Sinks library	DSP System Toolbox Sinks library
Trigger and measurement panels	With Simulink only: <ul style="list-style-type: none"> <li>• Trigger</li> <li>• Cursor Measurement</li> </ul> With DSP System Toolbox or Simscape license: <ul style="list-style-type: none"> <li>• Signal Statistics</li> </ul>	<ul style="list-style-type: none"> <li>• Trigger</li> <li>• Cursor Measurements</li> <li>• Signal Statistics</li> <li>• Bilevel Measurements</li> <li>• Peak Finder</li> </ul>

Feature	Scope	Time Scope
	<ul style="list-style-type: none"> <li>• Bilevel Measurements</li> <li>• Peak Finder</li> </ul>	
<p>Simulation mode support for block-based sample times</p> <p>For block-based sample times, all the inputs of the block run at the same rate.</p>	<ul style="list-style-type: none"> <li>• Normal</li> <li>• Accelerator</li> <li>• Rapid-Accelerator</li> <li>• External</li> </ul>	<ul style="list-style-type: none"> <li>• Rapid-Accelerator</li> <li>• External</li> </ul>
<p>Simulation mode support for port-based sample times</p> <p>For port-based sample times, the input ports can run at different rates.</p>	No.	<ul style="list-style-type: none"> <li>• Normal</li> <li>• Accelerator</li> </ul>
Frame processing of signals	Included in Scope block with DSP System Toolbox license.	Included in Time Scope block.
Sample time propagation	If the different ports have different sample rates, the scope uses the greatest common divisor of the rates.	When using port-based sample times, the different ports of the Scope block inherit the different rates and plots the signals according to those rates.
Save model to previous Simulink release	If saving to a release before R2015a, the Scope block is converted to a scope with the features available in that release.	No change in features.

This table lists the differences in Configuration Property default values between the Scope and Time Scope blocks.

Property	Scope	Time Scope
Open at start of simulation	Cleared	Selected



Property	Scope	Time Scope
Input processing	Elements as channels (sample based)	Columns as channels (frame based)
Maximize Axes	Off	Auto
Time Units	None	Metric (based on Time Span)
Time-axis labels	Bottom displays only	All
Show time-axis label	Cleared	Selected
Plot Type	Auto	Line
Title	%<Signal Label>	No title
Y label	No label	Amplitude

## See Also

Floating Scope | Scope | Scope Viewer

## Related Examples

- “Scope Tasks” on page 26-54
- “Floating Scope and Scope Viewer Tasks” on page 26-69

## Debugging a Model with Scope Blocks

There are different types of triggering techniques available in with a Scope block. You can choose one over the other depending on your application. Some of the important triggering techniques available in with a Scope include:

- **Edge Trigger:** Use edge triggering to stabilize a repetitive waveform and search for a occurrence of a particular pattern in the signal. Using the edge triggering technique, one can stabilize a repetitive signal based on occurrence of edge in a signal and then measure important attributes of a signal like Rise Time, Fall Time, Peak to peak voltage, RMS voltage etc.
- **Pulse width triggering:** Using this technique, you can set the Scope to trigger, for example, on the occurrence of a glitch – a pulse which is faster / slower than the reference pulse. This ability can help one investigate the properties of the glitch and do some investigation on the root cause of the glitch
- **Runt triggering:** Using the Runt Triggering, one can set the Scope to trigger for pulses whose amplitude crosses one of the two voltage threshold but not both and whose pulse width lies in a specific predefined time range. This is very useful in debugging the Runt Signals frequently encountered in troubleshooting Digital integrated Circuits.

Runt signals are the signals which typically cross a voltage threshold level but fail to cross a second threshold before re-crossing the first threshold level. Runt signals are frequently encountered in digital circuits.

To look for Runt signals, enable the Trigger, set the Trigger Mode to Normal, set the trigger type as Runt, adjust the voltage threshold and then view if the Scope detects and displays the presence of any runt signals in the incoming data stream.

### See Also

Floating Scope | Scope | Scope Viewer

### Related Examples

- “Scope Tasks” on page 26-54
- “Floating Scope and Scope Viewer Tasks” on page 26-69

## Scope Trace Selection Panel

Select signals for a measurement panel. To open the Trace Selection panel:

- From the menu, select **Tools > Measurements > Trace Selection**.
- Open a measurement panel.

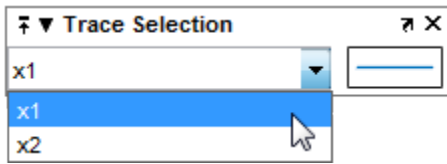

### See Also

Floating Scope | Scope

### Related Examples

- “Scope Triggers Panel” on page 26-16

## Scope Triggers Panel

### In this section...

“What Is the Trigger Panel” on page 26-16

“Main Pane” on page 26-17

“Source/Type and Levels/Timing Panes” on page 26-17

“Hysteresis of Trigger Signals” on page 26-27

“Delay/Holdoff Pane” on page 26-28

### What Is the Trigger Panel

The Trigger panel defines a trigger event to synchronize simulation time with input signals. You can use trigger events to stabilize periodic signals such as a sine wave or capture non-periodic signals such as a pulse that occurs intermittently.

To open the Trigger panel:

- 1 Open a Scope block window.
- 2 On the toolbar, click the Triggers button .
- 3 Run a simulation.

Triangle trigger pointers indicate the trigger time ▼ and trigger level ◀ of an event. The marker color corresponds to the color of the source signal.

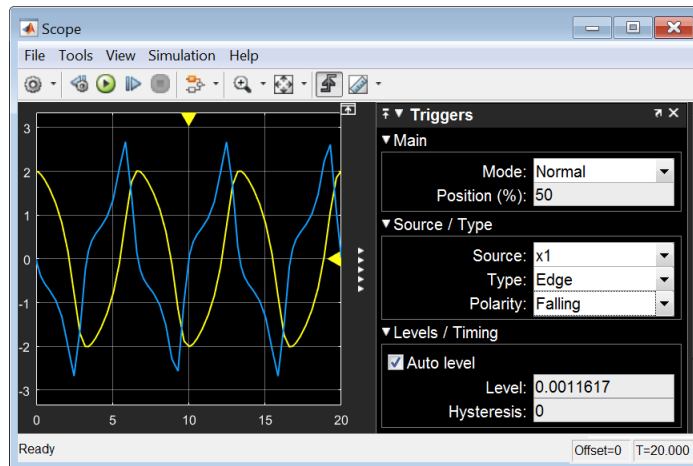

## Main Pane

**Mode** — Specify when the display updates.

- **Auto** — Display data from the last trigger event. If no event occurs after one time span, display the last available data.
- **Normal** — Display data from the last trigger event. If no event occurs, the display remains blank.
- **Once** — Display data from the last trigger event and freeze the display. If no event occurs, the display remains blank. Click the **Rearm** button to look for the next trigger event.
- **Off** — Disable triggering.

**Position (%)** — Specify the position of the time pointer along the y-axis. You can also drag the time pointer to the left or right to adjust its position.

## Source/Type and Levels/Timing Panes

**Source** — Select a trigger signal. For magnitude and phase plots, select either the magnitude or the phase.

**Type** — Select the type of trigger.

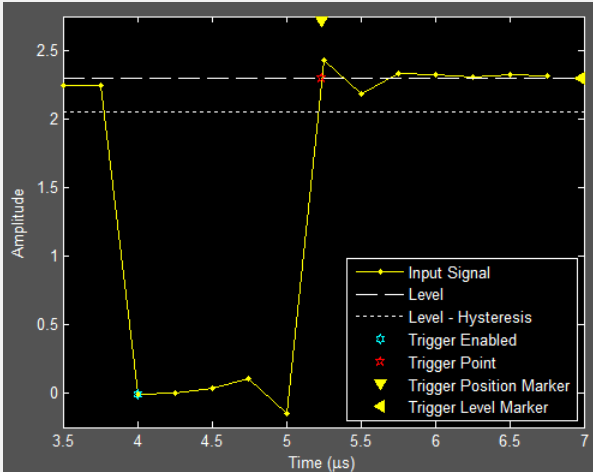
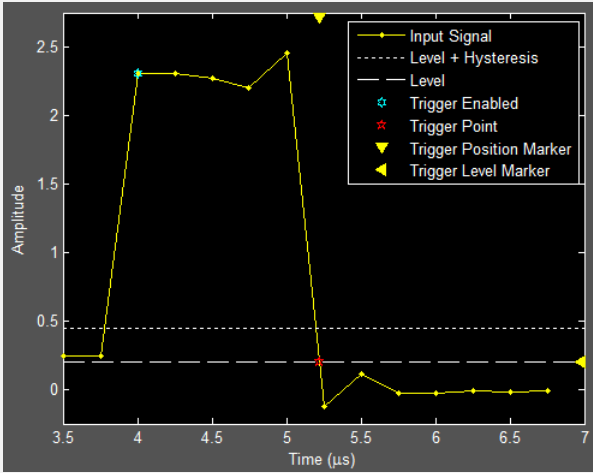
Trigger Type	Trigger Parameters
<p>Edge — Trigger when the signal crosses a threshold.</p>	<p><b>Polarity</b> — Select the polarity for an edge-triggered signal.</p> <ul style="list-style-type: none"> <li>• <b>Rising</b> — Trigger when the signal is increasing.</li> </ul>  <ul style="list-style-type: none"> <li>• <b>Falling</b> — Trigger when the signal value is decreasing.</li> </ul>  <ul style="list-style-type: none"> <li>• <b>Either</b> — Trigger when the signal is increasing or decreasing.</li> </ul>

Trigger Type	Trigger Parameters
	<p data-bbox="541 303 1302 361"><b>Level</b> — Enter a threshold value for an edge triggered signal. <b>Auto level</b> is 50%</p> <p data-bbox="541 390 1302 453"><b>Hysteresis</b> — Enter a value for an edge-triggered signal. See “Hysteresis of Trigger Signals” on page 26-27</p>

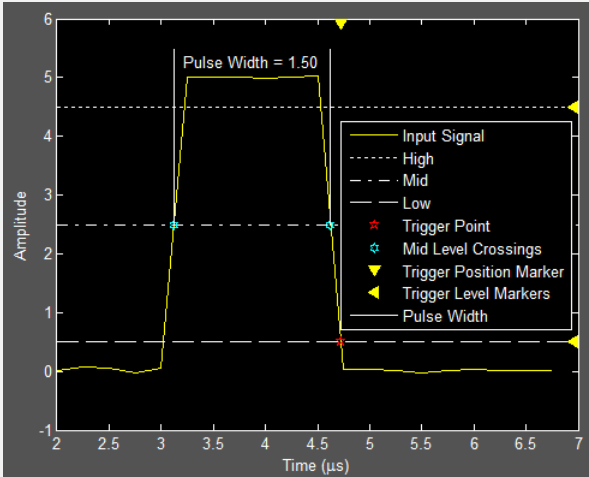
Trigger Type	Trigger Parameters
<p><b>Pulse Width</b> — Trigger when the signal crosses a low threshold and a high threshold twice within a specified time.</p>	<p><b>Polarity</b> — Select the polarity for a pulse width-triggered signal.</p> <ul style="list-style-type: none"> <li>• <b>Positive</b> — Trigger on a positive-polarity pulse when the pulse crosses the low threshold for a second time.</li> </ul>  <ul style="list-style-type: none"> <li>• <b>Negative</b> — Trigger on a negative-polarity pulse when the pulse crosses the high threshold for a second time.</li> <li>• <b>Either</b> — Trigger on both positive-polarity and negative-polarity pulses.</li> </ul>
	<p><b>Note:</b> A glitch-trigger is a special type of a pulse width-trigger. A glitch-Trigger occurs for a pulse or spike whose duration is less than a specified amount. You can implement a glitch trigger by using a pulse width-trigger and setting the <b>Max Width</b> parameter to a small value.</p> <p><b>High</b> — Enter a high value for a pulse width-triggered signal. <b>Auto level</b> is 90%.</p>

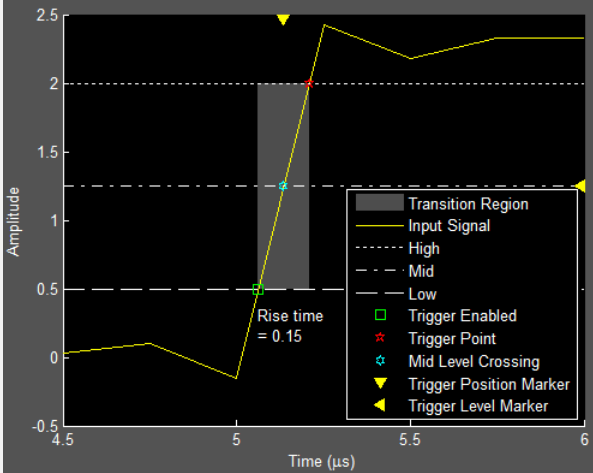

Trigger Type	Trigger Parameters
	<p data-bbox="541 298 1288 357"><b>Low</b> — Enter a low value for a pulse width-triggered signal. <b>Auto level</b> is 10%.</p> <p data-bbox="541 388 1288 482"><b>Min Width</b> — Enter the minimum pulse-width for a pulse width triggered signal. Pulse width is measured between the first and second crossings of the middle threshold.</p> <p data-bbox="541 513 1288 572"><b>Max Width</b> — Enter the maximum pulse width for a pulse width triggered signal.</p>

Trigger Type	Trigger Parameters
<p><b>Transition</b> — Trigger on the rising or falling edge of a signal that crosses the high and low levels within a specified time range.</p>	<p><b>Polarity</b> — Select the polarity for a transition-triggered signal.</p> <ul style="list-style-type: none"> <li>• <b>Rise Time</b> — Trigger on an increasing signal when the signal crosses the high threshold.</li> </ul>  <ul style="list-style-type: none"> <li>• <b>Fall Time</b> — Trigger on a decreasing signal when the signal crosses the low threshold.</li> <li>• <b>Either</b> — Trigger on an increasing or decreasing signal.</li> </ul> <p><b>High</b> — Enter a high value for a transition-triggered signal. <b>Auto level</b> is 90%.</p> <p><b>Low</b> — Enter a low value for a transition-triggered signal. <b>Auto level</b> is 10%.</p> <p><b>Min Time</b> — Enter a minimum time duration for a transition-triggered signal.</p> <p><b>Max Time</b> — Enter a maximum time duration for a transition-triggered signal.</p>

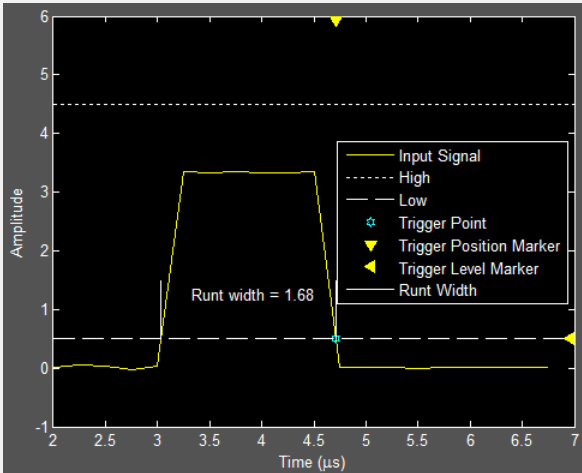
Trigger Type	Trigger Parameters
<p><b>Runt</b>— Trigger when a signal crosses a low threshold or a high threshold twice within a specified time.</p>	<p><b>Polarity</b> — Select the polarity for a runt-triggered signal.</p> <ul style="list-style-type: none"> <li>• <b>Positive</b> — Trigger on a positive-polarity pulse when the signal crosses the low threshold a second time, without crossing the high threshold.</li> </ul>  <ul style="list-style-type: none"> <li>• <b>Negative</b> — Trigger on a negative-polarity pulse.</li> <li>• <b>Either</b> — Trigger on both positive-polarity and negative-polarity pulses.</li> </ul> <p><b>High</b> — Enter a high value for a runt-triggered signal. <b>Auto level</b> is 90%.</p> <p><b>Low</b> — Enter a low value for a runt-triggered signal. <b>Auto level</b> is 10%.</p> <p><b>Min Width</b> — Enter a minimum width for a runt-triggered signal. Pulse width is measured between the first and second crossing of a threshold.</p> <p><b>Max Width</b> — Enter a maximum pulse width for a runt-triggered signal.</p>

Trigger Type	Trigger Parameters
<p><b>Window</b> — Trigger when a signal stays within or outside a region defined by the high and low thresholds for a specified time.</p>	<p><b>Polarity</b> — Select the region for a window-triggered signal.</p> <ul style="list-style-type: none"> <li> <b>Inside</b> — Trigger when a signal leaves a region between the low and high levels.                     <div data-bbox="580 451 1159 933" data-label="Figure"> </div> </li> <li> <b>Outside</b> — Trigger when a signal enters a region between the low and high levels.                     <div data-bbox="580 1046 1159 1519" data-label="Figure"> </div> </li> </ul>

Trigger Type	Trigger Parameters
	<ul style="list-style-type: none"><li data-bbox="543 298 1298 361">• <b>Either</b> — Trigger when a signal leaves or enters a region between the low and high levels.</li></ul> <p data-bbox="543 388 1332 451"><b>High</b> — Enter a high value for a window-triggered signal. <b>Auto level</b> is 90%.</p> <p data-bbox="543 479 1282 541"><b>Low</b> — Enter a low value for a window-trigger signal. <b>Auto level</b> is 10%.</p> <p data-bbox="543 569 1311 631"><b>Min Time</b> — Enter the minimum time duration for a window-triggered signal.</p> <p data-bbox="543 659 1320 722"><b>Max Time</b> — Enter the maximum time duration for a window-triggered signal.</p>

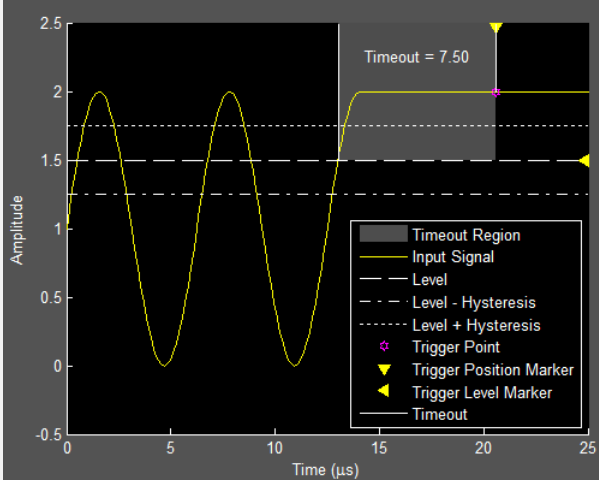
Trigger Type	Trigger Parameters
<p><b>Timeout</b> — Trigger when a signal stays above or below a threshold longer than a specified time</p>	<p><b>Polarity</b> — Select the polarity for a timeout-triggered signal.</p> <ul style="list-style-type: none"> <li>• <b>Rising</b> — Trigger when the signal does not cross the threshold from below. For example, if you set <b>Timeout</b> to 7.50 seconds, the scope triggers 7.50 seconds after the signal crosses the threshold.</li> </ul>  <ul style="list-style-type: none"> <li>• <b>Falling</b> — Trigger when the signal does not cross the threshold from above.</li> <li>• <b>Either</b> — Trigger when the signal does not cross the threshold from either direction</li> </ul> <p><b>Level</b> — Enter a threshold value for a timeout-triggered signal.</p> <p><b>Hysteresis</b> — Enter a value for a timeout-triggered signal. See “Hysteresis of Trigger Signals” on page 26-27.</p> <p><b>Timeout</b> — Enter a time duration for a timeout-triggered signal.</p> <p>Alternatively, a trigger event can occur when the signal stays within the boundaries defined by the hysteresis for 7.50 seconds after the signal crosses the threshold.</p>

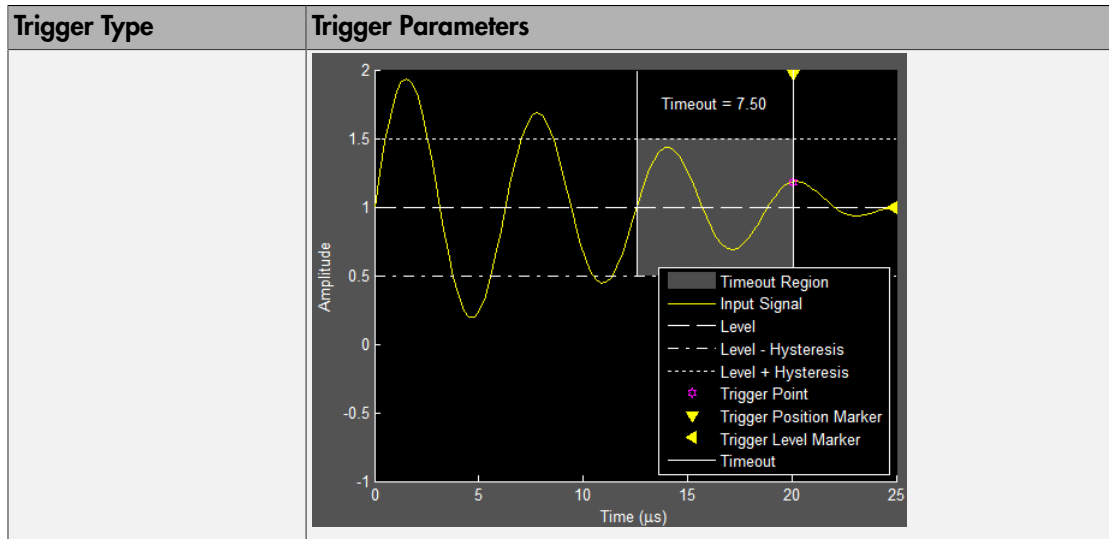

## Hysteresis of Trigger Signals

**Hysteresis (V)** — Specify the hysteresis or noise reject value. This parameter is visible when you set **Type** to **Edge** or **Timeout**. If the signal jitters inside this range and briefly crosses the trigger level, the scope does not register an event. In the case of an edge trigger with rising polarity, the scope ignores the times that a signal crosses the trigger level within the hysteresis region.

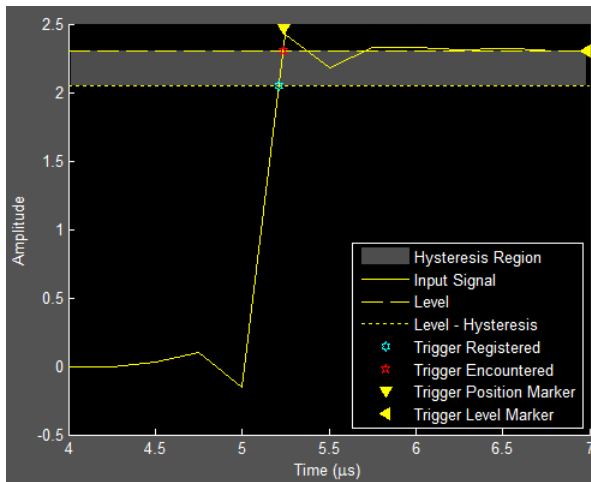

You can reduce the hysteresis region size by decreasing the hysteresis value. If you set the hysteresis value to 0.07 in this example, then the scope also considers the second rising edge to be a trigger event, as shown in the following figure.

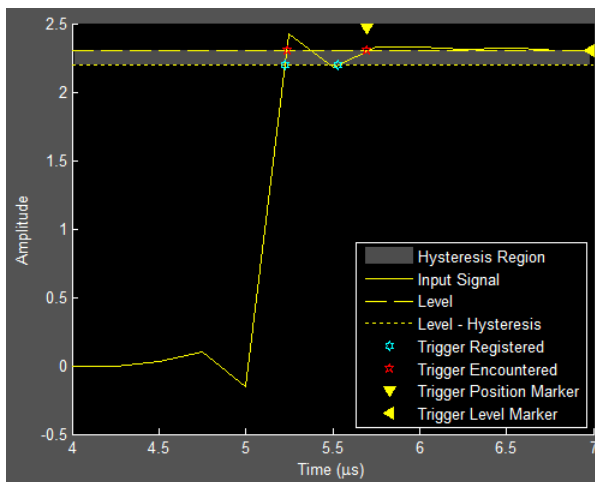

## Delay/Holdoff Pane

Offset the trigger position by a fixed delay, or set the minimum possible time between trigger events.



- **Delay (s)** — Specify the fixed delay time by which to offset the trigger position. This parameter controls the amount of time the scope waits after a trigger event occurs before displaying a signal.
- **Holdoff (s)** — Specify the minimum possible time between trigger events. This amount of time is used to suppress data acquisition after a valid trigger event has occurred. A trigger holdoff prevents repeated occurrences of a trigger from occurring during the relevant portion of a burst.

## See Also

Floating Scope | Scope

## Related Examples

- “Scope Cursor Measurements Panel” on page 26-30

## Scope Cursor Measurements Panel

### In this section...

“Settings Pane” on page 26-30

“Measurements Pane” on page 26-31

Display screen cursors with signal times and values. To open the Cursor measurements panel:

- From the menu, select **Tools > Measurements > Cursor Measurements**.
- On the toolbar, click the Cursor Measurements  button.

### Settings Pane

The Setting Pane is part of the Cursor Measurements Panel.

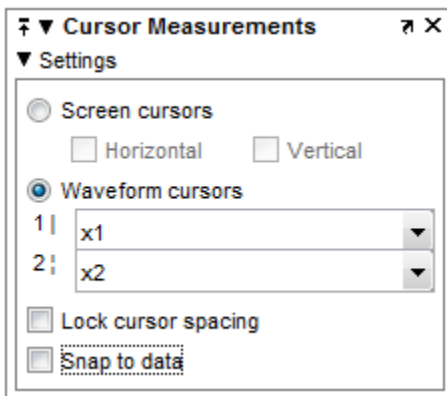

Select screen or waveform cursors for calculating measurements.

- **Screen Cursors** — Select cursors not attached to input signals.
- **Horizontal** — Display horizontal screen cursor.
- **Vertical** — Display vertical screen cursors.
- **Waveform Cursors** — Select vertical cursors attached to input signals.
- **1** — From the drop-down list, select an input signal for first waveform cursor.

- **2** — From the drop-down list, select an input signal for second waveform cursor.
- **Lock Cursor Spacing** — Lock the time and value difference between the two cursors.
- **Snap to Data** — Position waveform cursors on signal data points.

## Measurements Pane

The Measurements pane is part of the Cursor Measurements panel.

The Measurements pane is part of the Cursor Measurements panel.

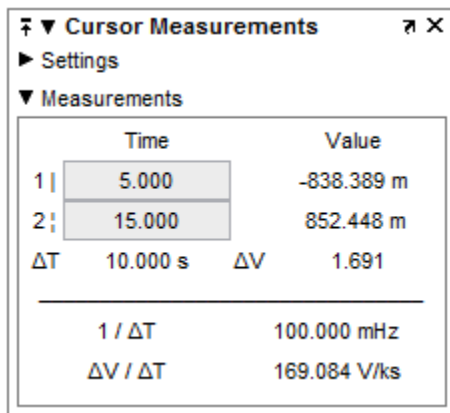

The screenshot shows a window titled "Cursor Measurements" with a "Settings" button and a "Measurements" section. The "Measurements" section contains a table with two columns: "Time" and "Value". The table has two rows for cursors 1 and 2, and a row for the difference between them. Below the table, there are two rows of calculated values: "1 / ΔT" and "ΔV / ΔT".

	Time	Value
1	5.000	-838.389 m
2	15.000	852.448 m
ΔT	10.000 s	ΔV 1.691
<hr/>		
	1 / ΔT	100.000 mHz
	ΔV / ΔT	169.084 V/ks

Display time and value measurements.

- **1 |**— Shows or enables you to modify the time or value at cursor number one, or both.
- **2 |**— Shows or enables you to modify the time or value at cursor number two, or both.
- **Δt**— Shows the absolute value of the difference in the times between cursor number one and cursor number two.
- **ΔV**— Shows the absolute value of the difference in signal amplitudes between cursor number one and cursor number two.
- **1/Δt**— Shows the rate, the reciprocal of the absolute value of the difference in the times between cursor number one and cursor number two.
- **ΔV/Δt**— Shows the slope, the ratio of the absolute value of the difference in signal amplitudes between cursors to the absolute value of the difference in the times between cursors.

## **See Also**

Floating Scope | Scope

## **Related Examples**

- “Scope Triggers Panel” on page 26-16

## Scope Signal Statistics Panel

**Note:** The Signal Statistics panel requires a DSP System Toolbox or Simscape license.

Display signal statistics for the signal selected in the **Trace Selection** panel. To open the Signal Statistics panel:

- From the menu, select **Tools > Measurements > Signal Statistics**.
- On the toolbar, click the Signal Statistics  button.

Signal Statistics		
	Value	Time
Max	2.011	20.000
Min	-2.008	16.596
Peak to Peak	4.019	
Mean	182.407 m	
Median	401.438 m	
RMS	1.568	

The statistics shown are:

- **Max** — Shows the maximum or largest value within the displayed portion of the input signal.
- **Min** — Shows the minimum or smallest value within the displayed portion of the input signal.
- **Peak to Peak** — Shows the difference between the maximum and minimum values within the displayed portion of the input signal.
- **Mean** — Shows the average or mean of all the values within the displayed portion of the input signal.
- **Median** — Shows the median value within the displayed portion of the input signal.
- **RMS** — Shows the difference between the maximum and minimum values within the displayed portion of the input signal.

When you use the zoom options in the Scope, the Signal Statistics measurements automatically adjust to the time range shown in the display. In the Scope toolbar, click

the **Zoom In** or **Zoom X** button to constrict the  $x$ -axis range of the display, and the statistics shown reflect this time range. For example, you can zoom in on one pulse to make the **Signal Statistics** panel display information about only that particular pulse.

The Signal Statistics measurements are valid for any units of the input signal. The letter after the value associated with each measurement represents the appropriate International System of Units (SI) prefix, such as  $m$  for *milli*-. For example, if the input signal is measured in volts, an  $m$  next to a measurement value indicates that this value is in units of millivolts. The SI prefixes are shown in the following table:

### See Also

Floating Scope | Scope

### Related Examples

- “Scope Triggers Panel” on page 26-16

## Scope Bilevel Measurements Panel

### In this section...

“Settings” on page 26-35

“Transitions Pane” on page 26-38

“Overshoots / Undershoots Pane” on page 26-42

“Cycles Pane” on page 26-45

---

**Note:** The Bilevel Measurements panel requires a DSP System Toolbox or Simscape license.

---

Display information about signal transitions, overshoots, undershoots, and cycles. To open the Bilevel Measurements panel:

- From the menu, select **Tools > Measurements > Bilevel Measurements**.
- On the toolbar, click the Bilevel Measurements  button.

### Settings

The **Settings** pane enables you to modify the properties used to calculate various measurements involving transitions, overshoots, undershoots, and cycles. You can modify the high-state level, low-state level, state-level tolerance, upper-reference level, mid-reference level, and lower-reference level.

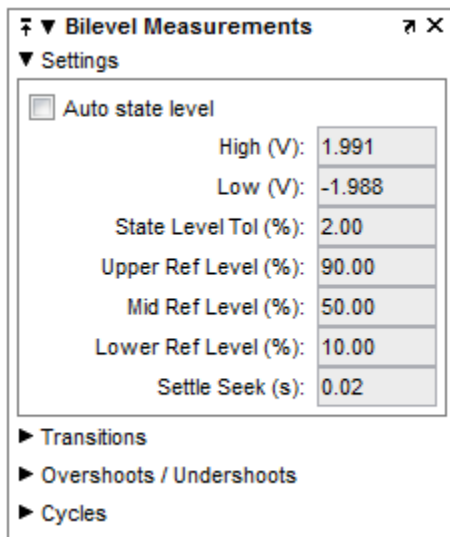

- **Auto State Level** — When this check box is selected, the Bilevel measurements panel detects the high- and low- state levels of a bilevel waveform. When this check box is cleared, you can enter in values for the high- and low- state levels manually.
- **High** — Used to specify manually the value that denotes a positive polarity, or high-state level, as shown in the following figure.

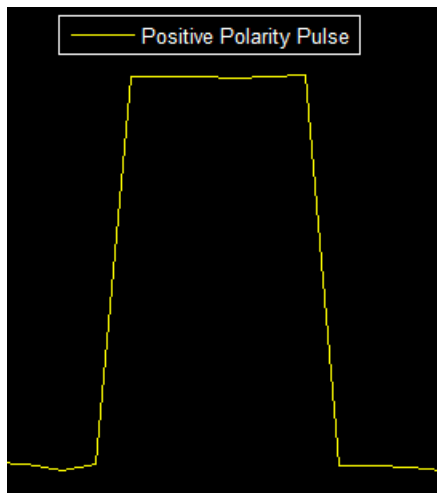



- **Low** — Used to specify manually the value that denotes a negative polarity, or low-state level, as shown in the following figure.

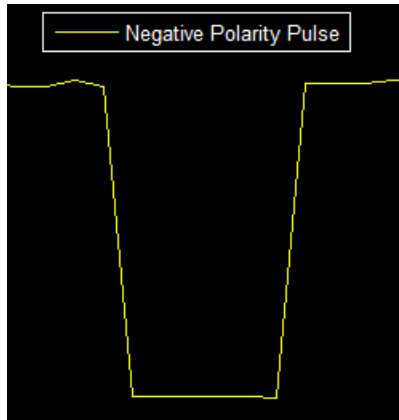

- **State Level Tolerance** — Tolerance within which the initial and final levels of each transition must be within their respective state levels. This value is expressed as a percentage of the difference between the high- and low-state levels.
- **Upper Ref Level** — Used to compute the end of the rise-time measurement or the start of the fall time measurement. This value is expressed as a percentage of the difference between the high- and low-state levels.
- **Mid Ref Level** — Used to determine when a transition occurs. This value is expressed as a percentage of the difference between the high- and low- state levels. In the following figure, the mid-reference level is shown as the horizontal line, and its corresponding mid-reference level instant is shown as the vertical line.

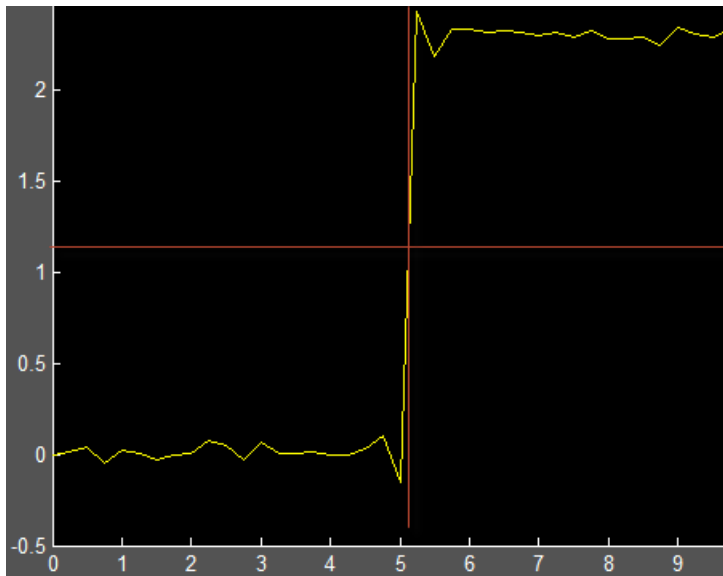

- **Lower Ref Level** — Used to compute the end of the fall-time measurement or the start of the rise-time measurement. This value is expressed as a percentage of the difference between the high- and low-state levels.
- **Settle Seek** — The duration after the mid-reference level instant when each transition occurs used for computing a valid settling time. This value is equivalent to the input parameter, D, which you can set when you run the `settlingtime` function. The settling time is displayed in the **Overshoots/Undershoots** pane.

## Transitions Pane

Display calculated measurements associated with the input signal changing between its two possible state level values, high and low.

Bilevel Measurements	
Settings	
Transitions	
High	1.991 V
Low	-1.988 V
Amplitude	3.979 V
+ Edges	3
+ Rise Time	2.314 secs
+ Slew Rate	1.376 V/s
- Edges	2
- Fall Time	2.315 secs
- Slew Rate	-1.375 V/s
Overshoots / Undershoots	
Cycles	

A positive-going transition, or *rising edge*, in a bilevel waveform is a transition from the low-state level to the high-state level. A positive-going transition has a slope value greater than zero. The following figure shows a positive-going transition.

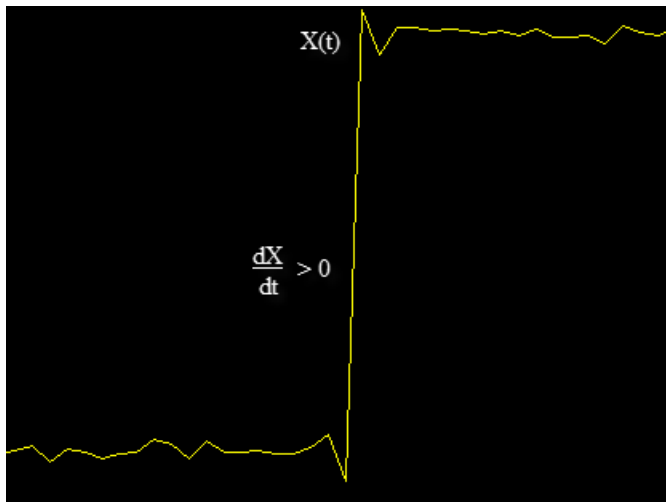

Whenever there is a plus sign (+) next to a text label, this symbol refers to measurement associated with a rising edge, a transition from a low-state level to a high-state level.

A negative-going transition, or falling edge, in a bilevel waveform is a transition from the high-state level to the low-state level. A negative-going transition has a slope value less than zero. The following figure shows a negative-going transition.

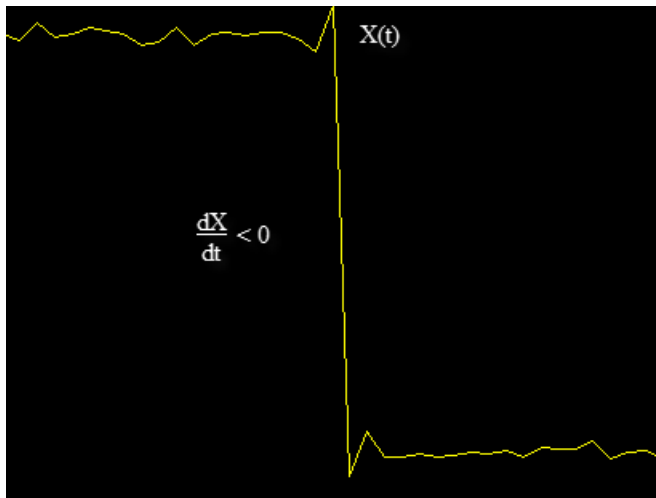

Whenever there is a minus sign (–) next to a text label, this symbol refers to measurement associated with a falling edge, a transition from a high-state level to a low-state level.

The Transition measurements assume that the amplitude of the input signal is in units of volts. You must convert all input signals to volts for the Transition measurements to be valid.

- **High** — The high-amplitude state level of the input signal over the duration of the **Time Span** parameter. You can set **Time Span** in the **Main** pane of the Visuals—Time Domain Properties dialog box.
- **Low** — The low-amplitude state level of the input signal over the duration of the **Time Span** parameter. You can set **Time Span** in the **Main** pane of the Visuals—Time Domain Properties dialog box.
- **Amplitude** — Difference in amplitude between the high-state level and the low-state level.

- **+ Edges** — Total number of positive-polarity, or rising, edges counted within the displayed portion of the input signal.
- **+ Rise Time** — Average amount of time required for each rising edge to cross from the lower-reference level to the upper-reference level.
- **+ Slew Rate** — Average slope of each rising-edge transition line within the upper- and lower-percent reference levels in the displayed portion of the input signal. The region in which the slew rate is calculated appears in gray in the following figure.

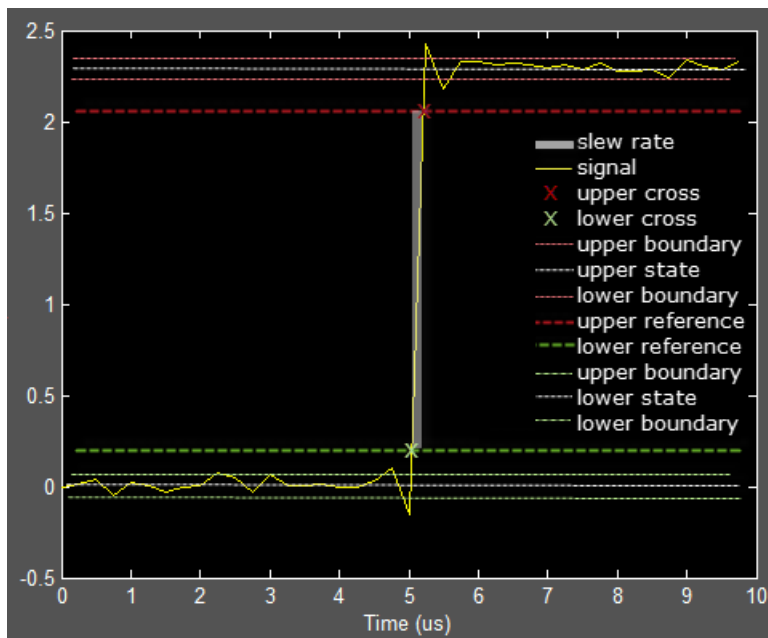

- **- Edges** — Total number of negative-polarity or falling edges counted within the displayed portion of the input signal.
- **- Fall Time** — Average amount of time required for each falling edge to cross from the upper-reference level to the lower-reference level.
- **- Slew Rate** — Average slope of each falling edge transition line within the upper- and lower-percent reference levels in the displayed portion of the input signal.

## Overshoots / Undershoots Pane

The **Overshoots/Undershoots** pane displays calculated measurements involving the distortion and damping of the input signal. *Overshoot* and *undershoot* refer to the amount that a signal respectively exceeds and falls below its final steady-state value. *Preshoot* refers to the amount before a transition that a signal varies from its initial steady-state value.

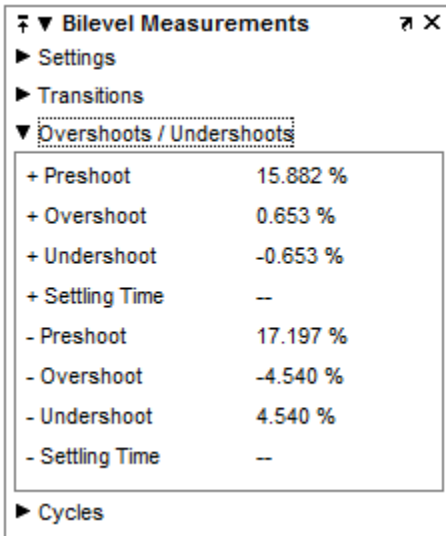

The screenshot shows a software interface with a tree view. The 'Overshoots / Undershoots' section is expanded, revealing a table of measurements. The table lists various metrics with their corresponding percentage values. The metrics are grouped by a '+' sign for positive values and a '-' sign for negative values. The 'Settling Time' metrics are represented by '--'.

Metric	Value
+ Preshoot	15.882 %
+ Overshoot	0.653 %
+ Undershoot	-0.653 %
+ Settling Time	--
- Preshoot	17.197 %
- Overshoot	-4.540 %
- Undershoot	4.540 %
- Settling Time	--

This figure shows preshoot, overshoot, and undershoot for a rising-edge transition.

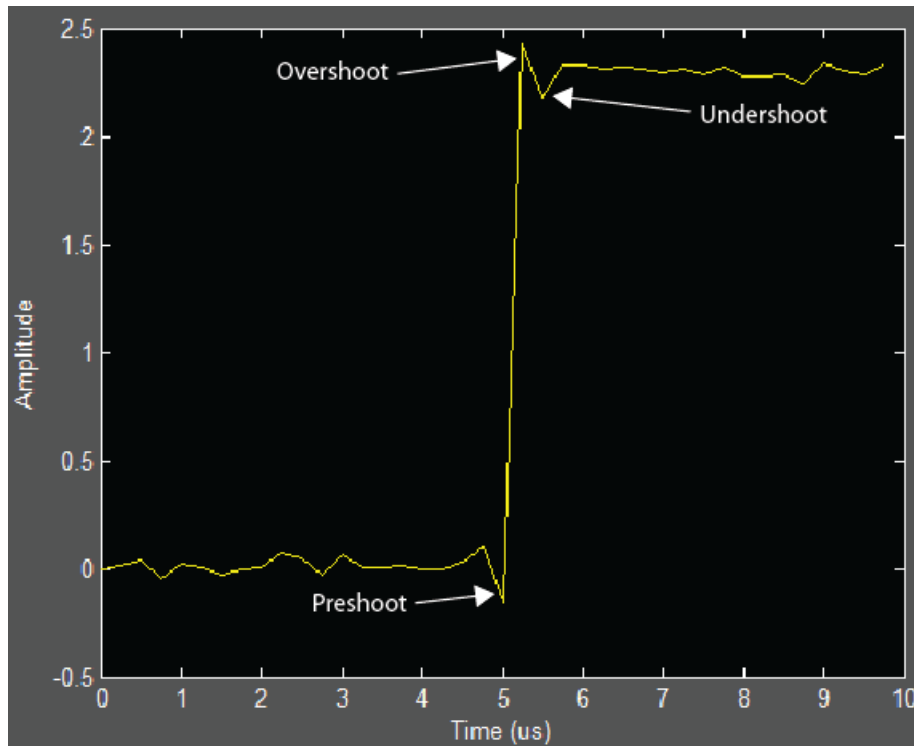

The next figure shows preshoot, overshoot, and undershoot for a falling-edge transition.

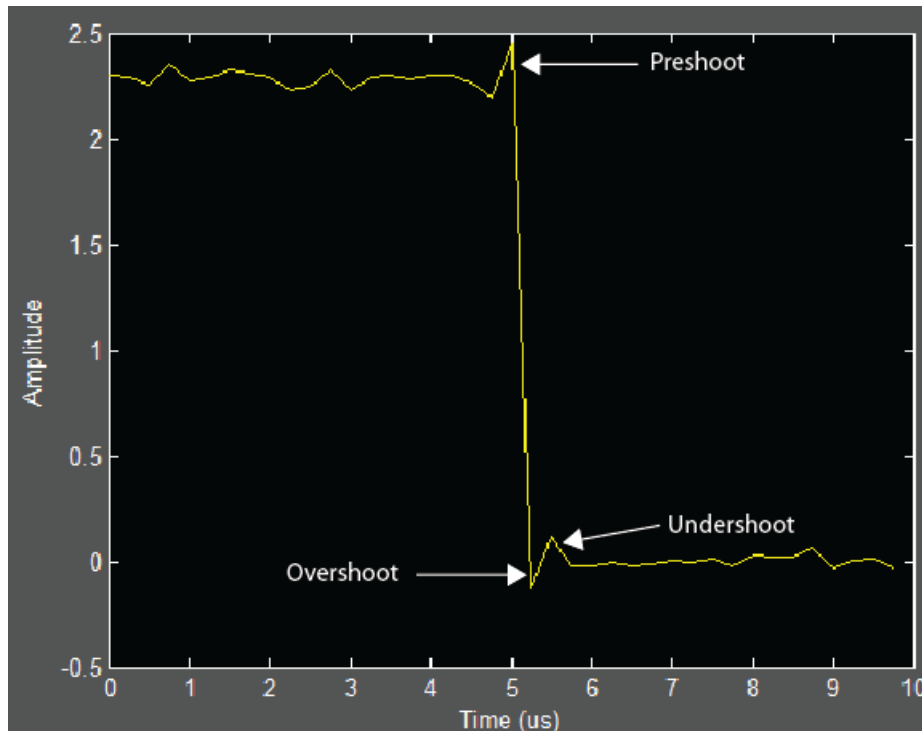

- **+ Preshoot** — Average lowest aberration in the region immediately preceding each rising transition.
- **+ Overshoot** — Average highest aberration in the region immediately following each rising transition.
- **+ Undershoot** — Average lowest aberration in the region immediately following each rising transition.
- **+ Settling Time** — Average time required for each rising edge to enter and remain within the tolerance of the high-state level for the remainder of the settle seek duration. The settling time is the time after the mid-reference level instant when the signal crosses into and remains in the tolerance region around the high-state level. This crossing is illustrated in the following figure.



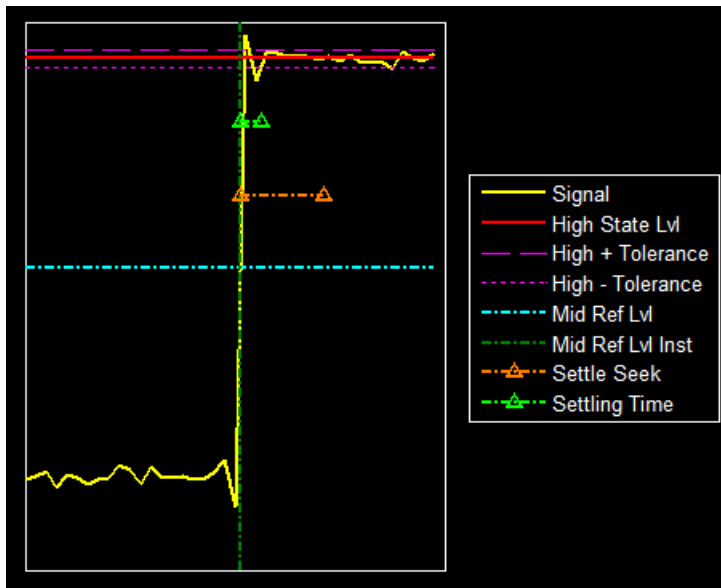

You can modify the settle seek duration parameter in the **Settings** pane.

- – **Preshoot** — Average highest aberration in the region immediately preceding each falling transition.
- – **Overshoot** — Average highest aberration in the region immediately following each falling transition.
- – **Undershoot** — Average lowest aberration in the region immediately following each falling transition.
- – **Settling Time** — Average time required for each falling edge to enter and remain within the tolerance of the low-state level for the remainder of the settle seek duration. The settling time is the time after the mid-reference level instant when the signal crosses into and remains in the tolerance region around the low-state level. You can modify the settle seek duration parameter in the **Settings** pane.

## Cycles Pane

The **Cycles** pane displays calculated measurements pertaining to repetitions or trends in the displayed portion of the input signal.

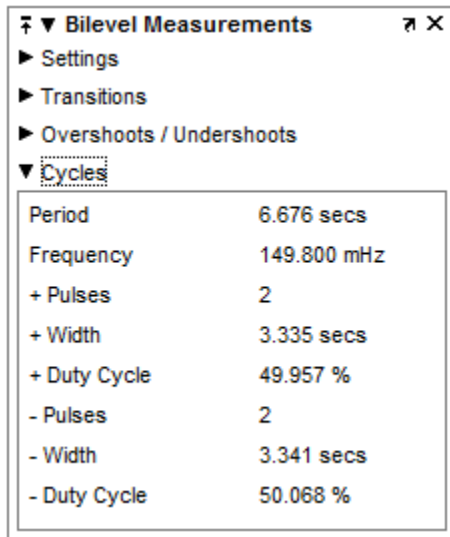

The image shows a software interface window titled "Bilevel Measurements". It contains a tree view with the following items: Settings, Transitions, Overshoots / Undershoots, and Cycles. The "Cycles" item is expanded, showing a list of properties and their values:

Property	Value
Period	6.676 secs
Frequency	149.800 mHz
+ Pulses	2
+ Width	3.335 secs
+ Duty Cycle	49.957 %
- Pulses	2
- Width	3.341 secs
- Duty Cycle	50.068 %

Properties to set:

- **Period** — Average duration between adjacent edges of identical polarity within the displayed portion of the input signal. The Bilevel measurements panel calculates period as follows. It takes the difference between the mid-reference level instants of the initial transition of each positive-polarity pulse and the next positive-going transition. These mid-reference level instants appear as red dots in the following figure.

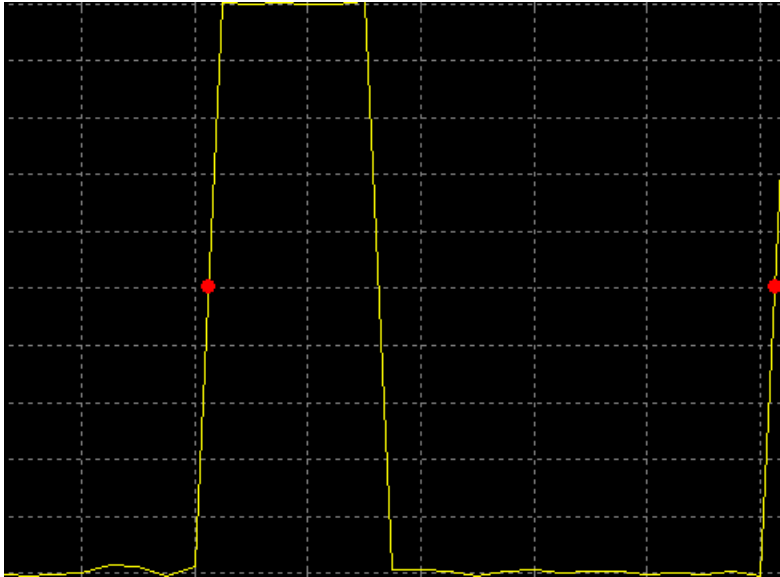

- **Frequency** — Reciprocal of the average period. Whereas period is typically measured in some metric form of seconds, or seconds per cycle, frequency is typically measured in hertz or cycles per second.
- **+ Pulses** — Number of positive-polarity pulses counted.
- **+ Width** — Average duration between rising and falling edges of each positive-polarity pulse within the displayed portion of the input signal.
- **+ Duty Cycle** — Average ratio of pulse width to pulse period for each positive-polarity pulse within the displayed portion of the input signal.
- **- Pulses** — Number of negative-polarity pulses counted.
- **- Width** — Average duration between rising and falling edges of each negative-polarity pulse within the displayed portion of the input signal.
- **- Duty Cycle** — Average ratio of pulse width to pulse period for each negative-polarity pulse within the displayed portion of the input signal.

When you use the zoom options in the Scope, the bilevel measurements automatically adjust to the time range shown in the display. In the Scope toolbar, click the **Zoom In** or **Zoom X** button to constrict the *x*-axis range of the display, and the statistics shown reflect this time range. For example, you can zoom in on one rising edge to make the

**Bilevel Measurements** panel display information about only that particular rising edge. However, this feature does not apply to the **High** and **Low** measurements.

### See Also

Floating Scope | Scope

### Related Examples

- “Scope Triggers Panel” on page 26-16

## Scope Peak Finder Panel

### In this section...

“Settings Pane” on page 26-49

“Peaks Pane” on page 26-51

**Note:** The Peak Finder panel requires a DSP System Toolbox or Simscape license.

The **Peak Finder** panel displays the maxima, showing the  $x$ -axis values at which they occur. This panel allows you to modify the settings for peak threshold, maximum number of peaks, and peak excursion.

- From the menu, select **Tools > Measurements > Peak Finder**.
- On the toolbar, click the Peak Finder  button.

### Settings Pane

The **Settings** pane enables you to modify the parameters used to calculate the peak values within the displayed portion of the input signal.

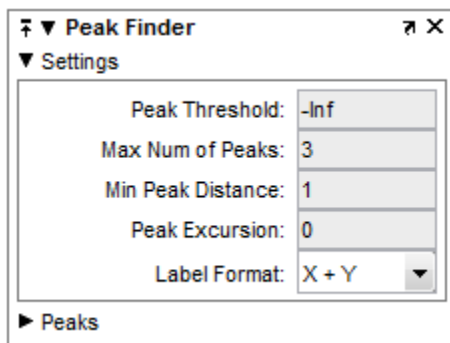

Properties to set:

- **Peak Threshold** — The level above which peaks are detected. This setting is equivalent to the MINPEAKHEIGHT parameter, which you can set when you run the `findpeaks` function.

- **Max Num of Peaks** — The maximum number of peaks to show. The value you enter must be a scalar integer from 1 through 99. This setting is equivalent to the `NPEAKS` parameter, which you can set when you run the `findpeaks` function.
- **Min Peaks Distance** — The minimum number of samples between adjacent peaks. This setting is equivalent to the `MINPEAKDISTANCE` parameter, which you can set when you run the `findpeaks` function.
- **Peak Excursion** — The minimum height difference between a peak and its neighboring samples. Peak excursion is illustrated alongside peak threshold in the following figure.

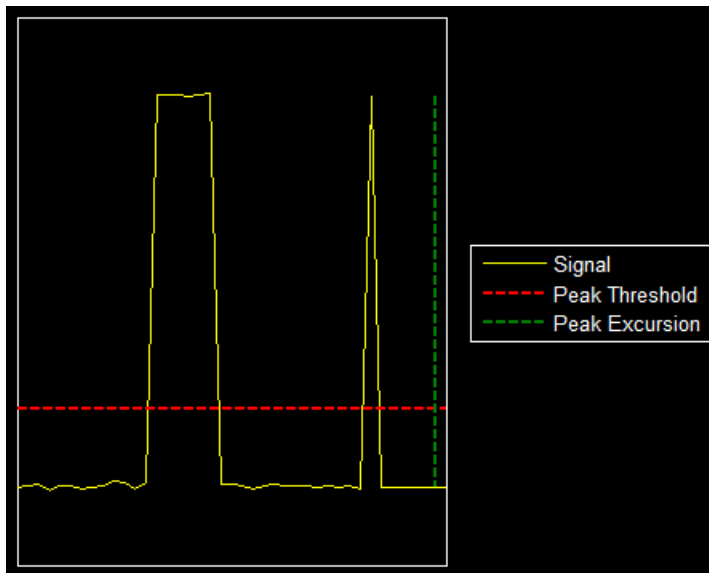

The *peak threshold* is a minimum value necessary for a sample value to be a peak. The *peak excursion* is the minimum difference between a peak sample and the samples to its left and right in the time domain. In the figure, the green vertical line illustrates the lesser of the two height differences between the labeled peak and its neighboring samples. This height difference must be greater than the **Peak Excursion** value for the labeled peak to be classified as a peak. Compare this setting to peak threshold, which is illustrated by the red horizontal line. The amplitude must be above this horizontal line for the labeled peak to be classified as a peak.

The peak excursion setting is equivalent to the **THRESHOLD** parameter, which you can set when you run the `findpeaks` function.

- **Label Format** — The coordinates to display next to the calculated peak values on the plot. To see peak values, you must first expand the **Peaks** pane and select the check boxes associated with individual peaks of interest. By default, both *x*-axis and *y*-axis values are displayed on the plot. Select which axes values you want to display next to each peak symbol on the display.
  - **X+Y** — Display both *x*-axis and *y*-axis values.
  - **X** — Display only *x*-axis values.
  - **Y** — Display only *y*-axis values.

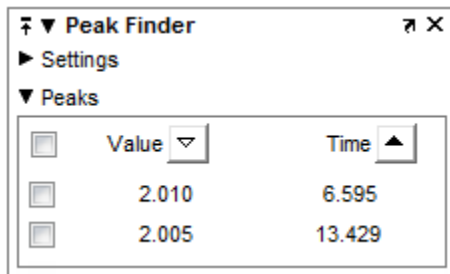

## Peaks Pane

The **Peaks** pane displays all of the largest calculated peak values. It also shows the coordinates at which the peaks occur, using the parameters you define in the **Settings** pane. You set the **Max Num of Peaks** parameter to specify the number of peaks shown in the list.



The numerical values displayed in the **Value** column are equivalent to the `pks` output argument returned when you run the `findpeaks` function. The numerical values displayed in the second column are similar to the `locs` output argument returned when you run the `findpeaks` function.

The Peak Finder displays the peak values in the **Peaks** pane. By default, the **Peak Finder** panel displays the largest calculated peak values in the **Peaks** pane in decreasing order of peak height. Use the sort descending button () to rearrange the

category and order by which Peak Finder displays peak values. Click this button again to sort the peaks in ascending order instead. When you do so, the arrow changes direction to become the sort ascending button (). A filled sort button indicates that the peak values are currently sorted in the direction of the button arrow. If the sort button is not filled () , then the peak values are sorted in the opposite direction of the button arrow. The **Max Num of Peaks** parameter still controls the number of peaks listed.

Use the check boxes to control which peak values are shown on the display. By default, all check boxes are cleared and the **Peak Finder** panel hides all the peak values. To show all the peak values on the display, select the check box in the top-left corner of the **Peaks** pane. To hide all the peak values on the display, clear this check box. To show an individual peak, select the check box directly to the left of its **Value** listing. To hide an individual peak, clear the check box directly to the left of its **Value** listing.

The Peaks are valid for any units of the input signal. The letter after the value associated with each measurement indicates the abbreviation for the appropriate International System of Units (SI) prefix, such as *m* for *milli*-. For example, if the input signal is measured in volts, an *m* next to a measurement value indicates that this value is in units of millivolts.

Abbreviation	Name	Multiplier
a	atto	$10^{-18}$
f	femto	$10^{-15}$
p	pico	$10^{-12}$
n	nano	$10^{-9}$
u	micro	$10^{-6}$
m	milli	$10^{-3}$
		$10^0$
k	kilo	$10^3$
M	mega	$10^6$
G	giga	$10^9$
T	tera	$10^{12}$
P	peta	$10^{15}$
E	exa	$10^{18}$



## **See Also**

Floating Scope | Scope

## **Related Examples**

- “Scope Triggers Panel” on page 26-16

## Scope Tasks

### In this section...

- “Add Scope Block to Model” on page 26-54
- “Connect Signals to Scope Block” on page 26-54
- “Save Simulation Data Using a Scope Block” on page 26-56
- “Share Scope Image” on page 26-58
- “Plot an Array of Signals” on page 26-60
- “Scopes Within an Enabled Subsystem” on page 26-61
- “Show Signal Units on a Scope Display” on page 26-62
- “Select Number of Displays and Layout” on page 26-66
- “Dock and Undock Scope Window to MATLAB Desktop” on page 26-67

### Add Scope Block to Model

To add a Scope block from the Simulink block library:

- 1 From the Simulink Editor menu, select **View > Library Browser**, or on the toolbar, click the Library Browser button .
- 2 From the Simulink Sinks library, drag a copy of the Scope block to the Simulink Editor.

To add a Scope block by searching from the model diagram:

- 1 In the Simulink Editor, click the model diagram.
- 2 Start typing `scope`, and then from the list, select `Scope Simulink/Sinks`.

### Connect Signals to Scope Block

To specify the number of input ports and the display layout:

- 1 Open a Scope window.
- 2 On the Scope toolbar, click the  button.

- 3 Click the **Main** tab. In the **Number of input ports** box, enter the number of signal lines you want to connect.
- 4 Connect signals from block output ports to the scope.

### Nonvirtual Bus and Array of Buses Signals

You can connect nonvirtual bus and array of buses signals to a Scope block. To display the bus signals, use normal or accelerator simulation mode. The Scope block displays each bus element signal, in the order the elements appear in the bus, from the top to the bottom. Nested bus elements are flattened. For example, in this model the `nestedBus` signal has the `const`, `subSignal`, and `step` signals as elements. The `subSignal` subbus has the `chirp` and `sine` signals as its bus elements. In the Scope block, the two elements of the `subSignal` bus display between the `const` and `step` signals.

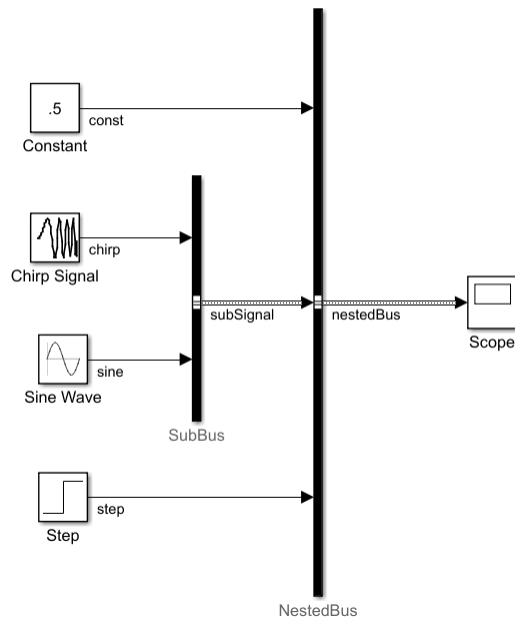

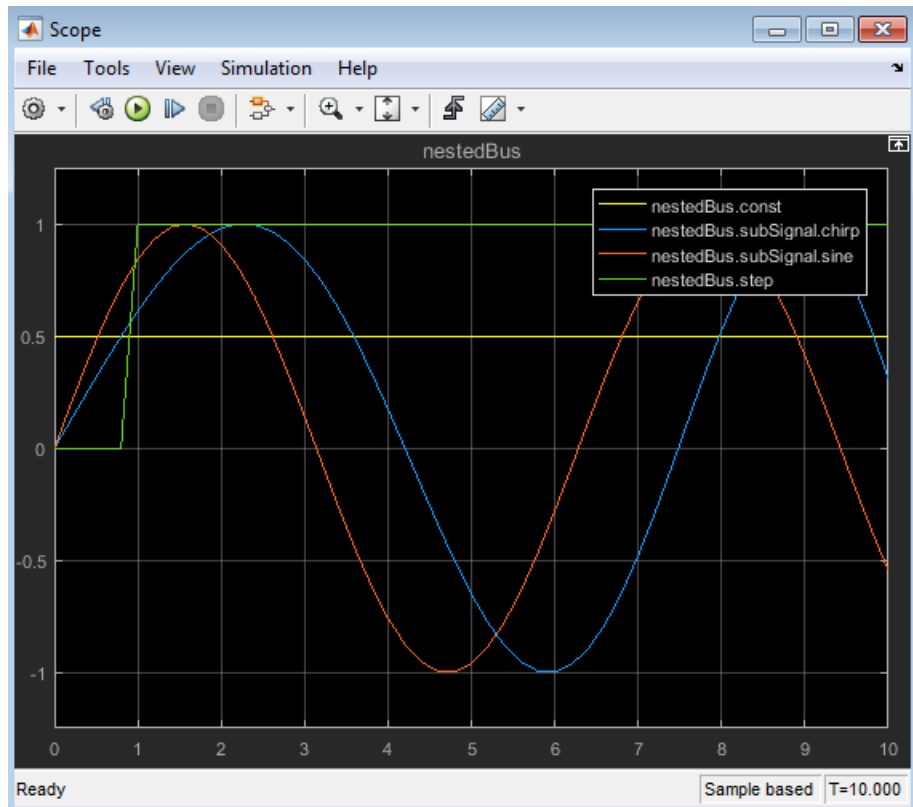

## Save Simulation Data Using a Scope Block

This procedure uses the model `vdp` to demonstrate saving signals to the MATLAB Workspace.

- 1 Add a Scope block to your model. See “Add Scope Block to Model” on page 26-54.
- 2 Connect signals to scope input ports. See “Connect Signals to Scope Block” on page 26-54. For example, connect the signals `x1` and `x2` to a scope.
- 3 Open the Scope window. From the toolbar, click the Parameters button .
- 4 Click the **Logging** tab, and then select the **Log data to workspace** check box. In the **Variable name** box, enter a variable name for saving the data or use the default name `ScopeData`. From the **Save format** list, select `Dataset`. Click **OK**.

Alternatively, you can set **Save format** to format other than Dataset (for example, Array).

When saving data from a Scope block, you do not have to select the **Log signal data** property for a signal or the **Signal logging** parameter on the **Model Configuration Parameters > Data Import/Export** pane.

---

**Note:** To log nonvirtual bus or array of buses signals attached to a Scope block, set the **Save format** parameter to **Dataset**.

---

- 5 Run a simulation. Simulink saves data to the MATLAB Workspace in a Dataset object with two elements, one element for each signal.
- 6 In the MATLAB Command Window, enter these commands to view the logged data from ScopeData, where x1 is the name of a signal:

```
x1_data = ScopeData.getElement('x1').Values.Data
x1_time = ScopeData.getElement('x1').Values.Time
plot(x1_time,x1_data)
```

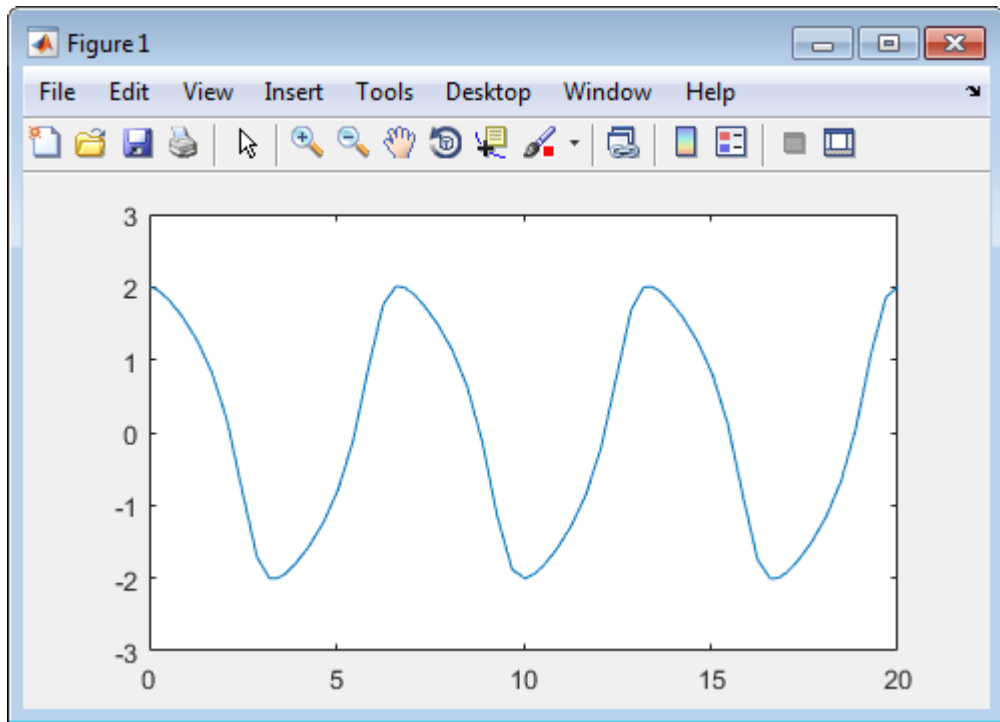

For information about the `Dataset` object, see `Simulink.SimulationData.Dataset`.

## Share Scope Image

This example uses the model `vdp` to demonstrate how to copy and paste a scope image.

- 1 Add a Scope block to your model. See “Add Scope Block to Model” on page 26-54.
- 2 Connect signals to scope ports. See “Connect Signals to Scope Block” on page 26-54. For example, in the `vdp` model, connect the signals `x1` and `x2` to a scope.
- 3 Open the Scope window and run the simulation.

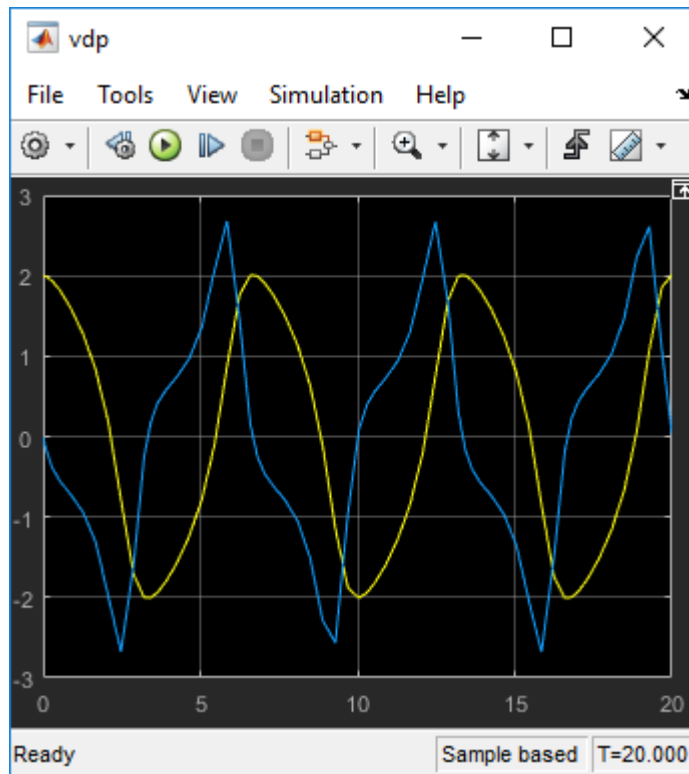

- 4 Select **File > Copy to Clipboard**.
- 5 Paste the image into a document. You paste a printer-friendly version of the scope with a white background and visible lines.

The van der Pol Equation results from my model:

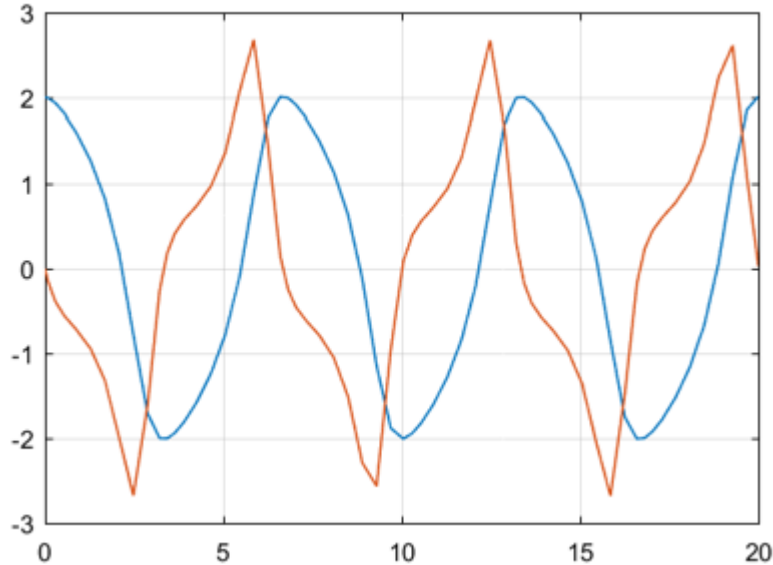

If you want to paste the exact scope plot displayed, select **View > Style**, then select the **Preserve colors for copy to clipboard** check box.

## Plot an Array of Signals

This example takes an array of four-sine wave signals and plots them on a Scope display.

- 1 Connect a Sine Wave block to a Scope block.
- 2 Open the Scope Configuration Properties dialog box. On the Display pane, select the **Legends** check box.
- 3 Set the **Amplitude** parameter for the Sine Wave block to [10 20;30 40].
- 4 Set the **Signal name** property for the signal to **SignalArray**.

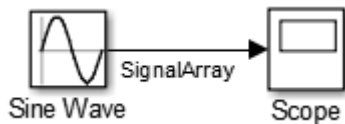



## 5 Simulate the model.

The Scope window displays the four signals in the matrix order (1,1), (2,1), (1,2), (2,2).

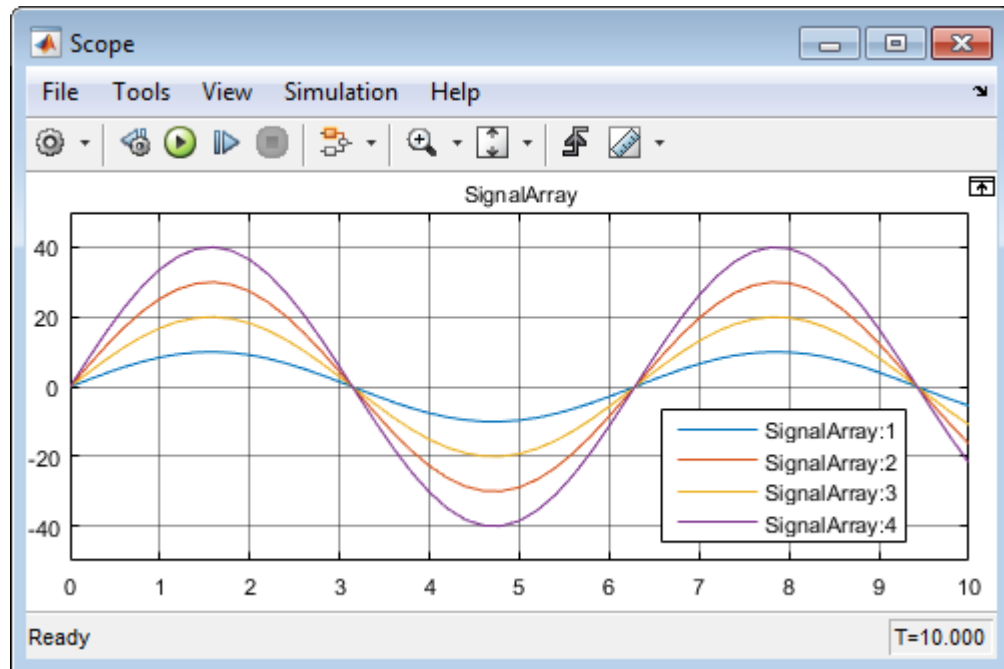

## Scopes Within an Enabled Subsystem

When placed within an Enabled Subsystem block, Scope blocks and Scope Viewers behave differently depending on the simulation mode:

- Normal mode — Scope plots data when the subsystem is enabled. The display plot shows gaps when the subsystem is disabled.

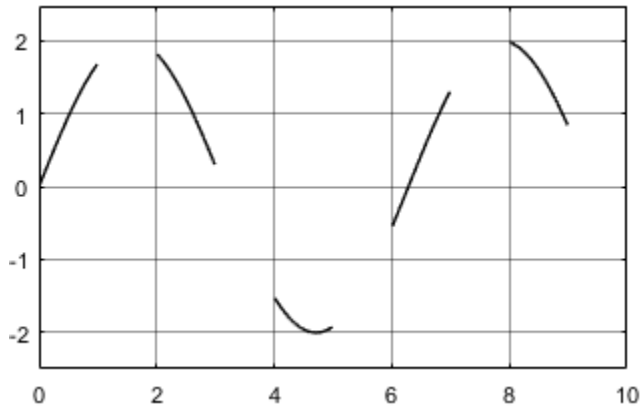

- External, Accelerator, and Rapid modes — Scope plots data when the subsystem is enabled. The display shows draw lines to connect the gaps.

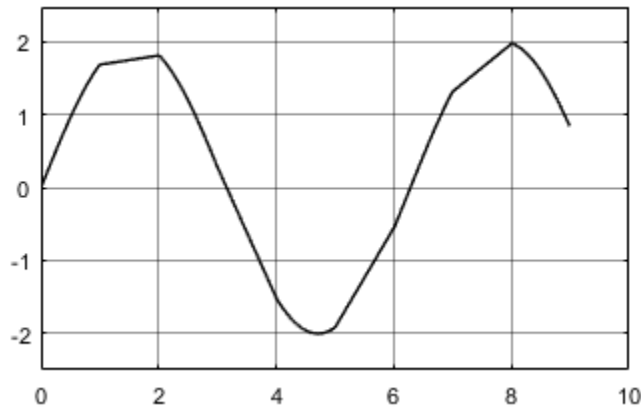

## Show Signal Units on a Scope Display

You can specify signal units at a model component boundary (Subsystem and Model blocks) using Inport and Outport blocks. See “Unit Specification in Simulink Models” on page 9-2 . You can then connect a Scope block to an Outport block or a signal originating from an Outport block. This example, the **Unit** property for the Out1 block was set to m/s.

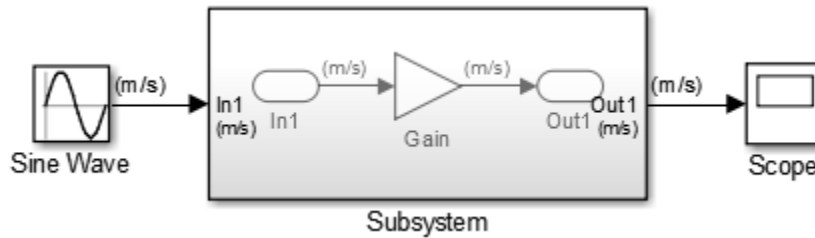

### Show Units on a Scope Display

- 1 From the Scope window toolbar, select the Configuration Properties button .
- 2 In the Configuration Properties: Scope dialog box, select the **Display** tab.
- 3 In the **Y-label** box, enter a title for the y-axis followed by (%<SignalUnits>). For example, enter  
Velocity (%<SignalUnits>)
- 4 Click **OK** or **Apply**.

Signal units display in the y-axis label as meters per second (m/s) and in the Cursor Measurements panel as millimeters per second (mm/s).

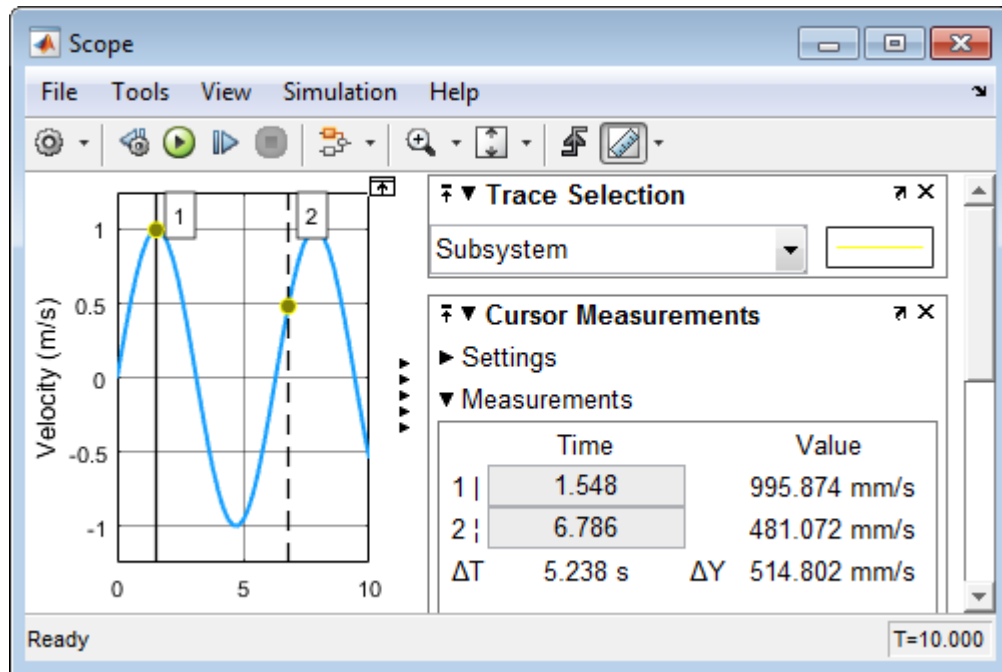

You can also select **Display > Signals & Ports > Ports Units**. You do not have to enter (%<SignalUnits>) in the **Y-Label** property.

### Show Units on a Scope Display Programmatically

- 1 Get the scope properties. In the MATLAB Command Window, enter

```
load_system('my_model')
s = get_param('my_model/Scope', 'ScopeConfiguration');
```

- 2 Add a y-axis label to the first display.

```
s.ActiveDisplay = 1
s.YLabel = 'Velocity (%<SignalUnits>);'
```

You can also set the model parameter **ShowPortUnits** to 'on'. All scopes in your model, with and without (%<SignalUnits>) in the **Y-Label** property, show units on the displays.

```
load_system('my_model')
```

```

get_param('my_model', 'ShowPortUnits')

ans =
off

set_param('my_model', 'ShowPortUnits', 'on')

ans =
on

```



### Determine Units from Logged Data Object

When saving simulation data from a scope with the `Dataset` format, you can find unit information in the `DataInfo` field of the timeseries object.

---

**Note:** Scope support for signal units is only for the `Dataset` logging format and not for the legacy logging formats `Array`, `Structure`, and `Structure With Time`.

---

- 1 From the Scope window toolbar, select the Configuration Properties button .
- 2 In the Configuration Properties: Scope dialog box, select the **Logging** tab.
- 3 Select the **Log data to workspace** check box. In the text box, enter a variable name for saving simulation data. For example, enter `ScopeData`.
- 4 From the Scope window toolbar, select the Run button .
- 5 In the MATLAB Command Window, enter

```

ScopeData.getElement(1).Values.DataInfo

Package: tsdata
Common Properties:
    Units: m/s (Simulink.SimulationData.Unit)
    Interpolation: linear (tsdata.interpolation)

```

### Connect Signals with Different Units to a Scope

When there are multiple ports on a scope, Simulink ensures that each port receives data with only one unit. If you try to combine signals with different units, such as by using a Bus Creator block, Simulink returns an error.

Scopes show units depending on the number of ports and displays:

- **Number of ports equal to the number of displays** — One port is assigned to one display with units for the port signal shown on the *y-axis* label.
- **Greater than the number of displays** — One port is assigned to one display, with the last display assigned the remaining signals. Different units are shown on the last *y-axis* label as a comma-separated list.

## Select Number of Displays and Layout

- 1 From a Scope window toolbar, select the Configuration Properties button .
- 2 In the Configuration Properties dialog box, select the **Main** tab, and then Select the **Layout** button.
- 3 Move your mouse pointer to select the number of displays and the layout you want. For example, select three displays in one column.

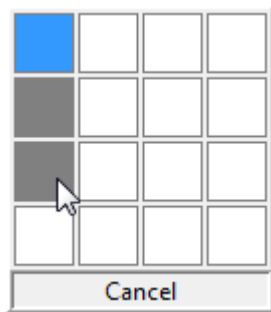

You can select more than four displays in a row or column. Click within the layout, and then drag your mouse pointer to expand the layout to a maximum of 16 rows by 16 columns. For example, click and drag down to select six displays in one column.

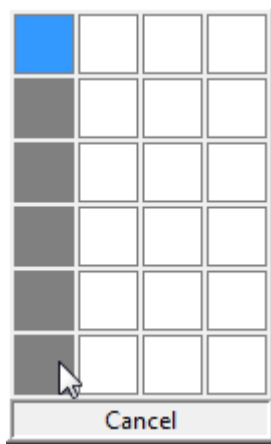

- 4 Click the left mouse button to apply the selected layout to the Scope window.

## Dock and Undock Scope Window to MATLAB Desktop

- 1 In the right corner of a Scope window, click the Dock Scope button.

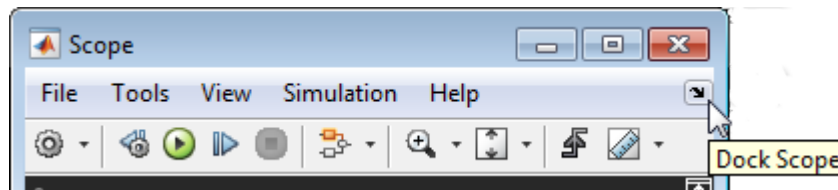

The Scope window is placed above the Command Window in the MATLAB desktop.

- 2 Click the Show Scope Actions button, and then click **Undock Scope**.

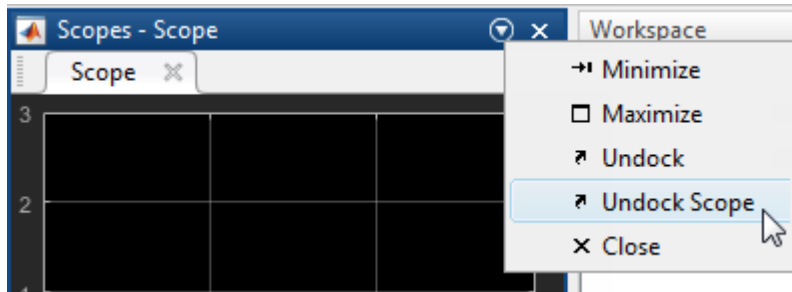

## See Also

Floating Scope | Scope | Scope Viewer

## Related Examples

- “Scope Blocks and Scope Viewer Overview” on page 26-8
- “Floating Scope and Scope Viewer Tasks” on page 26-69



## Floating Scope and Scope Viewer Tasks

### In this section...

- “Add Floating Scope Block to Model” on page 26-69
- “Add Scope Viewer with Signal & Scope Manager” on page 26-69
- “Connect Signals to Floating Scope Block or Scope Viewer” on page 26-70
- “Save Simulation Data Using Floating Scope Block” on page 26-71
- “Run Simulation from Floating Scope Window” on page 26-73
- “Delete Scope Viewer” on page 26-73
- “View Signals on a Floating Scope Quickly” on page 26-73
- “Connect Scope Viewers Without Using Signal Selector” on page 26-73

### Add Floating Scope Block to Model

To add a Floating Scope block from the Simulink block library:

- 1 From the Simulink Editor menu, click the Library Browser button .
- 2 From the Simulink Sinks library, drag a copy of the Floating Scope block to the Simulink Editor.

To add a Floating Scope block by searching from the model diagram:

- 1 In the Simulink Editor, click the model diagram, and then start typing `floating scope`.
- 2 From the list, select `Floating Scope Simulink/Sinks`.

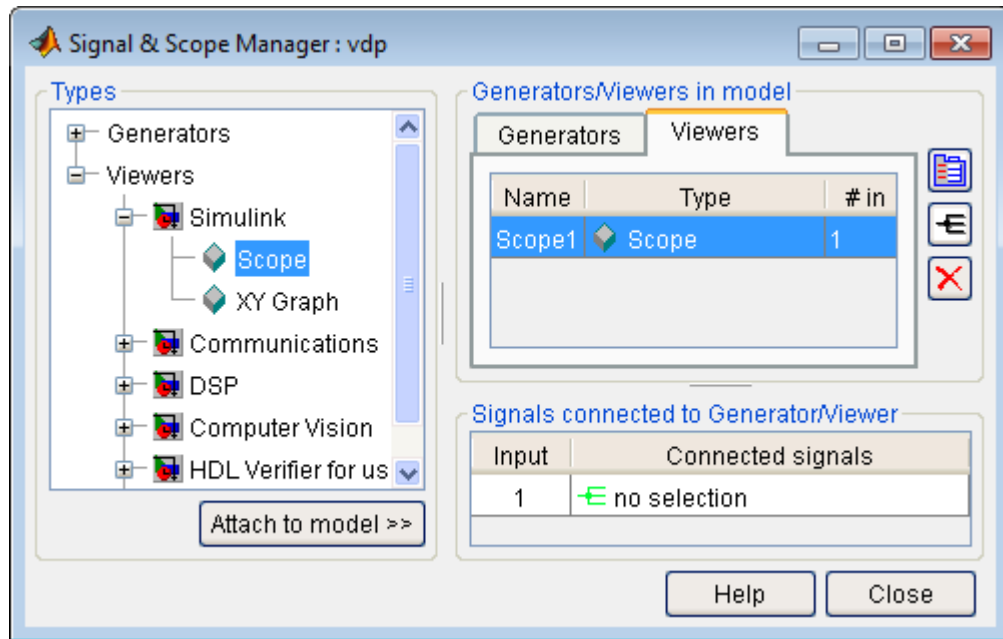

### Add Scope Viewer with Signal & Scope Manager

- 1 From the Simulink Editor menu, select **Diagram > Signals & Ports > Signal & Scope Manager**.
- 2 In the Signal & Scope Manager, in the **Types** pane and under the **Viewers** node, expand a product node to show the available viewers.
- 3 Select a **Scope**, and then click **Attach to model**. The viewer is added to a table on the **Viewers** tab in the **Generators/Viewers in model** pane.



## Connect Signals to Floating Scope Block or Scope Viewer

Use the Signal Selector to connect signals to a Floating Scope block or Scope viewer.

- 1 Open a Scope window. In a Simulink model, double-click a Floating Scope block or Scope viewer icon .
- 2 Open the Signal Selector. On the Scope window toolbar, click the Signal Selector button .
- 3 For Scopes with multiple displays, select a display. In the Signal Selector dialog box, select a display from the **Select signals for object** drop-down list.
- 4 Select check boxes for the signals you want to view.

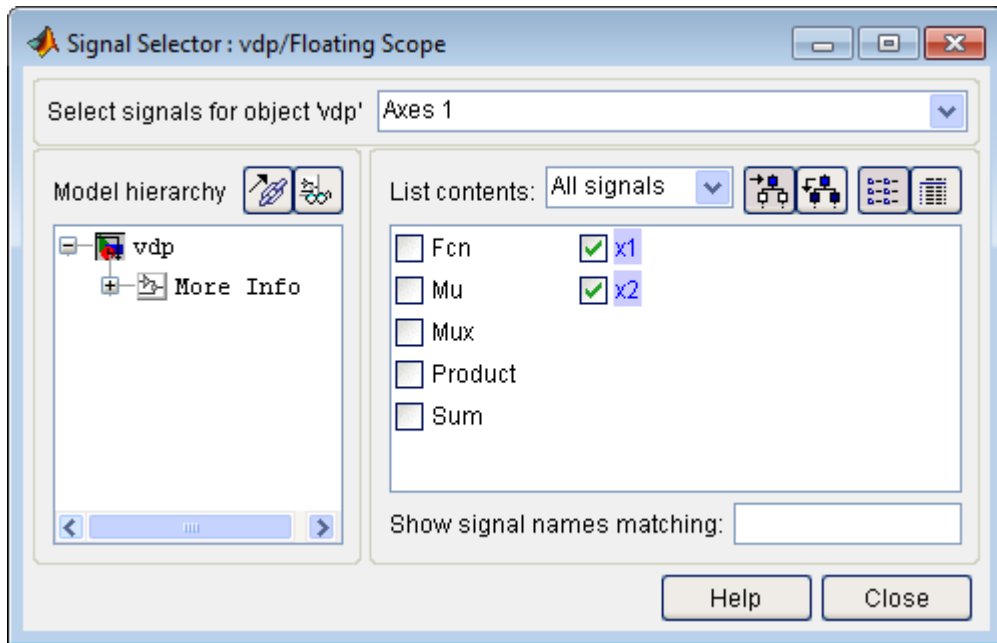

- 5 Click **Close** and then run a simulation.

## Save Simulation Data Using Floating Scope Block

This procedure uses the model vdp to demonstrate saving signals to the MATLAB Workspace.

- 1 Add a Floating Scope or Scope Viewer to your model. See “Add Floating Scope Block to Model” on page 26-69 or “Add Scope Viewer with Signal & Scope Manager” on page 26-69.
- 2 Connect signals using the Signal Selector. See “Connect Signals to Floating Scope Block or Scope Viewer” on page 26-70. For example, select the signals x1 and x2.
- 3 Open a Floating Scope or Scope Viewer window. From the toolbar, click the Parameters button .
- 4 Click the **Logging** tab, and then select the **Log/Unlog Viewed Signals to Workspace** button.

This selection also sets the **Log signal data** parameter check box for the connected signals. The Simulink Editor places logging symbols  on the signals.

- 5 Open the **Configuration Parameters** dialog box. From the Simulink Editor menu, select **Simulation > Model Configuration Parameters > Data Import/Export**.
- 6 Select the **Signal logging** check box. Use the default Dataset object name `logsout` or enter your own name. Click **OK**.
- 7 Run a simulation. Simulink saves data to the MATLAB Workspace in a Dataset object with two elements, one element for each signal.
- 8 In the MATLAB Command Window, enter these commands to view the logged data from `logsout`, where `x1` is the name of a signal:

```
x1_data = logsout.get('x1').Values.Data  
x1_time = logsout.get('x1').Values.Time  
plot(x1_time,x1_data)
```

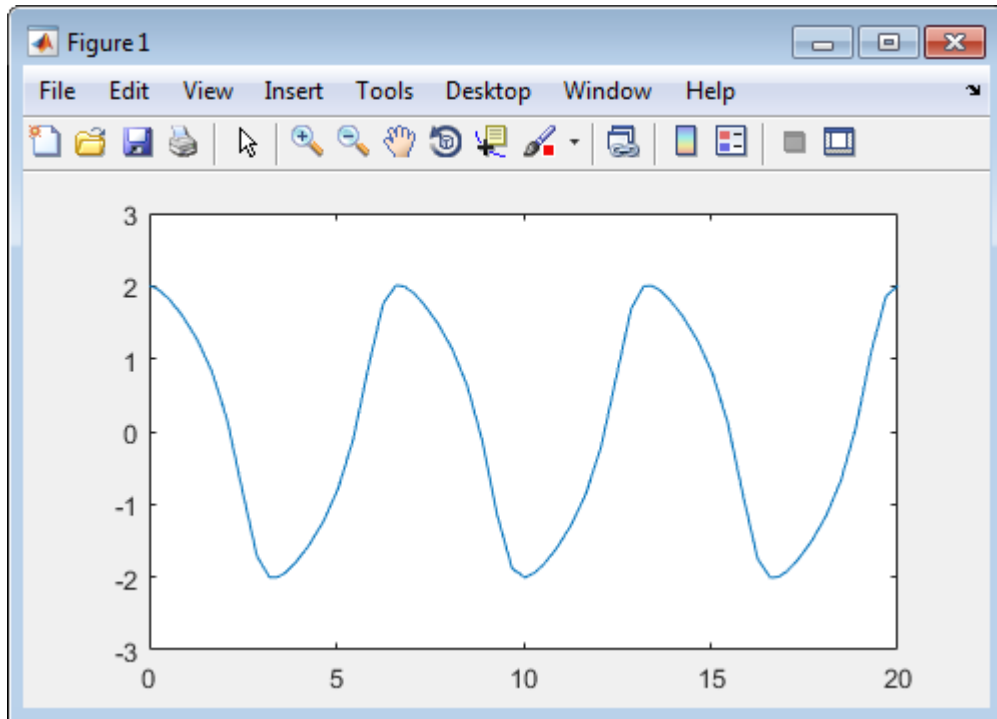

## Run Simulation from Floating Scope Window

- 1 From a Simulink model, double-click a Floating Scope block.
- 2 From the toolbar, click the **Run** button .

For information on using toolbar buttons to control a simulation, see “Step Through a Simulation” on page 2-15.

## Delete Scope Viewer

- 1 Right-click any signal line with a viewer attached or click the viewer symbol  attached to a signal line.
- 2 Select **Delete Viewer**, and then select a viewer name.

## View Signals on a Floating Scope Quickly

- 1 Open a Floating Scope window.
- 2 On the toolbar, click the Lock button  to unlock  the Floating Scope.

Signals that you connected to this scope using the Signal Selector are removed.

- 3 On the model, click a signal line to select and highlight the signal line. To select multiple signals, hold down the **Shift** key while selecting signals.

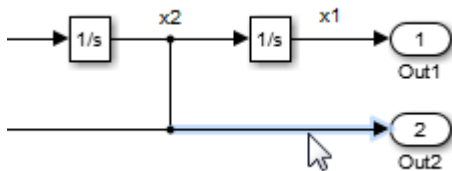

- 4 Run a simulation.

## Connect Scope Viewers Without Using Signal Selector

- 1 Right-click a signal line.
- 2 Select **Create & Connect Viewer > Simulink > Scope**.

The selected signal connects to the Scope Viewer, and a viewer symbol  is added to the signal line.

Connect additional signals using the Signal Selector.

### See Also

Floating Scope | Scope | Scope Viewer

### Related Examples

- “Scope Blocks and Scope Viewer Overview” on page 26-8
- “Scope Tasks” on page 26-54

# Signal Generator Tasks

## In this section...

“Attach Signal Generator” on page 26-75

“Attach and Remove Signal Generator” on page 26-75

## Attach Signal Generator

### Using the Context Menu

- 1 In the Simulink Editor, right-click the input to a block.
- 2 From the context menu, select **Create & Connect Generator**, the product, and then the generator you want as input to the block.

The name of the generator you choose appears in a box connected to the block input.

- 3 Right-click the generator name and select **Generator Parameters**. In the Generator Parameters dialog box, enter values for parameters that are specific to this generator.

### Using the Signal and Scope Manager

- 1 Right-click the input to a block and select **Signal & Scope Manager**.
- 2 In the **Types** pane and under the Generators node, expand a product node to show the available generators.
- 3 Select a generator and click **Attach to model**.

The generator is added to a table in the **Generators** tab in the **Generators/Viewers in model** section. The table lists the generators in your model.

## Attach and Remove Signal Generator

- 1 Right-click a generator icon on a signal line.
- 2 From the context menu, select **Disconnect Generator**.

## See Also

Floating Scope | Scope | Scope Viewer

### **Related Examples**

- “Scope Tasks” on page 26-54
- “Floating Scope and Scope Viewer Tasks” on page 26-69

### **More About**

- “Signal and Scope Manager” on page 26-77



## Signal and Scope Manager

### In this section...

“About the Signal & Scope Manager” on page 26-77

“Change Scope Viewer Parameters” on page 26-78

“Connect Viewers and Generators” on page 26-78

“View Test Point Data” on page 26-78

“Customize Signal & Scope Manager” on page 26-79

### About the Signal & Scope Manager

Using the Signal & Scope Manager you can manage viewers and generators from a central point.

---

**Note:** The Signal and Scope Manager requires that you have Java enabled when you start MATLAB.

---



#### Viewer and Generator

Symbols identify a viewer attached to a signal line and signal names identify generators. Manage viewers and generators using the Signal & Scope Manager.

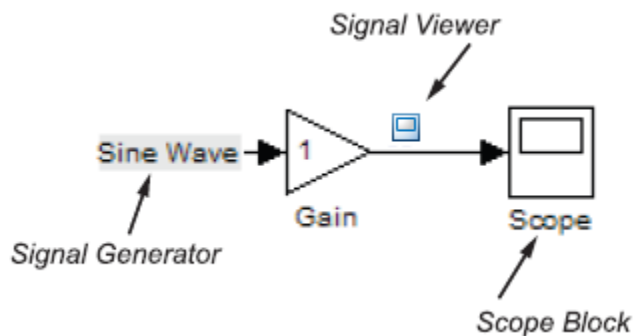
Viewers and generators are not blocks. Blocks are dragged from the Library browser and managed with block dialog boxes.



## Change Scope Viewer Parameters

- 1 Open the Signal & Scope Manager. Right-click the input to a block and select **Signal & Scope Manager**.
- 2 To the right side of the **Generators** and **Viewers** pane, click the Parameters button .
  - For a generator, the Generator Parameters dialog box opens.
  - For a viewer, a Viewer opens. From the viewer toolbar, select the parameters button . The Viewer parameters dialog box opens.
- 3 Review and change parameters.

## Connect Viewers and Generators

Connect signals to new viewer or generator using the Signal & Scope Manager.

- 1 Open the Signal & Scope Manager window. Right-click a signal line, and then select **Signal & Scope Manager**.
- 2 From the **Types** pane, select a viewer or generator.
- 3 Click **Attach to model**.
- 4 Use the Signal Selector (see “Signal Selector” on page 26-81 ) to connect the viewer or generator to a signal.

## View Test Point Data

Use a Scope viewer available from the Signal and Scope Manager to view any signal that is defined as a test point in a referenced model. A test point is a signal that you can always see when using a Scope viewer in a model.

---

**Note:** With some viewers (for example, XY Graph, To Video Display, Matrix Viewer, Spectrum Scope, and Vector Scope), you cannot use the Signal Selector to select signals with test points in referenced models.

---

For more information, see “Test Points” on page 62-56.

## Customize Signal & Scope Manager

You can add custom signal viewers or generators so that they appear in the Signal & Scope Manager. The following procedure assumes that you have a custom viewer named `newviewer` that you want to add.

- 1 Open a new Simulink library.

For example, open the Simulink browser and select **File > New > Library**.

- 2 Save the library.

For example, save it as `newlib`.

- 3 In the MATLAB Command Window, set the library type for the library.

For example, to set the library type of `newviewer` to `viewer`,

```
set_param('newlib','LibraryType','SSMgrViewerLibrary')
```

To set library type for generators, use the type `'SSMgrGenLibrary'`.

For example,

```
set_param('newlib','LibraryType','SSMgrGenLibrary')
```

- 4 Set the display name of the library.

For example,

```
set_param('newlib','SSMgrDisplayString','My Custom Library')
```

- 5 Add the viewer or generator to the library.

---

**Note:** If the viewer is a compound viewer, such as a subsystem with multiple blocks, make the top-level subsystem an atomic one.

---

- 6 Set the `ioType` of the viewer.

For example,

```
set_param('newlib/newviewer','ioType','viewer')
```

- 7 Save the library `newlib`. In the Simulink window, select **File > Save**.

- 8 Using the MATLAB editor, create a file named `sl_customization.m`. In this file, enter a directive to incorporate the new library as a viewer library.

For example, to save `newLib` as a viewer library, add the following lines:

```
function sl_customization(cm)
cm.addSigScopeMgrViewerLibrary('newLib')
%end function
```

To add a library as a generator library, add a line like the following:

```
cm.addSigScopeMgrGeneratorLibrary('newLib')
```

- 9 Add a corresponding `cm.addSigScope` line for each viewer or generator library you want to add.
- 10 Save the `sl_customization.m` file on your MATLAB path. Edit this file to add new viewer or generator libraries.
- 11 To see the new custom libraries, restart MATLAB and start the Signal & Scope Manager.

## See Also

Floating Scope | Scope | Scope Viewer

## Related Examples

- “Scope Tasks” on page 26-54
- “Floating Scope and Scope Viewer Tasks” on page 26-69

## More About

- “Scope Blocks and Scope Viewer Overview” on page 26-8
- “Signal Selector” on page 26-81

## Signal Selector

### In this section...

“About the Signal Selector” on page 26-81



“Select Signals” on page 26-82

“Model Hierarchy” on page 26-82

“Inputs/Signals List” on page 26-82

### About the Signal Selector

Use the Signal Selector to add signals to a Floating Scope or Scope viewer. See “Add Scope Viewer with Signal & Scope Manager” on page 26-69 . To open the Signal Selector,

- Open a Floating Scope. From the menu, select **Simulation > Signal Selector**, or on the toolbar, click the Signal Selector button .
- Open a model. From the menu, select **Diagram > Signal & Ports > Signal & Scope Manager**. On the right side of the Signal & Scope Manager, click the Signal Selector button .

The Signal Selector that appears when you click the **Edit signal selection** button applies only to the currently selected generator or viewer. If you want to connect blocks to another generator or viewer object, select the object in the Signal & Scope Manager and then open another instance of the Signal Selector.

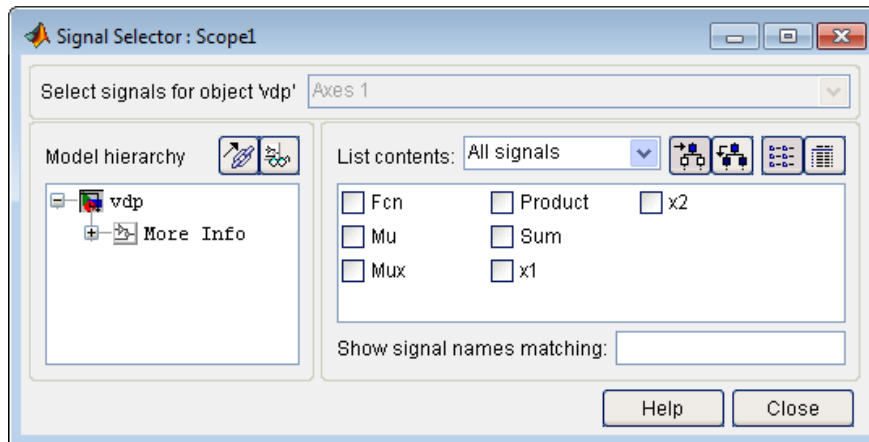

## Select Signals

This list box allows you to select the owner output port (in the case of signal generators) or display axis (in the case of viewers) to which you want to connect blocks in your model.

The list box is enabled only if the signal generator has multiple outputs or the viewer has multiple axes.

## Model Hierarchy

This tree-structured list lets you select any subsystem in your model.

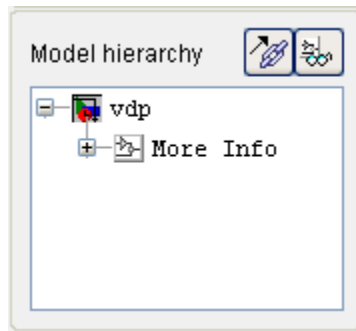

Selecting a subsystem causes the adjacent port list to display the ports available for connection in the selected subsystem. To display subsystems included as library links in your model, click the **Follow links** button at the top of the **Model hierarchy** control. To display subsystems contained by masked subsystems, click the **Look under masks** button at the top of the panel.

## Inputs/Signals List

The contents of this panel displays input ports available for connection to the Signal Selector owner if the owner is a signal generator or signals available for connection to the owner if the owner is a viewer.

If the Signal Selector owner is a signal generator, the inputs/signals list by default lists each input port in the system selected in the model hierarchy tree that is either unconnected or connected to a signal generator.

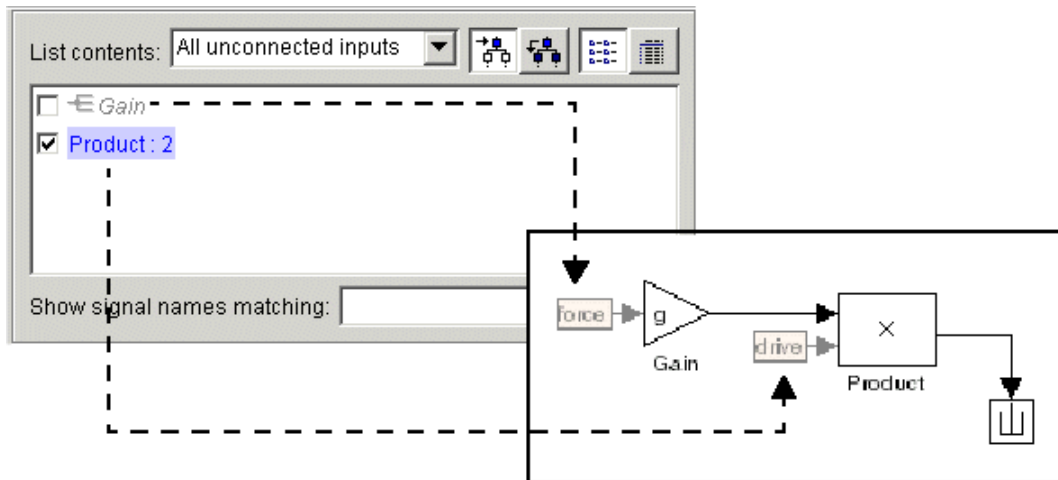

The label for each entry indicates the name of the block of which the port is an input. If the block has more than one input, the label indicates the number of the displayed port. A greyed label indicates that the port is connected to a signal generator other than the Signal Selector owner. Selecting the check box next to a port entry in the list connects the Signal Selector owner to the port, replacing, if necessary, the signal generator previously connected to the port.

To display more information on each signal, click the **Detailed view** button at the top of the pane. The detailed view shows the path and data type of each signal and whether the signal is a test point. The controls at the top and bottom of the panel let you restrict the amount of information shown in the ports list.

- To show named signals only, select **Named signals only** from the **List contents** control at the top of the pane.
- To show only signals selected in the Signal Selector, select **Selected signals only** from the **List contents** control.
- To show test point signals only, select **Testpointed/Logged signals only** from the **List contents** control.
- To show only signals whose signals match a specified string of characters, enter the characters in the **Show signals matching** control at the bottom of the **Signals** pane and press the **Enter** key.

- To show the selected types of signals for all subsystems below the currently selected subsystem in the model hierarchy, click the **Current and Below** button at the top of the **Signals** pane.

To select or clear a signal in the **Signals** pane, click its entry or use the arrow keys to move the selection highlight to the signal entry and press the **Enter** key. You can also move the selection highlight to a signal entry by typing the first few characters of its name (enough to identify it uniquely).

---

**Note** You can continue to select and clear signals on the block diagram with the Signal Selector open. For example, shift-clicking a line in the block diagram adds the corresponding signal to the set of signals that you previously selected with the Signal Selector. If the Signal Selector owner is a Floating Scope block and a simulation is running when you open the Signal Selector, Simulink updates the Signal Selector to reflect signal selection changes you have made on the block diagram. However, the changes do not appear until you select the Signal Selector window itself. You can also use the Signal Selector before running a model. If no simulation is running, selecting a signal in the model does not change the Signal Selector.

---

### See Also

Floating Scope | Scope Viewer

### Related Examples

- “Floating Scope and Scope Viewer Tasks” on page 26-69

### More About

- “Signal and Scope Manager” on page 26-77



# Control Scopes Programmatically

## In this section...

“Use Simulink Configuration Object” on page 26-85

“Scope Configuration Properties” on page 26-87

## Use Simulink Configuration Object

Use a Scope Configuration object for programmatic access to scope parameters.

- Modify the title, axis labels, and axis limits
- Turn on or off the legend or grid
- Control the number of inputs
- Change the number of displays and which display is active

In this example, the variable `myConfiguration` stores the mask object obtained using `get_param`. The example also shows how to change the value of a Scope parameter.

### Create a New Model

```
mdl='myModel';
new_system(mdl);
```

### Add Scope and Time Scope Blocks to Model

```
add_block('simulink/Sinks/Scope', [mdl '/myScope']);
add_block('dspnks4/Time Scope', [mdl '/myTimeScope']);
```

### Get a Scope Configuration Object

Many of the scope configuration properties correspond to Scope block parameters.

```
myConfiguration = get_param([mdl '/myScope'],'ScopeConfiguration')
```

```
myConfiguration =
```

```
Scope Configuration with properties:
```

```
    Name: 'myScope'
    Position: [680 390 560 420]
```

```
        Visible: 0
    OpenAtSimulationStart: 0
        DisplayFullPath: 0
    PreserveColorsForCopyToClipboard: 0
        NumInputPorts: '1'
        LayoutDimensions: [1 1]
        SampleTime: '-1'
    FrameBasedProcessing: 0
        MaximizeAxes: 'Off'
    MinimizeControls: 0
        AxesScaling: 'Manual'
    AxesScalingNumUpdates: '10'
        TimeSpan: 'Auto'
    TimeSpanOverrunAction: 'Wrap'
        TimeUnits: 'none'
    TimeDisplayOffset: '0'
        TimeAxisLabels: 'Bottom'
    ShowTimeAxisLabel: 0
        ActiveDisplay: 1
            Title: '%<SignalLabel>'
        ShowLegend: 0
        ShowGrid: 1
    PlotAsMagnitudePhase: 0
        YLimits: [-10 10]
        YLabel: ''
    DataLogging: 0
    DataLoggingVariableName: 'ScopeData'
    DataLoggingLimitDataPoints: 0
    DataLoggingMaxPoints: '5000'
    DataLoggingDecimateData: 0
    DataLoggingDecimation: '2'
    DataLoggingSaveFormat: 'Dataset'
```

### Set a Property

```
myConfiguration.DataLoggingMaxPoints = '10000';
```

### Find Scope and Time Scope Blocks

```
find_system mdl, 'LookUnderMasks', 'on', 'IncludeCommented', 'on', ...
    'AllBlocks', 'on', 'BlockType', 'Scope')
```

```
ans =
    'myModel/myScope'
```

```
'myModel/myTimeScope'
```

### Find Only Simulink Scope Blocks

```
find_system mdl, 'LookUnderMasks', 'on', 'IncludeCommented', 'on', ...  
'AllBlocks', 'on', 'BlockType', 'Scope', 'DefaultConfigurationName', ...  
'Simulink.scopes.TimeScopeBlockCfg')
```

```
ans =  
'myModel/myScope'
```

### Find Only DSP System Toolbox Time Scope Blocks

```
find_system mdl, 'LookUnderMasks', 'on', 'IncludeCommented', 'on', ...  
'AllBlocks', 'on', 'BlockType', 'Scope', 'DefaultConfigurationName', ...  
'spbscopes.TimeScopeBlockCfg')
```

```
ans =  
'myModel/myTimeScope'
```

## Scope Configuration Properties

See Scope Configuration

## See Also

Floating Scope | Scope | Scope Viewer

## Related Examples

- “Scope Tasks” on page 26-54
- “Floating Scope and Scope Viewer Tasks” on page 26-69

## More About

- “Scope Blocks and Scope Viewer Overview” on page 26-8



# Inspecting and Comparing Simulation Data

---

- “Simulation Data Inspector in Your Workflow” on page 27-2
- “Open the Simulation Data Inspector” on page 27-4
- “Log Signals to the Simulation Data Inspector” on page 27-6
- “Record Data with the Simulation Data Inspector” on page 27-10
- “Import Data” on page 27-12
- “Share Simulation Data Inspector Data and Views” on page 27-14
- “Inspect Simulation Data” on page 27-18
- “Compare Simulation Data” on page 27-27
- “Create A Simulation Data Inspector Report” on page 27-33
- “How the Simulation Data Inspector Compares Data” on page 27-35
- “Run Management and Configuration” on page 27-39
- “Customize the Simulation Data Inspector Interface” on page 27-41
- “Limitations of the Simulation Data Inspector” on page 27-57
- “Inspect and Compare Data Programmatically” on page 27-58
- “Keyboard Shortcuts for the Simulation Data Inspector” on page 27-63
- “Tune and Visualize Your Model with Dashboard Blocks” on page 27-65

## Simulation Data Inspector in Your Workflow

The Simulation Data Inspector provides the capability to inspect and compare time series data at several stages of your workflow:

- Inspect and compare simulation data while iteratively modifying the model diagram, parameter values, or configuration.
- Compare simulation outputs for different inputs when testing your model.
- Compare simulation outputs and generated code outputs.

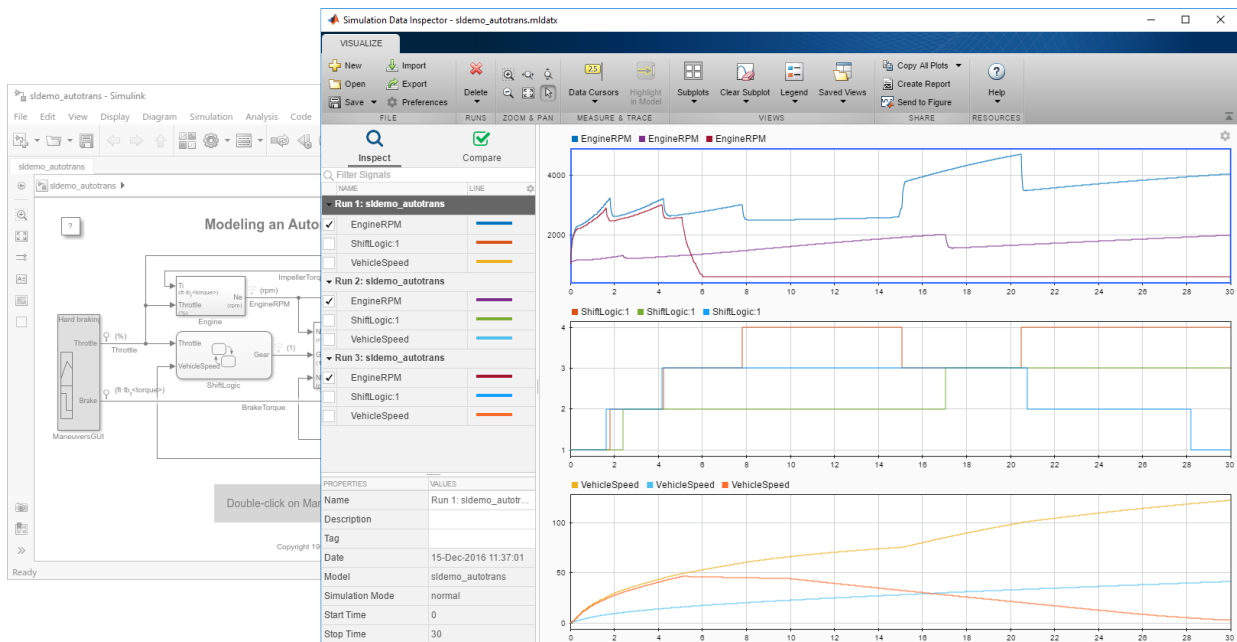

This example workflow shows how the Simulation Data Inspector fits in at several points of a design cycle:

- 1 Populate the Simulation Data Inspector with data.

Run a simulation in a model configured to log data to the Simulation Data Inspector, or import data from the workspace or a MAT-file.

- 2 Inspect the data.

View signals on multiple plots, zoom, and use data cursors to understand and evaluate the data. Customize the appearance of the Simulation Data Inspector to tell your story.

**3** Compare signals or simulation runs and apply tolerances.

The compare tools in the Simulation Data Inspector facilitate iterative design and allow you to highlight signals that do not meet tolerance requirements.

**4** Share your findings with others by saving Simulation Data Inspector data and views.

You can also harness the capabilities of the Simulation Data Inspector from the command line. For more information, see “Inspect and Compare Data Programmatically” on page 27-58.

## **Related Examples**

- “Log Signals to the Simulation Data Inspector” on page 27-6

## Open the Simulation Data Inspector

To open the Simulation Data Inspector, you can choose from several methods:

- Click the **Simulation Data Inspector** button on the Simulink editor toolbar.



- Click the **Simulation Data Inspector** drop-down and select **Simulation Data Inspector**.

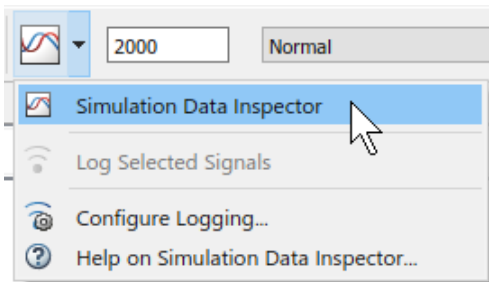

- Right-click the badge above a signal marked for logging  and select **Open Data Inspector**.
- Enter `Simulink.sdi.view` in the MATLAB Command Window.

## Why Is the Simulation Data Inspector Empty?

The Simulation Data Inspector is empty when it does not have data to plot. To populate the Simulation Data Inspector with data, you can:

- Select signals to log, and simulate your model, as described in “Log Signals to the Simulation Data Inspector” on page 27-6.
- Enable recording for logged data and simulate your model, as described in “Record Data with the Simulation Data Inspector” on page 27-10.
- Import data from the base workspace or a MAT-file, as described in “Import Data” on page 27-12 .

For a discussion of data formats supported by the Simulation Data Inspector, see “Limitations of the Simulation Data Inspector” on page 27-57.



## **Related Examples**

- “Inspect Simulation Data” on page 27-18

## Log Signals to the Simulation Data Inspector

The Simulation Data Inspector facilitates iterative debugging and optimization by providing fast and easy access to visualizations of logged data. By default, Simulink sends data for logged signals to the workspace and directly to Simulation Data Inspector. To select signals to log:

- 1 Select one or more signals in the model.
- 2 On the Simulink Editor toolbar, click the **Simulation Data Inspector** drop-down and select **Log Selected Signals**.

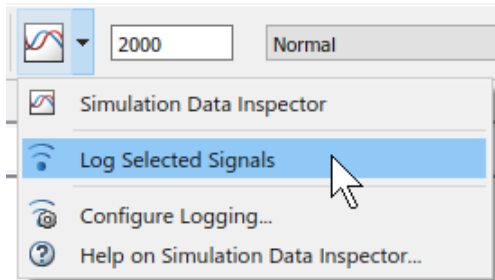

The logging badge  marks logged signals in the model.

Alternatively, you can select signals to log using one of the several methods described in “Mark a Signal for Logging” on page 59-73

---

**Tip:** For models with complex hierarchy and many signals of interest, the Model Data Editor can facilitate locating and selecting signals to log. See “Configure Data Properties by Using a Table” on page 57-123 for more information about the Model Data Editor.

---

With the Simulation Data Inspector, you can view logged signals while simulations run. To view the signals marked for logging:

- 1 Open the Simulation Data Inspector by clicking the **Simulation Data Inspector** button.
- 2 Simulate the model.

A new simulation run appears in the **Inspect** pane.

- 3 Select the check box next to the signal you want to view in the plot. For example, this plot shows the `ego` signal from the `sldemo_fuelsys` model.

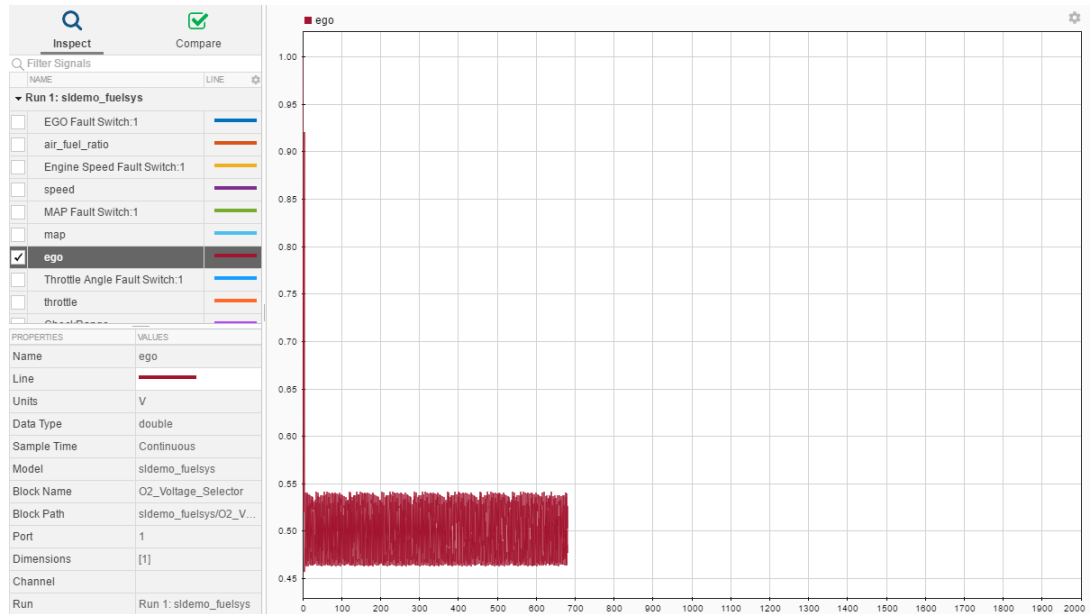

To stop logging a signal, right-click the signal in the model and select **Stop Logging Selected Signals**. Alternatively, you can select one or more signals and then select **Stop Logging Selected Signals** from the **Simulation Data Inspector** drop-down on the Simulink Editor toolbar. The logging badge disappears from the signals.

If the simulation mode is set to **Normal**, you can log signals from within reference models.

You can configure your model to log signals only to Simulation Data Inspector. To stop logging signal data to the workspace, clear the **Signal Logging** check box in the **Data Import/Export** section of the **Model Configuration Parameters**.

## Iterate Model Design with the Simulation Data Inspector

You can use the Simulation Data Inspector to view data from your model during simulation and quickly optimize model parameters. **Overwrite Run** mode and **Data Cursors** support iterative model and parameter optimization with the Simulation Data

Inspector. **Overwrite Run** mode helps prevent clutter, while **Data Cursors** facilitate quick and easy inspection of simulation data.

In **Overwrite Run** mode, the Simulation Data Inspector clears the data in the run at the start of a new simulation and replaces it with new data. Using run overwrite mode reduces the accumulation of runs in the **Inspect** pane. To enable **Overwrite Run** mode, right-click the run and select **Overwrite Run**. The overwrite symbol next to the run indicates that **Overwrite Run** mode is on.

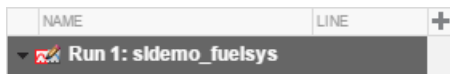

The Simulation Data Inspector plots incoming data for plotted signals while the new simulation runs. The run remains in **Overwrite Run** mode until you disable it. To disable **Overwrite Run** mode, right-click the run in the **Inspect** pane and clear the **Overwrite Run** check box.

**Data Cursors** in the Simulation Data Inspector facilitate close examination of signals throughout design iteration. You can add a data cursor to the plot during simulation, while a simulation is paused, or after the simulation has finished. To add a data cursor, click **Data Cursors**. Drag the data cursor around to inspect signal values.

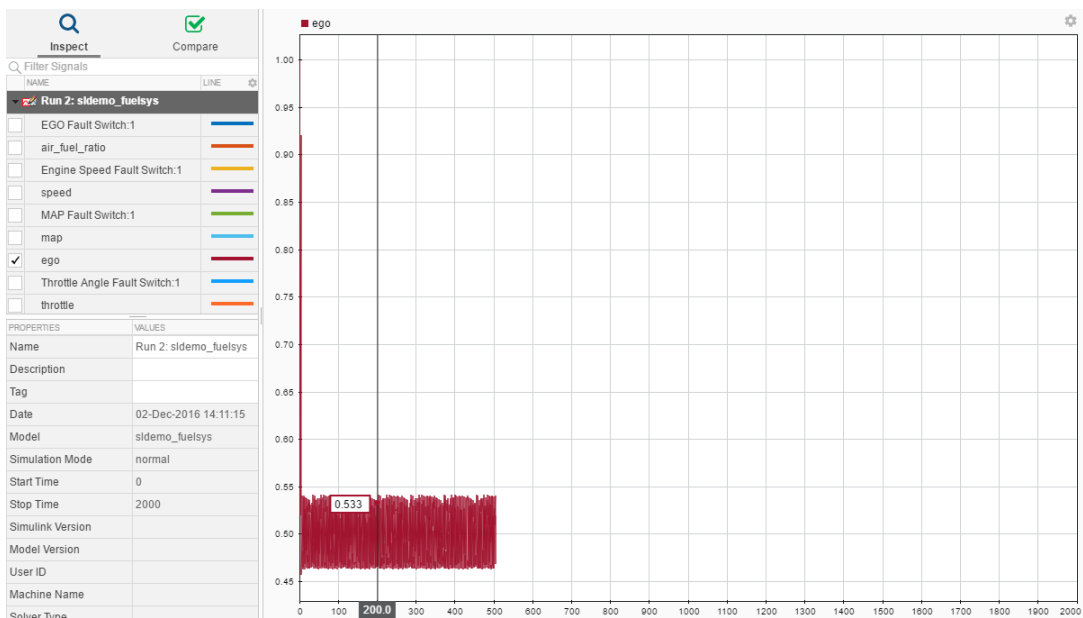

## **Related Examples**

- “Inspect Simulation Data” on page 27-18
- “Record Data with the Simulation Data Inspector” on page 27-10

## Record Data with the Simulation Data Inspector

Some logged data does not log directly into the Simulation Data Inspector and can be recorded instead. Recorded data is accumulated during simulation and then automatically imported into the Simulation Data Inspector when the simulation completes.

### Configure Your Model to Record Data

Signals must be logged to the workspace to record them with the Simulation Data Inspector. To configure logged workspace data for recording:

- 1 Click the **Simulation Data Inspector** drop-down on the Simulink Editor toolbar and select **Configure Logging**.

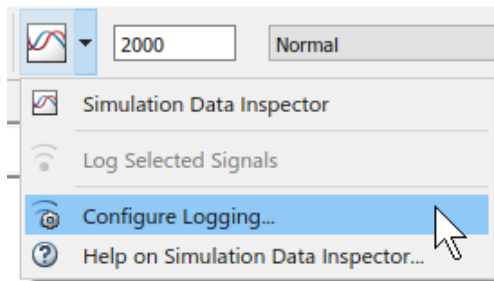

The **Data Import/Export** pane of the Configuration Parameters dialog box opens.

- 2 In the **Data Import/Export** pane, mark the check box labeled **Record logged workspace data in Simulation Data Inspector**.

---

**Note:** To record **States** and **Outputs**, **Dataset** is the recommended **Format**. You can also set **Format** to **Structure with time** or **Array**. If **Format** is configured as **Array**, you must also log **Time** for **States** and **Outputs** to record to the Simulation Data Inspector.

---

- 3 Click **OK**.

To disable recording, navigate back to the **Data Import/Export** pane of the Configuration Parameters dialog box and clear the check box labeled **Record logged workspace data in Simulation Data Inspector**.

## Record a Run

Once you have configured your model to record data, simulate the model to record a run.

- 1 Open the Simulation Data Inspector by clicking the **Simulation Data Inspector** button on the Simulink Editor toolbar.



- 2 To record data, simulate the model.

When the simulation completes, the **Simulation Data Inspector** button appears highlighted to indicate that new simulation data is available in the Simulation Data Inspector.



## Related Examples

- “Inspect Simulation Data” on page 27-18
- “Share Simulation Data Inspector Data and Views” on page 27-14
- “Overwrite a Run” on page 27-40

## Import Data

You can import data from the base workspace or a MAT-file into the Simulation Data Inspector for inspection and analysis.

To import data into the Simulation Data Inspector:

- 1 Click **Import** on the **Visualize** tab.
- 2 Select the origin of your data as either **Base workspace** or **MAT-file**.

Data available for import populates the table when the source is specified. Here, data from the base workspace is shown.

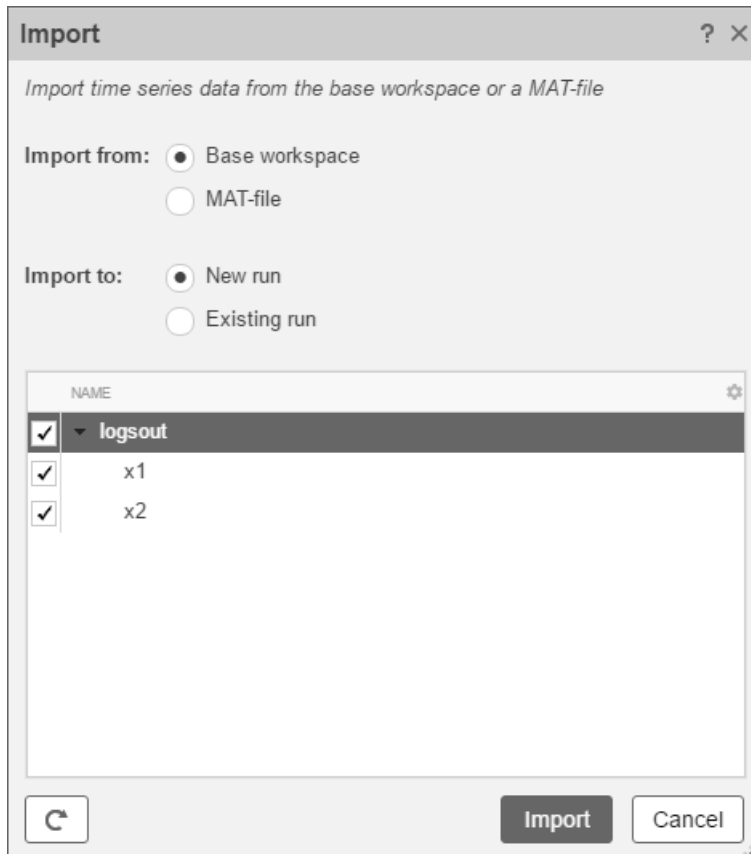



- 3 Select whether you would like to import the data as a new run or to an existing run. When you select the **Existing run** option, the Simulation Data Inspector adds the data to the existing run without overwriting any existing signals.
- 4 Mark the check boxes next to the signals you would like to import into the Simulation Data Inspector.
- 5 Click **Import**.

The imported signals appear in the **Inspect** pane as a new run or as new signals appended to the specified existing run.

### Related Examples

- “Inspect Simulation Data” on page 27-18
- “Share Simulation Data Inspector Data and Views” on page 27-14

## Share Simulation Data Inspector Data and Views

### In this section...

“Save and Load Simulation Data Inspector Sessions” on page 27-14

“Export Data from the Simulation Data Inspector” on page 27-15

“Share Simulation Data Inspector Data Views” on page 27-16

“Create Images of Plots” on page 27-16

“Create MATLAB Figures” on page 27-17

After you inspect, analyze, or compare your data in the Simulation Data Inspector, you can share the results with others. You can share plots as images or MATLAB figures. You can save the Simulation Data Inspector layout as a view, and you can save a session, including both the view and the data.

### Save and Load Simulation Data Inspector Sessions

If you want to archive or share data along with a configured view in the Simulation Data Inspector, save the Simulation Data Inspector session. When you save a Simulation Data Inspector session, the MLDATX-file contains:

- All runs, data, and properties from the **Inspect** pane
- Plot display selection for signals in the **Inspect** pane
- Subplot layout and line style and color selections

---

**Note:** Comparison runs and global tolerances are not saved in Simulation Data Inspector sessions.

---

To save a Simulation Data Inspector session, click the **Save** button on the **Visualize** tab. In the **Save** dialog box, name the file and browse to the location where you want to save the session. Save sessions as MLDATX-files. A status overlay at the bottom-right of the graphical viewing area displays information about the save operation and allows you to cancel at any time.

To load a Simulation Data Inspector session, click **Open** on the **Visualize** tab. In the **Open** dialog box, browse to select the desired MLDATX-file, then click **Open**.

Alternatively, you can double-click the MLDATX-file to launch MATLAB and the Simulation Data Inspector if they are not already open.

## Export Data from the Simulation Data Inspector

You can use the Simulation Data Inspector to export data from the **Inspect** or **Compare** panes to the base workspace or a MAT-file. You can only export data from one pane at a time. When you export data from the Simulation Data Inspector, the MAT-file contains the signal data and names and the interpolation method used to plot the signals. If you export multiple signals, the Simulation Data Inspector also saves the block path and port index for each signal. To export data:

- 1 Select all the signals you want to export on either the **Inspect** or **Compare** pane.

Only selected runs and signals are exported. In this example, only the x1 signals from Run 1 and Run 2 are exported. The check box selection does not affect whether a signal is exported.

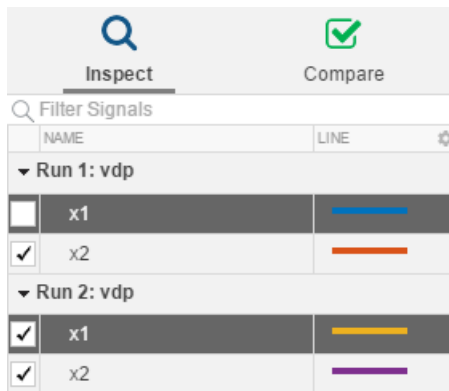

- 2 Either right-click a signal and select **Export Data** or click the **Export** button.
- 3 In the Export dialog box, choose whether to export the selected data to the base workspace or a MAT-file.

If you export the data to a MAT-file, you can specify the name and path for the MAT-file.

- 4 Click **Export**.

## Share Simulation Data Inspector Data Views

When you have different sets of data that you would like to visualize in the same way, you can save a view with the Simulation Data Inspector. A view saves the layout and appearance characteristics of the Simulation Data Inspector without saving any of the data. Specifically, a view saves:

- Plot layout, axis ranges, linking characteristics, normalized axes
- Location of signals in the plots
- Signal grouping and columns on display in the **Inspect** pane
- Signal color and line styling

To save a view:

- 1 Click the **Saved Views** drop-down arrow.
- 2 Select **Save View**.
- 3 In the dialog box, specify a name for the view and browse to the location where you would like to save the MLDATX-file.
- 4 Click **Save**.

To load a view:

- 1 Click the **Saved Views** drop-down arrow.
- 2 Select **Load View**.
- 3 Browse to the view you would like to load.
- 4 Click **Open**.

## Create Images of Plots

You can copy the plots you make in the Simulation Data Inspector and paste them into other programs to generate images. To copy a single plot image, click the drop-down arrow on the **Copy All Plots** button and select **Copy Plot**. The image is copied to your clipboard, so you can paste the image into another program, such as Microsoft PowerPoint® or Microsoft Word. Alternatively, you can right-click the plot and select **Copy Plot**.

If you want to copy an image that includes all the plots displayed in the Simulation Data Inspector, click the **Copy All Plots** button.

## Create MATLAB Figures

You can send plots generated in the Simulation Data Inspector to a MATLAB figure with the **Send to Figure** button. The **Send to Figure** button sends all the plots displayed in the Simulation Data Inspector to a MATLAB figure. You can use the MATLAB figure tools to customize the appearance of the figure to fit your needs.

For more information on plotting and customizing your MATLAB data plots, see “Types of MATLAB Plots” (MATLAB).

## Related Examples

- “Create A Simulation Data Inspector Report” on page 27-33

## Inspect Simulation Data

Using the Simulation Data Inspector, you can view and inspect signals from simulations or from imported data. The Simulation Data Inspector provides a comprehensive view of your data by allowing you to group data from multiple simulations on multiple plots. You can also use data cursors for close examination of signal values.

These examples show you how to view and inspect signal data using the Simulation Data Inspector using the `slexAircraftExample` model.

### Log and View Signals

This example uses signal logging to send data to the Simulation Data Inspector. You can also record logged simulation data or import signal data from the base workspace or a MAT-file. For more information, see “Record Data with the Simulation Data Inspector” on page 27-10 and “Import Data” on page 27-12 .

- 1 To open the model, enter `slexAircraftExample` in the MATLAB Command Window.
- 2 To log `q`, `rad/sec`, `Stick`, and `alpha`, `rad` to the Simulation Data Inspector, select each signal in the model. Then, click the **Simulation Data Inspector** drop-down, and select **Log Selected Signals**.

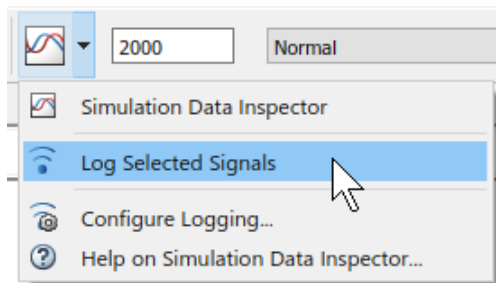

The logging badge  appears above each signal marked for logging.

- 3 Double-click the Pilot block. Set **Wave form** to `sine`, and click **OK**.
- 4 In the Simulink Editor, click the **Simulation Data Inspector** button to open the Simulation Data Inspector.
- 5 Simulate the model. A new run appears in the Simulation Data Inspector.

By default, the **Inspect** pane lists all logged signals in rows, organized by simulation run. You can expand or collapse any of the runs to view the signals in a run. For more information on signal grouping, see “Customize the Simulation Data Inspector Interface” on page 27-41.

- 6 Select the check boxes next to the **q**, **rad/sec**, **Stick**, and **alpha**, **rad** signals to plot them in the graphical viewing area.

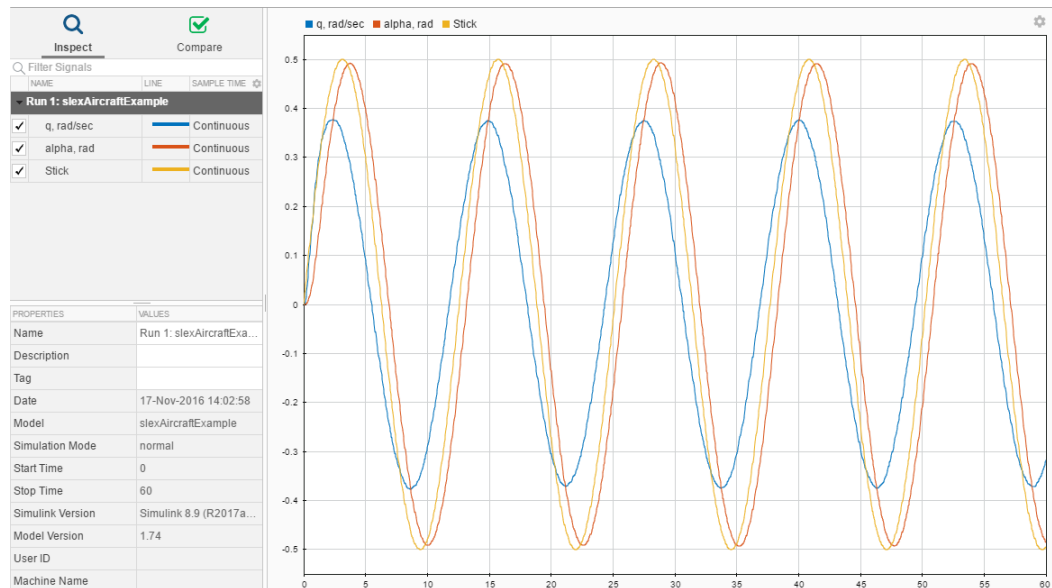

## Explore Simulation Data

In the Simulation Data Inspector, you can inspect signals using data cursors.

- 1 On the **Visualize** tab, click the **Data Cursors** button to add one data cursor to the plot.

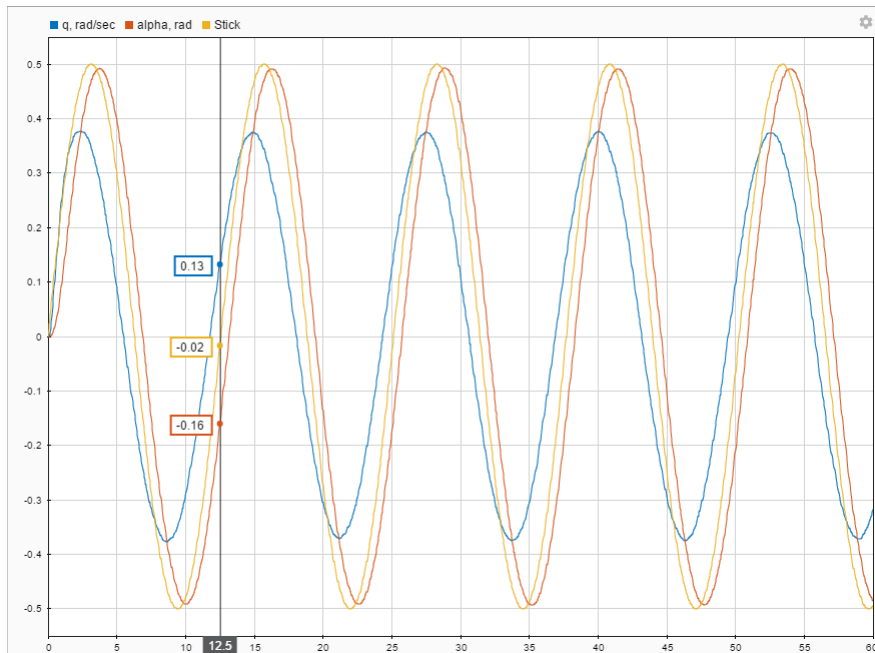

- 2 Drag the data cursor left or right to a point of interest. You can also use the arrow keys to move the data cursor.

To inspect the data at a specific point in time, click the data cursor time field and enter the desired time value, for example 40.33.

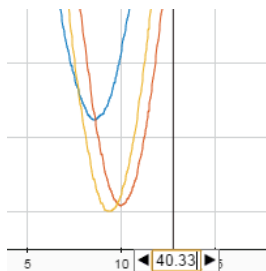

If the signal does not have a sample value at the point of interest, the Simulation Data Inspector linearly interpolates the value for the indicated time. An asterisk in the data cursor label indicates that the value is interpolated.



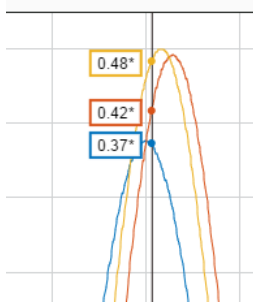

- 3 When you have finished inspecting the data, click the **Data Cursors** arrow

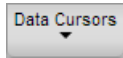

and select **Hide** to remove the cursor from the graphical viewing area.

## View Signals on Multiple Plots

You can use subplot layouts to view groups of signals on different subplots. For example, you can group the same signal from different simulation runs or group signals that have a similar range of values.

- 1 In the model, double-click the Pilot block. Set **Wave form** to **square**, and click **OK**.
- 2 Simulate the model.
- 3 In the Simulation Data Inspector, on the **Visualize** tab, click **Subplots** and select a 3×1 arrangement.
- 4 Click the middle subplot in the graphical viewing area. In the **Inspect** pane, select the check boxes for the **q**, **rad/sec**, **Stick**, and **alpha**, **rad** signals under **Run 2**.

The check boxes in the **Inspect** pane indicate the signals plotted in the selected subplot, which is outlined in blue.

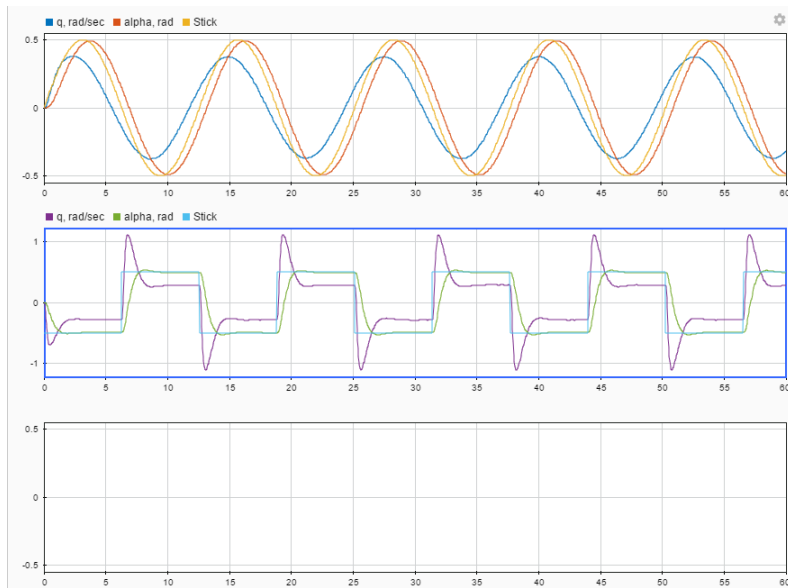

### Move Signals Between Plots

You can also move plotted signals to other subplots graphically, rather than using the check boxes.

- 1 Select the signal you want to move.
- 2 Drag the signal to the plot where you would like to see it.

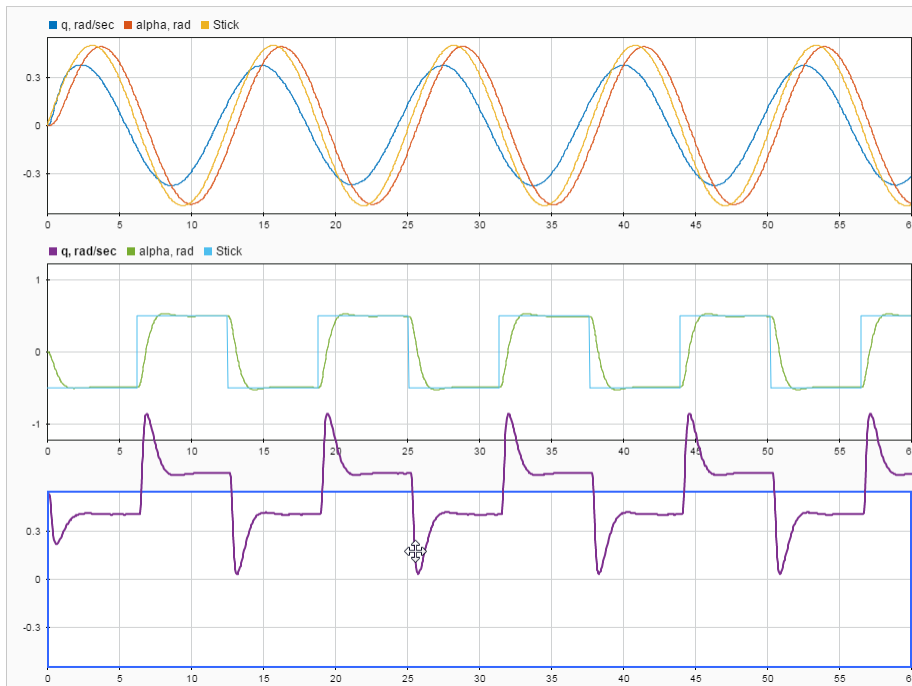

For more information on working with plots, see “Modify a Plot in the Simulation Data Inspector” on page 27-54.

### Linked Subplots

Subplots are linked by default, meaning that all plots in the graphical viewing area stay synchronized when you pan and zoom. Linked plots have a synchronized response when you:

- Click a plot and drag to pan
- Perform any zoom operation
- Fit to view

To pan and zoom independently in a subplot, you can unlink the subplot.

- 1 Select the subplot you want to unlink.
- 2 Click the settings button in the upper right of the graph.

- On the **More** tab, click the check box labeled **Link Subplot**.

The broken link symbol  appears on the unlinked subplot.

## Filter Runs and Signals

You can filter runs and signals displayed in the **Inspect** pane to help search through large amounts of data in the Simulation Data Inspector. You can filter the data by text contained in the run or signal names and properties.

To show only the `alpha, rad` signals, type `alpha` into the filter signals text box. Matches for the search criteria are highlighted in the filter results displayed in the pane. The filter dialog box suggests completions for the text typed into the search query.

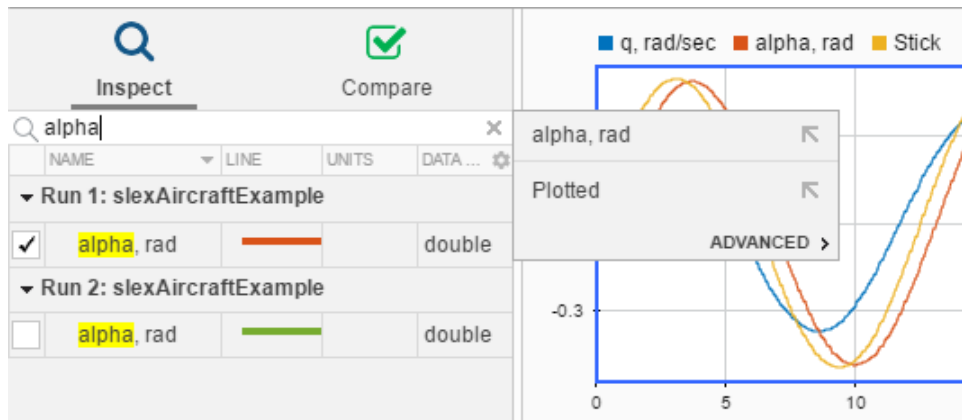

NAME	LINE	UNITS	DATA ...
▼ Run 1: slexAircraftExample			
<input checked="" type="checkbox"/>	alpha, rad	—	double
▼ Run 2: slexAircraftExample			
<input type="checkbox"/>	alpha, rad	—	double

To filter for a signal or run property, use colons to separate the property name and filter value. For example, `port : 1` filters for signals that use port 1 in the model. Because the property column is not visible in the **Inspect** pane, the result is not highlighted.

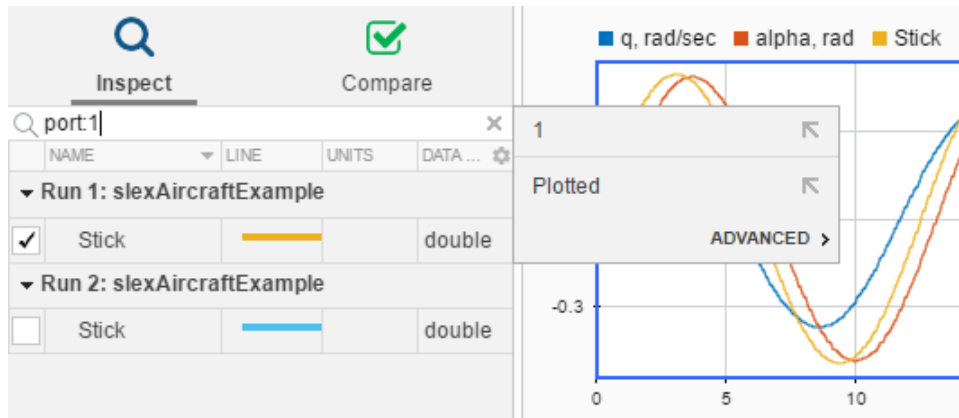

You can also construct more complicated filter queries that include multiple properties using the **Advanced** section of the filter dialog box.

- 1 Open the **Advanced** section of the filter dialog box.
- 2 Select a column to add to the filter, and enter the value.

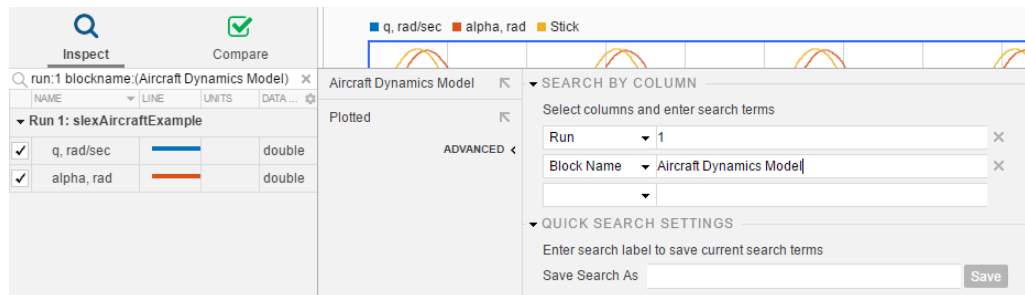

**Note:** Filters work by matching text. For example, an absolute tolerance filter for a value of `00.1` does not return signals with an absolute tolerance of `0.1`.

For convenience, you can save filter configurations. To save the filter, enter a name in the **Save Search As** box and click **Save** on the filter dialog box. Saved filters show as options in the filter list.

## Inspect Event-Based Data

Simulation Data Inspector visualizes data from event-based systems with stem plots. To plot event-based or message data, mark the signal for logging. When you simulate the model, the data appears in the Simulation Data Inspector as a stem plot for each event.

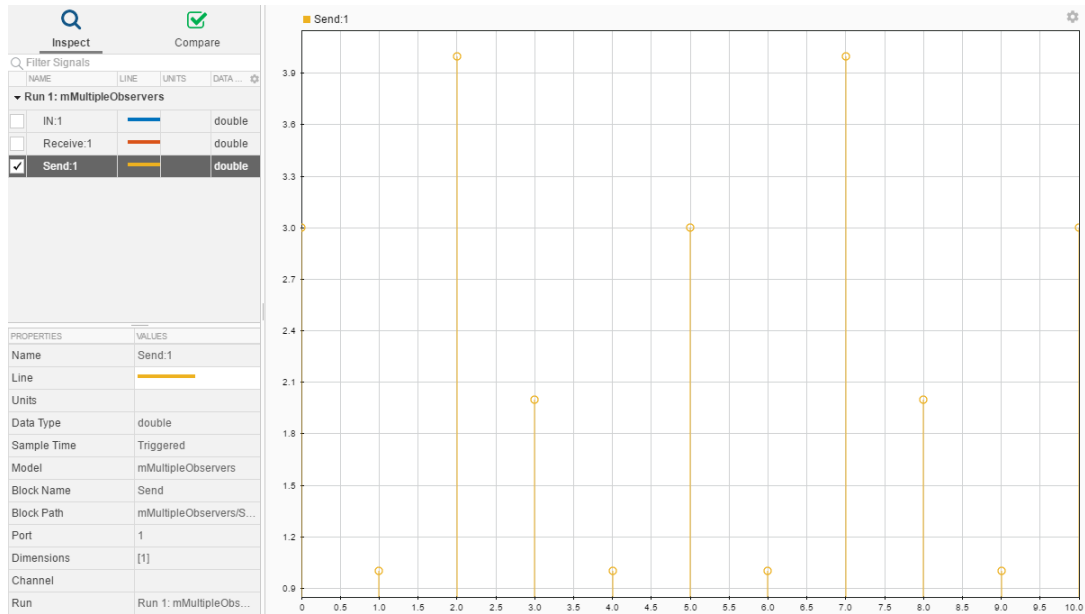

## Related Examples

- “Compare Simulation Data” on page 27-27
- “Share Simulation Data Inspector Data and Views” on page 27-14
- “Overwrite a Run” on page 27-40

## Compare Simulation Data

The Simulation Data Inspector can compare runs and individual signals. This example is a continuation of the workflow described in “Inspect Simulation Data” on page 27-18.

### Compare Signals

This example compares the `Stick` input signal to the output observed at `alpha, rad` and uses the tolerance feature in the Simulation Data Inspector to analyze the result.

To compare the `alpha, rad` signal to the `Stick` signal:

- 1 In the **Inspect** pane, right-click `Stick` under `Run 1` and select **Compare Signals > Set as Baseline**.
- 2 Right-click `alpha, rad` and select **Compare Signals > Set as Compare To**.
- 3 Switch to the **Compare** pane, and click the **Compare** button.

Baseline:	Stick (Run 1: slxAircraftExample ▾)	Global Abs Tolerance:	<input type="text" value="0"/>	Global Time Tolerance:	<input type="text" value="0"/>	<b>Compare</b>
Compare to:	alpha, rad (Run 1: slxAircraftExa ▾)	Global Rel Tolerance:	<input type="text" value="0"/>			

Here, the `alpha, rad` and `Stick` signals are compared from `Run 1`. The comparison fails because the signals do not match within the absolute and relative tolerances, both specified as 0 by default.

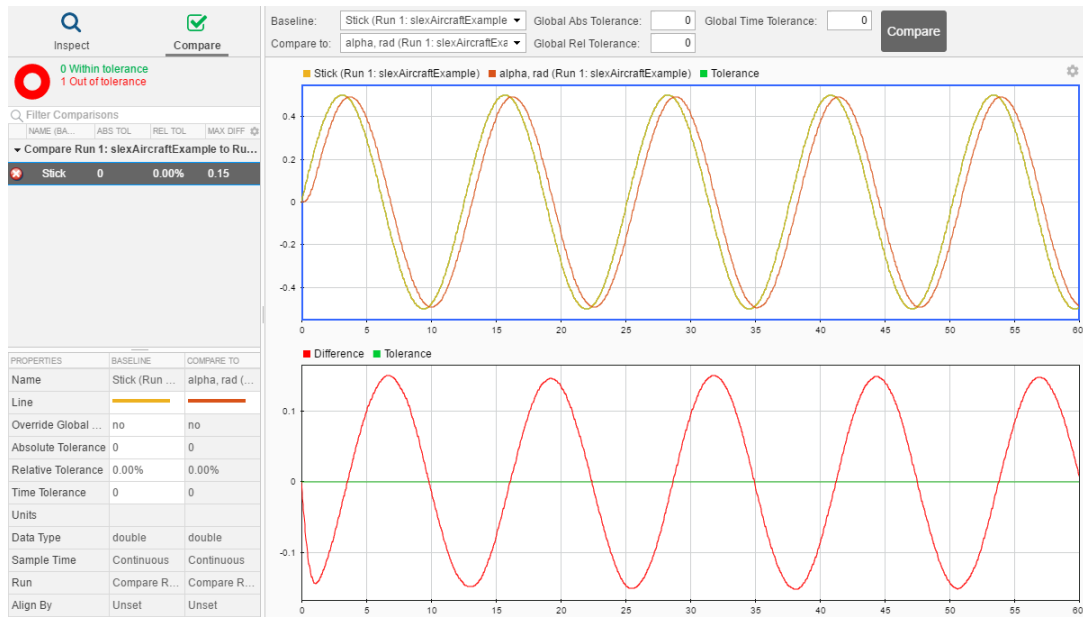

From a visual inspection of the signals, you can see `alpha, rad` lags `Stick`. Add a time tolerance to the `Stick` signal.

- 1 In the properties pane, click the **Override Global Tolerance** baseline value field, and select **yes** from the drop-down.

When the **Override Global Tolerance** field is set to **yes**, the tolerance values specified in the signal properties are applied instead of the global tolerances specified above the graphical viewing area.

- 2 Type `0.5` into the **Time Tolerance** field in the properties pane to the left of the graphical viewing area.

The comparison automatically runs again, with the updated tolerance value.

The Simulation Data Inspector draws the tolerance band around the plotted **Baseline** signal and around the signed difference signal displayed in the bottom subplot.



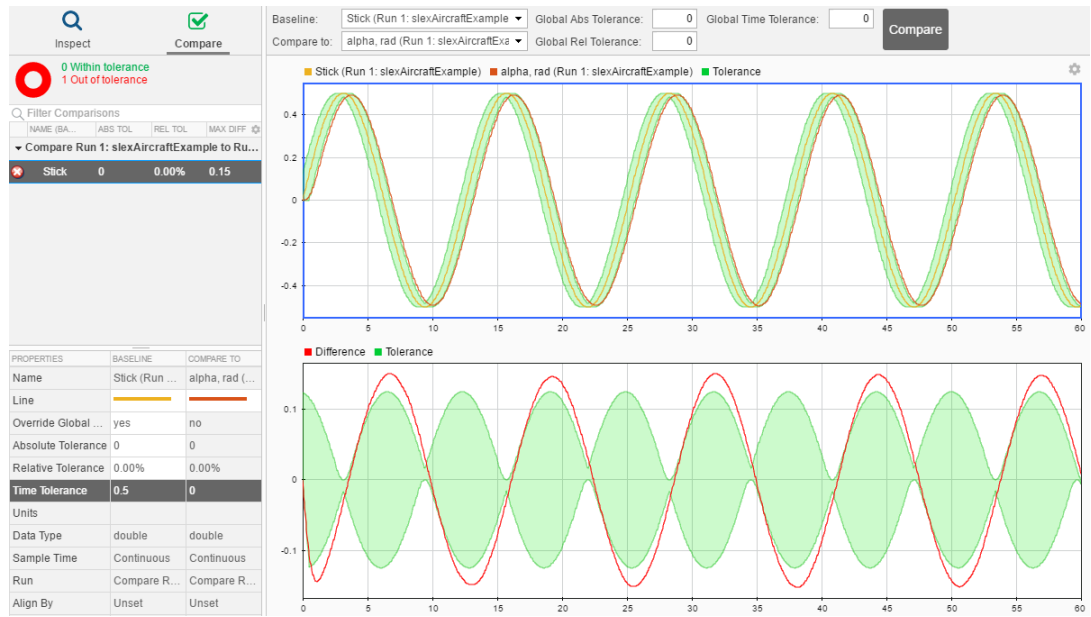

**Note:** The Simulation Data Inspector operates with the most lenient interpretation of the specified tolerances. For more information on tolerances, see “Tolerances in the Simulation Data Inspector” on page 27-37.

The time tolerance covers the phase difference between the two signals, but the comparison still does not pass due to the amplitude difference. To add an absolute tolerance to the **Stick** signal, type **0.05** into the **Absolute Tolerance** field in the properties pane.

With the combination of the absolute and time tolerances, the signal comparison passes.

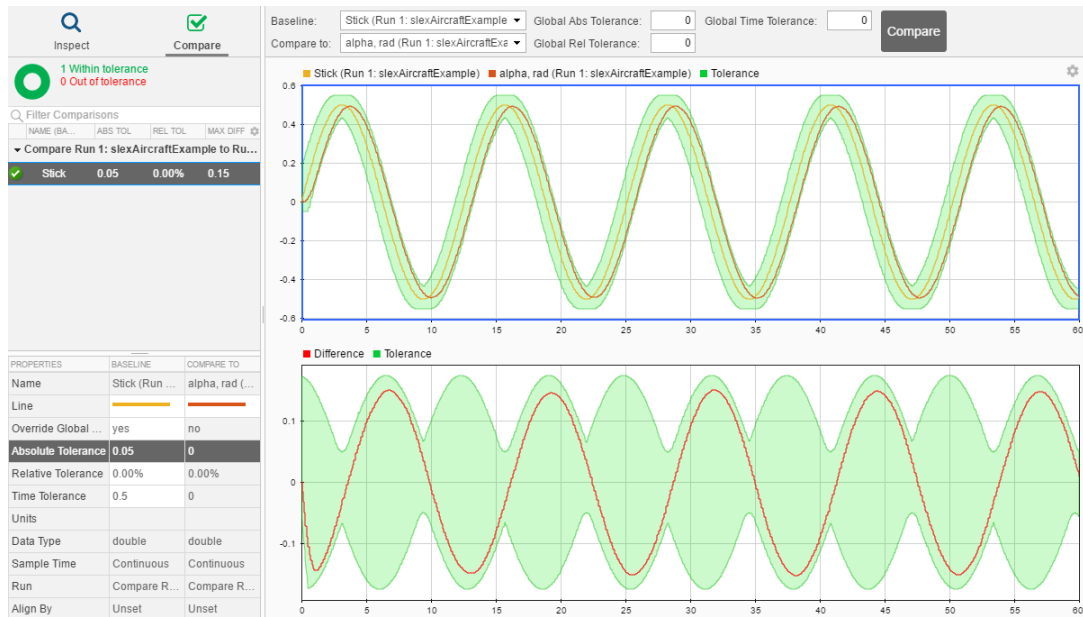

## Compare Runs

You can also use the Simulation Data Inspector to compare all logged signals in a model at once by comparing runs. Run comparisons provide useful information about the effects of changing model parameters. For example, change the frequency cutoff of the filter for the control stick input signal. Then, evaluate the effect on the output signal with the Simulation Data Inspector.

- 1 Click the **Model Explorer** button  to access the **Model Workspace** variables.
- 2 Change the value of **TS** in the **Model Workspace** from 0.1 to 1.
- 3 Close the **Model Explorer**.
- 4 Simulate the model with the new filter.
- 5 In the Simulation Data Inspector, click **Compare** to switch to the **Compare** pane.
- 6 Select **Run 2: slxAircraftExample** in the **Baseline** drop-down menu.
- 7 Select **Run 3: slxAircraftExample** in the **Compare To** drop-down menu.
- 8 Click **Compare**.

The **Compare** pane lists all signals from the runs with a comparison result. In this example, the comparison results of the aligned signals do not match. The signal differences are not within the acceptable specified tolerance values, all of which are set to zero.

0 Within tolerance  
3 Out of tolerance

Filter Comparisons

	NAME (BASE)	ABS TOL	REL TOL	MAX DIFF	
▼	Compare Run 3: slxAircraftExample to Run 2: sl...				
✘	q, rad/sec	0	0.00%	1.00	
✘	alpha, rad	0	0.00%	0.49	
✘	Stick	0	0.00%	0.78	

---

**Note:** The Simulation Data Inspector only compares signals from the **Baseline** run that align with a signal from the **Compare To** run. If a signal from the **Baseline** run does not align with a signal from the **Compare To** run, the signal is listed in the **Compare** pane with a warning. . For more information on signal alignment, see “Signal Alignment in the Simulation Data Inspector” on page 27-35.

---

To plot comparison data, select the signal you want to see in the **Compare** pane. Here, the top plot shows the  $q$ , rad/sec signals from the **Baseline** and **Compare To** runs. The bottom plot shows the difference between the signals and a graphical representation of the tolerance. For information on manipulating the plot, see “Customize the Simulation Data Inspector Interface” on page 27-41.

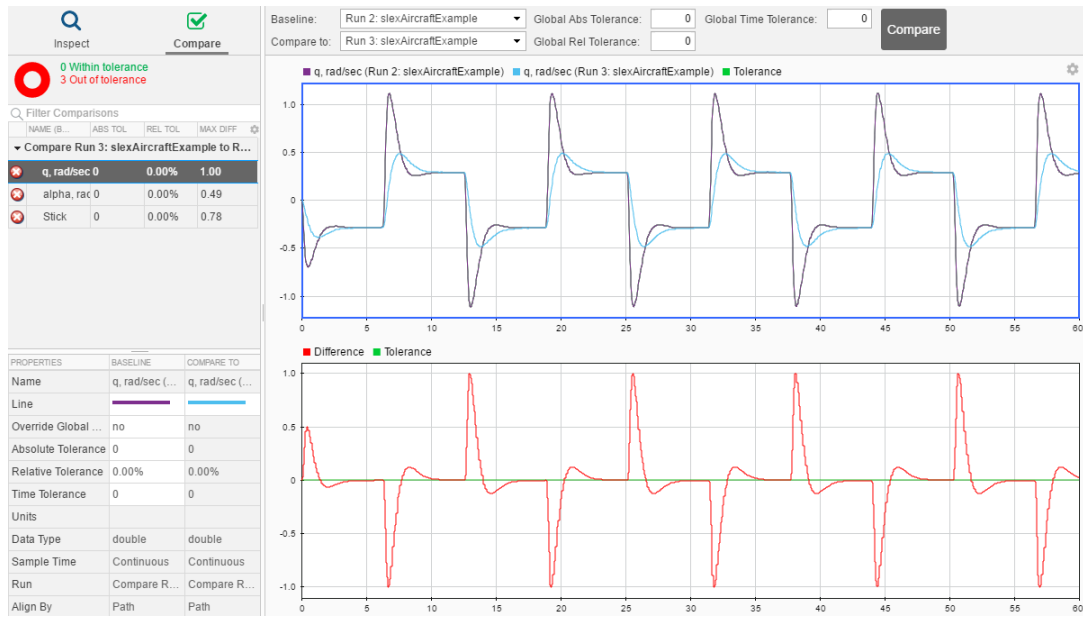

To qualify signals in the run comparison, you can add global tolerances to the comparison using the global tolerance fields above the graphical viewing area. Enter one or more desired tolerance values, then hit the **Compare** button to run the comparison again and compare the results against the tolerance values. The Simulation Data Inspector draws the tolerance band around the **Baseline** signal and on the signed difference plot on the lower half of the graphical viewing area. To apply different tolerance values to specific signals, set the **Override Global Tolerance** property to **yes** and specify the desired tolerance values in the signal properties.

## Related Examples

- “Inspect Simulation Data” on page 27-18
- “Create A Simulation Data Inspector Report” on page 27-33

## Create A Simulation Data Inspector Report

You can create a Simulation Data Inspector report of your data in either the **Inspect** or **Compare** pane. The report is an HTML file that includes information about all the signals in the active pane and all the plots. To generate a Simulation Data Inspector Report:

- 1 In the Simulation Data Inspector, click **Create Report**.

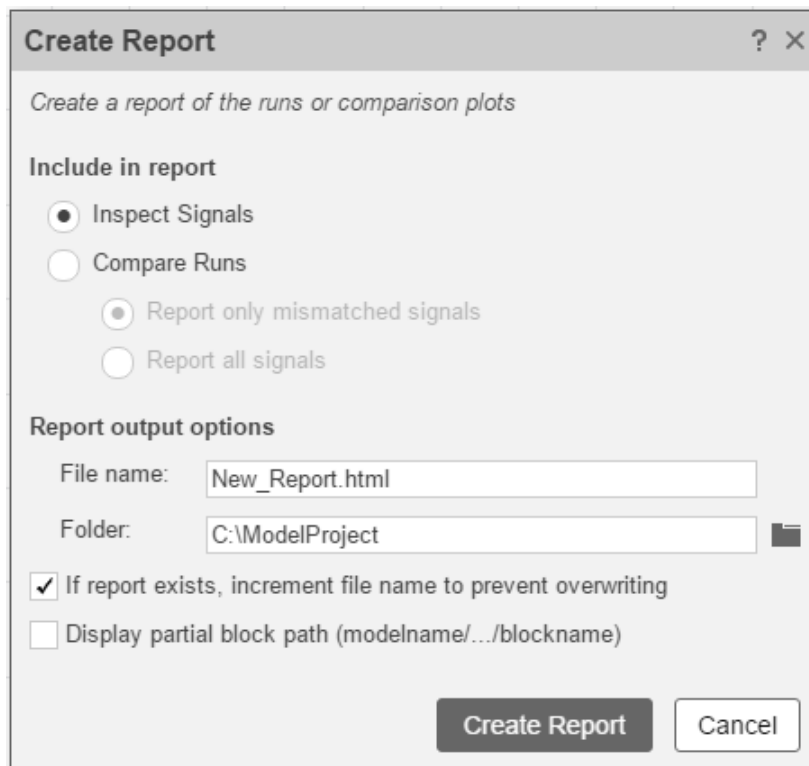

- 2 Under **Include in report**, specify the type of report you would like to create.
  - Select **Inspect Signals** to include the plots and signals from the **Inspect** pane.
  - Select **Compare Runs** to include the data and plots from the **Compare** pane. When you generate a **Compare Runs** report, you can choose to **Report only mismatched signals** or to **Report all signals**. If you select **Report only**

**mismatched signals**, the report shows only signal comparisons that are not within the specified tolerances.

- 3** Specify **File name** the report and navigate to the **Folder** where you want to save it.
- 4** Click **Create Report**.

The generated report automatically opens in your default browser.

### **Related Examples**

- “Share Simulation Data Inspector Data and Views” on page 27-14

## How the Simulation Data Inspector Compares Data

You can tailor the Simulation Data Inspector comparison process to fit your requirements in multiple ways. When comparing runs, the Simulation Data Inspector:

- 1 Aligns signal pairs in the **Baseline** and **Compare To** runs based on the **Alignment** settings.



The Simulation Data Inspector does not compare signals that it cannot align.

- 2 Synchronizes aligned signal pairs according to the specified **Sync Method**.

Interpolates data in signal pairs as specified by the **Interpolation Method**.

- 3 Computes the difference of the signal pairs.
- 4 Compares the difference result against specified tolerances.

When the comparison run completes, the results of the comparison are added in the navigation pane.

Status	Comparison Result
	<ul style="list-style-type: none"> <li>• Signal aligns.</li> <li>• Data from two runs falls within the tolerance.</li> </ul>
	<ul style="list-style-type: none"> <li>• Signal aligns.</li> <li>• Data from two runs does not fall within the tolerance.</li> </ul>
	Signal from <b>Baseline</b> does not align with a signal from <b>Compare To</b> .

When you compare signals of different lengths, the Simulation Data Inspector compares the signals on their overlapping interval.

### Signal Alignment in the Simulation Data Inspector

The first step in a comparison is to align the signals, or, decide which signals in the **Baseline** and **Compare To** runs the Simulation Data Inspector should compare to each

other. When you compare signals with the Simulation Data Inspector, you complete the alignment step by selecting the **Baseline** and **Compare To** signals.

The Simulation Data Inspector aligns signals using signal properties. In the **Alignment** tab of the **Preferences** window, you can specify the priority order for each of the signal properties used for alignment. The **Align By** field specifies the highest priority property. The priority drops with each subsequent **Then By** field. You must specify a primary alignment property in the **Align By** field, but you can leave any number of the **Then By** fields blank.

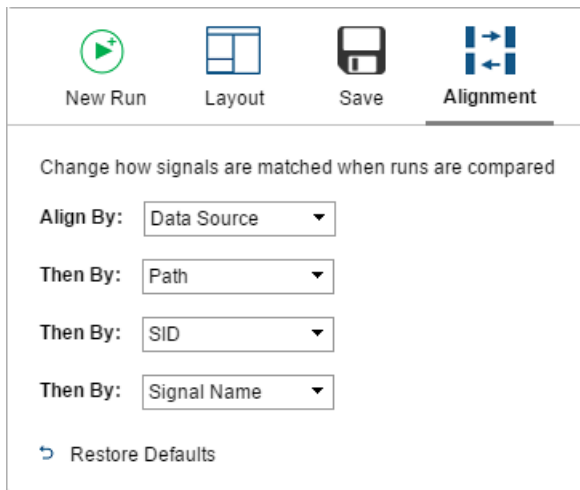

From each drop-down, you can select **Data Source**, **Path**, **SID**, or **Signal Name**. By default, the Simulation Data Inspector is configured to first align signals by data source, then by path, then by SID, and then by signal name. For more information on how to change alignment settings, see “Modify Signal Alignment for Comparisons” on page 27-51.

Property	Description
Data Source	Path of the variable in the MATLAB workspace for data imported from the workspace
Path	Block path for the source of the data in the model



Property	Description
SID	Numeric signal identifier  For more information about SIDs, see “Locate Diagram Components Using Simulink Identifiers” on page 1-19
Signal Name	Name of the signal in the model

## Synchronization Options in the Simulation Data Inspector

You can choose how the Simulation Data Inspector synchronizes signals when their time vectors do not contain all the same sample times. You can select **union** or **intersection** as the synchronization method.

When you specify **union** synchronization, the Simulation Data Inspector builds a time vector that comprises every sample time represented between the two signals. For each sample time not originally present in either signal, the Simulation Data Inspector interpolates the value. When you specify **intersection** synchronization, the Simulation Data Inspector uses only the sample times present in both signals in the comparison.

Choosing between the two options is a trade off between speed and accuracy. The interpolation required by **union** synchronization takes time, but provides a more precise result. When you use **intersection** synchronization, the run completes quickly because the Simulation Data Inspector computes fewer data points and does not interpolate. However, some data is discarded in the process.

## Interpolation Options in the Simulation Data Inspector

You can choose to interpolate your data with a zero-order hold (**zoh**) or a linear approximation. When you specify **zoh** in the **Interpolation Method**, the Simulation Data Inspector replicates the data of the previous sample for interpolated sample times. When you specify **linear** interpolation, the Simulation Data Inspector uses sample times on either side of the interpolated time to linearly approximate the value of the interpolated sample.

## Tolerances in the Simulation Data Inspector

You can specify absolute, relative, and time tolerances in the Simulation Data Inspector. You can specify all tolerances globally, at the top of the graphical viewing area, or on a

signal by signal basis in the properties pane. To use a signal tolerance, change **Override Global Tol** to **yes**.

When you specify multiple tolerance, sometimes each tolerance yields a different answer for what the tolerance should be at each point. The Simulation Data Inspector computes the overall tolerance band by selecting the most lenient tolerance result for each data point.

First, the Simulation Data Inspector computes the tolerance band using only the absolute and magnitude tolerances:

```
tolerance =  
max(absoluteTolerance,relativeTolerance*abs(baselineData));
```

The upper boundary of the tolerance band is formed by adding **tolerance** to the **Baseline** signal. Similarly, the lower boundary of the tolerance band is formed by subtracting **tolerance** from the **Baseline** signal.

To apply the time tolerance, the Simulation Data Inspector looks at a time interval defined as  $[(t - \text{timeTol}), (t + \text{timeTol})]$ . For the upper boundary of the tolerance band, the Simulation Data Inspector selects the maximum value on the interval for each data point. For the lower boundary of the tolerance band, the Simulation Data Inspector selects the minimum value on the interval for each data point.

## Related Examples

- “Compare Simulation Data” on page 27-27

## Run Management and Configuration

The Simulation Data Inspector loads new simulation runs into the **Inspect** pane. You can configure how new runs are loaded into the Simulation Data Inspector and how runs are named.

### Append New Runs

You can specify whether to add new runs in the **Inspect** pane at the top or bottom of the runs list. From the **File** section on the **Visualize** tab, click **Preferences**.

The **New Run** tab of the **Preferences** window has the options for configuring how new runs are added to the **Inspect** pane. The default configuration adds new runs to the bottom of the runs list.

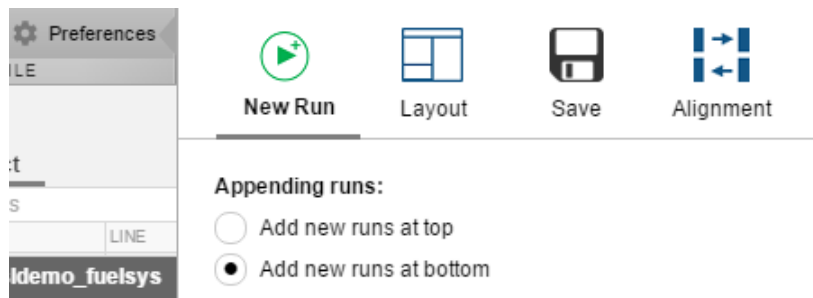

To append new runs at the top of the list, click **Add new runs at top**.

### Specify a Run Naming Rule

To specify how you would like the Simulation Data Inspector to name subsequent runs, open the **New Run** tab of **Preferences**. The default value for the **New run naming rule** is Run <run\_index>: <model\_name>.

New run naming rule:





Run <run\_index>: <model\_name>

<run_index>	Sequential number of each run
<model_name>	Name of Simulink model
<time_stamp>	Run creation time
<sim_mode>	Simulation mode for run

To change the run naming rule, enter your desired options from the list of available parameters along with any other regular characters. For example, to include the simulation mode in subsequent run names, enter `Run <run_index>: <model_name>: <sim_mode>` in the **New run naming rule** box. With this rule, using model `slexAircraftExample`, the run name appears as `Run 1: slexAircraftExample: normal`.

## Overwrite a Run

You can overwrite an existing run in the **Inspect** pane with **Overwrite Run** mode. To enable **Overwrite Run** mode, right-click the run you want to overwrite in the **Inspect** pane and select **Overwrite Run**. The overwrite symbol appears on the run to indicate that **Overwrite Run** mode is enabled.

NAME	LINE	
▼  Run 4: sldemo_fuelsys		
<input type="checkbox"/>	EGO Fault Switch:	
<input type="checkbox"/>	air_fuel_ratio	
<input type="checkbox"/>	Engine Speed Fa.	

When you simulate the model with a run in **Overwrite Run** mode, the data for the run is replaced with the new simulation run.

The run remains in overwrite mode until you disable it. To disable the overwrite mode, right-click the run and clear the check box next to **Overwrite Run**.

See “Iterate Model Design with the Simulation Data Inspector” on page 27-7 for more information on how **Overwrite Run** mode can be used with signal logging in an iterative workflow.

## Related Examples

- “Log Signals to the Simulation Data Inspector” on page 27-6
- “Customize the Simulation Data Inspector Interface” on page 27-41

## Customize the Simulation Data Inspector Interface

You can customize the Simulation Data Inspector interface to display the information you want, how you want to see it. You can modify both the layout and content of the panels that make up the Simulation Data Inspector interface. You can also change the grouping and alignment of data and the color scheme for the graphical viewing area.

### Modify the Simulation Data Inspector Layout

Click the **Preferences** button in the **File** section of the **Visualize** tab. Then, click the **Layout** button. You can choose to hide or display the navigation and properties panes. When you hide the navigation pane, the properties pane is automatically hidden. The Restore Defaults button at the bottom of the pane restores the settings of the active panel to their default configuration.

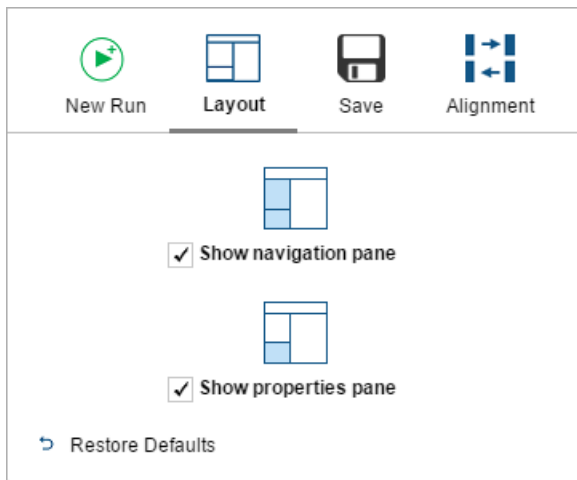

### Modify Displayed Properties

Columns in the **Inspect** and **Compare** panes display plot configuration and signal properties. To add or remove a property in the table, click the **Preferences** button below the **Inspect** and **Compare** pane selection buttons and click **Columns**. From the list, select the properties that you want to display in the active pane. Columns appear in the table in the order in which you select them.

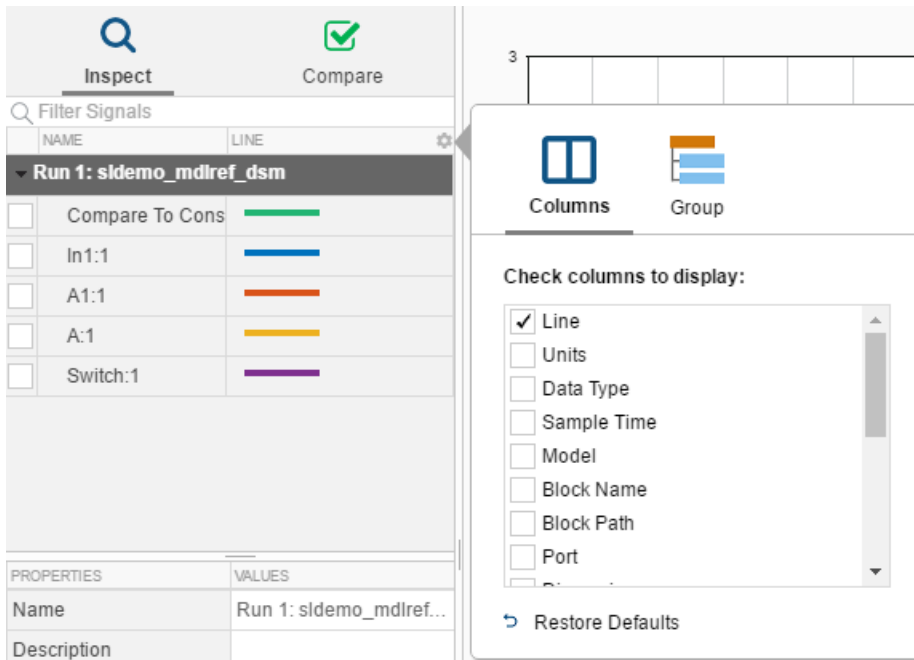

**Column Options for Inspect Pane**

Column Option	Value
Line	Signal line style and color
Units	Signal measurement units
Data Type	Signal data type
Sample Time	Method used to sample the signal
Model	Name of the model that generated the signal
Block Name	Name of the source block for the signal
Block Path	Path to the source block for the signal
Port	Index of the signal on the output port of its block
Dimensions	Dimensions of the matrix containing the signal

Column Option	Value
<b>Channel</b>	Index of signal within matrix
<b>Run</b>	Name of the simulation run containing the signal
<b>Absolute Tolerance</b>	User-specified, positive-valued absolute tolerance for the signal
<b>Relative Tolerance</b>	User-specified, positive-valued relative tolerance for the signal
<b>Override Global Tolerance</b>	User-specified property that determines whether signal tolerances take priority over global tolerances
<b>Time Tolerance</b>	User-specified, positive-valued time tolerance for the signal
<b>Interp Method</b>	User-specified interpolation method used to plot the signal
<b>Sync Method</b>	User-specified synchronization method used to coordinate signals for comparison
<b>Time Series Root</b>	Name of the variable associated with the signal for signals imported from the MATLAB workspace
<b>Time Source</b>	Name of the array containing the time data for signals imported from the MATLAB workspace
<b>Data Source</b>	Name of the array containing the signal data for signals imported from the MATLAB workspace

On the **Compare** pane, many parameters have a Baseline column and a Compare To column that you can display independently. The name of the baseline signal and a column indicating whether the comparisons pass or failed based on the specified tolerances are displayed by default.

#### Column Options for Compare Pane

Column Option	Value
<b>Line</b>	Signal line style and color

Column Option	Value
<b>Absolute Tolerance</b>	User-specified, positive-valued absolute tolerance for the signal
<b>Relative Tolerance</b>	User-specified, positive-valued relative tolerance for the signal
<b>Max Difference</b>	The maximum difference between the Baseline and Compare To signals
<b>Override Global Tolerance</b>	User-specified property that determines whether signal tolerances take priority over global tolerances
<b>Time Tolerance</b>	User-specified, positive-valued time tolerance for the signal
<b>Name</b>	Name of Compare To signal
<b>Units</b>	Signal measurement units
<b>Data Type</b>	Signal data type
<b>Sample Time</b>	Method used to sample the signal
<b>Run</b>	Name of the simulation run containing the signal
<b>Align By</b>	Signal alignment specified in <b>Comparison Options</b>
<b>Model</b>	Name of the model that generated the signal
<b>Block Name</b>	Name of the source block for the signal
<b>Block Path</b>	Path to the source block for the signal
<b>Port</b>	Index of the signal on the output port of its block
<b>Dimensions</b>	Dimensions of the matrix containing the signal
<b>Channel</b>	Index of signal within matrix
<b>Interp Method</b>	User-specified interpolation method
<b>Sync Method</b>	User-specified synchronization method used to coordinate signals for comparison



Column Option	Value
<b>Time Series Root</b>	Name of the variable associated with the signal for signals imported from the MATLAB workspace
<b>Time Source</b>	Name of the array containing the time data for signals imported from the MATLAB workspace
<b>Data Source</b>	Name of the array containing the signal data for signals imported from the MATLAB workspace





## View Signal and Run Properties

To view the properties of a signal, select a signal in the **Inspect** or **Compare** pane. The properties pane displays the properties of the selected signal. You can edit the properties with a white box to their right directly from the properties pane.

  
**Inspect**











  
**Compare**

Filter Signals















NAME	LINE	SAMPLE TIME
<b>▼ Run 3: sldemo_fuelsys</b>		
<input type="checkbox"/> EGO Fault Switch:1		Parameter
<input checked="" type="checkbox"/> <b>air_fuel_ratio</b>		<b>Continuous</b>
<input type="checkbox"/> Engine Speed Faul.		Parameter
<input type="checkbox"/> speed		Continuous
<input type="checkbox"/> MAP Fault Switch:1		Parameter
<input type="checkbox"/> map		Continuous

PROPERTIES	VALUES
Name	air_fuel_ratio
Line	
Units	1
Data Type	double
Sample Time	Continuous
Model	sldemo_fuelsys
Block Name	Engine Gas Dynamics
Block Path	sldemo_fuelsys/Engin...
Port	3
Dimensions	[1]
Channel	
Run	Run 3: sldemo_fuelsys
Override Global Toler...	no
Absolute Tolerance	0
Relative Tolerance	0.00%
Leading Tolerance	0
Lagging Tolerance	0
Interp Method	linear
Sync Method	union
Time Series Root	
Time Source	
Data Source	

To view the properties of a run, select a run in the **Inspect** or **Compare** pane.

NAME	LINE	
<b>Run 3: sldemo_fuelsys</b>		
<input type="checkbox"/>	EGO Fault Switch:	
<input type="checkbox"/>	air_fuel_ratio	
<input type="checkbox"/>	Engine Speed Fa.	
<input type="checkbox"/>	speed	
<input type="checkbox"/>	MAP Fault Switch:	
<input type="checkbox"/>	map	
<input type="checkbox"/>	ego	
<input type="checkbox"/>	Throttle Angle Fa.	
<input type="checkbox"/>	throttle	
<input type="checkbox"/>	CheckRange	
PROPERTIES	VALUES	
Name	Run 3: sldemo_fuelsys	
Description		
Tag		
Date	01-Nov-2016 09:37:18	
Model	sldemo_fuelsys	
Simulation Mode	normal	
Start Time	0	
Stop Time	2000	
Simulink Version	Simulink 8.9 (R2017a...	
Model Version	1.737	
User ID		
Machine Name		
Solver Type	Variable-Step	
Solver Name	ode45	
Initialization Time	0.986028	
Execution Time	16.906104	
Termination Time	0.109004	
Total Elapsed Time	18.001136	

On the **Compare** pane, the Simulation Data Inspector highlights differences in the Baseline and Compare To run and signal properties.

NAME (BA...	U...	L...	A...	R...	M...	⚙
<b>Compare Run 4: sldemo_fuelsys to Run 3: ...</b>						
✓	EGO Fault			0	0...	0
✗	air_fuel_r.			0	0...	0.03
✓	Engine S.			0	0...	0
✓	speed			0	0...	0
✓	MAP Fault			0	0...	0
✗	map			0	0...	2.9...
✗	ego			0	0...	0.07
✓	Throttle A.			0	0...	0
✗	throttle			0	0...	3.5...
PROPERTIES		BASELINE		COMPARE TO		
Name	Run 3: sldemo_fuelsys		Run 4: sldemo_fuelsys			
Description						
Tag						
Date	01-Nov-20...		01-Nov-20...			
Model	sldemo_fue...		sldemo_fue...			
Simulation Mode	normal		normal			
Start Time	0		0			
Stop Time	2000		2000			
Simulink Version	Simulink 8...		Simulink 8...			
Model Version	1.737		1.737			
User ID						
Machine Name						
Solver Type	Variable-Step		Variable-Step			
<b>Solver Name</b>	ode45		ode23			
<b>Initialization Time</b>	0.986028		0.994989			
<b>Execution Time</b>	16.906104		14.163133			
<b>Termination Time</b>	0.109004		0.106003			
<b>Total Elapsed Ti...</b>	18.001136		15.264125			

## Rename a Run

To rename a run name, you can:

- Double-click the run row, type the new run name, and press **Enter**.
- Click the Name row in the properties pane, type the new run name, and press **Enter**.

To specify a new run naming rule for subsequent simulation runs, see “Specify a Run Naming Rule” on page 27-39.

## Modify Grouping in Inspect Pane

You can customize the organizational hierarchy of your data in the **Inspect** pane. The data is grouped first by run name, which cannot be modified. You can then group your data by data hierarchy, model hierarchy, or without further hierarchy. Changes to signal grouping apply only to the **Inspect** pane, not the **Compare** pane. If you have a Simscape license, you can also group your data by physical system data hierarchy.

As an example, change the grouping in the **Inspect** pane to group by run name, then by model hierarchy, and then by data hierarchy.

- 1 Click the **Preferences** button in the upper right of the **Inspect** pane.
- 2 Click **Group**.
- 3 In the **Group** pane, select **Model Hierarchy** in the first **Then By** drop-down menu.
- 4 In the second **Then By** drop-down menu, select **Data Hierarchy**.

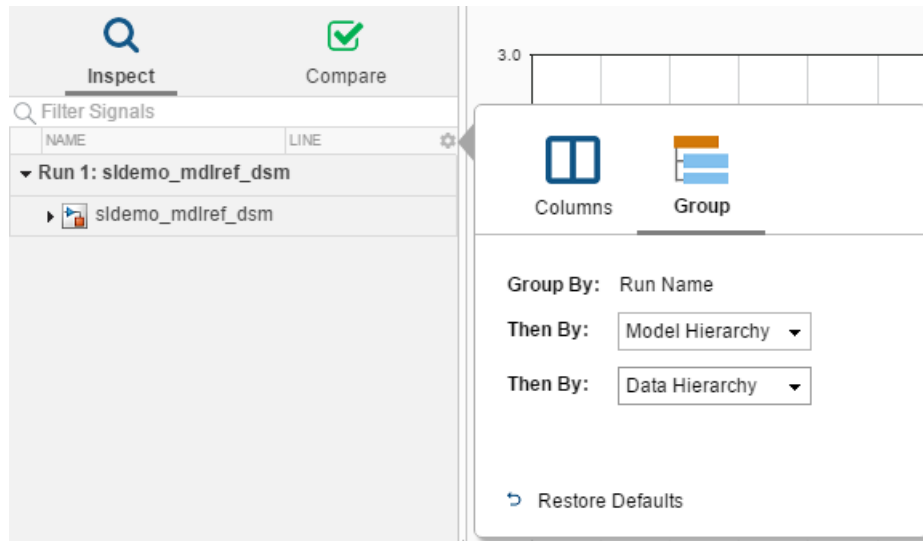

The **Inspect** pane groups the signal data by run name, then by model hierarchy, and then by data hierarchy.

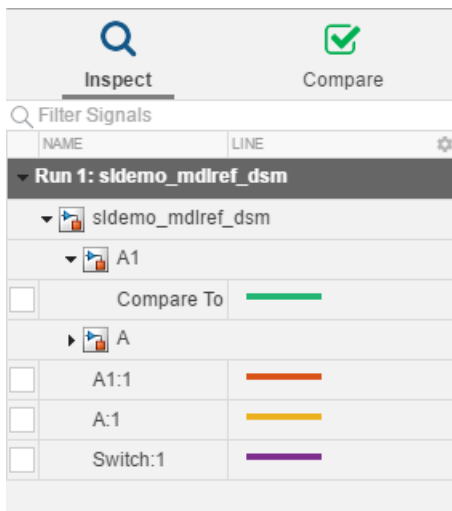

To remove the hierarchy and display a simple list of signals, select **None** from both **Then By:** drop-down menus on the **Group** pane.

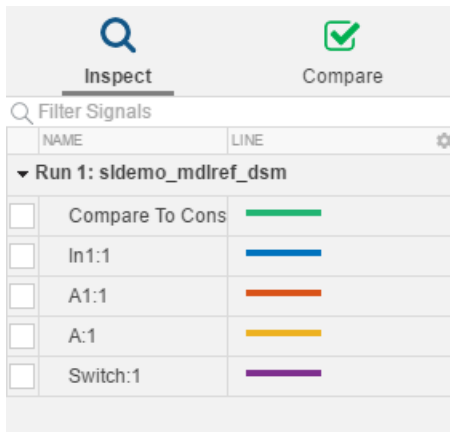

If you have a Simscape license, you can group your data by physical system data hierarchy as well, and three **Then By:** drop-down menus are shown.

## Modify Signal Alignment for Comparisons

When the Simulation Data Inspector aligns signals across simulation runs, it attempts to match signals between runs using signal properties. For more information on the properties used for alignment, see “Signal Alignment in the Simulation Data Inspector” on page 27-35. To modify how signals are aligned for run comparisons:

- 1 Click the **Preferences** button on the **File** section of the **Visualize** tab.
- 2 Click **Alignment**.
- 3 Select the **Align By** and **Then By** drop-down menus.

The default alignment options are: **Align By:** Data Source, **Then By:** Path, **Then By:** SID, and **Then By:** Signal Name.

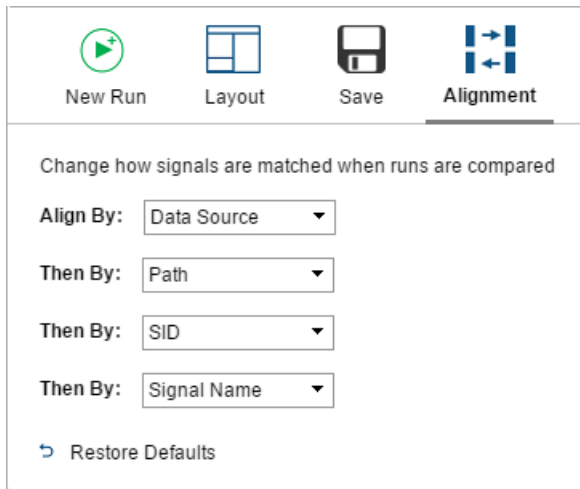

## Specify Colors and Style

The Simulation Data Inspector provides options for customizing the colors of the graphical display area and the line style and color for each signal.

To modify the colors of the graphical area, click the settings button at the top right of the graph. You can specify colors for the **Background**, **Plot area**, **Axes**, and **Grid** of the graphical viewing area. Click the box next to each feature to specify its color as a selection from the standard palette or as a custom numerical value. Click **Set** after you have specified your desired color options.

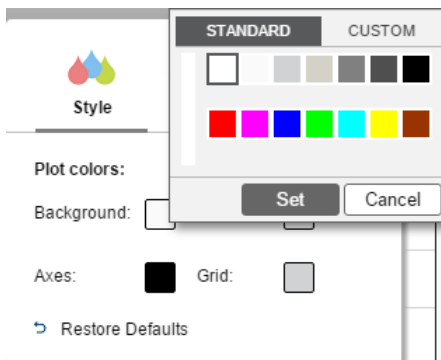



To specify the line style and color, click the **Line** column for a signal. If the line column is not shown, add the column using the settings button in the signals pane. Select a color and a line style. You can choose a color from the standard palette or specify a custom color numerically in the **Custom** tab. Click **Set** after you have specified your desired color and style options.

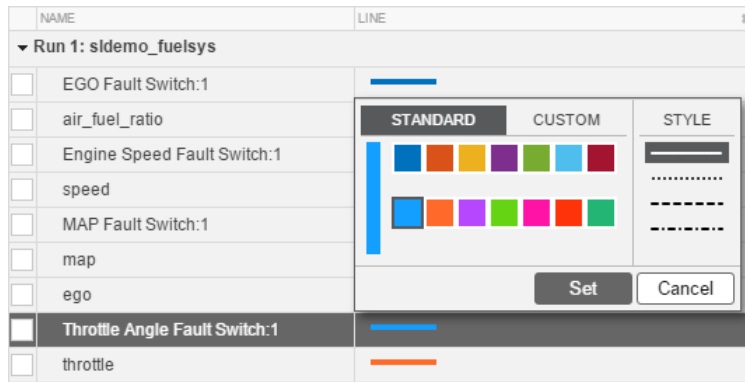

## Modify Logged Signal Properties

You can modify the line color, line style, and the subplot arrangement of a logged signal from the model. Changes you make in the model are applied to the next run in the Simulation Data Inspector at the start of simulation.

- 1 In the model, right-click the logging badge  and select **Properties** to open the Visualization Properties dialog box.
- 2 To specify the line style and color, select the **Custom style and color** check box, and then click the line to select the style and color.

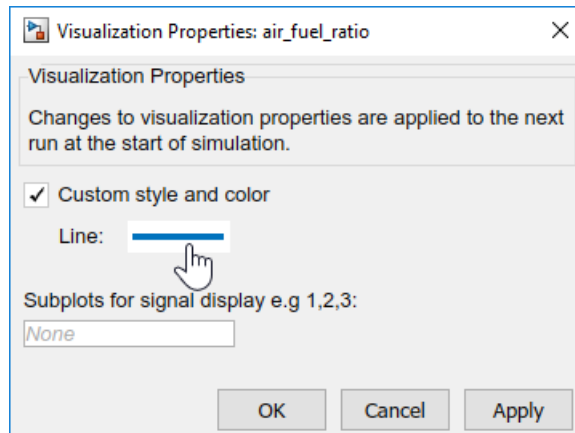

- 3 To specify which subplots a streamed signal is plotted on at the start of simulation, enter one or more subplot numbers in the **Subplots for signal display** box. The number refers to the subplot number in column-major order.

You can display subplots in configurations ranging from  $1 \times 1$  to  $8 \times 8$ . Subplots follow column-wise numbering, from 1 at the top-left subplot to 8 in the bottom left, to 64 at the bottom-right. This number system is fixed, irrespective of the subplot configuration you select. For example, if you display four subplots in a  $2 \times 2$  configuration, the bottom-right subplot of the configuration is numbered 10 and not 4. The number is 10 because in the largest possible  $8 \times 8$  matrix, that subplot is numbered 10 when counted in a column-wise manner.

- 4 Click **OK**, and save the model.

For information on how to log signals, see “Log Signals to the Simulation Data Inspector” on page 27-6.

## Modify a Plot in the Simulation Data Inspector

With the controls available in the Simulation Data Inspector, you can modify your plots to showcase your data. Some of the options facilitate presentation of data, while others allow you to more thoroughly explore data.

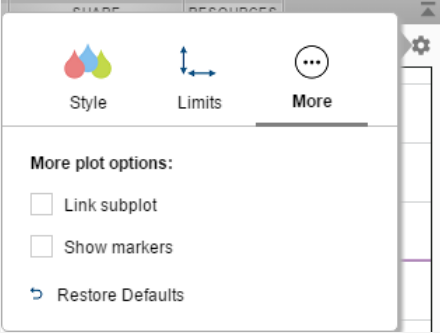
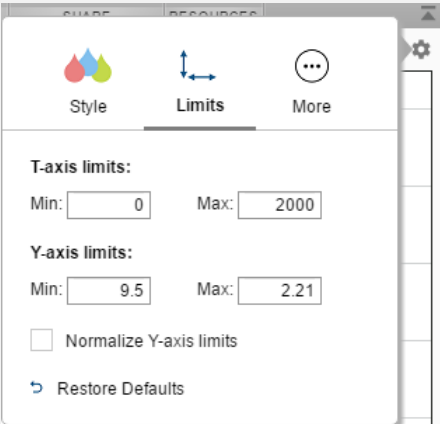
Goal	Action
<p>Normalize the data for each signal from 0 to 1 along the y-axis of a plot.</p>	<p>Open the plot settings and select the <b>Limits</b> tab. Check the <b>Normalize Y Axis</b> box.</p>
<p>Show markers at each sample point on a signal.</p>	<p>Open the plot settings and select the <b>More</b> tab. Check the <b>Show Markers</b> box.</p>  <p>The screenshot shows the 'More' tab selected in the plot settings. Under 'More plot options', the 'Show markers' checkbox is checked. Other options include 'Link subplot' (unchecked) and 'Restore Defaults'.</p>
<p>Set the plot axes minimum and maximum values.</p>	<p>Open the plot settings and select the <b>Limits</b> tab. Enter the desired values for the axis limits.</p>  <p>The screenshot shows the 'Limits' tab selected in the plot settings. It displays input fields for 'T-axis limits' (Min: 0, Max: 2000) and 'Y-axis limits' (Min: 9.5, Max: 2.21). There is also a 'Normalize Y-axis limits' checkbox which is unchecked, and a 'Restore Defaults' button.</p>

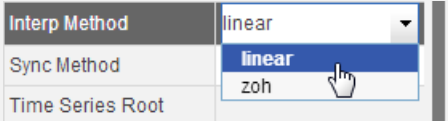
Goal	Action
Zoom and pan to inspect the data.	<p>On the <b>Visualize</b> tab, select one of the zoom actions.</p> 
Send all the plots to a separate MATLAB figure window.	<p>In the <b>Share</b> section of the <b>Visualize</b> tab, click <b>Send to Figure</b>.</p> <p>For more information on plotting and customizing your MATLAB data plots, see “Types of MATLAB Plots” (MATLAB).</p>
Set the interpolation method used for plotting a signal to zero-order-hold or linear.	<p>Select a signal in the <b>Inspect</b> or <b>Compare</b> panes. In the properties table, select an interpolation method from the <b>Interp Method</b> list.</p> 
Unlink or link a subplot.	<p>Select a subplot and open the plot settings. On the <b>More</b> tab, check or clear the <b>Link Subplot</b> box.</p> <p>For more details, see “Linked Subplots” on page 27-23.</p>

### Related Examples

- “Log Signals to the Simulation Data Inspector” on page 27-6
- “Run Management and Configuration” on page 27-39

## Limitations of the Simulation Data Inspector

The Simulation Data Inspector does not support all data formats. To work appropriately with data vectors, the Simulation Data Inspector requires at least an associated time vector. In general, the `Array` and `Structure` data formats are not supported unless **Time** is logged. The `Timeseries` data format is preferred because some of the Simulation Data Inspector features work best with metadata that is missing from other formats.

Simulating from the command line does not automatically import recorded data to the Simulation Data Inspector. Use the `Simulink.sdi.addToRun` function to import recorded signals to a run in the Simulation Data Inspector.

The Simulation Data Inspector allows up to 8000 channels per signal in a run created from imported workspace data.

### Related Examples

- “Simulation Data Inspector in Your Workflow” on page 27-2

## Inspect and Compare Data Programmatically

You can harness the capabilities of the Simulation Data Inspector from the MATLAB command line using the Simulation Data Inspector API. The API enables you to execute your workflow, from populating the Simulation Data Inspector with data to analyzing comparison results.

### Create a Run from Workspace Variables

This example creates a run in the Simulation Data Inspector from variables in the base workspace and plots the signals.

```
% Create timeseries data
t = (0:0.1:2*pi)';
ts1 = timeseries(sin(t),t,'Name','sine');
ts2 = timeseries(cos(t),t,'Name','cosine');

% Import timeseries into the Simulation Data Inspector
runID = Simulink.sdi.createRun('My Run','vars',ts1,ts2);
run = Simulink.sdi.getRun(runID);

% Plot signals
sig1 = getSignalByIndex(run,1);
sig2 = getSignalByIndex(run,2);

sig1.checked = true;
sig2.checked = true;

% Open the Simulation Data Inspector
Simulink.sdi.view
```

### Compare Signals Programmatically

You can programmatically compare signals using the Simulation Data Inspector.

```
% Open model
load_system('sldemo_absbrake')

% Simulate model
sim('sldemo_absbrake');

% Create a Simulation Data Inspector run
```

```

runID = Simulink.sdi.getRunIDByIndex(1);
run = Simulink.sdi.getRun(runID);

sig1 = getSignalIDByIndex(run,1);
sig2 = getSignalIDByIndex(run,2);

% Compare two signals
diff = Simulink.sdi.compareSignals(sig1,sig2);

% Find if signal data match
Match = diff.Match;

```

## Compare Runs of Simulation Data

This example compares the signal data of two simulation runs. At the end of this example, the difference between the Ww signal from each run is plotted in a MATLAB figure.

```

% Open model
load_system('sldemo_absbrake')

% Simulate model using 0.24 desired slip
set_param('sldemo_absbrake/Desired relative slip','Value','0.24')
sim('sldemo_absbrake');

% Simulate model using 0.25 desired slip
set_param('sldemo_absbrake/Desired relative slip','Value','0.25')
sim('sldemo_absbrake');

% Compare runs
runID1 = Simulink.sdi.getRunIDByIndex(1);
runID2 = Simulink.sdi.getRunIDByIndex(2);
runResult = Simulink.sdi.compareRuns(runID1,runID2);

% Plot 'Ww' signal difference between runs
signalResult = getResultByIndex(runResult, 1);
figure(3)
plot(signalResult.Diff)

```

## Analyze Simulation Data with Signal Tolerances

You can change tolerance values on a signal by signal basis to evaluate the effect of a model parameter change. This example uses the `slexAircraftExample` model and the

Simulation Data Inspector to evaluate the effect of changing the time constant for the low-pass filter following the control input.

```
% Load example model
load_system('slexAircraftExample')

% Mark the alpha, rad signal for streaming
Simulink.sdi.markSignalForStreaming('slexAircraftExample/Aircraft Dynamics Model', 4,

% Simulate system
sim('slexAircraftExample')

% Change input filter time constant
modelWorkspace = get_param('slexAircraftExample', 'modelworkspace');
modelWorkspace.assignin('Ts', 0.2)

% Simulate again
sim('slexAircraftExample')

% Get run data
runID1 = Simulink.sdi.getRunIDByIndex(1);
run1 = Simulink.sdi.getRun(runID1);

runID2 = Simulink.sdi.getRunIDByIndex(2);
run2 = Simulink.sdi.getRun(runID2);

% Compare signals
sigID1 = run1.getSignalIDByIndex(1);
sigID2 = run2.getSignalIDByIndex(1);
diff1 = Simulink.sdi.compareSignals(sigID1, sigID2);

% Check comparison result
diff1.match

ans =

    logical

     0

The result indicates that the signals do not match with the default tolerance of zero. You can change the tolerance and run the comparison again to evaluate the effect of the change in time constant.

% Get signal object for sigID1
```



```
sig1 = Simulink.sdi.getSignal(sigID1);

% Change absolute tolerance to 0.2
sig1.absTol = 0.2;

% Run the comparison again
diff2 = Simulink.sdi.compareSignals(sigID1, sigID2);

% Check the result
diff2.match

ans =

    logical

     1
```

## Generate a Report from the Simulation Data Inspector

You can programmatically generate a report from the Simulation Data Inspector.

```
% Open model
load_system('sldemo_absbrake')

% Simulate model twice
set_param('sldemo_absbrake/Desired relative slip', 'Value', '0.22')
sim('sldemo_absbrake')

set_param('sldemo_absbrake/Desired relative slip', 'Value', '0.25')
sim('sldemo_absbrake')

% Compare two runs
runID1 = Simulink.sdi.getRunIDByIndex(1);
runID2 = Simulink.sdi.getRunIDByIndex(2);
Simulink.sdi.compareRuns(runID1, runID2);

% Create report
Simulink.sdi.report('ReportToCreate', 'Compare Runs')
```

## Clear All Logged Signals

You can programmatically stop logging all signals marked for logging within a model. With a clean slate, you can then select your particular signals of interest to log and inspect in the Simulation Data Inspector.

This example starts by clearing all logged signals and then marks the EngineRPM and Gear signals for logging.

```
% Load example system
load_system('sldemo_autotrans')

% Clear all logged signals
set_param('sldemo_autotrans', 'InstrumentedSignals', [])

% Mark EngineRPM and Gear signals for logging
Simulink.sdi.markSignalForStreaming('sldemo_autotrans/ShiftLogic', 1, 'on')
Simulink.sdi.markSignalForStreaming('sldemo_autotrans/Engine', 1, 'on')

% Simulate the model
sim('sldemo_autotrans')

% View logged signals in the Simulation Data Inspector
Simulink.sdi.view
```

## Related Examples

- “Simulation Data Inspector in Your Workflow” on page 27-2

## Keyboard Shortcuts for the Simulation Data Inspector

In the table, if the shortcut is called **Ctrl+N**, for example, it means to hold down the **Ctrl** key and press the **N** key.

---

**Note:** On Macintosh platforms, use the **command** key instead of **Ctrl**.

---

### General Actions

Task	Shortcut
Start a new session	<b>Ctrl+N</b>
Open a session	<b>Ctrl+O</b>
Save a session	<b>Ctrl+S</b>
Compare	<b>Ctrl+E</b>
Link/Unlink a subplot	<b>Ctrl+U</b>
Delete a run or signal	<b>Delete</b>

### Plot Zooming

Task	Shortcut
Zoom in T (time)	<b>Ctrl+Shift+T</b>
Zoom in Y	<b>Ctrl+Shift+Y</b>
Zoom in T and Y	<b>Ctrl++</b> (numeric keypad only)
Zoom out	<b>Ctrl+-</b> (numeric keypad only)
Fit to view	<b>Spacebar</b>
Cancel zoom operation or signal dragging	<b>Esc</b>

## Data Cursors

Task	Shortcut
Show a data cursor	<b>Ctrl+I</b>
Hide all data cursors	<b>Shift+Del</b>
Move a selected data cursor to next data point	<b>Right arrow</b>
Move a selected data cursor to previous data point	<b>Left arrow</b>
Activate first (left) cursor	<b>Ctrl+1</b>
Activate second (right) cursor	<b>Ctrl+2</b>

## Import Dialog Box

These actions pertain to the import table.

Task	Shortcut
Expand all nodes	<b>Ctrl+=</b>
Collapse all nodes	<b>Shift+Ctrl+=</b>
Select a node	<b>Space</b>
Expand a single node	<b>Right arrow</b>
Collapse a single node	<b>Left arrow</b>

## Related Examples

- “Simulation Data Inspector in Your Workflow” on page 27-2
- “Customize the Simulation Data Inspector Interface” on page 27-41

## Tune and Visualize Your Model with Dashboard Blocks

### In this section...

“Explore Connections Within the Model” on page 27-65

“Simulate Changing Model States” on page 27-67

“View Signal Data” on page 27-67

“Tune Parameters During Simulation” on page 27-69

The blocks in the Dashboard library help you control and visualize your Simulink model during simulation and while the simulation is paused. This example uses the Fault-Tolerant Fuel Control System model to showcase the control and visualization capabilities of Dashboard blocks.

To open the model, enter `sldemo_fuelsys` into the MATLAB command window. To open the Dashboard subsystem, double-click it or click the Open the Dashboard link.

---

**Note:** Dashboard blocks cannot connect to signals inside reference models.

---

### Explore Connections Within the Model

The Dashboard subsystem contains blocks for controlling and visualizing signals in the Fault-Tolerant Fuel Control System model. Explore the connections between the signals and Dashboard blocks. Click either a signal or a Dashboard block to highlight the connections.

From the Dashboard subsystem, click the Toggle Switch in the Fuel panel. Hover the mouse over the ellipsis above the block and then click the arrow above it to jump to the connected block or signal.

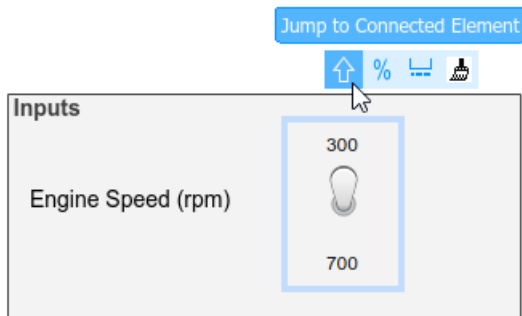

From the top level of the model, click the `air_fuel_ratio` signal and see the Dashboard subsystem, Quarter Gauge, and Half Gauge highlighted.

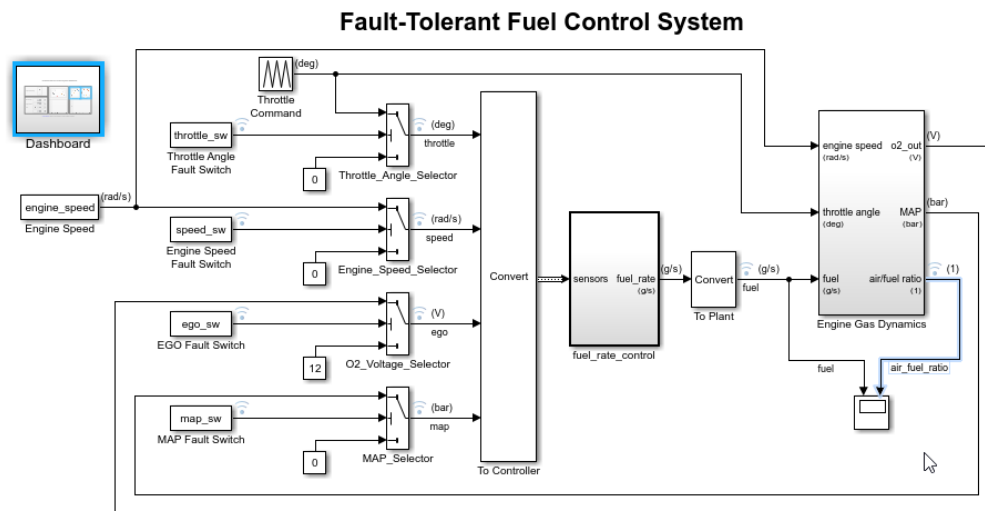

[Open the Dashboard](#) subsystem to simulate any combination of sensor failures.

Copyright 1990-2016 The MathWorks, Inc.

**Note:** Connections with Dashboard Scope blocks are not highlighted.

## Simulate Changing Model States

In the Dashboard subsystem, switches provide control over the state of the throttle angle, engine speed, EGO, and MAP signals. For each sensor signal, the switch toggles between `normal` and `fail`, allowing you to simulate the system response to each single-point failure. Clicking any one of these switches before simulation, during simulation, or while a simulation is paused changes the state in the model.

Run the simulation and observe the control system response to each single-point failure.

- 1 Start the simulation.
- 2 As the simulation runs, click one of the switches to simulate a component failure.

Observe the changes in the `fuel` and `air_fuel_ratio` signals in the Dashboard Scope and Gauge blocks when you flip each switch.

- 3 Stop the simulation when you are finished.

### Fault-Tolerant Fuel Control System Dashboard

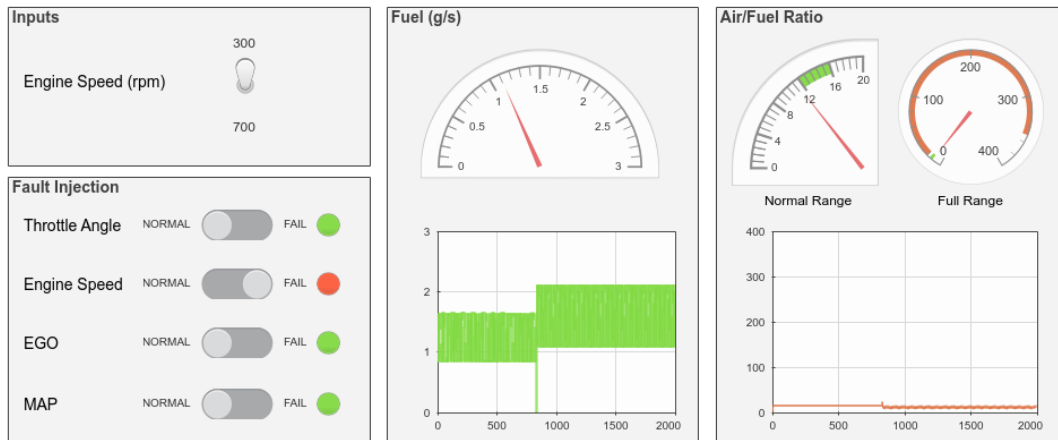

[Update Diagram](#) (Ctrl+D) to bind switches to model workspace variables.

## View Signal Data

Dashboard blocks allow you to view signal data using gauges, lamps, and dashboard scopes. In this example, the Dashboard blocks provide visual feedback about the fuel

input and air-to-fuel ratio during simulation, after simulation, and while a simulation is paused.

To capture different types of information and more effectively visualize a signal, connect multiple Dashboard blocks to a single signal. For example, you can visualize the `air_fuel_ratio` signal using the Gauge, Quarter Gauge, and Dashboard Scope blocks.

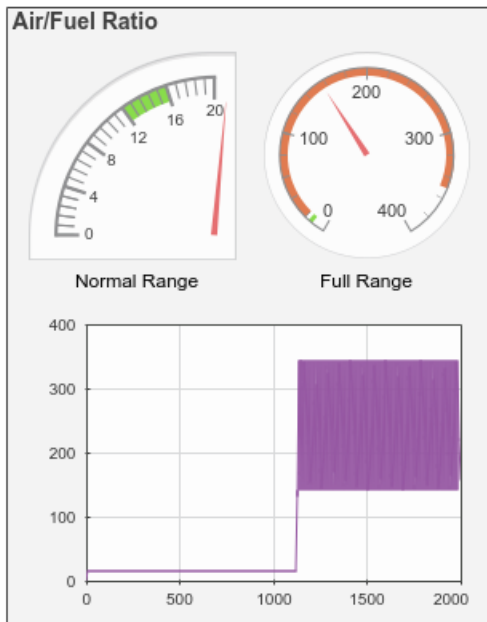

Use the Quarter Gauge block, labeled Normal Range in the example, to see small fluctuations in the instantaneous `air_fuel_ratio` signal while its value lies within the normal operational range. The Gauge block, labeled Full Range, allows you to see the behavior of the instantaneous `air_fuel_ratio` signal outside of the normal range. The Dashboard Scope block shows the variations of the `air_fuel_ratio` signal over time.

---

**Note:** If you disable streaming for a signal connected to a Dashboard block Gauge or Dashboard Scope, the connection breaks, and signal data does not stream to the block. To view signal data again, double-click the Dashboard block and reconnect the signal.

---



## Tune Parameters During Simulation

Often, models include parameters that require tuning. Dashboard blocks allow you to tune these parameters during a simulation. To explore the tuning capability within the fuel system model, replace the engine speed Toggle Switch block with a Knob:

- 1 Delete the engine speed Toggle Switch.
- 2 Add a Knob block from the Dashboard library.
- 3 Double-click the Knob block to open its dialog box.
- 4 In the model, select the Engine Speed block. Engine Speed is a Constant block whose **Constant value** parameter you can tune with the Knob block.

When you select Engine Speed, the name of the parameter you can tune appears in the connections table in the Knob block dialog box.

---

**Note:** Dashboard blocks cannot connect to blocks that are commented out.

---

- 5 Select the option button next to `engine_speed` in the connections table.
- 6 After you select the `engine_speed` parameter to tune, you can set the knob tick interval and range to values that make sense for your simulation. In this example, set **Minimum** to 75, **Maximum** to 750, and **Tick Interval** to 75.
- 7 Click **OK** to connect the `engine_speed` parameter to the knob.

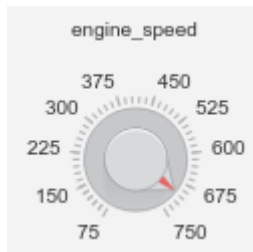

Simulate the model and tune the parameter using the Knob.

- 1 Start the simulation.
- 2 As the simulation runs, drag the pointer on the Knob to adjust the value of `engine_speed`.

Notice as you use the Knob to adjust the value of `engine_speed`, the `air_fuel_ratio` value displayed on the Gauge blocks and in the Dashboard Scope block changes.

- 3 Stop the simulation when you are finished tuning parameters.

### Related Examples

- “Decide How to Visualize Simulation Data” on page 28-2

# Analyzing Simulation Results

---

- “Decide How to Visualize Simulation Data” on page 28-2
- “Linearizing Models” on page 28-9
- “Finding Steady-State Points” on page 28-14

## Decide How to Visualize Simulation Data

### In this section...

“Visualizing Simulation Data” on page 28-2

“Port Value Displays” on page 28-2

“Scope Blocks and Scope Viewers” on page 28-3

“Simulation Data Inspector” on page 28-4

“Dashboard Controls and Displays” on page 28-6

“Outport Block” on page 28-7

“To Workspace Block” on page 28-7

“Signal Logging Without Blocks” on page 28-8

### Visualizing Simulation Data

During the modeling process, you run simulations to learn about the behavior of your model. To observe that behavior, view and plot signal values during and after a simulation. Some common modeling tasks that include simulations are:

- **Prototype** — Quickly model a design and compare design alternatives.
- **Validate** — Compare simulated data with functional requirements to validate that you built your model correctly.
- **Optimize** — Compare simulated data between simulations to check if changes to your model remain within a specified design tolerance.
- **Verify** — Compare simulated data from a model with measured data from the modeled system to verify that your model gives the correct answer.

In Simulink you can view simulation data using several approaches. Some approaches display signal data during a simulation. Other approaches save signal data to the MATLAB workspace where you can post process the data. Learn about each of these approaches so you can choose one suitable for your application.

### Port Value Displays

When debugging a model to isolate a particular issue, a common task is to observe signal values at each time step during a simulation. To observe a signal value, right-click a signal line, and then select **Show Value Label of Selected Port**.

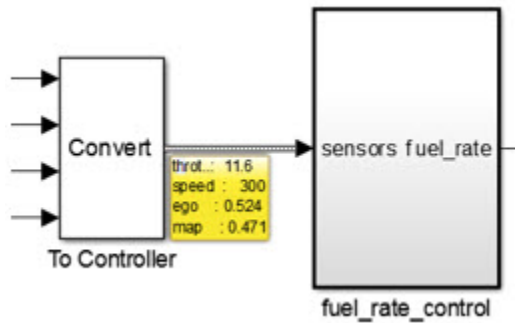

Displaying port values for a bus signal allows you to monitor the signal values at each time step during a simulation.

## Scope Blocks and Scope Viewers

Scope blocks and scope viewers offer a way to visualize your simulation data over time. If you are prototyping a model design, you can attach signals to a Scope block, and then simulate your model to test and validate the design. Use the oscilloscope-like tools (triggers and measurements) available with a scope to debug your model.



A Scope block or scope viewer opens to a scope window where you can display and evaluate simulation data. In the Scope window, you can:

- Select signals — Connect signal lines to a Scope block using input ports. Attach signals to a Floating Scope block using the signal selector tool that hierarchically displays all signals in a model.
- View signals — Compare selected signals by grouping them on multiple displays.
- Prototype and debug — Set triggers to capture events, use interactive cursors to measure signal values at various points, and review signal statistics such as maximum and mean values. Also, control simulations and step through simulations to validate a design.
- Save signal data — Save signal data to the MATLAB workspace using a dataset object, array, or structure format.

- Supported data types — All data types supported by Simulink including variable-size, fixed-point, sample-based, and frame-based signals.

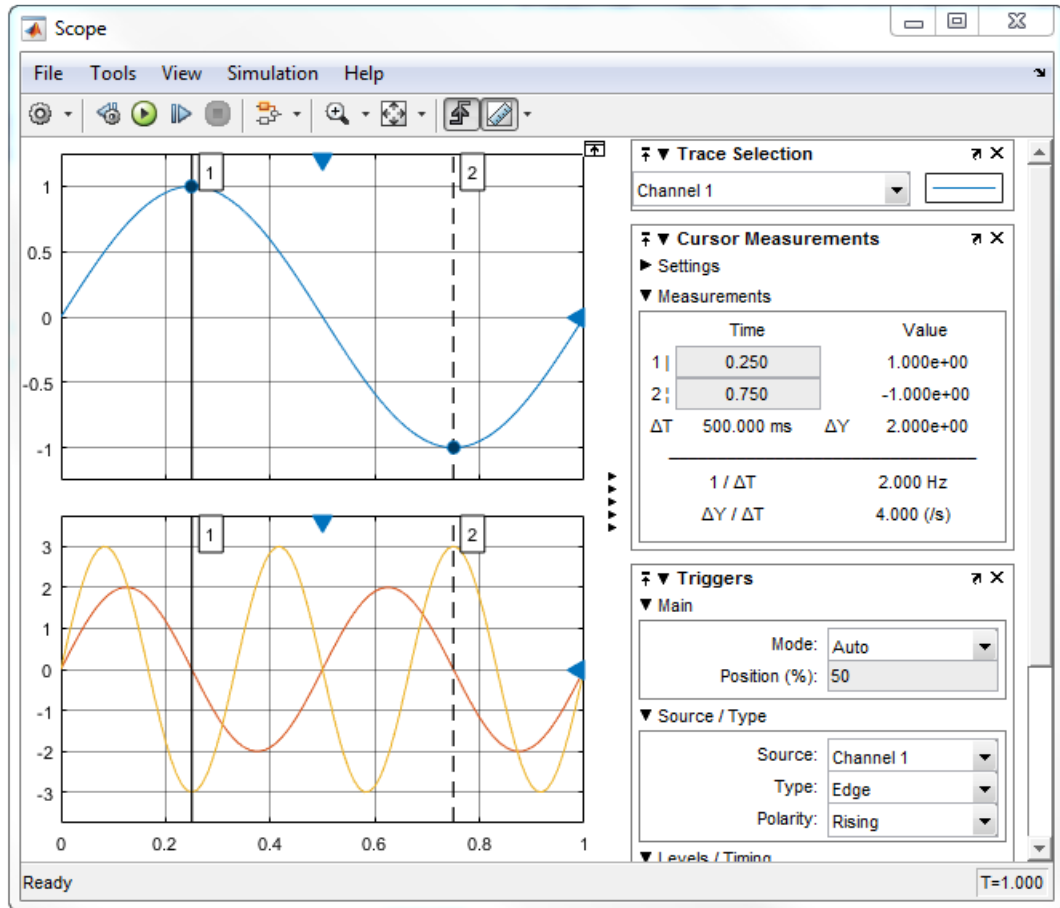

For more information, see “Scope Blocks and Scope Viewer Overview” on page 26-8.

## Simulation Data Inspector

If you run your simulation more than once and want to inspect or compare data between simulations, you can use the Simulation Data Inspector. You can stream and store

signals from the model and compare data between multiple simulations. For example, you can check to see if the difference between two signals is within a certain design tolerance. In the Simulation Data Inspector, you can:

- View signals — Inspect signal data while your model is simulating.
- Import data — Import time series data from MAT-files or the base workspace.
- Compare signal data — Compare multiple simulation outputs to check the difference between runs.
- Export data and generate reports — Export plots and comparison data to share or archive results.

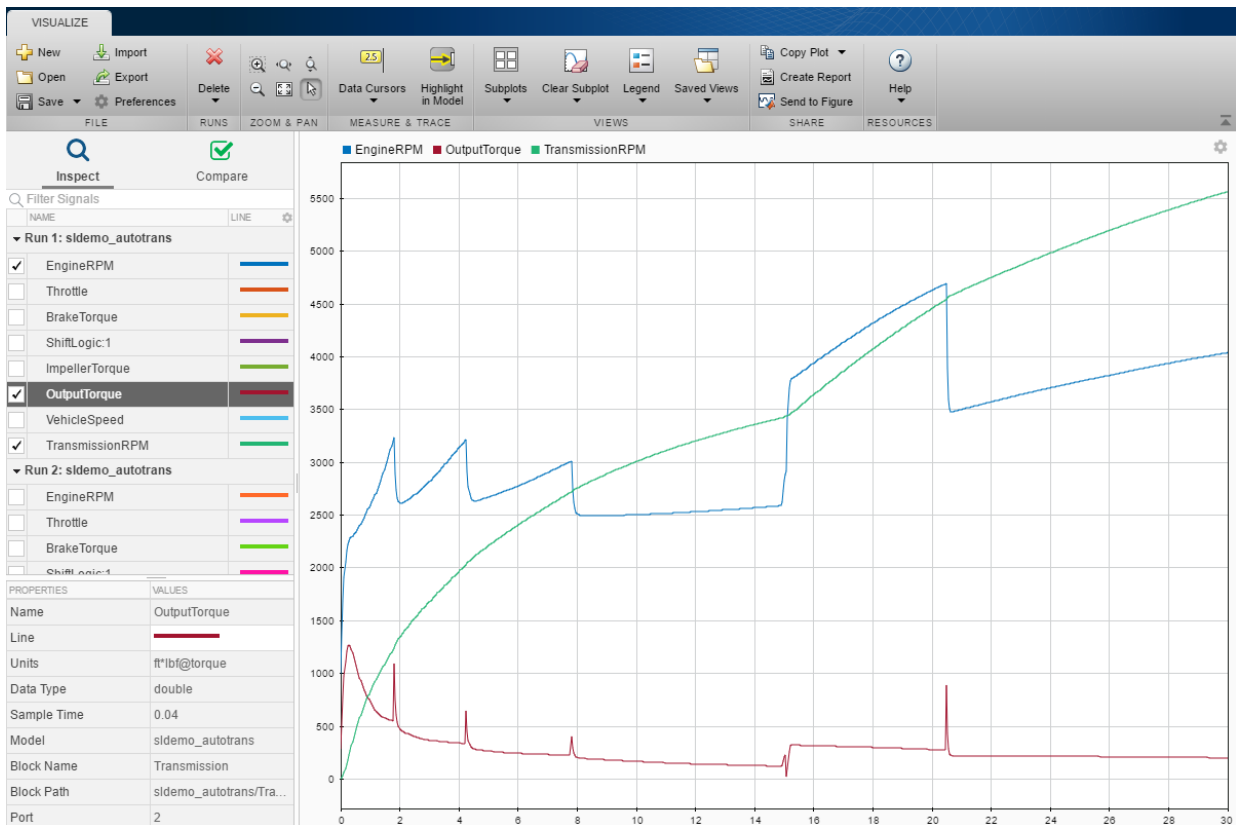

For more information, see “Simulation Data Inspector in Your Workflow” on page 27-2.

## Dashboard Controls and Displays

Create an interactive display of controls and displays within your model diagram using blocks from the Dashboard library. Connect block parameters to control blocks (Knobs, Buttons, and Switches) and signals to displays blocks. (Scopes and Gauges).

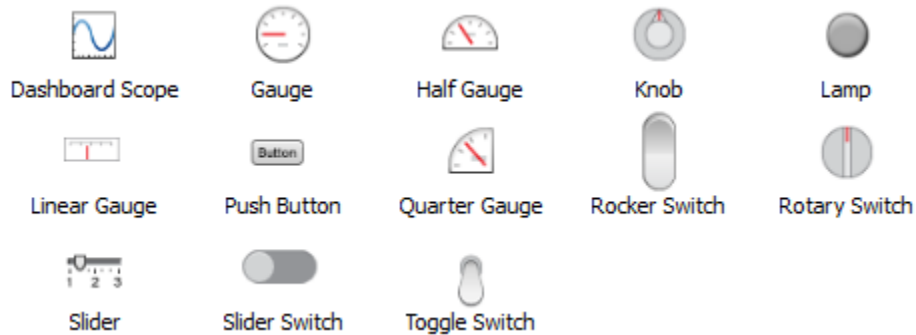

While a simulation is running, you can change parameter values using the controls. Signal values are updated continuously in the displays.

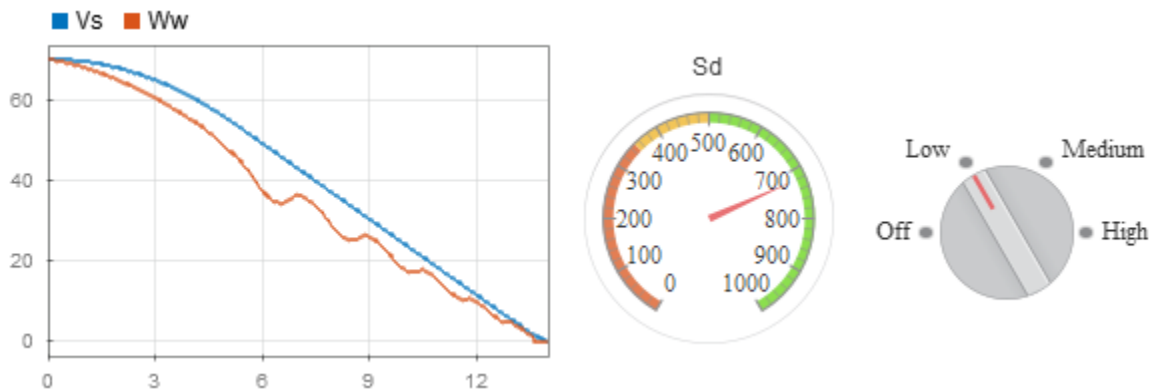

For more information, see “Tune and Visualize Your Model with Dashboard Blocks” on page 27-65.



## Output Block

Use Output blocks to save simulation data from the top-level of your model to the MATLAB workspace. Select and define the variables for saving data in the **Data Import/Export** pane of the Configuration Parameters dialog box. For example, select the **Time** and **Output** check boxes.



After running a simulation, you can use MATLAB plotting commands to display the simulation results. The variables `tout` and `yout` are the default variables returned by the solver after a simulation.

```
plot(tout,yout)
```

For more information, see “Model Configuration Parameters: Data Import/Export”.

## To Workspace Block

Use To Workspace blocks to save simulation data from anywhere in your model to the MATLAB workspace. Store a time vector by connecting a Clock block to a To Workspace block. You can also get a time vector using the `sim` command.

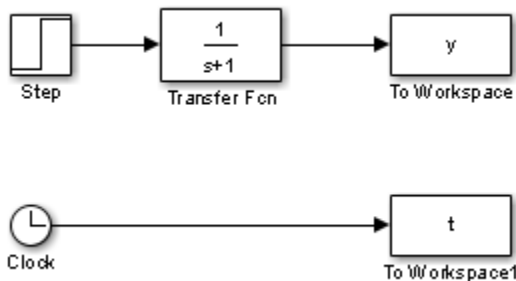

During a simulation, the blocks write data to an internal buffer. When you pause the simulation or it reaches the end time, data is written to the workspace and saved in the variables `y` and `t`.

For more information, see “Model Configuration Parameters: Data Import/Export”.

## Signal Logging Without Blocks

You can save simulation data to the MATLAB workspace without using blocks.

- 1 Select signals for logging. Right-click a signal line, select **Properties**, and then select the **Log signal data** check box.
- 2 Enable signal logging during a simulation. In the **Data Import/Export** pane of the Configuration Parameters dialog box, select the **Signal logging** check box and enter a variable name.

For more information, see Export Signal Data Using Signal Logging on page 59-70.

## See Also

Floating Scope | Outport | Scope | Scope Viewer | To Workspace

## Related Examples

- “Export Simulation Data” on page 59-4
- “Simulation Data Inspector in Your Workflow” on page 27-2
- “Scope Blocks and Scope Viewer Overview” on page 26-8
- “Tune and Visualize Your Model with Dashboard Blocks” on page 27-65

## Linearizing Models

### In this section...

“About Linearizing Models” on page 28-9

“Linearization with Referenced Models” on page 28-11

“Linearization Using the 'v5' Algorithm” on page 28-13

### About Linearizing Models

The Simulink product provides the `linmod`, `linmod2`, and `dlinmod` functions to extract linear models in the form of the state-space matrices  $A$ ,  $B$ ,  $C$ , and  $D$ . State-space matrices describe the linear input-output relationship as

$$\dot{x} = Ax + Bu$$

$$y = Cx + Du,$$

where  $x$ ,  $u$ , and  $y$  are state, input, and output vectors, respectively. For example, the following model is called `lmod`.

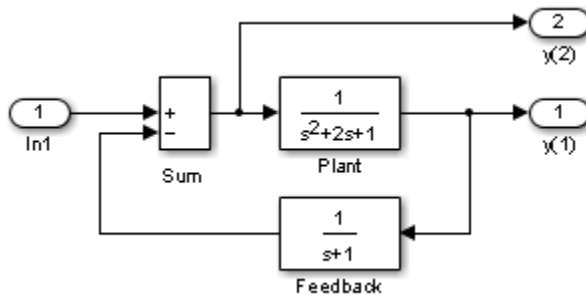

To extract the linear model of this system, enter this command.

```
[A,B,C,D] = linmod('lmod')
```

```
A =
    -2    -1    -1
```

```
      1      0      0
      0      1     -1
B =
      1
      0
      0
C =
      0      1      0
      0      0     -1
D =
      0
      1
```

Inputs and outputs must be defined using Inport and Outport blocks from the Ports & Subsystems library. Source and sink blocks do not act as inputs and outputs. Inport blocks can be used in conjunction with source blocks, using a Sum block. Once the data is in the state-space form or converted to an LTI object, you can apply functions in the Control System Toolbox product for further analysis:

- Conversion to an LTI object  
`sys = ss(A,B,C,D);`
- Bode phase and magnitude frequency plot  
`bode(A,B,C,D)` or `bode(sys)`
- Linearized time response  
`step(A,B,C,D)` or `step(sys)`  
`impulse(A,B,C,D)` or `impulse(sys)`  
`lsim(A,B,C,D,u,t)` or `lsim(sys,u,t)`

You can use other functions in the Control System Toolbox and the Robust Control Toolbox™ products for linear control system design.

When the model is nonlinear, an operating point can be chosen at which to extract the linearized model. Extra arguments to `linmod` specify the operating point.

```
[A,B,C,D] = linmod('sys', x, u)
```

For discrete systems or mixed continuous and discrete systems, use the function `dlinmod` for linearization. This function has the same calling syntax as `linmod` except that the second right-hand argument must contain a sample time at which to perform the linearization.

## Linearization with Referenced Models

You can use `linmod` to extract a linear model from a Simulink environment that contains Model blocks.

---

**Note** In Normal mode, the `linmod` command applies the block-by-block linearization algorithm on blocks inside the referenced model. If the Model block is in Accelerator mode, the `linmod` command uses numerical perturbation to linearize the referenced model. Due to limitations on linearizing multirate Model blocks in Accelerator mode, you should use Normal mode simulation for all models referenced by Model blocks when linearizing with referenced models. For an explanation of the block-by-block linearization algorithm, see the Simulink Control Design™ documentation.

---

For example, consider the f14 model `mdlref_f14`. The Aircraft Dynamics Model block refers to the model `mdlref_dynamics`.

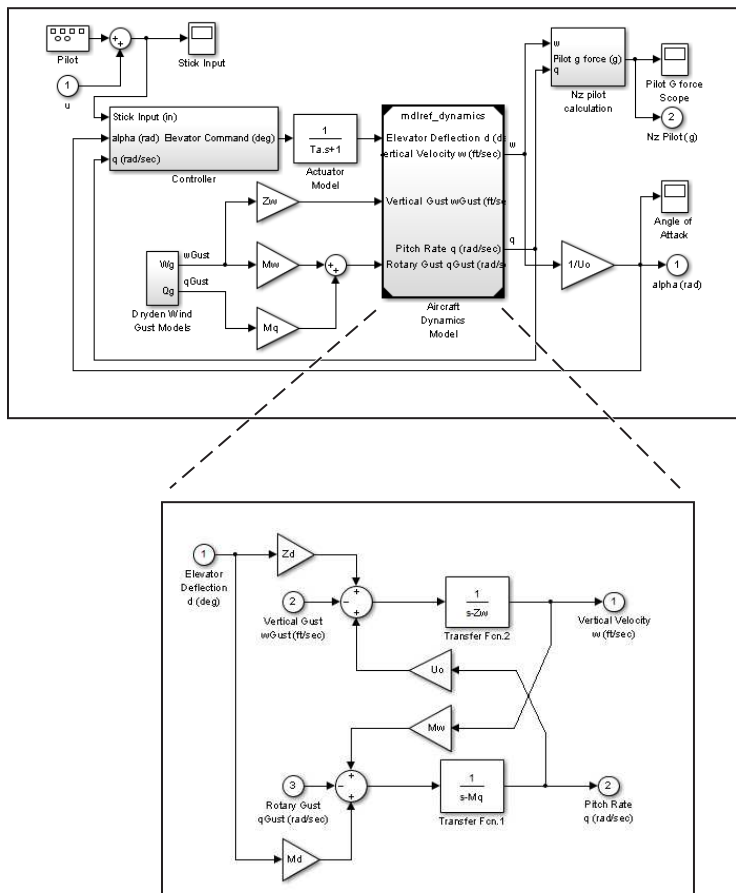

To linearize the `mdlref_f14` model, call the `linmod` command on the top `mdlref_f14` model as follows.

```
[A,B,C,D] = linmod('mdlref_f14')
```

The resulting state-space model corresponds to the complete `f14` model, including the referenced model.

You can call `linmod` with a state and input operating point for models that contain Model blocks. When using operating points, the state vector  $x$  refers to the total state vector for the top model and any referenced models. You must enter the state vector using the structure format. To get the complete state vector, call

```
x = Simulink.BlockDiagram.getInitialState(topModelName)
```

## Linearization Using the 'v5' Algorithm

Calling the `linmod` command with the 'v5' argument invokes the perturbation algorithm created prior to MATLAB software version 5.3. This algorithm also allows you to specify the perturbation values used to perform the perturbation of all the states and inputs of the model.

```
[A,B,C,D]=linmod('sys',x,u,para,xpert,upert,'v5')
```

Using `linmod` with the 'v5' option to linearize a model that contains Derivative or Transport Delay blocks can be troublesome. Before linearizing, replace these blocks with specially designed blocks that avoid the problems. These blocks are in the Simulink Extras library in the Linearization sublibrary.

You access the Extras library by opening the Blocksets & Toolboxes icon:

- For the Derivative block, use the Switched derivative for linearization.

When using a Derivative block, you can also try to incorporate the derivative term in other blocks. For example, if you have a Derivative block in series with a Transfer Fcn block, it is better implemented (although this is not always possible) with a single Transfer Fcn block of the form

$$\frac{s}{s+a}$$

In this example, the blocks on the left of this figure can be replaced by the block on the right.

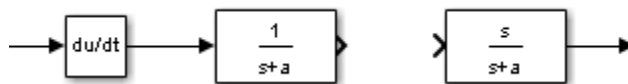

## See Also

`dlinmod` | `linmod`

## Finding Steady-State Points

The Simulink `trim` function uses a model to determine steady-state points of a dynamic system that satisfy input, output, and state conditions that you specify. Consider, for example, this model, called `ex_lmod`.

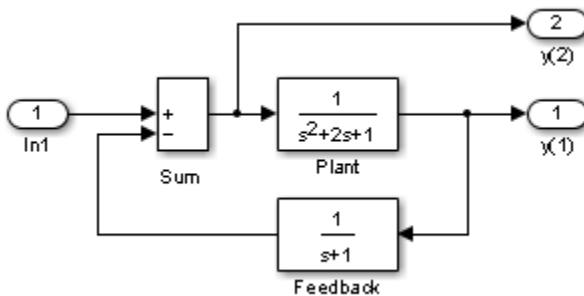

You can use the `trim` function to find the values of the input and the states that set both outputs to 1. First, make initial guesses for the state variables (`x`) and input values (`u`), then set the desired value for the output (`y`).

```
x = [0; 0; 0];
u = 0;
y = [1; 1];
```

Use index variables to indicate which variables are fixed and which can vary.

```
ix = [];      % Don't fix any of the states
iu = [];      % Don't fix the input
iy = [1;2];   % Fix both output 1 and output 2
```

Invoking `trim` returns the solution. Your results might differ because of roundoff error.

```
[x,u,y,dx] = trim('lmod',x,u,y,ix,iu,iy)
```

```
x =
    0.0000
    1.0000
    1.0000
u =
     2
y =
```



```
1.0000
1.0000
dx =
1.0e-015 *
-0.2220
-0.0227
0.3331
```

Note that there might be no solution to equilibrium point problems. If that is the case, `trim` returns a solution that minimizes the maximum deviation from the desired result after first trying to set the derivatives to zero. For a description of the `trim` syntax, see `trim`.

## See Also

`trim`



# Improving Simulation Performance and Accuracy

---

- “How Optimization Techniques Improve Performance and Accuracy” on page 29-2
- “Speed Up Simulation” on page 29-3
- “How Profiler Captures Performance Data” on page 29-5
- “Check and Improve Simulation Accuracy” on page 29-11
- “Modeling Techniques That Improve Performance” on page 29-13
- “Use Performance Advisor to Improve Simulation Efficiency” on page 29-20

## How Optimization Techniques Improve Performance and Accuracy

The design of a model and choice of configuration parameters can affect simulation performance and accuracy. Solvers handle most model simulations accurately and efficiently with default parameter values. However, some models yield better results when you adjust solver parameters. Information about the behavior of a model can help you improve simulation performance, particularly when you provide this information to the solver. Use optimization techniques to better understand the behavior of your model and modify the model settings to improve performance and accuracy.

To optimize your model and achieve faster simulation automatically using Performance Advisor, see “Automated Performance Optimization”.

To learn more about accelerator modes for faster simulation, see “Acceleration”.

### Related Examples

- “Speed Up Simulation” on page 29-3
- “Check and Improve Simulation Accuracy” on page 29-11
- “How Profiler Captures Performance Data” on page 29-5

### More About

- “Modeling Techniques That Improve Performance” on page 29-13

## Speed Up Simulation

Several factors can slow simulation. Check your model for some of these conditions.

- Your model includes an Interpreted MATLAB Function block. When a model includes an Interpreted MATLAB Function block, the MATLAB execution engine is called at each time step, drastically slowing down the simulation. Use the built-in Fcn block or the Math Function block whenever possible.
- Your model includes a MATLAB file S-function. MATLAB file S-functions also call the MATLAB execution engine at each time step. Consider converting the S-function either to a subsystem or to a C-MEX file S-function.
- Your model includes a Memory block. Using a Memory block causes the variable-order solvers (`ode15s` and `ode113`) to reset back to order 1 at each time step.
- The maximum step size is too small. If you changed the maximum step size, try running the simulation again with the default value (`auto`).
- Your accuracy requirements are too high. The default relative tolerance (0.1% accuracy) is usually sufficient. For models with states that go to zero, if the absolute tolerance parameter is too small, the simulation can take too many steps around the near-zero state values. See the discussion of this error in “Maximum order” “Maximum order” in the online documentation.
- The time scale is too long. Reduce the time interval.
- The problem is stiff, but you are using a nonstiff solver. Try using `ode15s`. For more information, see “Stiffness of System” on page 29-17.
- The model uses sample times that are not multiples of each other. Mixing sample times that are not multiples of each other causes the solver to take small enough steps to ensure sample time hits for all sample times.
- The model contains an algebraic loop. The solutions to algebraic loops are iteratively computed at every time step. Therefore, they severely degrade performance. For more information, see “Algebraic Loops” on page 3-38.
- Your model feeds a Random Number block into an Integrator block. For continuous systems, use the Band-Limited White Noise block in the Sources library.
- Your model contains a scope viewer that displays too many data points. Try adjusting the viewer property settings that can affect performance. For more information, see Scope Viewer.
- You need to simulate your model iteratively. You change tunable parameters between iterations but do not make structural changes to the model. Every iteration requires

the model to compile again, thus increasing overall simulation time. Use fast restart to perform iterative simulations. In this workflow, the model compiles only once and iterative simulations are tied to a single compile phase. See “How Fast Restart Improves Iterative Simulations” on page 68-2 for more information.

### **Related Examples**

- “How Profiler Captures Performance Data” on page 29-5
- “Check and Improve Simulation Accuracy” on page 29-11

### **More About**

- “How Optimization Techniques Improve Performance and Accuracy” on page 29-2
- “Modeling Techniques That Improve Performance” on page 29-13
- “How Fast Restart Improves Iterative Simulations” on page 68-2

## How Profiler Captures Performance Data

### In this section...

“How Profiler Works” on page 29-5

“Start Profiler” on page 29-7

“Save Profiler Results” on page 29-10

### How Profiler Works

Profiler captures performance data while your model simulates. It identifies the parts of your model that require the most time to simulate. Use the profiling information to decide where to focus your model optimization efforts.

---

**Note:** You cannot use Profiler in Rapid Accelerator mode.

---

Simulink stores performance data in the *simulation profile report*. The data shows the time spent executing each function in your model.

The basis for Profiler is an execution model that this pseudocode summarizes.

```

Sim()
  ModelInitialize().
  ModelExecute()
    for t = tStart to tEnd
      Output()
      Update()
      Integrate()
        Compute states from derivs by repeatedly calling:
          MinorOutput()
          MinorDeriv()
        Locate any zero crossings by repeatedly calling:
          MinorOutput()
          MinorZeroCrossings()
      EndIntegrate
    Set time t = tNew.
  EndModelExecute
ModelTerminate
  
```

EndSim

According to this conceptual model, Simulink runs a model by invoking the following functions zero, one, or many times, depending on the function and the model.

Function	Purpose	Level
sim	Simulate the model. This top-level function invokes the other functions required to simulate the model. The time spent in this function is the total time required to simulate the model.	System
ModelInitialize	Set up the model for simulation.	System
ModelExecute	Execute the model by invoking the output, update, integrate, etc., functions for each block at each time step from the start to the end of simulation.	System
Output	Compute the outputs of a block at the current time step.	Block
Update	Update the state of a block at the current time step.	Block
Integrate	Compute the continuous states of a block by integrating the state derivatives at the current time step.	Block
MinorOutput	Compute block output at a minor time step.	Block
MinorDeriv	Compute the state derivatives of a block at a minor time step.	Block
MinorZeroCrossings	Compute zero-crossing values of a block at a minor time step.	Block
ModelTerminate	Free memory and perform any other end-of-simulation cleanup.	System
Nonvirtual Subsystem	Compute the output of a nonvirtual subsystem at the current time step by invoking the output, update, integrate, etc., functions for each block that	Block



Function	Purpose	Level
	it contains. The time spent in this function is the time required to execute the nonvirtual subsystem.	

Profiler measures the time required to execute each invocation of these functions. After the model simulates, Profiler generates a report that describes the amount of simulation time spent on each function.

## Start Profiler

- 1 Open the model.
- 2 Select **Analysis > Performance Tools > Show Profiler Report**.
- 3 Simulate the model.

When simulation is complete, Simulink generates and displays the simulation profile for the model in a MATLAB web browser.

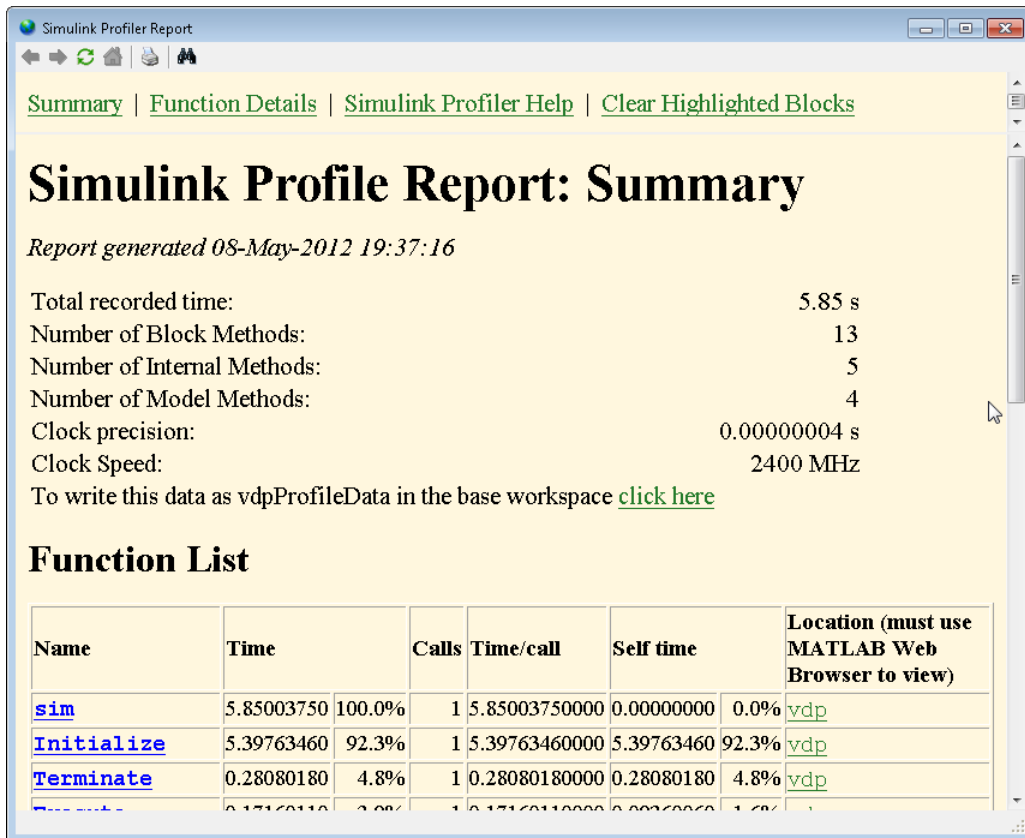

### Summary Section

The summary file displays the following performance totals.

Item	Description
<b>Total Recorded Time</b>	Total time required to simulate the model
<b>Number of Block Methods</b>	Total number of invocations of block-level functions (e.g., <code>Output()</code> )
<b>Number of Internal Methods</b>	Total number of invocations of system-level functions (e.g., <code>ModelExecute</code> )
<b>Number of Model Methods</b>	Number of methods called by the model

Item	Description
<b>Number of Nonvirtual Subsystem Methods</b>	Total number of invocations of nonvirtual subsystem functions
<b>Clock Precision</b>	Precision of the profiler's time measurement
<b>Clock Speed</b>	Speed of the profiler's time measurement

The function list shows summary profiles for each function invoked to simulate the model. For each function listed, the summary profile specifies this information.

Item	Description
<b>Name</b>	Name of function. This item is a hyperlink. Click it to display a detailed profile of this function.
<b>Time</b>	Total time spent executing all invocations of this function as an absolute value and as a percentage of the total simulation time.
<b>Calls</b>	Number of times this function was invoked.
<b>Time/Call</b>	Average time required for each invocation of this function, including the time spent in functions invoked by this function.
<b>Self Time</b>	Total time required to execute this function, excluding time spent in functions called by this function.
<b>Location</b>	Specifies the block or model executed for which this function is invoked. This item is a hyperlink. Click it to highlight the corresponding element in the model diagram.

### Detailed Profile Section

This section of the report contains detailed profiles for each function that Simulink invoked to simulate the model. In addition to the information in the summary profile for the function, the detailed profile displays the function (parent function) that invoked the profiled function and the functions (child functions) invoked by the profiled function. Click the name of the parent or a child function to see the detailed profile for that function.

---

**Note:** Enabling Profiler on a parent model does not enable profiling for referenced models. You must enable profiling separately for each referenced model. Profiling occurs only if the referenced model executes in Normal mode. See “Normal Mode” on page 33-4 for more information.

---

## Save Profiler Results

You can save the Profiler report to a variable in the MATLAB workspace, and after that, to a `mat` file. At a later time, you can regenerate and review the report.

Save the Profiler report for a model `vdp` to the variable `profile1` and to the data file `report1.mat`.

**1** In the **Simulink Profiler Report** window, in the **Summary** section, click **click here** link. Simulink saves the report data to the variable `vdpProfileData`.

**2** Review the report. At the MATLAB command prompt, enter:

```
slprofreport(vdpProfileData)
```

**3** Save the data to a variable named `profile1` in the base workspace.

```
profile1 = vdpProfileData;
```

**4** Save the data to a `mat` file named `report1`.

```
save report1 profile1
```

To view the report later, at the MATLAB command prompt, enter:

```
load report1  
slprofreport(profile1);
```

## Related Examples

- “Speed Up Simulation” on page 29-3
- “Check and Improve Simulation Accuracy” on page 29-11

## More About

- “How Optimization Techniques Improve Performance and Accuracy” on page 29-2
- “Modeling Techniques That Improve Performance” on page 29-13

# Check and Improve Simulation Accuracy

## Check Simulation Accuracy

- 1 Simulate the model over a reasonable time span.
- 2 Reduce either the relative tolerance to  $1e-4$  (the default is  $1e-3$ ) or the absolute tolerance.
- 3 Simulate the model again.
- 4 Compare the results from both simulations.

If the results are not significantly different, the solution has converged.

If the simulation misses significant behavior at the start, reduce the initial step size to ensure that the simulation does not step over that behavior.

## Unstable Simulation Results

When simulation results become unstable over time,

- The system can be unstable.
- If you are using the `ode15s` solver, try restricting the maximum order to 2 (the maximum order for which the solver is A-stable). You can also try using the `ode23s` solver.

## Inaccurate Simulation Results

If simulation results are not accurate:

- For a model that has states whose values approach zero, if the absolute tolerance parameter is too large, the simulation takes too few steps around areas of near-zero state values. Reduce this parameter value in the **Solver pane** of model configuration parameters or adjust it for individual states in the function block parameters of the Integrator block.
- If reducing the absolute tolerances does not improve simulation accuracy enough, reduce the size of the relative tolerance parameter. This change reduces the acceptable error and forces smaller step sizes and more steps.

Certain modeling constructs can also produce unexpected or inaccurate simulation results.

- A Source block that inherits sample time can produce different simulation results if, for example, the sample times of the downstream blocks are modified (see “How Propagation Affects Inherited Sample Times” on page 7-38).
- A Derivative block found in an algebraic loop can result in a loss in solver accuracy.

### **Related Examples**

- “Speed Up Simulation” on page 29-3
- “How Profiler Captures Performance Data” on page 29-5

### **More About**

- “How Optimization Techniques Improve Performance and Accuracy” on page 29-2
- “Modeling Techniques That Improve Performance” on page 29-13

## Modeling Techniques That Improve Performance

### In this section...

“Accelerate the Initialization Phase” on page 29-13

“Reduce Model Interactivity” on page 29-14

“Reduce Model Complexity” on page 29-15

“Choose and Configure a Solver” on page 29-16

“Save the Simulation State” on page 29-18

### Accelerate the Initialization Phase

Speed up a simulation by accelerating the initialization phase, using these techniques.

#### Simplify Graphics Using Mask Editor

Complex graphics and large images take a long time to load and render. Masked blocks that contain such images can make your model less responsive. Where possible, remove complex drawings and images from masked blocks.

If you want to keep the image, replace it with a smaller, low-resolution version. Use mask editor and edit the icon drawing commands to keep the image that is loaded by the call to `image()`.

For more information on mask editor, see “Mask Editor Overview”.

#### Consolidate Function Calls

When you open or update a model, Simulink runs the mask initialization code. If your model contains complicated mask initialization commands that contain many calls to `set_param`, consolidate consecutive calls into a single call with multiple argument pairs. Consolidating the calls can reduce the overhead associated with these function calls.

To learn more, see “Mask Callback Code” on page 37-18.

#### Load Data Using MAT-file

If you use MATLAB scripts to load and initialize data, you can improve performance by loading MAT-files instead. The data in a MAT-file is in binary and can be more difficult to work with than a script. However, the load operation typically initializes data more quickly than the equivalent MATLAB script.

For more information, see “MAT-Files for Signal Data” on page 59-15.

## Reduce Model Interactivity

In general, the more interactive a model is, the longer it takes to simulate. Use these techniques to reduce the interactivity of your model.

### Disable Debugging Diagnostics

Some enabled diagnostic features can slow simulations considerably. Consider disabling them in the model configuration parameters **Diagnostics** pane and in the **Diagnostics** category of the **All Parameters** tab.

---

**Note:** Running **Array bounds exceeded** and **Solver data inconsistency** can slow down model runtime performance. For more information, see “Array bounds exceeded” and “Solver data inconsistency”.

---

### Disable MATLAB Debugging

After verifying that your MATLAB code works correctly, disable these checks in the model configuration parameters **Simulation Target** pane.

- **Enable debugging/animation**
- **Detect wrap on overflow (with debugging)**
- **Echo expressions without semicolons**

For more information, see “Model Configuration Parameters: Simulation Target”.

### Use BLAS Library Support

If your simulation involves low-level MATLAB matrix operations, use the Basic Linear Algebra Subprograms (BLAS) libraries to make use of highly optimized external linear algebra routines.

### Disable Stateflow Animations

By default, Stateflow charts highlight the current active states in a model and animate the state transitions that take place as the model simulates. This feature is useful for debugging, but it slows the simulation.



To accelerate simulations, either close all Stateflow charts or disable the animation. Similarly, consider disabling animation or reducing scene fidelity when you use:

- Simulink 3D Animation
- Simscape Multibody visualization
- FlightGear
- Any other 3D animation package

To learn more, see “Speed Up Simulation” (Stateflow).

### **Adjust Scope Viewer Properties**

If your model contains a scope viewer that displays a high rate of logging and you cannot remove the scope, adjust the viewer properties to trade off fidelity for rendering speed.

However, when you use decimation to reduce the number of plotted data points, you can miss short transients and other phenomena that you can see with more data points. To have more precise control over enabling visualizations, place viewers in enabled subsystems.

For more information, see Scope Viewer.

## **Reduce Model Complexity**

Use these techniques to improve simulation performance by simplifying a model without sacrificing fidelity.

### **Replace Subsystems with Lower-Fidelity Alternatives**

Replace a complex subsystem with one of these alternatives:

- A linear or nonlinear dynamic model that was created from measured input-output data using the System Identification Toolbox™.
- A high-fidelity, nonlinear statistical model that was created using the Model-Based Calibration Toolbox™.
- A linear model that was created using Simulink Control Design.
- A lookup table. For more information, see A lookup table.

You can maintain both representations of the subsystem in a library and use variant subsystems to manage them. Depending on the model, you can make this replacement

without affecting the overall result. For more information, see “Optimize Generated Code for Lookup Table Blocks” on page 36-44.

### Reduce Number of Blocks

When you reduce the number of blocks in your model, fewer blocks require updates during simulations and simulation is faster.

- Vectorization is one way to reduce your block count. For example, if you have several parallel signals that undergo a similar set of computations, try to combine them into a vector using a Mux block and perform a single computation.
- You can also enable the **Block Reduction** parameter in the **Configuration Parameters > All Parameters** tab.

### Use Frame-Based Processing

In frame-based processing, Simulink processes samples in batches instead of one at a time. If a model includes an analog-to-digital converter, for example, you can collect output samples in a buffer. Process the buffer in a single operation, such as a fast Fourier transform. Processing data in chunks this way reduces the number of times that the simulation needs to invoke blocks in your model.

In general, the scheduling overhead decreases as frame size increases. However, larger frames consume more memory, and memory limitations can adversely affect the performance of complex models. Experiment with different frame sizes to find one that maximizes the performance benefit of frame-based processing without causing memory issues.

### Choose and Configure a Solver

Simulink provides a comprehensive library of solvers, including fixed-step and variable-step solvers, to handle stiff and nonstiff systems. Each solver determines the time of the next simulation step. A solver applies a numerical method to solve ordinary differential equations that represent the model.

The solver you choose and the solver options you select can affect simulation speed. Select and configure a solver that helps boost the performance of your model using these criteria. For more information, see “Choose a Solver” (Global Optimization Toolbox).

### **Stiffness of System**

A stiff system has continuous dynamics that vary slowly and quickly. Implicit solvers are particularly useful for stiff problems. Explicit solvers are better suited for nonstiff systems. Using an explicit solver to solve a stiff system can lead to incorrect results. If a nonstiff solver uses a very small step size to solve a model, this is a sign that your system is stiff.

### **Model Step Size and Dynamics**

When you are deciding between using a variable-step or fixed-step solver, keep in mind the step size and dynamics of your model. Select a solver that uses time steps to capture only the dynamics that are important to you. Choose a solver that performs only the calculations needed to work out the next time step.

You use fixed-step solvers when the step size is less than or equal to the fundamental sample time of the model. With a variable-step solver, the step size can vary because variable-step solvers dynamically adjust the step size. As a result, the step size for some time steps is larger than the fundamental sample time, reducing the number of steps required to complete the simulation. In general, simulations with variable-step solvers run faster than those that run with fixed-step solvers.

Choose a fixed-step solver when the fundamental sample time of your model is equal to one of the sample rates. Choose a variable-step solver when the fundamental sample time of your model is less than the fastest sample rate. You can also use variable-step solvers to capture continuous dynamics.

### **Decrease Solver Order**

When you decrease the solver order, you reduce the number of calculations that Simulink performs to determine state outputs, which improves simulation speed. However, the results become less accurate as the solver order decreases. Choose the lowest solver order that produces results with acceptable accuracy.

### **Increase Solver Step Size or Error Tolerance**

Increasing the solver step size or error tolerance usually increases simulation speed at the expense of accuracy. Make these changes with care because they can cause Simulink to miss potentially important dynamics during simulations.

## Disable Zero-Crossing Detection

Variable-step solvers dynamically adjust the step size, increasing it when a variable changes slowly and decreasing it when a variable changes rapidly. This behavior causes the solver to take many small steps near a discontinuity because this is when a variable changes rapidly. Accuracy improves, but often at the expense of long simulation times.

To avoid the small time steps and long simulations associated with these situations, Simulink uses zero-crossing detection to locate such discontinuities accurately. For systems that exhibit frequent fluctuations between modes of operation—a phenomenon known as chattering—this zero-crossing detection can have the opposite effect and thus slow down simulations. In these situations, you can disable zero-crossing detection to improve performance.

You can enable or disable zero-crossing detection for specific blocks in a model. To improve performance, consider disabling zero-crossing detection for blocks that do not affect the accuracy of the simulation.

For more information, see “Zero-Crossing Detection” on page 3-24.

## Save the Simulation State

In the classic workflow, a Simulink model simulates repeatedly for different inputs, boundary conditions, and operating conditions. In many situations, these simulations share a common startup phase in which the model transitions from the initial state to another state. For example, you can bring an electric motor up to speed before you test various control sequences.

Using `SimState`, you can save the simulation state at the end of the startup phase and then restore it for use as the initial state for future simulations. This technique does not improve simulation speed, but it can reduce total simulation time for consecutive runs because the startup phase needs to be simulated only once.

See “Save and Restore Simulation State as `SimState`” on page 23-37 for more information.

## Related Examples

- “Speed Up Simulation” on page 29-3
- “How Profiler Captures Performance Data” on page 29-5

## **More About**

- “How Optimization Techniques Improve Performance and Accuracy” on page 29-2
- “Check and Improve Simulation Accuracy” on page 29-11

## Use Performance Advisor to Improve Simulation Efficiency

Use Performance Advisor to check for conditions and configuration settings that can cause inefficient simulation performance. Performance Advisor analyzes a model and produces a report with suboptimal conditions or settings that it finds. It suggests better model configuration settings where appropriate, and provides mechanisms for fixing issues automatically or manually.

### Related Examples

- “Performance Advisor Workflow” on page 30-2
- “Improve Simulation Performance Using Performance Advisor” on page 30-2

### More About

- “Improve Simulation Performance Using Performance Advisor” on page 30-2
- “How Optimization Techniques Improve Performance and Accuracy” on page 29-2

# Performance Advisor

---

- “Improve Simulation Performance Using Performance Advisor” on page 30-2
- “Perform a Quick Scan Diagnosis” on page 30-14
- “Improve vdp Model Performance” on page 30-16
- “Performance Advisor Window” on page 30-22

## Improve Simulation Performance Using Performance Advisor

In this section...
“Performance Advisor Workflow” on page 30-2
“Prepare Your Model” on page 30-3
“Create a Performance Advisor Baseline Measurement” on page 30-5
“Run Performance Advisor Checks” on page 30-6
“View and Respond to Results” on page 30-8
“View and Save Performance Advisor Reports” on page 30-11

Whatever the level of complexity of your model, you can make systematic changes that improve simulation performance. Performance Advisor checks for configuration settings that slow down your model simulations. It produces a report that lists the suboptimal conditions or settings it finds and suggests better configuration settings where appropriate.

You can use the Performance Advisor to fix some of these suboptimal conditions automatically or you can fix them manually.

---

**Note:** Use Performance Advisor on top models. Performance Advisor does not traverse referenced models or library links.

---

To learn about faster simulation using acceleration modes, see “Acceleration”.

### Performance Advisor Workflow

When the performance of a model is slower than expected, use Performance Advisor to help identify and resolve bottlenecks.

- 1 Prepare your model.
- 2 Create a baseline to compare measurements against.
- 3 Select the checks you want to run.
- 4 Run Performance Advisor with the selected checks and see recommended changes.
- 5 Make changes to the model. You can either:



- Automatically apply changes.
  - Generate advice, and review and apply changes manually.
- 6** After applying changes, Performance Advisor performs a final validation of the model to see how performance has improved.
- If the performance improves, the selected checks were successful. The performance check is complete.
  - If the performance is worse than the baseline, Performance Advisor reinstates the previous settings of the model.
- 7** Save your model.

---

**Caution:** Performance Advisor does not automatically save your model after it makes changes. When you are satisfied with the changes to the model from Performance Advisor, save the model.

---

## Prepare Your Model

Before running checks using Performance Advisor, complete the following steps:

- “Start Performance Advisor” on page 30-3
- “Enable Data Logging for the Model” on page 30-4
- “Select How Performance Advisor Applies Advice” on page 30-4
- “Select Validation Actions for the Advice” on page 30-4
- “Specify Runtime for Performance Advisor” on page 30-5

### Start Performance Advisor

To get started with Performance Advisor:

- 1** Make a backup of the model.
- 2** Verify that the model can simulate without error.
- 3** Close all applications, including web browsers. Leave only the MATLAB Command Window, the model you want to analyze, and Performance Advisor running.

Running other applications can hinder the performance of model simulation and the ability of Performance Advisor to measure accurately.

- 4 Open Performance Advisor. In the Simulink Editor, select **Analysis > Performance Tools > Performance Advisor**.

### Enable Data Logging for the Model

Make sure the model configuration parameters are set to enable data logging.

- 1 In the model, select **Simulation > Model Configuration Parameters**.
- 2 In the Configuration Parameters dialog box, click **Data Import/Export** in the left pane.
- 3 Set up signal logging. The model must log at least one signal for Performance Advisor to work. For example, select the **States** or **Output** check box.
- 4 Click **Configure Signals to Log** and select the signals to log.

---

**Note:** Select only the signals you are most interested in. Minimizing the number of signals to log can help performance. Selecting too many signals can cause Performance Advisor to run for a longer time.

---

- 5 Click **OK** in the Configuration Parameters dialog box.
- 6 Run the model once to make sure that the simulation is successful.

### Select How Performance Advisor Applies Advice

Choose from these options to apply advice to the model:

- **Use check parameters.** Select the checks for which you want Performance Advisor to automatically apply advice. You can review the remaining checks and apply advice manually.
- **Automatically for all checks.** Performance Advisor automatically applies advice to all selected checks.
- **Generate advice only.** Review advice for each check and apply changes manually.

### Select Validation Actions for the Advice

For the checks you want to run, validate an improvement in simulation time and accuracy by comparing against a baseline measurement. Each validation action requires the model to simulate. Use these validation options as global settings for the checks you select:

- **Use check parameters.** From the checks you want to run, select the ones for which you want to validate an improvement in performance. Specify validation action for fixes using individual settings for these checks.
- **For all checks.** Performance Advisor automatically validates an improvement in performance for the checks you select.
- **Do not validate.** Performance Advisor does not validate an improvement in performance. Instead, you can validate manually. When you select this option and also specify for Performance Advisor to apply advice automatically, a warning appears before Performance Advisor applies changes without validation.

These global settings for validation apply to all checks in the left pane except the Final Validation check. The Final Validation check validates the overall performance improvement in a model after you have applied changes. In case you do not want to validate changes resulting from other check results, you can run the Final Validation check to validate model changes for simulation time and accuracy.

### **Specify Runtime for Performance Advisor**

You can specify a **Time Out** value in minutes if you want to limit the runtime duration of Performance Advisor. Use this option when running Performance Advisor on models with long simulation times.

If Performance Advisor times out before completing the checks you specify, in the left pane you can see the checks that failed.

## **Create a Performance Advisor Baseline Measurement**

A baseline measurement is a set of simulation measurements that Performance Advisor measures check results against.

---

**Note:** Before creating a baseline measurement, set the model configuration parameters to enable data logging. For more information, see “Enable Data Logging for the Model” on page 30-16.

---

- 1 In the model, select **Analysis > Performance Tools > Performance Advisor** to start Performance Advisor.
- 2 In the left pane, in the Baseline folder, select **Create Baseline**.

- 3 In the right pane, under **Input Parameters**, enter a value in the **Stop Time** field for the baseline.

When you enter a Stop Time value in Performance Advisor, this overrides the value set in the model. A large stop time can create a simulation that runs longer.

If you do not enter a value, Performance Advisor uses values from the model. Performance Advisor uses values from the model that are less than 10. Performance Advisor rounds values from the model larger than 10 to 10.

- 4 Select the **Check to view baseline signals and set their tolerances** check box to start the Signal Data Inspector after Performance Advisor runs a check. Using the Signal Data Inspector, you can compare signals and adjust tolerance levels.
- 5 Click **Run This Check**.

When a baseline has been created, a message like the following appears under **Analysis**:

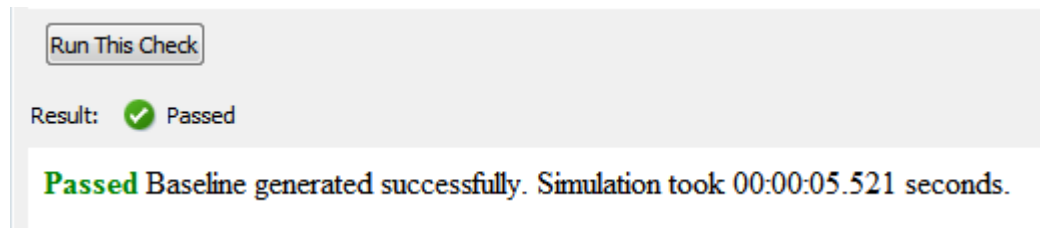

After the baseline has been created, you can run Performance Advisor checks.

## Run Performance Advisor Checks

- 1 After you have created a baseline measurement, select checks to run.
  - In the left pane of Performance Advisor, expand a folder, such as **Simulation** or **Simulation Targets**, to display checks related to specific tasks.
  - In the folder, select the checks you want to run using the check boxes.

---

**Tip:** If you are unsure of which checks apply, you can select and run all checks. After you see the results, clear the checks you are not interested in.

---

- 2 Specify input parameters for selected checks. Use one of these methods:

- Apply global settings to all checks to take action, validate simulation time and validate simulation accuracy.
- Alternatively, for each check, in the right pane, specify input parameters.

Input Parameter	Description
<b>Take action based on advice</b>	<p><b>automatically</b> — Allow Performance Advisor to automatically make the change for you.</p> <p><b>manually</b> — Review the change first. Then manually make the change or accept Performance Advisor recommendations.</p>
<b>Validate and revert changes if time of simulation increases</b>	Select this check box to have Performance Advisor rerun the simulation and verify that the change made based on the advice improves simulation time. If the change does not improve simulation time, Performance Advisor reverts the changes.
<b>Validate and revert changes if degree of accuracy is greater than tolerance</b>	Select this check box to have Performance Advisor rerun the simulation and verify that, after the change, the model results are still within tolerance. If the result is outside tolerance, Performance Advisor reverts the changes.
<b>Quick estimation of model build time</b>	Select this check box to have Performance Advisor use the number of blocks of a referenced model to estimate model build time.

- 3 To run a single check, click **Run This Check** from the settings for the check. Performance Advisor displays the results in the right pane.

You can also select multiple checks from the left pane and click **Run Selected Checks** from the right pane. Select **Show report after run** to display the results of the checks after they run.

- 4 To limit the run time of Performance Advisor, specify a **Time Out** value in minutes. Use this option for models with long simulation times. The default setting for this option is 60 minutes.

---

**Note:** The **Time Out** setting does not apply to a Quick Scan diagnosis.

---

Performance Advisor also generates an HTML report of the current check results and actions in a file with a name in the form *model\_name\report\_#.html*

To view this report in a separate window, click the **Report** link in the right pane.

---

**Note:** If you rename a system, you must restart Performance Advisor to check that system.

---

## View and Respond to Results

After you run checks with Performance Advisor, the right pane shows the results:

**Identify simulation target settings**

Analysis

Disabling simulation target settings, such as 'Echo expression without semicolons', can improve simulation speed.

Input Parameters

Take action based on advice:

Validate and revert changes if time of simulation increases

Validate and revert changes if degree of accuracy is greater than tolerance

Result: Warning

The simulation target setting 'Echo expressions without semicolons' is enabled. Disabling this setting might improve simulation speed. Review the following settings in the Model Configuration of model 'vdp'.

Performance Advisor has taken the necessary actions. For details, see the Action Results section.

Severity	Diagnostics checked	Original Value	New Value
	<a href="#">Simulation Target &gt; Echo expressions without semicolons</a>	on	off

Action

Review the action results

Result:

Summary of performance validations			
	Before this check	After this check	Improvement
<b>Performance</b>			
<b>Accuracy</b>	Within given tolerance	<a href="#">Within given tolerance Click to view</a>	
<b>Simulation Time</b>	00:00:34.970	00:00:02.036	<b>94.18%</b>

Analysis →

Action →

To view the results of a check, in the left pane, select the check you ran. The right pane updates with the results of the check. This pane has two sections.

The **Analysis** section contains:

- Information about the check
- Option to run the simulation
- Settings to take action based on advice from Performance Advisor
- Result of the check (Passed, Failed or Warning)

The **Action** section contains:

- A setting to manually accept all recommendations for the check
- Summary of actions taken based on the recommendations for the check

## Respond to Results

Use the **Take action based on advice** parameter in the **Analysis** section to select how to respond to changes that Performance Advisor suggests.

Value	Response
automatically	<ul style="list-style-type: none"> <li>Performance Advisor makes the change for you.</li> <li>You can evaluate the changes using the links in the summary table.</li> <li>The <b>Modify All</b> button in the <b>Action</b> section is grayed out since Performance Advisor has already made all recommended changes for you.</li> </ul>
manually	<ul style="list-style-type: none"> <li>Performance Advisor does not make the change for you.</li> <li>The links in the summary table show recommendations.</li> <li>Use the <b>Modify All</b> button in the <b>Action</b> section to implement all recommendations after reviewing them. Depending on how you set your validation input parameters before you ran the check, the button label can change to <b>Modify All and Validate</b>.</li> </ul>

## Review Actions

The **Action** section contains a summary of the actions that Performance Advisor took based on the **Input Parameters** setting. If the tool also performed validation actions, this section lists the results in a summary table. If performance has not improved, Performance Advisor reports that it reinstated the model to the settings it had before the check ran.

The screenshot displays the 'Action' section of the Performance Advisor interface. At the top, it says 'Review the action results' and has a button labeled 'Modify all and validate'. Below this, the 'Result:' section contains a table titled 'Summary of performance validations'. The table has four columns: 'Before this check', 'After this check', and 'Improvement'. The rows are: 'Performance' (no values, green checkmark), 'Accuracy' (Within given tolerance, Within given tolerance, Click to view, green checkmark), and 'Simulation Time' (00:00:04.276, 00:00:02.412, 43.59%). Below the table is a 'Summary of actions' section with an 'Actions:' label.

Severity	Description
	The actions succeeded. The table lists the percentage of improvement.



Severity	Description
	The actions failed. For example, if Performance Advisor cannot make a recommended change, it flags it as failed. It also flags a check as failed if performance did not improve and reinstates the model to the settings it had before the check ran.

**Caution:** Performance Advisor does not automatically save your model after it makes changes. When you are satisfied with the changes to the model from Performance Advisor, save the model.

## View and Save Performance Advisor Reports

When Performance Advisor runs checks, it generates HTML reports of the results. To view a report, select a folder in the left pane and click the link in the **Report** box in the right pane.

As you run checks, Performance Advisor updates the reports with the latest information for each check in the folder. Time stamps indicate when checks ran.

In the pane for global settings, when you select **Show report after run**, Performance Advisor displays a consolidated set of check results in the report.

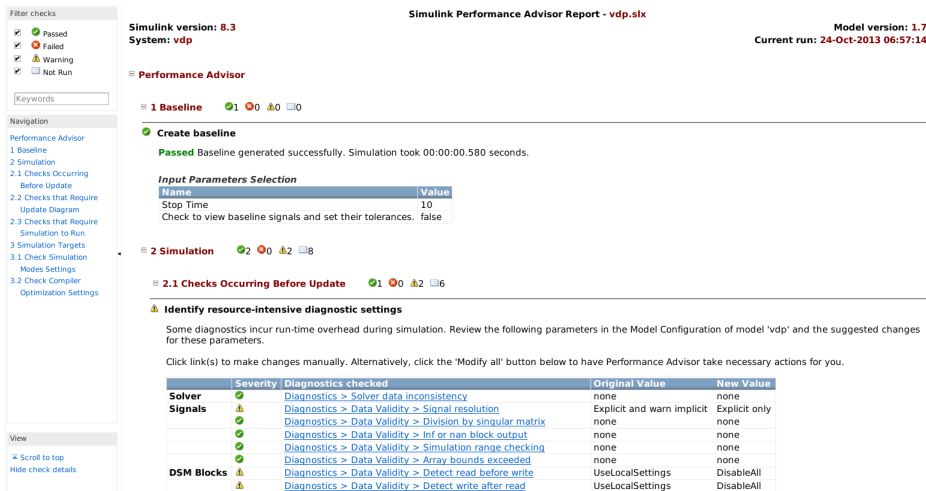

**Simulink Performance Advisor Report - vdp.slx**

Simulink version: 8.3  
System: vdp

Model version: 1.7  
Current run: 24-Oct-2013 06:57:14

**Performance Advisor**

1 Baseline 01 00 00 00

**Create baseline**

Passed Baseline generated successfully. Simulation took 00:00:00.580 seconds.

**Input Parameters Selection**

Name	Value
Stop Time	10

Check to view baseline signals and set their tolerances. false









2 Simulation 02 00 02 08

2.1 Checks Occurring Before Update 01 00 02 06

**Identify resource-intensive diagnostic settings**

Some diagnostics incur run-time overhead during simulation. Review the following parameters in the Model Configuration of model 'vdp' and the suggested changes for these parameters.

Click link(s) to make changes manually. Alternatively, click the 'Modify all' button below to have Performance Advisor take necessary actions for you.

Severity	Diagnostics checked	Original Value	New Value
	Diagnostics > Solver_data_inconsistency	none	none
	Diagnostics > Data Validity > Signal resolution	Explicit and warn implicit	Explicit only
	Diagnostics > Data Validity > Division by singular matrix	none	none
	Diagnostics > Data Validity > Inf or nan block output	none	none
	Diagnostics > Data Validity > Simulation range checking	none	none
	Diagnostics > Data Validity > Array bounds exceeded	none	none
	Diagnostics > Data Validity > Detect read before write	UseLocalSettings	DisableAll
	Diagnostics > Data Validity > Detect write after read	UseLocalSettings	DisableAll

You can perform these actions using the Performance Advisor report:

- Use the check boxes under **Filter checks** to view only the checks with the status that you are interested in viewing. For example, to see only the checks that failed or gave warnings, clear the **Passed** and **Not Run** check boxes.
- Perform a keyword search using the search box under **Filter checks**.
- Use the tree of checks under **Navigation** to jump to the category of checks or a specific check result that interests you.
- Expand and collapse content in the right pane of the report to view or hide check results.

Some checks have input parameters that you specify in the right pane of Performance Advisor. For example, **Identify resource intensive diagnostic settings** has several input parameters. When you run checks that have input parameters, Performance Advisor displays the values of the input parameters in the report.

#### Identify resource-intensive diagnostic settings

Some diagnostics incur run-time overhead during simulation. Review the following parameters in the Model Configuration of model 'vdp' and the suggested changes for these parameters.

Performance Advisor has taken the necessary actions. For details, see the Action Results section.

Severity	Diagnostics checked	Original Value	New Value
Solver	Diagnosics > Solver data inconsistency	none	none
Signals	Diagnosics > Data Validity > Signal resolution	Explicit and warn implicit	Explicit only
	Diagnosics > Data Validity > Division by singular matrix	none	none

▼ More (8 rows)

#### Input Parameters Selection

Name	Value
Take action based on advice	automatically
Validate and revert changes if time of simulation increases	true
Validate and revert changes if degree of accuracy is greater than tolerance	true

## Save Performance Advisor Reports

You can archive a Performance Advisor report by saving it to a new location. Performance Advisor does not update the saved version of a report when you run checks again. Archived reports serve as good points of comparison when you run checks again.

- 1 In the left pane of the Performance Advisor window, select the folder of checks for the report you want to save.
- 2 In the **Report** box, click **Save As**.
- 3 In the **Save As** dialog box, navigate to where you want to save the report, and click **Save**. Performance Advisor saves the report to the new location.

## Related Examples

- “Improve vdp Model Performance” on page 30-16

- “Perform a Quick Scan Diagnosis” on page 30-14

### **More About**

- “Simulink Performance Advisor Checks”
- “Acceleration”

### **External Websites**

- Improving Simulation Performance in Simulink

## Perform a Quick Scan Diagnosis

Quick Scan is a fast method to diagnose settings in a model and deliver an approximate analysis of performance. A model can compile and simulate several times during a normal run in Performance Advisor. Quick Scan enables you to review performance issues without compiling or changing the model or validating any fixes. In models with long compile times, use Quick Scan to get a rapid analysis of possible improvements.

When you perform a Quick Scan diagnosis, Performance Advisor

- Does not perform a baseline measurement.
- Does not automatically apply advice to the model.
- Does not validate any changes you make to the model.
- Does not time out if the Quick Scan diagnosis takes longer than the **Time Out** duration you specify.

### Run Quick Scan on a Model

- 1 Select checks to run.

---

**Tip:** If you are unsure of which checks apply, you can select and run all checks. After you see the results, clear the checks you are not interested in.

---

- In the left pane of Performance Advisor, expand a folder, such as **Simulation** or **Simulation Targets**, to display checks related to specific tasks.
  - In the folder, select the checks you want to run using the check boxes.
- 2 Select the **Show report after run** checkbox to display the results of the checks after they run.
  - 3 Click **Quick Scan** on the right pane.

### Checks in Quick Scan Mode

- “Identify resource-intensive diagnostic settings”
- “Check optimization settings”
- “Identify inefficient lookup table blocks”

- “Check MATLAB System block simulation mode”
- “Identify Interpreted MATLAB Function blocks”
- “Identify simulation target settings”
- “Check model reference rebuild setting”

### **Related Examples**

- “Improve Simulation Performance Using Performance Advisor” on page 30-2
- “Improve vdp Model Performance” on page 30-16

## Improve vdp Model Performance

### In this section...

- “Enable Data Logging for the Model” on page 30-16
- “Create Baseline” on page 30-16
- “Select Checks and Run” on page 30-17
- “Review Results” on page 30-18
- “Apply Advice and Validate Manually” on page 30-20

This example shows you how to run Performance Advisor on the vdp model, review advice, and make changes to improve performance.

### Enable Data Logging for the Model

- 1 In the vdp model, select **Simulation > Model Configuration Parameters**.
- 2 In the Configuration Parameters dialog box, click **Data Import/Export** in the left pane.
- 3 Set up signal logging. The model must log at least one signal for Performance Advisor to work. For example, select the **States** or **Output** check box.
- 4 Click **Configure Signals to Log**.
- 5 To select signals to log, select a signal in vdp. Right click and select **Properties**.
- 6 In the Signal Properties dialog box, check the **Log signal data** option and click **OK**.
- 7 Click **OK** in the Configuration Parameters dialog box.
- 8 Run the model once to make sure that the simulation is successful.

### Create Baseline

- 1 Open Performance Advisor. In the vdp model, select **Analysis > Performance Tools > Performance Advisor**.
- 2 In the right pane, under **Set Up**, select a global setting for **Take Action**. To automatically apply advice to the model, select **automatically for all checks**.
- 3 Select global settings to validate any improvements in simulation time and accuracy after applying advice. To select the default setting for validation, for **Validate simulation time** and **Validate simulation accuracy**, select **use check parameters**.

---

**Note:** To validate any improvements automatically, change the global settings to **For all checks**. However, this can increase simulation time as validating all checks requires more simulation runs.

---

- 4 Select **Show report after run**. This opens an HTML report of check results.
- 5 In the left pane, select the **Create baseline** check. Clear the other checks.
- 6 In the **Create baseline** pane, set **Stop Time** to 10. Click **Apply**.
- 7 Click **Run This Check**. The right pane updates to show that the baseline was created successfully.

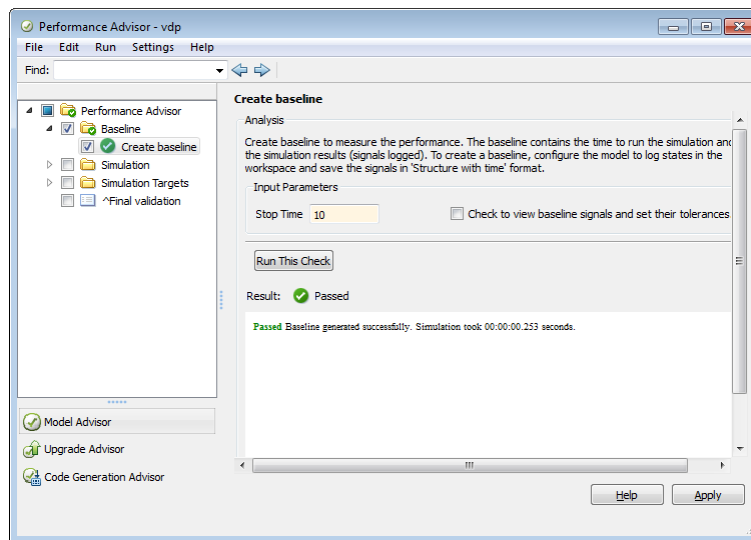

## Select Checks and Run

---

**Note:** The global input parameters to take action and validate improvement apply to all the checks you select.

---

- 1 In the left pane, clear the baseline check. Select these checks:

- In **Simulation > Checks Occurring Before Update**, select **Identify resource-intensive diagnostic settings**.
  - In **Simulation > Checks that Require Update Diagram**, select **Check model reference parallel build**.
  - In **Simulation Targets > Check Compiler Optimization Settings**, select **Select compiler optimizations on or off**.
  - Select **Final validation**.
- 2** For every check that you have selected in the left pane, select options in the right pane to validate any improvements in simulation time and accuracy. Note that **Take Action based on advice** is set to **automatically**, a result of **Take Action** being set to **automatically** for all checks.
  - 3** Select a value for **Time Out** if you want to limit the runtime duration of Performance Advisor.
  - 4** Click **Run Selected Checks**.

Performance Advisor runs the checks you selected and opens an HTML report with check results.

## Review Results

- 1** In the HTML report, filter the results to see only the checks that passed.



Simulink Performance Advisor Report - vdp.slx

Simulink version: 8.3  
System: vdp  
Treat as Referenced Model: off

**Performance Advisor**

- 1 Baseline ✔0 ✘0 ⚠0 📄1
- 2 Simulation ✔1 ✘0 ⚠1 📄10
  - 2.1 Checks Occurring Before Update ✔0 ✘0 ⚠1 📄8
  - 2.2 Checks that Require Update Diagram ✔1 ✘0 ⚠0 📄1
  - 2.3 Checks that Require Simulation to Run ✔0 ✘0 ⚠0 📄1
- 3 Simulation Targets ✔1 ✘0 ⚠0 📄1
  - 3.1 Check Simulation Modes Settings ✔0 ✘0 ⚠0 📄1
  - 3.2 Check Compiler Optimization Settings ✔1 ✘0 ⚠0 📄0

✔ Final validation

All of the selected checks passed successfully.

- 2 Navigate to the results for a particular check, for example **Check model reference parallel build**. Use the navigation tree in the left pane or scroll to the results for this check in the right pane.
- 3 Performance Advisor gives you information about this check, advice for performance improvement, as well as a list of related model configuration parameters.

✔ **Check model reference parallel build**

**Passed**

There are less than two reference models in your model. Parallel building is unnecessary. However, consider using model reference for large models. Use more than one model reference to take advantage of parallel building.

*Input Parameters Selection*

Name	Value
Quick estimation of model build time	true
Parallel build overhead time estimation factor	0.5

- 4 Filter the results to display warnings. See results for the **Identify resource-intensive diagnostic settings** check.

Performance Advisor identified diagnostic settings that incur runtime overhead during simulation. It modified values for some of these diagnostics. A table in the report shows the diagnostics checked and whether Performance Advisor suggested a change to the value.

If the performance of the model improved, the HTML report gives you information about this improvement. If the performance has deteriorated, Performance Advisor discards all changes and reinstates the original settings in the model.

## 5 See details for the **Final Validation** check.

### ✔ Final validation

Summary of performance validations			
	Before this check	After this check	Improvement
<b>Performance</b>			✔
<b>Accuracy</b>	Within given tolerance	Within given tolerance <a href="#">Click to view</a>	✔
<b>Simulation Time</b>	00:00:00.253	00:00:00.100	60.38%

### Passed

Overall, Performance advisor has improved the performance of the model.

#### Input Parameters Selection

Name	Value
Take action based on advice	automatically
Validate and revert changes if time of simulation increases	true
Validate and revert changes if degree of accuracy is greater than tolerance	true

This check validates the overall performance improvement in the model. The check results show changes in simulation time and accuracy, depending on whether performance improved or degraded.

## Apply Advice and Validate Manually

Generate advice for a check, apply it, and validate any improvements manually.

- 1 In the left pane, click **Performance Advisor**. Select these settings and click **Apply**:
  - Set **Take Action** to generate advice only.
  - Set **Validate simulation time** to use check parameters.
  - Set **Validate simulation accuracy** to use check parameters.
- 2 For every check that you have selected in the left pane, select options in the right pane to validate any improvements in simulation time and accuracy. Note that **Take**

**Action based on advice** is set to **manually**, a result of **Take Action** being set to **generate advice only**.

- 3** Select **Performance Advisor** in the left pane. Click **Run Selected Checks** in the Performance Advisor pane.

If the performance of the model has improved, the **Final Validation** check results show the overall performance improvement.

- 4** In the results for **Identify resource-intensive diagnostic settings**, Performance Advisor suggests new values for the diagnostics it checked. Review these results to accept or reject the values it suggests.

Alternatively, click **Modify all and Validate** to accept all changes and validate any improvement in performance.

## Related Examples

- “Improve Simulation Performance Using Performance Advisor” on page 30-2
- “Perform a Quick Scan Diagnosis” on page 30-14

## Performance Advisor Window

When you open Performance Advisor, it displays two panes.

In the left pane, the performance checks you can run are stored in folders. Expand the folders to see the checks within and select checks to run. You can search for folders and checks using **Find** above the pane.

Use the right pane to:

- Understand the Performance Advisor workflow
- Set up the model to run checks
- Select actions to apply generated advice and validate check results
- Learn more about each check
- Specify input parameters
- Run checks
- View and save reports
- View Performance Advisor results

After you run a check, Performance Advisor displays the results in the right pane. The right pane changes depending on the check you have selected.

Selection	Right Pane Display
Folder	<p><b>Analysis</b> pane, containing:</p> <ul style="list-style-type: none"> <li>• <b>Run Selected Checks</b> button — Click to run the selected checks in the folder and its subfolders.</li> <li>• <b>Show report after run</b> check box — Select to display an HTML report of the check results in a separate window.</li> </ul> <p><b>Report</b> pane, containing:</p> <ul style="list-style-type: none"> <li>• Link to HTML report of check results</li> <li>• <b>Save As</b> button — Click to export the HTML report to a specific location</li> </ul> <p><b>Tips</b> and <b>Legend</b> panes, containing brief descriptions on using the checks.</p>

Selection	Right Pane Display
Check	<p data-bbox="497 303 832 331"><b>Analysis</b> pane, containing:</p> <ul data-bbox="497 361 1277 496" style="list-style-type: none"> <li data-bbox="497 361 1277 453">• Input Parameters section — Before running checks, specify how you want checks to run (for more information, see “Run Performance Advisor Checks” on page 30-6).</li> <li data-bbox="497 465 1173 496">• Result section — Display results after a check runs.</li> </ul> <p data-bbox="497 522 807 550"><b>Action</b> pane, containing:</p> <ul data-bbox="497 579 1329 743" style="list-style-type: none"> <li data-bbox="497 579 1329 671">• <b>Modify</b> button — After the check runs, Performance Advisor suggests actions to take to improve performance. Click here to accept the recommendations and modify the model.</li> <li data-bbox="497 683 1329 743">• Result section — Display results after performing recommended actions.</li> </ul>

From Performance Advisor, you can also run:

- **Model Advisor** — Check a model or subsystem for conditions that result in inaccurate or inefficient simulation of the system. See “Run Model Checks”.
- **Upgrade Advisor** — Upgrade and improve models with the current release. See “Consult the Upgrade Advisor” on page 6-2.
- **Code Generation Advisor** — Configure the model to meet code generation objectives. See “Application Objectives Using Code Generation Advisor” (Simulink Coder).

## Related Examples

- “Improve Simulation Performance Using Performance Advisor” on page 30-2
- “Improve vdp Model Performance” on page 30-16



# Solver Profiler

---

- “Examine Model Dynamics Using Solver Profiler” on page 31-2
- “Understand Profiling Results” on page 31-6
- “Modify Solver Profiler Rules” on page 31-19
- “Customize State Ranking” on page 31-22
- “Solver Profiler Interface” on page 31-25

## Examine Model Dynamics Using Solver Profiler

When model simulation slows down or stops responding, a close examination of the dynamics of the model can help you identify the factors affecting the simulation.

Understanding solver behavior enables you to interpret how the model simulates and what causes the solver to take small steps.

The Solver Profiler, a tool for variable-step solvers, analyzes a model for patterns that affect its simulation. The Solver Profiler presents graphical and statistical information about the simulation, solver settings, events, and errors. You can use this data to identify locations in the model that caused simulation bottlenecks.

In addition, in simulations that use variable-step solvers, the size of the step can be limited due to various reasons. The Solver Profiler logs and reports all the events when the solver tries to take too large steps:

- Zero-crossing event
- Error control exception
- Newton iteration exception
- Differential algebraic equation (DAE) Newton iteration exception
- Infinite state exception

To examine model dynamics and identify causes that affect the simulation:

- 1 Open the model that is simulating slowly or unsuccessfully.



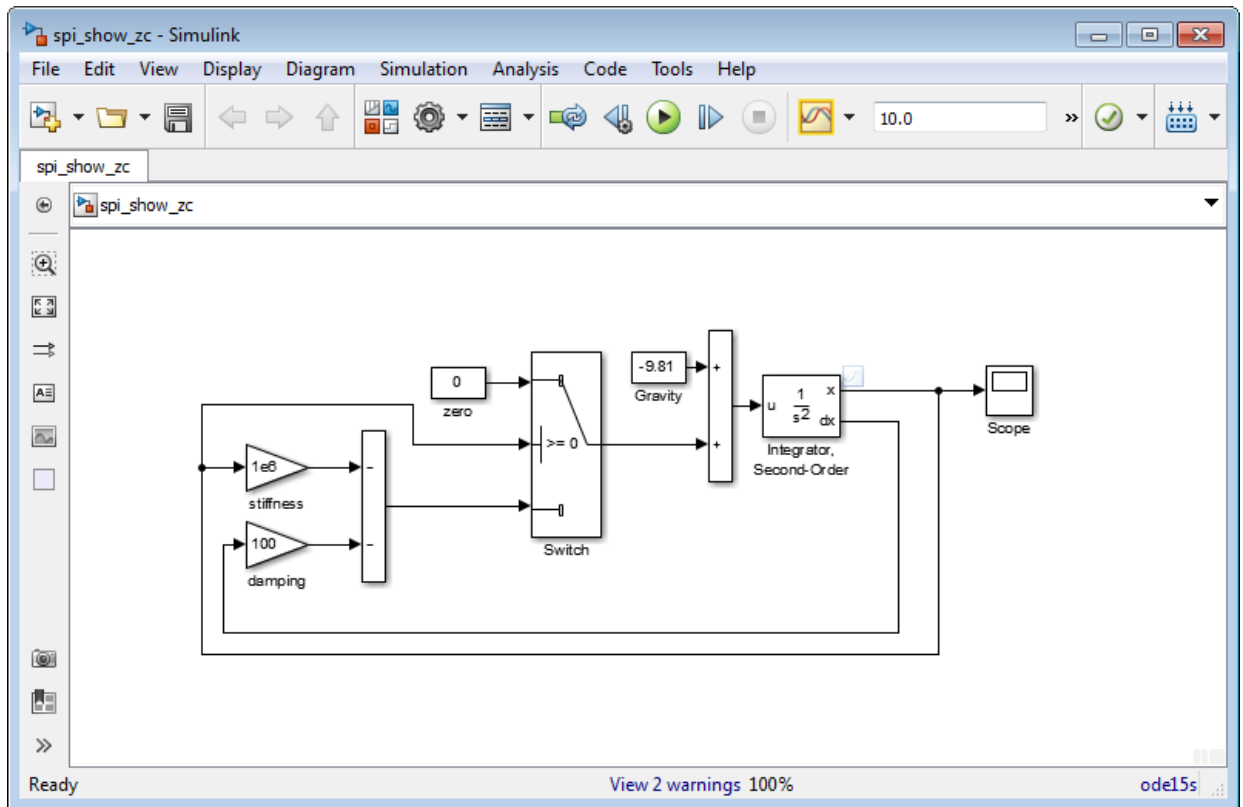

- Open the Solver Profiler by clicking the hyperlink in the lower-right corner of the Simulink Editor.

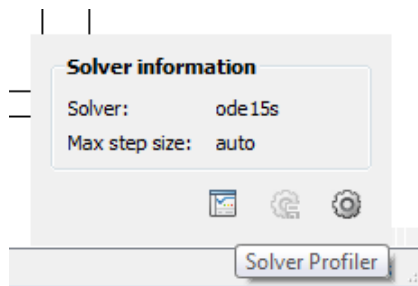

- 3 To log model states that have solver errors or exception events, select the **Continuous States** or **Simscape States** option before a run. Disable these options only if you are running out of memory. After the run, access the States Explorer or Simscape Explorer to examine those states.
- 4 Click **Run**. The profiler simulates the model and starts capturing solver performance data.

When the simulation ends, the profiler displays the statistics and exceptions it captured over the duration of the simulation.

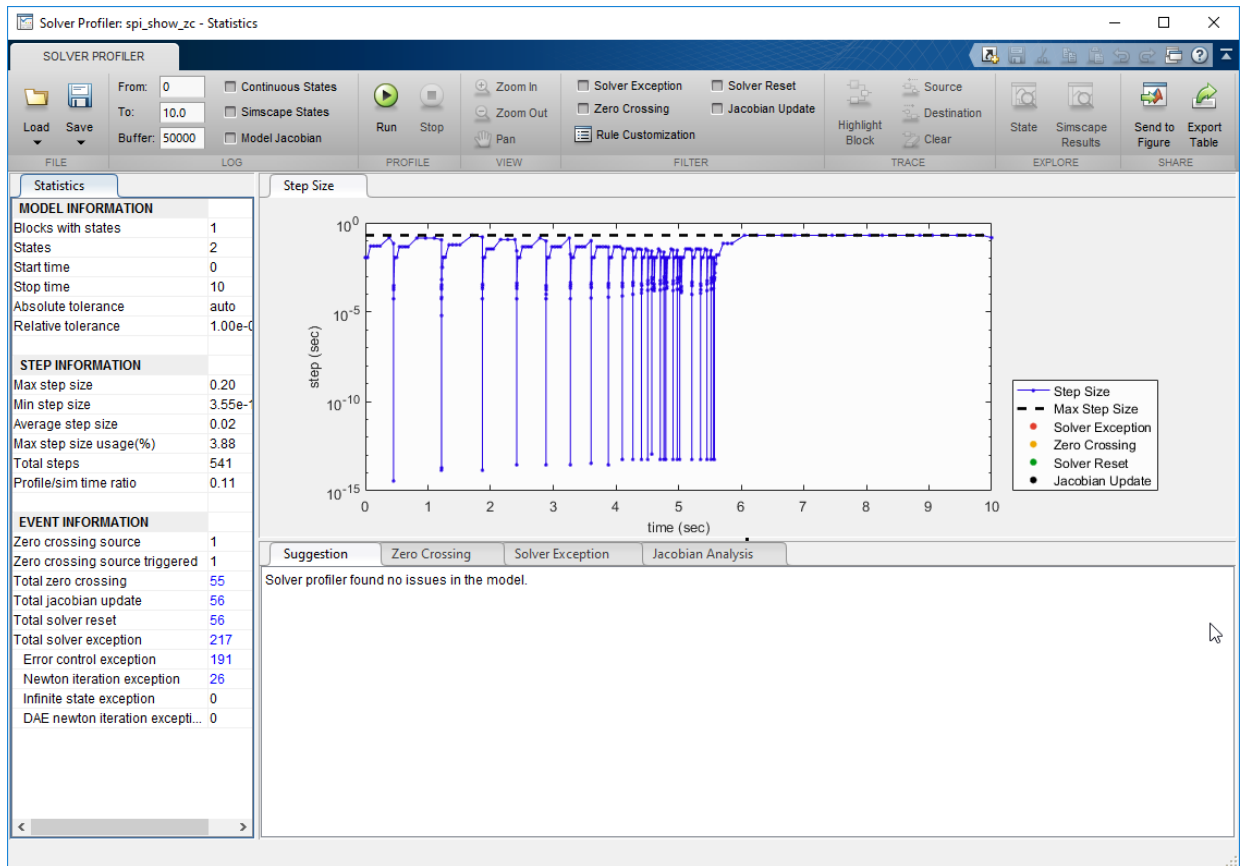

---

**Tip:** You can pause or stop the simulation at any time to view the information captured until that point.

---

- 5 Use the profiler plot to highlight the parts of the model that caused generate the most events.
- 6 Click **Save** to capture your profiling session, or exit without saving.

### **Related Examples**

- “Understand Profiling Results” on page 31-6

## Understand Profiling Results

In this section...
“Zero-Crossing Events” on page 31-6
“Tolerance-Exceeding Events” on page 31-9
“Newton Iteration Failures” on page 31-12
“Differential Algebraic Equation Failures” on page 31-14
“Jacobian Logging and Analysis” on page 31-17

If you have a large model, it can be challenging to identify which parts of your model cause the solver to take small steps. The Solver Profiler logs and reports events when the solver attempts to take large steps. This report of events helps you identify which parts of your model to focus on to improve solver performance.

This topic presents simple examples that illustrate various events that the profiler reports.

### Zero-Crossing Events

This example simulates a ball bouncing on a hard surface.

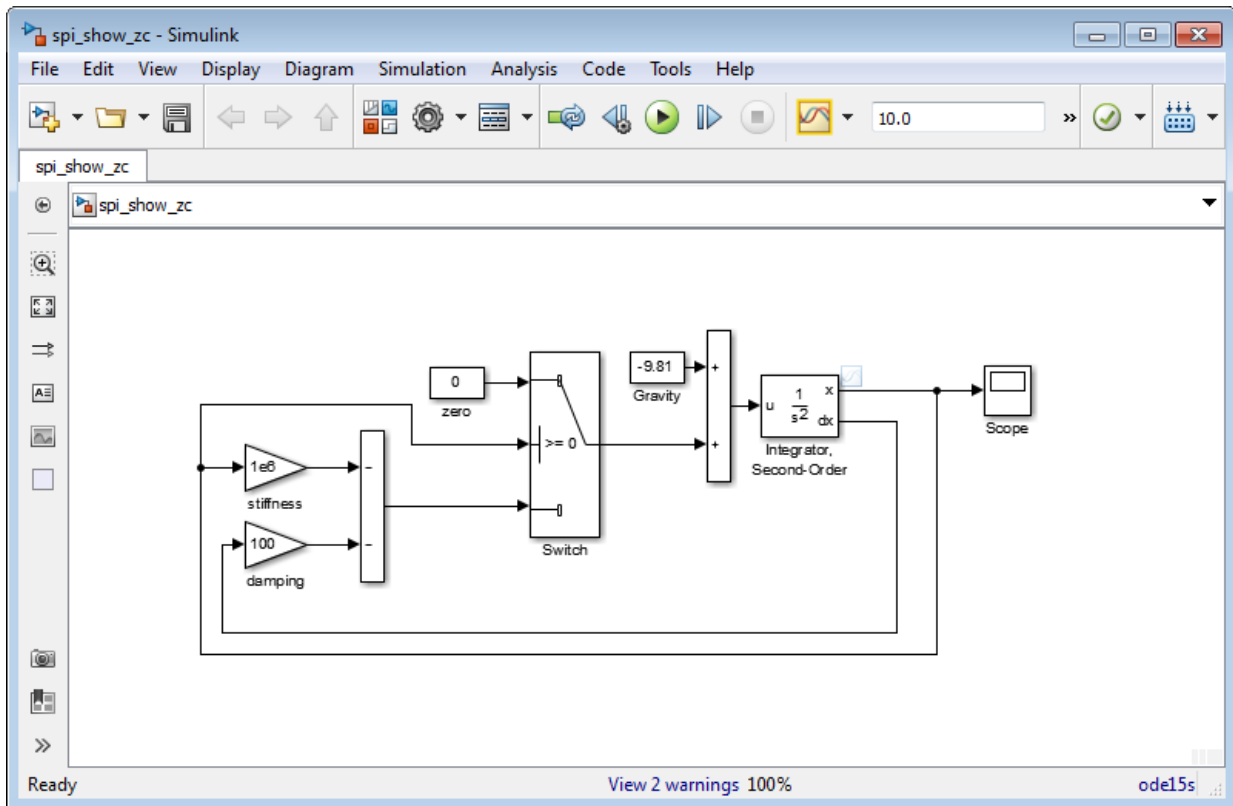

When you run the Solver Profiler on this model, the model simulates in 541 steps and that it triggers 55 zero-crossing events. To highlight the zero-crossing events on the step size plot, click the **Zero Crossing** tab and select the block that is causing the event.

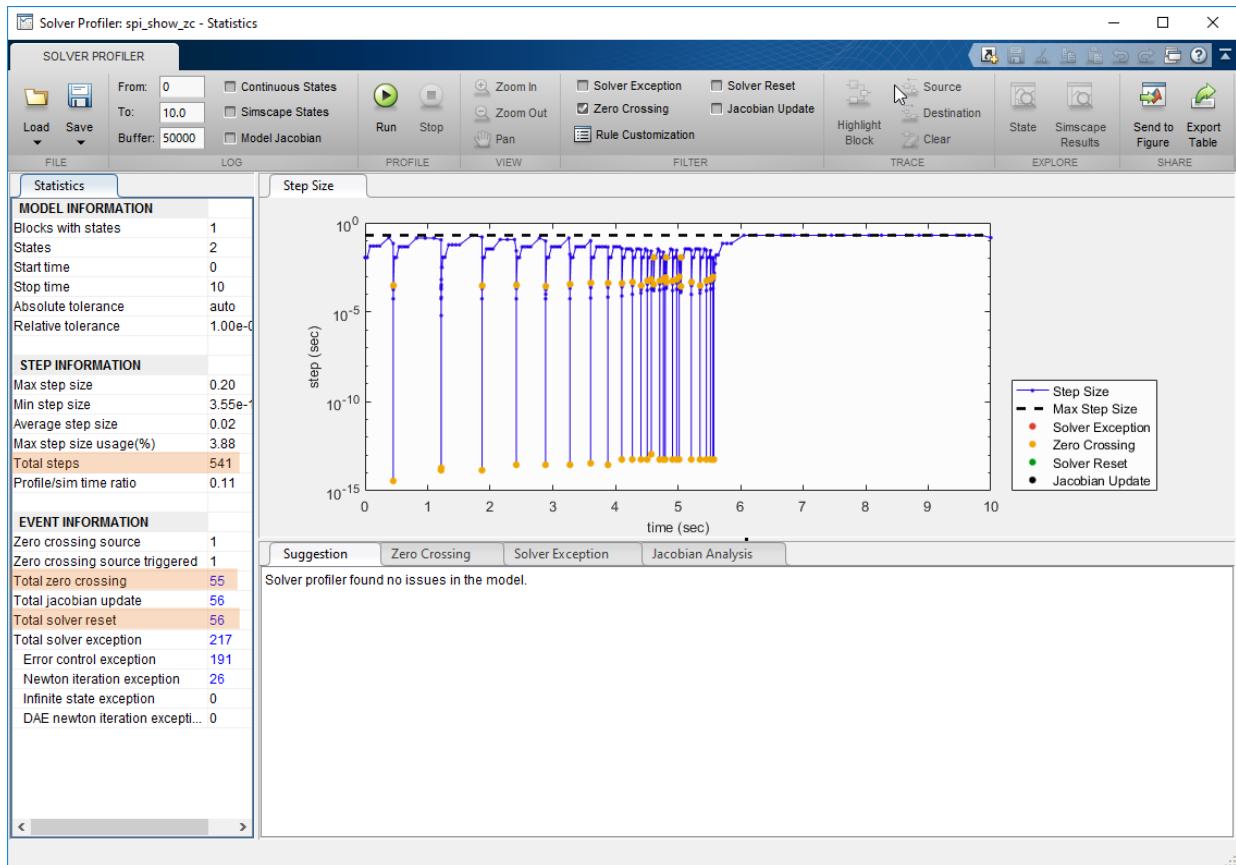

The result indicates that when the ball drops on the hard surface, it bounces 55 times before coming to a stop. The solver resets after each bounce, increasing the computational load. Having many resets improves accuracy at the cost of computation load. Therefore, it is important to be cognizant of this trade-off when modeling.

If this modeling construct belonged to a larger model, the Solver Profiler would help you locate it. You could then modify the model to improve solver performance. For example, you can decide to reduce the accuracy of the contact dynamic by increasing the damping factor, which would reduce the number of bounce events. Increasing the damping from 100 to 500 makes the ball bounce only 9 times, allowing the simulation to complete in only 137 steps.

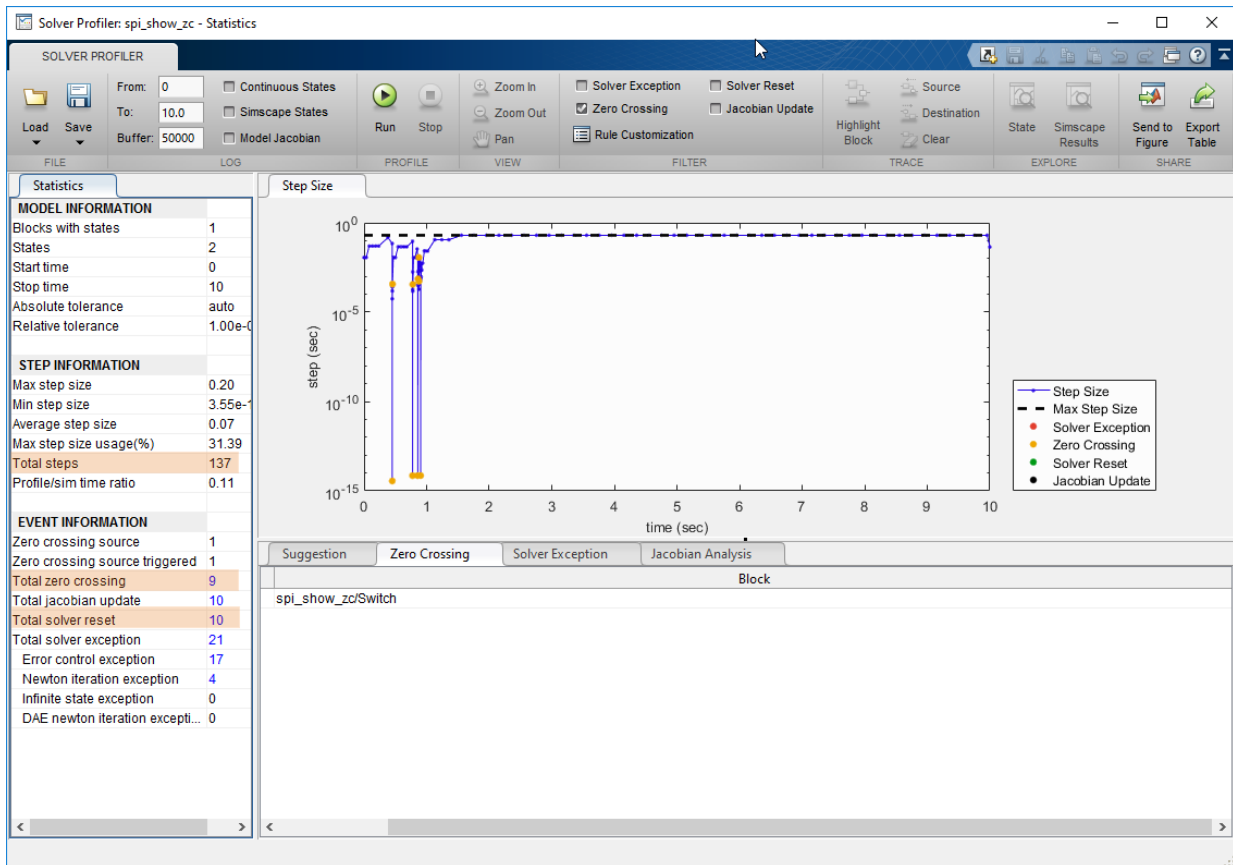

## Tolerance-Exceeding Events

This example simulates two identical nonlinear spring-damping systems. The two systems have different spring stiffnesses.

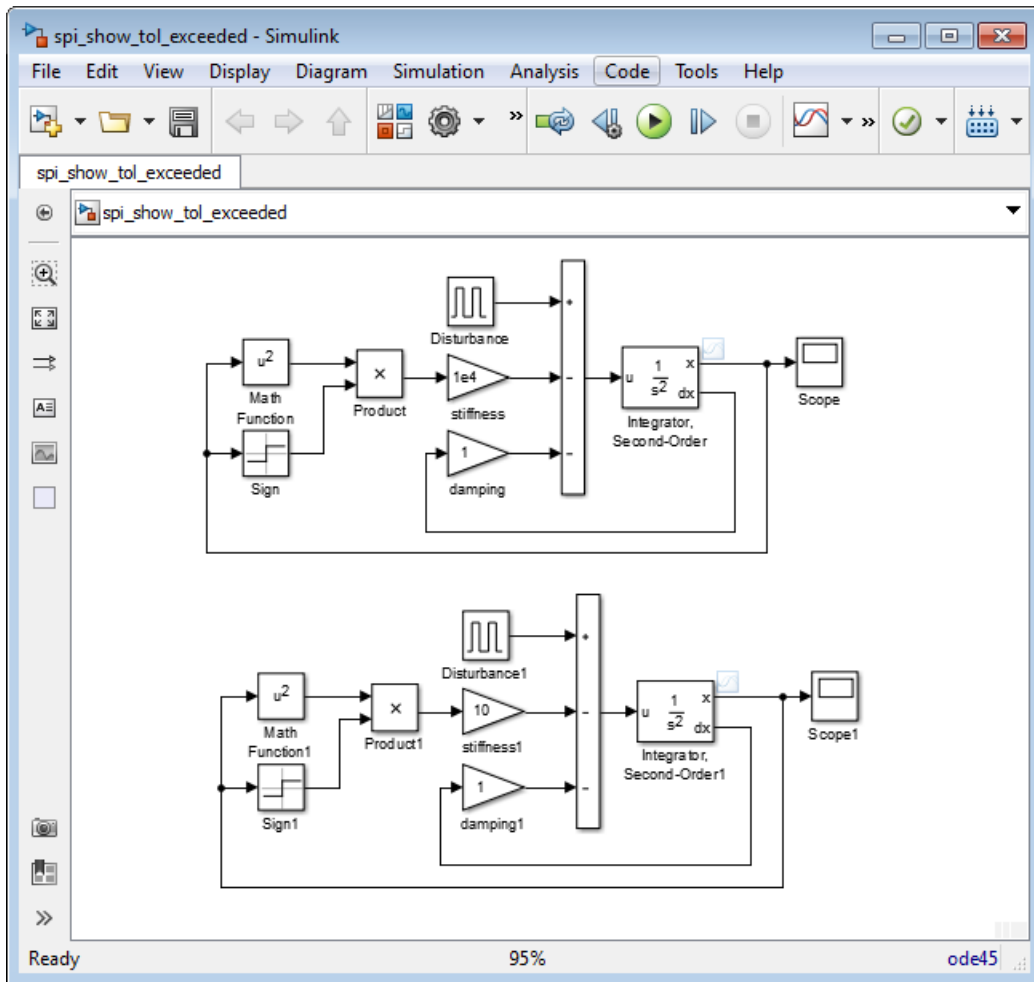

When you run the Solver Profiler on this model, you can see the tolerance exceeding events in the **Solver Exception** tab.



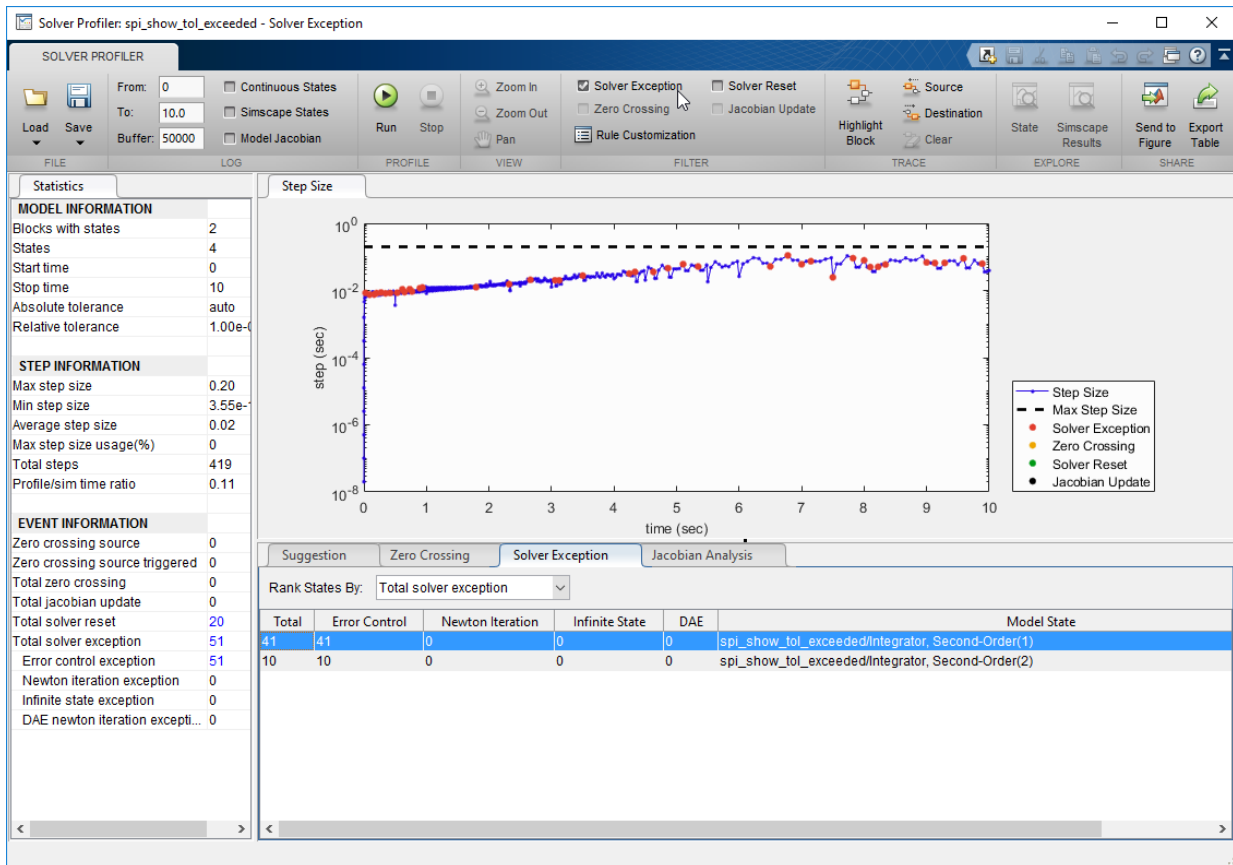

The result indicates that the stiffer spring causes the solver tolerance to exceed the limit. Typically, model states that change the fastest tend to be closest to the solver tolerance limit.

The solver attempts to take the largest possible steps while optimally trading off between speed and accuracy. Occasionally, this trade-off causes the solver to take steps that exceed the tolerance limit and forces it to reduce the step size. Exceeding the tolerance limit is not a poor modeling practice in itself. This profiler statistic is not meant to help you reduce tolerance exceeding events to zero.

This statistic can help you identify parts of your model that are close to exceeding the tolerance limit. You can identify model components that change the fastest or are the

stiffest. You can decide to retain this model dynamic in the simulation or simplify it to speed up simulation.

The tolerance-exceeding statistic can also help you identify modeling errors. If you do not expect the highlighted states to change as fast, you can examine your model for errors. In this example, the modeling error could be the stiffness of the stiffer spring is specified as N/m instead of the N/mm. This error makes the spring 1000 times stiffer than expected.

## Newton Iteration Failures

Newton iteration failures are specific to implicit solvers like `ode15s` and `ode23t`, and they result from Newton iterations not converging after a few trials. Similar to tolerance-exceeding events, these failures tend to occur when a system changes quickly.

This example simulates how the radius of a ball of flame changes when you strike a match. The ball of flame grows rapidly until it reaches a critical size, when the amount of oxygen consumed balances the growth in ball surface.

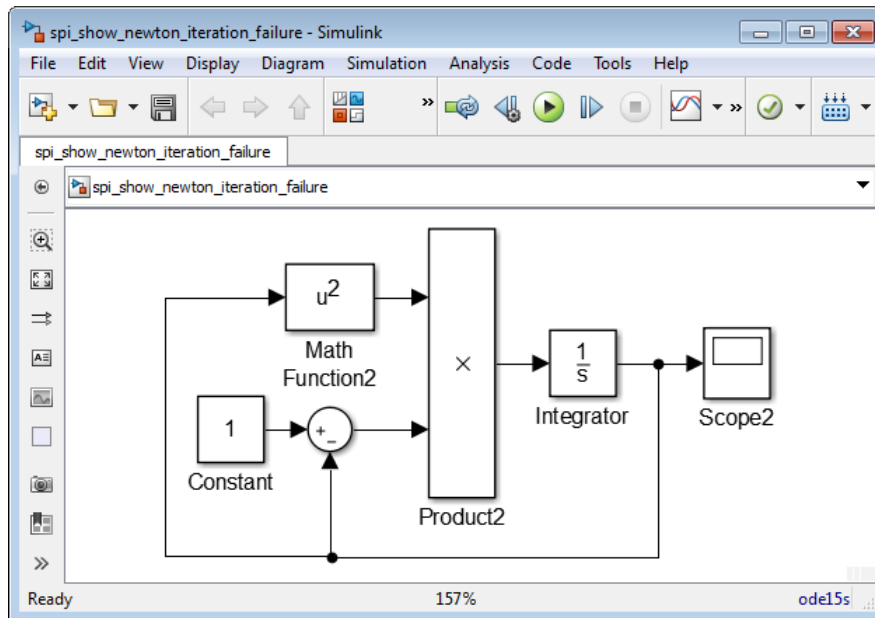

When you run the Solver Profiler on this model, you can see the Newton iteration failures in the **Solver Exception** tab.

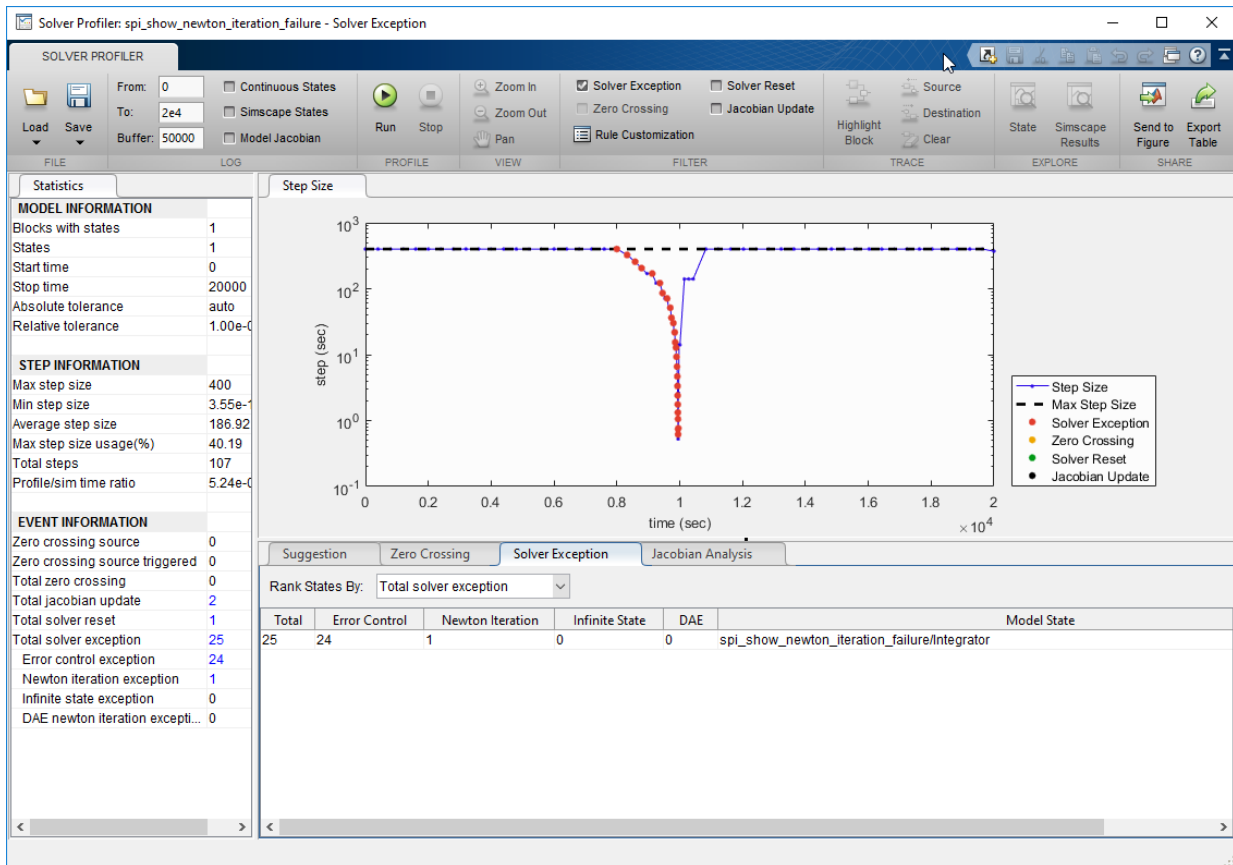

The result indicates that when the combustion begins, the solver tolerance is exceeded multiple times. When equilibrium is attained, the system appears different, and a Newton iteration failure occurs. The Jacobian of the system is recomputed, and the solver continues to move forward.

Newton failures are not indicative of poor modeling practices. This profiler statistic is not meant to help you reduce these failures to zero. In this example, you can reduce the solver tolerance to prevent this failure. But the solver then takes small steps unnecessarily, which is counterproductive. Therefore, in this example, this failure is acceptable.

This type of failure becomes problematic when it occurs in large numbers over a short period, especially in Simscape models. Dense failures indicate that your model is not robust numerically. One way to improve numerical robustness is to tighten the solver tolerance. Another way is to modify the model to avoid rapid changes.

## Differential Algebraic Equation Failures

Most Simscape models are implemented using differential algebraic equations (DAEs), in contrast to Simulink models, which use ordinary differential equations.

The use of DAEs adds complexity to Simscape models. Solvers like `ode15s` and `ode23t` can handle many types of DAEs. However, when the algebraic constraints between Simscape components are complex and changing fast, the Newton iteration process fails to resolve to those constraints.

This example simulates a pressure source that can be directed toward one of two hydraulic chambers.

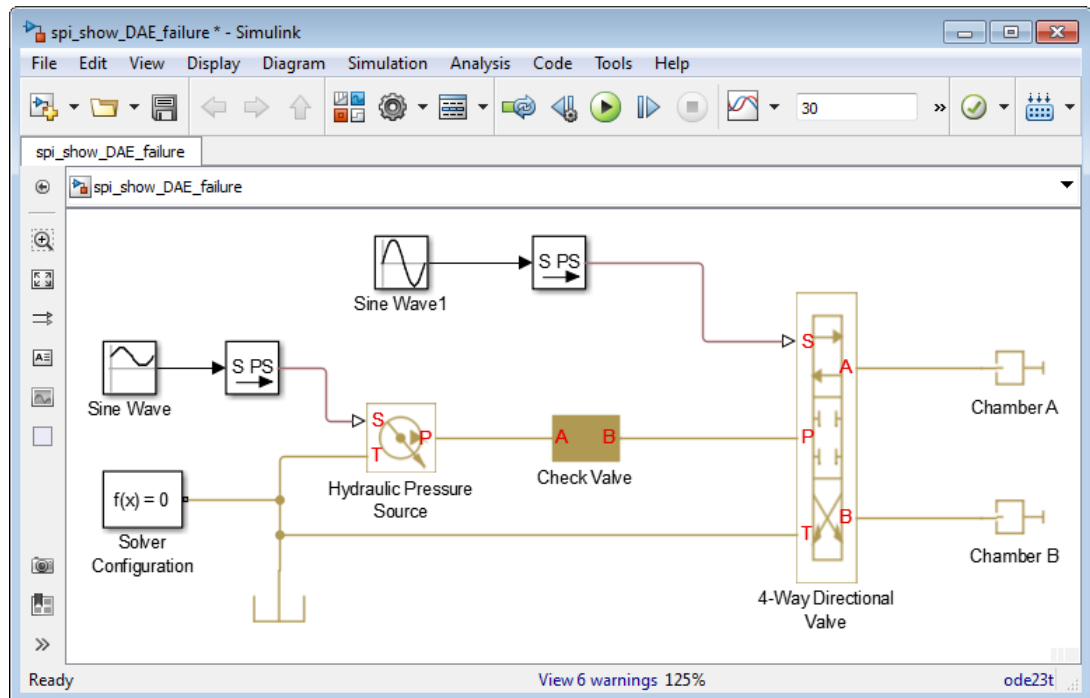

When you simulate this model, Simulink displays several warnings.

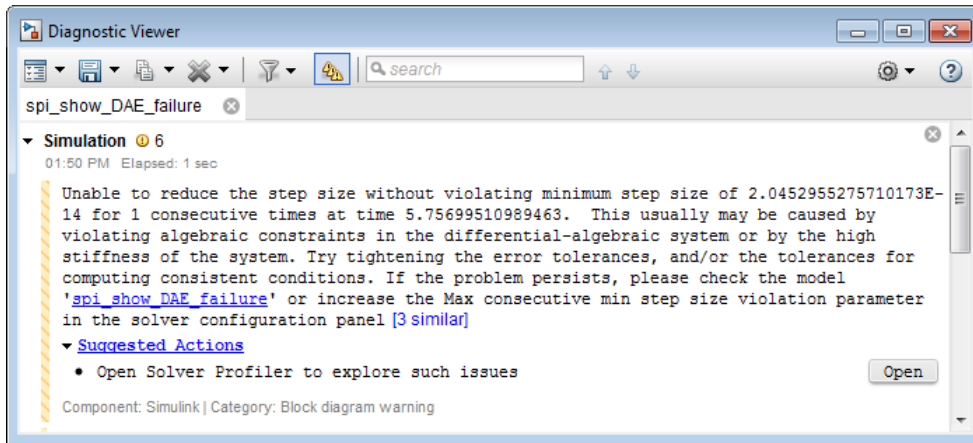

Typically, small models can handle such warnings and simulate to completion. However, this warning indicates that the model is not robust numerically. Minor changes to the model, or integration into a larger model, can result in errors.

When you run the Solver Profiler on this model, you can see the DAE failures in the **Solver Exception** tab.

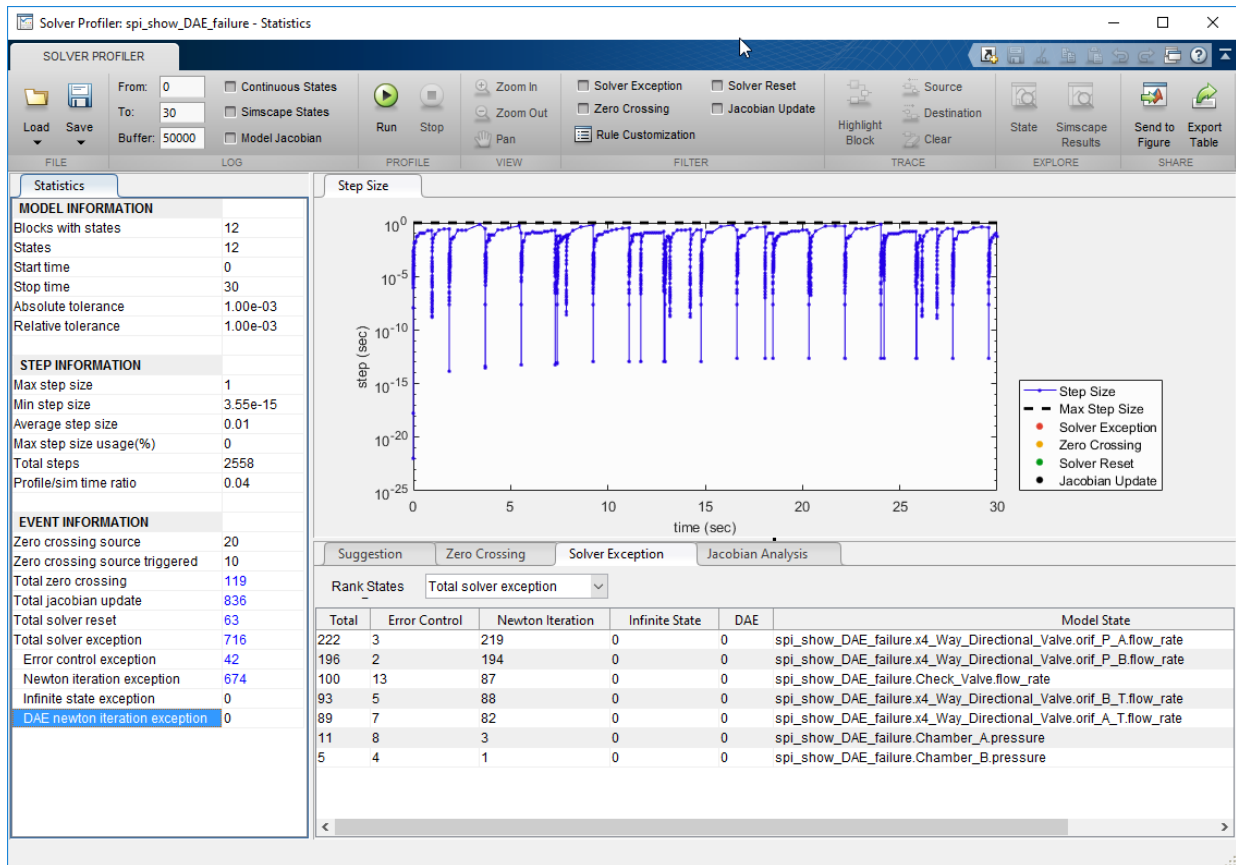

In this case, the exception results from large solver tolerance. Tightening the solver tolerance forces the solver to take smaller steps and better capture the changes in algebraic constraints.

Alternatively, this exception can be avoided by removing the algebraic constraint. In this example, the **Check Valve** and the **4-Way Directional Valve** are directly connected. When their pressure–flow relationship changes rapidly, the solver is unable to capture the changes. Inserting a **Hydraulic Chamber** between those two components makes them compliant. To learn more about dry nodes, see Simscape documentation.

## Jacobian Logging and Analysis

The Solver Profiler supports Jacobian logging and analysis for ode15s and ode23t solvers only.

You can select the **Model Jacobian** checkbox in the Solver Profiler to log updates to the Jacobian matrix for the model. When you run the Solver Profiler on a model, you can see the logs in the **Jacobian Analysis** tab.

The **Jacobian Analysis** tab indicates the states in the model that are likely slowing down the solver.

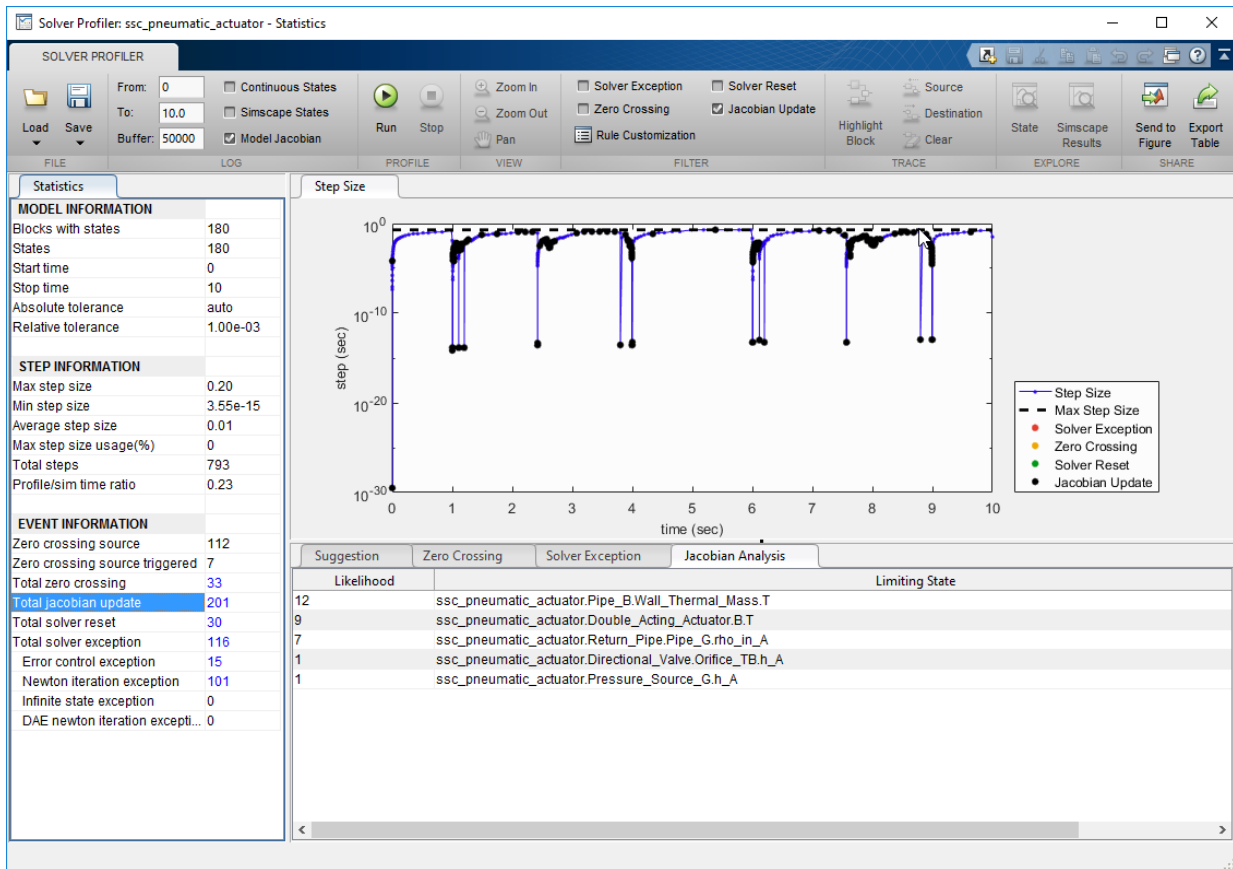

To investigate the cause of each limiting state, select a row in the **Jacobian Analysis** tab and click **Highlight Block**.

### **Related Examples**

- “Examine Model Dynamics Using Solver Profiler” on page 31-2



# Modify Solver Profiler Rules

You can customize the suggestions that appear in the Solver Profiler in these ways:

- Change the thresholds of the Solver Profiler rules that detect failure patterns.
- Select which rules to apply during a profiling run.
- Author your own rule set as a MATLAB script.

## Change Thresholds of Profiler Rules

Click **Rule Customization** in the Solver Profiler to access the rule set. You can change the thresholds for most of these rules and also select which rules you want to apply selectively during a simulation run.

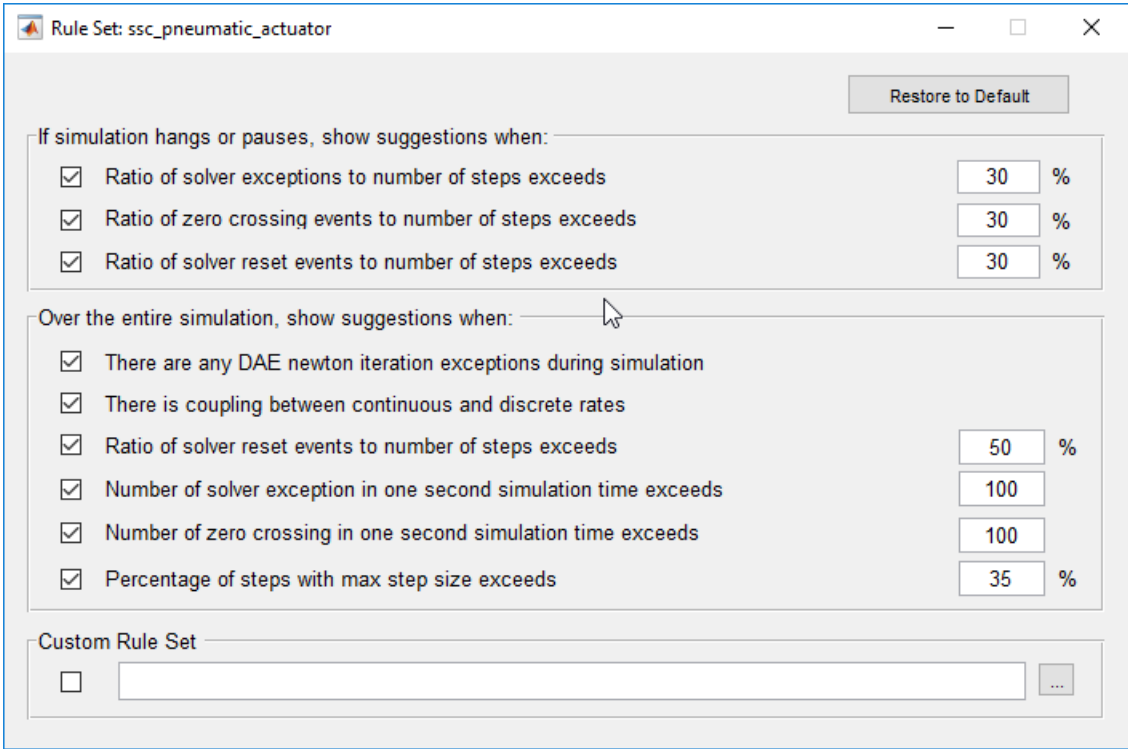

## Develop Profiler Rule Set

You can override the settings on the **Rule Set** dialog box by specifying a custom rule set.

Create a rule set as a MATLAB script and specify the path to the script in the **Custom Rule Set** section of the **Rule Set** dialog box.

A simple rule set example looks as follows:

```
function diagnosticsString = customRule(profilerData)
    if isempty(profilerData.zcEvents)
        diagnosticsString{1} = 'No zero-crossing event detected.';
    else
        diagnosticsString{1} = 'Zero-crossing events detected.';
    end
end
```

The input to the function is an array of structures called `profilerData`. This array of structures organizes all the information that the Solver Profiler collects during a profiling run. It contains the following substructures.

Substructure	Fields
<b>stateInfo</b> : Stores information on block states	<ul style="list-style-type: none"> <li>• <b>name</b>: Block name</li> <li>• <b>value</b>: State values</li> <li>• <b>blockIdx</b>: Block ID</li> </ul>
<b>blockInfo</b> : Cross-reference of blocks and state IDs	<ul style="list-style-type: none"> <li>• <b>name</b>: Block name</li> <li>• <b>stateIdx</b>: State ID</li> </ul>
<b>zcSrcInfo</b> : Stores information on blocks causing zero-crossing events	<ul style="list-style-type: none"> <li>• <b>name</b>: Block name</li> <li>• <b>blockIdx</b>: Block ID</li> </ul>
<b>zcEvents</b> : Cross-reference of the time stamps of zero-crossing events and the corresponding state IDs	<ul style="list-style-type: none"> <li>• <b>t</b>: Event timestamp</li> <li>• <b>srcIdx</b>: Block ID</li> </ul>
<b>exceptionEvents</b> : Cross-reference of exception event timestamps, the ID of the corresponding state that caused the event, and the cause.	<ul style="list-style-type: none"> <li>• <b>t</b>: Event timestamp</li> <li>• <b>stateIdx</b>: State ID</li> <li>• <b>cause</b>: Cause of exception</li> </ul>
<b>resetTime</b> : Stores timestamps of solver resets.	None

---

Substructure	Fields
tout: Stores simulation times.	None

## Customize State Ranking

If you log continuous states in the Solver Profiler, you can open the State Explorer to investigate each continuous state. The State Explorer ranks continuous states by the following metrics:

- State Derivative
- Newton/DAE Exception
- State Value
- Error Control Exception
- State Name
- State Chatter

In addition to these ranking metrics, you can write and upload your own algorithm to determine how continuous states are ranked in the State Explorer.

- 1 Click the edit button next to the **Rank States By** dropdown.

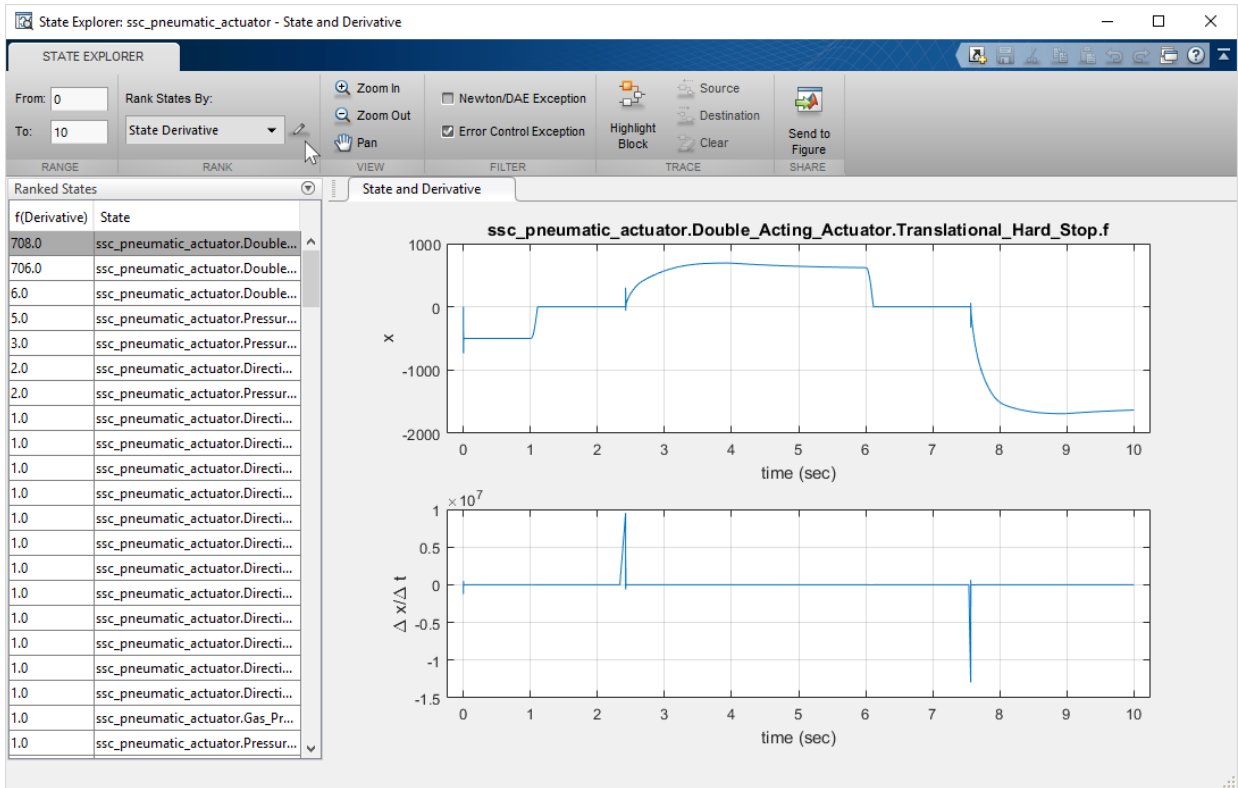

2 In the Custom Algorithm dialog box that appears, click **Add** and upload a MATLAB script that contains your ranking algorithm.

A simple algorithm that ranks states by value looks as follows:

---

**Note:** The structures referenced in this example organize information that the Solver Profiler collects during a profiling run. For more information on the structures, see “Develop Profiler Rule Set” on page 31-20.

---

```
function [index,score] = customRank(sd,tl,tr)
```

```
% Allocate storage for index and score list
nStates = length(sd.stateInfo);
```

```
index = 1:nStates;
score = zeros(nStates,1);

% Loop through each state to calculate score
for i = 1:nStates
    x = sd.stateInfo(i).value;
    % apply time range constraints
    x = x(sd.tout>=tl & sd.tout<=tr);
    if max(x) > 1
        score(i) = 1;
    else
        score(i) = 0;
    end
end

% Rank the states
[score, order] = sort(score, 'descend');
index = index(order);

end
```

# Solver Profiler Interface

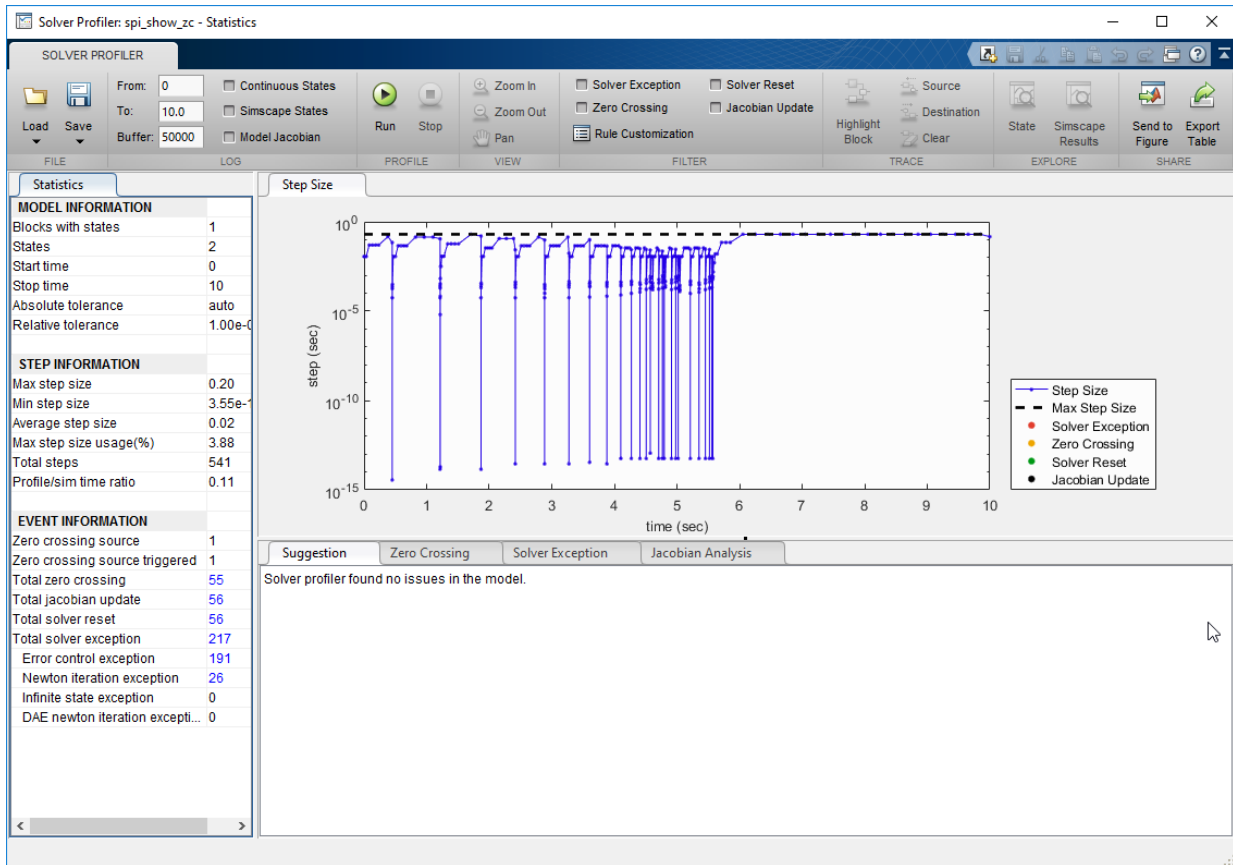

The Solver Profiler enables you to:

- Start a profiling session, save a session, or open a saved session.
- Customize and filter the results displayed.
- Interact with the model and trace and highlight the states that contain exceptions.
- Open Simscape Explorer or States Explorer to analyze simulation data further.
- Customize profiler suggestions using your own rules.

## Statistics Pane

The statistics pane displays information on model parameters, including:

- **Average step size** — A measure of how fast the solver advances. It is calculated as the total simulation time divided by the number of steps the solver used. It is bounded by the model configuration parameters **Max step size** and **Min step size**.
- **Max step size usage** — The percentage of maximum step sizes used by the solver among all step sizes.
- **Zero crossing** — A solver-specific event that affects model dynamics. During simulation, the solver detects zero crossing. Zero crossing detection incurs computation cost. For more information, see “Zero-Crossing Detection” on page 3-24.
- **Solver reset** — An event that causes the solver to reset its parameters. Solver reset detection incurs computation cost.
- **Solver exception** — An event that renders the solver unable to solve model states to meet accuracy specifications. To solve model states accurately, the solver has to run a few adjusted trials, which incur computation cost.
- **Error control exception** — An event where a solution obtained by the solver has an error that is greater than the tolerance specification.
- **Newton iteration exception** — An event specific to implicit solvers. Newton iterations do not converge after a few trials.
- **Infinite state exception** — An event where one or more states solved by the solver are infinite.
- **DAE newton iteration exception** — An event specific to implicit solvers for Simscape models. The Newton iteration does not converge even though the solver violates the minimum step size constraint.

## Suggestions and Exceptions Pane

The suggestions and exceptions pane displays information on exceptions, including:

- **Solver exception** — An event that renders the solver unable to solve model states to meet accuracy specifications. To solve model states accurately, the solver has to run a few adjusted trials, which incur computation cost.
- **Error control exception** — An event where a solution obtained by the solver has an error that is greater than the tolerance specification.



- **Newton iteration exception** — An event specific to implicit solvers. Newton iterations do not converge after a few trials.
- **Infinite state exception** — An event where one or more states solved by the solver are infinite.
- **DAE newton iteration exception** — An event specific to implicit solvers for Simscape models. The Newton iteration does not converge even though the solver violates the minimum step size constraint.

### Related Examples

- “Examine Model Dynamics Using Solver Profiler” on page 31-2
- “Understand Profiling Results” on page 31-6



# Simulink Debugger

---

- “Introduction to the Debugger” on page 32-2
- “Debugger Graphical User Interface” on page 32-3
- “Debugger Command-Line Interface” on page 32-10
- “Debugger Online Help” on page 32-12
- “Start the Simulink Debugger” on page 32-13
- “Start a Simulation” on page 32-15
- “Run a Simulation Step by Step” on page 32-18
- “Set Breakpoints” on page 32-23
- “Display Information About the Simulation” on page 32-29
- “Display Information About the Model” on page 32-34

## Introduction to the Debugger

With the debugger, you run your simulation method by method. You can stop after each method to examine the execution results. In this way, you can pinpoint problems in your model to specific blocks, parameters, or interconnections.

---

**Note** Methods are functions that the Simulink software uses to solve a model at each time step during the simulation. Blocks are made up of multiple methods. “Block execution” in this documentation is shorthand for “block methods execution.” Block diagram execution is a multi-step operation that requires execution of the different block methods in all the blocks in a diagram at various points during the process of solving a model at each time step during simulation, as specified by the simulation loop.

---

The debugger has both a graphical and a command-line user interface. The graphical interface allows you to access the most commonly used features of the debugger. The command-line interface gives you access to all of the capabilities in the debugger. If you can use either to perform a task, the documentation shows you first how to use the graphical interface, “Debugger Graphical User Interface” on page 32-3, and then the command-line interface, “Debugger Command-Line Interface” on page 32-10.

All functions such as `atrace` and `ashow` can only be used within the debugger.

### Related Examples

- “Start the Simulink Debugger” on page 32-13
- “Start a Simulation” on page 32-15
- “Run a Simulation Step by Step” on page 32-18

### More About

- “Debugger Graphical User Interface” on page 32-3
- “Debugger Command-Line Interface” on page 32-10
- “Debugger Online Help” on page 32-12

## Debugger Graphical User Interface

### In this section...

“Displaying the Graphical Interface” on page 32-3

“Toolbar” on page 32-4

“Breakpoints Pane” on page 32-5

“Simulation Loop Pane” on page 32-5

“Outputs Pane” on page 32-7

“Sorted List Pane” on page 32-7

“Status Pane” on page 32-8

### Displaying the Graphical Interface

Select **Debug Model** from a model window **Simulation > Debug** menu to display the debugger graphical interface.

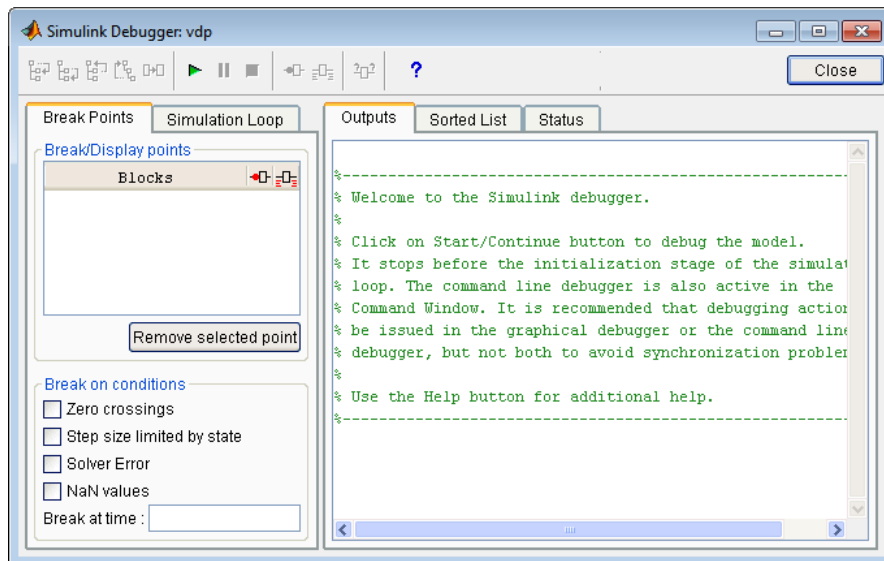

---

**Note:** The debugger graphical user interface does not display state or solver information. The command line interface does provide this information. See “Display System States” on page 32-31 and “Display Solver Information” on page 32-32.









---



## Toolbar

The debugger toolbar appears at the top of the debugger window.



From left to right, the toolbar contains the following command buttons:

Button	Purpose
	Step into the next method (see “Stepping Commands” on page 32-20 for more information on this command, and the following stepping commands).
	Step over the next method.
	Step out of the current method.
	Step to the first method at the start of next time step.
	Step to the next block method.
	Start or continue the simulation.
	Pause the simulation.
	Stop the simulation.
	Break before the selected block.

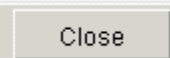
Button	Purpose
	Display inputs and outputs of the selected block when executed (same as trace gcb).
	Display the current inputs and outputs of selected block (same as probe gcb).
	Display help for the debugger.
	Close the debugger.

## Breakpoints Pane

To display the **Breakpoints** pane, select the **Break Points** tab on the debugger window.

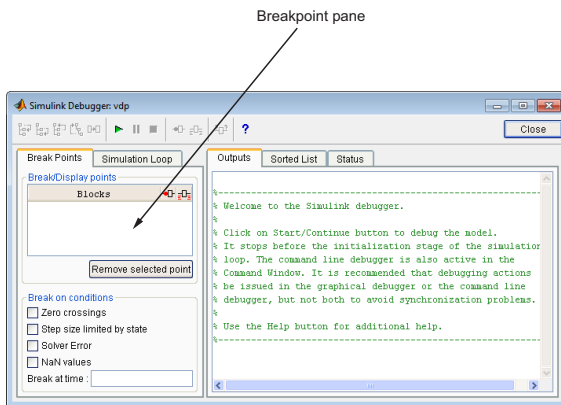

The **Breakpoints** pane allows you to specify block methods or conditions at which to stop a simulation. See “Set Breakpoints” on page 32-23 for more information.

## Simulation Loop Pane

To display the **Simulation Loop** pane, select the **Simulation Loop** tab on the debugger window.

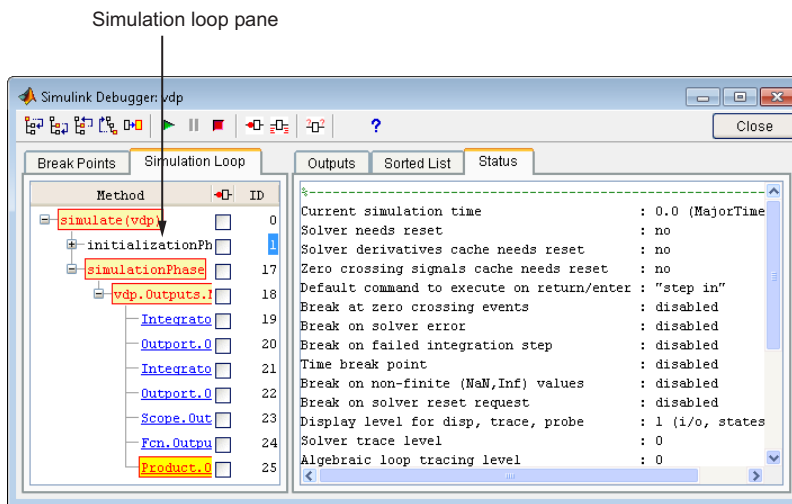

The **Simulation Loop** pane contains three columns:

- Method
- Breakpoints
- ID

### Method Column

The **Method** column lists the methods that have been called thus far in the simulation as a method tree with expandable/collapsible nodes. Each node of the tree represents a method that calls other methods. Expanding a node shows the methods that the block method calls. Clicking a block method name highlights the corresponding block in the model diagram.

Whenever the simulation stops, the debugger highlights the name of the method where the simulation has stopped as well as the methods that invoked it. The highlighted method names indicate the current state of the method call stack.

### Breakpoints Column

The breakpoints column consists of check boxes. Selecting a check box sets a breakpoint at the method whose name appears to the left of the check box. See “Setting Breakpoints from the Simulation Loop Pane” on page 32-25 for more information.



## ID Column

The ID column lists the IDs of the methods listed in the **Methods** column. See “Method ID” on page 32-10 for more information.

## Outputs Pane

To display the **Outputs** pane, select the **Outputs** tab on the debugger window.

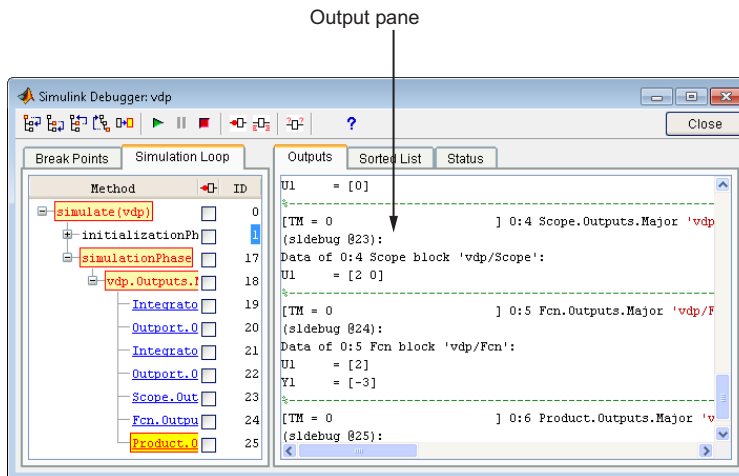

The Outputs pane displays the same debugger output that would appear in the MATLAB command window if the debugger were running in command-line mode. The output includes the debugger command prompt and the inputs, outputs, and states of the block at whose method the simulation is currently paused (see “Block Data Output” on page 32-19). The command prompt displays current simulation time and the name and index of the method in which the debugger is currently stopped (see “Block ID” on page 32-10).

## Sorted List Pane

To display the **Sorted List** pane, select the **Sorted List** tab on the debugger window.

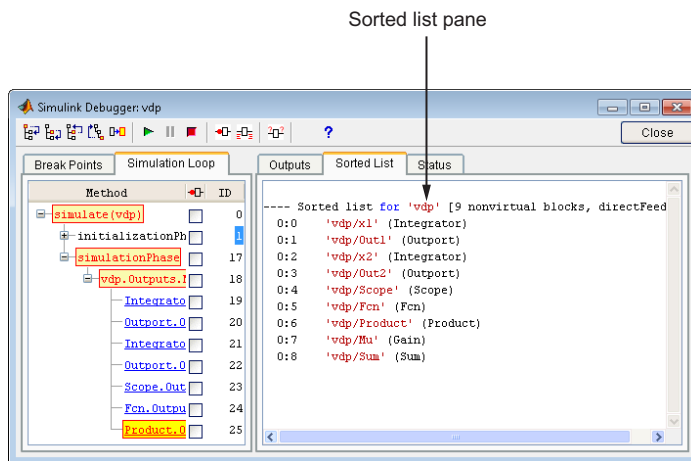

The **Sorted List** pane displays the sorted lists for the model being debugged. See “Display Model’s Sorted Lists” on page 32-34 for more information.

## Status Pane

To display the **Status** pane, select the **Status** tab on the debugger window.

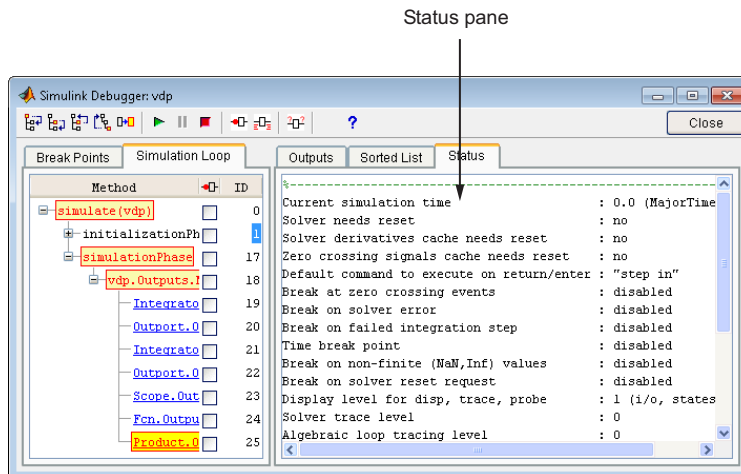

The **Status** pane displays the values of various debugger options and other status information.

## **Related Examples**

- “Start the Simulink Debugger” on page 32-13
- “Start a Simulation” on page 32-15
- “Run a Simulation Step by Step” on page 32-18

## **More About**

- “Debugger Command-Line Interface” on page 32-10
- “Debugger Online Help” on page 32-12

## Debugger Command-Line Interface

### In this section...

“Controlling the Debugger” on page 32-10

“Method ID” on page 32-10

“Block ID” on page 32-10

“Accessing the MATLAB Workspace” on page 32-11

### Controlling the Debugger

In command-line mode, you control the debugger by entering commands at the debugger command line in the MATLAB Command Window. To enter commands at the debugger command line, you must start the debugger programmatically and not through the GUI. Use `sldebug` for this purpose. The debugger accepts abbreviations for debugger commands. For more information on debugger commands, see “Simulink Debugger”.

---

**Note:** You can repeat some commands by entering an empty command (i.e., by pressing the **Enter** key) at the command line.

---

### Method ID

Some of the Simulink software commands and messages use method IDs to refer to methods. A method ID is an integer assigned to a method the first time the method is invoked. The debugger assigns method indexes sequentially, starting with 0.

### Block ID

Some of the debugger commands and messages use block IDs to refer to blocks. Block IDs are assigned to blocks while generating the model's sorted lists during the compilation phase of the simulation. A block ID has the form `sysIdx:blkIdx`, where `sysIdx` is an integer identifying the system that contains the block (either the root system or a nonvirtual subsystem) and `blkIdx` is the position of the block in the system's sorted list. For example, the block `ID0:1` refers to the first block in the model's root system. The `slist` command shows the block ID for each debugged block in the model.

## Accessing the MATLAB Workspace

You can enter any MATLAB expression at the `sldebug` prompt. For example, suppose you are at a breakpoint and you are logging time and output of your model as `tout` and `yout`. The following command creates a plot.

```
(sldebug ...) plot(tout, yout)
```

You cannot display the value of a workspace variable whose name is partially or entirely the same as that of a debugger command by entering it at the debugger command prompt. You can, however, use the `eval` command to work around this problem. For example, use `eval('s')` to determine the value of `s` rather than `step` the simulation.

## Related Examples

- “Start the Simulink Debugger” on page 32-13
- “Start a Simulation” on page 32-15
- “Run a Simulation Step by Step” on page 32-18

## More About

- “Debugger Graphical User Interface” on page 32-3
- “Debugger Online Help” on page 32-12

## Debugger Online Help

You can get online help on using the debugger by clicking the **Help** button on the debugger toolbar. Clicking the **Help** button displays help for the debugger in the MATLAB product Help browser.



In command-line mode, you can get a brief description of the debugger commands by typing `help` at the debug prompt.

### Related Examples

- “Start the Simulink Debugger” on page 32-13
- “Start a Simulation” on page 32-15
- “Run a Simulation Step by Step” on page 32-18

### More About

- “Debugger Graphical User Interface” on page 32-3
- “Debugger Command-Line Interface” on page 32-10

## Start the Simulink Debugger

You can start the debugger from either a Simulink model window or from the MATLAB Command Window.

### In this section...

“Starting from a Model Window” on page 32-13

“Starting from the Command Window” on page 32-13

### Starting from a Model Window

- 1 In a model window, select **Simulation > Debug > Debug Model**.

The debugger graphical user interface opens. See “Debugger Graphical User Interface” on page 32-3.

- 2 Continue selecting toolbar buttons.

---

**Note:** When running the debugger in graphical user interface (GUI) mode, you must explicitly start the simulation. For more information, see “Start a Simulation” on page 32-15.

---

---

**Note:** When starting the debugger from the GUI, you cannot enter debugger commands in the MATLAB command window. For this, you must start the debugger from the command window using the `sim` or `sldebug` commands.

---

### Starting from the Command Window

- 1 In the MATLAB Command Window, enter either
  - the `sim` command. For example, enter

```
sim('vdp', 'StopTime', '10', 'debug', 'on')
```
  - or the `sldebug` command. For example, enter

```
sldebug 'vdp'
```

In both cases, the example model `vdp` loads into memory, starts the simulation, and stops the simulation at the first block in the model execution list.

- 2 The debugger opens and a debugger command prompt appears within the MATLAB command window. Continue entering debugger commands at this debugger prompt.

## **Related Examples**

- “Start a Simulation” on page 32-15
- “Run a Simulation Step by Step” on page 32-18
- “Set Breakpoints” on page 32-23

## **More About**

- “Debugger Graphical User Interface” on page 32-3
- “Debugger Command-Line Interface” on page 32-10
- “Debugger Online Help” on page 32-12



## Start a Simulation

To start the simulation, click the **Start/Continue** button on the debugger toolbar.

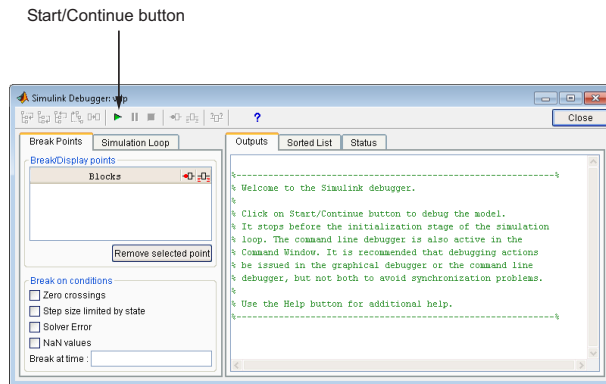

The simulation starts and stops at the first simulation method that is to be executed. It displays the name of the method in its **Simulation Loop** pane. At this point, you can

- Set breakpoints.
- Run the simulation step by step.
- Continue the simulation to the next breakpoint or end.
- Examine data.
- Perform other debugging tasks.

The debugger displays the name of the method in the Simulation Loop pane, as shown in the following figure:

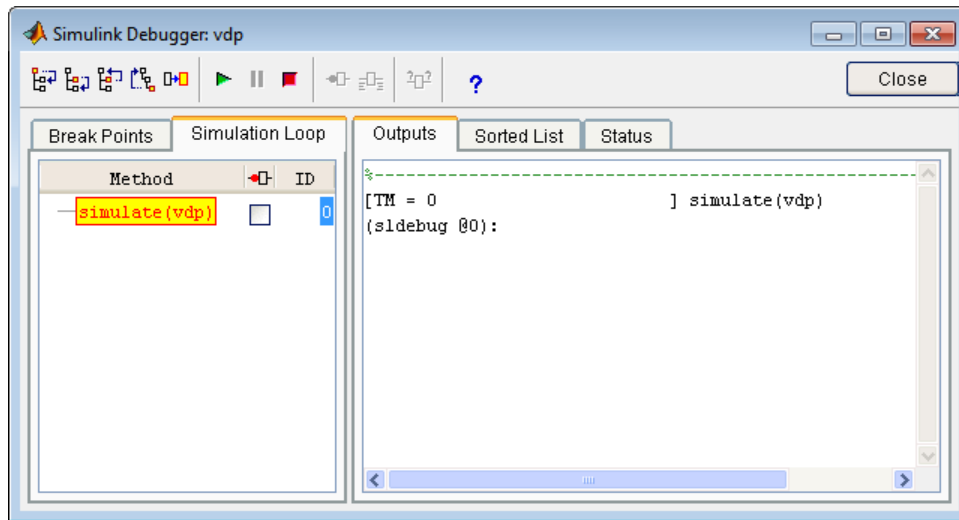

The following sections explain how to use the debugger controls to perform these debugging tasks.

---

**Note** When you start the debugger in GUI mode, the debugger command-line interface is also active in the MATLAB Command Window. However, to prevent synchronization errors between the graphical and command-line interfaces, you should avoid using the command-line interface.

---

## Related Examples

- “Start the Simulink Debugger” on page 32-13
- “Run a Simulation Step by Step” on page 32-18
- “Set Breakpoints” on page 32-23
- “Display Information About the Simulation” on page 32-29
- “Display Information About the Model” on page 32-34

## More About

- “Debugger Graphical User Interface” on page 32-3
- “Debugger Command-Line Interface” on page 32-10

- “Debugger Online Help” on page 32-12

## Run a Simulation Step by Step

### In this section...

- “Introduction” on page 32-18
- “Block Data Output” on page 32-19
- “Stepping Commands” on page 32-20
- “Continuing a Simulation” on page 32-21
- “Running a Simulation Nonstop” on page 32-21

### Introduction

The debugger provides various commands that let you advance a simulation from the method where it is currently suspended (the next method) by various increments (see “Stepping Commands” on page 32-20). For example, you can advance the simulation

- Into or over the next method
- Out of the current method
- To the top of the simulation loop.

After each advance, the debugger displays information that enables you to determine the point to which the simulation has advanced and the results of advancing the simulation to that point.

For example, in GUI mode, after each step command, the debugger highlights the current method call stack in the **Simulation Loop** pane. The call stack comprises the next method and the methods that invoked the next method either directly or indirectly. The debugger highlights the call stack by highlighting the names of the methods that make up the call stack in the **Simulation Loop** pane.

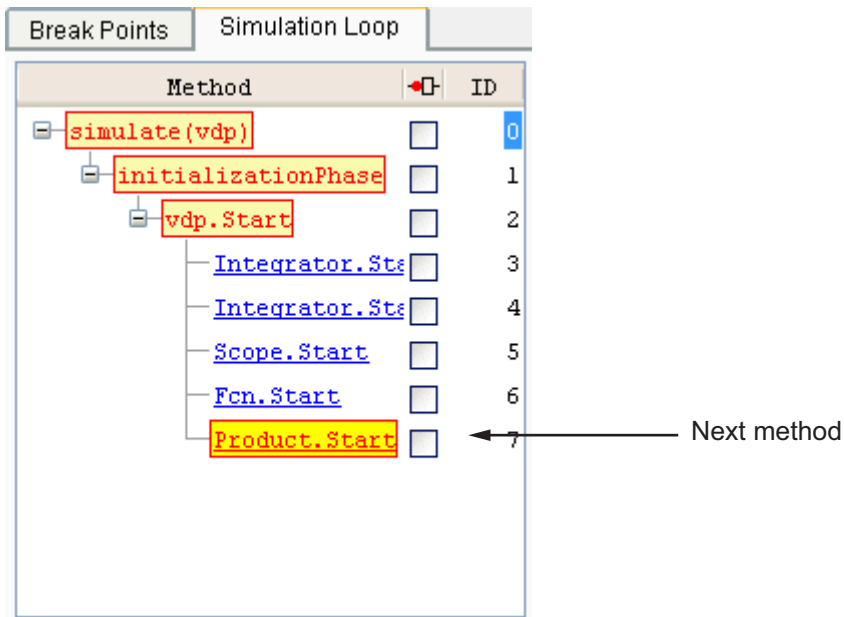

In command-line mode, you can use the `where` command to display the method call stack.

## Block Data Output

After executing a block method, the debugger prints any or all of the following block data in the debugger **Output** panel (in GUI mode) or, if in command line mode, the MATLAB Command Window:

- $U_n = v$   
where  $v$  is the current value of the block's  $n$ th input.
- $Y_n = v$   
where  $v$  is the current value of the block's  $n$ th output.
- $CSTATE = v$   
where  $v$  is the value of the block's continuous state vector.
- $DSTATE = v$

where  $v$  is the value of the block's discrete state vector.

The debugger also displays the current time, the ID and name of the next method to be executed, and the name of the block to which the method applies in the MATLAB Command Window. The following example illustrates typical debugger outputs after a step command.

```

Current time                                Next method
      |                                     |
      v                                     v
-----
[Tm = 2.009509145207664e-05 ] 0:2 Integrator.Derivatives 'vdp/x2'
(sldebug @49):
Data of 0:2 Integrator block 'vdp/x2':
U1    = [-1.9998794294512876]
Y1    = [-4.0190182904153282e-05]
CSTATE = [-4.0190182904153282e-05]
-----
[Tm = 3.014263717811496e-05 ] vdp.Outputs.Minor

```

## Stepping Commands

Command-line mode provides the following commands for advancing a simulation incrementally:

This command...	Advances the simulation...
<code>step [in into]</code>	Into the next method, stopping at the first method in the next method or, if the next method does not contain any methods, at the end of the next method
<code>step over</code>	To the method that follows the next method, executing all methods invoked directly or indirectly by the next method
<code>step out</code>	To the end of the current method, executing any remaining methods invoked by the current method
<code>step top</code>	To the first method of the next time step (i.e., the top of the simulation loop)
<code>step blockmth</code>	To the next block method to be executed, executing all intervening model- and system-level methods

This command...	Advances the simulation...
next	Same as <code>step over</code>

Buttons in the debugger toolbar allow you to access these commands in GUI mode.

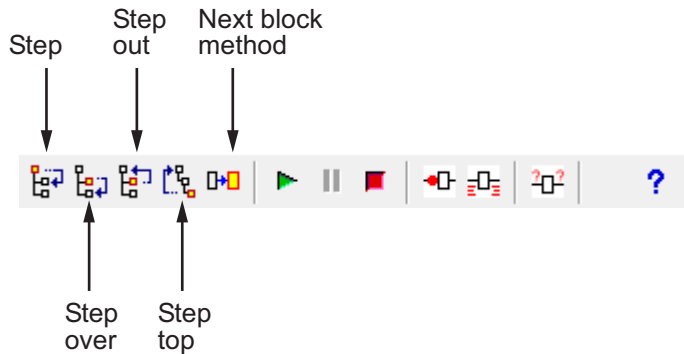

Clicking a button has the same effect as entering the corresponding command at the debugger command line.

## Continuing a Simulation

In GUI mode, the **Stop** button turns red when the debugger suspends the simulation for any reason. To continue the simulation, click the **Start/Continue** button. In command-line mode, enter `continue` to continue the simulation. By default, the debugger runs the simulation to the next breakpoint (see “Set Breakpoints” on page 32-23) or to the end of the simulation, whichever comes first.

## Running a Simulation Nonstop

The `run` command lets you run a simulation to the end of the simulation, skipping any intervening breakpoints. At the end of the simulation, the debugger returns you to the command line. To continue debugging a model, you must restart the debugger.

---

**Note** The GUI mode does not provide a graphical version of the `run` command. To run the simulation to the end, you must first clear all breakpoints and then click the **Start/Continue** button.

---

## **Related Examples**

- “Start the Simulink Debugger” on page 32-13
- “Set Breakpoints” on page 32-23
- “Display Information About the Simulation” on page 32-29
- “Display Information About the Model” on page 32-34
- “Run Accelerator Mode with the Simulink Debugger” on page 33-33

## **More About**

- “Debugger Graphical User Interface” on page 32-3
- “Debugger Command-Line Interface” on page 32-10
- “Debugger Online Help” on page 32-12



## Set Breakpoints

### In this section...

“About Breakpoints” on page 32-23

“Setting Unconditional Breakpoints” on page 32-23

“Setting Conditional Breakpoints” on page 32-25

### About Breakpoints

The debugger allows you to define stopping points called breakpoints in a simulation. You can then run a simulation from breakpoint to breakpoint, using the debugger `continue` command. The debugger lets you define two types of breakpoints: unconditional and conditional. An unconditional breakpoint occurs whenever a simulation reaches a method that you specified previously. A conditional breakpoint occurs when a condition that you specified in advance arises in the simulation.

Breakpoints are useful when you know that a problem occurs at a certain point in your program or when a certain condition occurs. By defining an appropriate breakpoint and running the simulation via the `continue` command, you can skip immediately to the point in the simulation where the problem occurs.

---

**Note:** When you stop a simulation at a breakpoint of a MATLAB S-function in the debugger, to exit MATLAB, you must first quit the debugger.

---

### Setting Unconditional Breakpoints

You can set unconditional breakpoints from the:

- Debugger toolbar
- **Simulation Loop** pane
- MATLAB product Command Window (command-line mode only)

#### Setting Breakpoints from the Debugger Toolbar

To enable the **Breakpoint** button,

- 1 Simulate the model.

- 2 Click the **Step over current method** button until `simulationPhase` is highlighted.
- 3 Click the **Step into current method** button.

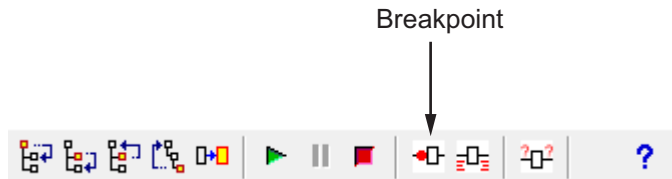

The debugger displays the name of the selected block in the **Break/Display points** panel of the **Breakpoints** pane.

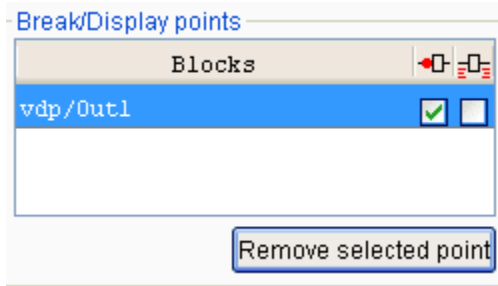

---

**Note** Clicking the **Breakpoint** button on the toolbar sets breakpoints on the invocations of a block's methods in major time steps.

---

You can temporarily disable the breakpoints on a block by deselecting the check box in the breakpoints column of the panel. To clear the breakpoints on a block and remove its entry from the panel,

- 1 Select the entry.
- 2 Click the **Remove selected point** button on the panel.

---

**Note** You cannot set a breakpoint on a virtual block. A virtual block is purely graphical: it indicates a grouping or relationship among a model's computational blocks. The debugger warns you if you try to set a breakpoint on a virtual block. You can get a listing

of a model's nonvirtual blocks, using the `slist` command (see “Displaying a Model's Nonvirtual Blocks” on page 32-35).

### Setting Breakpoints from the Simulation Loop Pane

To set a breakpoint at a particular invocation of a method displayed in the Simulation Loop pane, select the check box next to the method's name in the breakpoint column of the pane.

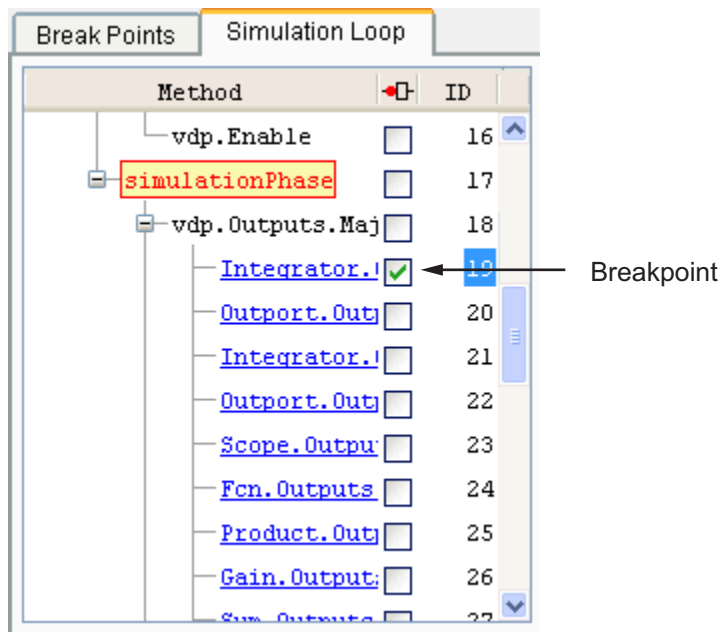

To clear the breakpoint, deselect the check box.

### Setting Breakpoints from the Command Window

In command-line mode, use the `break` and `bafter` commands to set breakpoints before or after a specified method, respectively. Use the `clear` command to clear breakpoints.

### Setting Conditional Breakpoints

You can use either the **Break on conditions** controls group on the debugger **Breakpoints** pane

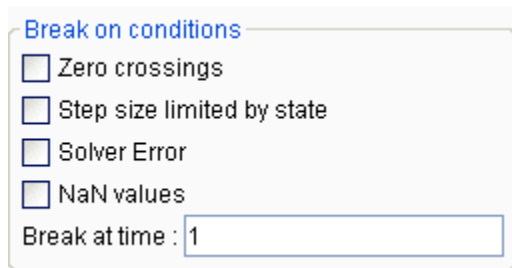

or the following commands (in command-line mode) to set conditional breakpoints.

This command...	Causes the Simulation to Stop...
<code>tbreak [t]</code>	At a simulation time step
<code>ebreak</code>	At a recoverable error in the model
<code>nanbreak</code>	At the occurrence of an underflow or overflow (NaN) or infinite (Inf) value
<code>xbreak</code>	When the simulation reaches the state that determines the simulation step size
<code>zcbreak</code>	When a zero crossing occurs between simulation time steps

### Setting Breakpoints at Time Steps

To set a breakpoint at a time step, enter a time in the debugger **Break at time** field (GUI mode) or enter the time using the `tbreak` command. This causes the debugger to stop the simulation at the `Outputs.Major` method of the model at the first time step that follows the specified time. For example, starting `vdp` in debug mode and entering the commands

```
tbreak 2
continue
```

causes the debugger to halt the simulation at the `vdp.Outputs.Major` method of time step 2.078 as indicated by the output of the `continue` command.

```
%-----%
[Tm = 2.034340153847549      ] vdp.Outputs.Minor
(sldebug @37):
```

### Breaking on Nonfinite Values

Selecting the debugger **NaN values** option or entering the `nanbreak` command causes the simulation to stop when a computed value is infinite or outside the range of values that is supported by the machine running the simulation. This option is useful for pinpointing computational errors in a model.

### Breaking on Step-Size Limiting Steps

Selecting the **Step size limited by state** option or entering the `xbreak` command causes the debugger to stop the simulation when the model uses a variable-step solver and the solver encounters a state that limits the size of the steps that it can take. This command is useful in debugging models that appear to require an excessive number of simulation time steps to solve.

### Breaking at Zero Crossings

Selecting the **Zero crossings** option or entering the `zcbreak` command causes the simulation to halt when a nonsampled zero crossing is detected in a model that includes blocks where zero crossings can arise. After halting, the ID, type, and name of the block in which the zero crossing was detected is displayed. The block ID (**s:b:p**) consists of a system index **s**, block index **b**, and port index **p** separated by colons (see “Block ID” on page 32-10).

For example, setting a zero-crossing break at the start of execution of the `zeroxing` example model,

```
>> sldebug zeroxing
%-----
%
[TM = 0                               ] zeroxing.Simulate
(sldebug @0): >> zcbreak
Break at zero crossing events           : enabled
```

and continuing the simulation

```
(sldebug @0): >> continue
```

results in a zero-crossing break at

```
Interrupting model execution before running mdlOutputs at the left post of
(major time step just before) zero crossing event detected at the following location:
 6[-0] 0:5:2 Saturate 'zeroxing/Saturation'
%-----%
```

```
[TzL= 0.3435011087932808      ] zeroxing.Outputs.Major  
(sldebug @16): >>
```

If a model does not include blocks capable of producing nonsampled zero crossings, the command prints a message advising you of this fact.

### Breaking on Solver Errors

Selecting the debugger **Solver Errors** option or entering the `ebreak` command causes the simulation to stop if the solver detects a recoverable error in the model. If you do not set or disable this breakpoint, the solver recovers from the error and proceeds with the simulation without notifying you.

### Related Examples

- “Start the Simulink Debugger” on page 32-13
- “Start a Simulation” on page 32-15
- “Display Information About the Simulation” on page 32-29
- “Display Information About the Model” on page 32-34
- “Run Accelerator Mode with the Simulink Debugger” on page 33-33

### More About

- “Debugger Graphical User Interface” on page 32-3
- “Debugger Command-Line Interface” on page 32-10
- “Debugger Online Help” on page 32-12

## Display Information About the Simulation

### In this section...

“Display Block I/O” on page 32-29

“Display Algebraic Loop Information” on page 32-31

“Display System States” on page 32-31

“Display Solver Information” on page 32-32

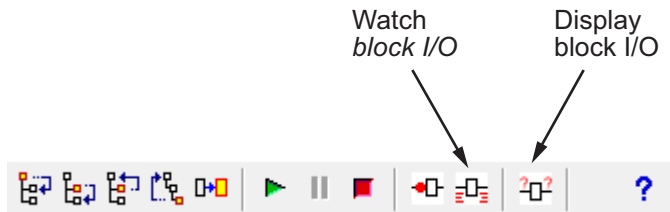

### Display Block I/O

The debugger allows you to display block I/O by clicking the appropriate buttons on the debugger toolbar





or by entering the appropriate debugger command.

This command...	Displays a Blocks I/O...
probe	Immediately
disp	At every breakpoint any time execution stops
trace	Whenever the block executes

**Note:** The two debugger toolbar buttons, Watch Block I/O () and Display Block I/O () correspond, respectively, to `trace gcb` and `probe gcb`. The `probe` and `disp` commands do not have a one-to-one correspondence with the debugger toolbar buttons.

## Displaying I/O of a Selected Block

To display the I/O of a block, select the block and click  in GUI mode or enter the `probe` command in command-line mode. In the following table, the `probe gcb` command has a corresponding toolbar button. The other commands do not.

Command	Description
<code>probe</code>	Enter or exit <code>probe</code> mode. Typing any command causes the debugger to exit <code>probe</code> mode.
<code>probe gcb</code>	Display I/O of selected block. Same as  .
<code>probe s:b</code>	Print the I/O of the block specified by system number <code>s</code> and block number <code>b</code> .

The debugger prints the current inputs, outputs, and states of the selected block in the debugger **Outputs** pane (GUI mode) or the Command Window of the MATLAB product.

The `probe` command is useful when you need to examine the I/O of a block whose I/O is not otherwise displayed. For example, suppose you are using the `step` command to run a model method by method. Each time you step the simulation, the debugger displays the inputs and outputs of the current block. The `probe` command lets you examine the I/O of other blocks as well.

## Displaying Block I/O Automatically at Breakpoints

The `disp` command causes the debugger to display a specified block's inputs and outputs whenever it halts the simulation. You can specify a block by entering its block index and entering `gcb` as the `disp` command argument. You can remove any block from the debugger list of display points, using the `undisp` command. For example, to remove block `0:0`, enter `undisp 0:0`.

---

**Note** Automatic display of block I/O at breakpoints is not available in the debugger GUI mode.



---

The `disp` command is useful when you need to monitor the I/O of a specific block or set of blocks as you step through a simulation. Using the `disp` command, you can specify the blocks you want to monitor and the debugger will then redisplay the I/O of those blocks



on every step. Note that the debugger always displays the I/O of the current block when you step through a model block by block, using the `step` command. You do not need to use the `disp` command if you are interested in watching only the I/O of the current block.

### Watching Block I/O

To watch a block, select the block and click  in the debugger toolbar or enter the `trace` command. In GUI mode, if a breakpoint exists on the block, you can set a watch on it as well by selecting the check box for the block in the watch column  of the **Break/Display points** pane. In command-line mode, you can also specify the block by specifying its block index in the `trace` command. You can remove a block from the debugger list of trace points using the `untrace` command.

The debugger displays a watched block's I/O whenever the block executes. Watching a block allows you obtain a complete record of the block's I/O without having to stop the simulation.

### Display Algebraic Loop Information

The `atrace` command causes the debugger to display information about a model's algebraic loops (see “Algebraic Loops” on page 3-38) each time they are solved. The command takes a single argument that specifies the amount of information to display.

This command...	Displays for each algebraic loop...
<code>atrace 0</code>	No information
<code>atrace 1</code>	The loop variable solution, the number of iterations required to solve the loop, and the estimated solution error
<code>atrace 2</code>	Same as level 1
<code>atrace 3</code>	Level 2 plus the Jacobian matrix used to solve the loop
<code>atrace 4</code>	Level 3 plus intermediate solutions of the loop variable

### Display System States

The `states` debug command lists the current values of the system states in the MATLAB Command Window. For example, the following sequence of commands shows the states of the bouncing ball example (`sldemo_bounce`) after its first, second, and

third time steps. However, before entering the debugger, open the Configuration Parameters dialog box, clear the **Block reduction** and **Signal storage reuse** check boxes on the **All Parameters** tab.

```

sldebug sldemo_bounce
%-----%
[TM = 0                               ] simulate(sldemo_bounce)
(sldebug @0): >> step top
%-----%
[TM = 0                               ] sldemo_bounce.Outputs.Major
(sldebug @16): >> next
%-----%
[TM = 0                               ] sldemo_bounce.Update
(sldebug @23): >> states

Continuous States:
Idx Value                               (system:block:element Name 'BlockName')
  0  10                                (0:4:0 CSTATE 'sldemo_bounce/Second-Order Integrator')
  1. 15                                (0:4:1)

(sldebug @23): >> next
%-----%
[TM = 0                               ] solverPhase
(sldebug @26): >> states

Continuous States:
Idx Value                               (system:block:element Name 'BlockName')
  0  10                                (0:4:0 CSTATE 'sldemo_bounce/Second-Order Integrator')
  1. 15                                (0:4:1)

(sldebug @26): >> next
%-----%
[TM = 0.01                             ] sldemo_bounce.Outputs.Major
(sldebug @16): >> states

Continuous States:
Idx Value                               (system:block:element Name 'BlockName')
  0  10.1495095                        (0:4:0 CSTATE 'sldemo_bounce/Second-Order Integrator')
  1. 14.9019                            (0:4:1)

```

## Display Solver Information

The `strace` command allows you to pinpoint problems in solving a models differential equations that can slow down simulation performance. Executing this command causes the debugger to display solver-related information at the command line of the MATLAB product when you run or step through a simulation. The information includes the sizes of the steps taken by the solver, the estimated integration error resulting from the step size, whether a step size succeeded (i.e., met the accuracy requirements that the model specifies), the times at which solver resets occur, etc. If you are concerned about the time required to simulate your model, this information can help you to decide whether the

solver you have chosen is the culprit and hence whether choosing another solver might shorten the time required to solve the model.

## **Related Examples**

- “Start the Simulink Debugger” on page 32-13
- “Start a Simulation” on page 32-15
- “Set Breakpoints” on page 32-23
- “Display Information About the Model” on page 32-34
- “Run Accelerator Mode with the Simulink Debugger” on page 33-33

## **More About**

- “Debugger Graphical User Interface” on page 32-3
- “Debugger Command-Line Interface” on page 32-10
- “Debugger Online Help” on page 32-12

## Display Information About the Model

### In this section...

“Display Model’s Sorted Lists” on page 32-34

“Display a Block” on page 32-35

### Display Model’s Sorted Lists

In GUI mode, the debugger **Sorted List** pane displays lists of blocks for a model’s root system and each nonvirtual subsystem. Each list lists the blocks that the subsystems contains sorted according to their computational dependencies, alphabetical order, and other block sorting rules. In command-line mode, you can use the `slist` command to display a model’s sorted lists.

```

---- Sorted list for 'vdp' [9 nonvirtual blocks, directFeed=0]
 0:0  'vdp/x1' (Integrator)
 0:1  'vdp/Out1' (Output)
 0:2  'vdp/x2' (Integrator)
 0:3  'vdp/Out2' (Output)
 0:4  'vdp/Scope' (Scope)
 0:5  'vdp/Fcn' (Fcn)
 0:6  'vdp/Product' (Product)
 0:7  'vdp/Mu' (Gain)
 0:8  'vdp/Sum' (Sum)

```

These displays include the block index for each command. You can use them to determine the block IDs of the model’s blocks. Some debugger commands accept block IDs as arguments.

### Identifying Blocks in Algebraic Loops

If a block belongs to an algebraic list, the `slist` command displays an algebraic loop identifier in the entry for the block in the sorted list. The identifier has the form

```
algId=s#n
```

where `s` is the index of the subsystem containing the algebraic loop and `n` is the index of the algebraic loop in the subsystem. For example, the following entry for an Integrator block indicates that it participates in the first algebraic loop at the root level of the model.

```
0:1 'test/ss/I1' (Integrator, tid=0) [algId=0#1, discontinuity]
```

When the debugger is running, you can use the `ashow` command at the debugger command-line interface to highlight the blocks and lines that make up an algebraic loop. See “Displaying Algebraic Loops” on page 32-36 for more information.

## Display a Block

To determine the block in a models diagram that corresponds to a particular index, enter `bshow s:b` at the command prompt, where `s:b` is the block index. The `bshow` command opens the system containing the block (if necessary) and selects the block in the systems window.

### Displaying a Model's Nonvirtual Systems

The `systems` command displays a list of the nonvirtual systems in the model that you are debugging. For example, the `sldemo_clutch` model contains the following systems:

```
open_system('sldemo_clutch')
set_param(gcs, 'OptimizeBlockIOStorage','off')
sldebug sldemo_clutch
(sldebug @0): %-----%
[TM = 0 ] simulate(sldemo_clutch)
(sldebug @0): >> systems
0 'sldemo_clutch'
1 'sldemo_clutch/Locked'
2 'sldemo_clutch/Unlocked'
```

---

**Note** The `systems` command does not list subsystems that are purely graphical. That is, subsystems that the model diagram represents as Subsystem blocks but that are solved as part of a parent system. are not listed. In Simulink models, the root system and triggered or enabled subsystems are true systems. All other subsystems are virtual (that is, graphical) and do not appear in the listing from the `systems` command.

---

### Displaying a Model's Nonvirtual Blocks

The `slist` command displays a list of the nonvirtual blocks in a model. The listing groups the blocks by system. For example, the following sequence of commands produces a list of the nonvirtual blocks in the Van der Pol (`vdp`) example model.

```
sldebug vdp
```

```

%-----%
[TM = 0                               ] simulate(vdp)
sldebug @0): >> slist

---- Sorted list for 'vdp' [9 nonvirtual blocks, directFeed=0]
 0:0   'vdp/x1' (Integrator)
 0:1   'vdp/Out1' (Outport)
 0:2   'vdp/x2' (Integrator)
 0:3   'vdp/Out2' (Outport)
 0:4   'vdp/Scope' (Scope)
 0:5   'vdp/Fcn' (Fcn)
 0:6   'vdp/Product' (Product)
 0:7   'vdp/Mu' (Gain)
 0:8   'vdp/Sum' (Sum)

```

---

**Note** The `slist` command does not list blocks that are purely graphical. That is, blocks that indicate relationships between or groupings among computational blocks.

---

### Displaying Blocks with Potential Zero Crossings

The `zclist` command displays a list of blocks in which nonsampled zero crossings can occur during a simulation. For example, `zclist` displays the following list for the clutch sample model:

```

(sldebug @0): >> zclist
 0 0:4:0   F HitCross 'sldemo_clutch/Friction Mode Logic/Lockup
Detection/Velocities Match'
 1 0:4:1   F
 2 0:10:0  F Abs 'sldemo_clutch/Friction Mode Logic/Lockup
Detection/Required Friction for Lockup/Abs'
 3 0:12:0  F RelationalOperator 'sldemo_clutch/Friction Mode
Logic/Lockup Detection/Required Friction for Lockup/Relational Operator'
 4 0:19:0  F Abs 'sldemo_clutch/Friction Mode Logic/Break Apart
Detection/Abs'
 5 0:20:0  F RelationalOperator 'sldemo_clutch/Friction Mode
Logic/Break Apart Detection/Relational Operator'
 6 2:3:0   F Signum 'sldemo_clutch/Unlocked/slip direction'

```

### Displaying Algebraic Loops

The `ashow` command highlights a specified algebraic loop or the algebraic loop that contains a specified block. To highlight a specified algebraic loop, enter `ashow s#n`, where `s` is the index of the system (see “Identifying Blocks in Algebraic Loops” on page 32-34) that contains the loop and `n` is the index of the loop in the system. To display the loop that contains the currently selected block, enter `ashow gcb`. To show a loop that

contains a specified block, enter `ashow s:b`, where `s:b` is the block's index. To clear algebraic-loop highlighting from the model diagram, enter `ashow clear`.

### Displaying Debugger Status

In GUI mode, the debugger displays the settings of various debug options, such as conditional breakpoints, in its **Status** panel. In command-line mode, the `status` command displays debugger settings. For example, the following sequence of commands displays the initial debug settings for the `vdp` model:

```
sim('vdp', 'StopTime', '10', 'debug', 'on')
%-----%
[TM = 0                               ] simulate(vdp)
(sldebug @0): >> status
%-----%
Current simulation time                : 0.0 (MajorTimeStep)
Solver needs reset                     : no
Solver derivatives cache needs reset   : no
Zero crossing signals cache needs reset : no
Default command to execute on return/enter : ""
Break at zero crossing events          : disabled
Break on solver error                  : disabled
Break on failed integration step       : disabled
Time break point                      : disabled
Break on non-finite (NaN,Inf) values   : disabled
Break on solver reset request          : disabled
Display level for disp, trace, probe   : 1 (i/o, states)
Solver trace level                     : 0
Algebraic loop tracing level          : 0
Animation Mode                        : off
Execution Mode                        : Normal
Display level for etrace               : 0 (disabled)
Break points                          : none installed
Display points                        : none installed
Trace points                          : none installed
```

### Related Examples

- “Start the Simulink Debugger” on page 32-13
- “Start a Simulation” on page 32-15
- “Set Breakpoints” on page 32-23
- “Display Information About the Simulation” on page 32-29

- “Run Accelerator Mode with the Simulink Debugger” on page 33-33

### **More About**

- “Debugger Graphical User Interface” on page 32-3
- “Debugger Command-Line Interface” on page 32-10
- “Debugger Online Help” on page 32-12



# Accelerating Models

---

- “What Is Acceleration?” on page 33-2
- “How Acceleration Modes Work” on page 33-4
- “Code Regeneration in Accelerated Models” on page 33-9
- “Choosing a Simulation Mode” on page 33-12
- “Design Your Model for Effective Acceleration” on page 33-18
- “Perform Acceleration” on page 33-25
- “Interact with the Acceleration Modes Programmatically” on page 33-29
- “Run Accelerator Mode with the Simulink Debugger” on page 33-33
- “Comparing Performance” on page 33-35
- “How to Improve Performance in Acceleration Modes” on page 33-39

## What Is Acceleration?

*Acceleration* is a mode of operation in the Simulink product that you can use to speed up the execution of your model. The Simulink software includes two modes of acceleration: accelerator mode and the rapid accelerator mode. Both modes replace the normal interpreted code with compiled target code. Using compiled code speeds up simulation of many models, especially those where run time is long compared to the time associated with compilation and checking to see if the target is up to date.

The accelerator mode works with any model, but performance decreases if a model contains blocks that do not support acceleration. The accelerator mode supports the Simulink debugger and profiler. These tools help with debugging and determining relative performance of various parts of your model. For more information, see “Run Accelerator Mode with the Simulink Debugger” on page 33-33 and “How Profiler Captures Performance Data” on page 29-5.

The rapid accelerator mode works with only those models containing blocks that support code generation of a standalone executable. For this reason, rapid accelerator mode does not support the debugger or profiler. However, this mode generally results in faster execution than the accelerator mode. When used with dual-core processors, the rapid accelerator mode runs Simulink and the MATLAB technical computing environment from one core while the rapid accelerator target runs as a separate process on a second core.

For more information about the performance characteristics of the Accelerator and rapid accelerator modes, and how to measure the difference in performance, see “Comparing Performance” on page 33-35.

To optimize your model and achieve faster simulation automatically using Performance Advisor, see “Automated Performance Optimization”.

To employ modeling techniques that help achieve faster simulation, see “Manual Performance Optimization”.

### Related Examples

- “Design Your Model for Effective Acceleration” on page 33-18
- “Perform Acceleration” on page 33-25

### More About

- “How Acceleration Modes Work” on page 33-4

- “Choosing a Simulation Mode” on page 33-12
- “Comparing Performance” on page 33-35

## How Acceleration Modes Work

In this section...
“Overview” on page 33-4
“Normal Mode” on page 33-4
“Accelerator Mode” on page 33-5
“Rapid Accelerator Mode” on page 33-7

### Overview

The Accelerator and rapid accelerator modes use portions of the Simulink Coder product to create an executable.

The Accelerator and rapid accelerator modes replace the interpreted code normally used in Simulink simulations, shortening model run time.

Although the acceleration modes use some Simulink Coder code generation technology, you do not need the Simulink Coder software installed to accelerate your model.

---

**Note:** The code generated by the accelerator and rapid accelerator modes is suitable only for speeding the simulation of your model. Use Simulink Coder to generate code for other purposes.

---

### Normal Mode

In normal mode, the MATLAB technical computing environment is the foundation on which the Simulink software is built. Simulink controls the solver and model methods used during simulation. Model methods on page 3-16 include such things as computation of model outputs. Normal mode runs in one process.

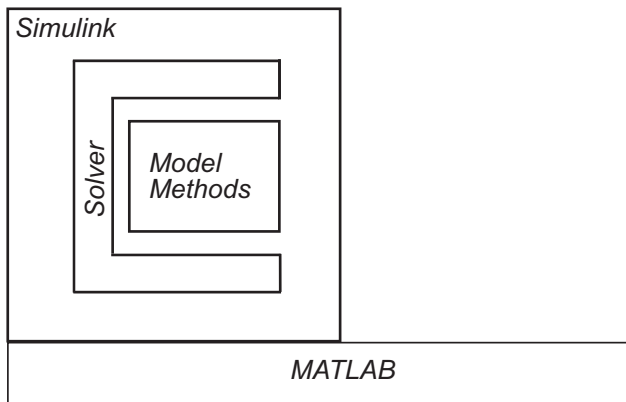

*One Process*

## Accelerator Mode

By default, the accelerator mode uses Just-in-Time (JIT) acceleration to generate an execution engine in memory instead of generating C code or MEX files. You can also have your model fall back to the classic accelerator mode, in which Simulink generates and links code into a C-MEX S-function.

In the accelerator mode, the model methods are separate from the Simulink software and are part of the *acceleration target code*, which is used in later simulations.

Simulink checks that the acceleration target code is up to date before reusing it. For more information, see “Code Regeneration in Accelerated Models” on page 33-9 .

There are two modes of operation in accelerator mode.

### Just-In-Time Accelerator Mode

In this default mode, Simulink generates an execution engine in memory for the top-level model only and not for referenced models. As a result, a C compiler is not required during simulation.

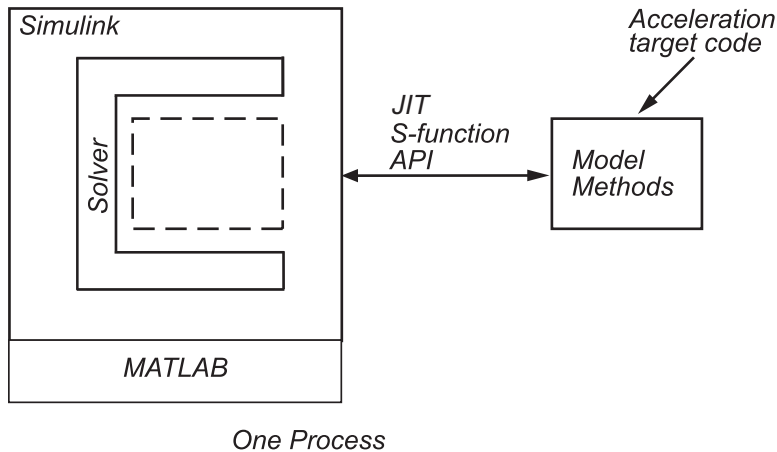

Because the acceleration target code is in memory, it is available for reuse as long as the model is open. Simulink also serializes the acceleration target code so that the model does not need rebuilding when it is opened.

### Classic Accelerator Mode

If you want to simulate your model using the classic, C-code generating, accelerator mode, run the following command:

```
set_param(0, 'GlobalUseClassicAccelMode', 'on');
```

In this mode, Simulink generates and links code into a shared library, which communicates with the Simulink software. The target code executes in the same process as MATLAB and Simulink.

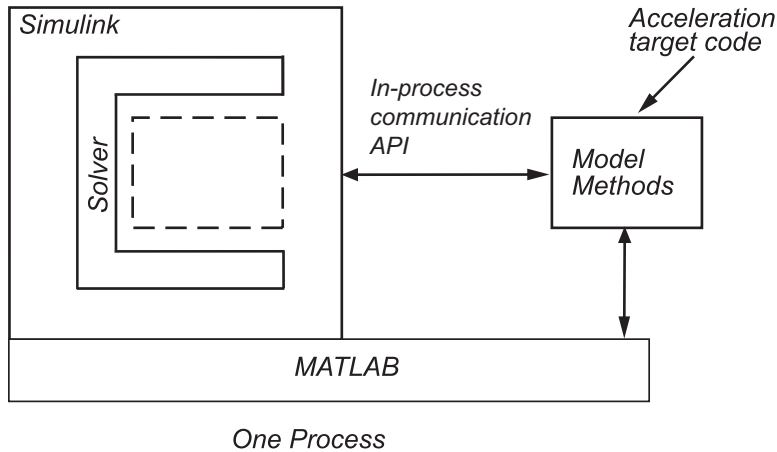

## Rapid Accelerator Mode

The rapid accelerator mode creates a *Rapid Accelerator standalone executable* from your model. This executable includes the solver and model methods, but it resides outside of MATLAB and Simulink. It uses external mode (see “External Mode Communication” (Simulink Coder)) to communicate with Simulink.

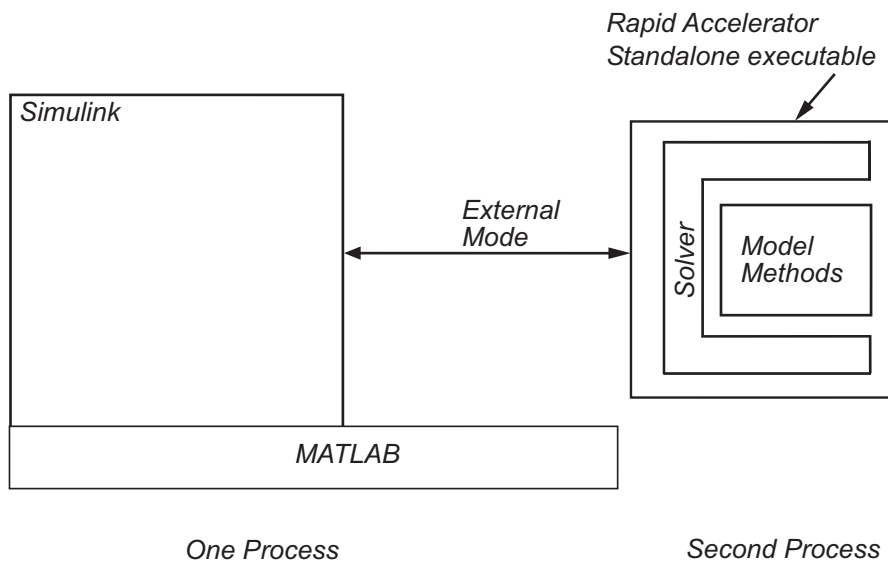

MATLAB and Simulink run in one process, and if a second processing core is available, the standalone executable runs there.

### Related Examples

- “Design Your Model for Effective Acceleration” on page 33-18
- “Perform Acceleration” on page 33-25

### More About

- “Choosing a Simulation Mode” on page 33-12
- “Code Regeneration in Accelerated Models” on page 33-9
- “Comparing Performance” on page 33-35



## Code Regeneration in Accelerated Models

### In this section...

“Determine If the Simulation Will Rebuild” on page 33-9

“Parameter Tuning in Rapid Accelerator Mode” on page 33-9

Changing the structure of your model causes the Rapid Accelerator mode to regenerate the standalone executable, and for the Accelerator mode to regenerate the target code and update (overwrite) the existing MEX-file. Changing the value of a tunable parameter does not trigger a rebuild.

### Determine If the Simulation Will Rebuild

The Accelerator and Rapid Accelerator modes use a checksum to determine if the model has changed, indicating that the code should be regenerated. The checksum is an array of four integers computed using an MD5 checksum algorithm based on attributes of the model and the blocks it contains.

- 1 Use the `Simulink.BlockDiagram.getChecksum` command to obtain the checksum for your model. For example:  

```
cs1 = Simulink.BlockDiagram.getChecksum('myModel');
```
- 2 Obtain a second checksum after you have altered your model. The code regenerates if the new checksum does not match the previous checksum.
- 3 Use the information in the checksum to determine why the simulation target rebuilt.

For a detailed explanation of this procedure, see the example model `slAcce1DemoWhyRebuild`.

### Parameter Tuning in Rapid Accelerator Mode

In model rebuilds, Rapid Accelerator Mode handles block diagram and runtime parameters differently from other parameters.

#### Tuning Block Diagram Parameters

You can change some block diagram parameters during simulation without causing a rebuild. Tune these parameters using the `set_param` command or using the **Model Configuration Parameters** dialog box. These block diagram parameters include:

Solver Parameters		
AbsTol	MaxNumMinSteps	RelTol
ConsecutiveZCsStepRelTol	MaxOrder	StartTime
ExtrapolationOrder	MaxStep	StopTime
InitialStep	MinStep	ZCDetectionTol
MaxConsecutiveMinStep	OutputTimes	
MaxConsecutiveZCs	Refine	

Loading and Logging Parameters		
ConsistencyChecking	MinStepSizeMsg	SaveTime
Decimation	OutputOption	StateSaveName
FinalStateName	OutputSaveName	TimeSaveName
LimitDataPoints	SaveFinalState	
LoadExternalInput	SaveFormat	
MaxConsecutiveZCsMsg	SaveOutput	
MaxDataPoints	SaveState	

### Tuning Runtime Parameters

To tune runtime parameters for maximum acceleration in Rapid Accelerator mode, follow this procedure which yields better results than using `set_param` for the same purpose:

- 1 Collect the runtime parameters in a runtime parameter structure while building a rapid accelerator target executable using the `Simulink.BlockDiagram.buildRapidAcceleratorTarget` function.
- 2 To change the parameters, use the `Simulink.BlockDiagram.modifyTunableParameters` function.
- 3 To specify the modified parameters to the `sim` command, use the `RapidAcceleratorParameterSets` and `RapidAcceleratorUpToDateCheck` parameters.

All other parameter changes can necessitate a rebuild of the model.

<b>Parameter Changes:</b>	<b>Passed Directly to <code>sim</code> command</b>	<b>Passed Graphically via Block Diagram or via <code>set_param</code> command</b>
Runtime	Does not require rebuild	Can require rebuild
Block diagram (logging parameters)	Does not require rebuild	Does not require rebuild

## Related Examples

- “Design Your Model for Effective Acceleration” on page 33-18
- “Perform Acceleration” on page 33-25
- “How to Improve Performance in Acceleration Modes” on page 33-39
- “Optimize, Estimate, and Sweep Block Parameter Values” on page 35-50

## More About

- “What Is Acceleration?” on page 33-2
- “Choosing a Simulation Mode” on page 33-12
- “How Acceleration Modes Work” on page 33-4
- “Comparing Performance” on page 33-35

## Choosing a Simulation Mode

### In this section...

“Simulation Mode Tradeoffs” on page 33-12

“Comparing Modes” on page 33-13

“Decision Tree” on page 33-15

### Simulation Mode Tradeoffs

In general, you must trade off simulation speed against flexibility when choosing either Accelerator mode or Rapid Accelerator mode instead of Normal mode.

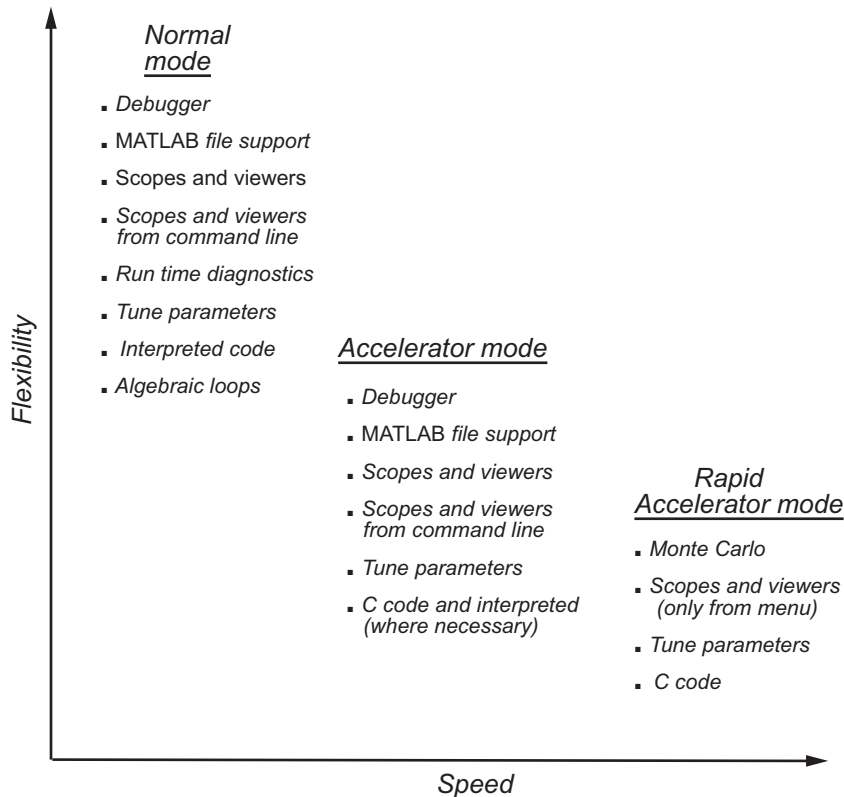

Normal mode offers the greatest flexibility for making model adjustments and displaying results, but it runs the slowest.

Accelerator mode lies between Normal and Rapid Accelerator modes in performance and in interaction with your model. If your model has 3-D signals, use Normal or Accelerator mode. Accelerator mode does not support runtime diagnostics.

Rapid Accelerator mode runs the fastest, but this mode does not support the debugger or profiler, and works only with those models for which C code is available for all of the blocks in the model. In addition, Rapid Accelerator mode does not support 3-D parameters and sinks.

**Note:** An exception to this rule occurs when you run multiple simulations, each of which executes in less than one second in Normal mode. For example:

```
for i=1:100
sim(model); % executes in less than one second in Normal mode
end
```

For this set of conditions, you will typically obtain the best performance by simulating the model in Normal mode.

**Tip:** To gain additional flexibility, consider using model referencing to componentize your model. If the top-level model uses Normal mode, then you can simulate a referenced model in a different simulation mode than you use for other portions of a model. During the model development process, you can choose different simulation modes for different portions of a model. For details, see “Simulate Model Referencing Models” on page 8-31.

## Comparing Modes

The following table compares the characteristics of Normal mode, Accelerator mode, and Rapid Accelerator mode.

If you want to...	Then use this mode...		
	Normal	Accelerator	Rapid Accelerator
<b>Performance</b>			
Run your model in a separate address space			✓

If you want to...	Then use this mode...		
	Normal	Accelerator	Rapid Accelerator
Efficiently run batch and Monte Carlo simulations			✓
<b>Model Adjustment</b>			
Change model parameters such as solver, stop time without rebuilding	✓	✓	✓
Change block tunable parameters such as gain	✓	✓	✓
For more information on configuration set parameters which can be modified without requiring rebuild, see “Code Regeneration in Accelerated Models” on page 33-9			
<b>Model Requirement</b>			
Accelerate your model even if C code is not used for all blocks		✓	
Support Interpreted MATLAB Function blocks	✓	✓	
Support Non-Inlined MATLAB language or Fortran S-Functions	✓	✓	
Permit algebraic loops in your model	✓	✓	
Have your model work with the debugger or profiler	✓	✓	
Have your model include C++ code	✓	✓	
<b>Data Display</b>			
Use scopes and signal viewers	✓	✓	See “Behavior of Scopes and Viewers with Rapid Accelerator Mode” on page 33-21
Use scopes and signal viewers when running your model from the command line	✓	✓	

---

**Note:** Scopes and viewers do not update if you run your model from the command line in Rapid Accelerator mode.

---

## Decision Tree

Use this decision tree to select between Normal, Accelerator, or Rapid Accelerator modes.

See “Comparing Performance” on page 33-35 to understand how effective the accelerator modes will be in improving the performance of your model.

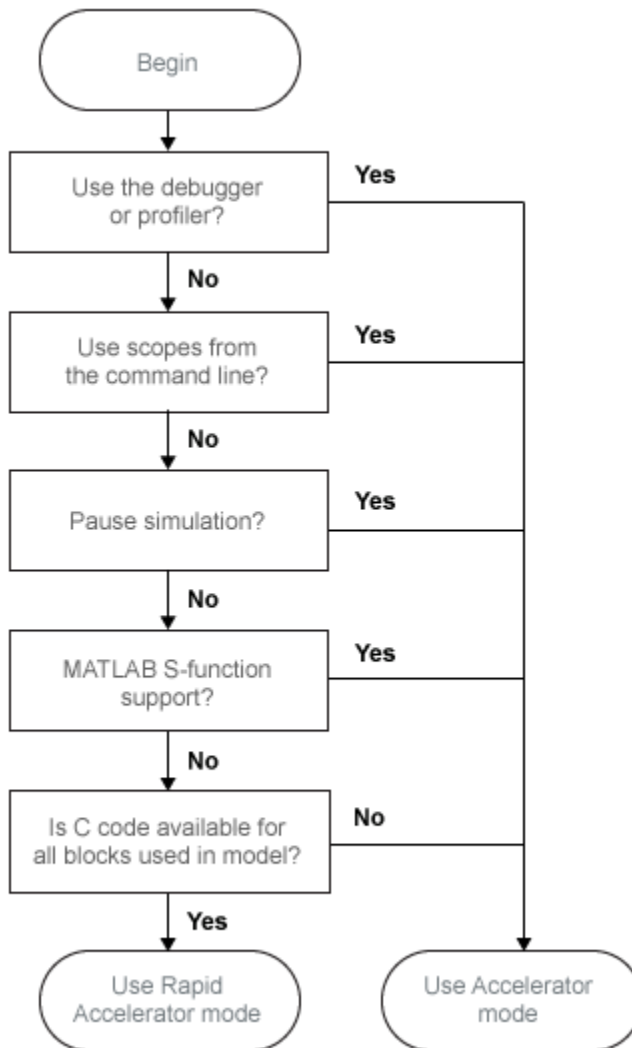

## Related Examples

- “Design Your Model for Effective Acceleration” on page 33-18



- “Interact with the Acceleration Modes Programmatically” on page 33-29

### **More About**

- “Code Regeneration in Accelerated Models” on page 33-9
- “How Acceleration Modes Work” on page 33-4

## Design Your Model for Effective Acceleration

### In this section...

“Select Blocks for Accelerator Mode” on page 33-18

“Select Blocks for Rapid Accelerator Mode” on page 33-19

“Control S-Function Execution” on page 33-19

“Accelerator and Rapid Accelerator Mode Data Type Considerations” on page 33-20

“Behavior of Scopes and Viewers with Rapid Accelerator Mode” on page 33-21

“Factors Inhibiting Acceleration” on page 33-22

### Select Blocks for Accelerator Mode

The Accelerator simulation mode runs the following blocks as if you were running Normal mode because these blocks do not generate code for the accelerator build. Consequently, if your model contains a high percentage of these blocks, the Accelerator mode may not increase performance significantly. All of these Simulink blocks use interpreted code.

- Display
- From File
- From Workspace
- Inport (root level only)
- Interpreted MATLAB Function
- Outport (root level only)
- Scope
- To File
- To Workspace
- XY Graph

---

**Note:** In some instances, Normal mode output might not precisely match the output from Accelerator mode because of slight differences in the numerical precision between the interpreted and compiled versions of a model.

---

The following blocks can cause poor simulation runtime performance when run in the default JIT Accelerator mode.

- Transport Delay
- Variable Transport Delay

## Select Blocks for Rapid Accelerator Mode

Blocks that do not support code generation (such as SimEvents) or blocks that generate code only for a specific target cannot be simulated in Rapid Accelerator mode.

Additionally, Rapid Accelerator mode does not work if your model contains any of the following blocks:

- Interpreted MATLAB Function
- Device driver S-functions, such as blocks from the Simulink Real-Time product, or those targeting Freescale™ MPC555

---

**Note:** In some instances, Normal mode output might not precisely match the output from Rapid Accelerator mode because of slight differences in the numerical precision between the interpreted and compiled versions of a model.

---

## Control S-Function Execution

---

**Note:** In the default JIT Accelerator mode, inlining of user-written TLC S-Functions is not supported. If you run a model containing TLC S-Functions in the JIT Accelerator mode, there is a possibility of the execution speed reducing. The code generation speed, however, will be high due to JIT acceleration.

---

Inlining S-functions using the Target Language Compiler increases performance with the classic Accelerator mode by eliminating unnecessary calls to the Simulink API. By default, however, the classic Accelerator mode ignores an inlining TLC file for an S-function, even though the file exists. The Rapid Accelerator mode always uses the TLC file if one is available.

A device driver S-Function block written to access specific hardware registers on an I/O board is one example of why this behavior was chosen as the default. Because the

Simulink software runs on the host system rather than the target, it cannot access the targets I/O registers and so would fail when attempting to do so.

To direct the classic Accelerator mode to use the TLC file instead of the S-function MEX-file, specify `SS_OPTION_USE_TLC_WITH_ACCELERATOR` in the `mdlInitializeSizes` function of the S-function, as in this example:

```
static void mdlInitializeSizes(SimStruct *S)
{
/* Code deleted */
ssSetOptions(S, SS_OPTION_USE_TLC_WITH_ACCELERATOR);
}
```

The Rapid Accelerator mode will make use of the MEX file if the S-Function's C file is not present in the same folder.

---

**Note:** to use the `.c` or `.cpp` code for your S-Function, ensure that they are in the same folder as the S-Function MEX-file, otherwise, you can include additional files to an S-function or bypass the path limitation by using the `rtwmakecfg.m` file. For more information, see [Use `rtwmakecfg.m` API to Customize Generated Makefiles \(Simulink Coder\)](#).

---

## Accelerator and Rapid Accelerator Mode Data Type Considerations

- Accelerator mode supports fixed-point signals and vectors up to 128 bits.
- Rapid Accelerator mode does not support fixed-point signals or vectors greater than 32 bits.
- Rapid Accelerator mode supports fixed-point parameters up to 128 bits.
- Rapid Accelerator mode supports fixed-point root inputs up to 32 bits
- Rapid Accelerator mode supports root inputs of Enumerated data type
- Rapid Accelerator mode does not support fixed-point data for the From Workspace block.
- Rapid Accelerator mode ignores the selection of the **Log fixed-point data as a fi object** (FixptAsFi) check box for the To Workspace block.
- Rapid Accelerator mode supports bus objects as parameters.
- The Accelerator mode and Rapid Accelerator mode store integers as compactly as possible.

- Fixed-Point Designer does not collect min, max, or overflow data in the Accelerator or Rapid Accelerator modes.
- Accelerator mode does not support runtime diagnostics.

## Behavior of Scopes and Viewers with Rapid Accelerator Mode

Running the simulation from the command line or the menu determines the behavior of scopes and viewers in Rapid Accelerator mode.

Scope or Viewer Type	Simulation Run from Menu	Simulation Run from Command Line
Simulink Scope blocks	Same support as Normal mode	<ul style="list-style-type: none"> <li>• Logging is supported</li> <li>• Scope window is not updated</li> </ul>
Simulink signal viewer scopes	Graphics are updated, but logging is not supported	Not supported
Other signal viewer scopes	Support limited to that available in External mode	Not supported
Signal logging	Supported, with limitations listed in “Signal Logging in Rapid Accelerator Mode” on page 59-71	Supported, with limitations listed in “Signal Logging in Rapid Accelerator Mode” on page 59-71.
Multirate signal viewers	Not supported	Not supported
Stateflow Chart blocks	Same support for chart animation as Normal mode	Not supported

Rapid Accelerator mode does not support multirate signal viewers such as the DSP System Toolbox spectrum scope or the Communications System Toolbox™ scatterplot, signal trajectory, or eye diagram scopes.

---

**Note:** Although scopes and viewers do not update when you run Rapid Accelerator mode from the command line, they do update when you use the menu. “Run Acceleration Mode from the User Interface” on page 33-25 shows how to run Rapid Accelerator mode from the menu. “Interact with the Acceleration Modes Programmatically” on page 33-29 shows how to run the simulation from the command line.

---

## Factors Inhibiting Acceleration

- You cannot use the Accelerator or Rapid Accelerator mode if your model:
  - Passes array parameters to MATLAB S-functions that are not numeric, logical, or character arrays, are sparse arrays, or that have more than two dimensions.
  - Uses Fcn blocks containing trigonometric functions having complex inputs.
- In some cases, changes associated with external or custom code do not cause Accelerator or Rapid Accelerator simulation results to change. These include:
  - TLC code
  - S-function source code, including `rtwmakecfg.m` files
  - Integrated custom code
  - S-Function Builder

In such cases, consider force regeneration of code for a top model. Alternatively, you can force regeneration of top model code by deleting code generation folders, such as `slprj` or the generated model code folder.

---

**Note:** With JIT acceleration, the acceleration target code is in memory. It is therefore available for reuse as long as the model is open, even if you delete the `slprj` folder.

---

## Rapid Accelerator Mode Limitations

- Rapid Accelerator mode does not support:
  - Algebraic loops.
  - Targets written in C++.
  - Interpreted MATLAB Function blocks.
  - Noninlined MATLAB language or Fortran S-functions. You must write S-functions in C or inline them using the Target Language Compiler (TLC) or you can also use the MEX file. For more information, see “Write Fully Inlined S-Functions” (Simulink Coder).
  - 3-D signals.
  - Debugger or Profiler.
  - Run time objects for `Simulink.RunTimeBlock` and `Simulink.BlockCompOutputPortData` blocks.

- Model parameters must be one of these data types:
  - `boolean`
  - `uint8` or `int8`
  - `uint16` or `int16`
  - `uint32` or `int32`
  - `single` or `double`
  - Fixed-point
  - Enumerated
- You cannot pause a simulation in Rapid Accelerator mode.
- If a Rapid Accelerator build includes referenced models (by using Model blocks), set up these models to use fixed-step solvers to generate code for them. The top model, however, can use a variable-step solver as long as the blocks in the referenced models are discrete.
- In certain cases, changing block parameters can result in structural changes to your model that change the model checksum. An example of such a change is changing the number of delays in a DSP simulation. In these cases, you must regenerate the code for the model. See “Code Regeneration in Accelerated Models” on page 33-9 for more information.
- For root inports, Rapid Accelerator mode supports only base as the `Srcworkspace`.
- For root inports, when you specify the minimum and maximum values that the block should output, Rapid Accelerator mode does not recognize these limits during simulation.
- In Rapid Accelerator mode, To File or To Workspace blocks inside function-call subsystems do not generate any logging files if the function-call port is grounded or unconnected.

### **Reserved Keywords**

Certain words are reserved for use by the Simulink Coder code language and by Accelerator mode and Rapid Accelerator mode. These keywords must not appear as function or variable names on a subsystem, or as exported global signal names. Using the reserved keywords results in the Simulink software reporting an error, and the model cannot be compiled or run.

The keywords reserved for the Simulink Coder product are listed in “Construction of Generated Identifiers” (Simulink Coder). Additional keywords that apply only to the Accelerator and Rapid accelerator modes are:

muDoubleScalarAbs	muDoubleScalarCos	muDoubleScalarMod
muDoubleScalarAcos	muDoubleScalarCosh	muDoubleScalarPower
muDoubleScalarAcosh	muDoubleScalarExp	muDoubleScalarRound
muDoubleScalarAsin	muDoubleScalarFloor	muDoubleScalarSign
muDoubleScalarAsinh	muDoubleScalarHypot	muDoubleScalarSin
muDoubleScalarAtan,	muDoubleScalarLog	muDoubleScalarSinh
muDoubleScalarAtan2	muDoubleScalarLog10	muDoubleScalarSqrt
muDoubleScalarAtanh	muDoubleScalarMax	muDoubleScalarTan
muDoubleScalarCeil	muDoubleScalarMin	muDoubleScalarTanh

## Related Examples

- “Design Your Model for Effective Acceleration” on page 33-18
- “Perform Acceleration” on page 33-25
- “How to Improve Performance in Acceleration Modes” on page 33-39

## More About

- “What Is Acceleration?” on page 33-2
- “How Acceleration Modes Work” on page 33-4
- “Choosing a Simulation Mode” on page 33-12



# Perform Acceleration

## In this section...

“Customize the Build Process” on page 33-25

“Run Acceleration Mode from the User Interface” on page 33-25

“Making Run-Time Changes” on page 33-27

## Customize the Build Process

Compiler optimizations are off by default. This results in faster build times, but slower simulation times. You can optimize the build process toward a faster simulation.

- 1 From the **Simulation** menu, select **Model Configuration Parameters**.
- 2 In the Configuration Parameters dialog box, select the **All Parameters** tab, and then from the **Compiler optimization level** drop-down list, select **Optimizations on (faster runs)**.

Code generation takes longer with this option, but the model simulation runs faster.

- 3 Select **Verbose accelerator builds** to display progress information using code generation, and to see the compiler options in use.

## Changing the Location of Generated Code

By default, the Accelerator mode places the generated code in a subfolder of the working folder called `slprj/accel/modelname` (for example, `slprj/accel/f14`). To change the name of the folder into which the Accelerator Mode writes generated code:

- 1 In the Simulink editor window, select **File > Simulink Preferences**.  
The Simulink Preferences window appears.
- 2 In the Simulink Preferences window, navigate to the **Simulation cache folder** parameter.
- 3 Enter the absolute or relative path to your subfolder and click **Apply**.

## Run Acceleration Mode from the User Interface

To accelerate a model, first open it, and then from the **Simulation > Mode** menu, select either **Accelerator** or **Rapid Accelerator**. Then start the simulation.

The following example shows how to accelerate the already opened f14 model using the Accelerator mode:

- 1 From the **Simulation > Mode** menu, select **Accelerator**.

Alternatively, you can select **Accelerator** from the Simulink Editor toolbar.

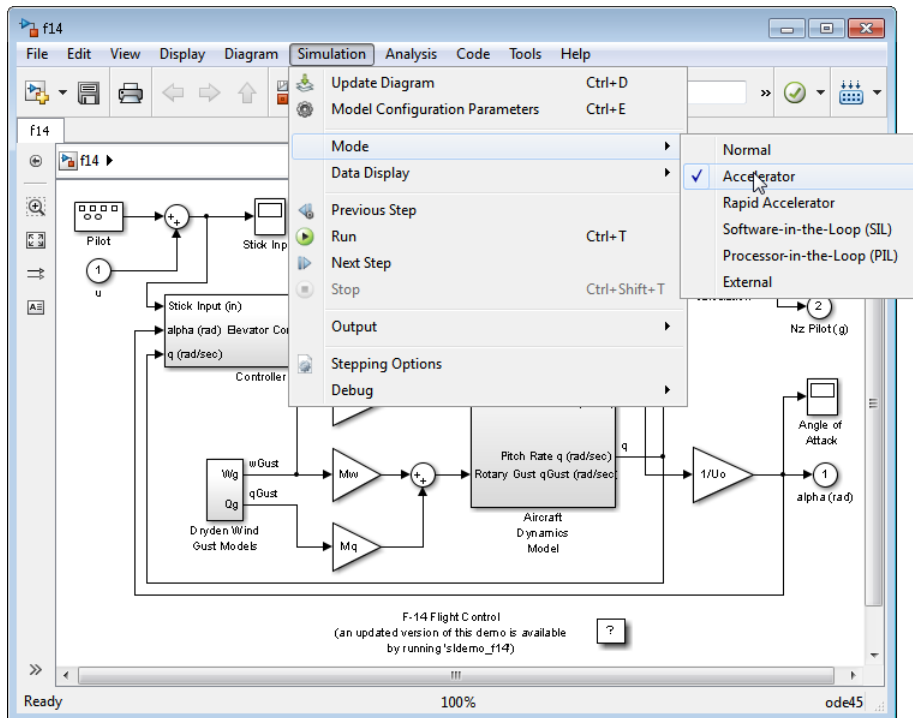

- 2 From the **Simulation** menu, select **Run**.

The Accelerator and Rapid Accelerator modes first check to see if code was previously compiled for your model. If code was created previously, the Accelerator or Rapid Accelerator mode runs the model. If code was not previously built, they first generate and compile the C code, and then run the model.

For an explanation of why these modes rebuild your model, see “Code Regeneration in Accelerated Models” on page 33-9.

The Accelerator mode places the generated code in a subfolder of the working folder called `slprj/accel/modelname` (for example, `slprj/accel/f14`). If you want to change this path, see “Changing the Location of Generated Code” on page 33-25.

The Rapid Accelerator mode places the generated code in a subfolder of the working folder called `slprj/raccel/modelname` (for example, `slprj/raccel/f14`).

---

**Note:** The warnings that blocks generate during simulation (such as divide-by-zero and integer overflow) are not displayed when your model runs in Accelerator or Rapid Accelerator mode.

---

## Making Run-Time Changes

A feature of the Accelerator and Rapid Accelerator modes is that simple adjustments (such as changing the value of a Gain or Constant block) can be made to the model while the simulation is still running. More complex changes (for example, changing from a `sin` to `tan` function) are not allowed during run time.

The Simulink software issues a warning if you attempt to make a change that is not permitted. The absence of a warning indicates that the change was accepted. The warning does not stop the current simulation, and the simulation continues with the previous values. If you wish to alter the model in ways that are not permitted during run time, you must first stop the simulation, make the change, and then restart the simulation.

In general, simple model changes are more likely to result in code regeneration when in Rapid Accelerator mode than when in Accelerator mode.

## Related Examples

- “Design Your Model for Effective Acceleration” on page 33-18
- “Interact with the Acceleration Modes Programmatically” on page 33-29
- “Run Accelerator Mode with the Simulink Debugger” on page 33-33

## More About

- “How Acceleration Modes Work” on page 33-4
- “Code Regeneration in Accelerated Models” on page 33-9

- “How Acceleration Modes Work” on page 33-4

## Interact with the Acceleration Modes Programmatically

### In this section...

“Why Interact Programmatically?” on page 33-29

“Build JIT Accelerated Execution Engine” on page 33-29

“Control Simulation” on page 33-29

“Simulate Your Model” on page 33-30

“Customize the Acceleration Build Process” on page 33-31

### Why Interact Programmatically?

You can build an accelerated model, select the simulation mode, and run the simulation from the command prompt or from MATLAB script. With this flexibility, you can create Accelerator mode MEX-files in batch mode, allowing you to build the C code and executable before running the simulations. When you use the Accelerator mode interactively at a later time, it will not be necessary to generate or compile MEX-files at the start of the accelerated simulations.

### Build JIT Accelerated Execution Engine

With the `accelbuild` command, you can build a JIT accelerated execution engine without actually simulating the model. For example, to build an Accelerator mode simulation of `myModel`:

```
accelbuild myModel
```

### Control Simulation

You can control the simulation mode from the command line prompt by using the `set_param` command:

```
set_param('modelName', 'SimulationMode', 'mode')
```

The simulation mode can be `normal`, `accelerator`, `rapid`, or `external`.

For example, to simulate your model with the Accelerator mode, you would use:

```
set_param('myModel', 'SimulationMode', 'accelerator')
```

However, a preferable method is to specify the simulation mode within the `sim` command:

```
simOut = sim('myModel', 'SimulationMode', 'accelerator');
```

You can use `bdroot` to set parameters for the currently active model (that is, the active model window) rather than *modelName* if you do not wish to explicitly specify the model name.

For example, to simulate the currently opened system in the Rapid Accelerator mode, you would use:

```
simOut = sim(bdroot, 'SimulationMode', 'rapid');
```

## Simulate Your Model

You can use `set_param` to configure the model parameters (such as the simulation mode and the stop time), and use the `sim` command to start the simulation:

```
sim('modelName', 'ReturnWorkspaceOutputs', 'on');
```

However, the preferred method is to configure model parameters directly using the `sim` command, as shown in the previous section.

You can substitute `gcs` for *modelName* if you do not want to explicitly specify the model name.

Unless target code has already been generated, the `sim` command first builds the executable and then runs the simulation. However, if the target code has already been generated and no significant changes have been made to the model (see “Code Regeneration in Accelerated Models” on page 33-9 for a description), the `sim` command executes the generated code without regenerating the code. This process lets you run your model after making simple changes without having to wait for the model to rebuild.

## Simulation Example

The following sequence shows how to programmatically simulate `myModel` in Rapid Accelerator mode for 10,000 seconds.

First open `myModel`, and then type the following in the Command Window:

```
simOut = sim('myModel', 'SimulationMode', 'rapid'...  
'StopTime', '10000');
```

Use the `sim` command again to resimulate after making a change to your model. If the change is minor (adjusting the gain of a gain block, for instance), the simulation runs without regenerating code.

## Customize the Acceleration Build Process

You can programmatically control the Accelerator mode and Rapid Accelerator mode build process and the amount of information displayed during the build process. See “Customize the Build Process” on page 33-25 for details on why doing so might be advantageous.

### Controlling the Build Process

Use `SimCompilerOptimization` to set the degree of optimization used by the compiler when generating code for acceleration. The permitted values are `on` or `off`. The default is `off`.

Enter the following at the command prompt to turn on compiler optimization:

```
set_param('myModel', 'SimCompilerOptimization', 'on')
```

When `SimCompilerOptimization` is set to `on` in JIT accelerated mode, the simulation time for some models improves, while the build time can become slower.

### Controlling Verbosity During Code Generation

Use the `AccelVerboseBuild` parameter to display progress information during code generation. The permitted values are `on` or `off`. The default is `off`.

Enter the following at the command prompt to turn on verbose build:

```
set_param('myModel', 'AccelVerboseBuild', 'on')
```

## Related Examples

- “Design Your Model for Effective Acceleration” on page 33-18
- “Perform Acceleration” on page 33-25
- “Run Accelerator Mode with the Simulink Debugger” on page 33-33

## More About

- “How Acceleration Modes Work” on page 33-4

- “Choosing a Simulation Mode” on page 33-12
- “Code Regeneration in Accelerated Models” on page 33-9



## Run Accelerator Mode with the Simulink Debugger

### In this section...

“Advantages of Using Accelerator Mode with the Debugger” on page 33-33

“How to Run the Debugger” on page 33-33

“When to Switch Back to Normal Mode” on page 33-33

### Advantages of Using Accelerator Mode with the Debugger

The Accelerator mode can shorten the length of your debugging sessions if you have large and complex models. For example, you can use the Accelerator mode to simulate a large model and quickly reach a distant breakpoint.

For more information, see “Accelerator Mode” on page 33-5.

---

**Note:** You cannot use the Rapid Accelerator mode with the debugger.

---

### How to Run the Debugger

To run your model in the Accelerator mode with the debugger:

- 1 From the **Simulation > Mode** menu, select **Accelerator**.
- 2 At the command prompt, enter:  

```
sldebug modelName
```
- 3 At the debugger prompt, set a time break:  

```
tbreak 10000  
continue
```
- 4 Once you reach the breakpoint, use the debugger command **emode** (execution mode) to toggle between Accelerator and Normal mode.

### When to Switch Back to Normal Mode

You must switch to Normal mode to step through the simulation by blocks, and when you want to use the following debug commands:

- trace
- break
- zcbreak
- nanbreak

### **Related Examples**

- “Design Your Model for Effective Acceleration” on page 33-18
- “Perform Acceleration” on page 33-25
- “Interact with the Acceleration Modes Programmatically” on page 33-29

### **More About**

- “What Is Acceleration?” on page 33-2
- “How Acceleration Modes Work” on page 33-4
- “Choosing a Simulation Mode” on page 33-12

## Comparing Performance

<b>In this section...</b>
“Performance of the Simulation Modes” on page 33-35
“Measure Performance” on page 33-37

### Performance of the Simulation Modes

The Accelerator and Rapid Accelerator modes give the best speed improvement compared to Normal mode when simulation execution time exceeds the time required for code generation. For this reason, the Accelerator and Rapid Accelerator modes generally perform better than Normal mode when simulation execution times are several minutes or more. However, models with a significant number of Stateflow or MATLAB Function blocks might show only a small speed improvement over Normal mode because in Normal mode these blocks also simulate through code generation.

Including tunable parameters in your model can also increase the simulation time.

The figure shows in general terms the performance of a hypothetical model simulated in Normal, Accelerator, and Rapid Accelerator modes.

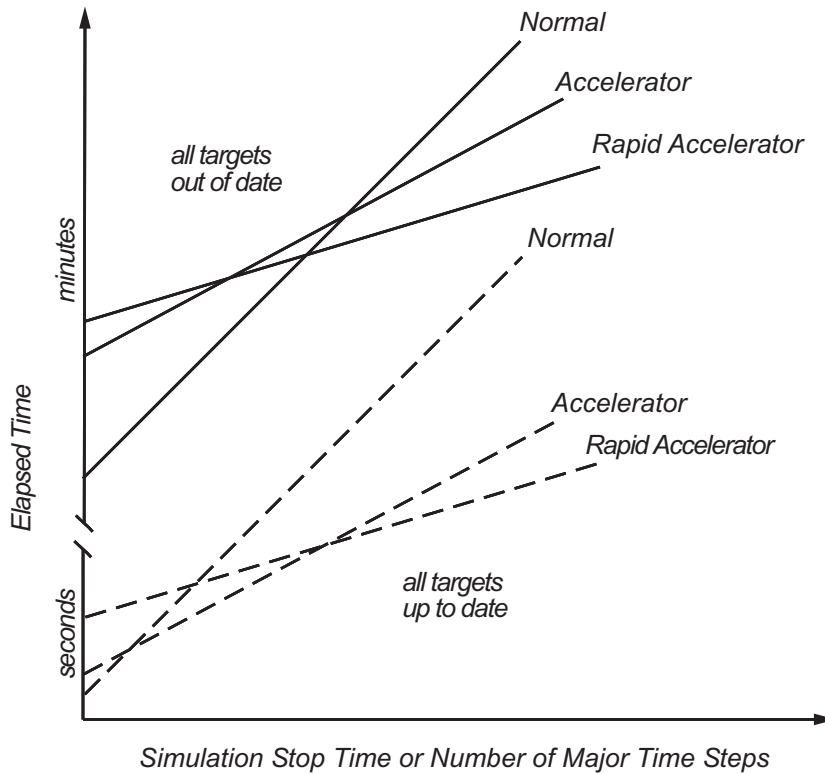

### Performance When the Target Must Be Rebuilt

The solid lines in the figure show performance when the target code must be rebuilt (“all targets out of date”). For this hypothetical model, the time scale is on the order of minutes, but it could be longer for more complex models.

As generalized in the figure, the time required to compile the model in Normal mode is less than the time required to build either the Accelerator target or Rapid Accelerator executable. It is evident from the figure that for small simulation stop times Normal mode results in quicker overall simulation times than either Accelerator mode or Rapid Accelerator mode.

The crossover point where Accelerator mode or Rapid Accelerator mode result in faster execution times depends on the complexity and content of your model. For instance, those models running in Accelerator mode containing large numbers of blocks using

interpreted code (see “Select Blocks for Accelerator Mode” on page 33-18) might not run much faster than they would in Normal mode unless the simulation stop time is very large. Similarly, models with a large number of Stateflow Chart blocks or MATLAB Function blocks might not show much speed improvement over Normal mode unless the simulation stop times are long.

For illustration purposes, the graphic represents a model with a large number of Stateflow Chart blocks or MATLAB Function blocks. The curve labeled “Normal” would have much smaller initial elapsed time than shown if the model did not contain these blocks.

### Performance When the Targets Are Up to Date

As shown by the broken lines in the figure (“all targets up to date”) the time for the Simulink software to determine if the Accelerator target or the Rapid Accelerator executable are up to date is significantly less than the time required to generate code (“all targets out of date”). You can take advantage of this characteristic when you wish to test various design tradeoffs.

For instance, you can generate the Accelerator mode target code once and use it to simulate your model with a series of gain settings. This is an especially efficient way to use the Accelerator or Rapid Accelerator modes because this type of change does not result in the target code being regenerated. This means the target code is generated the first time the model runs, but on subsequent runs the Simulink code spends only the time necessary to verify that the target is up to date. This process is much faster than generating code, so subsequent runs can be significantly faster than the initial run.

Because checking the targets is quicker than code generation, the crossover point is smaller when the target is up to date than when code must be generated. This means subsequent runs of your model might simulate faster in Accelerator or Rapid Accelerator mode when compared to Normal mode, even for short stop times.

## Measure Performance

You can use the `tic`, `toc`, and `sim` commands to compare Accelerator mode or Rapid Accelerator mode execution times to Normal mode.

- 1 Open your model.
- 2 From the **Simulation** > **Mode** menu, select **Normal**.
- 3 Use the `tic`, `toc`, and `sim` commands at the command line prompt to measure how long the model takes to simulate in Normal mode:

```
tic,[t,x,y]=sim('myModel',10000);toc
```

`tic` and `toc` work together to record and return the elapsed time and display a message such as the following:

```
Elapsed time is 17.789364 seconds.
```

- 4 Select either **Accelerator** or **Rapid Accelerator** from the **Simulation > Mode** menu, and build an executable for the model by clicking the **Run** button. The acceleration modes use this executable in subsequent simulations as long as the model remains structurally unchanged. “Code Regeneration in Accelerated Models” on page 33-9 discusses the things that cause your model to rebuild.
- 5 Rerun the compiled model at the command prompt:

```
tic,[t,x,y]=sim('myModel',10000);toc
```

- 6 The elapsed time displayed shows the run time for the accelerated model. For example:

```
Elapsed time is 12.419914 seconds.
```

The difference in elapsed times (5.369450 seconds in this example) shows the improvement obtained by accelerating your model.

## Related Examples

- “Design Your Model for Effective Acceleration” on page 33-18
- “Perform Acceleration” on page 33-25
- “Interact with the Acceleration Modes Programmatically” on page 33-29
- “Run Accelerator Mode with the Simulink Debugger” on page 33-33
- “How to Improve Performance in Acceleration Modes” on page 33-39

## More About

- “How Acceleration Modes Work” on page 33-4
- “Choosing a Simulation Mode” on page 33-12

## How to Improve Performance in Acceleration Modes

### In this section...

“Techniques” on page 33-39

“C Compilers” on page 33-39

### Techniques

To get the best performance when accelerating your models:

- Verify that the Configuration Parameters dialog box settings are as follows:

On this pane...	Set...	To...
All Parameters tab	<b>Solver data inconsistency</b>	none
All Parameters tab	<b>Array bounds exceeded</b>	none
All Parameters tab	<b>Signal storage reuse</b>	selected

- Disable Stateflow debugging and animation.
- When logging large amounts of data (for instance, when using the Workspace I/O, To Workspace, To File, or Scope blocks), use decimation or limit the output to display only the last part of the simulation.
- Customize the code generation process to improve simulation speed. For details, see “Customize the Build Process” on page 33-25.

### C Compilers

On computers running the Microsoft Windows operating system, the Accelerator and Rapid Accelerator modes use the default 64-bit C compiler supplied by MathWorks to compile your model. If you have a C compiler installed on your PC, you can configure the mex command to use it instead. You might choose to do this if your C compiler produces highly optimized code since this would further improve acceleration.

---

**Note:** For an up-to-date list of 32- and 64-bit C compilers that are compatible with MATLAB software for all supported computing platforms, see:

[http://www.mathworks.com/support/compilers/current\\_release/](http://www.mathworks.com/support/compilers/current_release/)

---

## **Related Examples**

- “Design Your Model for Effective Acceleration” on page 33-18
- “Interact with the Acceleration Modes Programmatically” on page 33-29
- “Run Accelerator Mode with the Simulink Debugger” on page 33-33

## **More About**

- “How Acceleration Modes Work” on page 33-4
- “Choosing a Simulation Mode” on page 33-12
- “Comparing Performance” on page 33-35



# Managing Blocks



# Working with Blocks

---

- “Nonvirtual and Virtual Blocks” on page 34-2
- “Specify Block Properties” on page 34-4
- “Adjust Visual Presentation to Improve Model Readability” on page 34-8
- “Display Port Values for Debugging” on page 34-16
- “Control and Display the Sorted Order” on page 34-27
- “Access Block Data During Simulation” on page 34-46

## Nonvirtual and Virtual Blocks

When creating models, you need to be aware that Simulink blocks fall into two basic categories: nonvirtual blocks and virtual blocks. Nonvirtual blocks play an active role in the simulation of a system. If you add or remove a nonvirtual block, you change the model's behavior. Virtual blocks, by contrast, play no active role in the simulation; they help organize a model graphically. Some Simulink blocks are virtual in some circumstances and nonvirtual in others. Such blocks are called conditionally virtual blocks. The table lists Simulink virtual and conditionally virtual blocks.

Block Name	Condition Under Which Block Is Virtual
Bus Assignment	Virtual if input bus is virtual.
Bus Creator	Virtual if output bus is virtual.
Bus Selector	Virtual if input bus is virtual.
Demux	Always virtual.
Enable	Virtual unless connected directly to an Output block.
From	Always virtual.
Goto	Always virtual.
Goto Tag Visibility	Always virtual.
Ground	Always virtual.
Inport	Virtual <i>unless</i> the block resides in a conditionally executed or atomic subsystem <i>and</i> has a direct connection to an Output block.
Mux	Always virtual.
Output	Virtual when the block resides within any subsystem block (conditional or not), and does <i>not</i> reside in the root (top-level) Simulink window.
Selector	Virtual only when <b>Number of input dimensions</b> specifies <b>1</b> and <b>Index Option</b> specifies <b>Select all</b> , <b>Index vector (dialog)</b> , or <b>Starting index (dialog)</b> .
Signal Specification	Always virtual.
Subsystem	Virtual unless the block is conditionally executed or the <b>Treat as atomic unit</b> check box is selected.

Block Name	Condition Under Which Block Is Virtual
	You can check if a block is virtual with the <code>IsSubsystemVirtual</code> block property. See “Block-Specific Parameters”.
Terminator	Always virtual.
Trigger	Virtual when the output port is <i>not</i> present.

## More About

- “Specify Block Properties” on page 34-4
- “Display Port Values for Debugging” on page 34-16
- “Control and Display the Sorted Order” on page 34-27
- “Access Block Data During Simulation” on page 34-46
- “Block Libraries”

## Specify Block Properties

For each block in a model, you can set general block properties, such as:

- A description of the block
- The block execution order
- A block annotation
- Block callback functions

To set block properties, use the Property Inspector. You can set properties in the **Properties** and **Info** tabs of the Property Inspector when the block is selected. Alternatively, you can use the Block Properties dialog box. For more information on setting properties, see “Setting Properties and Parameters” on page 1-51.

### Set Block Annotation Properties

In the Property Inspector, use the **Block Annotation** section to display the values of selected block parameters in an annotation. The annotation appears below the block icon.

Enter the text of the annotation in the text box. You can use a block property token in the annotation. The value for the property replaces the token in the annotation in the model. To display a list of tokens that you can use in an annotation, type % in the text box. The parameters that are valid for the selected block appear. See “Common Block Properties” and “Block-Specific Parameters”.

Suppose that you specify the following annotation text and tokens for a Product block:

```
Multiplication = %<Multiplication>
Sample time = %<SampleTime>
```

In the Simulink Editor, the block displays this annotation:



You can also create block annotations programmatically. See “Create Block Annotations Programmatically” on page 34-6.

## Specify Block Callbacks

Use the **Callbacks** tab to specify block callbacks. Callbacks are MATLAB commands that you specify that execute when a specific model action occurs, such as when you select or delete a block. For more information on callbacks, see “Callbacks for Customized Model Behavior” on page 4-46.

- 1 Select the block whose callback you want to set.
- 2 In **Properties** tab of the Property Inspector, in the **Callbacks** section, select the function that you want to assign the callback to. For example, select `OpenFcn` to specify a behavior for double-clicking a block.
- 3 In the text box, enter the command that you want to execute when that block function occurs.

After you assign a callback to a function, the function displays an asterisk next to it in the list. The asterisks helps you to see the functions that have callbacks assigned to them.

### Set a Block Callback Programmatically

This example shows how to use the `OpenFcn` callback to execute MATLAB scripts when you double-click a block. For example, in a MATLAB script you can define variables or open a plot of simulated data.

To create a callback programmatically, select the block to which you want to add this property. Then, at the MATLAB command prompt, enter a command in this form:

```
set_param(gcf, 'OpenFcn', 'myfunction')
```

In this example, `myfunction` represents a valid MATLAB command or a MATLAB script on your MATLAB search path.

## Specify Block Execution Priority and Tag

In the **Advanced Properties** section of the block properties, you can specify the block priority and identify the block by assigning a value to the **Tag** property.

- **Priority** — Specify the execution priority of the block relative to other blocks in the model. For more information, see “Assign Block Priorities” on page 34-41.
- **Tag** — Specify an identifier for the block. Specify text to assign to the block Tag parameter. Setting this property is useful for finding the block in the model by searching or programmatically using `find_system`. See “Find Model Elements in Simulink Models” on page 12-48.

## Use Block Description to Identify a Block

The **Info** tab displays information about the block type. The block author provides this description.

You can also enter a description in the **Description** box to provide information about the block instance.

- If you add a description, you can set up your model display so that the description appears in a tool tip when you hover over the block. Use **Display > Blocks > Tool Tip Options > Description** to enable this tool tip.
- The **Description** property can help you to find a block by searching. See “Find Model Elements in Simulink Models” on page 12-48.

## Create Block Annotations Programmatically

You can use a block `AttributesFormatString` parameter to display specified block parameter values below the block. “Common Block Properties” and “Block-Specific Parameters” describe the parameters that a block can have. Use the Simulink `set_param` function to set this parameter to the attributes format that you want.

The attributes format can be any text that has embedded parameter names. An embedded parameter name is a parameter name preceded by `%<` and followed by `>`, for example, `%<priority>`. Simulink displays the attributes format text below the block icon, replacing each parameter name with the corresponding value. You can use line-feed characters (`\n`) to display each parameter on a separate line. For example, select a Gain block and enter this command at the MATLAB command prompt:

```
set_param(gcf, 'AttributesFormatString', 'pri=%<priority>\ngain=%<Gain>')
```

The Gain block displays this block annotation:





If a parameter value is not text or an integer, N/S (for not supported) appears in place of the value. If the parameter name is not valid, Simulink displays ??? in place of the value.

## **More About**

- “Setting Properties and Parameters” on page 1-51
- “Callbacks for Customized Model Behavior” on page 4-46
- “Assign Block Priorities” on page 34-41

## Adjust Visual Presentation to Improve Model Readability

As you build a model, you can adjust block positions, change block and background color, adjust fonts, and add elements that help to improve model readability. These changes can help to organize the model visually and help others understand the model when you share it.

You can make these types of changes to improve model readability:

- Flip or rotate blocks. These adjustments help blocks to fit in the model and connect with other blocks. See “Flip or Rotate a Block” on page 34-8.
- Reposition or hide block names. See “Move and Hide Block Names” on page 34-10.
- Add colors to blocks and to the background. See “Specify Model Colors” on page 34-10.
- Adjust aesthetics by changing fonts and deepening the intensity of drop shadows. See “Specify Fonts in Models” on page 34-11 and “Increase Drop Shadow Depth” on page 34-12.
- Surround groups of blocks with a box to show that the blocks are related. See “Box and Label Areas of a Model” on page 34-12.
- Copy formatting from a block, line, or area to another model element. See “Copy Formatting Between Model Elements” on page 34-14.
- Document a model using text, image, and math annotations. See “Describe Models Using Annotations” on page 4-3.
- Annotate a block. See “Set Block Annotation Properties” on page 34-4.
- Change the block icon, for example, display a graphic on the block. Use a mask to achieve this effect. A mask also enables you to design a custom interface for a block. To learn about masks, see “Masking Fundamentals” on page 37-2.

### Flip or Rotate a Block

You can change the orientation of a block by rotating it in 90-degree increments or by flipping it 180 degrees about its horizontal or vertical axis. Rotate or flip a block so that it fits better in the model, for example, in feedback loops. You might also need to rotate a block so that inports align with outports.

The figure shows a Gain block flipped to simplify a feedback loop diagram.

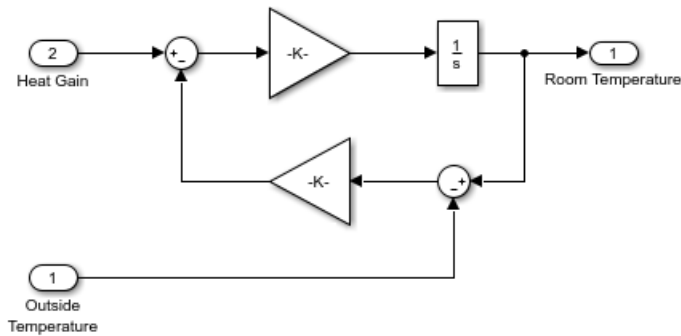

- To rotate or flip a block, select the block and select a command from the **Diagram > Rotate & Flip** menu. You can rotate clockwise (**Ctrl+R**) or counterclockwise.

The **Flip Block** command flips the block based on the orientation of its ports. For example, if the ports are on the sides, the block flips horizontally (about its vertical axis).

### Port Location After Rotating or Flipping

Rotating moves block ports from the sides to top and bottom or the reverse, depending on the placement of the ports. The resulting positions of the block ports depend on the block *port rotation type*.

Rotating can reposition the ports on some blocks to maintain left-to-right or top-to-bottom port numbering order. A block whose ports are reordered after a rotation have the *default port rotation* type. This policy helps to maintain the left-right and top-down block diagram orientation convention used in control system modeling applications. Blocks by default use this rotation policy. The figure shows the effect of clockwise rotation on a block with the default port rotation policy.

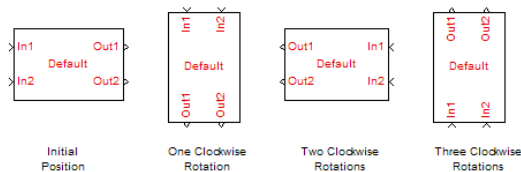

A masked block can specify for ports to keep their order after rotation (see “Port rotation”). These blocks have a *physical port rotation* type. This policy helps when

designing blocks to use in mechanical and hydraulic systems modeling and other applications where diagrams do not have a preferred orientation. The figure shows the effect of clockwise rotation on a block with a physical port rotation type.

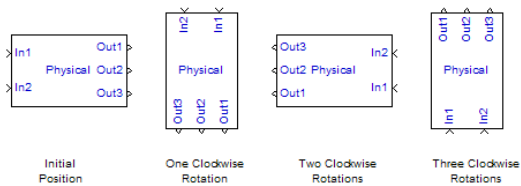

Flipping a block moves the ports to the opposite side of the block, creating a mirror image, regardless of port rotation type.

## Move and Hide Block Names

By default, block names appear below blocks whose ports are on the sides and to the left of blocks whose ports are on the top and bottom. You can change the location of a block name, and you can hide block names.

To change the location of a block name, you can:

- Drag the block name to the opposite side of the block.
- Select the block and then select **Diagram > Rotate & Flip > Flip Block Name**.

To toggle the display of the block name, select **Diagram > Format > Show Block Name**.

## Specify Model Colors

You can specify the outline and interior colors of any block, and you can change the background color for any system in a model. You can also change text color and background color for annotations and fill color for areas.

This subsystem uses color to identify the inports.

slidemo\_fuelsys ▶ fuel\_rate\_control ▶ fuel\_calc ▶ switchable\_compensation ▶

## Loop Compensation and Filtering

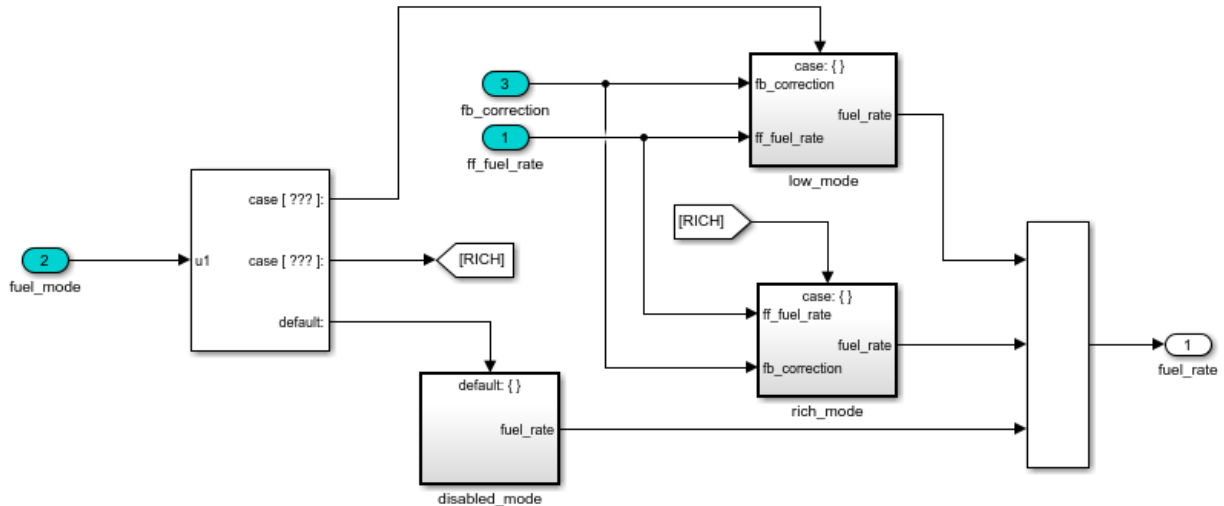

- To change outline color on a block, text color in an annotation, or interior color for an area, select the element, and then select **Diagram > Format > Foreground Color**. Changing the foreground color of a block also changes the color of its output signals.
- To change interior color on a block or background color in an annotation, select the element, and then select **Diagram > Format > Background Color**.
- To change a background color in a system, open the system, and then select **Diagram > Format > Canvas Color**.

You can select a color from the menu or select **Custom** to open the color picker and define your own color.

You can also use the Property Inspector to change color for an area or an annotation. To specify colors programmatically, see “Specify Colors Programmatically” on page 1-22

## Specify Fonts in Models

Change font family, style, and size for any model element to make your model easier to read or to comply with company standards. You can modify the font for selected blocks,

signal labels, areas, and annotations. Changing a block's font changes the font for the name and for text that appears on the block.

You can also change the default font for the model. The default font affects any elements whose font you have not changed and any new elements you create. If you want to use the same default font in all new models, change the default model font in your default template. See “Use Customized Settings When Creating New Models” on page 1-8.

- To change the font of a block, signal label, area, or annotation, select the element, and then select **Diagram > Format > Font Style for Selection**. Use the dialog box to specify the font information.
- To change the default font for the model, with no selection, select **Diagram > Format > Font Style for Model**. Use the dialog box to specify the font information.

You can also use the Property Inspector to change font for an area or an annotation.

## Increase Drop Shadow Depth

By default, blocks have a drop shadow. To make the block stand out more against the background, you can increase the depth of the drop shadow.

Select the blocks whose drop shadow depth you want to increase, and then select **Diagram > Format > Shadow**.

---

**Tip:** To remove the default drop shadow for all blocks, select the Simulink Editor preference **Use classic diagram theme**.

---

## Box and Label Areas of a Model

Add an area to your model to visually group related model elements in a box. An area can move with the blocks it surrounds. You can add text to an area to briefly describe or label the area.

- 1 Drag a box around the area of interest in the model.
- 2 From the action bar, select **Create Area**.

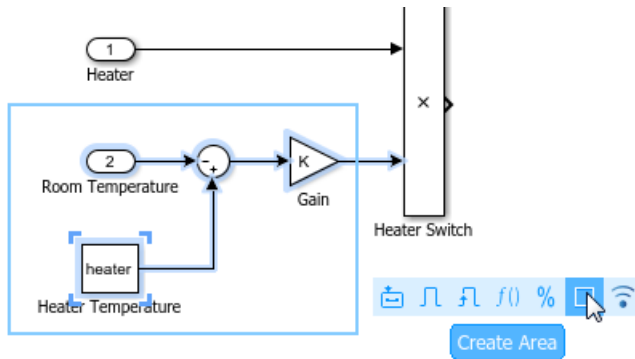

- 3 Type the name of the area. The name appears in the upper-left corner of the area.

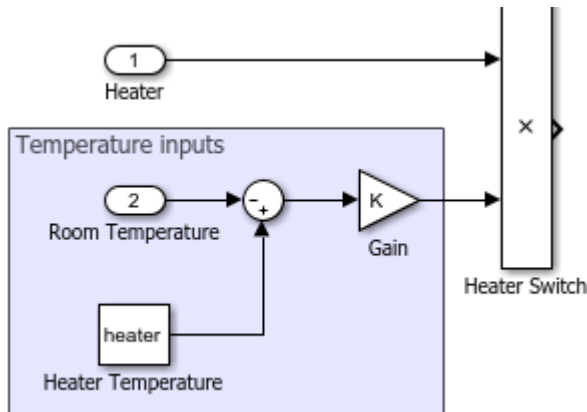

To enter the name later, select the area, click the **?**, and start typing, or use the **Name** property in the Property Inspector.

- 4 Optionally, add a description of the area contents using the Property Inspector.
- 5 To move the area and its contents, drag the area near the border.

---

**Tip:** To move an area without moving its contents, hold **Alt** (**option** on a Mac) and drag.

---

Alternatively, you can drag an area box from the palette onto the canvas, resize the box, and move it to the desired location.

## Convert Area to a Subsystem

An area is similar to a subsystem in that it is a way to group related blocks. However, a subsystem creates a hierarchy, replacing multiple blocks in a model with a single block. You can initially group related blocks in an area and later decide to put those blocks in a subsystem by converting the area. The resulting subsystem has the same name, blocks, description, and requirements traceability information as the area.

To convert an area to a subsystem, right-click the area and select **Create Subsystem from Area**.

## Copy Formatting Between Model Elements

If you have applied formatting to a block, signal line, or area in a model, you can copy the formatting and apply it to another model element. Examples of formatting include font changes, foreground and background color, and drop shadow effects.

- 1 Select the block, line, or area whose formatting you want to copy.
- 2 From the ellipsis menu, select **Copy Formatting**. The cursor becomes a paintbrush.

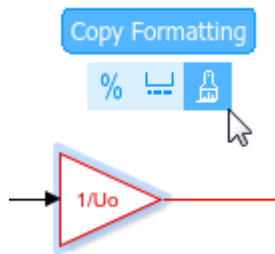

- 3 Using the paintbrush, click each element that you want to copy the formatting to.
- 4 To cancel the paintbrush cursor, click a blank spot on the canvas or press **Esc**.

## More About

- “Keyboard and Mouse Actions for Simulink Modeling” on page 1-90
- “Use Customized Settings When Creating New Models” on page 1-8
- “Set Block Annotation Properties” on page 34-4
- “Build and Edit a Model in the Simulink Editor” on page 1-24



- “Programmatic Modeling Basics” on page 1-14

## Display Port Values for Debugging

### In this section...

“Display Port Values for Easy Debugging” on page 34-16

“Display Value for a Specific Port” on page 34-20

“Display Port Values for a Model” on page 34-23

“Port Value Display Limitations” on page 34-24

### Display Port Values for Easy Debugging

For many blocks whose signals carry data, Simulink can display signal values (block output) as port value labels (similar to tool tips) on the block diagram during and after a simulation. Port value labels display block output values when Simulink runs block output methods. This model shows a port value label for the port on the Fcn block, an output value of  $-3.03$ .

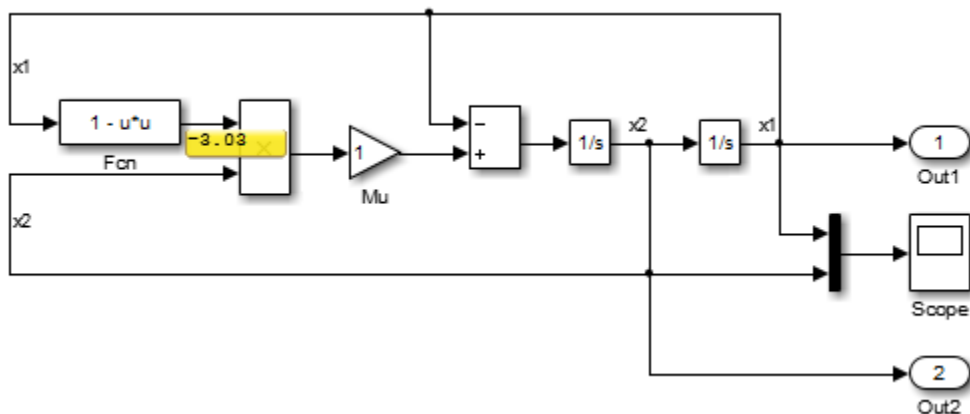

If the port value label appears empty, this means that no port value is currently available. For example, toggling a port value label on a continuous block when paused during simulation does not display any values in the label.

Port value labels are also empty when you have not yet simulated the model. This is because the block output methods do not run when the model does not simulate.

If you toggle or hover on a block that Simulink optimizes out of a simulation (such as a virtual subsystem block), while you simulate, the model displays the text `optimized`.

Displaying port value data tips can help during interactive debugging of a model. For example, the figure shows the output of a thermal model for a house.

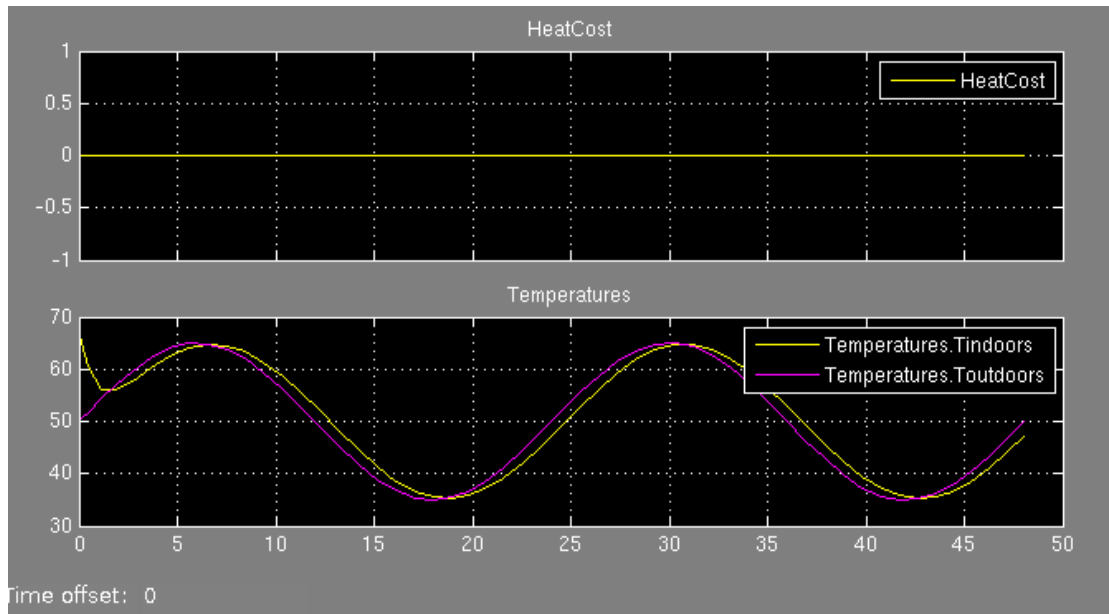

These results suggest a problem with the model because:

- The heating cost is 0 at all temperatures.
- The temperature inside the house matches ambient temperature almost exactly.

In such cases, debugging the blocks in the model interactively can help isolate the error. Port value labels provide information at the output of every block in the model. So in this example, if you step forward using Simulation Stepper, you can see that the output of the Heater subsystem is 0 at every time step.

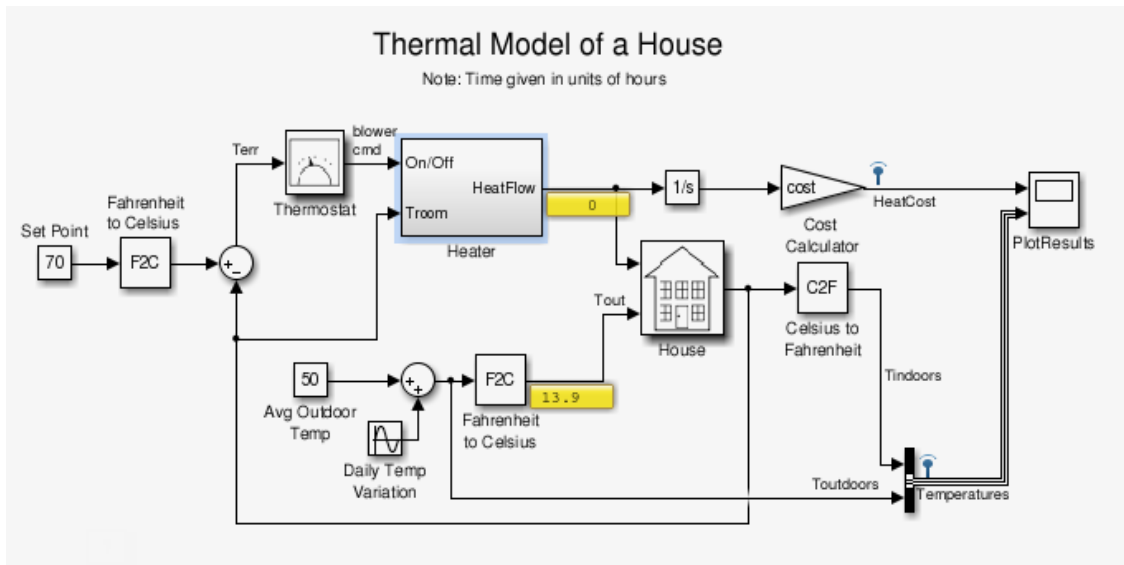

To learn more, you can enable port value labels for blocks inside the Heater subsystem. Using Simulation Stepper, if you step forward again to display the values, you can see that there is an issue with the HeatGain block. The output is constant at 0.

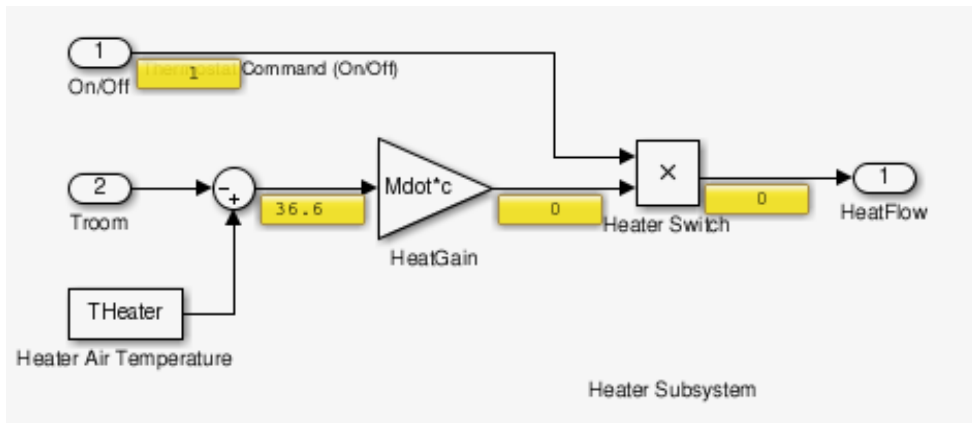

This technique helps you isolate the issue.

To simplify debugging, you can turn on and off port value labels during simulation. Besides providing useful information for debugging, port value displays can help you monitor a signal value during simulation. However, these labels are not saved with a model.

For nonnumeric data display, Simulink uses these values:

Message	Explanation
action	The signal executes action subsystems.
fcn-call	The signal is a function-call signal, e.g., Function Call Generator output.
ground	The signal is coming from a Ground block.
not a data signal	The signal does not contain valid data, e.g., the signal is from a block that is commented out.

In some cases:

- The port value display may not be able to acquire the value signal or
- The signal's value cannot be easily displayed

In such cases, Simulink uses these values.

Message	Explanation
...	The signal dimension exceeds the maximum number of elements Simulink can display. For more information, see "Display Port Values for a Model" on page 34-23.
(no message)	The simulation data available is insufficient. Step forward or press play to obtain more data.
click to add signals	You have enabled a port value label on a bus. However, you have not selected a signal to display. Click the label to select bus signals.
inaccessible	Simulink cannot obtain the port value. For an example, see "Signal Storage Reuse" on page 34-24.
[m*n]	This is a nonvector signal. Simulink cannot display the actual values of the matrix. It displays the matrix dimension instead.
no data yet	This message appears when:

Message	Explanation
	<ul style="list-style-type: none"> <li>The simulation data is not available. Start the simulation to see values.</li> <li>If the model contains subsystems (for example, an enabled subsystem) and model references and they are not executed during a simulation.</li> </ul>
not used	Simulink cannot obtain the signal value due to optimization.
removed	Simulink cannot obtain the signal value due to block reduction.
optimized	Simulink cannot obtain the signal value due to optimization. In Normal mode, this message appears for blocks with <b>Conditional input branch execution</b> enabled. For more information, see “Conditional Subsystems” on page 10-2.
unavailable	The simulation data available is insufficient. For example, see “Simulation Stepper” on page 34-25.

---

**Note:** You can force a value label to display the signal value by designating the signal as a test point. Use the **Properties** dialog box to do this.

---

## Display Value for a Specific Port

To display the value of a specific port or port values for a block before simulation, select one or more signals, right-click the selection, and select **Show Value Label of Selected Port**.

By default, Simulink displays the value of a signal when you click on it during simulation. You can control this behavior in **Display > Data Display in Simulation > Options > Display values > Enable by default during simulation**.

---

**Note:** To remove all data tips, select **Display > Data Display in Simulation > Remove All Value Labels**.

---

For bus signals, the **Show Value Label of Selected Port** option opens a dialog box where you can select from all signals in the bus. For example, in this model, you can see the dialog box for all signals that are contained in ModelBus.

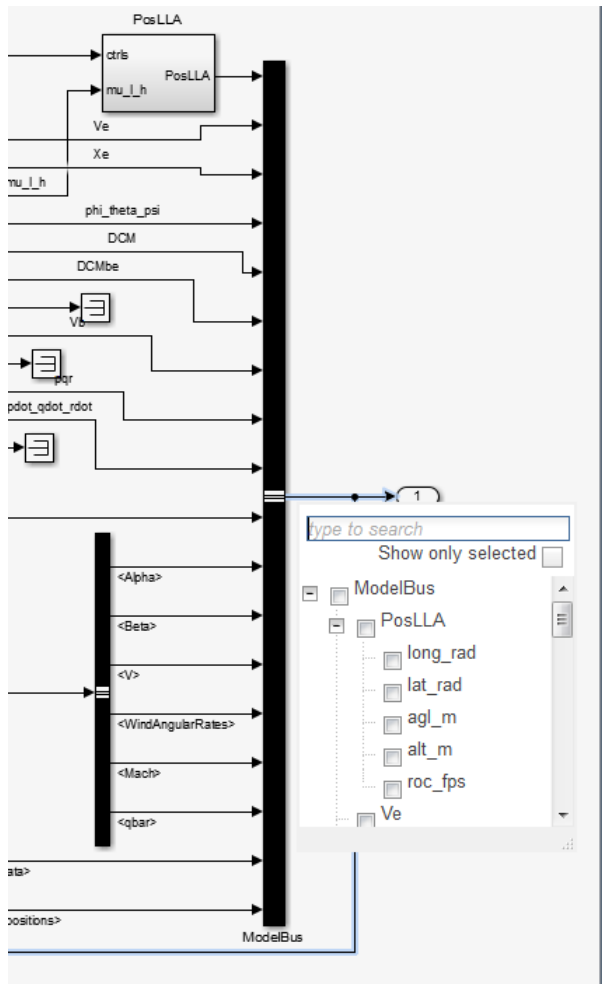

You can search for a signal by name or filter through the hierarchy. Select a parent signal to include all of the signals it contains. You can also filter the display to view only those signals you have selected.

Click anywhere outside the dialog box to close it. The port value label appears. The label has no data; it displays values when you simulate the model.

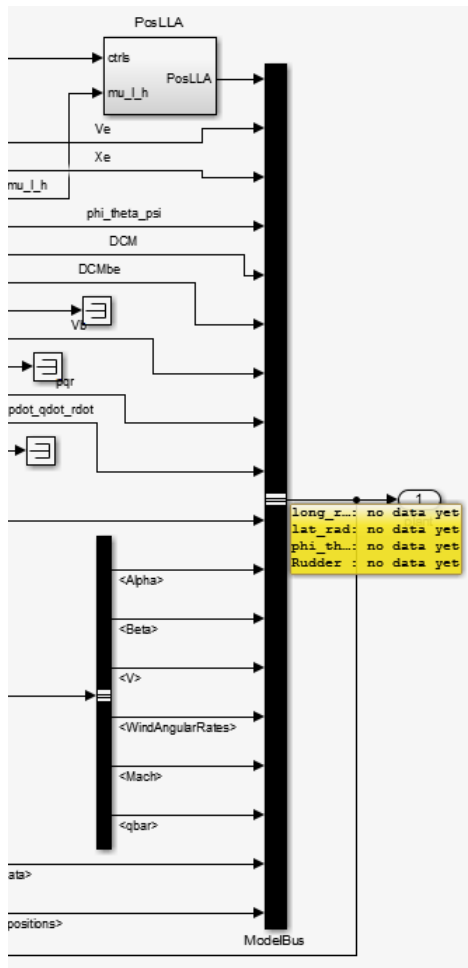

When you simulate the model, the port value label displays the names and values of the signals you chose. To change the signals to display, click on the port value label to reopen the dialog. You can also click on another signal to display its value.



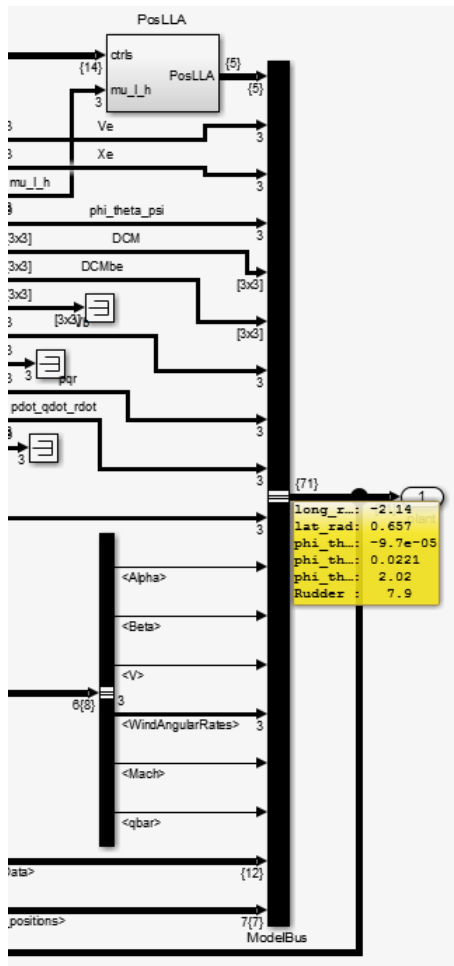

**Note:** Simulink does not save the values of a signal when you remove the port value label.

## Display Port Values for a Model

Specify port value display formatting and the frequency of updates. The Value Label Display Options dialog box controls these settings on the entire model.

- 1 In the model whose port values you want to display, select **Display > Data Display in Simulation > Options**.
- 2 In the Value Label Display Options dialog box, specify your preferences for:
  - The display options, including font size, the refresh frequency, and the number of elements displayed for vector signals with signal widths greater than 1
  - The display mode
  - Floating-point or fixed-point format

## Port Value Display Limitations

### Performance

Enabling the hovering option for a model or setting at least one block to **Toggle Value Labels When Clicked** slows down simulation.

### Accelerated Modes

Port values work in Normal and Accelerator modes only. They do not work in Rapid Accelerator and External modes. The table shows how accelerator modes affect the display of port values.

Accelerated Mode	Port Values
Accelerator	<ul style="list-style-type: none"> <li>• Signals not optimized in Accelerator mode display port values as in Normal mode. Signals optimized in Accelerator mode display port values as <b>optimized</b>. For more information, see “Display Port Values for Easy Debugging” on page 34-16.</li> <li>• Model reference blocks simulated in Accelerator mode do not get their port value displays updated.</li> </ul>
Rapid Accelerator	Incompatible. The limitation exists whether the model or its parent specifies accelerated simulation. For more information, see “Accelerate, Refine, and Test Hybrid Dynamic System on Host Computer by Using RSim System Target File” (Simulink Coder).

### Signal Storage Reuse

If the output port buffer of a block is shared with another block through the optimization of signal storage reuse, the port value displays as **inaccessible**. You can disable signal

storage reuse using the **Configuration Parameters > All Parameters > Signal storage reuse** check box. However, disabling signal storage reuse increases the memory used during simulation.

### Signal Data Types

- Simulink displays the port value for ports connected to most kinds of signals, including signals with built-in data types (such as `double`, `int32`, or `Boolean`), `DYNAMICALLY_TYPED`, and several other data types.
- Simulink shows the floating format for only noncomplex signal value displays.
- Simulink displays the port value of fixed point data types based on the converted double value.
- Simulink does not display data for signals with some composite data types, such as bus signals.

### Subsystems

- You cannot display port values for subsystems contained in a variant subsystem when there are no signal lines connecting to them. In such cases, during simulation, Simulink automatically determines block connectivity based on the active variant. However, you can display port values within the subsystems contained in the variant subsystem. You can also display values on signal lines outside of the variant subsystem.
- When you disable a conditionally executed subsystem, the port value display for a signal that goes into an Output block displays the value of the Output block, depending on the **Output when disabled** setting.
- Simulink does not display data for the ports of an enabled subsystem that is not enabled.

### Simulation Stepper

If you do not enable port value display when stepping forward, the display will not be available when stepping back. When stepping back, if the port value is unavailable, the `unavailable` label is displayed.

### Refine Factor

Port value displays do not honor refine factor values (**Configuration Parameters > Data Import/Export > Additional parameters > Refine factor**) because Simulink updates port value displays only during major time steps.

### **Signal Specification Block and Inport Block**

When you display port values on Signal Specification and Inport blocks in a subsystem, the value that is driving the blocks displays instead of the block values.

### **Command-Line Simulations**

For efficiency, Simulink does not support port value displays during a command-line simulation using the `sim` command.

### **Merge Block**

Simulink does not display the output value of a merge block. To see this value, refer to the source block.

### **Command Line Interface**

You cannot specify port value displays through the command line interface.

### **Non-Simulink signals**

You cannot place port values on non-Simulink signals, such as Simscape or SimEvents signals. This limitation applies to conditional breakpoints as well.

### **More About**

- “Nonvirtual and Virtual Blocks” on page 34-2
- “Specify Block Properties” on page 34-4
- “Adjust Visual Presentation to Improve Model Readability” on page 34-8
- “Control and Display the Sorted Order” on page 34-27
- “Access Block Data During Simulation” on page 34-46
- “Block Libraries”

## Control and Display the Sorted Order

### In this section...

- “What Is Sorted Order?” on page 34-27
- “Display the Sorted Order” on page 34-27
- “Sorted Order Notation” on page 34-28
- “How Simulink Determines the Sorted Order” on page 34-38
- “Assign Block Priorities” on page 34-41
- “Rules for Block Priorities” on page 34-41
- “Block Priority Violations” on page 34-44

### What Is Sorted Order?

During the updating phase of simulation, Simulink determines the order in which to invoke the block methods during simulation. This block invocation ordering is the *sorted order*.

You cannot set this order, but you can assign priorities to nonvirtual blocks to indicate to Simulink their execution order relative to other blocks. Simulink tries to honor block priority settings, unless there is a conflict with data dependencies. To confirm the results of priorities that you have set, or to debug your model, display and review the sorted order of your nonvirtual blocks and subsystems.

---

**Note:** For more information about block methods and execution, see:

- “Block Methods” on page 3-15
  - “Conditional Subsystems” on page 10-2
- 

### Display the Sorted Order

To display the sorted order of the vdp model:

- 1 Open the van der Pol equation model:  
vdp
- 2 In the model window, select **Display > Blocks > Sorted Execution Order**.

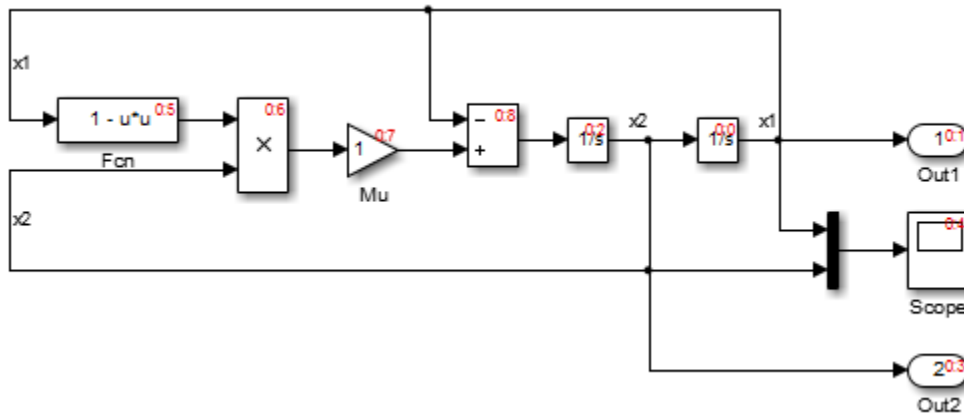

Simulink displays a notation in the top-right corner of each nonvirtual block and each nonvirtual subsystem. These numbers indicate the order in which the blocks execute. The first block to execute has a sorted order of 0.

For example, in the van der Pol equation model, the Integrator block with the sorted order 0:0 executes first. The Out1 block, with the sorted order 0:1, executes second. Similarly, the remaining blocks execute in numeric order from 0:2 to 0:8.

You can save the sorted order setting with your model. To display the sorted order when you reopen the model, select **Simulation > Update diagram**.

## Sorted Order Notation

The sorted order notation varies depending on the type of block. The following table summarizes the different formats of sorted order notation. Each format is described in detail in the sections that follows the table.

Block Type	Sorted Order Notation	Description
“Nonvirtual Blocks” on page 34-31	$s : b$ $s : b \{x, y\}$	<ul style="list-style-type: none"> <li><math>s</math> is the system index of the model or subsystem the block resides in. For root-level models, <math>s</math> is always 0.</li> <li><math>b</math> specifies the block position within the sorted order for the designated execution context.</li> </ul>

Block Type	Sorted Order Notation	Description
		<ul style="list-style-type: none"> <li><math>x,y</math> are the system indices of the subsystems whose execution is controlled by this block.</li> </ul>
“Nonvirtual Subsystems” on page 34-32 (not including function-call and action subsystems)	$s:b$	<ul style="list-style-type: none"> <li><math>s</math> is the system index of the model or subsystem.</li> <li><math>b</math> specifies the block position within the sorted order for the designated execution context.</li> </ul>
“Virtual Blocks and Subsystems” on page 34-34	Not applicable	Virtual blocks do not execute.
Action Subsystems	$s:b'$	<ul style="list-style-type: none"> <li><math>s</math> is the system index of the model or subsystem the block resides in. For root-level models, <math>s</math> is always 0.</li> <li><math>b'</math> is the block index of the action block (but not of the action subsystem).</li> </ul>
“Function-Call Subsystems” on page 34-35 and Function-Call models	One non-grounded initiator: $s:b^i$	<ul style="list-style-type: none"> <li><math>s</math> is the system index of the model or subsystem the block resides in. For root-level models, <math>s</math> is always 0.</li> <li><math>b^i</math> is the block index of the root initiator in the subsystem’s hierarchy.</li> </ul>
	Two or more initiators: <ul style="list-style-type: none"> <li><math>s:b^{i1}, s:b^{i2}, \dots, s:b^{in}</math> where <math>n</math> is the number of non-grounded initiators.</li> </ul>	<ul style="list-style-type: none"> <li><math>s</math> is the system index of the model or subsystem the block resides in. For root-level models, <math>s</math> is always 0.</li> <li><math>b^{in}</math> is the block index of the <math>n</math>-th root initiator in the subsystem’s hierarchy.</li> </ul>
	Initiators are either Ground blocks or are unconnected: <ul style="list-style-type: none"> <li><math>s:G</math></li> </ul>	<ul style="list-style-type: none"> <li><math>s</math> is the system index of the model or subsystem the block resides in. For root-level models, <math>s</math> is always 0.</li> <li><math>G</math> indicates that all function-call initiators are grounded.</li> </ul>

Block Type	Sorted Order Notation	Description
“Branched Function-Call Signals” on page 34-37	$s : b^i [B_k]$	<ul style="list-style-type: none"> <li>• <math>s</math> is the system index of the model or subsystem the block resides in. For root-level models, <math>s</math> is always 0.</li> <li>• <math>b^i</math> is the block index of the root initiator in the subsystem’s hierarchy.</li> <li>• <math>B_k</math> indicates that it is a branched function-call subsystem with branch index <math>k</math>.</li> </ul>
Function-Call Feedback Latch Blocks	$s : b^i [B_m]$	<ul style="list-style-type: none"> <li>• <math>s</math> is the system index of the model or subsystem the block resides in. For root-level models, <math>s</math> is always 0.</li> <li>• <math>b^i</math> is the block index of the root initiator in the subsystem’s hierarchy.</li> <li>• <math>B_m</math> indicates that it is a branched subsystem with branch index <math>m</math>.</li> </ul>
Blocks in a model with asynchronous function-call inputs	Function-call root-level Inport and Outport blocks: $F_i$	<ul style="list-style-type: none"> <li>• <math>F</math> indicates that it is executed in a function-call context.</li> <li>• <math>i</math> is the function-call index.</li> </ul>
	Root-level data Inport blocks: If they drive a function-call subsystem, it is the function-call index of the subsystem.  If they are part of the model that is not driven by asynchronous function-call inputs, then no function-call index is displayed.	
	Root-level function-call blocks: $F_i$ Root-level branched function-call blocks: $F_i [B_k]$	<ul style="list-style-type: none"> <li>• <math>F</math> indicates that it is executed in a function-call context.</li> <li>• <math>i</math> is the function-call index.</li> </ul>



Block Type	Sorted Order Notation	Description
Blocks inside Export Function Models (See “Execution Order for Function-Call Root-Level Inport Blocks” on page 10-59)	Function-call root-level Inport and Outport blocks: $F_i$	<ul style="list-style-type: none"> <li>• <math>F</math> indicates that it is a function-call block.</li> <li>• <math>i</math> is the execution order for the function-call root-level Inport or Outport block in normal simulation mode.</li> </ul>
	Root-level function-call subsystems: $F_i$ Root-level branched function-call subsystems: $F_i[B_k]$	<ul style="list-style-type: none"> <li>• <math>F</math> indicates that it is a function-call block.</li> <li>• <math>i</math> is the execution order for the function-call root-level Inport block in normal simulation mode.</li> <li>• <math>B_k</math> indicates a branched function-call subsystem with index <math>k</math>.</li> </ul>
	Merge and Data Store Memory blocks: $F_i, F_j, \dots$	<ul style="list-style-type: none"> <li>• <math>F</math> indicates that it is a function-call block.</li> <li>• <math>i</math> is the block execution index.</li> </ul>
	Root-level data Inport and Outport blocks: Same execution order as the function-call subsystems they are connected to.	
“Bus-Capable Blocks” on page 34-38	$S : B$	<ul style="list-style-type: none"> <li>• <math>S</math> is the system index of the model or subsystem the block resides in. For root-level models, <math>S</math> is always 0.</li> <li>• <math>B</math> indicates a bus-capable block.</li> </ul>

- “Nonvirtual Blocks” on page 34-31
- “Nonvirtual Subsystems” on page 34-32
- “Virtual Blocks and Subsystems” on page 34-34
- “Function-Call Subsystems” on page 34-35
- “Branched Function-Call Signals” on page 34-37
- “Bus-Capable Blocks” on page 34-38

### Nonvirtual Blocks

In the van der Pol equation model, all the nonvirtual blocks in the model have a sorted order. The system index for the top-level model is 0, and the block execution order ranges from 0 to 8.

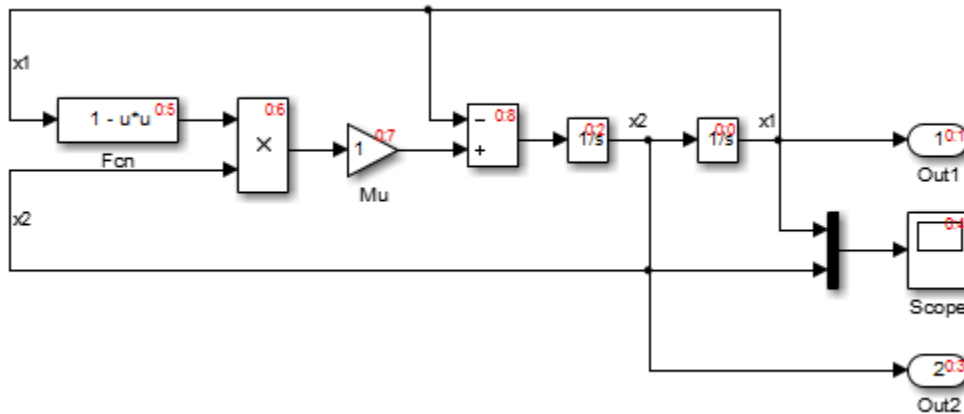

### Nonvirtual Subsystems

The following model contains an atomic, nonvirtual subsystem named Discrete Cruise Controller.

When you enable the sorted order display for the root-level system, Simulink displays the sorted order of the blocks.

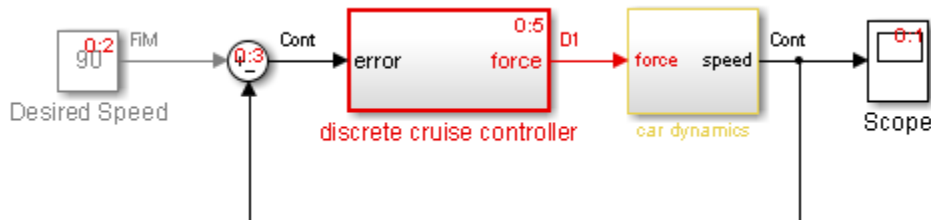

The Scope block in this model has the lowest sorted order, but its input depends on the output of the Car Dynamics subsystem. The Car Dynamics subsystem is virtual, so it does not have a sorted order and does not execute as an atomic unit. However, the blocks within the subsystem execute at the root level, so the Integrator block in the Car Dynamics subsystem executes first. The Integrator block sends its output to the Scope block in the root-level model, which executes second.

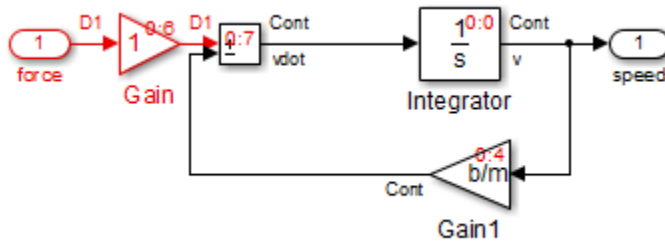

The Discrete Cruise Controller subsystem has a sorted order of 0:5:

- 0 indicates that this atomic subsystem is part of the root level of the hierarchical system comprised of the primary system and the two subsystems.
- 5 indicates that the atomic subsystem is the sixth block that Simulink executes relative to the blocks within the root level.

The sorted order of each block inside the Discrete Cruise Controller subsystem has the form 1:b, where:

- 1 is the system index for that subsystem.
- *b* is the block position in the execution order. In the Discrete Cruise Controller subsystem, the sorted order ranges from 0 to 8.

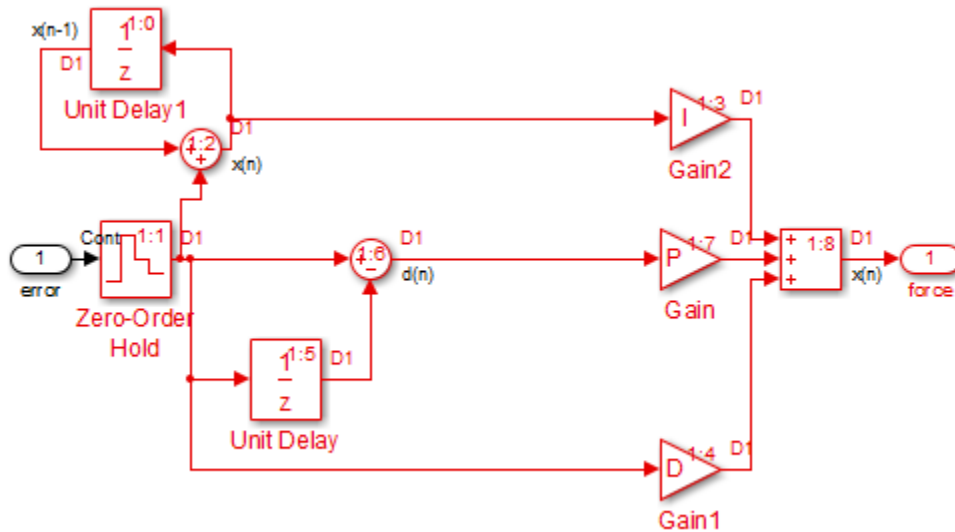

---

**Note:** Depending on your model configuration, Simulink can insert hidden, nonvirtual subsystems in your model. As a result, the visible blocks inside the hidden subsystem block can have a system index that is different from the current system index. For example, if you select **Model Configuration Parameters > All Parameters > Conditional input branch execution**, Simulink creates hidden, nonvirtual subsystems, which can affect the sorted execution order.

---

### Virtual Blocks and Subsystems

Virtual blocks, such as the Mux block, exist only graphically and do not execute. Consequently, they are not part of the sorted order and do not display any sorted order notation.

Virtual subsystems do not execute as a unit, and like a virtual block, are not part of the sorted order. The blocks inside the virtual subsystem are part of the root-level system sorted order, and therefore share the system index.

In the model in “Nonvirtual Subsystems” on page 34-32, the virtual subsystem Car Dynamics does not have a sorted order. However, the blocks inside the subsystem have a sorted order in the execution context of the root-level model. The blocks have the same

system index as the root-level model. The Integrator block inside the Car Dynamics subsystem has a sorted order of 0:0, indicating that the Integrator block is the first block executed in the context of the top-level model.

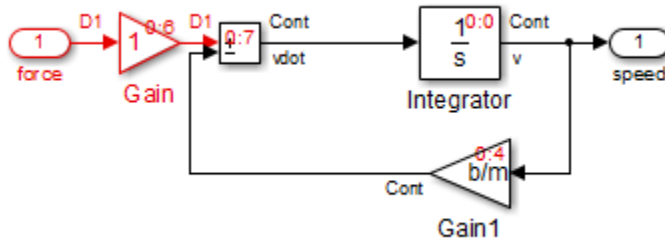

## Function-Call Subsystems

### Single Initiator

A function-call subsystem (or model) executes when the initiator invokes the function-call subsystem (or model) and, therefore, does not have a sorted order independent of its initiator. Specifically, for a subsystem that connects to one initiator, Simulink uses the notation  $s : b^i$ , where  $s$  is the index of the system that contains the initiator and  $b^i$  is the block index of the root initiator in the subsystems hierarchy.

For example, the sorted order for the subsystems  $f$  and  $g$  is 0:0, since the sorted order of their root initiator,  $Chart$ , is 0:0.

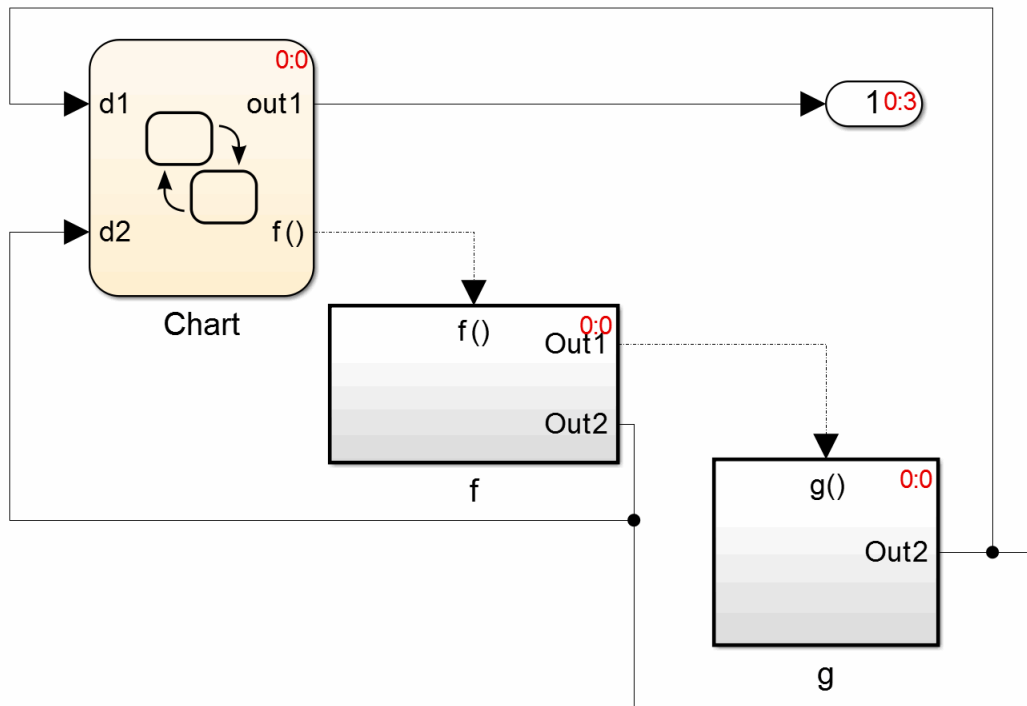

### Multiple Initiators

For a function-call subsystem that connects to more than one initiator, the sorted order notation is  $s:b^{i^1}, s:b^{i^2}, \dots, s:b^{i^n}$  where  $n$  is the number of non-grounded initiators,  $s$  is the system index of the model or subsystem the block resides in, and  $b^{i^n}$  is the block index of the  $n$ -th root initiator in the subsystem's hierarchy.

For example, open the `s1_subsys_fcncall16` model. The `f` subsystem has three initiators from the same level in the subsystem's hierarchy. Two are from the Stateflow chart, `Chart1`, and one from the Stateflow chart, `Chart`.

Because `Chart1` has a sorted order `0:2` and `Chart` has a sorted order of `0:4`, the function-call subsystem `f` has a sorted order notation of `0:2,0:4`.

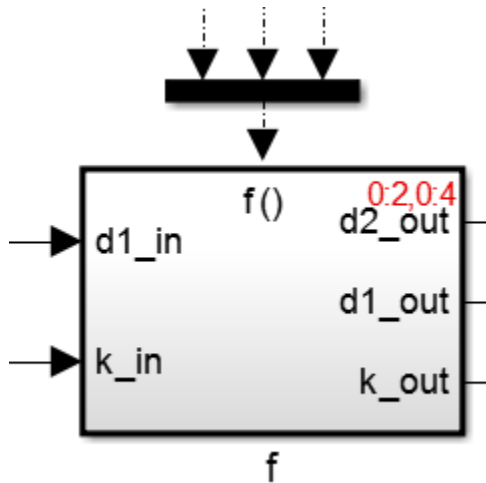

### Branched Function-Call Signals

When a function-call signal is branched using a Function-Call Split block, Simulink displays the order in which subsystems (or models) that connect to the branches execute when the initiator invokes the function call. Simulink uses the notation  $s:b^i[B_k]$  to indicate this order.  $s$  is the system index of the model or subsystem the block resides in,  $b^i$  is the block index of the root initiator in the subsystem's hierarchy, and  $B_k$  indicates that it is a branched function-call subsystem with branch index  $k$ .

For example, open the `s1_subsys_fcncall111` model and display the sorted order. The sorted order indicates that the subsystem  $f$  (B0) executes before the subsystem  $g$  (B1).

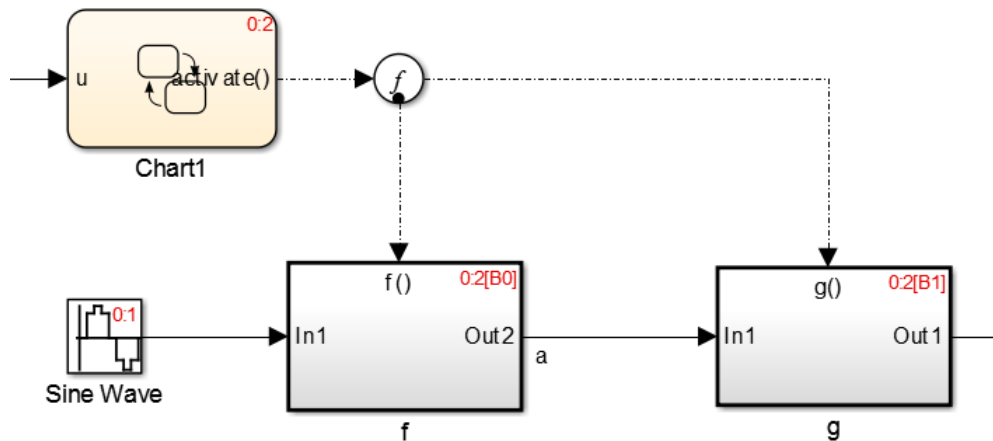

### Bus-Capable Blocks

A bus-capable block does not execute as a unit and therefore does not have a unique sorted order. Such a block displays its sorted order as  $s : B$  where  $B$  stands for bus.

For example, open the `sldemo_bus_arrays` model and display the sorted order. Open the For Each Subsystem to see that the sorted order for the Bus Assignment block appears as  $1 : B$ .

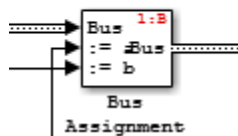

For more information, see “Bus-Capable Blocks” on page 63-43.

## How Simulink Determines the Sorted Order

### Direct-Feedthrough Ports Impact on Sorted Order

To ensure that the sorted order reflects data dependencies among blocks, Simulink categorizes block input ports according to the dependency of the block outputs on the



block input ports. An input port whose current value determines the current value of one of the block outputs is a *direct-feedthrough* port. Examples of blocks that have direct-feedthrough ports include:

- Gain
- Product
- Sum

Examples of blocks that have non-direct-feedthrough inputs:

- Integrator — Output is a function of its state.
- Constant — Does not have an input.
- Memory — Output depends on its input from the previous time step.

### Rules for Sorting Blocks

To sort blocks, Simulink uses the following rules:

- If a block drives the direct-feedthrough port of another block, the block must appear in the sorted order ahead of the block that it drives.

This rule ensures that the direct-feedthrough inputs to blocks are valid when Simulink invokes block methods that require current inputs.

- Blocks that do not have direct-feedthrough inputs can appear anywhere in the sorted order as long as they precede any direct-feedthrough blocks that they drive.

Placing all blocks that do not have direct-feedthrough ports at the beginning of the sorted order satisfies this rule. This arrangement allows Simulink to ignore these blocks during the sorting process.

Applying these rules results in the sorted order. Blocks without direct-feedthrough ports appear at the beginning of the list in no particular order. These blocks are followed by blocks with direct-feedthrough ports arranged such that they can supply valid inputs to the blocks which they drive.

The following model, from “Nonvirtual Subsystems” on page 34-32, illustrates this result. The following blocks do not have direct-feedthrough and therefore appear at the beginning of the sorted order of the root-level system:

- Integrator block in the Car Dynamics virtual subsystem

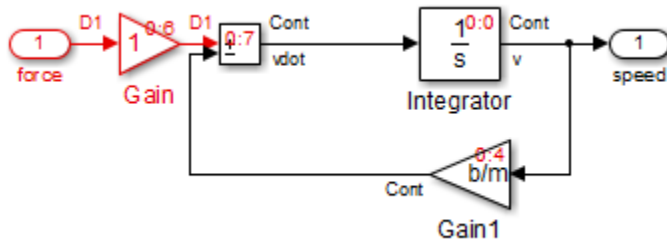

- Speed block in the root-level model

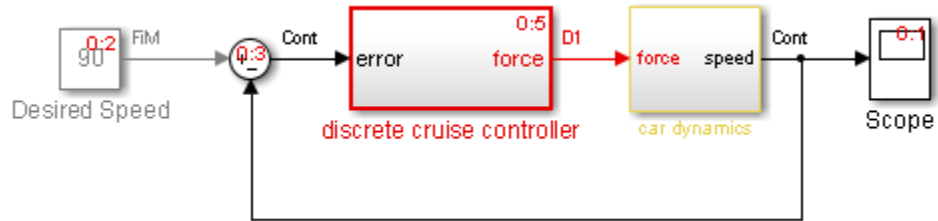

Inside the Discrete Cruise Controller subsystem, all the Gain blocks, which have direct-feedthrough ports, run before the Sum block that they drive.

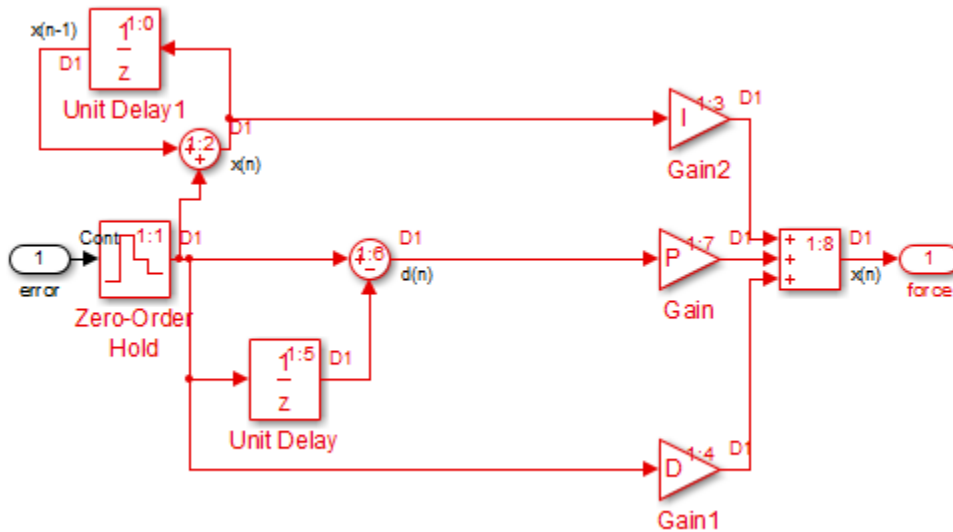

## Assign Block Priorities

You can assign a priority to a nonvirtual block or to an entire subsystem. Higher priority blocks appear before lower priority blocks in the sorted order. The lower the number, the higher the priority. Set the block priority in the block properties in the **Advanced** section.

## Rules for Block Priorities

Simulink honors the block priorities that you specify unless they violate data dependencies. (“Block Priority Violations” on page 34-44 describes situations that cause block property violations.)

In assessing priority assignments, Simulink attempts to create a sorted order such that the priorities for the individual blocks within the root-level system or within a nonvirtual subsystem are honored relative to one another.

Three rules pertain to priorities:

- “Priorities Are Relative” on page 34-42

- “Priorities Are Hierarchical” on page 34-43
- “Lack of Priority May Not Result in Low Priority” on page 34-44

**Priorities Are Relative**

Priorities are relative; the priority of a block is relative to the priority of the blocks within the same system or subsystem.

For example, suppose you set the following priorities in the Discrete Cruise Controller subsystem in the model in “Nonvirtual Subsystems” on page 34-32.

Block	Priority
Gain	3
Gain1	2
Gain2	1

After updating the diagram, the sorted order for the Gain blocks is as follows.

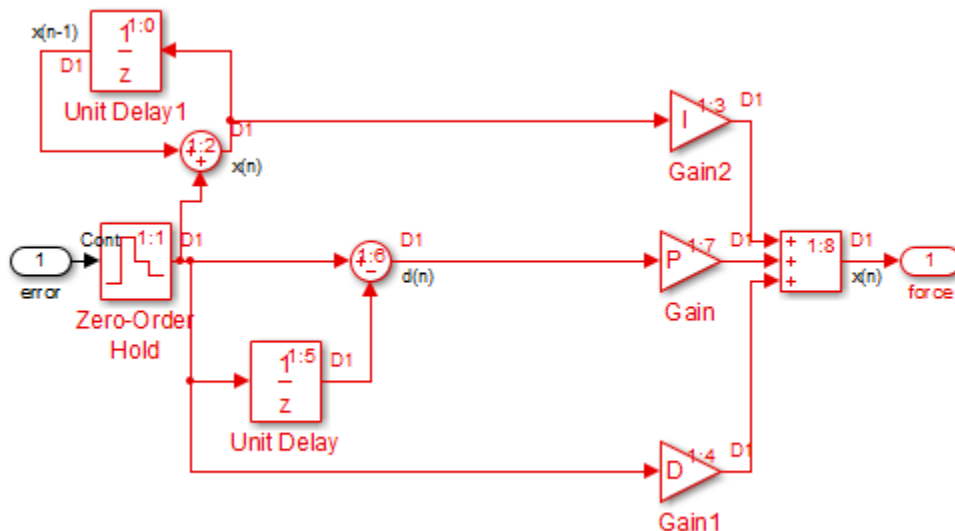

The sorted order values of the Gain, Gain1, and Gain2 blocks reflect the respective priorities assigned: Gain2 has highest priority and executes before Gain1 and Gain;

Gain1 has second priority and executes after Gain2; and Gain executes after Gain1. Simulink takes into account the assigned priorities relative to the other blocks in that subsystem.

The Gain blocks are not the first, second, and third blocks to execute. Nor do they have consecutive sorted orders. The sorted order values do not necessarily correspond to the priority values. Simulink arranges the blocks so that their priorities are honored relative to each other.

### Priorities Are Hierarchical

In the Car Dynamics virtual subsystem, suppose you set the priorities of the Gain blocks as follows.

Block	Priority
Gain	2
Gain1	1

After updating the diagram, the sorted order for the Gain blocks is as illustrated. With these priorities, Gain1 always executes before Gain.

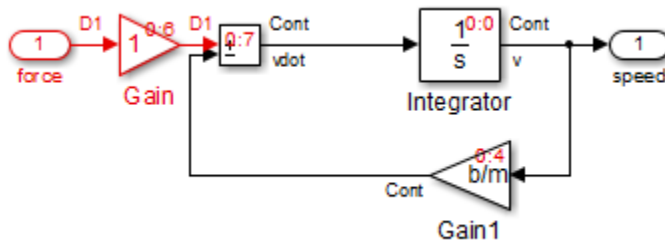

You can set a priority of 1 to one block in each of the two subsystems because of the hierarchical nature of the subsystems within a model. Simulink never compares the priorities of the blocks in one subsystem to the priorities of blocks in any other subsystem.

For example, consider this model again.

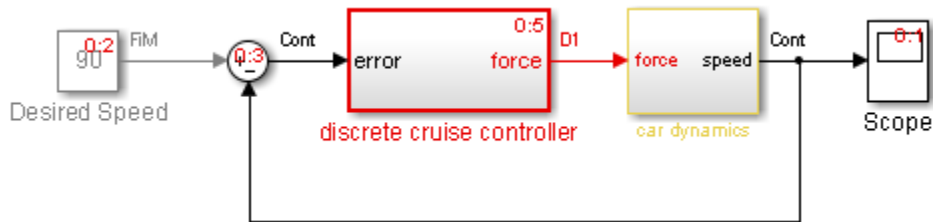

The blocks within the Car Dynamics virtual subsystem are part of the root-level system hierarchy and are part of the root-level sorted order. The Discrete Cruise Controller subsystem has an independent sorted order with the blocks arranged consecutively from 1:0 to 1:7.

### Lack of Priority May Not Result in Low Priority

A lack of priority does not necessarily result in a low priority (higher sorting order) for a given block. Blocks that do not have direct-feedthrough ports execute before blocks that have direct-feedthrough ports, regardless of their priority.

If a model has two atomic subsystems, A and B, you can assign priorities of 1 and 2 respectively to A and B. This priority causes all the blocks in A to execute before any of the blocks in B. The blocks within an atomic subsystem execute as a single unit, so the subsystem has its own system index and its own sorted order.

## Block Priority Violations

Simulink software honors the block priorities that you specify unless they violate data dependencies. If Simulink is unable to honor a block priority, it displays a **Block Priority Violation** diagnostic message.

As an example:

- 1 Open the `sldemo_bounce` model.

Notice that the output of the Memory block provides the input to the Coefficient of Restitution Gain block.

- 2 Set the priority of the Coefficient of Restitution block to 1, and set the priority of the Memory block to 2.

Setting these priorities specifies that the Coefficient of Restitution block execute before the Memory block. However, the Coefficient of Restitution block depends on the output of the Memory block, so the priorities you just set violate the data dependencies.

- 3 In the model window, enable sorted order by selecting **Format > Block displays > Sorted Order**.
- 4 Select **Simulation > Update Diagram**.

The block priority violation warning appears in the **Diagnostic Viewer**. To open the **Diagnostic Viewer** window, click **View > Diagnostic Viewer**. The warning includes the priority for the respective blocks:

```
Warning: Unable to honor user-specified priorities.  
'sldemo_bounce/Memory' (pri=[2]) has to execute  
before 'sldemo_bounce/Coefficient of Restitution'  
(pri=[1]) to satisfy data dependencies
```

- 5 Remove the priorities from the Coefficient of Restitution and Memory blocks and update the diagram again to see the correct sorted order.

## More About

- “Nonvirtual and Virtual Blocks” on page 34-2
- “Specify Block Properties” on page 34-4
- “Adjust Visual Presentation to Improve Model Readability” on page 34-8
- “Display Port Values for Debugging” on page 34-16
- “Access Block Data During Simulation” on page 34-46

## Access Block Data During Simulation

### In this section...

“About Block Run-Time Objects” on page 34-46

“Access a Run-Time Object” on page 34-46

“Listen for Method Execution Events” on page 34-47

“Synchronizing Run-Time Objects and Simulink Execution” on page 34-48

### About Block Run-Time Objects

Simulink provides an application programming interface, called the block run-time interface, that enables programmatic access to block data, such as block inputs and outputs, parameters, states, and work vectors, while a simulation is running. You can use this interface to access block run-time data from the MATLAB command line, the Simulink Debugger, and from Level-2 MATLAB S-functions (see “Write Level-2 MATLAB S-Functions” in the online Simulink documentation).

---

**Note** You can use this interface even when the model is paused or is running or paused in the debugger.

---

The block run-time interface consists of a set of Simulink data object classes (see “Data Objects” on page 57-59) whose instances provide data about the blocks in a running model. In particular, the interface associates an instance of `Simulink.RunTimeBlock`, called the block's run-time object, with each nonvirtual block in the running model. A run-time object's methods and properties provide access to run-time data about the block's I/O ports, parameters, sample times, and states.

### Access a Run-Time Object

Every nonvirtual block in a running model has a `RuntimeObject` parameter whose value, while the simulation is running, is a handle for the blocks' run-time object. This allows you to use `get_param` to obtain a block's run-time object. For example, the following statement

```
rto = get_param(gcb, 'RuntimeObject');
```



returns the run-time object of the currently selected block. Run-time object data is read-only. You cannot use run-time objects to change a block's parameters, input, output, and state data.

---

**Note** Virtual blocks (see “Nonvirtual and Virtual Blocks” on page 34-2) do not have run-time objects. Blocks eliminated during model compilation as an optimization also do not have run-time objects (see “Block reduction”). A run-time object exists only while the model containing the block is running or paused. If the model is stopped, `get_param` returns an empty handle. When you stop a model, all existing handles for run-time objects become empty.

---

## Listen for Method Execution Events

One application for the block run-time API is to collect diagnostic data at key points during simulation, such as the value of block states before or after blocks compute their outputs or derivatives. The block run-time API provides an event-listener mechanism that facilitates such applications. For more information, see the documentation for the `add_exec_event_listener` command. For an example of using method execution events, enter

```
sldemo_msfcn_lms
```

at the MATLAB command line. This Simulink model contains the S-function `adapt_lms.m`, which performs a system identification to determine the coefficients of an FIR filter. The S-function's `PostPropagationSetup` method initializes the block run-time object's `DWork` vector such that the second vector stores the filter coefficients calculated at each time step.

In the Simulink model, double-clicking on the annotation below the S-function block executes its `OpenFcn`. This function first opens a figure for plotting the FIR filter coefficients. It then executes the function `add_adapt_coef_plot.m` to add a `PostOutputs` method execution event to the S-function's block run-time object using the following lines of code.

```
% Add a callback for PostOutputs event
blk = 'sldemo_msfcn_lms/LMS Adaptive';

h    = add_exec_event_listener(blk, ...
    'PostOutputs', @plot_adapt_coefs);
```

The function `plot_adapt_coefs.m` is registered as an event listener that is executed after every call to the S-function's `Outputs` method. The function accesses the block run-time object's `DWork` vector and plots the filter coefficients calculated in the `Outputs` method. The calling syntax used in `plot_adapt_coefs.m` follows the standard needed for any listener. The first input argument is the S-function's block run-time object, and the second argument is a structure of event data, as shown below.

```
function plot_adapt_coefs(block, ei) %#ok<INUSD>
%
% Callback function for plotting the current adaptive filtering
% coefficients.

stemPlot = get_param(block.BlockHandle, 'UserData');

est = block.Dwork(2).Data;
set(stemPlot(2), 'YData', est);
drawnow('expose');
```

## Synchronizing Run-Time Objects and Simulink Execution

You can use run-time objects to obtain the value of a block output and display in the MATLAB Command Window by entering the following commands.

```
rto = get_param(gcf, 'RuntimeObject')
rto.OutputPort(1).Data
```

However, the displayed data may not be the true block output if the run-time object is not synchronized with the Simulink execution. Simulink only ensures the run-time object and Simulink execution are synchronized when the run-time object is used either within a Level-2 MATLAB S-function or in an event listener callback. When called from the MATLAB Command Window, the run-time object can return incorrect output data if other blocks in the model are allowed to share memory.

To ensure the `Data` field contains the correct block output, open the Configuration Parameters dialog box, and then clear the **Signal storage reuse** check box on the **All Parameters** tab (see “Signal storage reuse”).

## More About

- “Nonvirtual and Virtual Blocks” on page 34-2
- “Specify Block Properties” on page 34-4

- “Adjust Visual Presentation to Improve Model Readability” on page 34-8
- “Display Port Values for Debugging” on page 34-16
- “Control and Display the Sorted Order” on page 34-27



# Working with Block Parameters

---

- “Set Block Parameter Values” on page 35-2
- “Share and Reuse Block Parameter Values by Creating Variables” on page 35-11
- “Parameter Interfaces for Reusable Components” on page 35-20
- “Organize Related Block Parameter Definitions in Structures” on page 35-22
- “Tune and Experiment with Block Parameter Values” on page 35-38
- “Manage Variables from Block Parameters” on page 35-47
- “Optimize, Estimate, and Sweep Block Parameter Values” on page 35-50
- “Control Block Parameter Data Types” on page 35-57
- “Specify Minimum and Maximum Values for Block Parameters” on page 35-66
- “Switch Between Sets of Parameter Values During Simulation and Code Execution” on page 35-71

## Set Block Parameter Values

Blocks have numeric parameters that determine how they calculate output values. To control the calculations that blocks perform, you can specify parameter values. For example, a Gain block has a **Gain** parameter, and a Transfer Fcn block has multiple parameters that represent the transfer function coefficients.

You can use numbers, variables, and expressions to set block parameter values. Choose a technique based on your modeling goals. For example, you can:

- Share parameter values between blocks and models by creating variables.
- Control parameter characteristics such as data type and dimensions by creating parameter objects.
- Model an algorithm as code by using mathematical expressions.

Set block parameters using the property inspector or the block dialog box. For more information, see “Block Parameters and Properties in Simulink” on page 1-55. To set block sample times, see “Specify Sample Time” on page 7-3.

---

**Tip:** You can use the Model Explorer to make batch changes to many block parameter values at once. For more information, see “Search and Edit Using Model Explorer” on page 12-2.

---

## Programmatically Access Parameter Values

To programmatically access block parameter values, use the `get_param` and `set_param` functions. You can use this technique to:

- Construct a model programmatically.
- Adjust parameter values during a simulation run when you simulate a model programmatically.

To sweep parameter values between simulation runs by using a script, use `Simulink.SimulationInput` objects instead of `get_param` and `set_param`. See “Optimize, Estimate, and Sweep Block Parameter Values” on page 35-50.

Suppose you create a model named `myModel` that contains a Constant block named `My Constant`. Next, you use the block dialog box to set the **Constant value** parameter to

15. To programmatically return the parameter value, use the function `get_param`. You specify the block path and the equivalent programmatic parameter name, `Value`.

```
paramValue = get_param('myModel/My Constant', 'Value')

paramValue =

15
```

To programmatically change the value, for example to 25, use the function `set_param`. Use the character vector `'25'` as the input to the function.

```
set_param('myModel/My Constant', 'Value', '25')
```

For a list of programmatic names of block parameters, see “Block-Specific Parameters”.

For more information about programmatic simulation, see “Run Simulations Programmatically” on page 24-2.

To avoid using the `get_param` and `set_param` functions, use the name of a MATLAB variable or `Simulink.Parameter` object as the parameter value, and change the value of the variable or object at the command prompt. See “Share and Reuse Block Parameter Values by Creating Variables” on page 35-11.

## Specify Parameter Values

Goal	Block Parameter Value	Description
Store the parameter value in the model file.	2.3 [1.2 2.3 4.5; 7.9 8.7 6.5] 2 + 3i	Literal numeric value. Specify a scalar, vector, matrix, or multidimensional array. Use <code>i</code> to specify complex values.
<ul style="list-style-type: none"> <li>Access the parameter value without having to locate or identify the block in the model.</li> <li>Change the parameter value without having to modify the model file.</li> </ul>	myVar	MATLAB variable that exists in a workspace.  For more information, see “Share and Reuse Block Parameter Values by Creating Variables” on page 35-11.

Goal	Block Parameter Value	Description
<ul style="list-style-type: none"> <li>• Share the parameter value between blocks or between models.</li> <li>• Identify the parameter by a specific name when sweeping or tuning the value.</li> </ul>		
<ul style="list-style-type: none"> <li>• Avoid name clashes between workspace variables.</li> <li>• Organize parameter values using hierarchies and meaningful names.</li> <li>• Reduce the number of workspace variables that a model uses.</li> </ul>	<code>myParam.a.SpeedVect</code>	Field of parameter structure.  For more information, see “Organize Related Block Parameter Definitions in Structures” on page 35-22.
Use a portion of a matrix or array variable. For example, set the parameters of a n-D Lookup Table block.	<code>myMatrixParam(:,2)</code>	Index operation.
<ul style="list-style-type: none"> <li>• Define parameter characteristics, such as data type, complexity, units, allowed value range, and dimensions, separately from the parameter value.</li> <li>• Define a system constant with custom documentation.</li> <li>• Create a tunable parameter in the generated code.</li> </ul>	<code>myParam</code>	Parameter object.  For more information, see “Use Parameter Objects” on page 35-5.



Goal	Block Parameter Value	Description
<ul style="list-style-type: none"> <li>Model a complicated algorithm or subroutine by using code instead of blocks.</li> <li>Reduce block population in a model.</li> <li>Use MATLAB operators and functions to perform calculations in a model.</li> <li>Write a custom MATLAB function that calculates parameter values.</li> </ul>	$5^{3.2} - 1/3$ <code>myParam * myOtherparam + sin(0.78*pi)</code> <code>myFun(15.23)</code>	<p>Expression or custom function.</p> <p>For more information, see “Use MATLAB Functions and Custom Functions” on page 35-6.</p>
Specify a block parameter value by using a data type other than <code>double</code> .	<code>15.23</code> <code>single(15.23)</code> <code>myParam</code>	<p>Typed or untyped expression, numeric MATLAB variable, or parameter object.</p> <p>For more information about controlling parameter data types, see “Control Block Parameter Data Types” on page 35-57.</p>

### Use Parameter Objects

Parameter objects are `Simulink.Parameter` objects and objects of the subclasses that you create. The parameter object exists in a workspace such as the base workspace or a data dictionary.

You can use parameter objects to define system constants. For example, use a parameter object to represent the radius of the Earth. Use the properties of the object to specify the physical units and to document the purpose of the value.

Create parameter objects to prepare your model for code generation. You can configure parameter objects to appear as tunable global variables in the generated code. You can also control the parameter data type through the object.

To create and use parameter objects in models, see “Data Objects” on page 57-59. For information about using variables to set block parameter values, see “Share and Reuse Block Parameter Values by Creating Variables” on page 35-11.

### Use MATLAB Functions and Custom Functions

You can set a block parameter value to an expression that calls MATLAB functions and operators such as `sin` and `max`. You can also call your own custom functions that you write on the MATLAB path.

Suppose that a section of your block algorithm uses variables to calculate a single constant number used by the rest of the algorithm. You can perform the calculation by creating multiple blocks.

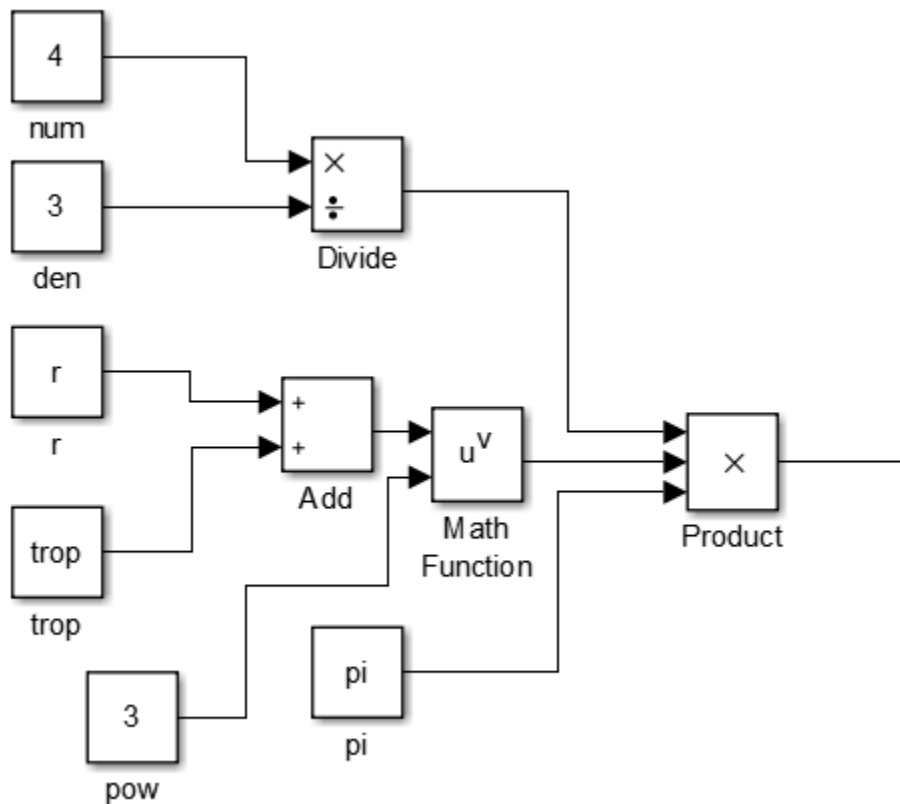

Instead, create a single Constant block that uses an expression written in MATLAB code. This technique reduces the size of the block algorithm and improves readability.

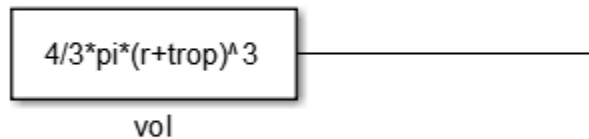

You can model a complicated portion of an algorithm by using an expression instead of many blocks. To operate on an existing signal, use a mathematical expression as the value of a parameter in an algorithmic block, such as the **Gain** parameter of a Gain block.

With expressions, you can also call your custom functions to set block parameter values. Suppose that you write a MATLAB function that calculates optimal P, I, and D parameters for a control algorithm by accepting a single input number.

```

paramFcn.m x +
1  function paramValue = paramFcn(performance,parameter)
2  %PARAMVALUE = paramFcn(PERFORMANCE,PARAMETER) returns the P, I, or D
3  %value PARAMVALUE that you request using PARAMETER. Specify performance
4  %criteria using PERFORMANCE.
5
6  % Initialize output.
7  paramValue = [];
8
9  % Calculate parameter value.
10 switch parameter
11     case 'P'
12         paramValue = performance*3;
13     case 'I'
14         paramValue = sqrt(performance)/0.175;
15     case 'D'
16         paramValue = performance^0.25;
17
18 % Validation

```

You can parameterize a PID Controller block by using the function to set the parameter values.

Controller parameters

Source:	internal
Proportional (P):	paramFcn(perf,'P')
Integral (I):	paramFcn(perf,'I')
Derivative (D):	paramFcn(perf,'D')

## Considerations for Other Modeling Goals

Choose a technique to set block parameter values based on your modeling goals.

Goal	Features or Products	Best Practice
Run multiple simulations quickly.	Simulink.Simulink objects and the <code>sim</code> function	Use variables or parameter objects to set block parameter values. This technique helps you to assign meaningful names to the parameters and to avoid having to identify or locate the blocks in the model. See “Optimize, Estimate, and Sweep Block Parameter Values” on page 35-50.
Sweep parameter values during testing.	Simulink Test™	Use variables or parameter objects to set block parameter values. Use iterations and parameter overrides to run multiple tests. See “Parameter Overrides” (Simulink Test) and “Run Multiple Combinations of Tests Using Iterations” (Simulink Test).
Estimate and optimize parameter values.	Simulink Design Optimization™	<p>Use variables or parameter objects to set block parameter values.</p> <p>To estimate or optimize a parameter that uses a data type other than <code>double</code>, use a parameter object to separate the value from the data type.</p> <p>For parameter estimation, see “Parameter Estimation” (Simulink Design Optimization). For response optimization, see “Optimize Model Response” (Simulink Design Optimization).</p>
Generate code from a model. Simulate an external program through SIL/PIL or External mode simulations.	Simulink Coder	<p>Use parameter objects to set block parameter values. This technique helps you to declare and identify tunable parameters in the generated code and to control parameter data types. See “Block Parameter Representation in the Generated Code” (Simulink Coder).</p> <p>When you use expressions to set block parameter values, avoid using operators and functions that result in loss of tunability in the generated code. See “Tunable Expression Limitations” (Simulink Coder).</p>

**See Also**  
`set_param`

## **Related Examples**

- “Determine Where to Store Variables and Objects for Simulink Models” on page 57-85
- “Organize Related Block Parameter Definitions in Structures” on page 35-22
- “Tune and Experiment with Block Parameter Values” on page 35-38
- “Block-Specific Parameters”

## Share and Reuse Block Parameter Values by Creating Variables

To set a block parameter value, such as the **Gain** parameter of a Gain block, you can use numeric variables that you create and store in workspaces such as the base workspace, a model workspace, or a Simulink data dictionary. You can use the variable to set multiple parameter values in multiple blocks, including blocks in different models. To change the values of the block parameters, you change the value of the variable in the workspace.

Using a variable to set a block parameter value also enables you to:

- Access the parameter value without having to locate the block in the model.
- Change the parameter value without having to modify the model file (if you store the variable outside the model workspace).
- Identify the parameter by a specific, meaningful name when sweeping or tuning the value.

For basic information about setting block parameter values, see “Set Block Parameter Values” on page 35-2.

### Reuse Parameter Values in Multiple Blocks and Models

You can create a numeric MATLAB variable in a workspace, such as the base workspace or a data dictionary, and use it to specify one or more block parameter values.

- 1 At the command prompt, create a numeric variable in the base workspace. For example, create a variable `myParam` whose value is `15.23`.

```
myParam = 15.23;
```

- 2 Open a block dialog box. Set the value of the target parameter to `myParam`.
- 3 Set the values of parameters in the same block or in other blocks to `myParam`.

If you store the variable in the base workspace, you can use the variable in all open models. For example, if you use model referencing to segment a model into components, you can use the variable in multiple models in a model reference hierarchy.

If you store the variable in a data dictionary, you can use the variable in all of the models that are linked to the dictionary or to other dictionaries that reference the dictionary. If you link multiple models to different data dictionaries, to use a variable in more than one of the models, consider storing the variable in a single separate dictionary to which

no models are linked. Then, use dictionary referencing to share the variable between the target models. Models that you link to a data dictionary cannot use variables that are in the base workspace.

## Define a System Constant

To define a system constant, such as a variable that represents the radius of the Earth, consider creating a `Simulink.Parameter` object instead of a numeric MATLAB variable. Parameter objects allow you to specify physical units and custom documentation as well as other characteristics.

To create and use parameter objects in models, see “Data Objects” on page 57-59.

## Control Scope of Parameter Values

The *scope* of a variable is the set of models and blocks that can use the variable. For example, variables that you create in the base workspace have global scope because all blocks in all open models can use the variables. Variables that you store in a model workspace have limited scope because only the blocks in the host model can use the variables.

You cannot create two variables that have the same name in the same scope. Controlling the scope of a variable helps you to avoid name conflicts and establish clear ownership of the variable.

The table describes the different ways that you can control the scope of a reusable parameter value.

Scope	Technique
All open models	Create a variable in the base workspace.
One or more targeted models	Create a variable in a data dictionary. To reuse the variable in multiple models, create a referenced dictionary. See “What Is a Data Dictionary?” on page 61-2
One model, including all subsystems in the model	Create a variable in the model workspace. See “Model Workspaces” on page 57-106.
Multiple blocks inside a subsystem, including blocks in nested subsystems	Mask the subsystem and create a mask parameter instead of a workspace variable.



Scope	Technique
	<p>To prevent blocks inside a subsystem from using workspace variables, in the subsystem block dialog box, set <b>Permit Hierarchical Resolution</b> to <b>None</b>. This technique allows you to use the same name to create both a variable in a workspace and a mask parameter in the subsystem mask. The blocks in the subsystem can use only the mask parameter.</p> <p>For information about subsystems, see <i>Subsystem</i>. For information about masking, see “Masking Fundamentals” on page 37-2.</p>

To avoid name conflicts when you have a large model with many variables in the same scope, consider packaging the variables into a single structure. For more information, see “Organize Related Block Parameter Definitions in Structures” on page 35-22.

For basic information about how blocks use the variable names that you specify, see “Symbol Resolution” on page 57-118.

## Permanently Store Workspace Variables

Variables that you create in the base workspace variables do not persist between MATLAB sessions. However, you can store the variables in a MAT-file or script file, and load the file whenever you open the model using a model callback. A model *callback* is a set of commands that Simulink executes when you interact with a model in a particular way, such as opening the model. You can use a callback to load variables when you open the model. Use this technique to store variables while you learn about Simulink and experiment with models.

- 1 In a model that contains a Gain block, set the value of the **Gain** parameter to K.
- 2 At the command prompt, create a variable K in the base workspace.
 

```
K = 27;
```
- 3 In the Workspace browser, right-click the variable and select **Save As**.

To save multiple variables in one file, select all of the target variables in the Workspace browser, and then right-click any of the selected variables.

- 4 In the dialog box, set **Save as type** to **MATLAB Script**. Set **File name** to `loadvar` and click **Save**.

The script file `loadvar.m` appears in your current folder. You can open the file to view the command that creates the variable `K`.

- 5 In the model, select **File > Model Properties > Model Properties**.
- 6 In the **Callbacks** tab of the Model Properties dialog box, select `PreLoadFcn` as the callback that you want to define. In the **Model pre-load function** pane, enter `loadvar` and click **OK**.
- 7 Save the model.

The next time that you open the model, the `PreloadFcn` callback loads the variable `K` into the base workspace. You can also save the variable to a MAT-file, for example `loadvar.mat`, and set the model callback to `load loadvar`.

To learn about callbacks, see “Callbacks for Customized Model Behavior” on page 4-46 and “Callbacks for Customized Model Behavior” on page 4-46. To programmatically define a callback for loading variables, see “Programmatically Store Workspace Variables for a Model” on page 35-14.

When you save variables to a file, you must save the changes that you make to the variables during your MATLAB session. To permanently store variables for a model, consider using a model workspace or a data dictionary instead of a MAT-file or script file. For more information about permanently storing variables, see “Determine Where to Store Variables and Objects for Simulink Models” on page 57-85.

### Programmatically Store Workspace Variables for a Model

In the example above, you define a model callback that creates variables when you open a model. You can programmatically save the variable and set the model callback.

- 1 At the command prompt, create the variable `K` in the base workspace.

```
K = 27;
```

- 2 Save the variable to a new script file named `loadvar.m`.

```
matlab.io.saveVariablesToScript('loadvar.m','K')
```

- 3 Set the model callback to load the script file.

```
set_param('myModel', 'PreloadFcn', 'loadvar')
```

- 4 Save the model.

```
save_system('myModel')
```

The function `matlab.io.saveVariablesToScript` saves variables to a script file. To save variables to a MAT-file, use the function `save`. To programmatically set model properties such as callbacks, use the function `set_param`.

## Manage and Edit Workspace Variables

When you use variables to set block parameter values, you store the variables in a workspace or data dictionary. You can use the command prompt or the Model Explorer to create, move, copy, and edit variables. You can also determine where a variable is used in a model, list all of the variables that a model uses, and list all of the variables that a model does not use.

The Model Explorer allows you to manage variables by using a graphical interface. You can view and edit the contents of any workspace, including data dictionaries, and transfer variables from one workspace to another. To view and modify a variable whose value is a structure or array, you can launch the Variable Editor from the Model Explorer. For more information, see “Search and Edit Using Model Explorer” on page 12-2 and “Edit and Manage Workspace Variables Used by Models” on page 57-92.

You can also create and edit variables directly from block parameters. Use this technique to determine where a variable is stored and to avoid navigating away from your model. See “Manage Variables from Block Parameters” on page 35-47.

To view tunable block parameter values in a list that you can search, sort, and filter, use the **Parameters** tab in the Model Data Editor. You can also create and navigate to variables that the block parameters use. To use the Model Data Editor, see “Configure Data Properties by Using a Table” on page 57-123.

At the command prompt, you can create variables in the base workspace by entering commands such as `myVar = 15;`. To programmatically create and store variables in a different workspace, such as a model workspace, use the programmatic interface for the target workspace. The table shows the interfaces and techniques that you can use to programmatically manage variables.

Target Workspace	Technique or Interface
Base workspace	Enter commands at the command prompt.
Model workspace	See <code>Simulink.ModelWorkspace</code> .
Data dictionary	See “Store Data in Dictionary Programmatically” on page 61-52.

To programmatically list the variables that a model uses or does not use, see `Simulink.findVars`.

To programmatically access variables for the purpose of sweeping block parameter values, consider using `Simulink.SimulationInput` objects instead of modifying the variables through the programmatic workspace interfaces. See “Optimize, Estimate, and Sweep Block Parameter Values” on page 35-50.

## Package Shared Breakpoint and Table Data for Lookup Tables

To share breakpoint vectors or table data between multiple n-D Lookup Table, Prelookup, and Interpolation Using Prelookup blocks, consider storing the data in `Simulink.LookupTable` and `Simulink.Breakpoint` objects instead of MATLAB variables or `Simulink.Parameter` objects. This technique improves model readability by clearly identifying the data as parts of a lookup table and explicitly associating breakpoint data with table data.

### Store Standalone Lookup Table in `Simulink.LookupTable` Object

A standalone lookup table consists of a set of table data and one or more breakpoint vectors. You do not share the table data or any of the breakpoint vectors with other lookup tables.

When you share a standalone lookup table, you use all of the table and breakpoint data together in multiple n-D Lookup Table blocks. To store this data in a `Simulink.LookupTable` object:

- 1 Create the object in a workspace or data dictionary. For example, at the command prompt, enter:
 

```
myLUTObj = Simulink.LookupTable;
```
- 2 Use the properties of the object to store the values of the table and breakpoint data.

- 3 Use the properties of the object to configure a unique name for the structure type in the generated code. In the property dialog box, under **Struct Type definition**, specify **Name**.
- 4 In the n-D Lookup Table blocks, set **Data specification** to `Lookup table` object.
- 5 To the right of **Data specification**, set **Name** to the name of the `Simulink.LookupTable` object.

For ways to create and configure `Simulink.LookupTable` objects, see `Simulink.LookupTable`

### Store Shared Data in `Simulink.LookupTable` and `Simulink.Breakpoint` Objects

When you use Prelookup and Interpolation Using Prelookup blocks to more finely control the lookup algorithm, you can share breakpoint vectors and sets of table data. For example, you can share a breakpoint vector between two separate sets of table data. With this separation of the breakpoint data from the table data, you can share individual parts of a lookup table instead of sharing the entire lookup table.

To store breakpoint and table data:

- 1 Create a `Simulink.LookupTable` object for each unique set of table data. Create a `Simulink.Breakpoint` object for each unique breakpoint vector, including breakpoint vectors that you do not intend to share.
- 2 Use the properties of the objects to store the values of the table and breakpoint data.
- 3 Configure the `Simulink.LookupTable` objects to refer to the `Simulink.Breakpoint` objects for breakpoint data. In the `Simulink.LookupTable` objects, set **Specification** to `Reference`. Specify the names of the `Simulink.Breakpoint` objects.
- 4 In the Interpolation Using Prelookup blocks, set **Specification** to `Lookup table` object. Set **Name** to the name of a `Simulink.LookupTable` object.

In the Prelookup blocks, set **Specification** to `Breakpoint` object. Set **Name** to the name of a `Simulink.Breakpoint` object.

The example model `fxpdemo_lookup_shared_param` contains two Prelookup and two Interpolation Using Prelookup blocks. Configure the blocks so that each combination of a Prelookup and an Interpolation Using Prelookup block represents a unique lookup table. Share the breakpoint vector between the two lookup tables. In this case, each lookup table has unique table data but shared breakpoint data.

- 1 Open the example model.
- 2 In the Prelookup block dialog box, set **Specification** to Breakpoint object. Set **Name** to sharedBkpts.
- 3 Click the button  next to the value of the **Name** parameter. Select **Create Variable**.
- 4 In the **Create New Data** dialog box, set **Value** to Simulink.Breakpoint and click **Create**.

A Simulink.Breakpoint object appears in the base workspace.

- 5 In the property dialog box for sharedBkpts, specify **Value** as a vector such as [1 2 3 4 5 6 7 8 9 10]. Click **OK**.
- 6 In the Prelookup block dialog box, click **OK**.
- 7 In the Prelookup1 block dialog box, set **Specification** to Breakpoint object. Set **Name** to sharedBkpts.
- 8 In the Interpolation Using Prelookup block dialog box, set **Specification** to Lookup table object. Set **Name** to dataForFirstTable.
- 9 Click the button  next to the value of the **Name** parameter. Select **Create Variable**.
- 10 In the **Create New Data** dialog box, set **Value** to Simulink.LookupTable and click **Create**.

A Simulink.LookupTable object appears in the base workspace.

- 11 In the property dialog box for dataForFirstTable, specify **Value** as a vector, such as [10 9 8 7 6 5 4 3 2 1].
- 12 Set **Specification** to Reference.
- 13 In the table under **Specification**, set **Name** to sharedBkpts and click **OK**.
- 14 In the Interpolation Using Prelookup block dialog box, click **OK**.
- 15 Configure the Interpolation Using Prelookup1 block to use a Simulink.LookupTable object named dataForSecondTable. In the object property dialog box, specify **Value** as a vector, such as [0 0.5 1 1.5 2 2.5 3 3.5 4 4.5]. Configure the object to refer to sharedBkpts for the breakpoint data.

The model now represents two unique lookup tables:

- A combination of sharedBkpts and dataForFirstTable.

- A combination of `sharedBkpts` and `dataForSecondTable`.

These lookup tables share the same breakpoint data through `sharedBkpts`.

### **Related Examples**

- “Manage Variables from Block Parameters” on page 35-47
- “Data Objects” on page 57-59
- “Organize Related Block Parameter Definitions in Structures” on page 35-22
- “Set Block Parameter Values” on page 35-2

## Parameter Interfaces for Reusable Components

You can use subsystems, referenced models, and custom library blocks as reusable components in other models. For guidelines to help you decide how to componentize a system, see “Componentization Guidelines” on page 15-29.

Typically, a reusable algorithm requires that numeric block parameters, such as the **Gain** parameter of a Gain block, either:

- Use the same value in all instances of the component.
- Use a different value in each instance of the component. Each value is instance specific.

By default, if you use a literal number or expression to set the value of a block parameter, the parameter uses the same value in all instances of the component. If you set multiple block parameter values by using a MATLAB variable, `Simulink.Parameter` object, or other parameter object in a workspace or data dictionary, these parameters also use the same value in all instances of the component.

### Referenced Models

If you use model referencing to create a reusable component, to set parameter values that are specific to each instance, configure model arguments for the referenced model. When you instantiate the model by adding a Model block to a different model, you set the values of the arguments in the Model block. When you add another Model block to the same parent model or to a different model, you can set different values for the same arguments. Optionally, if you create more than two instances, you can set the same value for some of the instances and different values for the other instances.

If a model has many model arguments, consider packaging the arguments into a single structure. Instead of configuring many arguments, configure the structure as a single argument. Without changing the mathematical functionality of the component, this technique helps you to reduce the number of model argument values that you must set in each instance of the component.

For more information about model arguments, see “Parameterize Instances of a Reusable Referenced Model” on page 8-65.



## Subsystems

If you use subsystems or custom libraries to create reusable components, to set parameter values that are specific to each instance, use masks, mask parameters, and parameter promotion. When you instantiate the component in a model, you set the values of the mask parameters in the Subsystem block. When you instantiate the component again in the same model or a different model, you can set different values for the same mask parameters. Optionally, if you create more than two instances, you can set the same value for some of the instances and different values for the other instances.

If the subsystem has many mask parameters, consider packaging the parameters into a single structure. Instead of configuring many mask parameters, configure the structure as a single parameter. Without changing the mathematical functionality of the component, this technique helps you to reduce the number of mask parameter values that you must set in each instance of the component.

For more information about subsystems, see [Subsystem](#). For more information about custom block libraries, see [“Create a Custom Block”](#) on page 38-19. For more information about masks, see [“Masking Fundamentals”](#) on page 37-2. For more information about structures, see [“Organize Related Block Parameter Definitions in Structures”](#) on page 35-22.

## Related Examples

- [“Determine Where to Store Variables and Objects for Simulink Models”](#) on page 57-85
- [“Share and Reuse Block Parameter Values by Creating Variables”](#) on page 35-11
- [“Set Block Parameter Values”](#) on page 35-2

## Organize Related Block Parameter Definitions in Structures

When you use numeric MATLAB variables to set block parameter values in a model, large models can accumulate many variables, increasing the effort of maintenance and causing the variable names to grow in length.

Instead, you can organize these parameter values into structures. Each structure is a single variable and each field of the structure stores a numeric parameter value. You can assign meaningful names to the structures, substructures, and fields to indicate the purpose of each value.

Use structures to:

- Reduce the number of workspace variables that you must maintain.
- Avoid name conflicts between workspace variables.

You cannot create two variables that have the same name in the same scope, such as in the base workspace. When you create structures, you must provide each field a name, but multiple structures can each contain a field that uses the same name. Therefore, you can use each structure and substructure as a *namespace* that prevents the field names from conflicting with each other and with other variable names in the same scope.

- Logically group sets of block parameter values. For example, use nested structures to clearly identify the parameter values that each subsystem or referenced model uses.

If you use mask parameters or model arguments to pass parameter values to the components of a system, you can use structures to reduce the number of individual mask parameters or model arguments that you must maintain. Instead of passing multiple variables, you can pass a single structure variable.

For basic information about creating and manipulating MATLAB structures, see Structures (MATLAB). For basic information about setting block parameter values in a model, see “Set Block Parameter Values” on page 35-2.

To use structures to initialize bus signals, see “Specify Initial Conditions for Bus Signals” on page 63-99.

### Create and Use Parameter Structure

This example shows how to create and use a parameter structure in a model.

The example model `f14` uses multiple variables from the base workspace to set block parameter values. For example, when you open the model, it creates the variables `Zw`, `Mw`, and `Mq` in the base workspace. To organize these variables into a single structure variable:

- 1 At the command prompt, open the example model.

```
f14
```

- 2 At the command prompt, create the parameter structure `myGains`. Set the field values by using the values of the target variables.

```
myGains.Zw = Zw;
myGains.Mw = Mw;
myGains.Mq = Mq;
```

- 3 In the Model Explorer, on the **Model Hierarchy** pane, click **Base Workspace**. In the **Contents** pane, right-click the variable `Mq` and select **Find Where Used**.
- 4 In the **Select a system** dialog box, click the node `f14` and click **OK**. Click **OK** when asked about updating the diagram.
- 5 In the **Contents** pane, right-click the row corresponding to the block labeled `Gain1` and select **Properties**. The `Gain1` block dialog box opens.
- 6 Change the value of the **Gain** parameter from `Mq` to `myGains.Mq` and click **OK**.
- 7 In the **Contents** pane, right-click the row corresponding to the `Transfer Fcn.1` block and select **Properties**.
- 8 Change the value of the **Denominator coefficients** parameter from `[ 1, -Mq]` to `[ 1, -myGains.Mq]` and click **OK**.
- 9 In the **Model Hierarchy** pane, click **Base Workspace**. Use **Find Where Used** to locate the blocks that use the variables `Mw` and `Zw`. In the block dialog boxes, replace the references to the variable names according to the table.

Variable Name	Replacement Name
<code>Mw</code>	<code>myGains.Mw</code>
<code>Zw</code>	<code>myGains.Zw</code>

- 10 Clear the old variables.

```
clear Zw Mw Mq
```

Each of the modified block parameters now uses a field of the `myGains` structure. The numeric value of each structure field is equal to the value of the corresponding variable that you cleared.

You can use the functions `Simulink.BlockDiagram.createVarStruct` and `Simulink.BlockDiagram.applyVarStruct` to migrate a model to use a single parameter structure instead of multiple workspace variables. For an example, see “Migration to Structure Parameters”.

## Store Data Type Information in Field Values

To use a structure or array of structures to organize parameter values that use a data type other than `double`, you can explicitly specify the type when you create the structure. When you create the structure, use typed expressions such as `single(15.23)` to specify the field values.

```
myParams.Gain = single(15.23);
```

If you want to change the field value later, you must remember to explicitly specify the type again. If you do not specify the type, the field value uses the data type `double` instead:

```
myParams.Gain = 15.23;  
% The field 'Gain' now uses the data type 'double' instead of 'single'.
```

To preserve the type specification, you can use subscripted assignment to assign a new value to the field:

```
% Assign value of type 'single'.  
myParams.Gain = single(15.23);  
  
% Assign new value while retaining type 'single'.  
myParams.Gain(:) = 11.79;
```

To match a fixed-point data type, set the field value by using an `fi` object.

## Control Field Data Types and Characteristics by Creating Parameter Object

A `Simulink.Parameter` object allows you to separate the value of a block parameter from its data type. If you use a parameter object to store a structure or array of structures, you can create a `Simulink.BUS` object to use as the data type of the entire structure.

You can use the bus object and the parameter object to explicitly control:

- The data type of each field. When you use this technique, you do not have to remember to use typed expressions or subscripted assignment to set the field values.
- The complexity, dimensions, and units of each field.
- The minimum and maximum value of each field if the field represents a tunable parameter value.
- The shape of the entire structure. The *shape* of the structure is the number, names, and hierarchy of fields.
- The tunability of the structure in the code that you generate from the model.

- 1 Create a parameter structure `myParams`.

```
myParams = struct(...
    'SubsystemA', struct(...
        'Gain', 15.23, ...
        'Offset', 89, ...
        'Init', 0.59), ...
    'SubsystemB', struct(...
        'Coeffs', [5.32 7.99], ...
        'Offset', 57, ...
        'Init1', 1.76, ...
        'Init2', 2.76) ...
);
```

- 2 Use the function `Simulink.Bus.createObject` to create `Simulink.Bus` objects that represent the structure and substructures.

```
Simulink.Bus.createObject(myParams)
```

Because `myParams` contains two unique substructures, the function creates three `Simulink.Bus` objects: one named `s1Bus1` to represent the parent structure `myParams`, one named `SubsystemA` for the substructure `SubsystemA`, and one named `SubsystemB` for the substructure `SubsystemB`.

- 3 Rename the bus object `s1Bus1` as `myParamsType`.

```
myParamsType = s1Bus1;
clear s1Bus1
```

- 4 Store the structure `myParams` in a `Simulink.Parameter` object.

```
myParams = Simulink.Parameter(myParams);
```

The `Value` property of the parameter object contains the structure.

- 5 Set the data type of the parameter object to the bus object `myParamsType`.

```
myParams.DataType = 'Bus: myParamsType';
```

- 6 Open the Bus Editor to view the bus objects.

```
buseditor
```

- 7 In the **Model Hierarchy** pane, click the node `SubsystemA`. In the **Contents** pane, set the field data types according to the figure.

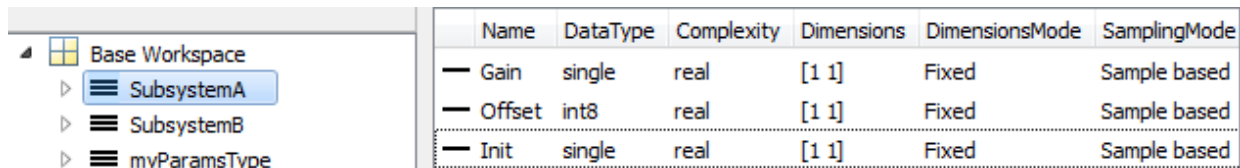

Name	DataType	Complexity	Dimensions	DimensionsMode	SamplingMode
Gain	single	real	[1 1]	Fixed	Sample based
Offset	int8	real	[1 1]	Fixed	Sample based
Init	single	real	[1 1]	Fixed	Sample based

- 8 Optionally, set the field data types for the substructure `SubsystemB`.

The parameter object `myParams` stores the parameter structure. The data type of the parameter object is the bus object `myParamType`. Prior to simulation and code generation, the parameter object casts the field values to the data types that you specified in the bus object.

To use one of the fields to set a block parameter value, specify an expression such as `myParams.SubsystemB.Init1`.

To access the field values at the command prompt, use the `Value` property of the parameter object. Because the bus object controls the field data types, you do not need to use a typed expression to set the field value.

```
myParams.Value.SubsystemA.Gain = 12.79;
```

The bus object strictly controls the field characteristics and the shape of the structure. For example, if you set the value of the two-element field `myParams.SubsystemB.Coeffs` to a three-element array, the model generates an error when you set a block parameter value. To change the dimensions of the field, modify the element `Coeffs` in the bus object `SubsystemB`.

To manipulate bus objects after you create them, see “Modify Bus Objects” on page 63-76 and “Save and Import Bus Objects” on page 63-82.

## Match Field Data Type with Signal Data Type

Suppose that you use the field `myParams.SubsystemA.Gain` to set the value of the **Gain** parameter in a Gain block. If you want the data type of the field to match the data type of the output signal of the block, consider using a `Simulink.AliasType` or a `Simulink.NumericType` object to set the data type of the field and the signal. If you do not use a data type object, you must remember to change the data type of the field whenever you change the data type of the signal.

- 1 At the command prompt, create a `Simulink.AliasType` object that represents the data type `single`.

```
myType = Simulink.AliasType;  
myType.BaseType = 'single';
```

- 2 In the Gain block dialog box, on the **Signal Attributes** tab, set **Output data type** to `myType`.
- 3 At the command prompt, open the Bus Editor.

```
buseditor
```

- 4 In the **Model Hierarchy** pane, select the bus object `SubsystemA`. In the **Contents** pane, set the data type of the field `Gain` to `myType`.

Now, both the output signal of the Gain block and the structure field `myParams.SubsystemA.Gain` use the data type that you specify by using the `BaseType` property of `myType`.

For more information about data type objects, see `Simulink.AliasType` and `Simulink.NumericType`.

## Manage Structure Variables

To create, modify, and inspect a variable whose value is a structure, you can use the Model Explorer whether you store the variable in the base workspace, a model workspace, or a data dictionary. To inspect and modify the field values in the structure, open the Variable Editor. For more information, see “Edit and Manage Workspace Variables Used by Models” on page 57-92.

## Define Parameter Hierarchy by Creating Nested Structures

To further organize block parameter values, create a hierarchy of nested structures.

For example, suppose that you create subsystems named `SubsystemA` and `SubsystemB` in your model. You use variables such as `Offset_SubsystemA` and `Offset_SubsystemB` to set block parameter values in the subsystems.

```
Gain_SubsystemA = 15.23;
Offset_SubsystemA = 89;
Init_SubsystemA = 0.59;

Coeffs_SubsystemB = [5.32 7.99];
Offset_SubsystemB = 57;
Init1_SubsystemB = 1.76;
Init2_SubsystemB = 2.76;
```

Create a parameter structure that contains a substructure for each subsystem. Use the values of the existing variables to set the field values.

```
myParams = struct(...
    'SubsystemA', struct(...
        'Gain', Gain_SubsystemA, ...
        'Offset', Offset_SubsystemA, ...
        'Init', Init_SubsystemA), ...
    'SubsystemB', struct(...
        'Coeffs', Coeffs_SubsystemB, ...
        'Offset', Offset_SubsystemB, ...
        'Init1', Init1_SubsystemB, ...
        'Init2', Init2_SubsystemB)...
);
```

The single structure variable `myParams` contains all of the parameter information for the blocks in the subsystems. Because each substructure acts as a namespace, you can define the `Offset` field more than once.

To use the `Offset` field from the substructure `SubsystemB` as the value of a block parameter, specify the parameter value in the block dialog box as the expression `myParams.SubsystemB.Offset`.

## Group Multiple Parameter Structures into an Array

To organize parameter structures that have similar characteristics, you can create a single variable whose value is an array of structures. This technique helps you to parameterize a model that contains multiple instances of an algorithm, such as a library subsystem or a referenced model that uses model arguments.



Suppose that you create two identical subsystems in a model.

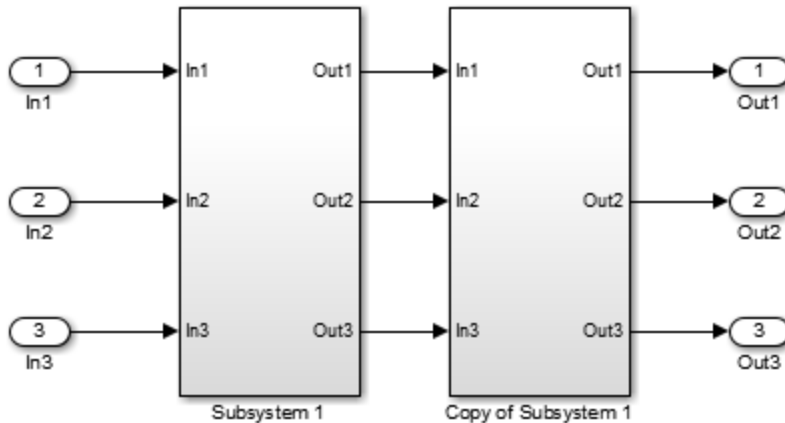

Suppose that the blocks in each subsystem require three numeric values to set parameter values. Create an array of two structures to store the values.

```
myParams(1).Gain = 15.23;
myParams(1).Offset = 89;
myParams(1).Init = 0.59;
```

```
myParams(2).Gain = 11.93;
myParams(2).Offset = 57;
myParams(2).Init = 2.76;
```

Each structure in the array stores the three parameter values for one of the subsystems.

To set the value of a block parameter in one of the subsystems, specify an expression that references a field of one of the structures in the array. For example, use the expression `myParams(2).Init`.

### Organize Parameter Values for Reusable Components and Iterative Algorithms

You can also partition an array of structures in a For Each Subsystem block. This technique helps you to organize workspace variables when a model executes an algorithm repeatedly, for example by iterating the algorithm over a vector signal. For an example, see “Repeat an Algorithm Using a For Each Subsystem” on page 63-131.

If you use model arguments to specify different parameter values across multiple instances of a referenced model, you can use arrays of structures to organize the model argument values. In the referenced model workspace, create a structure variable and configure the model to use the structure as a model argument. Use the fields of the structure to set block parameter values in the model. Then, create an array of structures in the base workspace or a data dictionary to which the parent model or models are linked. In the parent model or models, use each of the structures in the array as the value of the model argument in a Model block. Each structure in the array stores the parameter values for one instance of the referenced model.

The example model `sldemo_mdhref_datamngt` contains three instances (masked Model blocks) of the referenced model `sldemo_mdhref_counter_datamngt`. The base workspace variables `IC1`, `IC2`, `Param1`, and `Param2` are `Simulink.Parameter` objects whose values are structures. The parent model uses these variables to set the values of mask parameters on the Model blocks. Since `IC1` is structurally identical to `IC2`, and `Param1` to `Param2`, you can combine these four structures into two arrays of structures.

- 1 Open the example parent model.

```
sldemo_mdhref_datamngt
```

The model creates the four `Simulink.Parameter` objects in the base workspace.

- 2 Open the example referenced model.

```
sldemo_mdhref_counter_datamngt
```

The model workspace defines two model arguments, `CounterICs` and `CounterParams`, whose values are structures. The blocks in the model use the fields of these structures to set parameter values.

- 3 In the model `sldemo_mdhref_datamngt`, double-click each of the Model blocks, which opens the mask dialog boxes. Each mask uses a different combination of the four parameter objects from the base workspace to set the model argument values in the Model blocks.
- 4 At the command prompt, view the values of the parameter objects from the base workspace.

```
Param1.Value  
IC1.Value
```

```
ans =
```

```
Increment: 1
```

```

LowerLimit: -20
UpperLimit: 20

ans =

        Count: 0
OverflowState: InRange

```

The value of each parameter object is a structure. The structures in **Param2** and **IC2** have the same fields as the structures in **Param1** and **IC1** but different field values.

- Combine the four parameter objects into two parameter objects whose values are arrays of structures.

```

% Create a new parameter object by copying Param1.
Param = Param1.copy;

% Use the structure in Param2 as the second structure in the new object.
Param.Value(2) = Param2.Value;
% The value of Param is now an array of two structures.

% Delete the old objects Param1 and Param2.
clear Param1 Param2

% Create a new parameter object by copying IC1.
% Use the structure in IC2 as the second structure in the new object.
IC = IC1.copy;
IC.Value(2) = IC2.Value;
clear IC1 IC2

```

- In the parent model, double-click each of the Model blocks. In the mask dialog boxes, replace the parameter values according to the table.

Previous Value	New Value
Param1	Param(1)
IC1	IC(1)
Param2	Param(2)
IC2	IC(2)

Each Model block sets the value of the model argument **CounterICs** by using one of the structures in the array **IC**. Similarly, each block sets the value of **CounterParams** by using one of the structures in **Param**.

### Enforce Uniformity in an Array of Structures

All of the structures in an array of structures must have the same hierarchy of fields. Each field in the hierarchy must have the same characteristics throughout the array. You can use a parameter object and a bus object to enforce this uniformity among the structures.

To use a parameter object to represent an array of parameter structures, set the value of the object to the array of structures:

```
% Create array of structures.
myParams(1).Gain = 15.23;
myParams(1).Offset = 89;
myParams(1).Init = 0.59;
myParams(2).Gain = 11.93;
myParams(2).Offset = 57;
myParams(2).Init = 2.76;

% Create bus object.
Simulink.Bus.createObject(myParams);
myParamsType = slBus1;
clear slBus1

% Create parameter object and set data type.
myParams = Simulink.Parameter(myParams);
myParams.DataType = 'Bus: myParamsType';
```

To use one of the fields to set a block parameter value, specify an expression such as `myParams(2).Offset`.

To access the field values at the command prompt, use the `Value` property of the parameter object.

```
myParams.Value(2).Offset = 129;
```

### Create a Structure of Constant-Valued Signals

You can use a structure in a Constant block to create a single bus signal that transmits multiple numeric constants. For more information, see `Constant`. For information about bus signals, see “Buses” on page 63-3.

## Considerations Before Migrating to Parameter Structures

- Before you migrate a model to use parameter structures, discover all of the blocks in the target model and in other models that use the variables that you intend to replace.

For example, suppose two blocks in a model use the workspace variable `myVar`. If you create a structure `myParams` with a field `myVar`, and set the parameter value in only one of the blocks to `myParams.myVar`, the other block continues to use the variable `myVar`. If you delete `myVar`, the model generates an error because the remaining block requires the deleted variable.

To discover all of the blocks that use a variable:

- 1 Open all models that might use the variable. If the models are in a model reference hierarchy, you can open only the top model.
- 2 Right-click the variable in the Model Explorer **Contents** pane and select **Find Where Used**. The Model Explorer displays all of the blocks that use the variable.

You can discover variable usage only in models that are open. Before you migrate to parameter structures, open all models that might use the target variables. For more information about determining variable usage in a model, see “Finding Blocks That Use a Specific Variable” on page 57-95.

Alternatively, you can refrain from deleting `myVar`. However, if you change the value of the `myParams.myVar` structure field, you must remember to change the value of `myVar` to match.

- You can combine multiple separate variables or parameter objects (such as `Simulink.Parameter`) into a structure that you store in a single variable or parameter object (to combine parameter objects, see “Combine Existing Parameter Objects Into a Structure” on page 35-33). However, the resulting variable or object acts as a single entity. As a result, you cannot apply different code generation settings, such as storage classes, to individual fields in the structure.

## Combine Existing Parameter Objects Into a Structure

When you use parameter objects to set block parameter values (for example, so you can apply storage classes), to combine the objects into a single structure:

- 1 Create a MATLAB structure and store it in a variable. To set the field values, use the parameter values that each existing parameter object stores.
- 2 Convert the variable to a parameter object. Create and use a `Simulink.Bus` object as the data type of the parameter object (see “Control Field Data Types and Characteristics by Creating Parameter Object” on page 35-24).
- 3 Choose a storage class to apply to the resulting parameter object. You can choose only one storage class, which applies to the entire structure.
- 4 Transfer parameter metadata, such as the `Min` and `Max` properties of the existing parameter objects, to the corresponding properties of the `Simulink.BusElement` objects in the bus object.

For example, suppose you have three individual parameter objects.

```
coeff = Simulink.Parameter(17.5);  
coeff.Min = 14.33;  
coeff.DataType = 'single';  
coeff.StorageClass = 'ExportedGlobal';
```

```
init = Simulink.Parameter(0.00938);  
init.Min = -0.005;  
init.Max = 0.103;  
init.DataType = 'single';  
init.StorageClass = 'SimulinkGlobal';
```

```
offset = Simulink.Parameter(199);  
offset.DataType = 'uint8';  
offset.StorageClass = 'ExportedGlobal';
```

- 1 Create a structure variable.

```
myParams.coeff = coeff.Value;  
myParams.init = init.Value;  
myParams.offset = offset.Value;
```

- 2 Convert the variable to a parameter object.

```
myParams = Simulink.Parameter(myParams);
```

- 3 Create a bus object and use it as the data type of the parameter object.

```
Simulink.Bus.createObject(myParams.Value);  
paramsDT = copy(slBus1);
```

```
myParams.DataType = 'Bus: paramsDT';
```

- 4 Transfer metadata from the old parameter objects to the bus elements in the bus object.

```
% coeff
paramsDT.Elements(1).Min = coeff.Min;
paramsDT.Elements(1).DataType = coeff.DataType;

% init
paramsDT.Elements(2).Min = init.Min;
paramsDT.Elements(2).Max = init.Max;
paramsDT.Elements(2).DataType = init.DataType;

% offset
paramsDT.Elements(3).DataType = offset.DataType;
```

To help you write a script that performs this transfer operation, you can use the `properties` function to find the properties that the bus elements and the old parameter objects have in common. To list the structure fields so that you can iterate over them, use the `fieldnames` function.

- 5 Apply a storage class to the parameter object.

```
myParams.StorageClass = 'ExportedGlobal';
```

Now, you can use the fields of `myParams`, instead of the old parameter objects, to set the block parameter values.

## Parameter Structures in the Generated Code

You can configure parameter structures to appear in the generated code as structures and arrays of structures. For information about generating code with structure parameters, see “Organize Block Parameter Values into Structures in the Generated Code” (Simulink Coder).

## Parameter Structure Limitations

- The value of a field that you use to set a block parameter must be numeric or of an enumerated type. The value of a field can be a real or complex scalar, vector, or multidimensional array.
- If the value of any of the fields of a structure is a multidimensional array, you cannot tune any of the field values during simulation.

- All of the structures in an array of structures must have the same hierarchy of fields. Each field in the hierarchy must have the same characteristics throughout the array:
  - Field name
  - Numeric data type, such as `single` or `int32`
  - Complexity
  - Dimensions

Suppose that you define an array of two structures.

```
paramStructArray = ...  
[struct('sensor1',int16(7),'sensor2',single(9.23)) ...  
 struct('sensor1',int32(9),'sensor2',single(11.71))];
```

You cannot use any of the fields in a block parameter because the field `sensor1` uses a different data type in each structure.

- Parameter structures do not support context-sensitive data typing in the generated code. If the parameter structure is tunable in the code, the fields of the structure use the numeric data types that you specify by using either typed expressions or a `Simulink.Bus` object. If you do not use typed expressions or a `Simulink.Bus` object, the fields of the structure use the `double` data type.

## Package Shared Breakpoint and Table Data for Lookup Tables

When you share data between lookup table blocks, consider using `Simulink.LookupTable` and `Simulink.Breakpoint` objects instead of structures to store and group the data. This technique improves model readability by clearly identifying the data as parts of a lookup table and explicitly associating breakpoint data with table data. See “Package Shared Breakpoint and Table Data for Lookup Tables” on page 35-16.

## Create Parameter Structure According to Structure Type from Existing C Code

You can create a parameter structure that conforms to a `struct` type definition that your existing C code defines. Use this technique to:

- Replace existing C code with a Simulink model.



- Integrate existing C code for simulation in Simulink (for example, by using the Legacy Code Tool). For an example, see “Integrate C Function Whose Arguments Are Pointers to Structures”.
- Generate C code (Simulink Coder) that you can compile with existing C code into a single application. For an example, see “Exchange Structured and Enumerated Data Between Generated and External Code” (Embedded Coder).

In MATLAB, store the parameter structure in a parameter object and use a bus object as the data type (see “Control Field Data Types and Characteristics by Creating Parameter Object” on page 35-24). To create the bus object according to your C-code `struct` type, use the `Simulink.importExternalCTypes` function.

## Related Examples

- “Detailed Workflow for Managing Data with Model Reference”
- “Set Block Parameter Values” on page 35-2
- “Determine Where to Store Variables and Objects for Simulink Models” on page 57-85
- Structures (MATLAB)
- “Switch Between Sets of Parameter Values During Simulation and Code Execution” on page 35-71

## Tune and Experiment with Block Parameter Values

As you construct a model you can experiment with block parameters, such as the coefficients of a Transfer Fcn block, to help you decide which blocks to use. You can simulate the model with different parameter values, and capture and observe the simulation output.

You can change the values of most numeric block parameters during a simulation. To observe the effects, you can visualize the simulation output in real time. This technique allows you to quickly test parameter values while you develop an algorithm. You can visually:

- Tune and optimize control parameters.
- Calibrate model parameters.
- Test control robustness under different conditions.

When you begin a simulation, Simulink first updates the model diagram. This operation can take time for larger models. To test parameter values without repeatedly updating the model diagram, you can tune the parameter values during a single simulation run.

Alternatively, to avoid updating the model diagram, use Fast Restart. For more information about Fast Restart, see “Get Started with Fast Restart” on page 68-6.

If you cannot visually analyze the simulation output in real time, or if you must run many simulations, consider using a programmatic approach to sweeping parameter values. You can capture the simulation output data and perform analysis later. For more information, see “Optimize, Estimate, and Sweep Block Parameter Values” on page 35-50.

For basic information about accessing and setting block parameter values, see “Set Block Parameter Values” on page 35-2.

### Iteratively Adjust Block Parameter Value Between Simulation Runs

This example shows how to rapidly prototype a model by changing block parameter values between simulation runs. You can experiment with parameter values and observe simulation results to help you decide which blocks to use and how to build your model.

The example model `sldemo_fuelsys` represents the fueling system of a gasoline engine. A subsystem in the model, `feedforward_fuel_rate`, calculates the fuel demand of the

engine by using the constant number 14.6, which represents the ideal (stoichiometric) ratio of air to fuel that the engine consumes. Two blocks in the subsystem use the number to set the values of parameters.

Suppose that you want to change the design value of the ideal air-to-fuel ratio from 14.6 to 17.5 to observe the effect on the fuel demand. To store the design value in the model, you can modify the value in the block dialog boxes. Alternatively, you can store the value in a variable with a meaningful name, which allows you to reuse the value in the two blocks.

To observe the change in simulation outputs by changing the value in the block dialog boxes:

- 1 Open the example model.  
`sldemo_fuelsys`
- 2 Set the model simulation time from 2000 to 50 for a faster simulation.
- 3 In the model, open the Scope block dialog box.

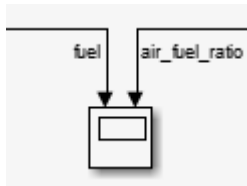

- 4 Simulate the model. Resize the window in the Scope block dialog box to see all of the simulation results.

The scope display shows that throughout the simulation, the `fuel` signal oscillates between approximately 0.9 and 1.6. The `air_fuel_ratio` signal quickly climbs to 15 without overshoot.

- 5 Navigate to the target subsystem.  
`open_system('sldemo_fuelsys/fuel_rate_control/fuel_calc/feedforward_fuel_rate')`
- 6 Open the block parameter dialog box for the Constant block labeled `rich`.
- 7 Change the **Constant value** parameter from  $1/(14.6 \cdot 0.8)$  to  $1/(17.5 \cdot 0.8)$ .
- 8 Similarly, change the **Constant value** parameter of the block labeled `normal` from  $1/14.6$  to  $1/17.5$ .
- 9 Simulate the model.

The scope display shows that the signals now respond differently.

To replace the literal values in the block dialog boxes with a numeric variable:

- 1 In the block dialog box for the block labeled `normal`, set **Constant value** to  $1 / \text{mixture}$  and click **OK**.
- 2 In the block dialog box for the block labeled `rich`, set **Constant value** to  $1 / (\text{mixture} * 0.8)$  and click **Apply**.
- 3 Click the button  next to the value of the **Constant value** parameter. Select **Create Variable > mixture**.
- 4 In the **Create New Data** dialog box, set **Value** to `17.5` and click **Create**. In the **Data properties** dialog box, click **OK**.

The numeric variable `mixture` appears in the base workspace with value `17.5`. Between simulation runs, you can change the value of `mixture` in the base workspace instead of changing the parameter values in the block dialog boxes.

## Tune Block Parameter Value During Simulation

This example shows how to observe the effect of changing a block parameter value during a simulation. This technique allows you to avoid updating the model diagram between simulation runs and to interactively test and debug your model.

The example model `sldemo_fuelsys` contains a **Constant** block, **Throttle Command**, that represents the throttle command. To observe the effect of increasing the magnitude of the command during simulation:

- 1 Open the example model.  
`sldemo_fuelsys`
- 2 In the model, open the Scope block dialog box.

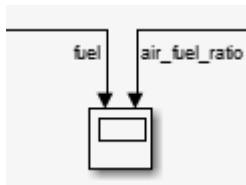

### 3 Begin a simulation.

The model is configured to simulate 2000 seconds. During the simulation, the values of the `fuel` and `air_fuel_ratio` signals appear on the scope graph in real time.

### 4 In the model, when the status bar indicates approximately 1000 (1000 seconds), click the Pause button to pause the simulation.

### 5 In the scope display, the `fuel` graph plots the simulation output prior to the pause time.

### 6 Open the block dialog box for the block labeled `Throttle Command`. Change the value of the **Output values** parameter from [10 20 10] to [10 30 10] and click **OK**.

### 7 Click the Step Forward button to advance the simulation step by step. Click the button about 15 times or until you see a change in the `fuel` graph in the scope display.

The plot of the signal `fuel` indicates a sharp increase in fuel demand that corresponds to the increased throttle command.

### 8 In the model, resume the simulation by clicking the Continue button .

The scope display shows the significant periodic increase in fuel demand, and the periodic reduction in the air-to-fuel ratio, throughout the rest of the simulation.

During the simulation, you must update the model diagram after you change the value of a workspace variable. For more information about updating the model diagram, see “Update Diagram and Run Simulation” on page 1-65.

## Prepare for Parameter Tuning and Experimentation

- Consider using workspace variables to set block parameter values.

To access the value of a block parameter, such as the **Constant value** parameter of a Constant block, you must navigate to the block in the model and open the block dialog box, search for the block by using the Model Explorer, or use the function `set_param` at the command prompt.

Alternatively, if you set the block parameter value by creating a workspace variable, you can change the value of the variable by using the command prompt, the MATLAB Workspace browser, or the Model Explorer. You can also create a variable to set the same value for multiple block parameters. When you change the variable value, all of

the target block parameters use the new value. For more information about accessing and setting block parameter values, see “Set Block Parameter Values” on page 35-2.

- Learn how to visualize simulation output.

To observe simulation output in real time while you tune block parameter values, you can use blocks in a model such as the Scope block. You can also capture simulation output at the end of a simulation run, and view the data in the Simulation Data Inspector. For more information, see “Decide How to Visualize Simulation Data” on page 28-2.

- Consider specifying value ranges for block parameters that you expect to tune during simulation.

If you expect another person to use your model and tune the parameter, you can control the allowed tuning values by specifying a range. Also, it is a best practice to specify value ranges for all fixed-point block parameters that you expect to tune. To specify block parameter value ranges, see “Specify Minimum and Maximum Values for Block Parameters” on page 35-66.

- Learn how to control simulation duration and pace.

A simulation run can execute so quickly that you cannot tune block parameter values. Also, if you want to change a parameter value at a specific simulation time, you must learn to control the simulation pace. You can configure the simulation to run for a specific duration or to run forever, and pause and advance the simulation when you want to. For more information about controlling simulation execution, see “Simulate a Model Interactively” on page 23-2. To programmatically control simulations, see “Control Simulations Programmatically” on page 24-8.

## **Interactively Tune Using Dashboard Blocks**

You can tune block parameter values by adding blocks from the Dashboard library to your model. Dashboard blocks allow you to adjust the parameter values of other blocks, and to observe simulation output in real time, by interacting with knobs, switches, and readouts that mimic the appearance of industrial controls. You can interact with the Dashboard blocks without having to locate the target block parameters in the model. For more information, see “Tune and Visualize Your Model with Dashboard Blocks” on page 27-65.

## Which Block Parameters Are Tunable During Simulation?

*Nontunable block parameters* are parameters whose values you cannot change during simulation. For example, you cannot tune the **Sample time** block parameter. If a parameter is nontunable, you cannot change its value during simulation by changing the value in the block dialog box or by changing the value of a workspace variable.

Nontunable block parameters include:

- Sample times.
- Parameters that control the appearance or structure of a block such as the number of inputs of a Sum block.
- Priority, which allows you to control block execution order.
- Parameters that control the block algorithm, such as the **Integrator method** parameter of a Discrete-Time Integrator block.

To determine whether a block parameter is tunable during simulation, use one of these techniques:

- Begin a simulation and open the block dialog box. If the value of the target block parameter is gray during simulation, you cannot tune the parameter.
- At the command prompt, determine whether the flags `read-write` and `read-only-if-compiled` describe the parameter.

1 Select the block in the model.

2 At the command prompt, use the function `get_param` to return information about the block dialog box parameters. The function returns a structure that has a field for each parameter in the block dialog box.

```
paramInfo = get_param(gcb, 'DialogParameters');
```

Alternatively, rather than locating and selecting the block in the model, you can replace `gcb` with the block path, such as `'myModel/mySubsystem/myBlock'`.

3 View the information about the target block parameter. For example, to view the information about the **Sample time** parameter of a block, view the value of the field `SampleTime`, which is also a structure.

```
paramInfo.SampleTime
```

```
ans =
```

```
Prompt: 'Sample time:'  
Type: 'string'  
Enum: {}  
Attributes: {'read-write' 'read-only-if-compiled' 'dont-eval'}
```

- 4 Inspect the structure's `Attributes` field, whose value is a cell array of character vectors. If the flag `read-write` appears in the cell array, you can modify the parameter value. However, if the flag `read-only-if-compiled` also appears in the cell array, you cannot modify the parameter value during simulation.

If you use masks to create custom interfaces for blocks and subsystems, you can control the tunability of individual mask parameters. If you use model arguments to parameterize referenced models, you can tune the value of each model argument in each Model block.

## Why Did the Simulation Output Stay the Same?

If the output of your simulation does not change after you change a parameter value, use these troubleshooting techniques:

- Locate the definition of a workspace variable.

If you use a workspace variable to set block parameter values, determine where the variable definition resides. For example, if you define a variable `myVar` in a model workspace and use it to set a block parameter value in the model, you cannot change the parameter value by changing the value of a variable named `myVar` in the base workspace. You must access the variable definition in the model workspace.

To locate the definition of a variable, open a block dialog box that uses the variable.

Click the button  next to the block parameter value and select **Explore Variable**. A dialog box opens, such as the Model Explorer, which displays the definition of the variable in the appropriate workspace. For more information about how models use variables, see “Symbol Resolution” on page 57-118.

- Specify value ranges for fixed-point parameters that you want to tune during simulation.

If the block parameter you want to tune uses a fixed-point data type with best-precision scaling, specify a minimum and maximum value for the parameter so that Simulink can calculate and apply an appropriate scaling. If you do not specify a value range, Simulink might apply a scaling that excludes the tuning values that you want



to use. To specify value ranges, see “Specify Minimum and Maximum Values for Block Parameters” on page 35-66.

- Update the model diagram during a simulation run. If you use a workspace variable to set the value of one or more block parameters, after you change the value of the variable during a simulation, you must update the model diagram.

To learn how to update a model diagram, see “Update Diagram and Run Simulation” on page 1-65.

## Tunability Considerations for Other Modeling Goals

### Rapid Accelerator Simulations

If a block parameter value references workspace variables, you cannot change the block parameter value during rapid accelerator simulation, such as by using the function `set_param`. Instead, you can tune the values of the referenced variables.

Alternatively, use parameter sets to tune runtime parameters in between rapid accelerator simulations. For more information, see “Tuning Runtime Parameters” on page 33-10.

### Code Generation and Simulation of External Programs

Parameters that are tunable during simulation can appear as nontunable inlined parameters in the generated code. If you simulate an external program by using SIL, PIL, or External mode simulation, parameter tunability during the simulation can depend on your code generation settings.

To control parameter tunability in the generated code, you can adjust the code generation settings for a model by using the configuration parameter **Default parameter behavior**. You can also adjust settings for individual MATLAB variables, `Simulink.Parameter` objects, and other parameter objects. For more information, see “Configure Block Parameter Tunability for Rapid Prototyping” (Simulink Coder).

### Stateflow Charts

To debug a Stateflow chart by changing data during simulation, see “Change Data Values During Simulation” (Stateflow).

## See Also

`set_param`

## **Related Examples**

- “Specify Minimum and Maximum Values for Block Parameters” on page 35-66
- “Parameter Tuning in Rapid Accelerator Mode” on page 33-9
- “Manage Variables from Block Parameters” on page 35-47
- “Switch Between Sets of Parameter Values During Simulation and Code Execution” on page 35-71

## Manage Variables from Block Parameters

To set the value of a block parameter, such as the **Gain** parameter of a Gain block, you can create a MATLAB variable, `Simulink.Parameter` object, or other parameter object in a workspace. See “Share and Reuse Block Parameter Values by Creating Variables” on page 35-11.

To create and edit variables from a block dialog box, the Property Inspector, the Model Data Editor, or the Model Explorer, click the button  next to the value of the block parameter. Use this technique to configure the variable without having to find its definition or open additional dialog boxes such as Model Explorer manually.

### Rename Variable

This example shows how to rename a variable by navigating to Model Explorer from a parameter in a block dialog box.

- 1 Open the model `f14`. The model loads data to the MATLAB base workspace.
- 2 Open the block dialog box for the Gain block that uses variable `MW`.
- 3 Click the button  next to the value of the **Gain** parameter. Select **Explore Variable**.

Model Explorer opens with `MW` as the selected variable in the base workspace.

- 4 In Model Explorer, right-click the variable `MW` and select **Rename All**.
- 5 In the **Select a system** dialog box, click the name of the model `f14` to select it as the context for renaming the variable `MW`.
- 6 Clear the **Search in referenced models** check box, since `f14` does not reference any models, and click **OK**.

With **Search in referenced models** selected, you can rename the target variable everywhere it is used in a model reference hierarchy. However, renaming the target variable in an entire hierarchy can take more time.

The **Update diagram to include recent changes** check box is cleared by default to save time by avoiding unnecessary model diagram updates. Select the check box to incorporate recent changes you made to the model by forcing a diagram update.

- 7 Click **OK** when asked to update the model diagram.

Since you just opened the model, you must update the model diagram at least once before renaming a variable. You could have selected **Update diagram to include recent changes** in the **Select a system** dialog box to force an initial diagram update, though you typically use that option when you make changes to the model while performing multiple variable renaming operations.

- 8 In the **Rename All** dialog box, type the new name for the variable in the **New name** box and click **OK**.
- 9 In the block dialog, click **OK** to accept the change to the block parameter.

## Edit Variable Value or Property

This example shows how to edit a variable from a parameter in a block dialog box. You can use this procedure to edit a variable made from a built-in or custom data type or from a class such as `Simulink.Parameter`.

- 1 Open the model `f14`. The model loads data to the MATLAB base workspace.
- 2 Open the block dialog box for the Gain block that uses the variable `Mw`.
- 3 Click the button  next to the value of the **Gain** parameter. Select **Open Variable**.
- 4 In the **Data properties** dialog box, type a new value for the variable in the **Value** box and click **OK**.

## Navigate to Mask Parameter

This example shows how to navigate to a mask parameter from a parameter in a block dialog box. When you explore a model that contains multiple masked subsystems and masked blocks, you can find the mask that defines a particular parameter.

- 1 Open the model `masking_example`.
- 2 Open the block dialog box for the Gain block that uses the mask parameter `m`.
- 3 Click the button  next to the value of the **Gain** parameter and select **Open Variable**.

The mask dialog box that contains the mask parameter `m` appears.

## Create Variable

This example shows how to create a variable from a parameter in a block dialog box.

- 1 Open the model `sldemo_fuelsys`.
- 2 Open the Throttle Command block dialog box.
- 3 In the **Output values** box, replace the expression `[ 10 20 10]` with `throtCmd`.
- 4 Click the button  next to the value of the **Output values** parameter. Select **Create Variable**.
- 5 In the **Create New Data** dialog box, type `[ 10 20 10]` in the **Value** box and click **Create**.

In the **Create New Data** dialog box you can choose the workspace to define the new variable. If a model is linked to a data dictionary, you can choose to create a variable in the dictionary.

- 6 In the **Data properties** dialog box, click **OK**.

## Related Examples

- “Share and Reuse Block Parameter Values by Creating Variables” on page 35-11
- “Tune and Experiment with Block Parameter Values” on page 35-38

## Optimize, Estimate, and Sweep Block Parameter Values

When you *sweep* one or more parameters, you change their values between simulation runs, and compare and analyze the output signal data from each run. Use parameter sweeping to tune control parameters, estimate unknown model parameters, and test the robustness of a control algorithm by taking into consideration uncertainty in the real-world system.

You can sweep block parameter values or the values of workspace variables that you use to set the parameter values. Use block dialog boxes, the Model Explorer, the command prompt, or scripts to change parameter values and execute simulations.

If you want to repeatedly change the value of a block parameter, creating a variable in a workspace. You can use the Model Explorer or programmatic commands to change the value of the variable instead of locating or identifying the block in the model. Also, several features and products that facilitate parameter optimization, estimation, and sweeping require that you set block parameter values by creating workspace variables.

To learn how to manipulate parameter values during the iterative process of creating a model, see “Tune and Experiment with Block Parameter Values” on page 35-38.

For basic information about accessing and setting block parameter values as you design a model, see “Set Block Parameter Values” on page 35-2. For basic information about programmatically simulating a model, such as by using a script, see “Run Simulations Programmatically” on page 24-2.

### Sweep Parameter Value and Inspect Simulation Results

This example shows how to change a block parameter value between multiple programmatic simulation runs. Use this technique to determine an optimal parameter value by comparing the output signal data of each run.

The example model `sldemo_absbrake` uses a Constant block to specify a slip setpoint for an anti-lock braking system. Simulate the model with two different slip setpoint values, 0.24 and 0.25, and compare the output wheel speed of each simulation run.

To store the setpoint value, create a variable in the base workspace. This technique enables you to assign a meaningful name to the value.

Open the example model.

```
open_system('sldemo_absbrake');
```

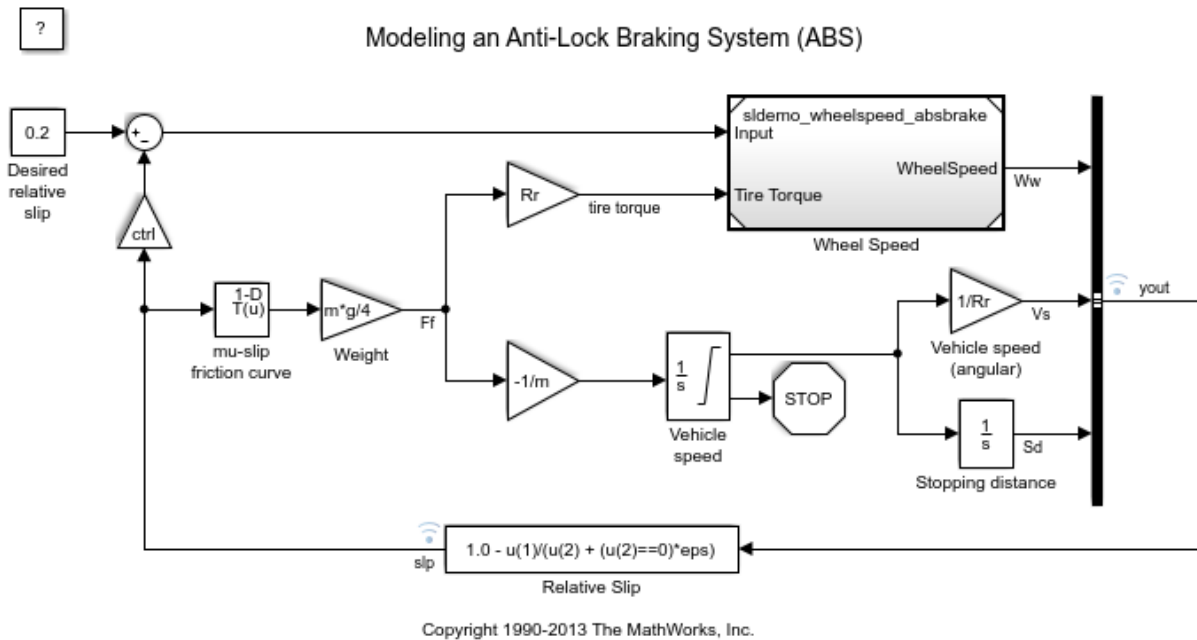

The signals `yout` (which is a virtual bus) and `slip` are configured for logging. When you simulate the model, you can collect and later inspect the values of these signals by using the Simulation Data Inspector.

In the block dialog box of the Constant block labeled `Desired relative slip`, set **Constant value** to `relSlip` and click **Apply**.

Click the action button next to the value of the **Constant value** parameter. Select **Create Variable**.

In the Create New Data dialog box, set **Value** to `0.2` and click **Create**. A variable, whose value is `0.2`, appears in the base workspace.

Alternatively, you can use these commands at the command prompt to create the variable and configure the block:

```
relSlip = 0.2;
```

```
set_param('sldemo_absbrake/Desired relative slip','Value','relSlip')
```

In the `relSlip` property dialog box, click **OK**.

At the command prompt, create an array to store the two experimentation values for the relative slip setpoint, 0.24 and 0.25.

```
relSlip_vals = [0.24 0.25];
```

Create a `Simulink.SimulationInput` object for each simulation that you want to run (in this case, two). Store the objects in a single array variable, `simIn`. Use the `setVariable` method of each object to identify each of the two experimentation values.

```
for i = 1:length(relSlip_vals)
    simIn(i) = Simulink.SimulationInput('sldemo_absbrake');
    setVariable(simIn(i), 'relSlip', relSlip_vals(i));
end
```

Use the `sim` function to simulate the model. Optionally, store the output in a variable named `simOutputs`.

```
simOutputs = sim(simIn);
```

```
Running simulations...
Completed 1 of 2 simulation runs
Completed 2 of 2 simulation runs
```

The model streams the logged signals, `yout` and `slp`, to the Simulation Data Inspector. You can view the signal data in the Simulation Data Inspector.

Compare the output data of the two latest simulation runs.

```
runIDs = Simulink.sdi.getAllRunIDs();
runResult = Simulink.sdi.compareRuns(runIDs(end-1), runIDs(end));
```

Plot the difference between the values of the `Ww` signal (which is an element of the virtual bus signal `yout`) by specifying the result index 1.

```
signalResult = getResultByIndex(runResult,1);
plot(signalResult.Diff);
```



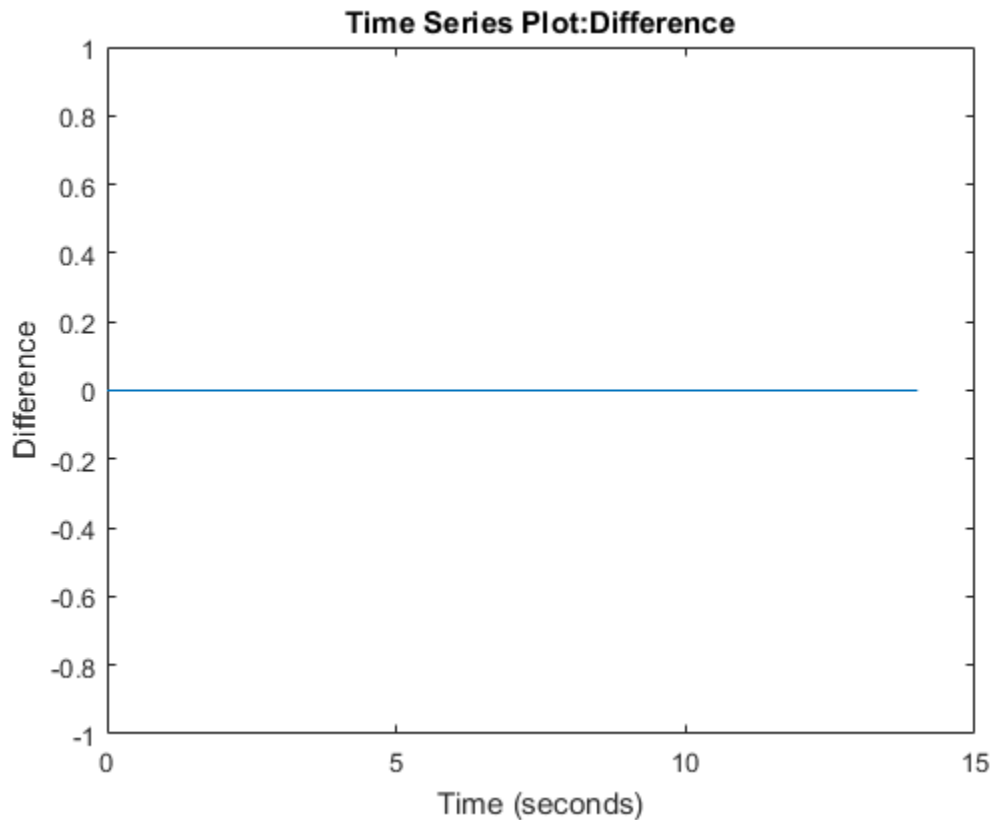

## Store Sweep Values in `Simulink.SimulationInput` Objects

When you write a script to run many simulations, create an array of `Simulink.SimulationInput` objects (one object for each simulation that you want to run). Use the `setVariable` and `setBlockParameter` methods of each object to identify the parameter values to use for the corresponding simulation run. With this technique, you avoid having to use the `set_param` function to modify block parameter values and assignment commands to modify workspace variable values between simulation runs.

For more information about using `Simulink.SimulationInput` objects to run multiple simulations, see `sim`.

### Sweep Nonscalars, Structures, and Parameter Objects

If you use nonscalar variables, structure variables, or `Simulink.Parameter` objects to set block parameter values, use the `setVariable` method of each `Simulink.SimulationInput` object. Refer to the examples in the table.

Scenario	Example
MATLAB variable, <code>myArray</code> , whose value is an array. You want to set the third element in the array (assuming one-based indexing).	<code>setVariable(simIn, 'myArray(3)', 15.23)</code>
MATLAB variable, <code>myStruct</code> , that has a field named <code>field1</code> .	<code>setVariable(simIn, 'myStruct.field1', 15.23)</code>
Parameter object, <code>myParam</code> , whose <code>Value</code> property is a scalar.	<code>setVariable(simIn, 'myParam.Value', 15.23)</code>
Parameter object, <code>myArrayParam</code> , whose <code>Value</code> property is an array. You want to set the third element in the array.	<code>setVariable(simIn, 'myArrayParam.Value(3)', 15.23)</code>
Parameter object, <code>myStructParam</code> , whose <code>Value</code> property is a structure. The structure has a field named <code>field1</code> .	<code>setVariable(simIn, 'myStructParam.Value.field1', 15.23)</code>

### Sweep Value of Variable in Model Workspace

If you use the model workspace to store variables, when you use the `setVariable` method of a `Simulink.SimulationInput` object to modify the variable value, use the `Workspace` pair argument to identify the containing model:

```
setVariable(simIn, 'myVar', 15.23, 'Workspace', 'myModel')
```

### Capture and Visualize Simulation Results

Each simulation run during a parameter sweep produces outputs, such as signal values from Output blocks and from logged signals.

You can capture these outputs in variables and objects for later analysis. For more information, see “Export Simulation Data” on page 59-4.

To visualize simulation output data so you can compare the effect of each parameter value, see “Decide How to Visualize Simulation Data” on page 28-2.

## Improve Simulation Speed

To perform many simulations that each use different parameter values, you can use accelerated simulation modes. For larger models, accelerated simulations take less time to execute than normal simulations. If you also have Parallel Computing Toolbox, you can use the multiple cores of your processor to simultaneously execute simulations. Use arguments of the `sim` function to specify the simulation mode and to specify parallel execution.

To improve the simulation speed of your model by using accelerated simulations and other techniques, see “Performance”. For examples and more information, see “Run Multiple Simulations” on page 25-2.

## Sweep Parameter Values to Test and Verify System

If you have Simulink Test, you can confirm that your model still meets requirements when you use different parameter values. Parameter overrides and test iterations enable you to set different parameter values for each test case. For more information, see “Parameter Overrides” (Simulink Test) and “Run Multiple Combinations of Tests Using Iterations” (Simulink Test).

## Estimate and Calibrate Model Parameters

If you have Simulink Design Optimization, you can estimate model parameter values so that simulation outputs closely fit the data that you measure in the real world. Use this technique to estimate the real-world values of parameters in a *plant model*, which represents the dynamics of a real-world system, when you cannot directly measure the values. This estimation improves the accuracy of the plant model. For more information, see “Estimate Parameters from Measured Data” (Simulink Design Optimization).

## **Tune and Optimize PID and Controller Parameters**

If you have Simulink Control Design, you can use PID Tuner to tune the parameters of a PID Controller block. For more information, see “PID Controller Tuning in Simulink” (Simulink Control Design).

If you have Simulink Design Optimization, you can optimize control parameter values so that simulation outputs meet response requirements that you specify. For more information, see “Design Optimization to Meet Step Response Requirements (GUI)” (Simulink Design Optimization).

## **Related Examples**

- “Data Objects” on page 57-59
- “Specify Minimum and Maximum Values for Block Parameters” on page 35-66
- “Sweep Variant Control Using Parallel Simulation” on page 24-23
- “Switch Between Sets of Parameter Values During Simulation and Code Execution” on page 35-71

## Control Block Parameter Data Types

A block parameter, such as the **Gain** parameter of a Gain block, has a data type in the same way that a signal has a data type (see “Control Signal Data Types” on page 57-8). MATLAB variables, `Simulink.Parameter` objects, and other parameter objects that you use to set block parameter values also have data types. Control block parameter data types to:

- Accurately simulate the execution of your control algorithm on hardware.
- Generate efficient code.
- Integrate the generated code with your custom code.
- Avoid using data types that your target hardware does not support.

### Reduce Maintenance Effort with Data Type Inheritance

By default, block parameters, numeric MATLAB variables that use the data type `double`, and `Simulink.Parameter` objects acquire a data type through inherited and context-sensitive data typing. For example, if the input and output signals of a Gain block use the data type `single`, the **Gain** parameter typically uses the same data type. If you use a `Simulink.Parameter` object to set the value of the block parameter, by default, the object uses the same data type as the parameter. You can take advantage of this inheritance to avoid explicitly specifying data types for parameters.

Some inheritance rules choose a parameter data type other than the data type that the corresponding signals use. For example, suppose that:

- The input and output signals of a Gain block use fixed-point data types with binary-point-only scaling.
- On the **Parameter Attributes** tab, **Parameter data type** is set to `Inherit: Inherit via internal rule` (the default).
- On the **Parameter Attributes** tab, you specify a minimum and maximum value for the parameter by using **Parameter minimum** and **Parameter maximum**.

The data type setting `Inherit: Inherit via internal rule` can cause the block to choose a different data type, with a different word length or scaling, than the data type that the signals use. The minimum and maximum values that you specified for the parameter influence the scaling that the block chooses.

When you select internal rules (`Inherit: Inherit via internal rule`) to enable Simulink to choose data types, before simulating or generating code, configure the

characteristics of your target hardware. The internal rules can use these settings to choose data types that yield efficient generated code. To configure your hardware characteristics, see “Run on Target Hardware Pane”.

### Context-Sensitive Data Typing

When you use a MATLAB variable or `Simulink.Parameter` object to set the value of a block parameter, you can configure the variable or parameter object to use *context-sensitive* data typing. When you simulate or generate code, the variable or parameter object uses the same data type as the block parameter. With this technique, you can match the data type of the variable or parameter object with the data type of the block parameter. To control the data type of the block parameter and the variable or object, you specify only the data type of the block parameter.

To use context-sensitive data typing, set the value of a MATLAB variable to a `double` value. For a `Simulink.Parameter` object, set the `Value` property by using a `double` value and set the `DataType` property to `auto` (the default).

### Techniques to Explicitly Specify Parameter Data Types

Many blocks supported for discrete-time simulation and code generation (such as those in the built-in Discrete library) enable you to explicitly specify parameter data types. For example, in an **n-D Lookup Table** block dialog box, on the **Data Types** tab, you can specify a data type for the lookup table data by using the **Table data** parameter. In a Gain block dialog box, use the **Parameter Attributes** tab to set **Parameter data type**, which controls the data type of the **Gain** parameter.

Some blocks, such as those in the Continuous library, do not enable you to specify parameter data types. These block parameters use internal rules to choose a data type. To indirectly control the data type of such a parameter, apply the data type to a `Simulink.Parameter` object instead.

When you use a `Simulink.Parameter` object or other parameter object to set the value of a block parameter, you can use the `DataType` property of the object to specify a data type.

If you use model arguments, you can specify a data type:

- For the model argument that you store in the model workspace.
- With some blocks (such as those in the Discrete library), for the block parameter that uses the model argument.

- For the argument value that you specify in a Model block.

The default settings for these data types typically use inheritance and context-sensitive data typing. For example, the default value of the `DataType` property of a `Simulink.Parameter` object is `auto`, which causes the parameter object to acquire a data type from the block parameter or parameters that use the object.

To explicitly specify a data type, you can use the Data Type Assistant in block dialog boxes and property dialog boxes. For information about the Data Type Assistant, see “Specify Data Types Using Data Type Assistant” on page 57-45.

## Calculate Best-Precision Fixed-Point Scaling for Tunable Block Parameters

When you apply fixed-point data types to a model, you can use the Data Type Assistant and the Fixed-Point Tool to calculate best-precision scaling for tunable block parameters. A block parameter, `Simulink.Parameter` object, or other parameter object is *tunable* if it appears in the generated code as a variable stored in memory.

The chosen scaling must accommodate the range of values that you expect to assign to the parameter. To enable the tools to calculate an appropriate scaling, specify the range information in the block or in a parameter object. Then, use one of these techniques to calculate the scaling:

- Use the Fixed-Point Tool to autoscale the entire model or subsystem. The tool can propose and apply fixed-point data types for data items including block parameters, `Simulink.Parameter` objects, signals, and states.
- Configure individual block parameters or parameter objects to calculate their own scaling.

When you later change value ranges for parameters, this technique enables you or the model to recalculate the scaling without having to autoscale the entire model. However, if changing the value range of the parameter also changes the value range of an associated signal, you must manually calculate and apply a new scaling for the signal or use the Fixed-Point Tool to autoscale the model or subsystem.

For basic information about fixed-point data types, block parameters, and other tools and concepts, use the information in the table.

Topic	More Information
Fixed-point data types and scaling	“Fixed-Point Numbers in Simulink” (Fixed-Point Designer)

Topic	More Information
How to specify value range information for block parameters and parameter objects	“Specify Minimum and Maximum Values for Block Parameters” on page 35-66
How to use the Data Type Assistant	“Specify Data Types Using Data Type Assistant” on page 57-45
Tunability and block parameter representation in the generated code	“Block Parameter Representation in the Generated Code” (Simulink Coder)

- “Autoscale Entire Model by Using the Fixed-Point Tool” on page 35-60
- “Calculate Best-Precision Scaling for Individual Parameters” on page 35-61

### Autoscale Entire Model by Using the Fixed-Point Tool

You can use the Fixed-Point Tool to autoscale data items in your model, including tunable parameters and signals whose values depend on those parameters. If you use this technique:

- To configure parameters as tunable, use parameter objects (for example, `Simulink.Parameter`) instead of the Model Parameter Configuration dialog box. The Fixed-Point Tool can autoscale parameter objects, but cannot autoscale numeric variables that you select through the Model Parameter Configuration dialog box.

If your model already uses the Model Parameter Configuration dialog box, use the `tunablevars2parameterobjects` function to create parameter objects instead.

- When you use `Simulink.Parameter` objects to set block parameter values, specify the value range information in the objects instead of the blocks. The Fixed-Point Tool uses the range information in each object to propose a data type for that object.
- To enable the tool to autoscale parameter values that you store as fields of a structure, use a `Simulink.Bus` object as the data type of the entire structure. Specify the range information for each field by using the `Min` and `Max` properties of the corresponding element in the bus object. The tool can then apply a data type to each element by using the `DataType` property.

To use a bus object as the data type of a parameter structure, see “Control Field Data Types and Characteristics by Creating Parameter Object” on page 35-24.

- Before you apply the data types that the Fixed-Point Tool proposes, clear the proposals for parameters and parameter objects whose data types you do not want the tool to change. For example, clear the proposals for these entities:



- Parameter objects that you import into the generated code from your own handwritten code by applying a storage class such as `ImportedExtern`.
- `Simulink.Parameter` model arguments in a model workspace.

Alternatively, before autoscaling the model, consider replacing these parameter objects with numeric MATLAB variables to prevent the Fixed-Point Tool from autoscaling them.

Allowing the tool to autoscale model arguments can increase the risk of unintentional data type mismatches between the model argument values (which you specify in Model blocks in a parent model), the model arguments in the model workspace, and the client block parameters in the model.

- Parameter objects whose `DataType` property is set to `auto` (context-sensitive). Clear the proposals if you want the parameter objects to continue to use context-sensitive data typing.

For more information about using the Fixed-Point Tool to autoscale `Simulink.Parameter` objects, see “Autoscale Simulink.Parameter Objects” (Fixed-Point Designer).

### Calculate Best-Precision Scaling for Individual Parameters

You can configure a block parameter or `Simulink.Parameter` object to calculate its own best-precision scaling. First, specify value range information for the target parameter or parameter object. Then, use the Data Type Assistant or the function `fixdt` to apply a data type to the parameter or object. Use these techniques when you do not want to use the Fixed-Point Tool to autoscale the model.

#### Enable Block Parameter to Automatically Calculate Best-Precision Scaling

You can enable the parameters of some blocks (typically blocks in the Discrete library) to automatically calculate best-precision fixed-point scaling. Use this technique to store the range and data type information in the model instead of a parameter object. When you use this technique, if you later change the range information, the block parameter automatically recalculates best-precision scaling.

In the block dialog box, use the function `fixdt` to specify a fixed-point data type with unspecified scaling. For example, use best-precision scaling for lookup table data, and store the data in a 16-bit word:

- 1 On the **Data Types** tab of an n-D Lookup Table block, under the **Minimum** and **Maximum** columns, specify a value range for the elements of the table data.
- 2 Under the **Data Type** column, set the table data type to `fixdt(1,16)`.
- 3 If you use a tunable `Simulink.Parameter` object to set the value of the table data parameter, set the `DataType` property of the object to `auto`. In the generated code, the parameter object uses the same scaling as the block parameter.

When you simulate or generate code, the lookup table data uses a signed 16-bit fixed-point data type whose binary-point scaling depends on the range information that you specify. The calculated scaling allows the fixed-point type to represent values that lie within the range. If you later change the minimum or maximum values, the block recalculates the scaling when you simulate or generate code.

#### Calculate Scaling for Parameter Object

If you use a `Simulink.Parameter` object to set the values of multiple block parameters, and if the block parameters use different data types (including different fixed-point scaling), you cannot set the `DataType` property of the object to `auto` (the default). Instead, you can calculate best-precision fixed-point scaling for the parameter object by specifying range and data type information in the object. You can also use this technique to store range and data type information in a parameter object instead of a block dialog box. When you use this technique, if you later change the range information, you must recalculate the best-precision scaling by using the Data Type Assistant.

Suppose that you create a parameter object to represent the value `15.25`, and that the design range of the value is between `0.00` and `32.00`. To calculate best-precision scaling, use the Data Type Assistant.

- 1 At the command prompt, create a parameter object in the base workspace whose value is `15.25`.  

```
myParam = Simulink.Parameter(15.25);
```
- 2 In the MATLAB Workspace browser, double-click the object `myParam`. The property dialog box opens.
- 3 Specify range information in the object. For example, set **Minimum** to `0.00` and **Maximum** to `32.00`.
- 4 Set **Data type** to `fixdt(0,16,0)`.
- 5 Expand the Data Type Assistant and click **Calculate Best-Precision Scaling**.

The data type changes from `fixdt(0,16,0)` to `fixdt(0,16,10)`.

The calculated scaling (a fraction length of 10 bits) enables the fixed-point data type to represent parameter values that lie within the range that you specified.

If you specify range and data type information in a parameter object, consider removing the range and data type information from the blocks that use the object. Some tools, such as the Fixed-Point Tool, ignore the range information that you specify in the block and use only the information in the parameter object. Removing the information from the block prevents confusion and user errors.

For example, on the **Parameter Attributes** tab of a Gain block dialog box, set **Parameter minimum** and **Parameter maximum** to [ ]. Set **Parameter data type** to an inherited data type such as `Inherit: Inherit from 'Gain'` so that the block parameter uses the same data type as the parameter object.

## Detect Numerical Accuracy Issues Due to Quantization and Overflow

When the data type of a block parameter, MATLAB variable, or parameter object cannot represent the value that you specify, the data type quantizes the value, compromising numerical accuracy. For example, the 32-bit floating-point data type `single` (`float` in C code) cannot exactly represent the parameter value `1.73`. When the real-world value of a data item lies outside the range of values that the data type can represent, overflow can cause loss of information.

To detect these issues, use the diagnostic configuration parameters under **Configuration Parameters > Diagnostics > Data Validity > Parameters**. Set the values of these diagnostic configuration parameters to `warning` or `error`:

- **Detect downcast**
- **Detect precision loss**
- **Detect underflow**
- **Detect overflow**

## Reuse Custom C Data Types for Parameter Data

In a model, you can create parameter data that conform to custom C data types, such as structures, that your existing C code defines. Use these data to:

- Replace existing C code with a Simulink model.
- Integrate C code for simulation in Simulink (for example, by using the Legacy Code Tool).

- Prepare to generate code (Simulink Coder) that you can integrate with existing code.

Use these techniques to match your custom data types:

- For a structure type, create a `Simulink.Bus` object. Use the object as the data type for a structure that you store in a `Simulink.Parameter` object. See “Organize Related Block Parameter Definitions in Structures” on page 35-22.
- For an enumeration, create an enumeration class and use it as the data type for block parameters. See “Use Enumerated Data in Simulink Models” on page 58-7.
- To match a `typedef` statement that represents an alias of a primitive, numeric data type, use a `Simulink.AliasType` object as the data type for block parameters. See `Simulink.AliasType`.

To create these classes and objects, you can use the function `Simulink.importExternalCTypes`.

## Data Types of Mathematical Expressions

If you specify a block parameter using a mathematical expression, the block determines the final parameter data type using a combination of MATLAB and Simulink data typing rules.

Suppose that you define two parameter objects `int8Param` and `doubleParam`, and use the objects to specify the **Constant value** parameter in a Constant block.

```
int8Param = Simulink.Parameter(3);
int8Param.DataType = 'int8';

doubleParam = Simulink.Parameter(9.36);
doubleParam.DataType = 'double';
```

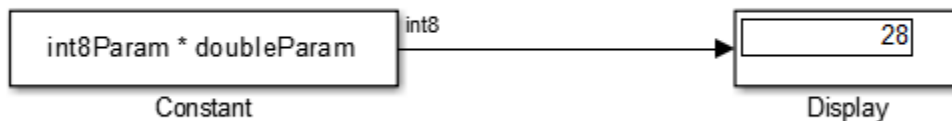

The Constant block determines the data type of the **Constant value** parameter using these steps:

- 1 Each parameter object casts the specified numeric value to the specified data type.

Parameter object	Data type	Numeric value	Result
int8Param	int8	3	int8(3)
doubleParam	double	9.36	double(9.36)

- 2 The block evaluates the specified expression, `int8Param * doubleParam`, using MATLAB rules.

An expression that involves a `double` data type and a different type returns a result of the different type. Therefore, the result of the expression `int8(3) * double(9.36)` is `int8(28)`.

## Block Parameter Data Types in the Generated Code

For more information about controlling parameter data types in the generated code, see “Parameter Data Types in the Generated Code” (Simulink Coder).

### Related Examples

- “Set Block Parameter Values” on page 35-2
- “Specify Minimum and Maximum Values for Block Parameters” on page 35-66
- “Tune and Experiment with Block Parameter Values” on page 35-38
- “Data Validity Diagnostics Overview”

## Specify Minimum and Maximum Values for Block Parameters

You can protect your model design by preventing block parameters from using values outside of a range. For example, if the value of a parameter that represents the angle of an aircraft aileron cannot feasibly exceed a known magnitude, you can specify a design maximum for the parameter in the model.

Fixed-Point Designer enables Simulink to use your range information to calculate best-precision fixed-point scaling for:

- Tunable parameters.
- Signals, by taking into consideration the range of values that you intend to assign to tunable parameters.

For basic information about block parameters, see “Set Block Parameter Values” on page 35-2.

### Specify Block Parameter Value Ranges

To specify a value range for a block parameter, choose a technique based on your modeling goals.

- You can specify value ranges for some block parameters by using other parameters of the same block. For example, you can control the value range of the **Gain** parameter of a Gain block by using the **Parameter minimum** and **Parameter maximum** parameters in the **Parameter Attributes** tab in the block dialog box. For other blocks, such as n-D Lookup Table and PID Controller, use the **Data Types** tab.

Use this technique to:

- Store the range information in the model file.
- Store the range information when you store fixed-point data type information in the block (for example, by setting the **Parameter data type** parameter of a Gain block to a fixed-point type, including best-precision scaling). This technique more clearly associates the range information with the data type information.
- To specify value ranges for the parameters of any block, consider using parameter objects (for example, `Simulink.Parameter`) to set the parameter values. You can specify the range information in the object, instead of the block, by using the **Min** and **Max** properties.

Use this technique to:

- Specify range information for blocks that cannot store minimum or maximum information, for example, many blocks in the Continuous library.
- Specify range information for a single value that you share between multiple block parameters (see “Share and Reuse Block Parameter Values by Creating Variables” on page 35-11). Instead of using a numeric MATLAB variable, use a parameter object so that you can specify the **Min** and **Max** properties.
- Store the range information when you store fixed-point data type information in a parameter object (by setting the **DataType** property to a fixed-point type instead of **auto**). This technique more clearly associates the range information with the data type information.

If you specify the range information in a parameter object, consider removing the range information from the block. For example, on the **Parameter Attributes** tab of a Gain block dialog box, set **Parameter minimum** and **Parameter maximum** to [ ]. Some tools, such as the Fixed-Point Tool, use the range information that you specify in the block only if you do not specify the range information in the parameter object. If you specify the range information in the parameter object, the tools ignore the range information that you specify in the block.

For basic information about creating and using data objects, see “Data Objects” on page 57-59.

### Specify Valid Range Information

Specify a minimum or maximum as an expression that evaluates to a scalar, real number with **double** data type. For example, you can set the **Parameter minimum** parameter of a Gain block by using:

- A literal number such as **98.884**. Implicitly, the data type is **double**.
- A numeric workspace variable (see “Share and Reuse Block Parameter Values by Creating Variables” on page 35-11) whose data type is **double**. Use this technique to share a minimum or maximum value between multiple data items.

However, you cannot use variables to set the **Min** or **Max** properties of a parameter object.

To leave the minimum or maximum of a block parameter or parameter object unspecified, use an empty matrix [ ], which is the default value.

### **Specify Range Information for Nonscalar Parameters**

If the value of a block parameter is a vector or matrix, the range information that you specify applies to each element of the vector or matrix. If the value of any of the elements is outside the specified range, the model generates an error.

If the value of a block parameter is a structure or a field of a structure, specify range information for the structure fields by creating a `Simulink.Parameter` object whose data type is a `Simulink.Bus` object. Specify the range information by using the properties of the signal elements in the bus object. For more information, see “Control Field Data Types and Characteristics by Creating Parameter Object” on page 35-24.

### **Specify Range Information for Complex-Valued Parameters**

If the value of a block parameter is complex (i), the range information that you specify applies separately to the real part and to the imaginary part of the complex number. If the value of either part of the number is outside the range, the model generates an error.

### **Restrict Allowed Values for Block Parameters**

To protect your design by preventing block parameters from using values outside of a range, you can specify the minimum and maximum information by using other parameters of the same block. If you or your users set the value of the target parameter outside the range that you specify, the model generates an error.

Whether a block allows you to specify a value range for a parameter, consider using a parameter object (for example, `Simulink.Parameter`) to set the value of the target parameter. Use the properties of the object to specify the range information. This technique helps you to specify range information for a variable that you use to set multiple block parameter values.

### **Specify Range Information for Tunable Fixed-Point Parameters**

When you use fixed-point data types in your model, you can enable Simulink to choose a best-precision scaling for block parameters and `Simulink.Parameter` objects. If you intend to tune such a parameter by changing its value during simulation or during execution of the generated code, the fixed-point scaling chosen by Simulink must accommodate the range of values that you expect to assign to the parameter.

Also, if you expect to change the value of a parameter, signal data types in the model must accommodate the corresponding expanded range of possible signal values. If you



use the Fixed-Point Tool to propose and apply fixed-point data types for a model, to allow the tool to accurately autoscale the signals, specify range information for tunable parameters.

To specify range information for tunable parameters, see “Calculate Best-Precision Fixed-Point Scaling for Tunable Block Parameters” on page 35-59. To learn how the Fixed-Point Tool autoscales signals by taking into account the value ranges of tunable parameters, see “Derive Ranges for Simulink.Parameter Objects” (Fixed-Point Designer).

## Unexpected Errors or Warnings for Data with Greater Precision or Range than double

When a data item (signal or parameter) uses a data type other than `double`, before comparison, Simulink casts the data item and each design limit (minimum or maximum value that you specify) to the nondouble data type. This technique helps prevent the generation of unnecessary, misleading errors and warnings.

However, Simulink stores design limits as `double` before comparison. If the data type of the data item has higher precision than `double` (for example, a fixed-point data type with a 128-bit word length and a 126-bit fraction length) or greater range than `double`, and `double` cannot exactly represent the value of a design limit, Simulink can generate unexpected warnings and errors.

If the nondouble type has higher precision, consider rounding the design limit to the next number furthest from zero that `double` can represent. For example, suppose that a signal generates an error after you set the maximum value to `98.8847692348509014`. At the command prompt, calculate the next number furthest from zero that `double` can represent.

```
format long
98.8847692348509014 + eps(98.8847692348509014)

ans =

    98.884769234850921
```

Use the resulting number, `98.884769234850921`, to replace the maximum value.

## Optimize Generated Code

If you have Embedded Coder, Simulink Coder can optimize the code that you generate from the model by taking into account the minimum and maximum values that you

specify for signals and parameters. This optimization can remove algorithmic code and affect the results of some simulation modes such as SIL or external mode. For more information, see “Optimize using the specified minimum and maximum values”.

### **Related Examples**

- “Control Block Parameter Data Types” on page 35-57
- “Tune and Experiment with Block Parameter Values” on page 35-38

## Switch Between Sets of Parameter Values During Simulation and Code Execution

To store multiple independent sets of values for the same block parameters, you can use an array of structures. To switch between the parameter sets, create a variable that acts as an index into the array, and change the value of the variable. You can change the value of the variable during simulation and, if the variable is tunable, during execution of the generated code.

### Explore Example Model

Open this example model:

```
open_system('sldemo_fuelsys_dd_controller')
```

### Fuel Rate Controller

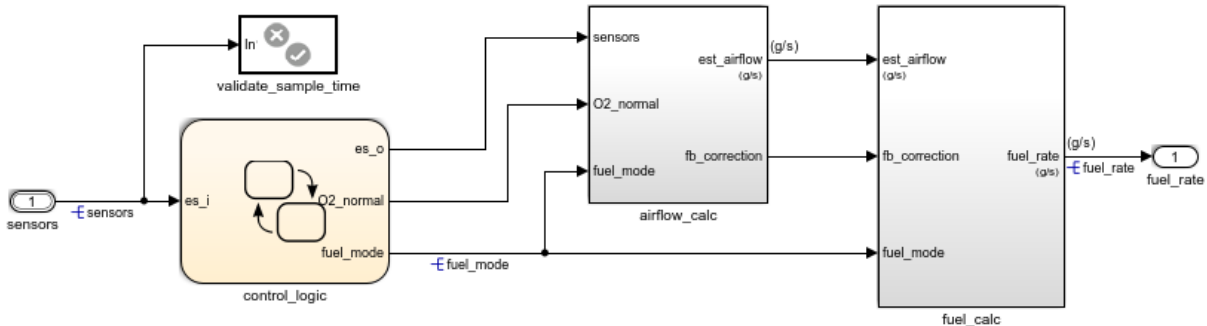

Copyright 1990-2015 The MathWorks, Inc.

This model represents the fueling system of a gasoline engine. The output of the model is the rate of fuel flow to the engine.

Navigate to the `switchable_compensation` nested subsystem.

```
open_system(['sldemo_fuelsys_dd_controller/fuel_calc/', ...
            'switchable_compensation'])
```

## Loop Compensation and Filtering

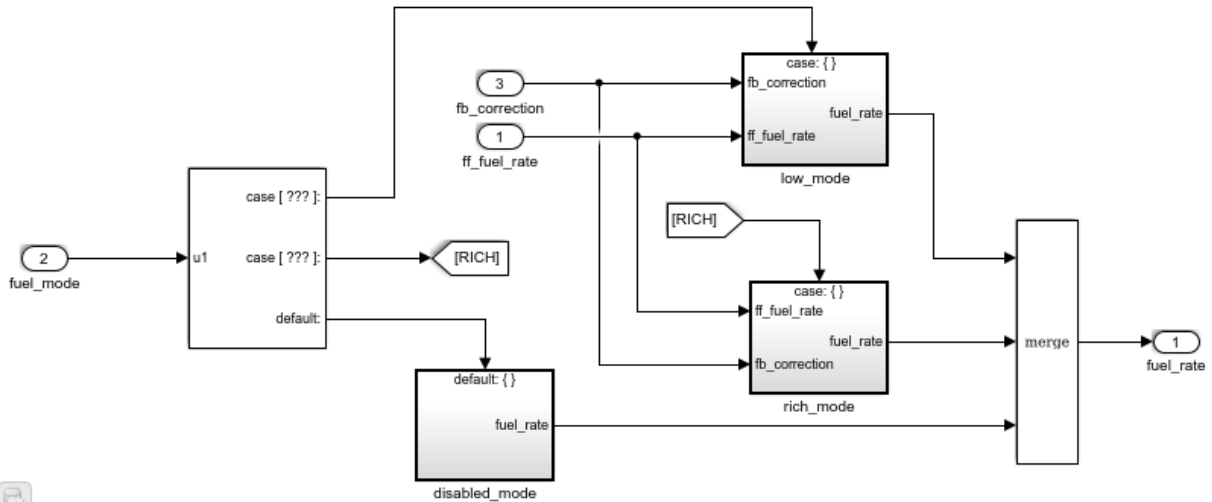

This subsystem corrects and filters noise out of the fuel rate signal. The subsystem uses different filter coefficients based on the fueling mode, which the control logic changes based on sensor failures in the engine. For example, the control algorithm activates the `low_mode` subsystem during normal operation. It activates the `rich_mode` subsystem in response to sensor failure.

Open the `low_mode` subsystem.

```
open_system(['sldemo_fuelsys_dd_controller/fuel_calc/',...
            'switchable_compensation/low_mode'])
```

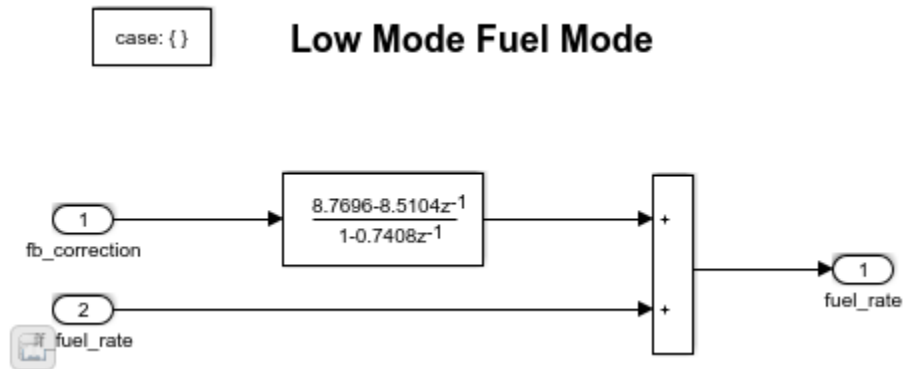

The Discrete Filter block filters the fuel rate signal. In the block dialog box, the **Numerator** parameter sets the numerator coefficients of the filter.

The sibling subsystem `rich_mode` also contains a Discrete Filter block, which uses different coefficients.

Update the model diagram to display the signal data types. The input and output signals of the block use the single-precision, floating-point data type `single`.

In the lower-left corner of the model, click the data dictionary badge. The data dictionary for this model, `sldemo_fuelsys_dd_controller.sldd`, opens in the Model Explorer.

In the **Contents** pane, view the properties of the `Simulink.NumericType` objects, such as `s16En15`. All of these objects currently represent the single-precision, floating-point data type `single`. The model uses these objects to set signal data types, including the input and output signals of the Discrete Filter blocks.

Suppose that during simulation and execution of the generated code, you want each of these subsystems to switch between different numerator coefficients based on a variable whose value you control.

### Store Parameter Values in Array of Structures

Store the existing set of numerator coefficients in a `Simulink.Parameter` object whose value is a structure. Each field of the structure stores the coefficients for one of the Discrete Filter blocks.

```
lowBlock = ['sldemo_fuelsys_dd_controller/fuel_calc/'...
            'switchable_compensation/low_mode/Discrete Filter'];
```

```
richBlock = ['sldemo_fuelsys_dd_controller/fuel_calc/'...  
            'switchable_compensation/rich_mode/Discrete Filter'];  
params.lowNumerator = eval(get_param(lowBlock, 'Numerator'));  
params.richNumerator = eval(get_param(richBlock, 'Numerator'));  
params = Simulink.Parameter(params);
```

Copy the value of `params` into a temporary variable. Modify the field values in this temporary structure, and assign the modified structure as the second element of `params`.

```
temp = params.Value;  
temp.lowNumerator = params.Value.lowNumerator * 2;  
temp.richNumerator = params.Value.richNumerator * 2;  
params.Value(2) = temp;  
clear temp
```

The value of `params` is an array of two structures. Each structure stores one set of filter coefficients.

### Create Variable to Switch Between Parameter Sets

Create a `Simulink.Parameter` object named `Ctrl`.

```
Ctrl = Simulink.Parameter(2);  
Ctrl.DataType = 'uint8';
```

In the `low_mode` subsystem, in the Discrete Filter block dialog box, set the **Numerator** parameter to the expression `params(Ctrl).lowNumerator`.

```
set_param(lowBlock, 'Numerator', 'params(Ctrl).lowNumerator');
```

In the Discrete Filter block in the `rich_mode` subsystem, set the value of the **Numerator** parameter to `params(Ctrl).richNumerator`.

```
set_param(richBlock, 'Numerator', 'params(Ctrl).richNumerator');
```

The expressions select one of the structures in `params` by using the variable `Ctrl`. The expressions then dereference one of the fields in the structure. The field value sets the values of the numerator coefficients.

To switch between the sets of coefficients, you change the value of `Ctrl` to the corresponding index in the array of structures.

### Use Bus Object as Data Type of Array of Structures

Optionally, create a `Simulink.BUS` object to use as the data type of the array of structures. You can:

- Control the shape of the structures.
- For each field, control characteristics such as data type and physical units.
- Control the name of the `struct` type in the generated code.

Use the function `Simulink.Bus.createObject` to create the object and rename the object as `paramsType`.

```
Simulink.Bus.createObject(params.Value)
paramsType = slBus1;
clear slBus1
```

You can use the `Simulink.NumericType` objects from the data dictionary to control the data types of the structure fields. In the bus object, use the name of a data type object to set the `DataType` property of each element.

```
paramsType.Elements(1).DataType = 's16En15';
paramsType.Elements(2).DataType = 's16En7';
```

Use the bus object as the data type of the array of structures.

```
params.DataType = 'Bus: paramsType';
```

### Use Enumerated Type for Switching Variable

Optionally, use an enumerated type as the data type of the switching variable. You can associate each of the parameter sets with a meaningful name and restrict the allowed values of the switching variable.

Create an enumerated type named `FilterCoeffs`. Create an enumeration member for each of the structures in `params`. Set the underlying integer value of each enumeration member to the corresponding index in `params`.

```
Simulink.defineIntEnumType('FilterCoeffs',{'Weak','Aggressive'},[1 2])
```

Use the enumerated type as the data type of the switching variable. Set the value of the variable to `Aggressive`, which corresponds to the index 2.

```
Ctrl.Value = FilterCoeffs.Aggressive;
```

### Add New Objects to Data Dictionary

Add the objects that you created to the data dictionary  
`sldemo_fuelsys_dd_controller.slidd`.

```
dictObj = Simulink.data.dictionary.open('sldemo_fuelsys_dd_controller.sldd');
sectObj = getSection(dictObj, 'Design Data');
addEntry(sectObj, 'Ctrl', Ctrl)
addEntry(sectObj, 'params', params)
addEntry(sectObj, 'paramsType', paramsType)
```

You can also store enumerated types in data dictionaries. However, you cannot import the enumerated type in this case because you cannot save changes to `sldemo_fuelsys_dd_controller.sldd`. For more information about storing enumerated types in data dictionaries, see “Enumerations in Data Dictionary”.

### Switch Between Parameter Sets During Simulation

Open the example model `sldemo_fuelsys_dd`, which references the controller model `sldemo_fuelsys_dd_controller`.

```
open_system('sldemo_fuelsys_dd')
```

## Fault-Tolerant Fuel Control System

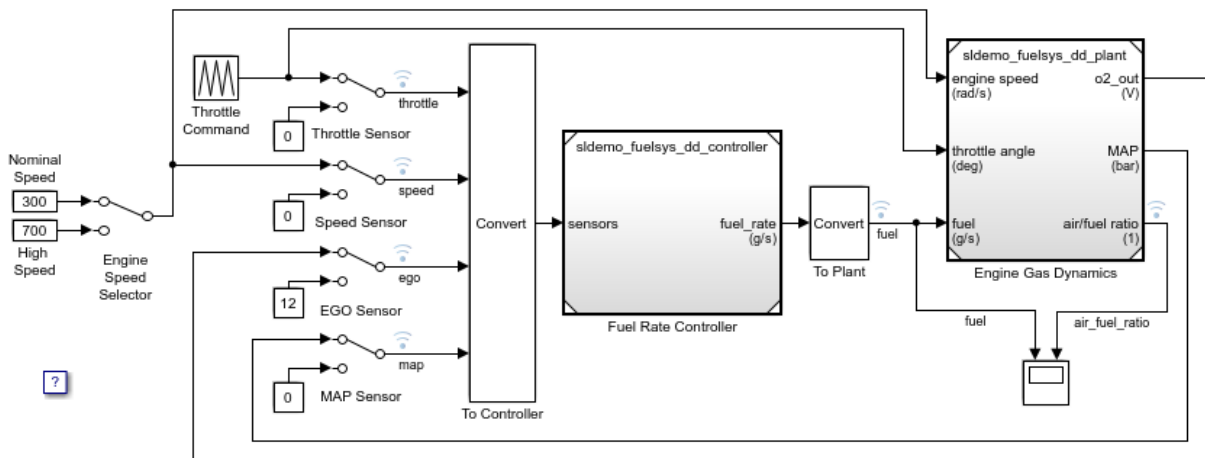

The sensor switches simulate any combination of sensor failures.  
The Engine Speed Selector switch simulates different engine speeds (rad/s).

Copyright 1990-2015 The MathWorks, Inc.

Set the simulation stop time to `Inf` so that you can interact with the model during simulation.



Begin a simulation run and open the Scope block dialog box. The scope shows that the fuel flow rate (the `fuel` signal) oscillates with significant amplitude during normal operation of the engine.

In the Model Explorer, view the contents of the data dictionary `sldemo_fuelsys_dd_controller.sldd`. Set the value of `Ctrl` to `FilterCoeffs.Weak`.

Update the `sldemo_fuelsys_dd` model diagram. The scope shows that the amplitude of the fuel rate oscillations decreases due to the less aggressive filter coefficients.

Stop the simulation.

### Generate and Inspect Code

If you have Simulink Coder software, you can generate code that enables you to switch between the parameter sets during code execution.

In the Model Explorer, view the contents of the data dictionary `sldemo_fuelsys_dd_controller.sldd`. In the **Contents** pane, set **Column View** to **Storage Class**.

Use the **StorageClass** column to apply the storage class `ExportedGlobal` to `params` so that the array of structures appears as a tunable global variable in the generated code. Apply the same storage class to `Ctrl` so that you can change the value of the switching variable during code execution.

Alternatively, to configure the objects, use these commands:

```
tempEntryObj = getEntry(sectObj, 'params');
params = getValue(tempEntryObj);
params.StorageClass = 'ExportedGlobal';
setValue(tempEntryObj, params);

tempEntryObj = getEntry(sectObj, 'Ctrl');
Ctrl = getValue(tempEntryObj);
Ctrl.StorageClass = 'ExportedGlobal';
setValue(tempEntryObj, Ctrl);
```

Generate code from the controller model.

```
rtwbuild('sldemo_fuelsys_dd_controller')

### Starting build procedure for model: sldemo_fuelsys_dd_controller
```

```
### Successful completion of code generation for model: sldemo_fuelsys_dd_controller
```

In the code generation report, view the header file `sldemo_fuelsys_dd_controller_types.h`. The code defines the enumerated data type `FilterCoeffs`.

```
file = fullfile('sldemo_fuelsys_dd_controller_ert_rtw',...
    'sldemo_fuelsys_dd_controller_types.h');
rtwdemodbtype(file, '#ifndef DEFINED_TYPEDEF_FOR_FilterCoeffs_',...
    '/* Forward declaration for rtModel */',1,0)
```

```
#ifndef DEFINED_TYPEDEF_FOR_FilterCoeffs_
#define DEFINED_TYPEDEF_FOR_FilterCoeffs_

typedef enum {
    Weak = 1,                               /* Default value */
    Aggressive
} FilterCoeffs;

#endif
```

The code also defines the structure type `paramType`, which corresponds to the `Simulink.Bus` object. The fields use the single-precision, floating-point data type from the model.

```
rtwdemodbtype(file, '#ifndef DEFINED_TYPEDEF_FOR_paramType_',...
    '#ifndef DEFINED_TYPEDEF_FOR_FilterCoeffs_',1,0)
```

```
#ifndef DEFINED_TYPEDEF_FOR_paramType_
#define DEFINED_TYPEDEF_FOR_paramType_

typedef struct {
    real32_T lowNumerator[2];
    real32_T richNumerator[2];
} paramType;

#endif
```

View the source file `sldemo_fuelsys_dd_controller.c`. The code uses the enumerated type to define the switching variable `Ctrl`.

```
file = fullfile('sldemo_fuelsys_dd_controller_ert_rtw',...
    'sldemo_fuelsys_dd_controller.c');
```

```

rtwdemodbtype(file,'FilterCoeffs Ctrl = Aggressive;',...
  '/* Block signals (auto storage) */',1,0)

FilterCoeffs Ctrl = Aggressive;          /* Variable: Ctrl
                                          * Referenced by:
                                          *   '<S12>/Discrete Filter'
                                          *   '<S13>/Discrete Filter'
                                          */

```

The code also defines the array of structures `params`.

```

rtwdemodbtype(file,'/* Exported block parameters */',...
  '/* Variable: params',1,1)

/* Exported block parameters */
paramsType params[2] = { {
  { 8.7696F, -8.5104F },

  { 0.0F, 0.2592F }
}, { { 17.5392F, -17.0208F },

  { 0.0F, 0.5184F }
} } ;                                     /* Variable: params

```

The code algorithm in the model `step` function uses the switching variable to index into the array of structures.

To switch between the parameter sets stored in the array of structures, change the value of `Ctrl` during code execution.

## Related Examples

- “Tune and Experiment with Block Parameter Values” on page 35-38
- “Block Parameter Representation in the Generated Code” (Simulink Coder)
- “Organize Related Block Parameter Definitions in Structures” on page 35-22
- “Access Structured Data Through a Pointer That External Code Defines” (Embedded Coder)



# Working with Lookup Tables

---

- “About Lookup Table Blocks” on page 36-2
- “Anatomy of a Lookup Table” on page 36-4
- “Lookup Tables Block Library” on page 36-6
- “Guidelines for Choosing a Lookup Table” on page 36-8
- “Enter Breakpoints and Table Data” on page 36-12
- “Characteristics of Lookup Table Data” on page 36-17
- “Methods for Estimating Missing Points” on page 36-22
- “Edit Lookup Tables” on page 36-27
- “Import Lookup Table Data from MATLAB” on page 36-31
- “Import Lookup Table Data from Excel” on page 36-38
- “Create a Logarithm Lookup Table” on page 36-39
- “Prelookup and Interpolation Blocks” on page 36-42
- “Optimize Generated Code for Lookup Table Blocks” on page 36-44
- “Update Lookup Table Blocks to New Versions” on page 36-48
- “Lookup Table Glossary” on page 36-54

## About Lookup Table Blocks

A *lookup table* block uses an array of data to map input values to output values, approximating a mathematical function. Given input values, Simulink performs a “lookup” operation to retrieve the corresponding output values from the table. If the lookup table does not define the input values, the block estimates the output values based on nearby table values.

The following example illustrates a one-dimensional lookup table that approximates the function  $y = x^3$ . The lookup table defines its output ( $y$ ) data discretely over the input ( $x$ ) range  $[-3, 3]$ . The following table and graph illustrate the input/output relationship:

x	-3	-2	-1	0	1	2	3
y	-27	-8	-1	0	1	8	27

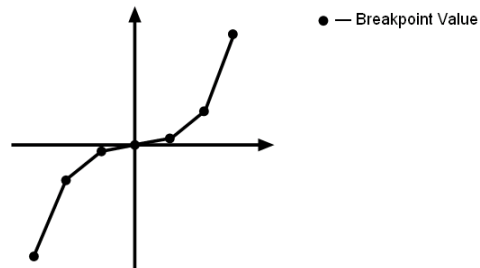

An input of -2 enables the table to look up and retrieve the corresponding output value (-8). Likewise, the lookup table outputs 27 in response to an input of 3.

When the lookup table block encounters an input that does not match any of the table's  $x$  values, it can interpolate or extrapolate the answer. For instance, the lookup table does not define an input value of -1.5; however, the block can linearly interpolate the nearest data points (-2, -8) and (-1, -1) to estimate and return a value of -4.5.

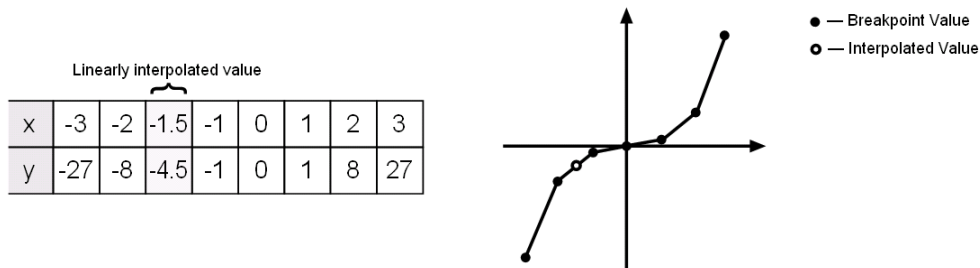

x	-3	-2	-1.5	-1	0	1	2	3
y	-27	-8	-4.5	-1	0	1	8	27

Similarly, although the lookup table does not include data for  $x$  values beyond the range of  $[-3, 3]$ , the block can extrapolate values using a pair of data points at either end

of the table. Given an input value of 4, the lookup table block linearly extrapolates the nearest data points (2, 8) and (3, 27) to estimate an output value of 46.

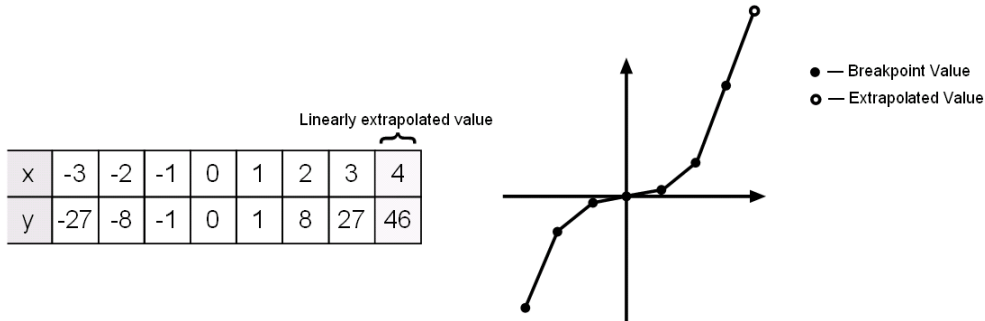

Since table lookups and simple estimations can be faster than mathematical function evaluations, using lookup table blocks might result in speed gains when simulating a model. Consider using lookup tables in lieu of mathematical function evaluations when:

- An analytical expression is expensive to compute.
- No analytical expression exists, but the relationship has been determined empirically.

Simulink provides a broad assortment of lookup table blocks, each geared for a particular type of application. The sections that follow outline the different offerings, suggest how to choose the lookup table best suited to your application, and explain how to interact with the various lookup table blocks.

## More About

- “Anatomy of a Lookup Table” on page 36-4
- “Lookup Tables Block Library” on page 36-6
- “Lookup Table Glossary” on page 36-54

## Anatomy of a Lookup Table

The following figure illustrates the anatomy of a two-dimensional lookup table. Vectors or *breakpoint data sets* and an array, referred to as *table data*, constitute the lookup table.

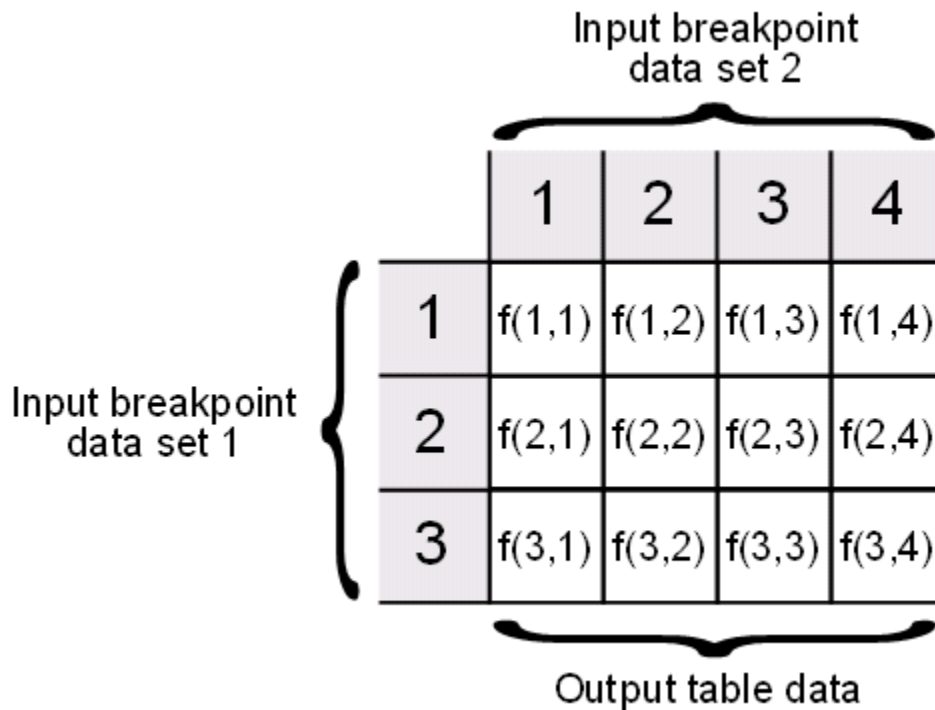

Each breakpoint data set is an index of input values for a particular dimension of the lookup table. The array of table data serves as a sampled representation of a function evaluated at the breakpoint values. Lookup table blocks use breakpoint data sets to relate a table's input values to the output values that it returns.

### More About

- “About Lookup Table Blocks” on page 36-2
- “Lookup Tables Block Library” on page 36-6



- “Lookup Table Glossary” on page 36-54
- “Edit Lookup Tables” on page 36-27

## Lookup Tables Block Library

Several lookup table blocks appear in the Lookup Tables block library.

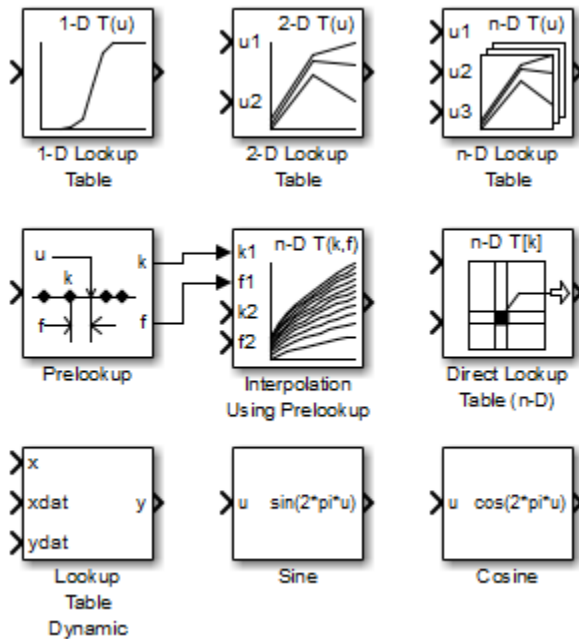

The following table summarizes the purpose of each block in the library.

Block Name	Description
1-D Lookup Table	Approximate a one-dimensional function.
2-D Lookup Table	Approximate a two-dimensional function.
n-D Lookup Table	Approximate an N-dimensional function.
Prelookup	Compute index and fraction for Interpolation Using Prelookup block.
Interpolation Using Prelookup	Use precalculated index and fraction values to accelerate approximation of N-dimensional function.
Direct Lookup Table (n-D)	Index into an N-dimensional table to retrieve the corresponding outputs.

<b>Block Name</b>	<b>Description</b>
Lookup Table Dynamic	Approximate a one-dimensional function using a dynamically specified table.
Sine	Use a fixed-point lookup table to approximate the sine wave function.
Cosine	Use a fixed-point lookup table to approximate the cosine wave function.

## **More About**

- “About Lookup Table Blocks” on page 36-2
- “Anatomy of a Lookup Table” on page 36-4
- “Lookup Table Glossary” on page 36-54
- “Edit Lookup Tables” on page 36-27
- “Guidelines for Choosing a Lookup Table” on page 36-8

## Guidelines for Choosing a Lookup Table

### In this section...

“Data Set Dimensionality” on page 36-8

“Data Set Numeric and Data Types” on page 36-8

“Data Accuracy and Smoothness” on page 36-8

“Dynamics of Table Inputs” on page 36-9

“Efficiency of Performance” on page 36-9

“Summary of Lookup Table Block Features” on page 36-10

### Data Set Dimensionality

In some cases, the dimensions of your data set dictate which of the lookup table blocks is right for your application. If you are approximating a one-dimensional function, consider using either the 1-D Lookup Table or Lookup Table Dynamic block. If you are approximating a two-dimensional function, consider the 2-D Lookup Table block. Blocks such as the n-D Lookup Table and Direct Lookup Table (n-D) allow you to approximate a function of  $N$  variables.

### Data Set Numeric and Data Types

The numeric and data types of your data set influence the decision of which lookup table block is most appropriate. Although all lookup table blocks support real numbers, the Direct Lookup Table (n-D), 1-D Lookup Table, 2-D Lookup Table, and n-D Lookup Table blocks also support complex table data. All lookup table blocks support integer and fixed-point data in addition to double and single data types.

---

**Note:** For the Direct Lookup Table (n-D) block, fixed-point types are supported for the table data, output port, and optional table input port.

---

### Data Accuracy and Smoothness

The desired accuracy and smoothness of the data returned by a lookup table determine which of the blocks you should use. Most blocks provide options to perform interpolation

and extrapolation, improving the accuracy of values that fall between or outside of the table data, respectively. For instance, the Lookup Table Dynamic block performs linear interpolation and extrapolation, while the n-D Lookup Table block performs either linear or cubic spline interpolation and extrapolation. In contrast, the Direct Lookup Table (n-D) block performs table lookups without any interpolation or extrapolation. You can achieve a mix of interpolation and extrapolation methods by using the Prelookup block with the Interpolation Using Prelookup block.

## Dynamics of Table Inputs

The dynamics of the lookup table inputs impact which of the lookup table blocks is ideal for your application. The blocks use a variety of index search methods to relate the lookup table inputs to the table's breakpoint data sets. Most of the lookup table blocks offer a binary search algorithm, which performs well if the inputs change significantly from one time step to the next. The 1-D Lookup Table, 2-D Lookup Table, n-D Lookup Table, and Prelookup blocks offer a linear search algorithm. Using this algorithm with the option that resumes searching from the previous result performs well if the inputs change slowly. Some lookup table blocks also provide a search algorithm that works best for breakpoint data sets composed of evenly spaced breakpoints. You can achieve a mix of index search methods by using the Prelookup block with the Interpolation Using Prelookup block.

## Efficiency of Performance

When the efficiency with which lookup tables operate is important, consider using the Prelookup block with the Interpolation Using Prelookup block. These blocks separate the table lookup process into two components — an index search that relates inputs to the table data, followed by an interpolation and extrapolation stage that computes outputs. These blocks enable you to perform a single index search and then reuse the results to look up data in multiple tables. Also, the Interpolation Using Prelookup block can perform sub-table selection, where the block interpolates a portion of the table data instead of the entire table. For example, if your 3-D table data constitutes a stack of 2-D tables to be interpolated, you can specify a selection port input to select one or more of the 2-D tables from the stack for interpolation. A full 3-D interpolation has 7 sub-interpolations but a 2-D interpolation requires only 3 sub-interpolations. As a result, significant speed improvements are possible when some dimensions of a table are used for data stacking and not intended for interpolation. These features make table lookup operations more efficient, reducing computational effort and simulation time.

## Summary of Lookup Table Block Features

Use the following table to identify features that correspond to particular lookup table blocks, then select the block that best meets your requirements.

Feature	1-D Lookup Table	2-D Lookup Table	Lookup Table Dynamic	n-D Lookup Table	Direct Lookup Table (n-D)	Prelookup	Interp. Using Prelookup
<b>Interpolation Methods</b>							
Flat	•	•	•	•	•	•	•
Linear	•	•	•	•		•	•
Cubic spline	•	•		•			
<b>Extrapolation Methods</b>							
Clip	•	•	•	•	•	•	•
Linear	•	•	•	•		•	•
Cubic spline	•	•		•			
<b>Numeric &amp; Data Type Support</b>							
Complex	•	•		•	•		
Double, Single	•	•	•	•	•	•	•
Integer	•	•	•	•	•	•	•
Fixed point	•	•	•	•	•	•	•
<b>Index Search Methods</b>							
Binary	•	•	•	•		•	
Linear	•	•		•		•	
Evenly spaced points	•	•		•	•	•	
Start at previous index	•	•		•		•	
<b>Miscellaneous</b>							

Feature	1-D Lookup Table	2-D Lookup Table	Lookup Table Dynamic	n-D Lookup Table	Direct Lookup Table (n-D)	Prelookup	Interp. Using Prelookup
Sub-table selection					.		.
Dynamic breakpoint data						.	
Dynamic table data			.		.		.
Input range checking	.	.		.	.	.	.

### More About

- “Anatomy of a Lookup Table” on page 36-4
- “Lookup Tables Block Library” on page 36-6
- “Edit Lookup Tables” on page 36-27

## Enter Breakpoints and Table Data

### In this section...

“Entering Data in a Block Parameter Dialog Box” on page 36-12

“Entering Data in the Lookup Table Editor” on page 36-12

“Entering Data Using Inports of the Lookup Table Dynamic Block” on page 36-14

### Entering Data in a Block Parameter Dialog Box

This example shows how to populate a 1-D Lookup Table block using the parameter dialog box. The lookup table in this example approximates the function  $y = x^3$  over the range  $[-3, 3]$ .

- 1 Copy a 1-D Lookup Table block from the Lookup Tables block library to a Simulink model.
- 2 In the 1-D Lookup Table block dialog box, enter the table dimensions and table data in the specified fields of the dialog box:
  - Set **Number of table dimensions** to 1.
  - Set **Table data** to  $[-27 \ -8 \ -1 \ 0 \ 1 \ 8 \ 27]$ .

Alternatively, to use an existing lookup table (`Simulink.LookupTable`) object, select **Data specification > Lookup table object**.

- 3 Enter the breakpoint data set using either of two methods:
  - To specify evenly spaced data points, set **Breakpoint specification** to **Even spacing**. Set **First point** to  $-3$  and **Spacing** to 1. The block calculates the number of evenly spaced breakpoints based on the table data.
  - To specify breakpoint data explicitly, set **Breakpoint specification** to **Explicit values** and set **Breakpoints 1** to  $[-3:3]$ .

### Entering Data in the Lookup Table Editor

Use the following procedure to populate a 2-D Lookup Table block using the Lookup Table Editor. In this example, the lookup table approximates the function  $z = x^2 + y^2$  over the input ranges  $x = [0, 2]$  and  $y = [0, 2]$ .



- 1** Copy a 2-D Lookup Table block from the Lookup Tables block library to a Simulink model.
- 2** Open the Lookup Table Editor by selecting **Lookup Table Editor** from the Simulink **Edit** menu or by clicking **Edit table and breakpoints** on the dialog box of the 2-D Lookup Table block.
- 3** Under **Viewing "n-D Lookup Table" block data**, enter the breakpoint data sets and table data in the appropriate cells. To change data, click a cell, enter the new value, and press **Enter**.
  - In the cells associated with the **Row Breakpoints**, enter each of the values [0 1 2].
  - In the cells associated with the **Column Breakpoints**, enter each of the values [0 1 2].
  - In the table data cells, enter the values in the array [0 1 4; 1 2 5; 4 5 8].

The Lookup Table Editor looks like this:

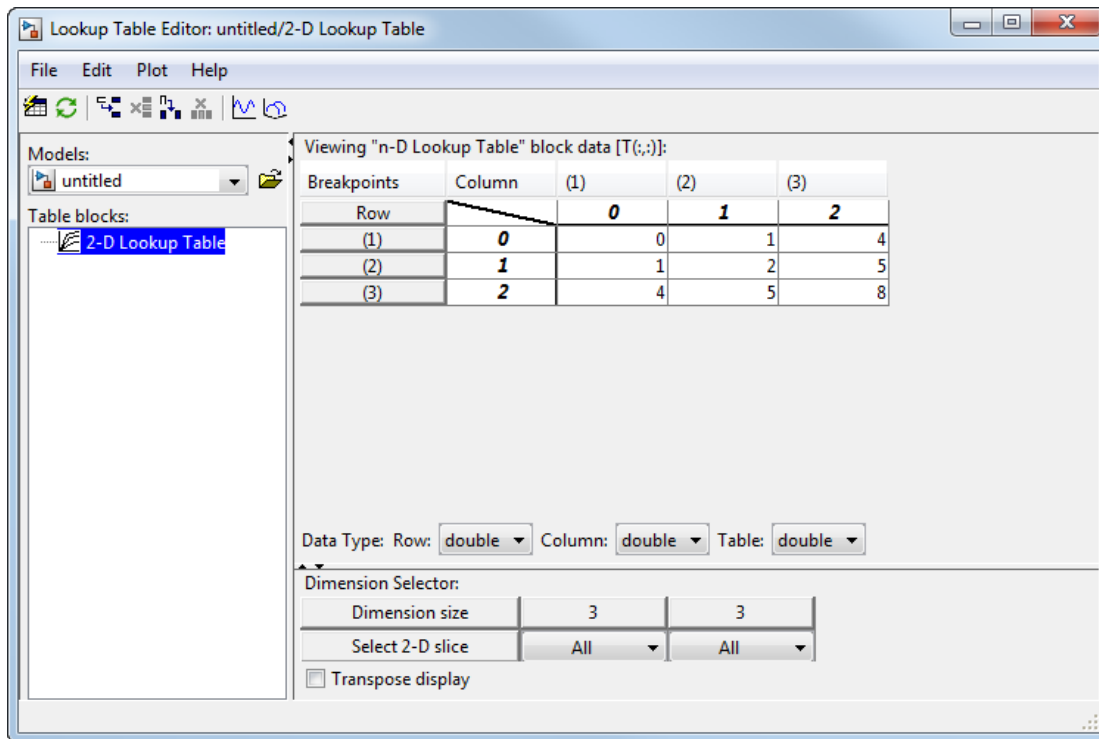

- 4 In the Lookup Table Editor, select **File > Update Block Data** to update the data in the 2-D Lookup Table block.
- 5 Close the Lookup Table Editor.

## Entering Data Using Inports of the Lookup Table Dynamic Block

Use the following procedure to populate a Lookup Table Dynamic block using that block's inports. In this example, the lookup table approximates the function  $y = 3x^2$  over the range  $[0, 10]$ .

- 1 Copy a Lookup Table Dynamic block from the Lookup Tables block library to a Simulink model.
- 2 Copy the blocks needed to implement the equation  $y = 3x^2$  to the Simulink model:
  - One Constant block to define the input range, from the Sources library

- One Math Function block to square the input range, from the Math Operations library
  - One Gain block to multiply the signal by 3, also from the Math Operations library
- 3 Assign the following parameter values to the Constant, Math Function, and Gain blocks using their dialog boxes:

Block	Parameter	Value
Constant	Constant value	0:10
Math Function	Function	square
Gain	Gain	3

- 4 Input the breakpoint data set to the Lookup Table Dynamic block by connecting the output of the Constant block to the input of the Lookup Table Dynamic block labeled **xdat**. This signal is the input breakpoint data set for  $x$ .
- 5 Input the table data to the Lookup Table Dynamic block by branching the output signal from the Constant block and connecting it to the Math Function block. Then connect the Math Function block to the Gain block. Finally, connect the Gain block to the input of the Lookup Table Dynamic block labeled **ydat**. This signal is the table data for  $y$ .

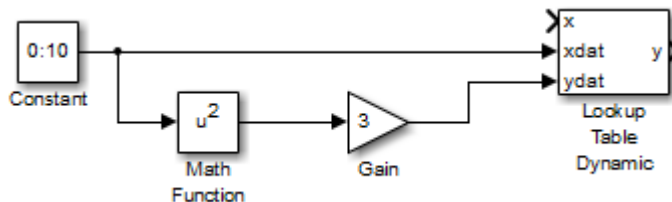

## See Also

Lookup Table Dynamic | n-D Lookup Table

## More About

- “About Lookup Table Blocks” on page 36-2
- “Anatomy of a Lookup Table” on page 36-4
- “Lookup Tables Block Library” on page 36-6

- “Lookup Table Glossary” on page 36-54
- “Edit Lookup Tables” on page 36-27
- “Guidelines for Choosing a Lookup Table” on page 36-8

## Characteristics of Lookup Table Data

### In this section...

“Sizes of Breakpoint Data Sets and Table Data” on page 36-17

“Monotonicity of Breakpoint Data Sets” on page 36-18

“Representation of Discontinuities in Lookup Tables” on page 36-18

“Formulation of Evenly Spaced Breakpoints” on page 36-20

### Sizes of Breakpoint Data Sets and Table Data

The following constraints apply to the sizes of breakpoint data sets and table data associated with lookup table blocks:

- The memory limitations of your system constrain the overall size of a lookup table.
- Lookup tables must use consistent dimensions so that the overall size of the table data reflects the size of each breakpoint data set.

To illustrate the second constraint, consider the following vectors of input and output values that create the relationship in the plot.

Vector of input values: [-3 -2 -1 0 1 2 3]

Vector of output values: [-3 -1 0 -1 0 1 3]

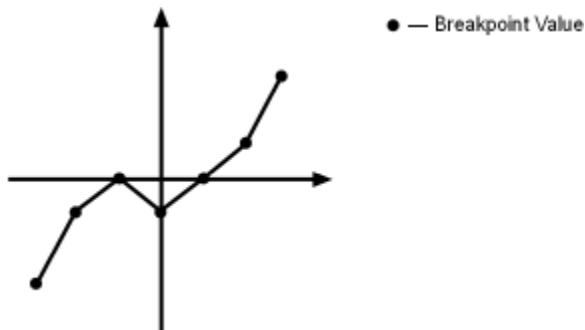

In this example, the input and output data are the same size (1-by-7), making the data consistently dimensioned for a 1-D lookup table.

The following input and output values define the 2-D lookup table that is graphically shown.

Row index input values: [1 2 3]  
 Column index input values: [1 2 3 4]  
 Table data: [11 12 13 14; 21 22 23 24; 31 32 33 34]

	1	2	3	4
1	11	12	13	14
2	21	22	23	24
3	31	32	33	34

In this example, the sizes of the vectors representing the row and column indices are 1-by-3 and 1-by-4, respectively. Consequently, the output table must be of size 3-by-4 for consistent dimensions.

## Monotonicity of Breakpoint Data Sets

The first stage of a table lookup operation involves relating inputs to the breakpoint data sets. The search algorithm requires that input breakpoint sets be *strictly monotonically increasing*, that is, each successive element is greater than its preceding element. For example, the vector

$A = [0 \ 0.5 \ 1 \ 1.9 \ 2.1 \ 3]$

is a valid breakpoint data set as each element is larger than its predecessors.

---

**Note:** Although a breakpoint data set is strictly monotonic in `double` format, it might not be so after conversion to a fixed-point data type.

---

## Representation of Discontinuities in Lookup Tables

You can represent discontinuities in lookup tables that have monotonically increasing breakpoint data sets. To create a discontinuity, repeat an input value in the breakpoint data set with different output values in the table data. For example, these vectors

of input ( $x$ ) and output ( $y$ ) values associated with a 1-D lookup table create the step transitions depicted in the plot that follows.

Vector of input values: `[-2 -1 -1 0 0 1 1 2]`

Vector of output values: `[-1 -1 -2 -2 2 2 1 1]`

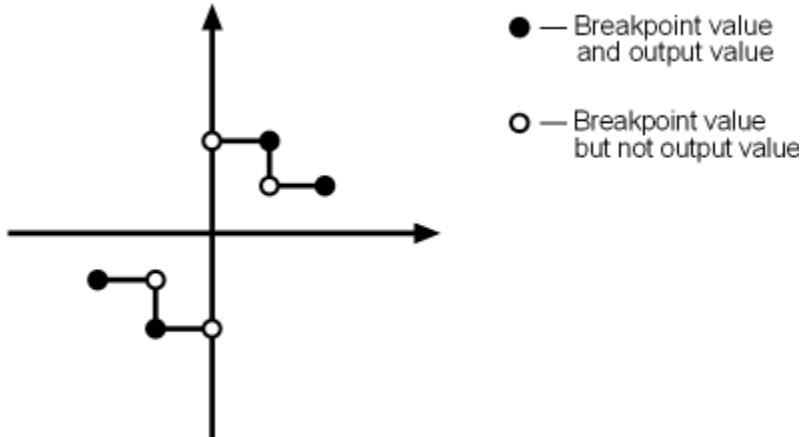

This example has discontinuities at  $x = -1$ ,  $0$ , and  $+1$ .

When there are two output values for a given input value, the block chooses the output according to these rules:

- If the input signal is less than zero, the block returns the output value associated with the last occurrence of the input value in the breakpoint data set. In this example, if the input is  $-1$ ,  $y$  is  $-2$ , marked with a solid circle.
- If the input signal is greater than zero, the block returns the output value associated with the first occurrence of the input value in the breakpoint data set. In this example, if the input is  $1$ ,  $y$  is  $2$ , marked with a solid circle.
- If the input signal is zero and there are two output values specified at the origin, the block returns the average of those output values. In this example, if the input is  $0$ ,  $y$  is  $0$ , the average of the two output values  $-2$  and  $2$  specified at  $x = 0$ .

When there are three points specified at the origin, the block generates the output associated with the middle point. The following example demonstrates this special rule.

Vector of input values: `[-2 -1 -1 0 0 0 1 1 2]`

Vector of output values: `[-1 -1 -2 -2 1 2 2 1 1]`

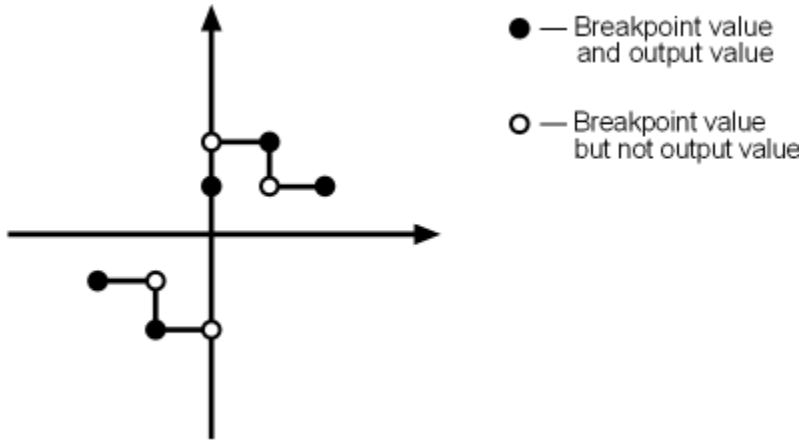

In this example, three points define the discontinuity at the origin. When the input is 0,  $y$  is 1, the value of the middle point.

You can apply this same method to create discontinuities in breakpoint data sets associated with multidimensional lookup tables.

### Formulation of Evenly Spaced Breakpoints

You can represent evenly spaced breakpoints in a data set by using one of these methods.

Formulation	Example	When to Use This Formulation
<code>[first_value:spacing:last_value]</code>	<code>[10:10:200]</code>	The lookup table does <i>not</i> use <code>double</code> or <code>single</code> .
<code>first_value + spacing * [0:(last_value-first_value)/spacing]</code>	<code>1 + (0.02 * [0:450])</code>	The lookup table uses <code>double</code> or <code>single</code> .

Because floating-point data types cannot precisely represent some numbers, the second formulation works better for `double` and `single`. For example, use `1 + (0.02 * [0:450])` instead of `[1:0.02:10]`. For a list of lookup table blocks that support evenly spaced breakpoints, see “Summary of Lookup Table Block Features” on page 36-10.

Among other advantages, evenly spaced breakpoints can make the generated code division-free and reduce memory usage. For more information, see:



- `fixpt_evenspace_cleanup` in the Simulink documentation
- “Effects of Spacing on Speed, Error, and Memory Usage” (Fixed-Point Designer) in the Fixed-Point Designer documentation
- “Identify questionable fixed-point operations” (Embedded Coder) in the Simulink Coder documentation

---

**Tip:** Do not use the MATLAB `linspace` function to define evenly spaced breakpoints. Simulink uses a tighter tolerance to check whether a breakpoint set has even spacing. If you use `linspace` to define breakpoints for your lookup table, Simulink considers the breakpoints to be unevenly spaced.

---

## More About

- “Anatomy of a Lookup Table” on page 36-4
- “Lookup Tables Block Library” on page 36-6
- “Edit Lookup Tables” on page 36-27
- “Guidelines for Choosing a Lookup Table” on page 36-8
- “Summary of Lookup Table Block Features” on page 36-10

## Methods for Estimating Missing Points

### In this section...

“About Estimating Missing Points” on page 36-22

“Interpolation Methods” on page 36-22

“Extrapolation Methods” on page 36-23

“Rounding Methods” on page 36-24

“Example Output for Lookup Methods” on page 36-25

### About Estimating Missing Points

The second stage of a table lookup operation involves generating outputs that correspond to the supplied inputs. If the inputs match the values of indices specified in breakpoint data sets, the block outputs the corresponding values. However, if the inputs fail to match index values in the breakpoint data sets, Simulink estimates the output. In the block parameter dialog box, you can specify how to compute the output in this situation. The available lookup methods are described in the following sections.

### Interpolation Methods

When an input falls between breakpoint values, the block interpolates the output value using neighboring breakpoints. Most lookup table blocks have the following interpolation methods available:

- **Flat** — Disables interpolation and uses the rounding operation titled **Use Input Below**. For more information, see “Rounding Methods” on page 36-24.
- **Nearest** — Disables interpolation and returns the table value corresponding to the breakpoint closest to the input. If the input is equidistant from two adjacent breakpoints, the breakpoint with the higher index is chosen.
- **Linear** — Fits a line between the adjacent breakpoints, and returns the point on that line corresponding to the input.
- **Cubic spline** — Fits a cubic spline to the adjacent breakpoints, and returns the point on that spline corresponding to the input.

---

**Note:** The Lookup Table Dynamic block does not let you select an interpolation method. The **Interpolation-Extrapolation** option in the **Lookup Method** field of the block parameter dialog box performs linear interpolation.

---

Each interpolation method includes a trade-off between computation time and the smoothness of the result. Although rounding is quickest, it is the least smooth. Linear interpolation is slower than rounding but generates smoother results, except at breakpoints where the slope changes. Cubic spline interpolation is the slowest method but produces the smoothest results.

## Extrapolation Methods

When an input falls outside the range of a breakpoint data set, the block extrapolates the output value from a pair of values at the end of the breakpoint data set. Most lookup table blocks have the following extrapolation methods available:

- **Clip** — Disables extrapolation and returns the table data corresponding to the end of the breakpoint data set range. This does not provide protection against out-of-range values.
- **Linear** — If the interpolation method is **Linear**, this extrapolation method fits a line between the first or last pair of breakpoints, depending on whether the input is less than the first or greater than the last breakpoint. If the interpolation method is **Cubic spline**, this extrapolation method fits a linear surface using the slope of the interpolant at the first or last break point, depending on whether the input is less than the first or greater than the last breakpoint. The extrapolation method returns the point on the generated linear surface corresponding to the input.
- **Cubic spline** — Fits a cubic spline to the first or last pair of breakpoints, depending if the input is less than the first or greater than the last breakpoint, respectively. This method returns the point on that spline corresponding to the input.

---

**Note:** The Lookup Table Dynamic block does not let you select an extrapolation method. The **Interpolation-Extrapolation** option in the **Lookup Method** field of the block parameter dialog box performs linear extrapolation.

---

In addition to these methods, some lookup table blocks, such as the n-D Lookup Table block, allow you to select an action to perform when encountering situations that require extrapolation. For instance, you can specify that Simulink generate either a warning or

an error when the lookup table inputs are outside the ranges of the breakpoint data sets. To specify such an action, select it from the **Diagnostic for out-of-range input** list on the block parameter dialog box.

## Rounding Methods

If an input falls between breakpoint values or outside the range of a breakpoint data set and you do not specify interpolation or extrapolation, the block rounds the value to an adjacent breakpoint and returns the corresponding output value. For example, the Lookup Table Dynamic block lets you select one of the following rounding methods:

- **Use Input Nearest** — Returns the output value corresponding to the nearest input value.
- **Use Input Below** — Returns the output value corresponding to the breakpoint value that is immediately less than the input value. If no breakpoint value exists below the input value, it returns the breakpoint value nearest the input value.
- **Use Input Above** — Returns the output value corresponding to the breakpoint value that is immediately greater than the input value. If no breakpoint value exists above the input value, it returns the breakpoint value nearest the input value.

## Example Output for Lookup Methods

In the following model, the Lookup Table Dynamic block accepts a vector of breakpoint data given by  $[-5:5]$  and a vector of table data given by  $\sinh([-5:5])$ .

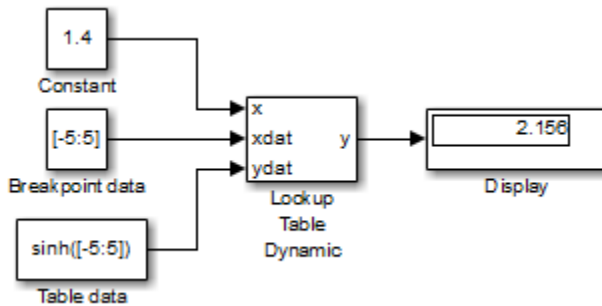

The Lookup Table Dynamic block outputs the following values when using the specified lookup methods and inputs.

Lookup Method	Input	Output	Comment
Interpolation-Extrapolation	1.4	2.156	N/A
	5.2	83.59	N/A
Interpolation-Use End Values	1.4	2.156	N/A
	5.2	74.2	The block uses the value for $\sinh(5.0)$ .
Use Input Above	1.4	3.627	The block uses the value for $\sinh(2.0)$ .
	5.2	74.2	The block uses the value for $\sinh(5.0)$ .
Use Input Below	1.4	1.175	The block uses the value for $\sinh(1.0)$ .
	-5.2	-74.2	The block uses the value for $\sinh(-5.0)$ .
Use Input Nearest	1.4	1.175	The block uses the value for $\sinh(1.0)$ .

## **More About**

- “About Lookup Table Blocks” on page 36-2
- “Lookup Table Glossary” on page 36-54
- “Anatomy of a Lookup Table” on page 36-4
- “Lookup Tables Block Library” on page 36-6
- “Edit Lookup Tables” on page 36-27
- “Guidelines for Choosing a Lookup Table” on page 36-8

## Edit Lookup Tables

In this section...
“Edit N-Dimensional Lookup Tables” on page 36-27
“Edit Custom Lookup Table Blocks” on page 36-29

You can edit a lookup table using:

- Lookup Table block dialog box
- Lookup Table Editor

To edit the lookup table in a block:

- 1 Open the subsystem that contains the lookup table block.
- 2 Open the lookup table block’s dialog box.
- 3 In the Table and Breakpoints tab, edit the **Table data** and relevant **Breakpoints** parameters as needed.

With the Lookup Table Editor, you can skip these steps and edit the desired lookup table without navigating to the block that uses it. However, you cannot use the Lookup Table Editor to change the dimensions of a lookup table. You must use the block parameter dialog box for this purpose.

### Edit N-Dimensional Lookup Tables

If the lookup table of the block currently selected in the Lookup Table Editor tree view has more than two dimensions, the table view displays a two-dimensional slice of the lookup table.

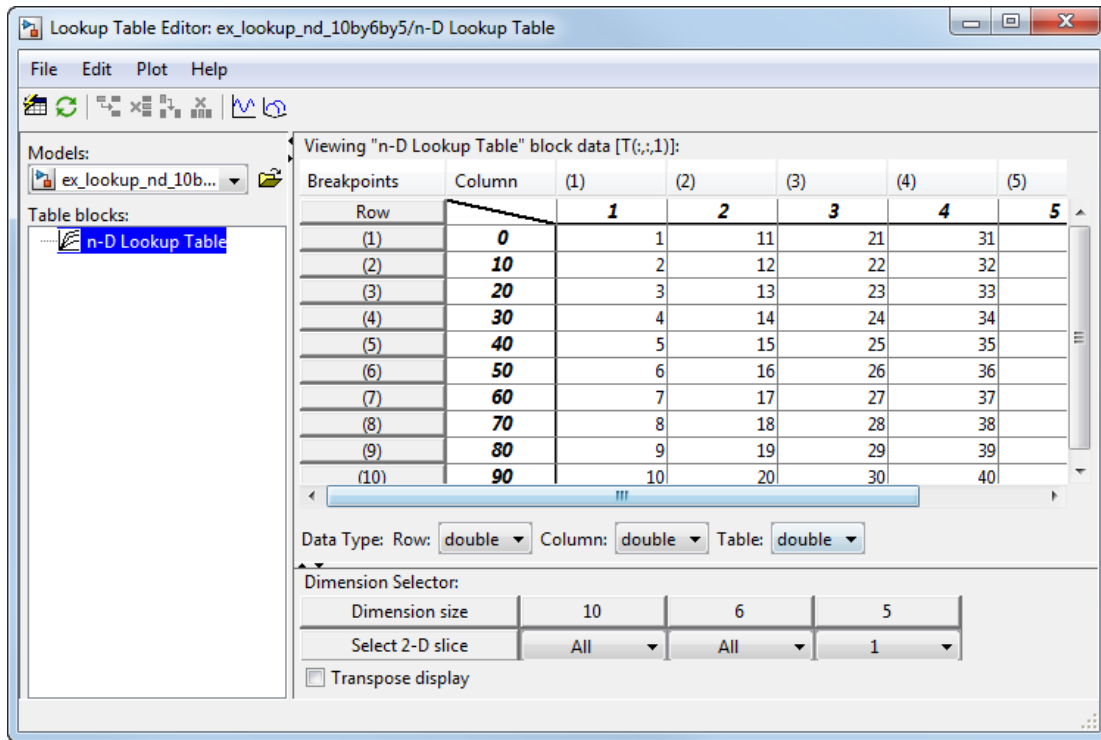

The **Dimension Selector** specifies which slice currently appears and lets you select another slice. The selector consists of a 2-by-N array of controls, where N is the number of dimensions in the lookup table. Each column corresponds to a dimension of the lookup table. The first column corresponds to the first dimension of the table, the second column to the second dimension of the table, and so on. The **Dimension size** row of the selector array displays the size of each dimension. The **Select 2-D slice** row specifies which dimensions of the table correspond to the row and column axes of the slice and the indices that select the slice from the remaining dimensions.

To select another slice of the table, specify the row and column axes of the slice in the first two columns of the **Select 2-D slice** row. Then select the indices of the slice from the pop-up index lists in the remaining columns.

For example, the following selector displays slice  $(:,:,1)$  of a 3-D lookup table, as shown under Dimension Selector in the Lookup Table Editor.

To transpose the table display, select the **Transpose display** check box.



## Edit Custom Lookup Table Blocks

You can use the Lookup Table Editor to edit custom lookup table blocks that you have created. To do this, you must first configure the Lookup Table Editor to recognize the custom lookup table blocks in your model.

- 1 Select **File > Configure**. The Lookup Table Blocks Type Configuration dialog box appears.

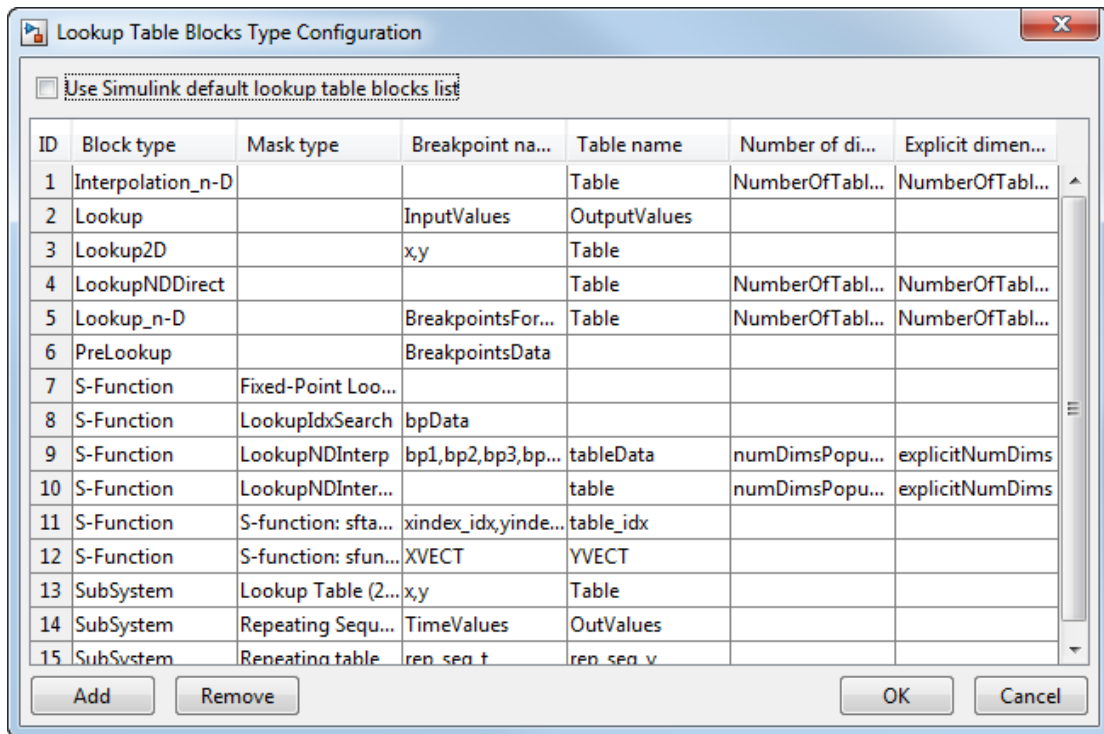

The dialog box displays a table of the lookup table block types that the Lookup Table Editor currently recognizes. This table includes the standard blocks. Each row of the table displays key attributes of a lookup table block type.

- 2 Click **Add** on the dialog box. A new row appears at the bottom of the block type table.
- 3 Enter information for the custom block in the new row under these headings.

Field Name	Description
Block type	Block type of the custom block. The block type is the value of the block's <b>BlockType</b> parameter.
Mask type	Mask type of the custom block. The mask type is the value of the block's <b>MaskType</b> parameter.
Breakpoint name	Names of the block parameters that store the breakpoints.
Table name	Name of the block parameter that stores the table data.
Number of dimensions	Leave empty.
Explicit dimensions	Leave empty.

#### 4 Click **OK**.

To remove a custom lookup table block type from the list that the Lookup Table Editor recognizes, select the custom entry in the table of the Lookup Table Blocks Type Configuration dialog box and click **Remove**. To remove all custom lookup table block types, select the **Use Simulink default lookup table blocks list** check box at the top of the dialog box.

## More About

- “About Lookup Table Blocks” on page 36-2
- “Lookup Table Glossary” on page 36-54
- “Anatomy of a Lookup Table” on page 36-4
- “Lookup Tables Block Library” on page 36-6
- “Guidelines for Choosing a Lookup Table” on page 36-8

## Import Lookup Table Data from MATLAB

### In this section...

“Import Standard Format Lookup Table Data” on page 36-31

“Propagate Standard Format Lookup Table Data” on page 36-32

“Import Nonstandard Format Lookup Table Data” on page 36-33

“Propagate Nonstandard Format Lookup Table Data” on page 36-34

You can import table and breakpoint data from variables in the MATLAB workspace by referencing them in the **Table and Breakpoints** tab of the dialog box. The following examples show how to import and export standard format and non-standard format data from the MATLAB workspace.

### Import Standard Format Lookup Table Data

Suppose you specify a 3-D lookup table in your n-D Lookup Table block.

Create workspace variables to use as breakpoint and table data for the lookup table.

```
table3d_map = zeros(2,4,3);
table3d_map(:,:,1) = [ 1 2 3 4; 5 6 7 8];
table3d_map(:,:,2) = [ 11 12 13 14; 15 16 17 18];
table3d_map(:,:,3) = [ 111 112 113 114; 115 116 117 118];
bp3d_z = [ 0 10 20];
bp3d_x = [ 0 10 20 30];
bp3d_y = [ 400 6400];
```

Open the n-D Lookup Table block dialog box, and enter the following parameters in the Table and Breakpoints tab:

- Table data: table3d\_map
- Breakpoints 1: bp3d\_y
- Breakpoints 2: bp3d\_x
- Breakpoints 3: bp3d\_z

Click **Edit table and breakpoints** to open the Lookup Table Editor and show the data from the workspace variables.

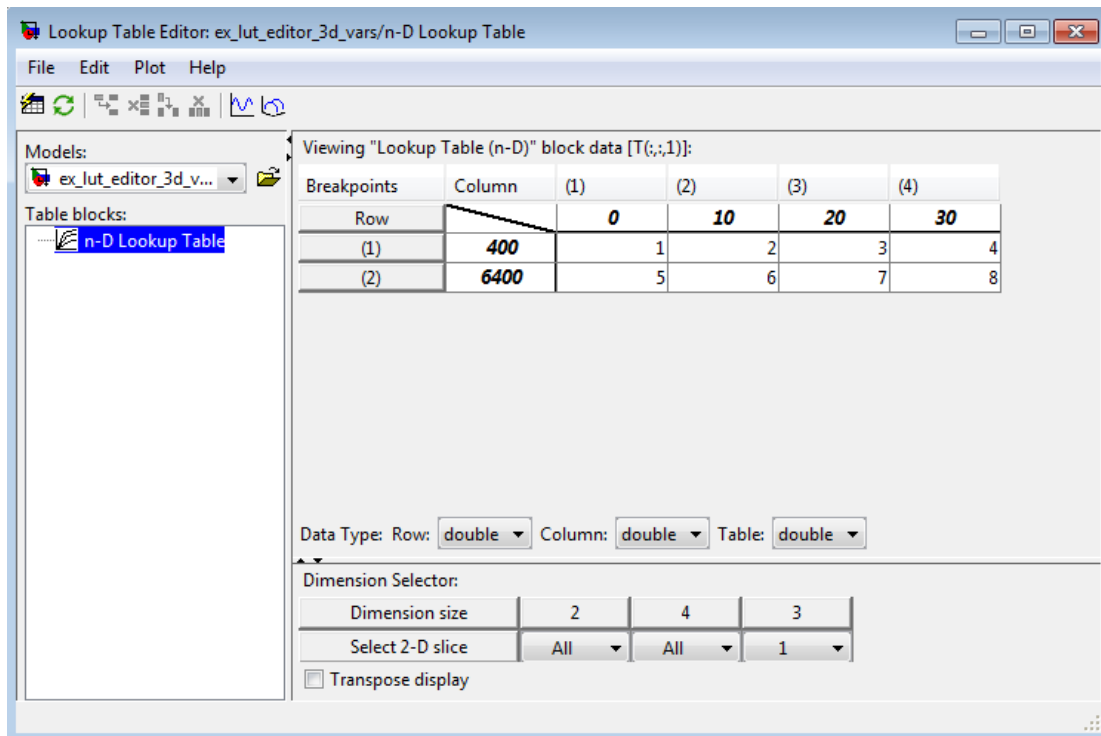

## Propagate Standard Format Lookup Table Data

When you make changes to your lookup table data, consider propagating the changes back to the MATLAB workspace variables the data was imported from using **File > Update Block Data**.

You can also use the Lookup Table Editor to edit the table data and breakpoint data set of `Simulink.LookupTable` and the breakpoint data set of `Simulink.Breakpoint` objects and propagate the changes back to the object.

Suppose you make a change to the lookup table variables imported from the MATLAB workspace variables in “Import Standard Format Lookup Table Data” on page 36-31. For example, change the value of the data in (1,1,1) from 1 to 33. To propagate this change back to `table3d_map` in the workspace, select **File > Update Block Data**. Click **Yes** to confirm that you want to overwrite `table3d_map`.

## Import Nonstandard Format Lookup Table Data

Suppose you specify a 3-D lookup table in your n-D Lookup Table block. Create workspace variables to use as breakpoint and table data for the lookup table. The variable for table data, `table3d_map_custom`, is a two-dimensional matrix.

```
table3d_map_custom = zeros(6,4);
table3d_map_custom = [ 1 2 3 4; 5 6 7 8;
11 12 13 14; 15 16 17 18;
111 112 113 114; 115 116 117 118];
bp3d_z =[ 0 10 20];
bp3d_x =[ 0 10 20 30];
bp3d_y =[ 400 6400];
```

Open the n-D Lookup Table block dialog box, and enter the following parameters in the Table and Breakpoints tab. Transform `table3d_map_custom` into a three-dimensional matrix for the table data input using the `reshape` command below.

- Table data: `reshape(table3d_map_custom,[2,4,3])`
- Breakpoints 1: `bp3d_y`
- Breakpoints 2: `bp3d_x`
- Breakpoints 3: `bp3d_z`

Click **Edit table and breakpoints** to open the Lookup Table Editor and show the data from the workspace variables.

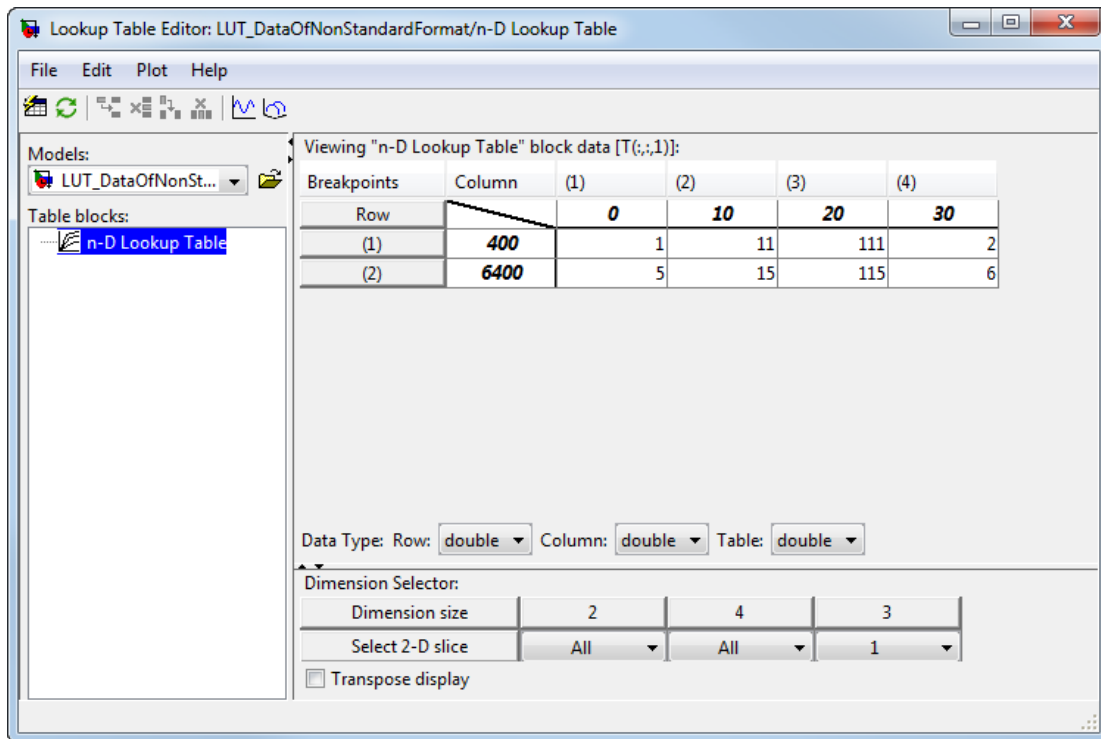

Change 1 to 33 in the Lookup Table Editor. The Lookup Table Editor records your changes by maintaining a copy of the table. To restore the variable values from the MATLAB workspace, select **File > Reload Block Data**. To update the MATLAB workspace variables with the edited data, select **File > Update Block Data** in the Lookup Table Editor. You cannot propagate the change to `table3d_map_custom`, the workspace variable that contains the nonstandard table data for the n-D Lookup Table block. To propagate the change, you must register a customization function that resides on the MATLAB search path. For details, see “Propagate Nonstandard Format Lookup Table Data” on page 36-34.

## Propagate Nonstandard Format Lookup Table Data

This example shows how to propagate changes from the Lookup Table Editor to workspace variables of nonstandard format. Suppose your Simulink model from “Import Nonstandard Format Lookup Table Data” on page 36-33 has a three-dimensional lookup table that gets its table data from the two-dimensional workspace variable

`table3d_map_custom`. Update the lookup table in the Lookup Table Editor and propagate these changes back to `table3d_map_custom` using a customization function.

- 1 Create a file named `s1_customization.m` with these contents.

```
function s1_customization(cm)
cm.LookupTableEditorCustomizer.getTableConvertToCustomInfoFcnHandle{end+1} = ...
@myGetTableConvertInfoFcn;
end
```

In this function:

- The argument `cm` is the handle to a customization manager object.
- The handle `@myGetTableConvertInfoFcn` is added to the list of function handles in the cell array for `cm.LookupTableEditorCustomizer.getTableConvertToCustomInfoFcnHandle`. You can use any alphanumeric name for the function whose handle you add to the cell array.

- 2 In the same file, define the `myGetTableConvertInfoFcn` function.

```
function blkInfo = myGetTableConvertInfoFcn(blk, tableStr)
    blkInfo.allowTableConvertLocal = true;
    blkInfo.tableWorkSpaceVarName = 'table3d_map_custom';
    blkInfo.tableConvertFcnHandle = @myConvertTableFcn;
end
```

The `myGetTableConvertInfoFcn` function returns the `blkInfo` object containing three fields.

- `allowTableConvertLocal` — Allows table data conversion for a block.
- `tableWorkSpaceVarName` — Specifies the name of the workspace variable that has a nonstandard table format.
- `tableConvertFcnHandle` — Specifies the handle for the conversion function.

When `allowTableConvertLocal` is set to `true`, the table data for that block is converted to the nonstandard format of the workspace variable whose name matches `tableWorkSpaceVarName`. The conversion function corresponds to the handle that `tableConvertFcnHandle` specifies. You can use any alphanumeric name for the conversion function.

- 3 In the same file, define the `myConvertTableFcn` function. This function converts a three-dimensional lookup table of size *Rows* \* *Columns* \* *Height* to a two-dimensional variable of size *(Rows\*Height)* \* *Columns*.

```
% Converts 3-dimensional lookup table from Simulink format to
% nonstandard format used in workspace variable
function cMap = myConvertTableFcn(data)

% Determine the row and column number of the 3D table data
mapDim = size(data);
numCol = mapDim(2);
numRow = mapDim(1)*mapDim(3);
cMap = zeros(numRow, numCol);
% Transform data back to a 2-dimensional matrix
cMap = reshape(data,[numRow,numCol]);
end
```

- 4 Put `sl_customization.m` on the MATLAB search path. You can have multiple files named `sl_customization.m` on the search path. For more details, see “Behavior with Multiple Customization Functions” on page 36-37.
- 5 Refresh Simulink customizations at the MATLAB command prompt.  
`sl_refresh_customizations`
- 6 Open the Lookup Table Editor for your lookup table block and select **File > Update Block Data**. Click **Yes** to overwrite the workspace variable `table3d_map_custom`.
- 7 Check the value of `table3d_map_custom` in the base workspace.

```
table3d_map_custom =

    33     2     3     4
     5     6     7     8
    11    12    13    14
    15    16    17    18
   111   112   113   114
   115   116   117   118
```

The change in the Lookup Table Editor has propagated to the workspace variable.

---

**Note:** If you do not overwrite the workspace variable `table3d_map_custom`, you are prompted to replace it with numeric data. Click **Yes** to replace the expression in the **Table data** field with numeric data. Click **No** if you do not want your Lookup Table Editor changes for the table data to appear in the block dialog box.

---



## Behavior with Multiple Customization Functions

At the start of a MATLAB session, Simulink loads each `sl_customization.m` customization file on the path and executes the `sl_customization` function. Executing each function establishes the customizations for that session.

When you select **File > Update Block Data** in the Lookup Table Editor, the editor checks the list of function handles in the cell array for `cm.LookupTableEditorCustomizer.getTableConvertToCustomInfoFcnHandle`. If the cell array contains one or more function handles, the `allowTableConvertLocal` property determines whether changes in the Lookup Table Editor can be propagated.

- If the value is set to `true`, then the table data is converted to the nonstandard format in the workspace variable.
- If the value is set to `false`, then table data is not converted to the nonstandard format in the workspace variable.
- If the value is set to `true` and another customization function specifies it to be `false`, the Lookup Table Editor reports an error.

## More About

- “About Lookup Table Blocks” on page 36-2
- “Lookup Table Glossary” on page 36-54
- “Anatomy of a Lookup Table” on page 36-4
- “Lookup Tables Block Library” on page 36-6
- “Edit Lookup Tables” on page 36-27
- “Guidelines for Choosing a Lookup Table” on page 36-8
- “Import Lookup Table Data from Excel” on page 36-38

## Import Lookup Table Data from Excel

This example shows how to use the MATLAB `xlsread` function in a Simulink model to import data into a lookup table.

- 1 Save the Excel file in a folder on the MATLAB path.
- 2 Open the model containing the lookup table block and select **File > Model Properties > Model Properties**.
- 3 In the Model Properties dialog box, in the **Callbacks** tab, click **PostLoadFcn** callback in the model callbacks list.
- 4 Enter the code to import the Excel Spreadsheet data in the text box. Use the MATLAB `xlsread` function, as shown in this example for a 2-D lookup table.

```
% Import the data from Excel for a lookup table
data = xlsread('MySpreadsheet', 'Sheet1');
% Row indices for lookup table
breakpoints1 = data(2:end,1)';
% Column indices for lookup table
breakpoints2 = data(1,2:end);
% Output values for lookup table
table_data = data(2:end,2:end);
```

- 5 Click **OK**.

After you save your changes, the next time you open the model, Simulink invokes the callback and imports the data.

### More About

- “About Lookup Table Blocks” on page 36-2
- “Lookup Table Glossary” on page 36-54
- “Anatomy of a Lookup Table” on page 36-4
- “Lookup Tables Block Library” on page 36-6
- “Edit Lookup Tables” on page 36-27
- “Guidelines for Choosing a Lookup Table” on page 36-8
- “Import Lookup Table Data from MATLAB” on page 36-31

## Create a Logarithm Lookup Table

Suppose you want to approximate the common logarithm (base 10) over the input range [1, 10] without performing an expensive computation. You can perform this approximation using a lookup table block as described in the following procedure.

- 1** Copy the following blocks to a Simulink model:
  - One Constant block to input the signal, from the Sources library
  - One n-D Lookup Table block to approximate the common logarithm, from the Lookup Tables library
  - One Display block to display the output, from the Sinks library
- 2** Assign the table data and breakpoint data set to the n-D Lookup Table block:
  - a** In the **Number of table dimensions** field, enter 1.
  - b** In the **Table data** field, enter  
[0 .301 .477 .602 .699 .778 .845 .903 .954 1].
  - c** In the **Breakpoints 1** field, enter [1:10].
  - d** Click **Apply**.

The dialog box looks something like this:

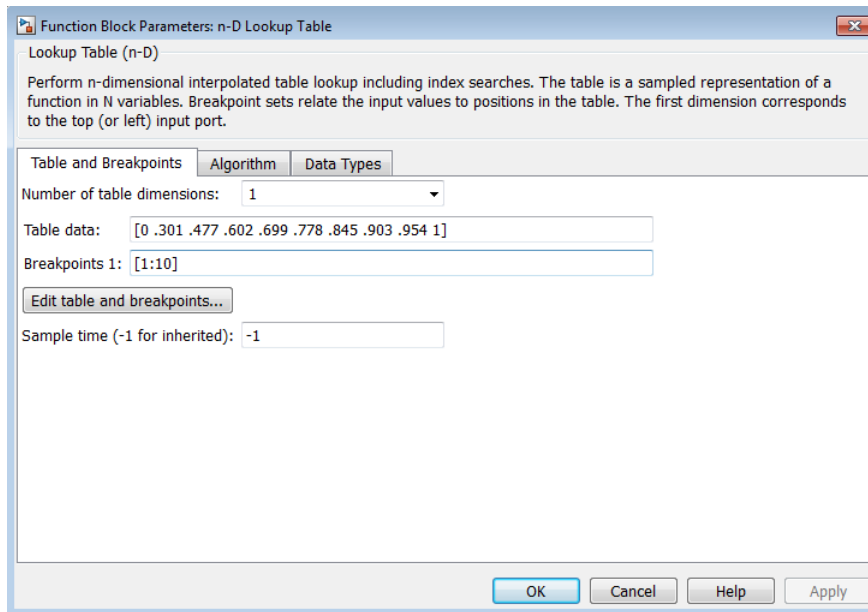

- 3 Double-click the Constant block to open the parameter dialog box, and change the **Constant value** parameter to 5. Click **OK** to apply the changes and close the dialog box.
- 4 Connect the blocks as follows.

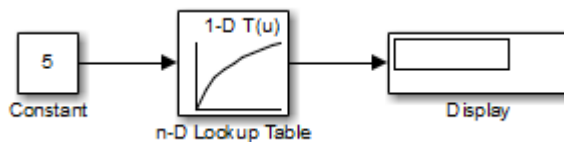

- 5 Start simulation.

The following behavior applies to the n-D Lookup Table block.

Value of the Constant Block	Action by the n-D Lookup Table Block	Example of Block Behavior	
		Input Value	Output Value
Equals a breakpoint	Returns the corresponding output value	5	0.699
Falls between breakpoints	Linearly interpolates the output value using neighboring breakpoints	7.5	0.874
Falls outside the range of the breakpoint data set	Linearly extrapolates the output value from a pair of values at the end of the breakpoint data set	10.5	1.023

For the n-D Lookup Table block, the default settings for **Interpolation method** and **Extrapolation method** are both **Linear**.

## See Also

n-D Lookup Table

## More About

- “About Lookup Table Blocks” on page 36-2
- “Lookup Table Glossary” on page 36-54
- “Anatomy of a Lookup Table” on page 36-4
- “Lookup Tables Block Library” on page 36-6
- “Edit Lookup Tables” on page 36-27
- “Guidelines for Choosing a Lookup Table” on page 36-8
- “Import Lookup Table Data from MATLAB” on page 36-31

## Prelookup and Interpolation Blocks

The following examples show the benefits of using Prelookup and Interpolation Using Prelookup blocks.

Action	Benefit	Example
Use an index search to relate inputs to table data, followed by an interpolation and extrapolation stage that computes outputs	Enables reuse of index search results to look up data in multiple tables, which reduces simulation time	To open the model, type <code>sldemo_bpcheck</code> at the command prompt.
Set breakpoint and table data types explicitly	Lowers memory required to store: <ul style="list-style-type: none"> <li>• Breakpoint data that uses a smaller type than the input signal</li> <li>• Table data that uses a smaller type than the output signal</li> </ul>	To open the model, type <code>sldemo_interp_memory</code> at the command prompt.
	Provides easier sharing of: <ul style="list-style-type: none"> <li>• Breakpoint data among Prelookup blocks</li> <li>• Table data among Interpolation Using Prelookup blocks</li> </ul>	To open the model, type <code>fxpdemo_lookup_shared_param</code> at the command prompt.
	Enables reuse of utility functions in the generated code	To open the model, type <code>fxpdemo_prelookup_utilfcn</code> at the command prompt.
Set the data type for intermediate results explicitly	Enables use of higher precision for internal computations than for table data or output data	To open the model, type <code>fxpdemo_interp_precision</code> at the command prompt.

### See Also

Interpolation Using Prelookup | Prelookup

## **More About**

- “About Lookup Table Blocks” on page 36-2
- “Lookup Table Glossary” on page 36-54
- “Anatomy of a Lookup Table” on page 36-4
- “Lookup Tables Block Library” on page 36-6
- “Edit Lookup Tables” on page 36-27
- “Guidelines for Choosing a Lookup Table” on page 36-8

## Optimize Generated Code for Lookup Table Blocks

### In this section...

“Remove Code That Checks for Out-of-Range Inputs” on page 36-44

“Optimize Breakpoint Spacing in Lookup Tables” on page 36-46

“Reduce Data Copies for Lookup Table Blocks” on page 36-47

### Remove Code That Checks for Out-of-Range Inputs

By default, generated code for the following lookup table blocks include conditional statements that check for out-of-range breakpoint or index inputs:

- 1-D Lookup Table
- 2-D Lookup Table
- n-D Lookup Table
- Prelookup
- Interpolation Using Prelookup

To generate code that is more efficient, you can remove the conditional statements that protect against out-of-range input values.

Block	Check Box to Select
1-D Lookup Table	<b>Remove protection against out-of-range input in generated code</b>
2-D Lookup Table	
n-D Lookup Table	
Prelookup	
Interpolation Using Prelookup	<b>Remove protection against out-of-range index in generated code</b>

Selecting the check box on the block dialog box improves code efficiency because there are fewer statements to execute. However, if you are generating code for safety-critical applications, you should not remove the range-checking code.

To verify the usage of the check box, run the following Model Advisor checks and perform the recommended actions.



<b>Model Advisor Check</b>	<b>When to Run the Check</b>
<b>By Product &gt; Embedded Coder &gt; Identify lookup table blocks that generate expensive out-of-range checking code</b>	For code efficiency
<b>By Product &gt; Simulink Verification and Validation &gt; Modeling Standards &gt; DO-178C/DO-331 Checks &gt; Check usage of lookup table blocks</b>	For safety-critical applications

For more information about the Model Advisor, see “Select and Run Model Advisor Checks” on page 5-2 in the Simulink documentation.

## Optimize Breakpoint Spacing in Lookup Tables

When breakpoints in a lookup table are tunable, the spacing does not affect efficiency or memory usage of the generated code. When breakpoints are *not* tunable, the type of spacing can affect the following factors.

Factor	Even Power of 2 Spaced Data	Evenly Spaced Data	Unevenly Spaced Data
Execution speed	The execution speed is the fastest. The position search and interpolation are the same as for evenly-spaced data. However, to increase speed a bit more for fixed-point types, a bit shift replaces the position search, and a bit mask replaces the interpolation.	The execution speed is faster than that for unevenly-spaced data because the position search is faster and the interpolation uses a simple division.	The execution speed is the slowest of the different spacings because the position search is slower, and the interpolation requires more operations.
Error	The error can be larger than that for unevenly-spaced data because approximating a function with nonuniform curvature requires more points to achieve the same accuracy.	The error can be larger than that for unevenly-spaced data because approximating a function with nonuniform curvature requires more points to achieve the same accuracy.	The error can be smaller because approximating a function with nonuniform curvature requires fewer points to achieve the same accuracy.
ROM usage	Uses less command ROM, but more data ROM.	Uses less command ROM, but more data ROM.	Uses more command ROM, but less data ROM.
RAM usage	Not significant.	Not significant.	Not significant.

Follow these guidelines:

- For fixed-point data types, use breakpoints with even, power-of-2 spacing.
- For non-fixed-point data types, use breakpoints with even spacing.

To identify opportunities for improving code efficiency in lookup table blocks, run the following Model Advisor checks and perform the recommended actions:

- **By Product > Embedded Coder > Identify questionable fixed-point operations**
- **By Product > Embedded Coder > Identify blocks that generate expensive saturation and rounding code**

For more information about the Model Advisor, see “Select and Run Model Advisor Checks” on page 5-2 in the Simulink documentation.

## Reduce Data Copies for Lookup Table Blocks

When you use workspace variables to store table and breakpoint data for Lookup Table blocks, and then configure these variables for tunability, you can avoid data copies by using the same data type for the block parameter and variable. Workspace variables include numeric MATLAB variables and `Simulink.Parameter` objects that you store in a workspace, such as the base workspace, or in a data dictionary. If the data type of the variable is smaller than the data type of the block parameter, the generated code implicitly casts the data type of the variable to the data type of the block parameter. This implicit cast requires a data copy which can potentially significantly increase RAM consumption and slow down code execution speed for large vectors or matrices.

For more information, see “Parameter Data Types in the Generated Code” (Embedded Coder) and “Block Parameter Representation in the Generated Code” (Embedded Coder).

## See Also

Interpolation Using Prelookup | n-D Lookup Table | Prelookup

## More About

- “Select and Run Model Advisor Checks” on page 5-2
- “Lookup Tables Block Library” on page 36-6
- “Edit Lookup Tables” on page 36-27
- “Guidelines for Choosing a Lookup Table” on page 36-8

## Update Lookup Table Blocks to New Versions

### In this section...

“Comparison of Blocks with Current Versions” on page 36-48

“Compatibility of Models with Older Versions of Lookup Table Blocks” on page 36-49

“How to Update Your Model” on page 36-50

“What to Expect from the Model Advisor Check” on page 36-50

### Comparison of Blocks with Current Versions

In R2011a, the following lookup table blocks were replaced with newer versions in the Simulink library:

Block	Changes	Enhancements
Lookup Table	<ul style="list-style-type: none"> <li>Block renamed as 1-D Lookup Table</li> <li>Icon changed</li> </ul>	<ul style="list-style-type: none"> <li>Default integer rounding mode changed from <b>Floor</b> to <b>Simplest</b></li> <li>Support for the following features: <ul style="list-style-type: none"> <li>Specification of parameter data types different from input or output signal types</li> <li>Reduced memory use and faster code execution for nontunable breakpoints with even spacing</li> <li>Cubic-spline interpolation and extrapolation</li> <li>Table data with complex values</li> <li>Fixed-point data types with word lengths up to 128 bits</li> <li>Specification of data types for fraction and intermediate results</li> <li>Specification of index search method</li> <li>Specification of diagnostic for out-of-range inputs</li> </ul> </li> </ul>
Lookup Table (2-D)	<ul style="list-style-type: none"> <li>Block renamed as 2-D Lookup Table</li> <li>Icon changed</li> </ul>	<ul style="list-style-type: none"> <li>Default integer rounding mode changed from <b>Floor</b> to <b>Simplest</b></li> <li>Support for the following features:</li> </ul>

Block	Changes	Enhancements
		<ul style="list-style-type: none"> <li>• Specification of parameter data types different from input or output signal types</li> <li>• Reduced memory use and faster code execution for nontunable breakpoints with even spacing</li> <li>• Cubic-spline interpolation and extrapolation</li> <li>• Table data with complex values</li> <li>• Fixed-point data types with word lengths up to 128 bits</li> <li>• Specification of data types for fraction and intermediate results</li> <li>• Specification of index search method</li> <li>• Specification of diagnostic for out-of-range inputs</li> <li>• Check box for <b>Require all inputs to have the same data type</b> now selected by default</li> </ul>
Lookup Table (n-D)	<ul style="list-style-type: none"> <li>• Block renamed as n-D Lookup Table</li> <li>• Icon changed</li> </ul>	<ul style="list-style-type: none"> <li>• Default integer rounding mode changed from Floor to Simplest</li> </ul>

## Compatibility of Models with Older Versions of Lookup Table Blocks

When you load existing models that contain the Lookup Table, Lookup Table (2-D), and Lookup Table (n-D) blocks, those versions of the blocks appear. The current versions of the lookup table blocks appear only when you drag the blocks from the Simulink Library Browser into new models.

If you use the `add_block` function to add the Lookup Table, Lookup Table (2-D), or Lookup Table (n-D) blocks to a model, those versions of the blocks appear. If you want to add the *current* versions of the blocks to your model, change the source block path for `add_block`:

Block	Old Block Path	New Block Path
Lookup Table	simulink/Lookup Tables/Lookup Table	simulink/Lookup Tables/1-D Lookup Table

Block	Old Block Path	New Block Path
Lookup Table (2-D)	simulink/Lookup Tables/Lookup Table (2-D)	simulink/Lookup Tables/2-D Lookup Table
Lookup Table (n-D)	simulink/Lookup Tables/Lookup Table (n-D)	simulink/Lookup Tables/n-D Lookup Table

## How to Update Your Model

To update your model to use current versions of the lookup table blocks, follow these steps:

Step	Action	Reason
1	Run the Upgrade Advisor.	Identify blocks that do not have compatible settings with the 1-D Lookup Table and 2-D Lookup Table blocks.
2	For each block that does not have compatible settings: <ul style="list-style-type: none"> <li>Decide how to address each warning.</li> <li>Adjust block parameters as needed.</li> </ul>	Modify each Lookup Table or Lookup Table (2-D) block to ensure compatibility with the current versions.
3	Repeat steps 1 and 2 until you are satisfied with the results of the Upgrade Advisor check.	Ensure that block replacement works for the entire model.

After block replacement, the block names that appear in the model remain the same. However, the block icons match the ones for the 1-D Lookup Table and 2-D Lookup Table blocks. For more information about the Upgrade Advisor, see “Model Upgrades”.

## What to Expect from the Model Advisor Check

The Model Advisor check groups all Lookup Table and Lookup Table (2-D) blocks into three categories:

- Blocks that have compatible settings with the 1-D Lookup Table and 2-D Lookup Table blocks
- Blocks that have incompatible settings with the 1-D Lookup Table and 2-D Lookup Table blocks

- Blocks that have repeated breakpoints

### Blocks with Compatible Settings

When a block has compatible parameter settings, automatic block replacement can occur without backward incompatibilities.

Lookup Method in the Lookup Table or Lookup Table (2-D) Block	Parameter Settings After Automatic Block Replacement	
	Interpolation	Extrapolation
Interpolation-Extrapolation	Linear	Linear
Interpolation-Use End Values	Linear	Clip
Use Input Below	Flat	Not applicable

Depending on breakpoint spacing, one of two index search methods can apply.

Breakpoint Spacing in the Lookup Table or Lookup Table (2-D) Block	Index Search Method After Automatic Block Replacement
Not evenly spaced	Binary search
Evenly spaced and tunable	A prompt appears, asking you to select Binary search or Evenly spaced points.
Evenly spaced and not tunable	

### Blocks with Incompatible Settings

When a block has incompatible parameter settings, the Model Advisor shows a warning and a recommended action, if applicable.

- If you perform the recommended action, you can avoid incompatibility during block replacement.
- If you use automatic block replacement without performing the recommended action, you might see numerical differences in your results.

Incompatibility Warning	Recommended Action	What Happens for Automatic Block Replacement
The <b>Lookup Method</b> is Use Input Nearest or Use Input	Change the lookup method to one of the following options:	The <b>Lookup Method</b> changes to Interpolation - Use End Values.

Incompatibility Warning	Recommended Action	What Happens for Automatic Block Replacement
Above. The replacement block does not support these lookup methods.	<ul style="list-style-type: none"> <li>• Interpolation - Extrapolation</li> <li>• Interpolation - Use End Values</li> <li>• Use Input Below</li> </ul>	<p>In the replacement block, this setting corresponds to:</p> <ul style="list-style-type: none"> <li>• <b>Interpolation</b> set to <b>Linear</b></li> <li>• <b>Extrapolation</b> set to <b>Clip</b></li> </ul>
The <b>Lookup Method</b> is <b>Interpolation - Extrapolation</b> , but the input and output are not the same floating-point type. The replacement block supports linear extrapolation only when all inputs and outputs are the same floating-point type.	Change the extrapolation method or the port data types of the block.	You also see a message that explains possible numerical differences.
The block uses small fixed-point word lengths, so that interpolation uses only one rounding operation. The replacement block uses two rounding operations for interpolation.	None	You see a message that explains possible numerical differences.

### Blocks with Repeated Breakpoints

When a block has repeated breakpoints, the Model Advisor recommends that you change the breakpoint data and rerun the check. You cannot perform automatic block replacement for blocks with repeated breakpoints.

### See Also

Interpolation Using Prelookup | n-D Lookup Table | Prelookup

### More About

- “Model Upgrades”
- “About Lookup Table Blocks” on page 36-2



- “Lookup Table Glossary” on page 36-54
- “Anatomy of a Lookup Table” on page 36-4
- “Lookup Tables Block Library” on page 36-6
- “Edit Lookup Tables” on page 36-27
- “Guidelines for Choosing a Lookup Table” on page 36-8

## Lookup Table Glossary

The following table summarizes the terminology used to describe lookup tables in the Simulink user interface and documentation.

Term	Meaning
breakpoint	A single element of a breakpoint data set. A breakpoint represents a particular input value to which a corresponding output value in the table data is mapped.
breakpoint data set	A vector of input values that indexes a particular dimension of a lookup table. A lookup table uses breakpoint data sets to relate its input values to the output values that it returns.
extrapolation	A process for estimating values that lie beyond the range of known data points.
interpolation	A process for estimating values that lie between known data points.
lookup table	An array of data that maps input values to output values, thereby approximating a mathematical function. Given a set of input values, a “lookup” operation retrieves the corresponding output values from the table. If the lookup table does not explicitly define the input values, Simulink can estimate an output value using interpolation, extrapolation, or rounding.
monotonically increasing	The elements of a set are ordered such that each successive element is greater than or equal to its preceding element.
rounding	A process for approximating a value by altering its digits according to a known rule.
strictly monotonically increasing	The elements of a set are ordered such that each successive element is greater than its preceding element.

Term	Meaning
table data	An array that serves as a sampled representation of a function evaluated at a lookup table's breakpoint values. A lookup table uses breakpoint data sets to index the table data, ultimately returning an output value.

### More About

- “About Lookup Table Blocks” on page 36-2
- “Anatomy of a Lookup Table” on page 36-4
- “Lookup Tables Block Library” on page 36-6
- “Guidelines for Choosing a Lookup Table” on page 36-8



# Working With Block Masks

---

- “Masking Fundamentals” on page 37-2
- “Create a Simple Mask” on page 37-7
- “Manage Existing Masks” on page 37-16
- “Mask Callback Code” on page 37-18
- “Draw Mask Icon” on page 37-22
- “Initialize Mask” on page 37-26
- “Promote Parameter to Mask” on page 37-30
- “Control Masks Programmatically” on page 37-37
- “Pass Values to Blocks Under the Mask” on page 37-44
- “Mask Linked Blocks” on page 37-47
- “Dynamic Mask Dialog Box” on page 37-51
- “Dynamic Masked Subsystem” on page 37-55
- “Debug Masks That Use MATLAB Code” on page 37-61
- “Introduction to Model Mask” on page 37-63
- “Create and Reference a Masked Model” on page 37-64
- “Control Model Mask Programmatically” on page 37-71
- “Constraints” on page 37-73
- “Masking Example Models” on page 37-74
- “Mask a Variant Subsystem” on page 37-75

## Masking Fundamentals

A mask is a custom interface for a block that hides the block content, making it appear as an atomic block with its own icon and parameter dialog box. It encapsulates the block logic, provides controlled access to the block data, and simplifies the graphical appearance of a model.

When you mask a block, a mask definition is created and saved along with the block. A mask changes only the block interface, and not the underlying block characteristics. You can provide access to one or more underlying block parameters by defining corresponding mask parameters on the mask.

Mask a Simulink block to:

- Display a meaningful icon on a block
- Provide a customized dialog box for the block
- Provide a dialog box that enables you to access only select parameters of the underlying blocks
- Provide users customized description that is specific to the masked block
- Initialize parameters using MATLAB code

Consider the model `masking_example` that represents the equation of line  $y = mx + b$ .

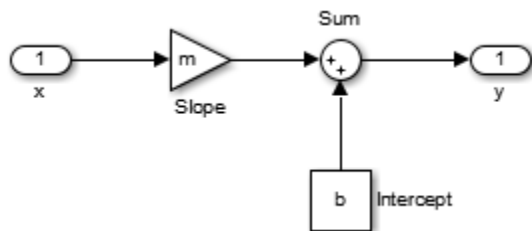

Each block has its own dialog box, making it complicated to specify the values for the line equation variables. To simplify the user interface, a mask is applied on the top-level subsystem block.

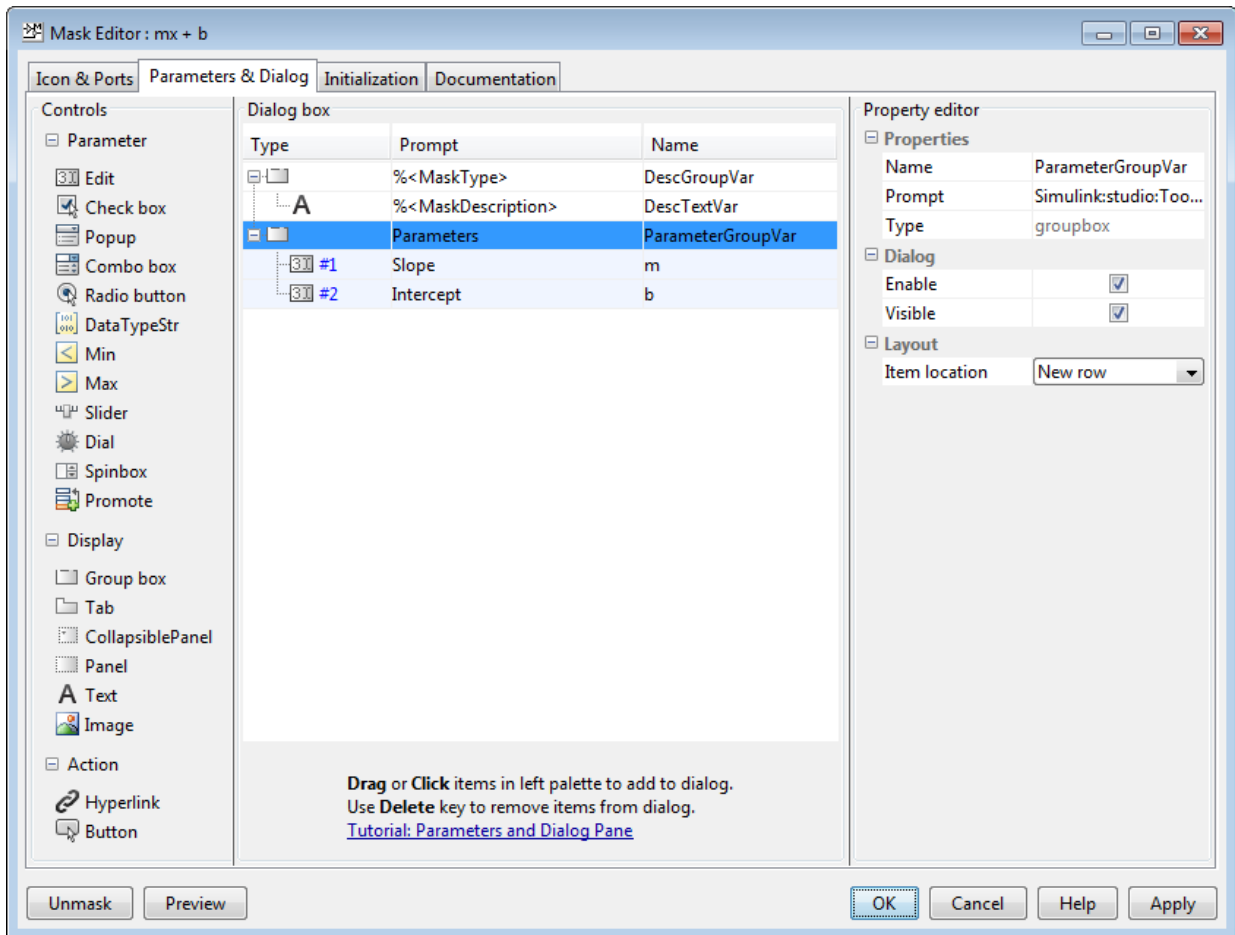

Here the variable  $m$  represents slope and the variable  $b$  represents the intercept for the line equation  $y = mx + b$ .

The mask dialog box displays the fields for **Slope** and **Intercept** that are internally mapped to variables  $m$  and  $b$ .

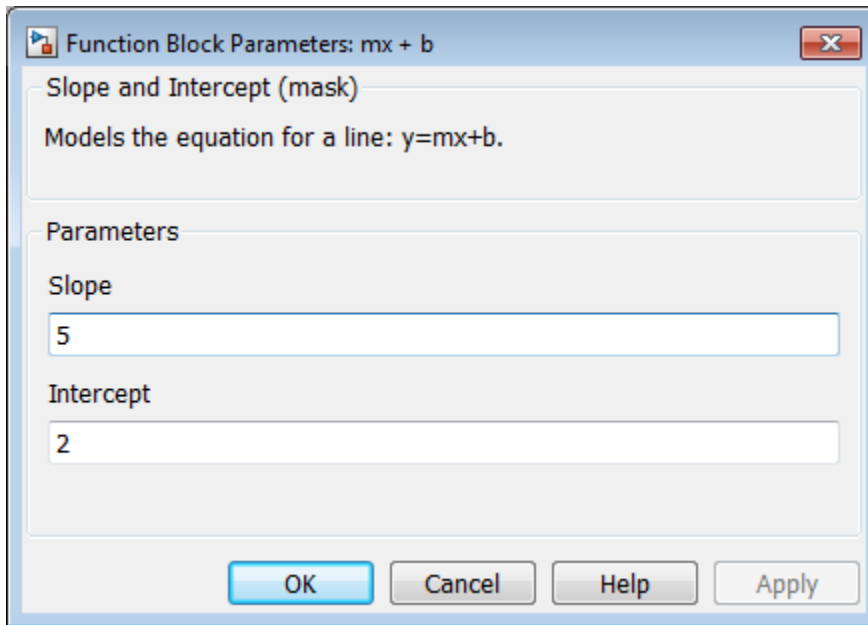

Masked blocks do not support content preview. To preview the contents of a subsystem, see “Preview Content of Hierarchical Items” on page 1-58.

**Tip:** For masking examples, see Simulink Masking Examples. The examples are grouped by type. In an example model:

- To view the mask definition, double-click the View Mask block.
- To view the mask dialog box, double-click the block.

## Masking Terminology

Term	Description
Mask icon	The masked block icon generated using drawing commands. Mask icon can be static or change dynamically with underlying block parameter values.



Term	Description
Mask parameters	The parameters that are defined in the Mask Editor and appear on the mask dialog box. Setting the value of a mask parameter on the mask dialog box sets the corresponding block parameter value.
Mask initialization code	MATLAB code that initializes a masked block or reflects current parameter values. Add mask initialization code in the <b>Initialization</b> pane of the Mask Editor dialog box. For example, add initialization code to set a parameter value automatically.
Mask dialog callback code	MATLAB code that runs in the base workspace when the value of a mask parameter changes. Use callback code to change the appearance of a mask dialog box dynamically and reflect current parameter values. For example, enable visible parameters on the dialog box.
Mask documentation	Description and usage information for a masked block defined in the Mask Editor.
Mask dialog box	A dialog box that contains fields for setting mask parameter values and provides mask description.
Mask workspace	Masks that define mask parameters or contain initialization code have a mask workspace. This workspace stores the evaluated values of the mask parameters and temporary values used by the mask.

## More About

- “Block Masks”
- “Create a Simple Mask” on page 37-7
- “Mask Editor Overview”
- Set mask parameters

- Group parameters under tabs
- Creating a Mask: Masking Fundamentals (3 min, 46 sec)

## Create a Simple Mask

You can mask a block interactively by using the Mask Editor or mask it programmatically. This example describes how to mask a block by using the **Mask Editor**. To mask a block programmatically, see “Control Masks Programmatically” on page 37-37.

For masking examples, see Simulink Masking Examples.

### Step 1: Open Mask Editor

- 1 Open the model in which you want to mask a block. For example, open `subsystem_example`.

This model contains a Subsystem block that models the equation for a line:  $y = mx + b$ .

- 2 Right-click the Subsystem block and select **Mask > Create Mask**.

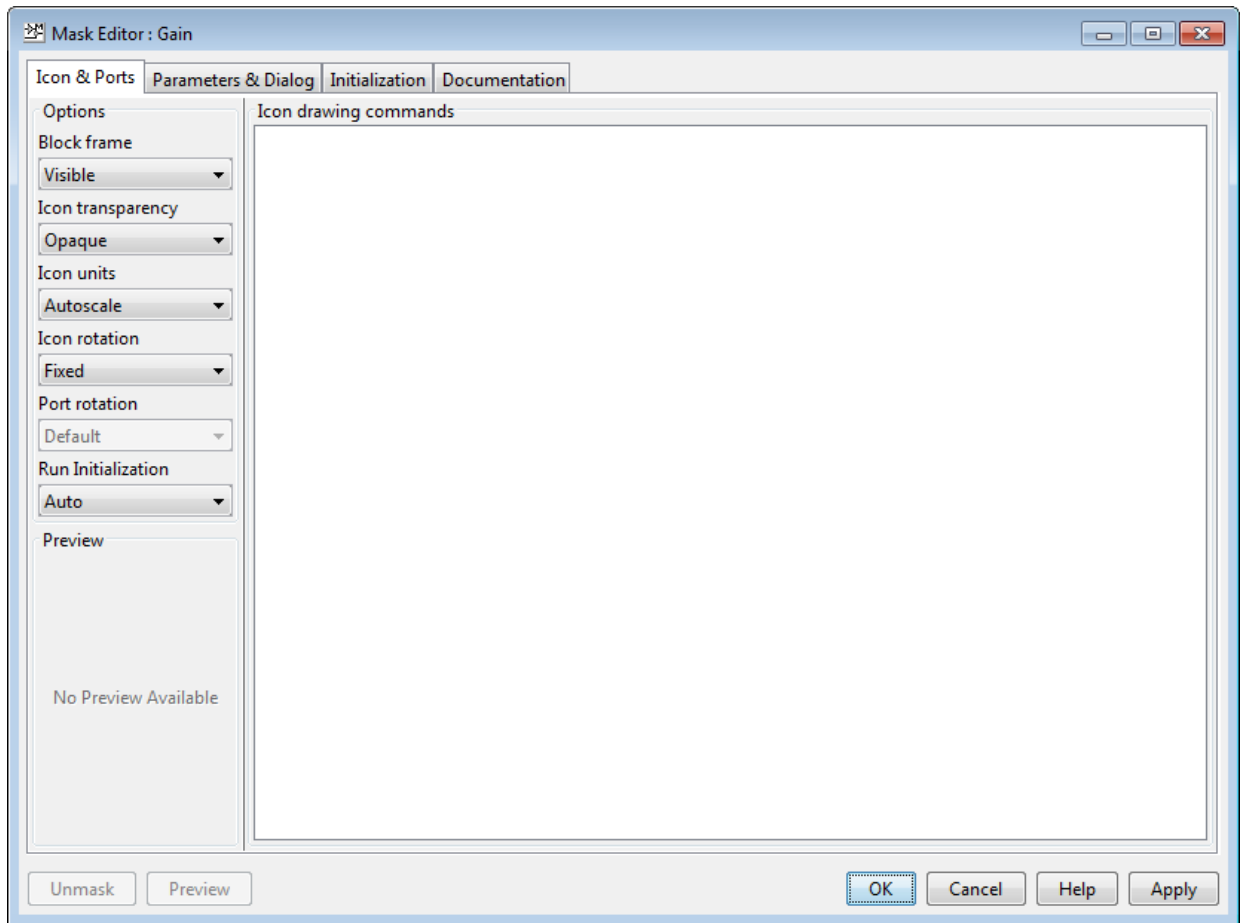

## Step 2: Define the Mask

The **Mask Editor** contains four tabs that enable you to define the block mask and customize the dialog box for the mask.

For detailed information on each pane, see “Mask Editor Overview”.

## Icon & Ports Tab

Use this tab to create an icon for the block mask. You can use the **Options** pane on the left to specify icon properties and icon visibility.

Add an image to the block mask.

- 1 In the **Block frame** drop-down box, select **Visible**.
- 2 In the **Icon transparency** drop-down box, select **Opaque**.
- 3 In the **Icon units** drop-down box, select **Autoscale**.
- 4 To restrict the icon rotation, select **Fixed** from the **Icon rotation** list.
- 5 In the **Icon drawing commands** text box, type,

```
x = [0 0.5 1 1.5];y = [0 0.5 1 1.5]; % An example to defines the variables x and y
plot(y,x) % Command to plot the graph
```

For more information on drawing command syntax, see “Icon drawing commands”.

- 6 To save the changes, click **Apply**. To preview the block mask icon without exiting the **Mask Editor**, click **Preview**

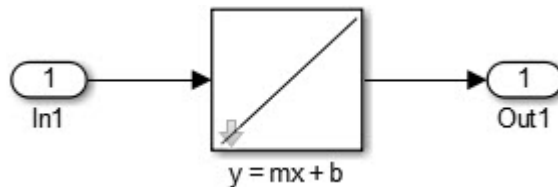

---

**Note:** For detailed information, see “Icon & Ports Pane”.

---

You can create static or dynamic block mask icons. For more information, see “Draw Mask Icon” on page 37-22 and `slexMaskDisplayAndInitializationExample`.

## Parameters & Dialog Tab

Use this tab to add controls like parameters, displays, and action items to the mask dialog box.

To add **Edit** boxes to the block mask.

- 1 In the left pane, under **Parameter**, click **Edit** twice to add two new rows in the **Dialog box** pane.
- 2 Type **Slope** and **Intercept** in the **Prompt** and **Name** columns, respectively. The value that you enter in **Prompt** column appears on the mask dialog box. The value you enter in **Name** column is the mask parameter name. The mask parameter name must be a valid MATLAB name.
- 3 In the right pane, under **Property editor**, provide values in the **Properties**, **Dialog**, and **Layout** sections.
- 4 Click **Apply**.

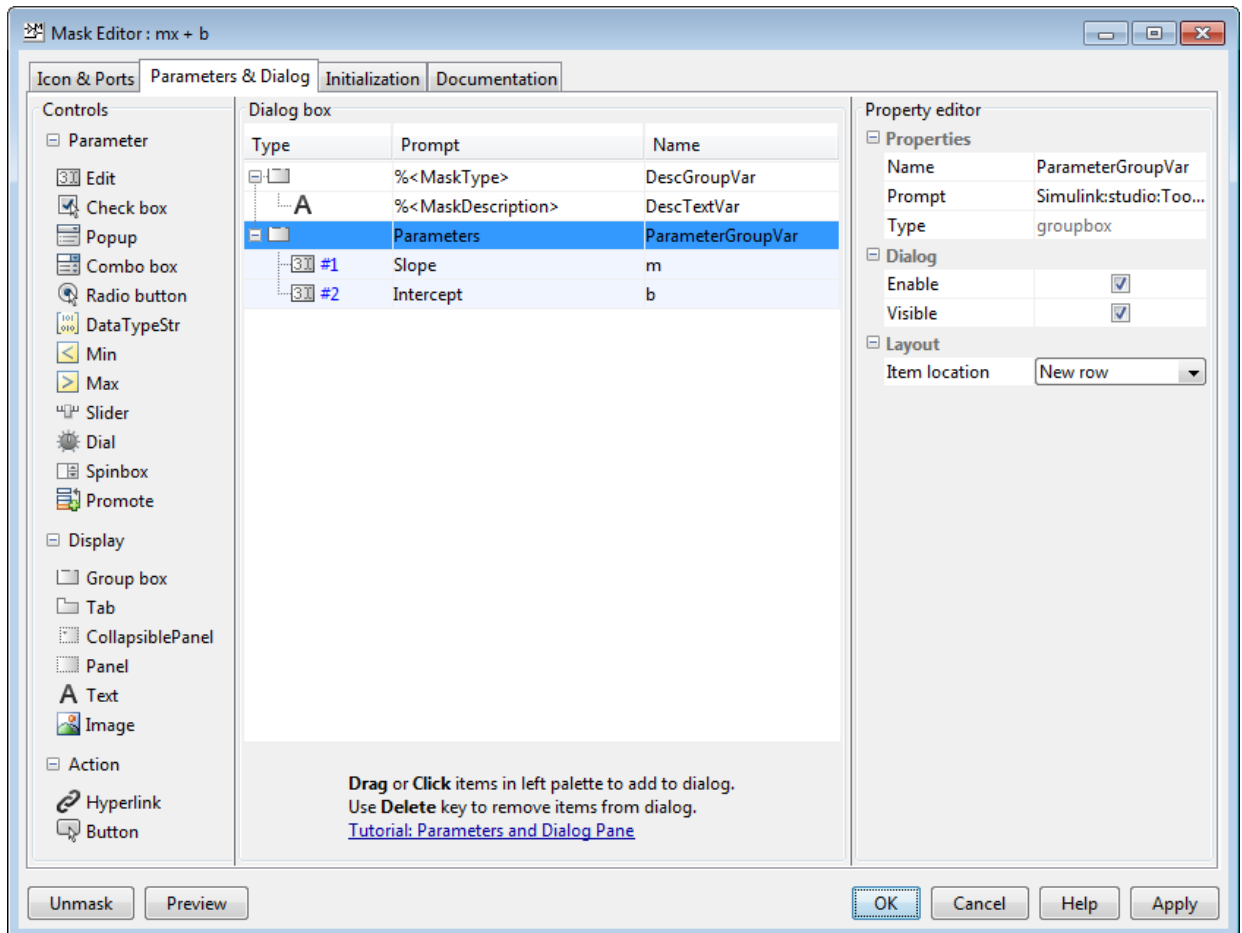

**5** To preview the mask dialog box without exiting the Mask Editor, click **Preview**.

---

**Note:** For detailed information, see “Parameters & Dialog Pane”.

---

### **Initialization Tab**

Use this pane to specify MATLAB code to control the mask parameters. You can add conditions for the user specified values, provide a predefined value for a mask parameter, and so on.

Consider the equation  $y = mx + b$ . To allow positive value for  $m$ , you can add MATLAB code in the initialization pane to specify the acceptable range for  $m$  as greater than zero.

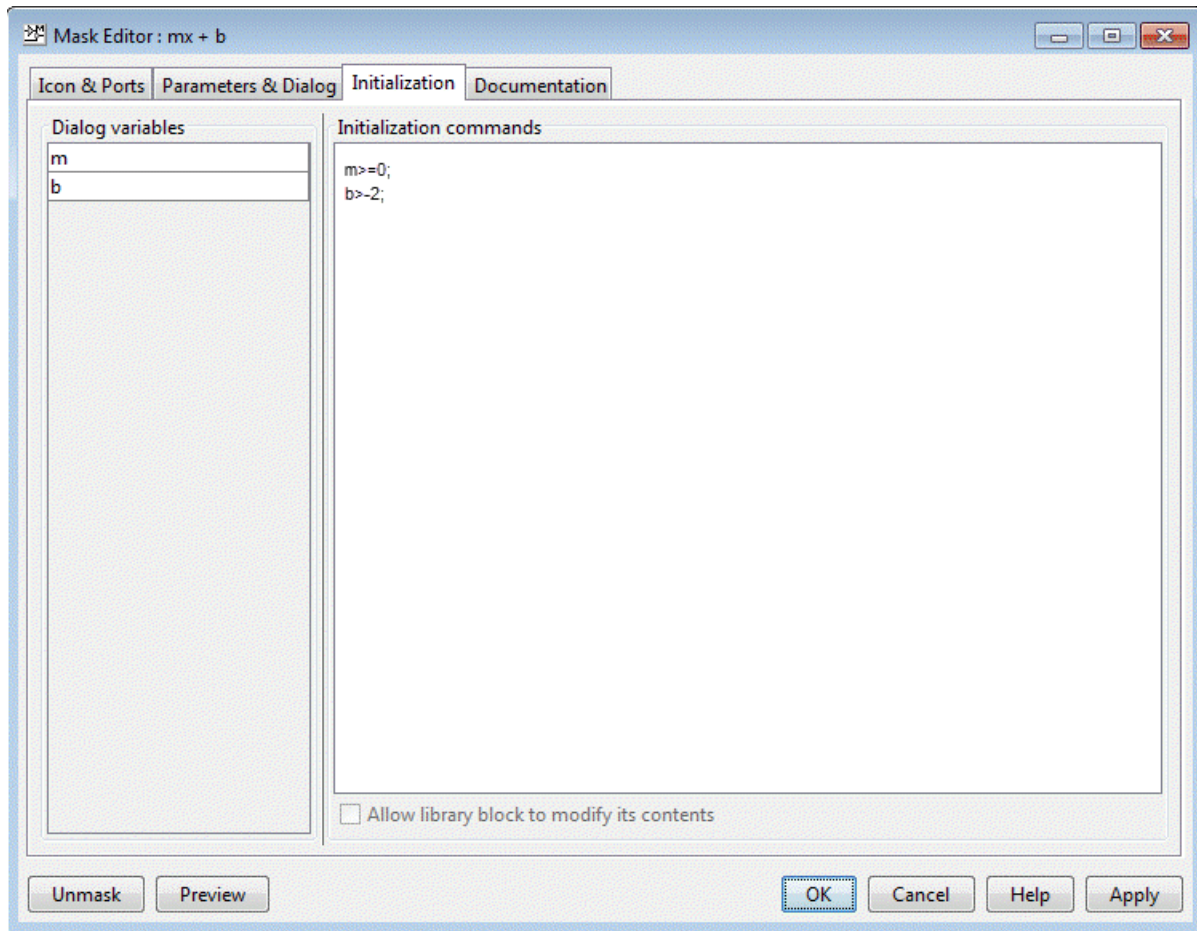

---

**Note:** For detailed information, see “Initialization Pane”.

---

### Documentation Tab

Use this tab to add a name, description, and additional information for the mask.

The **Documentation** tab contains these fields:



- 1 Type:** You can add a name for the block mask in this box. The mask name appears on top of the mask dialog box. You cannot add new lines.
- 2 Description:** You can add a description for the block mask in this box. By default, the description is displayed below the mask name, and it can contain new lines and spaces.
- 3 Help.** You can add additional information for the block mask in this box. You click **Help** on the mask dialog box, this information is displayed. You can use plain text, HTML and graphics, URLs, and web or eval commands to add information in the **Help** field.

After you have added information in the **Mask Editor**, click **Apply** or **OK**.

The block is now masked.

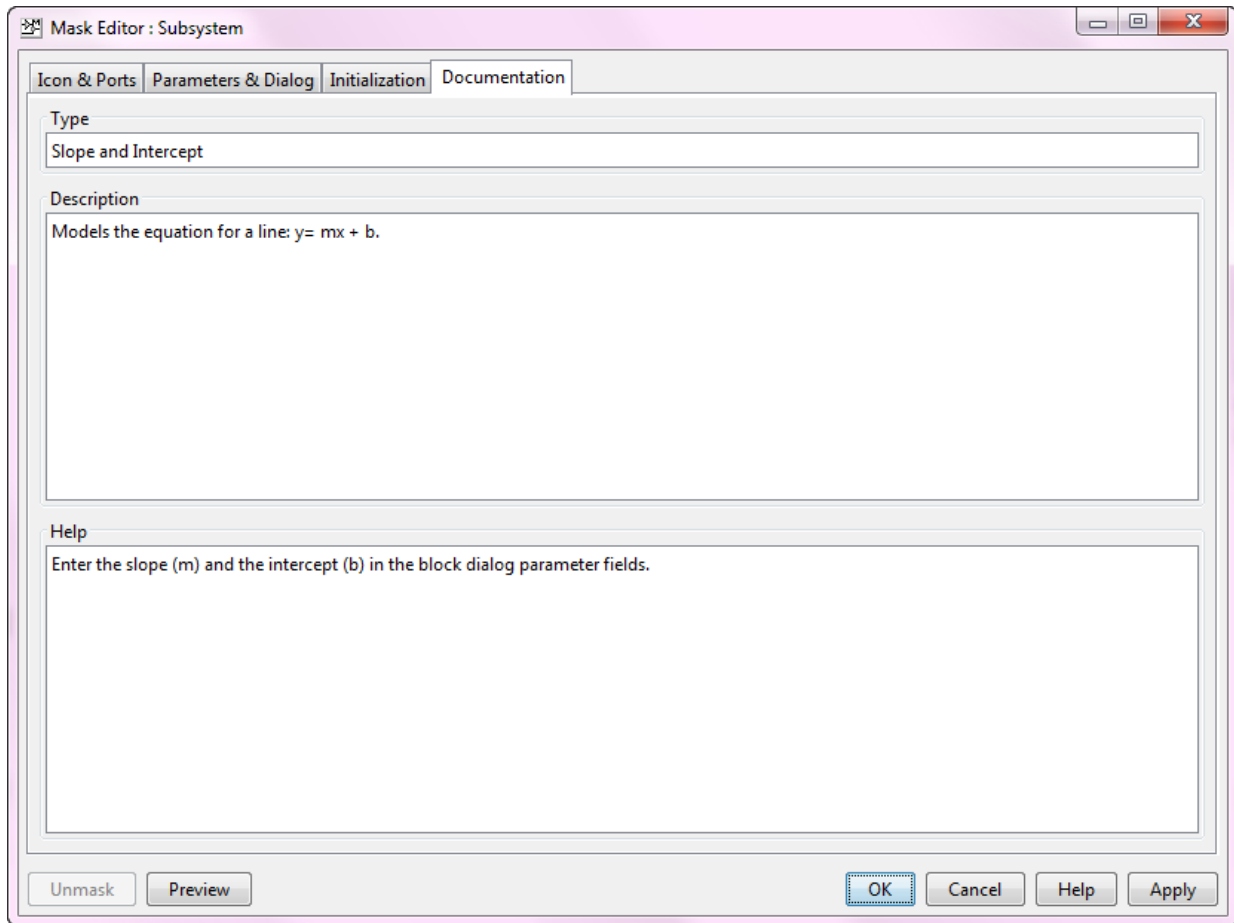

---

**Note:** For detailed information, see “Documentation Pane”.

---

### Step 3: Operate on Mask

- 1 You can preview the mask and choose to unmask the block or edit the block mask.
- 2 Double-click the masked block.

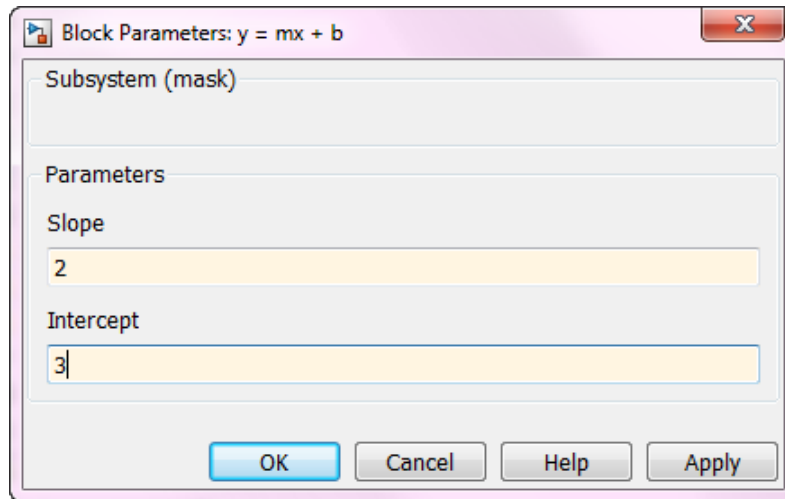

The mask dialog box appears.

- 3 Type values in the **Slope** and **Intercept** boxes of the mask dialog box. To view the output, simulate the model.
- 4 Click **OK**.
- 5 To edit the mask definition, right-click the block and select **Mask > Edit Mask**. For more information, see “Manage Existing Masks” on page 37-16.
- 6 Right-click the masked block and select **Mask > Look Under Mask** to view:
  - The blocks inside the masked subsystem
  - The built-in block dialog box of a masked block
  - The base mask dialog box of a linked masked block

## See Also

“Block Masks” | “Mask Editor Overview” | “Masking Fundamentals” on page 37-2 |  
Creating a Mask: Masking Fundamentals (3 min, 46 sec)

## Manage Existing Masks

### Change a Block Mask

You can change an existing mask by reopening the Mask Editor and using the same techniques that you used to create the mask:

- 1 Select the masked block.
- 2 Select **Mask > Edit Mask**.

The Mask Editor reopens, showing the existing mask definition. Change the mask as needed. After you change a mask, click **Apply** to preserve the changes.

### View Mask Parameters

To display a mask dialog box, double-click the block. Alternatively, right-click the block and select **Mask > Mask Parameters** or click **Diagram > Mask > Mask Parameters**.

---

**Tip:** Each block has a block parameter dialog box. To view the block parameters dialog box of a masked block, right-click the masked block and select **Block Parameters (BlockType)**.

---

### Look Under Block Mask

To see the block diagram under a masked Subsystem block, built-in block, or the model referenced by a masked model block, right-click the block and select **Mask > Look Under Mask**.

### Remove Mask

To remove a mask from a block,

- 1 Right-click the block.
- 2 Select **Mask > Edit Mask**.

The Mask Editor opens and displays the existing mask, for example:

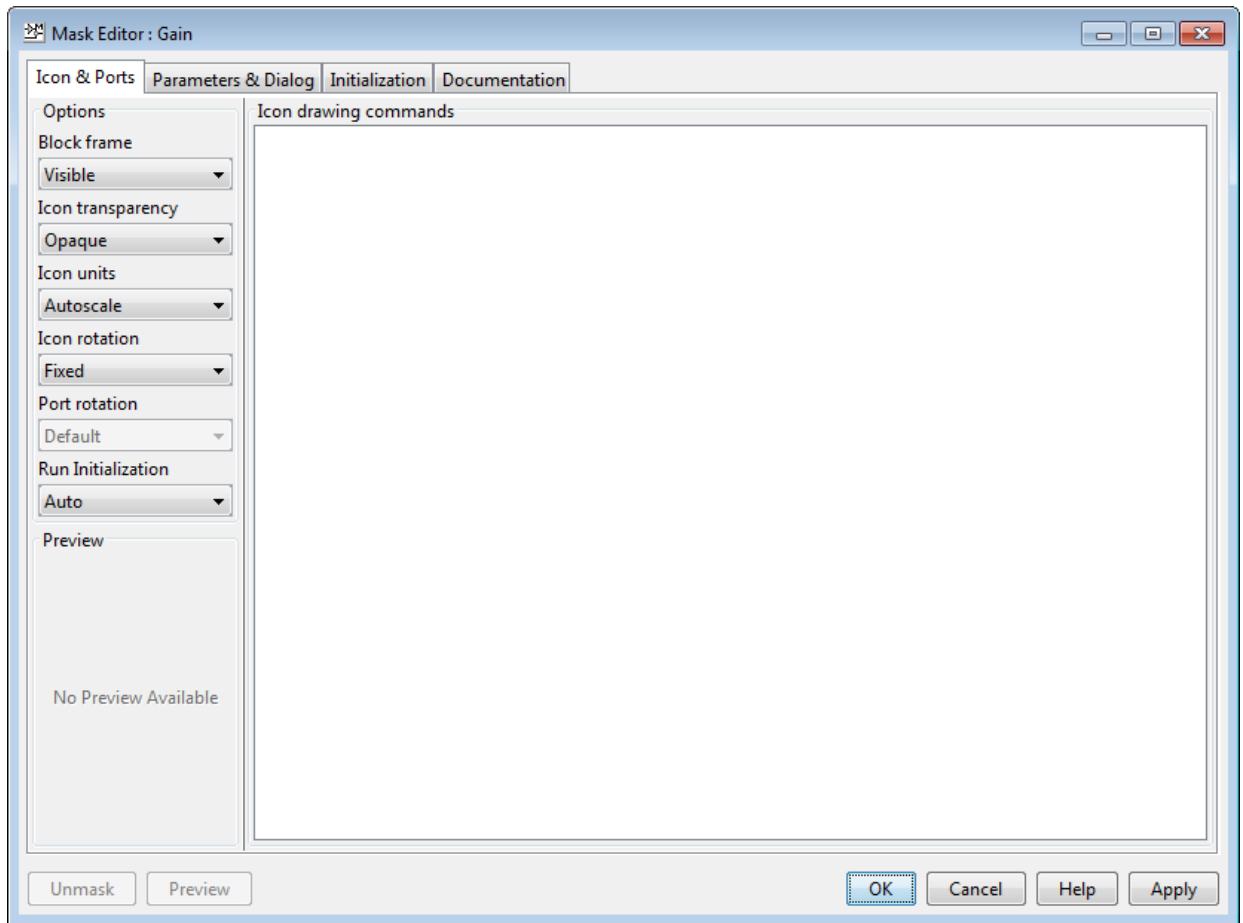

- 3 Click **Unmask** in the lower left corner of the Mask Editor.

The Mask Editor removes the mask from the block.

## See Also

“Create a Simple Mask” on page 37-7

## Mask Callback Code

### In this section...

“Add Mask Code” on page 37-18  
 “Execute Drawing Command” on page 37-18  
 “Execute Initialization Command” on page 37-19  
 “Execute Callback Code” on page 37-20

### Add Mask Code

You can use MATLAB code to initialize a mask and to draw mask icons. Since the location of code affects model performance, add your code to reflect the functionality you need.

Purpose	Add in Mask Editor	Programmatic Specification
Initialize the mask	<b>Initialization</b> pane	MaskInitialization parameter
Draw mask icon	<b>Icon &amp; Ports</b> pane	MaskDisplay parameter
Callback code for mask parameters	<b>Parameters &amp; Dialog</b> pane	MaskCallbacks parameter

### Execute Drawing Command

Place MATLAB code for drawing mask icons in the **Icon Drawing Commands** section of the **Icon & Ports** pane. Simulink executes these commands sequentially to redraw the mask icon when:

- Block is rendered first on the Mask Editor canvas.
- Mask parameters and values that depend on drawing commands change.
- Block appearance is altered due to rotation or other changes.

---

**Note:** Placing MATLAB code for drawing mask icons in the **Initialization** pane affects model performance. This behavior is because Simulink redraws the icon each time the masked block is evaluated in the model.

---

## Execute Initialization Command

Initialization commands for all masked blocks in a model run when you:

- Update the diagram
- Start simulation
- Start code generation
- Apply mask changes
- Change any of the parameters that define the mask, such as `MaskDisplay` and `MaskInitialization`, using the Mask Editor or `set_param`.
- Rotate or flip the masked block, if the icon depends on initialization commands.
- Cause the icon to be drawn or redrawn, and the icon drawing depends on initialization code.
- Change the value of a mask parameter by using the block dialog box or `set_param`.
- Copy the masked block within the same model or between different models.

When you open a model, Simulink locates visible masked blocks that reside at the top level of the model or in an open subsystem.

Simulink only executes the initialization commands for these visible masked blocks if they meet either of the following conditions:

- The masked block has icon drawing commands.

---

**Note:** Simulink does not initialize masked blocks that do not have icon drawing commands, even if they have initialization commands during model load.

---

- The masked subsystem belongs to a library and has the **Allow library block to modify its contents** parameter enabled.

When you load a model into memory without displaying it graphically, no initialization commands initially run for any masked blocks. See “Load a Model” on page 1-14 and `load_system` for information about loading a model without displaying it.

---

**Note:** The non-tunable parameters of a masked block are not evaluated if the model is already compiled (initialized).

---

## Execute Callback Code

Simulink executes the callback commands when:

- You open the mask dialog box. Callback commands execute sequentially, starting with the top mask dialog box.
- You modify a parameter value in the mask dialog box and then change the cursor location. For example, you press the **Tab** key or click into another field in the dialog box after changing the parameter value.

---

**Note:** When you modify the parameter value by using the `set_param` command, the callback commands do not execute.

---

- You modify the parameter value, either in the mask dialog box or using `set_param`, and then apply the change by clicking **Apply** or **OK**. Mask initialization commands execute after callback commands. For more information, see “Initialization Pane”.
- You hover over a masked block to see the tool tip for the block, when the tool tip contains parameter names and values.

---

**Note:** Callback commands do not execute if the mask dialog box is open when the block tool tip appears.

---

- You update a diagram (for example, by pressing **Ctrl+D** or by selecting **Simulation > Update diagram** in the Simulink Editor).
- If you close a mask dialog box without saving the changes, the Callback command for parameters is executed sequentially.

---

**Note:** Buttons on mask dialog box are unavailable when the callback code associated with the button is being executed.

---

For related Simulink example models, see:

- Sequence mask callbacks
- Unsafe mask callbacks
- Unsafe nested mask callbacks



## **See Also**

“Block Masks” | “Initialize Mask” on page 37-26

## Draw Mask Icon

You can create icons that update when you change the mask parameters to reflect the purpose of the block. This example shows how to use drawing commands to create a mask icon.

### In this section...

“Draw Static Icon” on page 37-22

“Draw Dynamic Icon” on page 37-23

## Draw Static Icon

A static mask icon remains unchanged, independent of the value of the mask parameters.

- 1 Right-click the masked block that requires the icon and select **Mask > Edit Mask**.

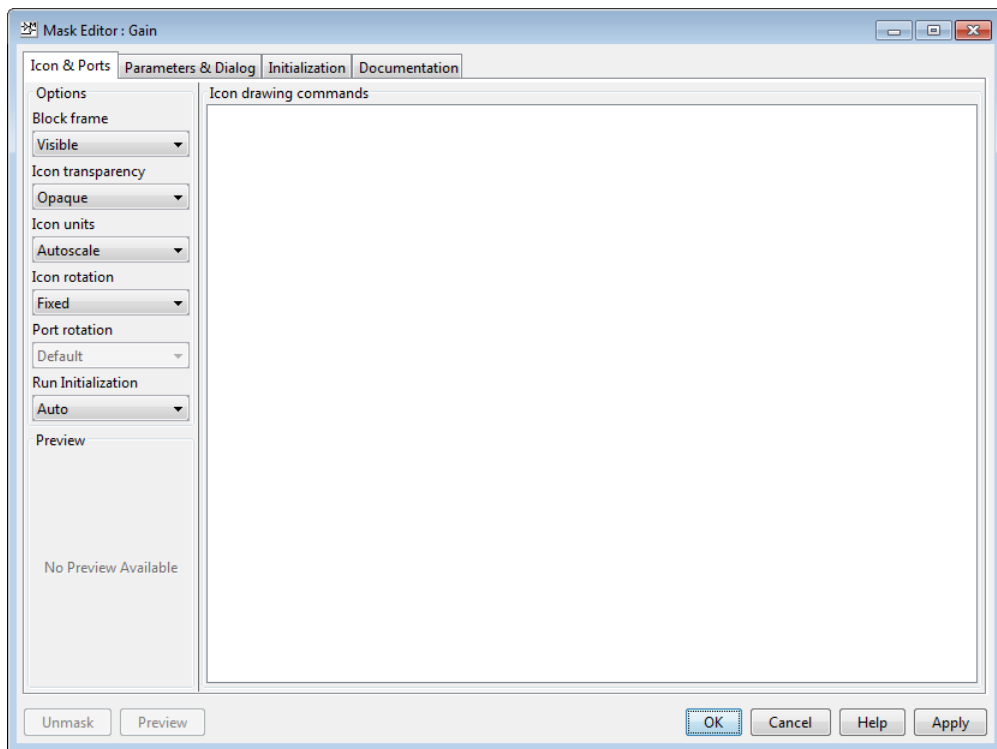

- 2 In the **Icons & Ports** tab, enter this command in the **Icon Drawing commands** pane:

```
% Use specified image as mask icon  
image('engine.jpg')
```

The image file must be on the MATLAB path.

For more examples of drawing command syntax, see “Icon drawing commands”.

Images in formats `.cur`, `.hdf4`, `.ico`, `.pcx`, `.ras`, `.xwd`, `.svg` (full version) cannot be used as block mask images. However, you can use images in these formats if you wrap the file name in the `imread()` function and use the RGB triplet. Using the `imread()` function is not efficient. However, it is still supported for backward compatibility.

## Draw Dynamic Icon

A dynamic icon changes with the values of the mask parameters. Use it to represent the purpose of the masked block.

- 1 Right-click the masked block that requires the icon and select **Mask > Edit Mask**.

The Mask Editor opens.

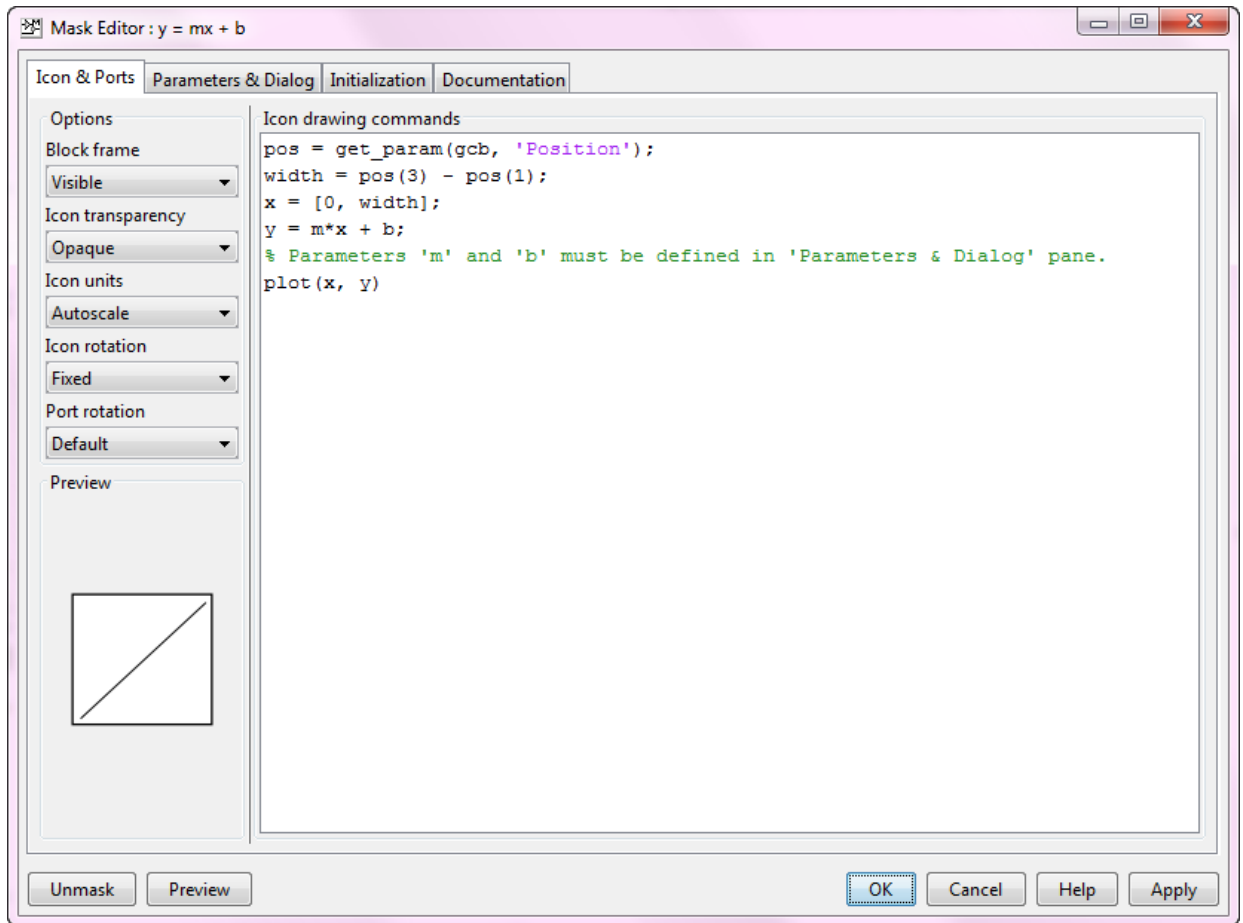

- 2 In the **Icons & Ports** tab, enter this command in the **Icon Drawing commands** pane:

```

pos = get_param(gcf, 'Position');
width = pos(3) - pos(1);
x = [0, width];
y = m*x + b;
% Parameters 'm' and 'b' must be defined in 'Parameters & Dialog' pane.
plot(x,y)

```

- 3 Under **Options**, set **Icon Units** to **Pixels**.

The drop-down lists under **Options** allow you to specify icon frame visibility, icon transparency, drawing context, icon rotation, and port rotation.

- 4 Click **Apply**. To view the icon generated, see model `masking_example`.

---

**Note:** If Simulink cannot evaluate all commands in the **Icon Drawing commands** pane to generate an icon, three question marks (? ? ?) appear on the mask.

---

See `slexMaskDisplayAndInitializationExample` for more examples of icon drawing commands. This model shows how to draw:

- Static mask
- Dynamic shape mask
- Dynamic text mask
- Image mask

## See Also

“Block Masks”

## Initialize Mask

You can add MATLAB code in the Initialization pane of the Mask Editor to initialize a masked block. Simulink executes these initialization commands to initialize a masked subsystem at critical times, such as model loading and start of a simulation run. For more information, see “Execute Initialization Command” on page 37-19.

You can add mask initialization code for these cases:

- To specify the initial values of mask parameters. For example to specify an initial value of parameter **a**, type `a = 5` in the Initialization pane.
- To specify an acceptable range of inputs for mask parameter. For example, to specify the range between 0 and 10 as the acceptable values for parameter **a**, type `0 = a > = 10`.
- To specify the value of a child block. For example,

```
set_param('Child block Name','Parameter name','Parameter Value')
```

- To create a self-modifiable mask. For more information, see Self-Modifying Mask.

The initialization code of a masked subsystem can refer only to the variables in its local workspace.

When you reference a block with, or copy a block into, a model, the mask dialog box displays the specified default values. You cannot use mask initialization code to change mask parameter default values in a library block or any other block.

---

**Note:** Blocks that contain initialization code do not work as expected when using model reference.

---

Use the Mask Editor **Initialization** pane to add MATLAB commands that initialize a masked block.

The **Initialization** pane contains these sections:

- **Dialog variables**
- **Initialization commands**

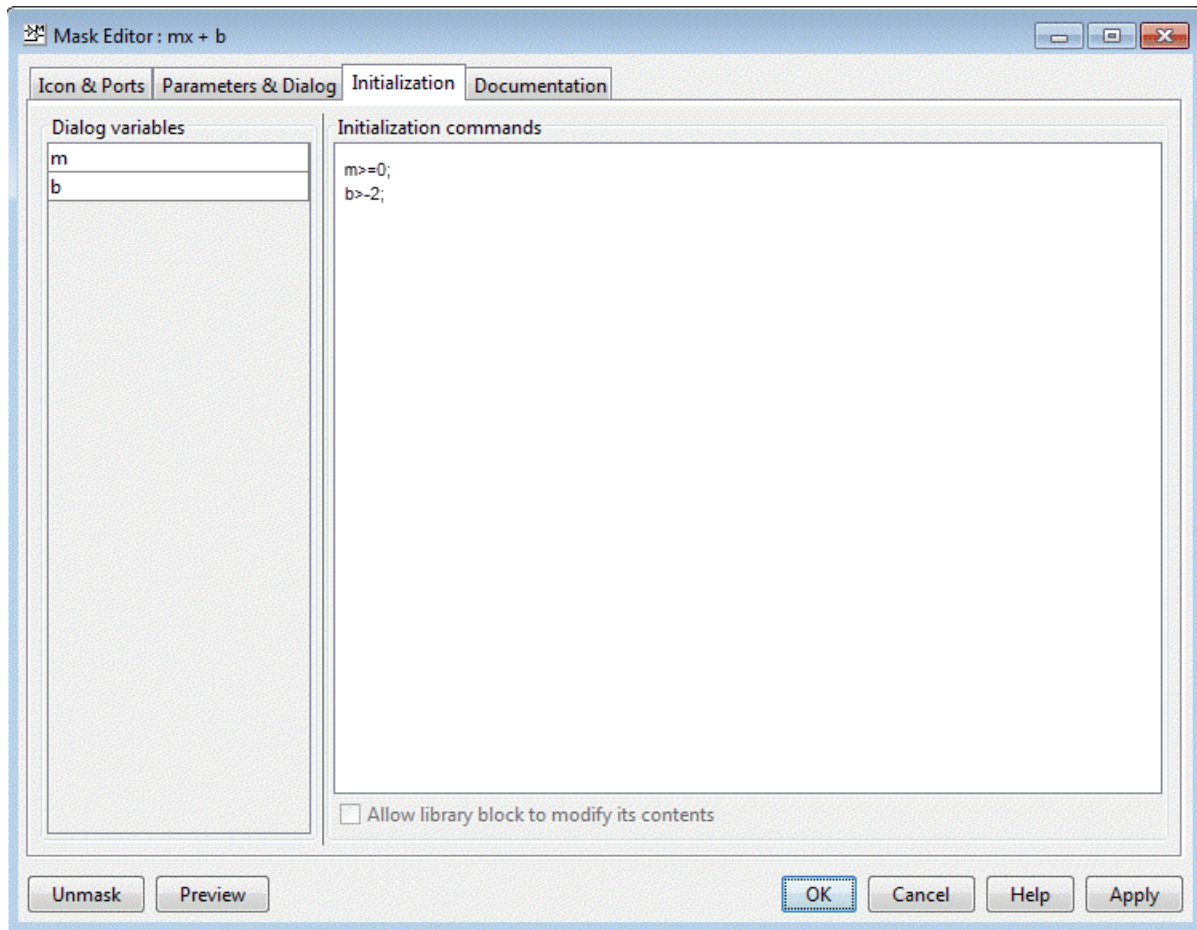

## Dialog Variables

The **Dialog variables** section displays the names of the variables associated with the mask parameters of the masked block that are defined in the **Parameters** pane.

You can copy the name of a parameter from this list and paste it into the **Initialization commands** section.

You can change the name of the mask parameter variable in the list by double-clicking and editing the name.

## Initialization Commands

You can add the initialization commands in this section. The initialization code must be a valid MATLAB expression, consisting of MATLAB functions and scripts, operators, and variables defined in the mask workspace. Initialization commands cannot access base workspace variables.

To avoid echoing results to the MATLAB Command Window, terminate initialization commands with a semicolon.

To view related examples, see

- Define mask display and initialization
- Use MATLAB graphics in masking

## Mask Initialization Best Practices

Mask initialization commands must observe the following rules:

- Do not use initialization code to create dynamic mask dialog boxes (Dialog boxes whose appearance or control settings change depending on changes made to other control settings). Instead, use the mask callbacks that are intended for this purpose. For more information, see “Dynamic Mask Dialog Box” on page 37-51.
- For nested masked subsystem, do not use `set_param` on a block located in the lower-level masked subsystem from the higher-level masked subsystem. The lower-level mask and the higher-level mask both could be initializing the same parameter of the block leading to unexpected behavior. For more information, see Unsafe Mask Callback Error.
- Do not use `set_param` commands on blocks that reside in another masked subsystem that you are initializing. Trying to set parameters of blocks in lower-level masked subsystems can trigger unresolved symbol errors if lower-level masked subsystems reference symbols defined by higher-level masked subsystems.

Suppose, for example, a masked subsystem A contains a masked subsystem B which contains Gain block C, whose `Gain` parameter references a variable defined by B. Suppose also that subsystem A has initialization code that contains this command:

```
set_param([gcb '/B/C'], 'SampleTime', '-1');
```

Simulating or updating a model containing A causes an unresolved symbol error.



- You cannot use mask initialization code to create data objects. Data objects are objects of these classes:
  - `Simulink.Parameter` and subclasses
  - `Simulink.Signal` and subclasses
- Do not add initialization code to delete the same masked block.
- Use mask initialization code to control direct child blocks only.

### **See Also**

“Block Masks” | “Masking Fundamentals” on page 37-2 | “Mask Callback Code” on page 37-18 | Self-Modifying Interface Connector

## Promote Parameter to Mask

In this section...
“Promote Underlying Parameters to Block Mask” on page 37-32
“Promote Underlying Parameters to Subsystem Mask” on page 37-34
“Unresolved Promoted Parameter” on page 37-36
“Best Practices” on page 37-36

Blocks and subsystems can have multiple parameters associated with them. Block masks allow you to expose one or more of these parameters while hiding others from view. Promoting specific parameters to the mask block simplifies the interface and enables you to specify the parameters the user of the block can view and set.

You can use the **Promote** button on the Mask Editor to promote any underlying parameter of a block either to a block mask or to a subsystem mask. The promoted block parameter gets associated with a parameter in the mask, enabling you to edit the parameter value from the mask dialog box.

Promote parameters from the block dialog box to the mask:

- To customize the mask dialog box by moving the required parameters from the block dialog box to the mask dialog box.
- To reuse a library block at different instances of a model. For each instance of the library block, you can create individual mask dialog box by promoting parameters for each block.

Consider the block dialog box of the Gain block, which has parameters such as **Gain**, **Multiplication**.

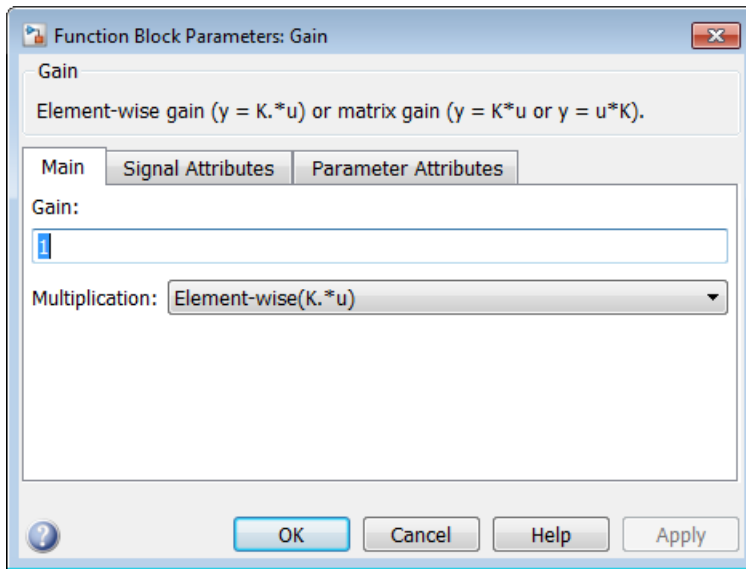

To expose only the **Gain** parameter, mask the Gain block and promote the **Gain** parameter to the mask dialog box.

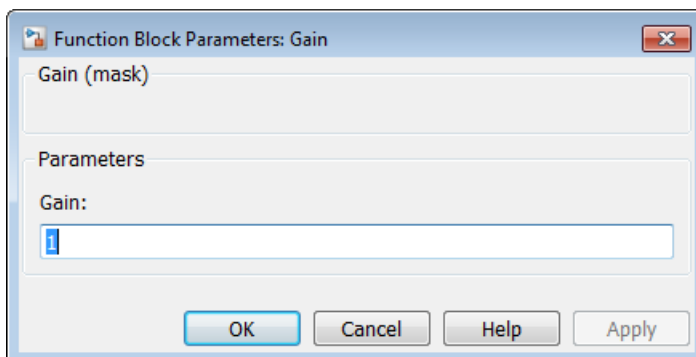

Similarly, you can mask a subsystem block and promote parameters to the mask from child blocks of the subsystem block. If the data type of subsystem child block parameters is the same, you can associate a single mask parameter with multiple promoted parameters. For example, you can promote multiple **Gain** parameters in a subsystem to a single dialog box on your mask.

If the parameter is of data type `popup` or `DataType`, the options must also be the same for the parameters to be promoted together. The **Evaluate** attribute for all the parameters to be promoted must be similar.

For a related example, see Promote mask parameters.

## Promote Underlying Parameters to Block Mask

- 1 Right-click the block whose parameter you want to promote and select **Mask > Create Mask**.
- 2 In the **Mask Editor** dialog box, click the **Parameters & Dialog** tab.
- 3 In the **Controls** pane, click **Promote**.
- 4 In the **Property editor** pane, next to **Type options**, click .

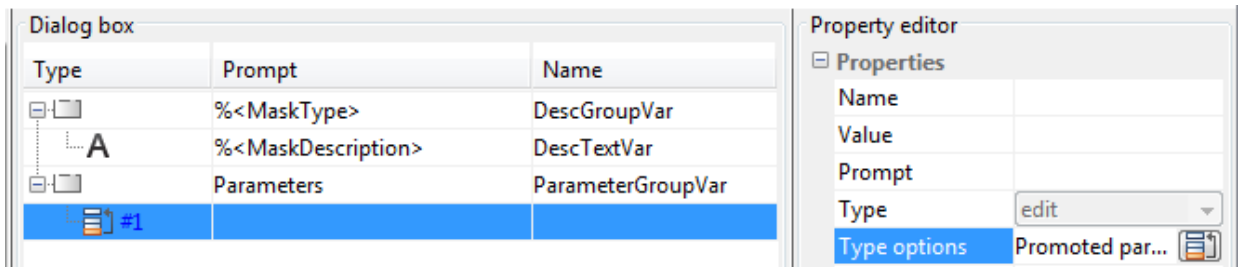

Use the **Promoted Parameter Selector** dialog box to select the parameters that you want to promote.

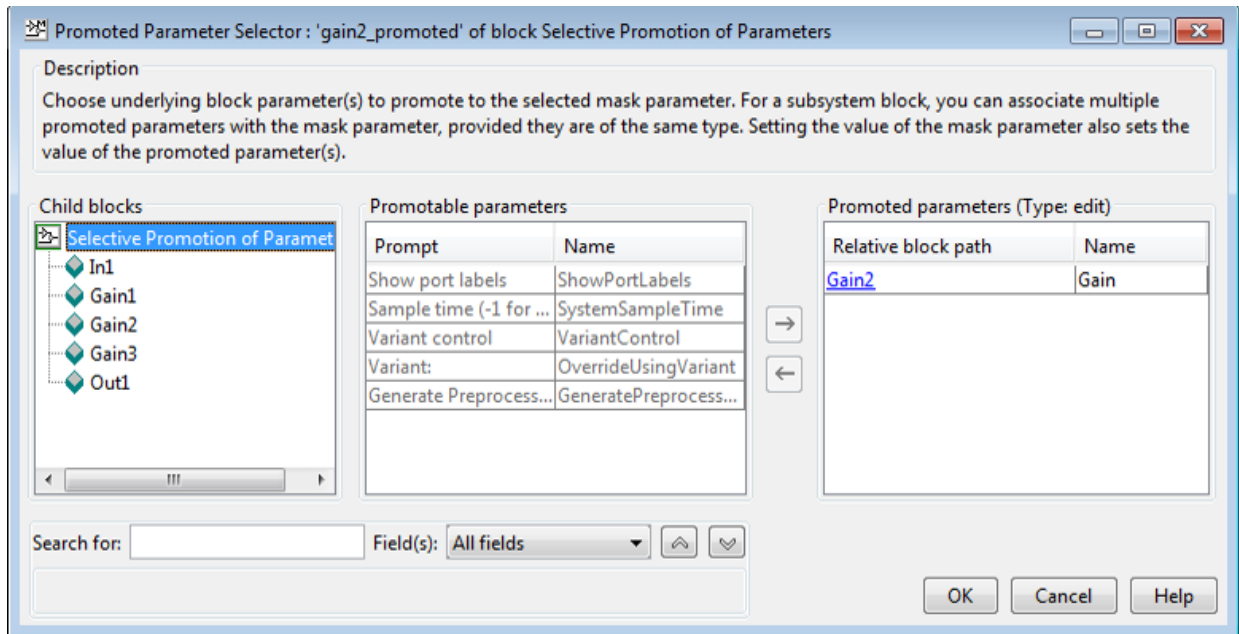

- To add a parameter to the **Promoted parameters** list, select a parameter from the **Promotable parameters** table and click the **Add to promoted parameter list** button .

To view the parameter properties such as **Type**, hover over the parameter name in the **Promotable parameter** pane.

---

**Tip:**

- You can use the **Child blocks** list or the **Search** box to find underlying block parameters to promote.
- To prevent tuning of a property during simulation, you can disable the **Tunable** attribute while promoting a tunable parameter.

- Click **OK**.
- In the **Mask Editor** dialog box, edit the prompt names for the promoted parameters and click **OK**. You cannot edit the variable names.



- 8 Click **OK**. Look at the block mask. Only the parameters you promoted are available to set.

---

**Note:**

- You can use **Promote all**  to promote all parameters. **Promote all** is available for all block masks except for subsystem masks.
  - To remove a promoted parameter, select the parameter and press **Delete** key.
  - You cannot view or promote parameters of a nested masked or linked child block.
- 

## Promote Underlying Parameters to Subsystem Mask

- 1 Right-click the subsystem and select **Mask > Create Mask**.
- 2 In the **Mask Editor** dialog box, click the **Parameters & Dialog** tab.
- 3 In the **Controls** pane, click **Promote**.
- 4 In the **Property editor** pane, next to **Type options**, click .
- 5 In the **Promoted Parameter Selector** dialog box, select the parameters that you want to promote.
- 6 To add a parameter to the **Promoted parameters** list, select a parameter from the **Promotable parameters** table and click the **Add to promoted parameter list** button .

You can add parameters of the same data type from different child blocks to the **Promoted parameters** list. For example, the **Gain** parameter from a different child block can be added to the **Promoted parameters** list to promote to the single **Gain** parameter on the mask.

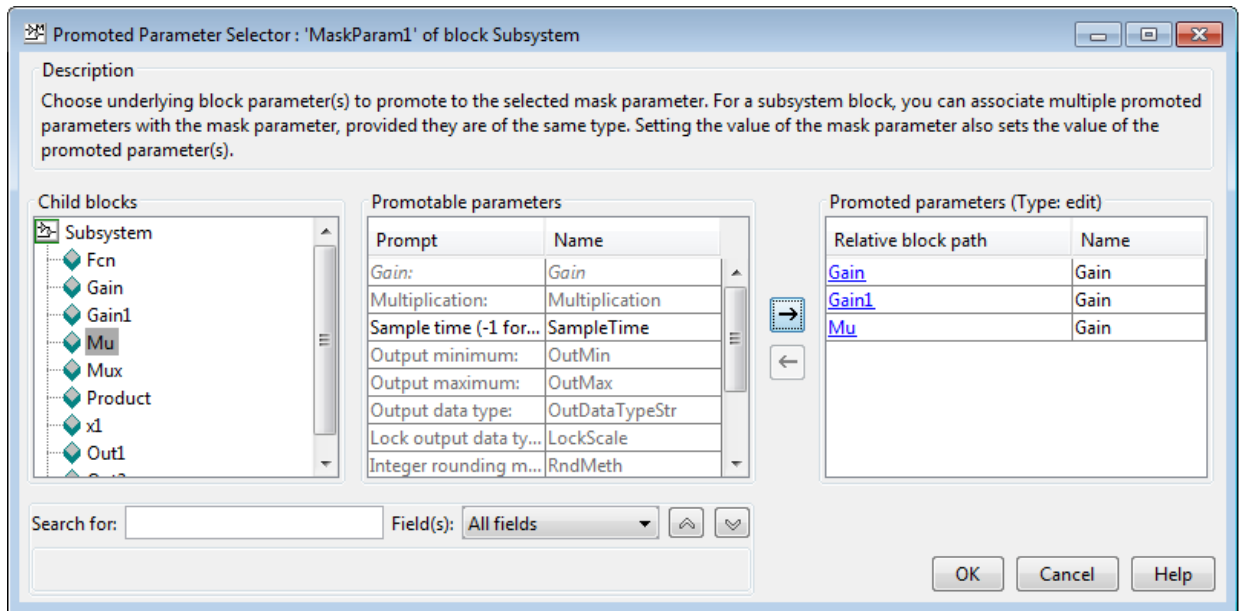

- Click **OK**.
- In the **Mask Editor** dialog box, edit the prompt names for the promoted parameters and click **OK**. You cannot edit the variable names.
- Click **OK**. Look at the block mask. Only the parameters you promoted are available to set.

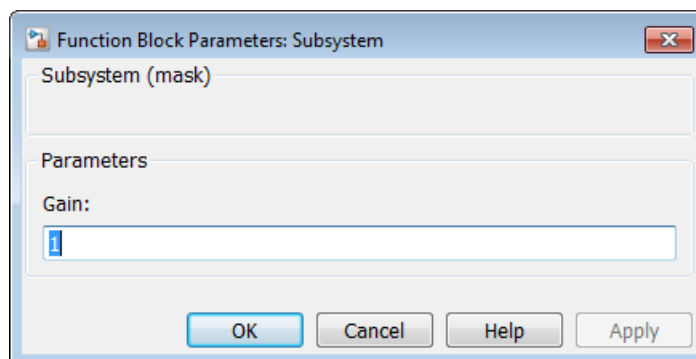

## Unresolved Promoted Parameter

When a promoted parameter is disconnected from the underlying block parameter, the promoted parameter is unresolved. Unresolved promoted parameters can cause the model to be erroneous as the promoted parameter cannot find the corresponding block parameter. Promoted parameters can become unresolved for any of these reasons:

- The underlying block is deleted.
- The underlying block is replaced with another block of same name but does not have the specified parameter.
- The underlying block is moved within another mask.

## Best Practices

- Set the value of a promoted parameter only in the mask dialog box and not in the underlying block dialog box or from the command line.
- Parameters once promoted cannot be promoted again to any other mask.
- Do not edit the **Evaluate** attribute of the promoted parameter. This property is inherited from the block parameter.
- If you are promoting a nontunable parameter, do not edit the **Tunable** attribute.
- Parameters of a masked or linked child block cannot be viewed or promoted.
- Callbacks associated with a block parameter are promoted to the block mask and not to the subsystem mask. User-defined callbacks are sequentially executed after the dynamic dialog callback execute.

## See Also

“Block Masks” | “Masking Fundamentals” on page 37-2 | “Parameter Interfaces for Reusable Components” on page 35-20



# Control Masks Programmatically

## In this section...

“Use `Simulink.Mask` and `Simulink.MaskParameter`” on page 37-37

“Use `get_param` and `set_param`” on page 37-38

“Programmatically Create Mask Parameters and Dialogs” on page 37-39

Simulink defines a set of parameters that help in setting and editing masks. To set and edit a mask from the MATLAB command line, you can use `Simulink.Mask` and `Simulink.MaskParameter` class methods. You can also use the `get_param` and `set_param` functions to set and edit masks. However, since these functions use delimiters that do not support Unicode (Non-English) characters it is recommended that you use methods of the `Simulink.Mask` and `Simulink.MaskParameter` class methods to control masks.

## Use `Simulink.Mask` and `Simulink.MaskParameter`

Use methods of `Simulink.Mask` and `Simulink.MaskParameter` classes to perform the following mask operations:

- Create, copy, and delete masks
- Create, edit, and delete mask parameters
- Determine the block that owns the mask
- Get workspace variables defined for a mask

**1** In this example the `Simulink.Mask.create` method is used to create a block mask:

```
maskObj = Simulink.Mask.create(gcb);
```

```
maskObj =
  Simulink.Mask handle
  Package: Simulink
  Properties:
      Type: ''
      Description: ''
      Help: ''
      Initialization: ''
      SelfModifiable: 'off'
```

```
        Display: ''
        IconFrame: 'on'
        IconOpaque: 'on'
RunInitForIconRedraw: 'off'
        IconRotate: 'none'
        PortRotate: 'default'
        IconUnits: 'autoscale'
        Parameters: []
Methods, Events, Superclasses
```

- 2 In this example the mask object is assigned to variable `maskObj` using the `Simulink.Mask.get` method:

```
maskObj = Simulink.Mask.get(gcb)

maskObj =
  Simulink.Mask handle
  Package: Simulink
  Properties:
      Type: ''
      Description: ''
      Help: ''
      Initialization: ''
      SelfModifiable: 'off'
      Display: ''
      IconFrame: 'on'
      IconOpaque: 'on'
RunInitForIconRedraw: 'off'
      IconRotate: 'none'
      PortRotate: 'default'
      IconUnits: 'autoscale'
      Parameters: [1x1 Simulink.MaskParameter]
  Methods, Events, Superclasses
```

For examples of other mask operations, like creating and editing mask parameters and copying and deleting masks see `Simulink.Mask` and `Simulink.MaskParameter` .

## Use `get_param` and `set_param`

The `set_param` and `get_param` functions have parameters for setting and controlling the mask. You can use these functions to set the mask of any block in the model or library based on a value passed from the MATLAB command line:

```
set_param(gcb, 'MaskStyleString', 'edit,edit', ..
```

```

'MaskVariables', 'maskparameter1=@1;maskparameter2=&2;',...
'MaskPromptString', 'Mask Parameter 1:|Mask Parameter 2:',...
'MaskValues', {'1', '2'});

get_param(gcb, 'MaskStyleString');

set_param(gcb, 'MaskStyles', {'edit', 'edit'}, 'MaskVariables',...
'maskparameter1=@1;maskparameter2=&2;', 'MaskPrompts',...
{'Mask Parameter 1:', 'Mask Parameter 2:'},...
'MaskValueString', '1|2');

get_param(gcb, 'MaskStyles');

```

where

- | separates individual character vector values for the mask parameters.
- @ indicates that the parameter field is evaluated.
- & indicates that the parameter field is not evaluated but assigned as a character vector.

---

**Note:** When you use `get_param` to get the Value of a mask parameter, Simulink returns the value that was last applied using the mask dialog. Values that you have entered into the mask dialog but not applied are not reflected when you use the `get_param` command.

---

To control the mask properties programmatically for a release before R2014a, see Mask Parameters.

## Programmatically Create Mask Parameters and Dialogs

This example shows how to create this simple mask dialog, add controls to the dialog, and change the properties of the controls.

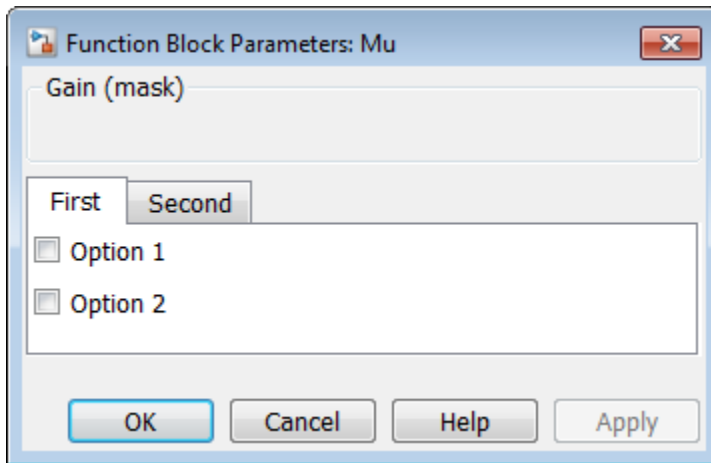

- 1 Create the mask for a block you selected in the model.

```
maskobj = Simulink.Mask.create(gcb);
```

- 2 Create parameters for the mask. You can change the location of these parameters on the dialog in a subsequent step.

```
maskobj.AddParameter('Type','checkbox','Prompt','Option 1',...
    'Name','option1');
maskobj.AddParameter('Type','checkbox','Prompt','Option 2',...
    'Name','option2');
```

These commands create a mask dialog with the default layout. Simulink adds the two parameters to the **Parameters** group, which is internally named as `ParameterGroupVar` by default.

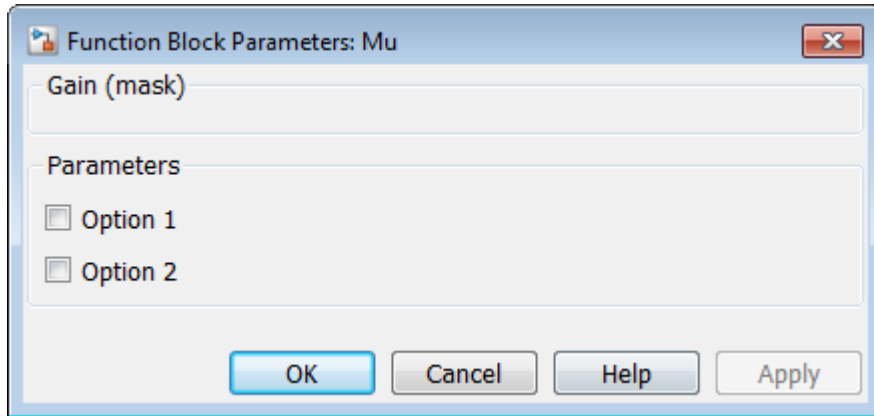

You can verify the group name programmatically.

```
dlg = maskobj.getDialogControls();
dlg(2)

ans =
  Group with properties:
    Name: 'ParameterGroupVar'
    Prompt: 'Simulink:studio:ToolBarParametersMenu'
    Row: 'new'
    Enabled: 'on'
    Visible: 'on'
    DialogControls: [1x1 Simulink.dialog.parameter.CheckBox]
```

- 3 To customize the dialog and to use tabs instead of the default group, remove the **Parameters** group box.

```
maskobj.removeDialogControl('ParameterGroupVar');
```

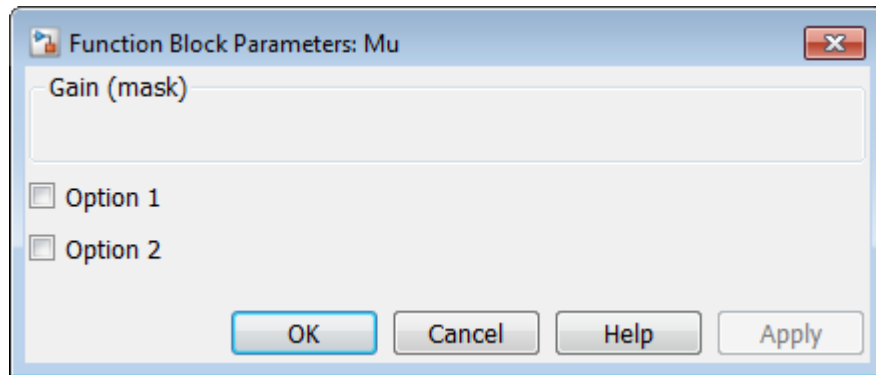

Simulink preserves the child dialog controls— the two check boxes in this example—even when you delete the `ParametersGroupVar` group surrounding them. These controls are parameters, that cannot be deleted using dialog control methods.

You can delete parameters using methods such as `Simulink.Mask.removeAllParameters`, which belongs to the `Simulink.Mask` class.

- 4 Create a tab container and get its handle.

```
tabgroup = maskobj.addDialogControl('tabcontainer', 'tabgroup');
```

- 5 Create tabs within this tab container.

```
tab1 = tabgroup.addDialogControl('tab', 'tab1');
tab1.Prompt = 'First';
tab2 = tabgroup.addDialogControl('tab', 'tab2');
tab2.Prompt = 'Second';
tab3 = tabgroup.addDialogControl('tab', 'tab3');
tab3.Prompt = 'Third (invisible)';
```

Make the third tab invisible.

```
tab3.Visible = 'off'
```

```
tab3 =
```

Tab with properties:

```
    Name: 'tab3'
    Prompt: 'Third (invisible)'
```

```
Enabled: 'on'  
Visible: 'on'  
DialogControls: []
```

For more information on dialog controls and their properties, type `help Simulink.dialog.Control` at the MATLAB command line.

## See Also

“Block Masks” | “Masking Fundamentals” on page 37-2 | “Initialize Mask” on page 37-26

## Pass Values to Blocks Under the Mask

A masked block can pass values to the block parameters under the mask. The underlying blocks use the passed values during simulation to execute the block logic.

A masked block has variables associated with mask parameters. These variables are stored in the mask workspace for a model and can correspond to a block parameter under the mask. When such a block is evaluated, the block variables look for matching values in the mask workspace to get a value.

The mapping of variables from the mask workspace to the base workspace must be correct. A correct mapping ensures that the right block variable is assigned the value that is passed from the mask.

Use any of these options to pass values to blocks under the mask:

- Parameter promotion (recommended)
- Mask initialization
- Referencing block parameters using variable names (For the Edit Parameter only)

### Parameter Promotion

When you promote a block parameter to its mask, the block parameter becomes accessible from the mask dialog box, allowing you to pass a value for the block parameter. Parameter promotion ensures correct mapping of parameter values and is a recommended way to pass values to the block from the mask dialog box. For more information on promoting a parameter, see “Promote Parameter to Mask” on page 37-30.

### Mask Initialization

You can use MATLAB code in the Initialization pane of the Mask Editor to assign or pass values to the block parameters under the mask. You can assign a fixed value to a block parameter, specify an acceptable range for the input values, or specify a value for the child block. For more information, see “Initialize Mask” on page 37-26.

### Referencing Block Parameters Using Variable Names

You can add an Edit parameter to the mask dialog box and pass values to the block parameters through it. The values that you provide for the Edit parameter in the mask



dialog box automatically becomes associated with the block parameter, by using the techniques described in “Symbol Resolution” on page 57-118.

Consider the model `masking_example`, which contains a masked Subsystem block and governs the equation  $y = mx + b$ . Here,  $m$  and  $b$  are variables controlling the slope and intercept of the equation and are associated with the Gain and the Constant block, respectively.

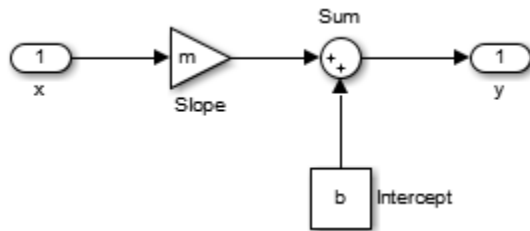

The variables  $m$  and  $b$  are assigned to the mask parameters **Slope** and **Intercept**, respectively, as parameter names in the Mask Editor.

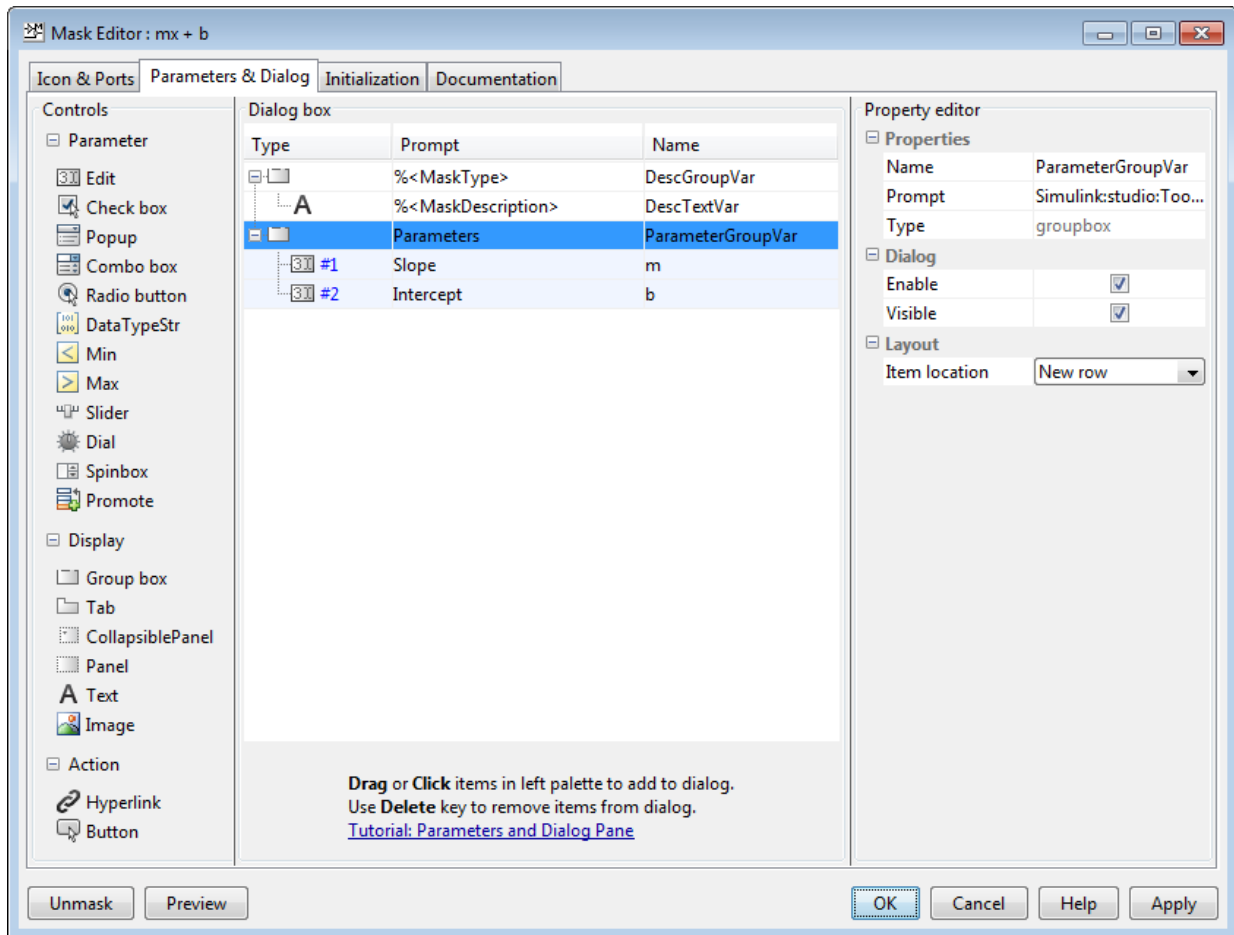

When you type values for **Slope** and **Intercept** in the mask dialog box, these values are internally assigned to the variables **m** and **b**. When the model is simulated, the Gain block and the Constant block search for numeric values of **m** and **b** and apply them to resolve the equation  $y = mx + b$ .

## See Also

“Block Masks” | “Masking Fundamentals” on page 37-2 | Creating a Mask: Masking Fundamentals (3 min, 46 sec)

## Mask Linked Blocks

**In this section...**

“Guidelines for Mask Parameters” on page 37-49

“Mask Behavior for Masked, Linked Blocks” on page 37-49

“Mask a Linked Block” on page 37-50

Simulink libraries can contain blocks that have masks. An example of this type of block is the Ramp block. These blocks become library links when copied to a model or another library. You can add a mask on this linked block. If this linked block is in a library and copied again, you can add another mask to this new linked block thus creating a stack of masks. Masking linked blocks allows you to add a custom interface to the link blocks similar to other Simulink blocks.

You can also apply a mask to a block, then include the block in a library. Masking a block that is later included in a library requires no special provisions. For more information, see “Create a Custom Library” on page 39-4.

The block mask that is present as part of the library is the base mask. A derived mask is the one created on top of the base mask.

For example, in the figure, Library A contains Block A, which has a Mask A. Block A is copied to Library B, and Mask B is added to it. When Block A is copied to Library B, a library link from Library B to Library A is created.

Block B is then copied to a model, and Mask C is added to it. This creates a library link from Block C to Library B. Block C now has Mask A, Mask B, and Mask C. Mask C is the derived mask and Mask B is the base mask.

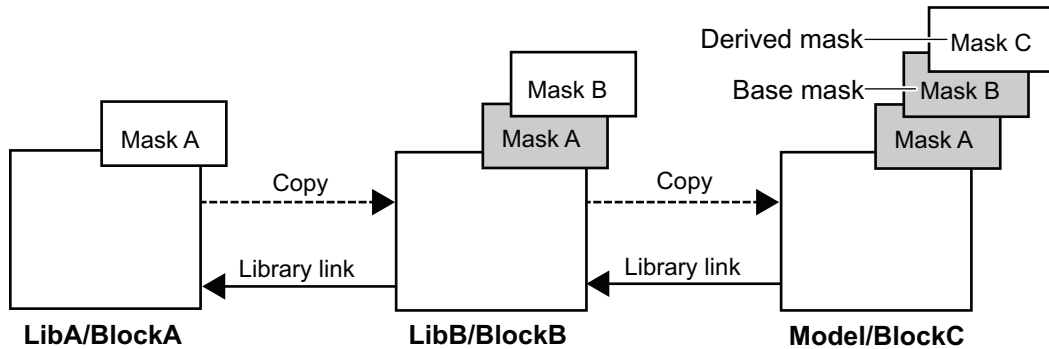

For Block C:

- Mask parameter names are unique in the stack.
- You can set mask parameters for Mask B and Mask C.
- Mask B and Mask C inherit `MaskType` and `MaskSelfModifiable` parameters from Mask A.
- Mask initialization code for Mask C executes first, followed by Mask B and Mask A.
- Variables are resolved starting from the mask immediately above the current mask in the stack. If the current mask is the top mask, it follows the regular variable resolution rules.

Creating or changing a library block mask changes the block interface in all models that access the block using a library reference, but has no effect on instances of the block that exist as separate copies.

To view related example, see [Use self-modifying library masks](#).

## Guidelines for Mask Parameters

- You cannot use same names for the mask parameters. The exception is the **Promote** type mask parameter, for which the name is inherited and is the same as that of the parameter promoted to it.
- You cannot set mask parameters for masks below the base mask. Mask parameters for masks below the base mask are inherited from the library.

## Mask Behavior for Masked, Linked Blocks

The following are some of the behaviors that are important to understand about masked, linked blocks.

- The **MaskType** and the **MaskSelfModifiable** parameters are inherited from the base mask.
- The mask display code for the derived mask executes first, followed by the display code for the masks below it until we come across a mask whose **MaskIconFrame** parameter is set to **opaque**.
- The mask initialization code for the derived mask executes first, followed by the initialization code for the masks below it.
- Variables are resolved starting from the mask immediately above the current mask in the stack. If the current mask is the top mask, the regular variable resolution rules apply.
- When you save a Simulink model or library containing a block with multiple masks, using **File > Export Model to > Previous Version**, the **SourceBlock** parameter is modified to point to the library block having the bottom-most mask.
- The following occurs when you disable, break, or reestablish links to libraries:
  - If you disable the link to the library block, the entire mask hierarchy is saved to the model file so that the block can act as a standalone block.
  - If you break the link to the library block, the block becomes a standalone block.
  - If you reestablish the link after disabling by doing a restore, all changes to the mask are discarded. If you mask subsystems, you must reestablish the link after disabling by doing a push. When you do a push, subsystem changes are pushed to the library block and top mask changes are pushed to the immediate library.

## Mask a Linked Block

### Step 1: Create Custom Library with Masked Linked Block

- 1 In the **Simulink Library Browser**, click the arrow next to  and select **New Library**.
- 2 Open the Ramp block in the Library editor window.
- 3 Right-click the Ramp block and select **Mask > Create Mask**.  
The **Mask Editor** opens.
- 4 In the **Icon drawing commands** section of the **Icons & Ports** pane, type:  

```
plot ([0:10],[0,1:10])
```
- 5 In the **Parameter & Dialog** pane, select  **Promote** to promote the Slope and Initial Output parameters.
- 6 Click **OK**.
- 7 Rename the block to Derived Ramp block.

### Step 2: Add a Mask to the Masked, Link Block

- 1 In the **Simulink Library Browser**, click the arrow next to  and select **New Model**. The Model editor window opens.
- 2 Drag the Derived Ramp block from the Library editor to the Model editor.  
The Derived Ramp block in the model has multiple masks on it. You can set parameters of the derived mask.

### Step 3: View Masks Below the Top Mask

- Right click the Derived Ramp block in the model and select **Mask > View Base Mask**. This opens the **Mask Editor** displaying the base mask definition.

## See Also

“Block Masks” | “Linked Blocks” on page 39-15

## Dynamic Mask Dialog Box

### In this section...

“Show Parameter” on page 37-51

“Enable Parameter” on page 37-52

“Create Dynamic Mask Dialog Box” on page 37-52

“Set Up Nested Masked Block Parameters” on page 37-53

You can create dialogs for masked blocks whose appearance changes in response to user input. Features of masked dialog boxes that can change in this way include:

- Visibility of parameter controls — Changing a parameter can cause the control for another parameter to appear or disappear. The dialog expands or shrinks when a control appears or disappears, respectively.
- Enabled state of parameter controls — Changing a parameter can cause the control for another parameter to be enabled or disabled for input. A disabled control is grayed to indicate visually that it is disabled.
- Parameter values — Changing a mask dialog box parameter can cause related mask dialog box parameters to be set to appropriate values.

Creating a dynamic masked dialog box entails using the Mask Editor with the `set_param` command. Specifically, you use the Mask Editor to define parameters of the dialog box, both static and dynamic. For each dynamic parameter, you enter a callback function that defines how the dialog box responds to changes to that parameter (see “Execute Callback Code” on page 37-20). The callback function can in turn use the `set_param` command to set mask parameters that affect the appearance and settings of other controls on the dialog box (see “Create Dynamic Mask Dialog Box” on page 37-52). Finally, you save the model or library containing the masked subsystem to complete the creation of the dynamic masked dialog box.

To view related example, see [Create dynamic mask dialog boxes](#).

### Show Parameter

The selected parameter appears on the mask dialog box only if this option is checked (the default).

## Enable Parameter

Clearing this option grays the prompt of the selected parameter and disables the edit control of the prompt.

## Create Dynamic Mask Dialog Box

This example shows how to create a mask dialog blocks whose appearance changes in response to your input.

You can set two parameters using this mask dialog box. The first parameter is a popup menu through which you select one of three gain values: **2**, **5**, or **User-defined**. Depending on the value that you select in this popup menu, an edit field for specifying the gain appears or disappears.

- 1** Mask a subsystem by right-clicking the block and selecting **Mask > Create Mask**.
- 2** Select the **Parameters & Dialog** pane on the Mask Editor.
- 3** Drag and drop a **Popup** parameter and select it in the **Dialog box** pane.
  - a** In the **Prompt** field, enter **Gain**.
  - b** In the **Name** field, enter **gainpopup**.
  - c** In the Property editor pane, clear **Evaluate** so that Simulink uses the literal values you specify for the popup.
  - d** In the **Type options** field, click the **Edit** button to enter these three values in the Popup Options dialog box:

```
2
5
User-defined
```

- 4** Enter this code in the **Dialog callback** field:

```
% Get the mask parameter values. This is a cell
% array of character vectors.
maskStr = get_param(gcb, 'gainpopup');

% The pop-up menu is the first mask parameter.
% Check the value selected in the pop-up
if strcmp(maskStr(1), 'U'),

    % Set the visibility of both parameters on when
```



```

    % User-defined is selected in the pop-up.
    set_param(gcf,'MaskVisibilities',{'on';'on'}),
else
    % Turn off the visibility of the Value field
    % when User-defined is not selected.
    set_param(gcf,'MaskVisibilities',{'on';'off'}),

    % Set the character vector in the Values field equal to the
    % character vector selected in the Gain pop-up menu.

    %maskStr{2}=maskStr{1};
    set_param(gcf,'editvalue',maskStr);
end

```

- 5 Drag and drop an **Edit** parameter and select it in the **Dialog box** pane.
  - a In the **Prompt** field, enter **Value**.
  - b In the **Name** field, enter **editvalue**.
  - c In the Property editor pane, clear **Visible** so that Simulink turns off the visibility of this property by default.
- 6 Click **Apply**.
- 7 To open the mask dialog box, double-click the masked subsystem .

If you select 2 or 5 as the **Gain**, Simulink hides the **Value**. If you select **User-defined** as the **Gain** the **Value** is visible.

## Set Up Nested Masked Block Parameters

If lower-level masked subsystems reference symbols defined by higher-level masked subsystems and you try to set parameters of blocks in lower-level masked subsystems, unresolved symbol errors can occur. Therefore, avoid using `set_param` commands to set parameters of blocks residing in masked subsystems that reside in the masked subsystem being initialized. Trying if lower-level masked subsystems reference symbols defined by higher-level masked subsystems.

Suppose, for example, a masked subsystem A contains masked subsystem B, which contains Gain block C, whose Gain parameter references a variable defined by B. Suppose also that subsystem A's initialization code contains this command:

```
set_param([gcb '/B/C'], 'SampleTime', '-1');
```

Simulating or updating a model containing A causes an unresolved symbol error.

**See Also**

“Block Masks” | “Dynamic Masked Subsystem” on page 37-55

# Dynamic Masked Subsystem

## In this section...

“Allow Library Block to Modify Its Contents” on page 37-55

“Create Self-Modifying Masks for Library Blocks” on page 37-55

“Evaluate Blocks Under Self-Modifying Mask” on page 37-59

## Allow Library Block to Modify Its Contents

This check box is enabled only if the masked subsystem resides in a library. Checking this option allows the block initialization code to modify the contents of the masked subsystem (that is, it lets the code add or delete blocks and set the parameters of those blocks). Otherwise, an error is generated when a masked library block tries to modify its contents in any way. To set this option at the MATLAB prompt, select the self-modifying block and enter the following command.

```
set_param(gcf, 'MaskSelfModifiable', 'on');
```

Then save the block.

## Create Self-Modifying Masks for Library Blocks

You can create masked library blocks that can modify their structural contents. These self-modifying masks allow you to:

- Modify the contents of a masked subsystem based on parameters in the mask dialog box or when the subsystem is initially dragged from the library into a new model.
- Vary the number of ports on a multiport S-Function block that resides in a library.

### Creating Self-Modifying Masks Using the Mask Editor

To create a self-modifying mask using the Mask Editor:

- 1 Unlock the library (see “Lock and Unlock Libraries” on page 39-8).
- 2 Right-click the block in the library.
- 3 Select **Mask > Edit Mask**. The Mask Editor opens.

- 4 In the Mask Editor **Initialization** pane, select the **Allow library block to modify its contents** option.
- 5 Enter the code that modifies the masked subsystem in the mask **Initialization** pane.

Do not enter code that structurally modifies the masked subsystem in a dialog parameter callback (see “Add Mask Code” on page 37-18). Doing so triggers an error when you edit the parameter.

- 6 Click **Apply** to apply the change or **OK** to apply the change and close the Mask Editor.
- 7 Lock the library.

### **Creating Self-Modifying Masks from the Command Line**

To create a self-modifying mask from the command line:

- 1 Unlock the library using the following command:

```
set_param(gcs, 'Lock', 'off')
```

- 2 Specify that the block is self-modifying by using the following command:

```
set_param(block_name, 'MaskSelfModifiable', 'on')
```

where `block_name` is the full path to the block in the library.

### **Create Self-Modifying Mask**

The library `selfModifying_example` contains a masked subsystem that modifies its number of input ports based on a selection made in the subsystem mask dialog box.

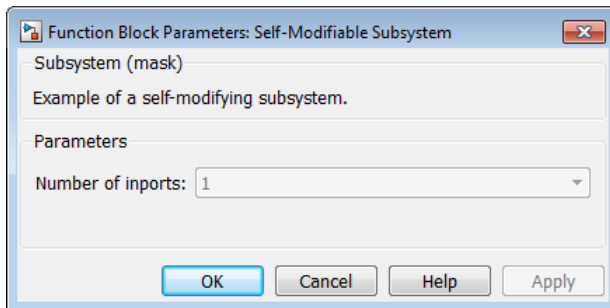
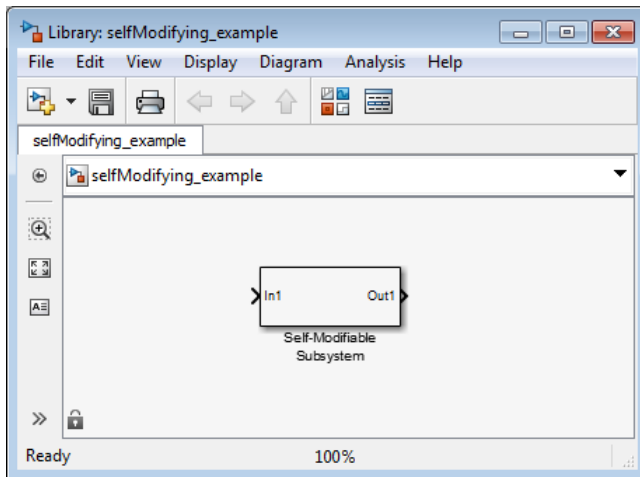

- 1 Click **Diagram > Unlock Library**.
- 2 Right-click the subsystem and select **Mask > Edit Mask**. The Mask Editor opens.
- 3 The Mask Editor **Parameters & Dialog** pane defines a parameter **numIn** that stores the value for the **Number of inports** option. This mask dialog box callback adds or removes Input ports inside the masked subsystem based on the selection made in the **Number of inports** list.

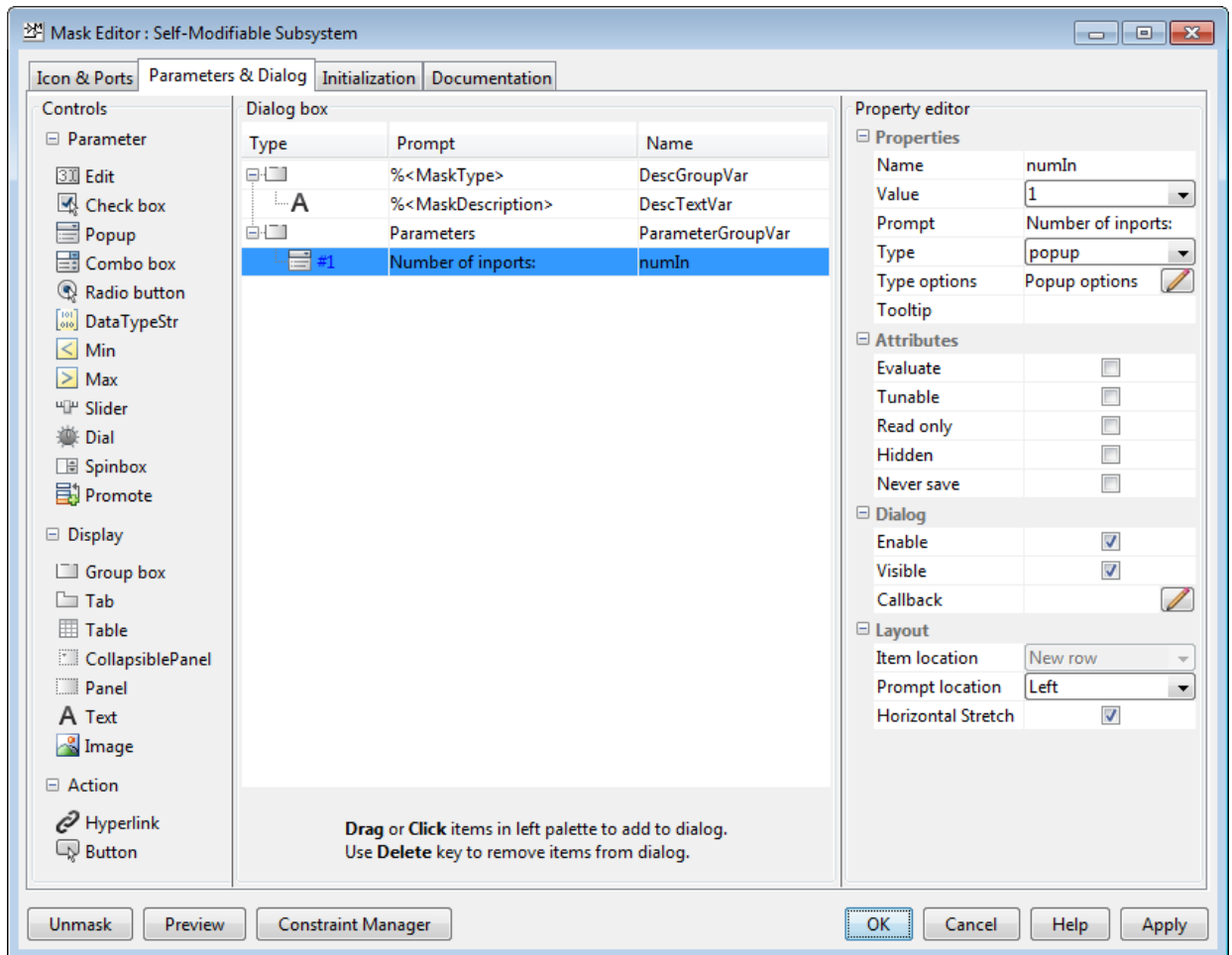

- To allow the dialog box callback to function properly, the **Allow library block to modify its contents** option on the Mask Editor **Initialization** pane is selected. If this option is not selected, copy of the library block could not modify their structural contents. Also, changing the selection in the **Number of inports** list would produce an error.

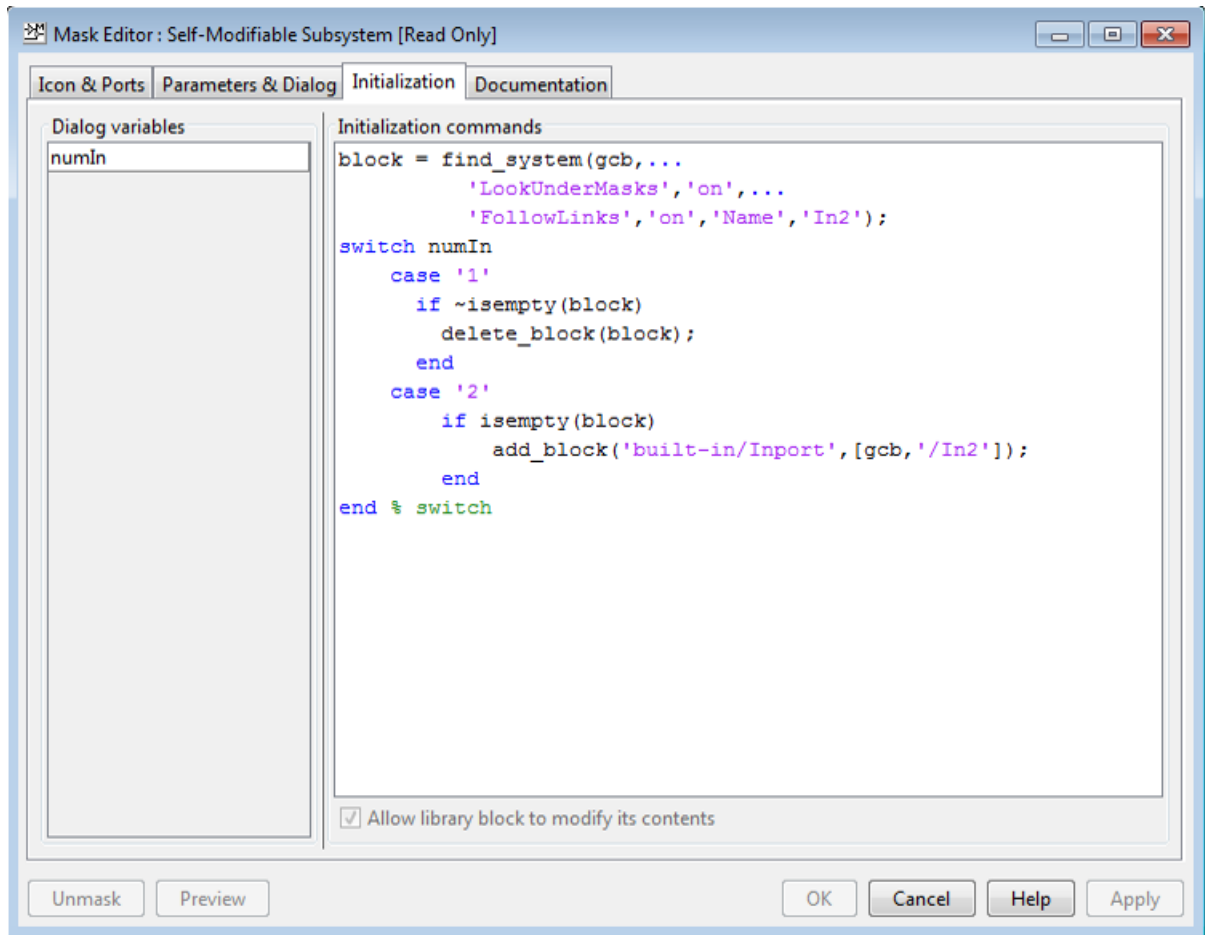

## Evaluate Blocks Under Self-Modifying Mask

This example shows how to force Simulink to evaluate blocks inside self-modifying masks.

Simulink evaluates elements of models containing masks in the following order:

- 1 Mask dialog box
- 2 Mask initialization code

### 3 Blocks or masked subsystems under the mask

Suppose a block named `myBlock` inside subsystem `mySubsys` masked by a self-modifying mask depends on mask parameter `myParam` to update itself.

`myParam` is exposed to the user through the **Mask Parameters** dialog box. `mySubsys` is updated through MATLAB code written in the **Mask Initialization** pane.

In this model, the sequence of updates is as follows:

- 1 You modify `myParam` through the mask dialog box.
- 2 The mask initialization code receives this change and modifies `mySubsys` under the mask.
- 3 `myBlock`, which lies under `mySubsys`, modifies itself based on the change to `myParam`.

In this sequence, Simulink does not evaluate `myBlock`, which lies under `mySubsys`, when the mask initialization code executes. Instead, Simulink only evaluates and updates the masked subsystem `mySubsys`. Meanwhile, `myBlock` remains unmodified.

You can force Simulink to evaluate such blocks earlier by using the `Simulink.Block.eval` method in the initialization code of the masked subsystem.

```
Simulink.Block.eval('mySubsys/myBlock');
```

### See Also

“Block Masks” | “Create a Simple Mask” on page 37-7 | “Initialize Mask” on page 37-26  
| “Mask Linked Blocks” on page 37-47 | Self-Modifying Interface Connector



## Debug Masks That Use MATLAB Code

### In this section...

“Code Written in Mask Editor” on page 37-61

“Code Written Using MATLAB Editor/Debugger” on page 37-61

### Code Written in Mask Editor

Debug initialization commands and parameter callbacks entered directly into the Mask Editor by:

- Removing the terminating semicolon from a command to echo its results to the MATLAB Command Window.
- Placing a keyboard command in the code to stop execution and give control to the keyboard.

---

**Tip:** To stop debugging the mask initialization callback code when an error is encountered, use the command `dbstop if caught error`.

---

### Code Written Using MATLAB Editor/Debugger

---

**Note:** You cannot debug icon drawing commands using the MATLAB Editor/Debugger. For information on icon drawing commands syntax, see “Icon drawing commands”.

---

Debug initialization commands and parameter callbacks written in files using the MATLAB Editor/Debugger in the same way that you would with any other MATLAB program file.

When debugging initialization commands, you can view the contents of the mask workspace. However, when debugging parameter callbacks, you can only access the base workspace of the block. If you need the value of a mask parameter, use `get_param`.

### More About

- “Initialize Mask” on page 37-26

- “Mask Callback Code” on page 37-18

## Introduction to Model Mask

A model consist of multiple blocks, with each block containing its own parameter and block dialog box. Simulink enables you to mask a model. By masking a model you encapsulate the model to have its own mask parameter dialog box. You can customize the mask parameter dialog box. When you mask a model, the model arguments become the model mask parameters. Referencing a masked model helps in having a better user-interface for a model with ease of controlling the model parameters through the mask.

When you reference a masked model from a Model block, a mask is generated automatically on the Model block. The generated mask on the Model block is a copy of the model mask that it is referencing. You can reference a masked model from multiple Model block instances.

Consider a model that represents the DC motor equation. **Plant** in this model is a Model block that references a masked model, simplifying the user interface.

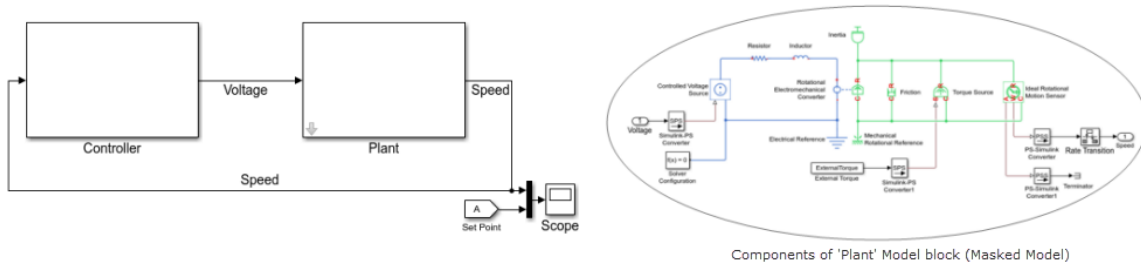

The **Plant** block contains same mask as that of the masked model and is uneditable. Mask can only be edited from the Mask Editor dialog box of the masked model.

### See Also

“Create and Reference a Masked Model” on page 37-64 | “Control Model Mask Programmatically” on page 37-71 | “Masking Fundamentals” on page 37-2

## Create and Reference a Masked Model

This example shows how to mask a model and reference the masked model from the Model block.

### Step 1: Define Mask Arguments

- 1 Open the model in Simulink. For example, consider a simple model containing two Gain blocks, a Constant block, and a Display block.

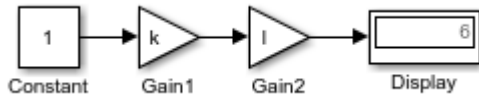

- 2 Click **View > Model Explorer > Model Workspace**. The Model Explorer dialog box opens.
- 3 Click **Add > MATLAB Variable**. A variable of data type `double` is created in the Model Workspace.
- 4 Select the **Argument** check box corresponding to the MATLAB variables to make it a model argument, for example, `k` and `l`.

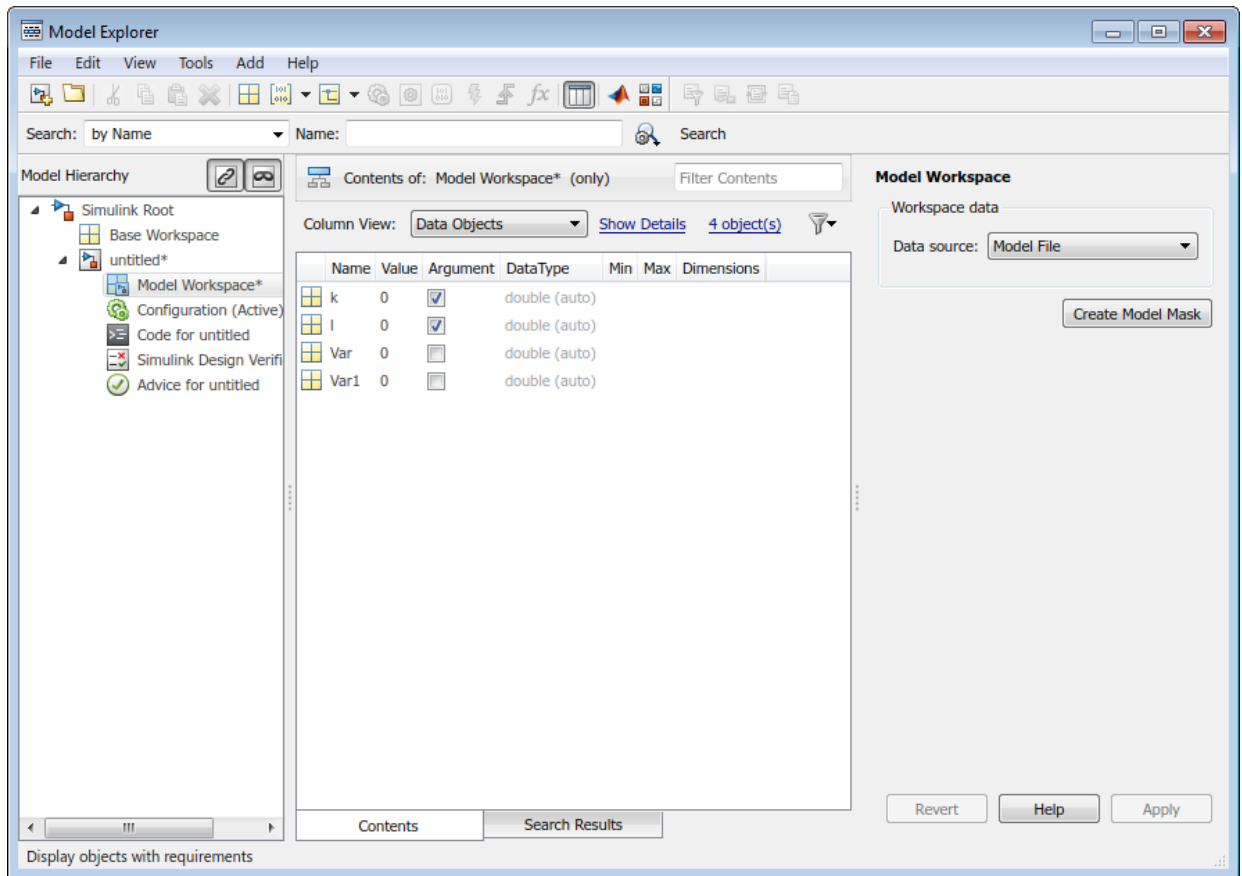

## Step 2: Create Model Mask

- 1 In the **Model Workspace** pane, click **Create Model Mask**.

Alternatively, in Simulink click **Diagram > Mask > Create Model Mask** or right-click the model, and in the context menu, click **Mask > Create > Model Mask**.

The Mask Editor dialog box opens.

- 2 Click the **Parameters & Dialog** tab. The model arguments that you select in Model Explorer appear in the Mask Editor dialog box as mask parameters.

**Tip:** Ensure that the model arguments you have selected in the Model Explorer dialog box are added as block parameters in the model. For example, the arguments *k* and *l* are passed to *Gain A* and *Gain B* blocks, respectively.

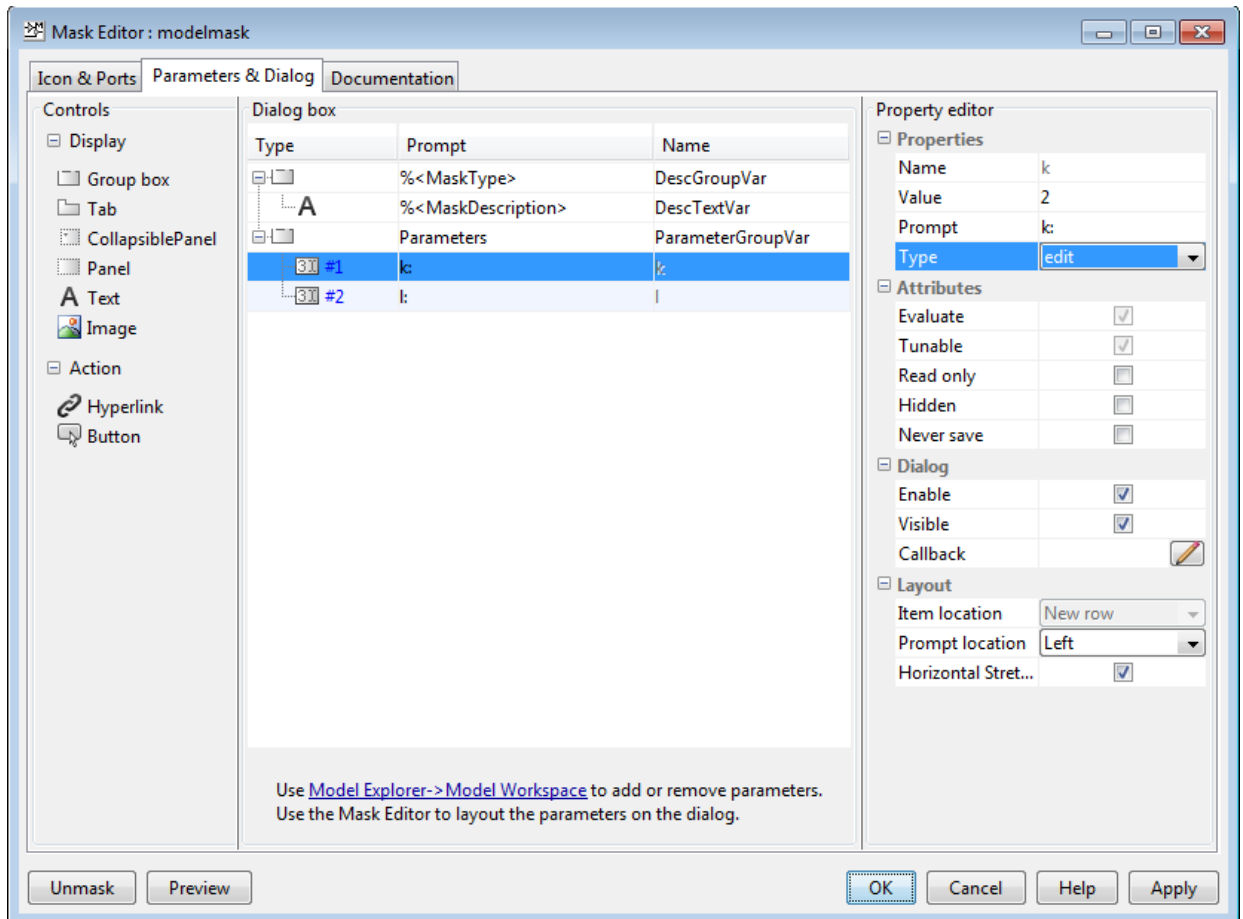

---

**Note:** The Mask Editor dialog box for model mask does not contain the **Initialization** tab. Initialization code can alter the model and other model reference blocks, and thus affect the simulation results.

---

- 3 Select a mask parameter (k or l) on the **Dialog box** pane and edit its properties in the Property editor, as required. For example, you can change the prompt name, parameter type, value, or orientation.

By default, the **Edit** parameter type is assigned to a model mask parameter. You can change the parameter type by editing the **Type** property in the **Property editor** section.

---

**Note:**

- Simulink supports only the **Edit**, **Slider**, **Dial**, and **Spinbox** parameter types for model mask.
  - Model mask supports all types of display and action controls.
- 

- 4 Click **OK**. The Simulink model is now masked and contains the model arguments as the mask parameter.
- 5 Save the model.

### Step 3: View Model Mask Parameters

- 1 To view the mask parameter dialog box, click **Diagram > Mask > Model Mask Parameters**.

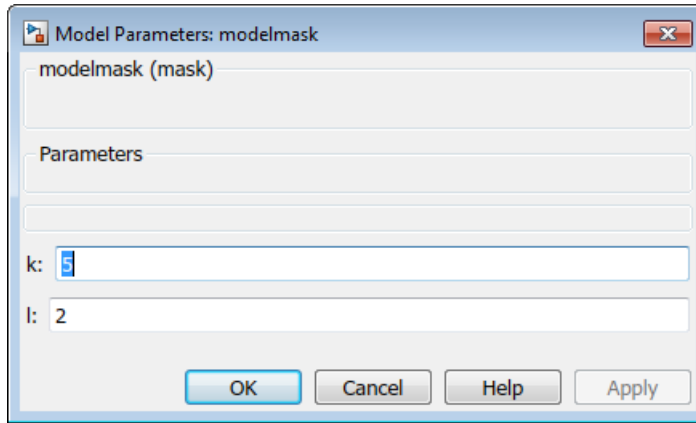

---

**Tip:** To edit the model mask parameters, click **Diagram > Mask > Edit Model Mask**.

---

- 2 Save the masked model.

### Step 4: Reference Masked Model

- 1 Open a blank model in Simulink and add the Model block from the library.
- 2 To reference the masked model from the Model block, specify the name of the masked model as the **Model name** in the **Block parameter** dialog box.



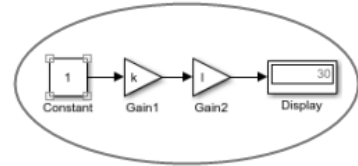
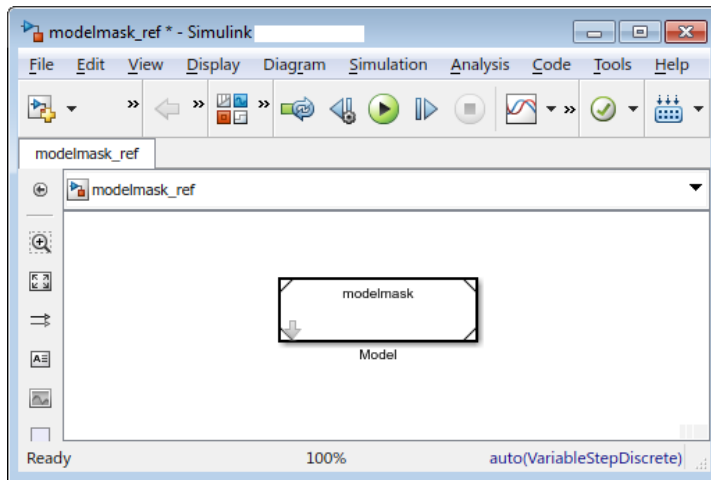

Masked model referenced by the Model block

- 3 To view the parameter dialog box of the referenced model, right-click the Model block, and in the context menu, click **Mask > Mask Parameters**. Alternatively, double-click the Model block.
- 4 Type 2 and 3 as the parameter values for k and l respectively.

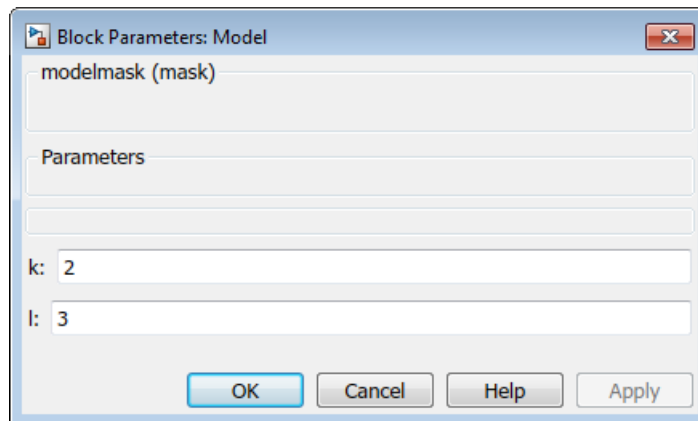

- 5 Click **OK**.
- 6 Simulate the model and view the result on the display block.
- 7 To view the referenced model from the Model block, click **Mask > Look Under Mask**.

- 8 To view the mask, right-click the Model block and click **Mask > View Mask**. The **Mask Editor** dialog box opens. The Mask Editor dialog box displays the uneditable mask parameters of the referenced model.

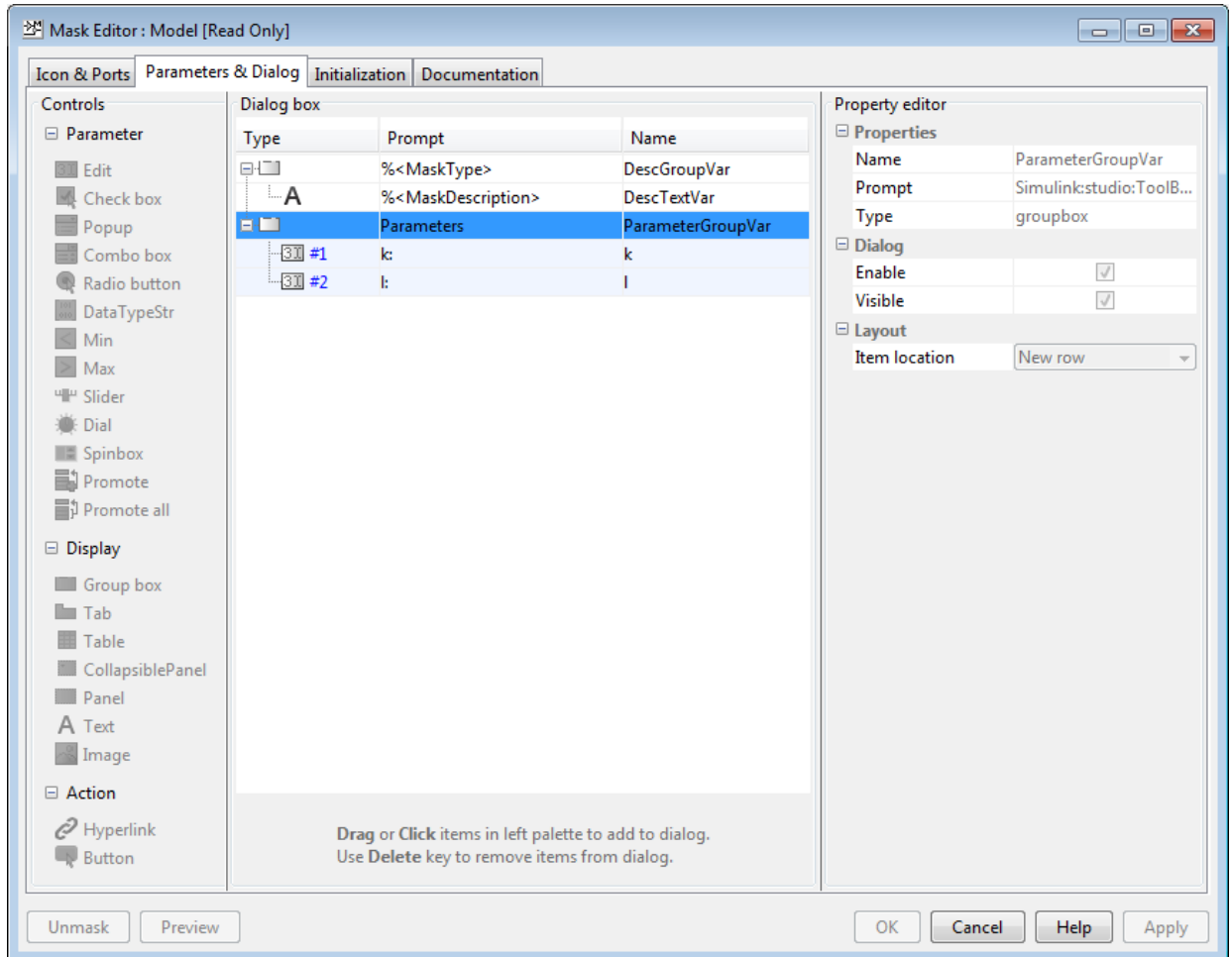

## See Also

“Introduction to Model Mask” on page 37-63 | “Control Model Mask Programmatically” on page 37-71 | “Masking Fundamentals” on page 37-2

## Control Model Mask Programmatically

Simulink defines a set of parameters to configure and edit a model mask.

---

**Note:** Adding, removing, and renaming parameters on a model mask using these methods is not supported:

- `addParameter`
  - `removeParameter`
  - `removeAllParameters`
  - `MaskParameter.Name`
- 

### Simulink.Mask.create

Use the `Simulink.Mask.create` method to create mask on a model. The syntax to mask a model is,

- Using the model name:

```
Simulink.Mask.create(ModelName)
```

- Using the model handle

```
ModelHandle = get_param(gcs, 'Handle') %To get the model handle
Simulink.Mask.create(ModelHandle) %To create mask using model handle
```

An example follows,

```
maskObj = Simulink.Mask.create('vdp');

        Type: 'vdp'
        Description: 'The van der Pol Equation...'
        Help: ''
        Initialization: ''
        SelfModifiable: 'off'
        Display: ''
        IconFrame: 'on'
        IconOpaque: 'opaque'
        RunInitForIconRedraw: 'off'
        IconRotate: 'none'
```

```
PortRotate: 'default'  
IconUnits: 'autoscale'  
Parameters: [0x0 Simulink.MaskParameter]  
BaseMask: [0x0 Simulink.Mask]
```

## Simulink.Mask.get

Use the `Simulink.Mask.get` method to get the mask on a model as a mask object. The syntax to get the existing mask of a model is,

- Using the model name:

```
Simulink.Mask.get(ModelName)
```

- Using the model handle

```
ModelHandle = get_param(gcs, 'Handle') %To get the model handle  
Simulink.Mask.get(ModelHandle) %To create mask using model handle
```

An example follows,

```
maskObj = Simulink.Mask.get('vdp');
```

```
      Type: 'vdp'  
Description: 'The van der Pol Equation...'  
      Help: ''  
Initialization: ''  
SelfModifiable: 'off'  
      Display: ''  
      IconFrame: 'on'  
      IconOpaque: 'opaque'  
RunInitForIconRedraw: 'off'  
      IconRotate: 'none'  
PortRotate: 'default'  
      IconUnits: 'autoscale'  
Parameters: [0x0 Simulink.MaskParameter]  
BaseMask: [0x0 Simulink.Mask]
```

## See Also

“Create and Reference a Masked Model” on page 37-64 | “Introduction to Model Mask” on page 37-63 | “Masking Fundamentals” on page 37-2

## Constraints

## Masking Example Models

The Simulink Masking Example models help you to understand and configure mask parameters, properties, and features. The examples are grouped by type. In an example model:

- To view the mask definition, double-click the View Mask block.
- To view the mask dialog box, double-click the block.



### See Also

“Block Masks” | “Mask Editor Overview” | “Masking Fundamentals” on page 37-2

## Mask a Variant Subsystem

In a masked Variant Subsystem block, you can use the mask initialization code to control the Variant choices. Click the **Open Model** button located on the top right corner to view an example model.

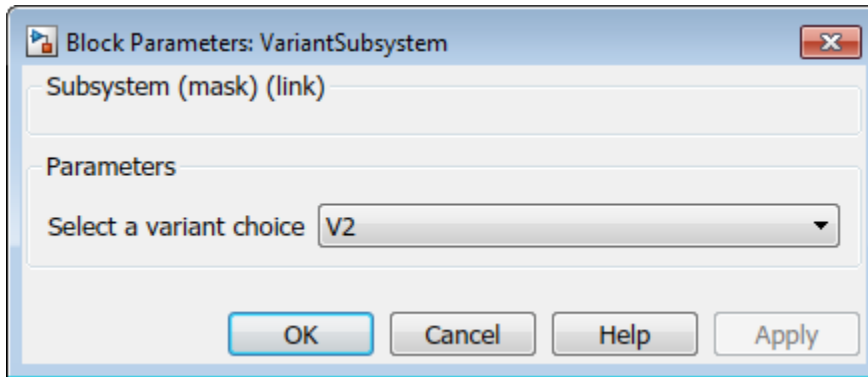
This model uses a masked Variant Subsystem block as a linked block. To view the mask dialog box, right-click the `VariantSubsystem` block and select **Mask > Mask Parameters**.



Select a variant choice and click **Apply**.

The variant choice that you specify on the mask dialog box applies to the blocks inside the `VariantSubsystem` block when you simulate the model.

The variant choice maps to the options specified on the mask dialog box as defined in the **Initialization** pane of the Mask Editor using mask initialization code.

In this model, double-click the **View Mask** block to view the mask initialization code for this model.

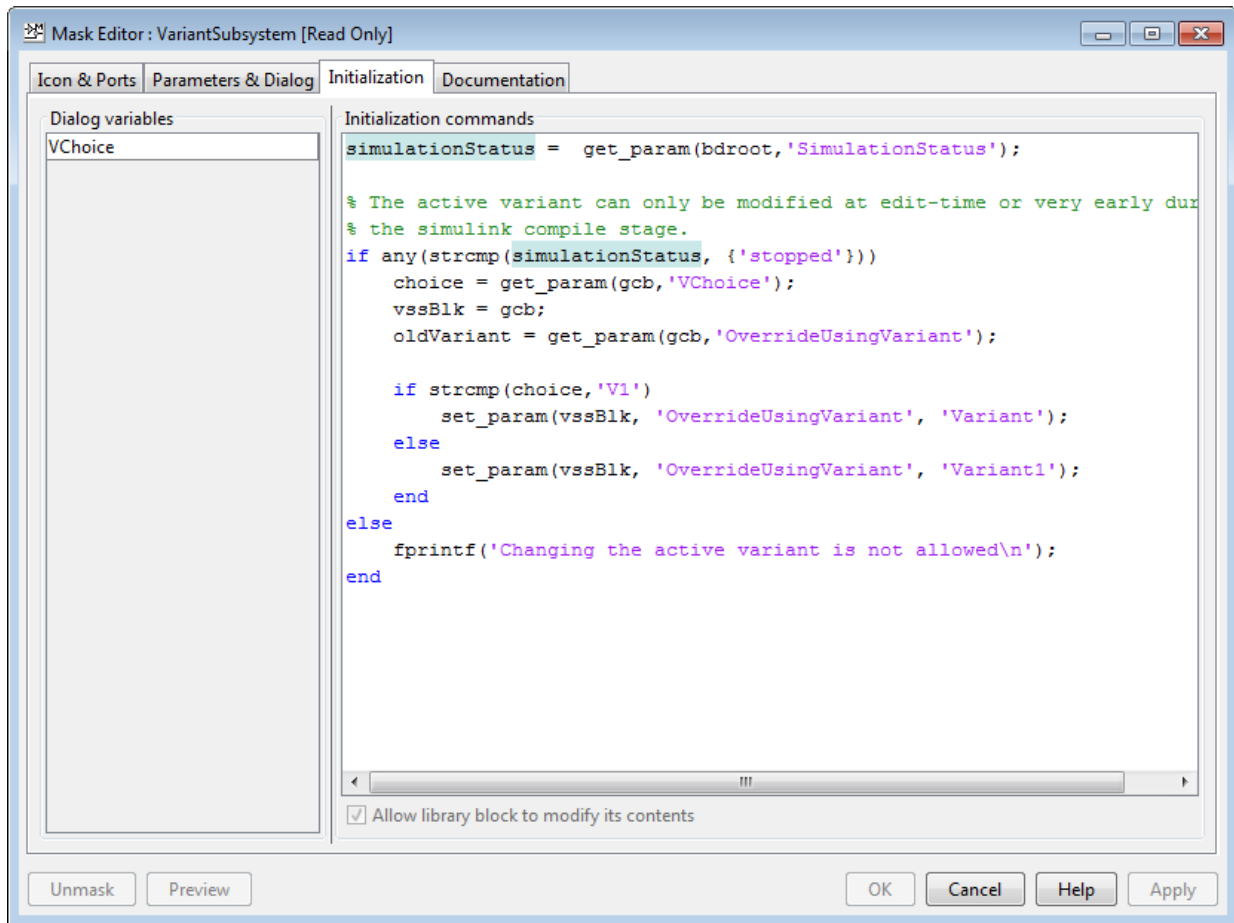

When you specify a choice on the mask dialog box, the `OverrideUsingVariant` command overrides the variant choice on the `VariantSubsystem` block.

Note: For a masked `Variant Subsystem` block, do not promote the variant choices to the mask dialog box.

### More About

docid:simulink\_ug.bvhtavr



# Creating Custom Blocks

---

- “Create Your Own Simulink Block” on page 38-2
- “Comparison of Custom Block Functionality” on page 38-7
- “Expanding Custom Block Functionality” on page 38-18
- “Create a Custom Block” on page 38-19

## Create Your Own Simulink Block

### In this section...

“Why Create Blocks” on page 38-2

“Types of Custom Blocks” on page 38-2

“Comparing MATLAB S-Functions to MATLAB Functions for Code Generation” on page 38-5

“Using S-Function Blocks to Incorporate Legacy Code” on page 38-5

### Why Create Blocks

Create your own blocks to extend the built-in modeling functionality of Simulink. For example, create new blocks to:

- Integrate an existing code (legacy code) or algorithms into Simulink. Legacy code is your code that gives the functionality not available through existing Simulink library blocks. Simulink provides tools that let you integrate MATLAB, C/C++, and Fortran code. This method allows you to integrate System objects into Simulink.
- Create a new Simulink block customized for your needs. You may want to create a custom block if the built-in Simulink library does not have a block that provides a necessary functionality.
- Create a new custom functionality using a MATLAB function rather than using a Simulink block diagram.

To summarize, integrate existing code if you already have code that you would like to access in Simulink. If you do not have existing code, but have a particular functionality that Simulink does not satisfy, create your own block.

### Types of Custom Blocks

#### MATLAB Function Blocks

A MATLAB Function block allows you to use the MATLAB language to define custom functionality. These blocks are a good starting point for creating a custom block if:

- You have an existing MATLAB function that models the custom functionality.

- You find it easier to model custom functionality using a MATLAB function than using a Simulink block diagram.
- The custom functionality does not include continuous or discrete dynamic states.

You can create a custom block from a MATLAB function using one of the following types of MATLAB function blocks.

- The Fcn block allows you to use a MATLAB expression to define a single-input, single-output (SISO) block.
- The Interpreted MATLAB Function block allows you to use a MATLAB function to define a SISO block.
- The MATLAB Function block allows you to define a custom block with multiple inputs and outputs that you can deploy to an embedded processor.

Each of these blocks has advantages in particular modeling applications. For example, you can generate code from models containing MATLAB Function blocks, whereas you cannot generate code for models containing an Fcn block.

### **MATLAB System Blocks**

A MATLAB System block allows you to use System objects written with the MATLAB language to define custom functionality. These blocks are a good starting point for creating a custom block if:

- You have an existing System object™ that models the custom functionality.
- You find it easier to model custom functionality using the MATLAB language than using a Simulink block diagram.
- The custom functionality includes discrete dynamic states.

### **Subsystem Blocks**

Subsystem blocks allow you to build a Simulink diagram to define custom functionality. These blocks serve as a good starting point for creating a custom block if:

- You have an existing Simulink diagram that models custom functionality.
- You find it easier to model custom functionality using a graphical representation rather than using handwritten code.
- The custom functionality is a function of continuous or discrete system states.
- You can model the custom functionality using existing Simulink blocks.

Once you have a Simulink subsystem that models the required behavior, you can convert it into a custom block by:

- 1 Masking the block to hide the block contents and provide a custom block dialog box.
- 2 Placing the block in a library to prohibit modifications and allow for easily updating copies of the block.

For more information, see “Libraries” and “Block Masks”.

### **S-Function Blocks**

S-function blocks allow you to write MATLAB, C, or C++ code to define custom functionality. These blocks serve as a good starting point for creating a custom block if:

- You have existing MATLAB, C, or C++ code that models custom functionality.
- You use continuous or discrete dynamic states or other system behaviors that require access to the S-function API.
- You cannot model the custom functionality using existing Simulink blocks.

You can create a custom block from an S-function using one of the following types of S-function blocks.

- The Level-2 MATLAB S-Function block allows you to write your S-function using the MATLAB language. (See “Write Level-2 MATLAB S-Functions”). You can debug a MATLAB S-function during a simulation using the MATLAB debugger.
- The S-Function block allows you to write your S-function in C or C++, or to incorporate existing code into your model using a C MEX wrapper. (See “C/C++ S-Functions”.)
- The S-Function Builder block assists you in creating a C MEX S-function or a wrapper function to incorporate legacy C or C++ code. (See “C/C++ S-Functions”.)
- The Legacy Code Tool transforms existing C or C++ functions into C MEX S-functions. (See “Integrate C Functions Using Legacy Code Tool”.)

The S-function target in the Simulink Coder product automatically generates a C MEX S-function from a graphical subsystem. If you want to build your custom block in a Simulink subsystem, but implement the final version of the block in an S-function, you can use the S-function target to convert the subsystem to an S-function. See “Accelerate Simulation, Reuse Code, or Protect Intellectual Property by Using S-Function Target” (Simulink Coder) in the Simulink Coder User's Guide for details and limitations on using the S-function target.

## Masked Blocks

You can customize any block by adding a mask to it. A mask is a custom interface to the block. You can customize a block using a mask in many ways, such as:

- Change the block appearance.
- Hide some or all of the parameters from the user of the block.
- Customize block parameters.

To learn more about masked blocks, see “Block Masks”.

## Comparing MATLAB S-Functions to MATLAB Functions for Code Generation

MATLAB S-functions and MATLAB functions for code generation have some fundamental differences.

- The Simulink Coder product can generate code for both MATLAB S-functions and MATLAB functions for code generation. However, MATLAB S-functions require a Target Language Compiler (TLC) file for code generation. MATLAB functions for code generation do not require a TLC file.
- MATLAB S-functions can use any MATLAB function whereas MATLAB functions for code generation are a subset of the MATLAB language. For a list of supported functions for code generation, see “Functions and Objects Supported for C/C++ Code Generation — Alphabetical List” on page 44-2.
- MATLAB S-functions can model discrete and continuous state dynamics whereas MATLAB functions for code generation cannot model state dynamics.

## Using S-Function Blocks to Incorporate Legacy Code

Each S-function block allows you to incorporate legacy code into your model, as follows.

- A MATLAB S-function accesses legacy code through its TLC file. Therefore, the legacy code is available only in the generated code, not during simulation.
- A C MEX S-function directly calls legacy C or C++ code.
- The S-Function Builder generates a wrapper function that calls the legacy C or C++ code.

- The Legacy Code Tool generates a C MEX S-function to call the legacy C or C++ code, which is optimized for embedded systems. See “Integrate C Functions Using Legacy Code Tool” for more information.

See “Call Reusable External Algorithm Code for Simulation and Code Generation” (Simulink Coder) for more information.

See “S-Functions Incorporate Legacy C Code” in the Simulink Developing S-Functions for an example.

## See Also

Fcn | Interpreted MATLAB Function | Level-2 MATLAB S-Function | MATLAB System | MATLAB Function | S-Function | S-Function Builder | Simulink Function | Subsystem

## More About

- “Comparison of Custom Block Functionality” on page 38-7
- “Expanding Custom Block Functionality” on page 38-18
- “Create a Custom Block” on page 38-19

## Comparison of Custom Block Functionality

In this section...
“Block Type Flowchart” on page 38-8
“Model State Behavior” on page 38-10
“Simulation Performance” on page 38-11
“Code Generation” on page 38-13
“Multiple Input and Output Ports” on page 38-14
“Speed of Updating the Simulink Diagram” on page 38-14
“Callback Methods” on page 38-15

When creating a custom block, consider:

- Does the block model continuous or discrete state behavior?
- Is the simulation performance important?
- Do you need to generate code for a model containing the custom block?

This table shows how each custom block type addresses the three concerns.

### Modelling Considerations

Custom Block Type	Model State Dynamics	Simulation Performance	Code Generation
Fcn	No	Very fast	Supported
Interpreted MATLAB Function	No	Less fast	Not supported
Level-2 MATLAB S-function	Yes	Less fast	Requires a TLC file
MATLAB Function	No	Fast	Supported with exceptions
MATLAB System	Yes	Fast	Supported with exceptions
S-Function	Yes	Fast	Requires a TLC file or non-inline S-Function support

Custom Block Type	Model State Dynamics	Simulation Performance	Code Generation
S-Function Builder	Yes	Fast	Supported
Simulink Function	Yes	Fast	Supported
Subsystem	Yes	Fast	Supported

For detailed design of custom blocks, consider:

- Does the custom block need multiple input and output ports?
- What are the callback methods to communicate with the Simulink engine and which custom blocks let you implement all or a subset of these callback methods?
- How important is the effect of the custom block on the speed of updating the Simulink diagram?

## Block Type Flowchart

This diagram helps to decide which block to use. First, determine whether you need the block for a function or a system. A function defines the relationship between a set of inputs and outputs. A system defines the relationship between a set of states as well as a set of inputs and outputs, parameters, System object processing methods for initialization, output, update, termination, and so forth.



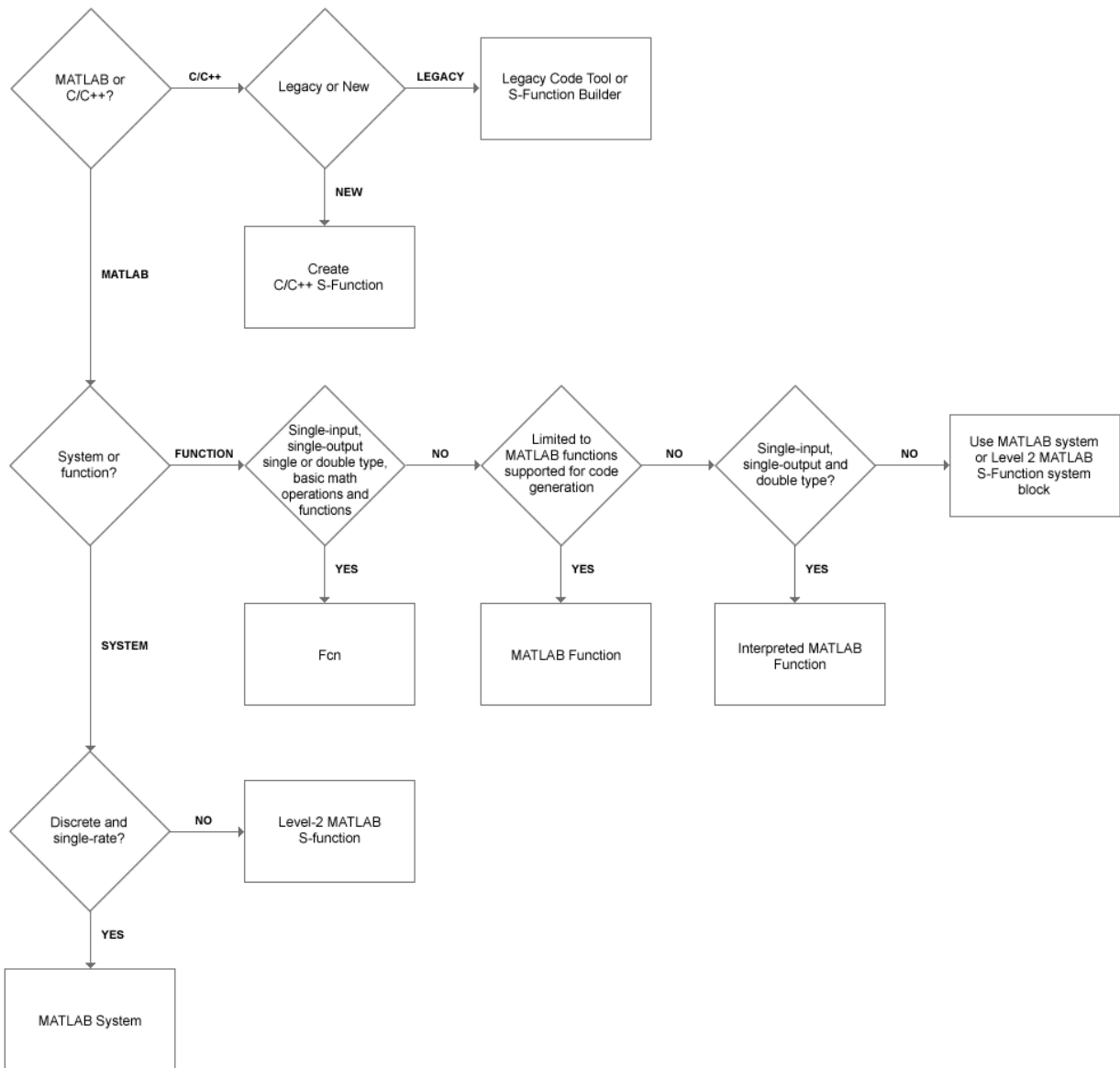

**Note:** In the flowchart, *Legacy* stands for the existing code or models.

## Model State Behavior

You need to model the state behavior for a block that requires some or all of its previous outputs to compute its current outputs. See “Modeling Dynamic Systems” on page 3-3 for more information.

Custom Block Type	Notes
Fcn, Interpreted MATLAB Function	Does not allow you to model state behavior.
MATLAB Function	Allows you to model a discrete state using <b>persistent</b> variables.
Level-2 MATLAB S-Function	Allows you to model both continuous and discrete state behavior using the <b>ContStates</b> or <b>Dwork</b> run-time object methods in combination with block callback methods. For a list of supported methods, see “Level-2 MATLAB S-Function Callback Methods” in “Write Level-2 MATLAB S-Functions”.
MATLAB System	Allows you to model discrete state behavior using <b>DiscreteState</b> properties of the <b>System</b> object, in combination with block callback methods. This block uses <b>System</b> object methods for callback methods: <b>mdlOutputs</b> ( <b>stepImpl</b> , <b>outputImpl</b> ), <b>mdlUpdate</b> ( <b>updateImpl</b> ), <b>mdlInitializeConditions</b> ( <b>resetImpl</b> ), <b>mdlStart</b> ( <b>setupImpl</b> ), <b>mdlTerminate</b> ( <b>releaseImpl</b> ). For more information see “What Are System Objects?” (MATLAB).
C MEX S-Function, S-Function Builder	Allows you to model both continuous and discrete state behavior in combination with block callback methods. For more information, see “Callback Methods for C MEX S-Functions”
Simulink Function	Communicates directly with the engine. You can model the state behavior using appropriate blocks from the continuous and discrete Simulink block libraries. When multiple calls to this function originate from different callers, the state values are also persistent between these calls. For more information, see “Call a Simulink Function Block from Multiple Sites” on page 10-107.
Subsystem	Communicates directly with the engine. You can model the state behavior using appropriate blocks from the continuous and discrete Simulink block libraries.

## Simulation Performance

For most applications, all custom block types provide satisfactory simulation performance. Use the Simulink profiler to get the actual performance indication. See “How Profiler Captures Performance Data” on page 29-5 for more information.

The two categories of performance indication are the interface cost and the algorithm cost. The interface cost is the time it takes to move data from the Simulink engine into the block. The algorithm cost is the time it takes to perform the algorithm that the block implements.

Custom Block Type	Notes
Fcn	Has the highest simulation performance. The block is tightly integrated with the Simulink engine and optimized for simulation and code generation.
Interpreted MATLAB Function	Has a slower performance due to the interface, but has the same algorithm cost as a MATLAB function. When block data (such as inputs and outputs) is accessed or returned from an Interpreted MATLAB Function block, the Simulink engine packages this data into MATLAB arrays. This packaging takes additional time and causes a temporary increase in memory during communication. If you pass large amounts of data across this interface, such as frames or arrays, the performance can be substantially slow. Once the data has been converted, the MATLAB execution engine executes the algorithm. As a result, the algorithm cost is the same as for MATLAB function.
Level-2 MATLAB S-Function	Incurs the same algorithm costs as the Interpreted MATLAB Function block, but with a slightly higher interface cost. Since MATLAB S-Functions can handle multiple inputs and outputs, the packaging is more complicated than for the Interpreted MATLAB Function block. In addition, the Simulink engine calls the MATLAB execution engine for each block method you implement, whereas the Interpreted MATLAB Function block calls the MATLAB execution engine only for the <b>Outputs</b> method.
MATLAB Function	Performs simulation through code generation and incurs the same interface cost as other Simulink built-in blocks.

Custom Block Type	Notes
	<p>The algorithm cost of this block is harder to analyze because of the block's implementation. On average, a function for this block and the MATLAB function run at about the same speed.</p> <p>If the MATLAB Function block has code that uses <code>coder.extrinsic</code> to call out to the MATLAB execution engine, it incurs all the costs that the MATLAB S-Function or Interpreted MATLAB Function block incur. Calling out to the MATLAB execution engine from a MATLAB Function block produces a warning to prevent you from doing so unintentionally.</p> <p>To reduce the algorithm cost, you can disable debugging for all MATLAB Function blocks.</p>
MATLAB System	<p>In the interpreted execution mode, performance is similar to that of the Level-2 MATLAB S-Function because the model simulates the block using the MATLAB execution engine. In the code generation mode, performance is similar to that of the MATLAB Function because the model simulates the block using the generated code. For more information, see the MATLAB Function entry in this table.</p>
C MEX S-Function	<p>Simulates via the compiled code and incurs the same interface cost as Simulink built-in blocks. The algorithm cost depends on the complexity of the S-Function.</p>
S-Function Builder	<p>This block only builds an S-Function from the specifications and C code you supply. You can also use this block as a wrapper for the generated S-Function in models. The algorithm cost of this block compared to C MEX S-Function is incurred only from the wrapper.</p>
Simulink Function, Subsystem	<p>If included in a library, introduces no interface or algorithm costs beyond what would normally be incurred if the block existed as a regular subsystem in the model.</p> <p>Performance is proportional to the complexity of the algorithm implemented in the subsystem. If the subsystem is contained in a library, some cost is incurred when Simulink loads any unloaded libraries the first time the diagram is updated or readied for simulation. If all referenced library blocks remain unchanged, Simulink does not subsequently reload the library. Compiling the model becomes faster than if the model did not use libraries.</p>

## Code Generation

You need code generation if your model is part of a bigger system. Not all custom block types support code generation with Simulink Coder.

Custom Block Type	Notes
Fcn	Supports code generation.
Interpreted MATLAB Function	Does not support code generation.
Level-2 MATLAB S-Function	Generates code only if you implement the algorithm using a Target Language Compiler (TLC) function. In accelerated and external mode simulations, you can choose to execute the S-Function in the interpretive mode by calling back to the MATLAB execution engine without implementing the algorithm in TLC. If the MATLAB S-Function is <code>SimViewingDevice</code> , the Simulink Coder product automatically omits the block during code generation.
MATLAB Function, MATLAB System	Supports code generation. However, if your block calls out to the MATLAB execution engine, it will build with the Simulink Coder product only if the calls to the MATLAB execution engine do not affect the block outputs. Under this condition, the Simulink Coder product omits these calls from the generated C code. This feature allows you to leave visualization code in place, even when generating embedded code.
C MEX S-Function, S-Function Builder	<p>Both supports code generation.</p> <ul style="list-style-type: none"> <li>• For non-inlined S-Functions, the Simulink Coder product uses the C MEX function during code generation.</li> <li>• In the case of C MEX S-Functions, if you need to either inline the S-Function or create a wrapper for handwritten code, you must write a TLC file for the S-Function.</li> <li>• In the case of S-Function Builder, you can choose the Generate wrapper TLC option to automatically generate a TLC file.</li> </ul> <p>See “S-Functions and Code Generation” (Simulink Coder) for more information.</p>
Simulink Function	Supports code generation. For more information, see “Modeling Functions and Callers for Code Generation” (Embedded Coder)

Custom Block Type	Notes
Subsystem	Supports code generation as long as the blocks contained within the subsystem support code generation. For more information, see “Code Generation of Subsystems” (Embedded Coder)

## Multiple Input and Output Ports

These types of custom blocks support multiple input and output ports.

Custom Block Type	Notes
Fcn, Interpreted MATLAB Function	Supports only a single input and a single output port.
MATLAB Function	Supports multiple input and output ports, including bus signals. See “How Structure Inputs and Outputs Interface with Bus Signals” on page 40-78 for more information.
MATLAB System	Supports multiple input and output ports, including bus signals. In addition, you can modify the number of input and output ports based on system object properties using the <code>getNumInputs</code> and <code>getNumOutputs</code> methods.
Level-2 MATLAB S-Function, C MEX S-Function, S-Function Builder	Supports multiple input and output ports. In addition, you can modify the number of input and output ports based on user-defined parameters. The C MEX S-Function and S-Function Builder support bus signals.
Simulink Function	Supports multiple input and output ports, including bus signals.
Subsystem	Supports multiple input and output ports, including bus signals. In addition, you can modify the number of input and output ports based on user-defined parameters. See “Self-Modifiable Linked Subsystems” on page 39-24 for more information.

## Speed of Updating the Simulink Diagram

Simulink updates the diagram before every simulation and when requested by the user. Every block introduces some overhead into the diagram update process.

Custom Block Type	Notes
Fcn, Interpreted MATLAB Function	Low diagram update cost.
MATLAB Function	Simulation is performed through code generation, so this blocks can take a significant amount of time when first updated. However, because code generation is incremental, Simulink does not repeatedly update the block if the block and the signals connected to it have not changed.
MATLAB System	Faster than MATLAB Function because code is not generated to update the diagram. Since, code generation is incremental, Simulink does not repeatedly update the block if the block and the signals connected to it have not changed.
C MEX S-Function, Level-2 MATLAB S-Function	Incurs greater costs than other Simulink blocks only if it overrides methods executed when updating the diagram. If these methods become complex, they can contribute significantly to the time it takes to update the diagram. For a list of methods executed when updating the diagram, see the process view in “Simulink Engine Interaction with C S-Functions”. When updating the diagram, Simulink invokes all relevant methods in the model initialization phase up to, but not including, <code>mdlStart</code> .
Simulink Function, Subsystem	The speed is proportional to the complexity of the algorithm implemented in the subsystem. If the subsystem is contained in a library, some cost is incurred when Simulink loads any unloaded libraries the first time the diagram is updated or readied for simulation. If all referenced library blocks remain unchanged, Simulink does not subsequently reload the library. Compiling the model becomes faster than if the model does not use libraries.

## Callback Methods

Simulink blocks communicate with the Simulink engine through block callback methods, which fully specify the behavior of blocks (except the Simulink Function block). Each custom block type allows you to implement a different set of callback methods. To learn how blocks interact with Simulink engine, see “Simulink Engine Interaction with C S-Functions”. This table uses “S-Function Callback Methods” names as equivalents.

Custom Block Type	Notes
Fcn, Interpreted MATLAB Function, MATLAB Function	All create a <code>mdlOutputs</code> method to calculate the value of outputs given the value of inputs. You cannot implement any other callback methods using one of these blocks and, therefore, cannot model state behavior.
Level-2 MATLAB S-Function	Allows implementation of a larger subset of callback methods, including methods you can use to model continuous and discrete states. For a list of supported methods, see “Level-2 MATLAB S-Function Callback Methods” in “Write Level-2 MATLAB S-Functions”.
MATLAB System	Uses System object methods for callback methods: <code>mdlOutputs</code> ( <code>stepImpl</code> , <code>outputImpl</code> ), <code>mdlUpdate</code> ( <code>updateImpl</code> ), <code>mdlInitializeConditions</code> ( <code>resetImpl</code> ), <code>mdlStart</code> ( <code>setupImpl</code> ), <code>mdlTerminate</code> ( <code>releaseImpl</code> ). For more information, see “Simulink Engine Interaction with System Object Methods” on page 42-28
C MEX S-Function	Allows implementation of a complete set of callback methods.
S-Function Builder	Allows implementation of <code>mdlOutputs</code> , <code>mdlDerivatives</code> and <code>mdlUpdate</code> .
Simulink Function	Packaged as a standalone function. Any caller to this function becomes part of one of the callback methods based on the caller’s location.
Subsystem	Communicates directly with the engine. You can model state behaviors using appropriate blocks from the continuous and discrete Simulink block libraries.

## See Also

Fcn | Interpreted MATLAB Function | Level-2 MATLAB S-Function | MATLAB System | MATLAB Function | S-Function | S-Function Builder | Simulink Function | Subsystem

## More About

- “Create Your Own Simulink Block” on page 38-2
- “Expanding Custom Block Functionality” on page 38-18



- “Create a Custom Block” on page 38-19

## Expanding Custom Block Functionality

You can expand the functionality of any custom block using callbacks and MATLAB graphics.

Block callbacks perform user-defined actions at specific points in the simulation. For example, the callback can load data into the MATLAB workspace before the simulation or generate a graph of simulation data at the end of the simulation. You can assign block callbacks to any of the custom block types. For a list of available callbacks and more information on how to use them, see “Specify Block Callbacks” on page 4-52.

GUIDE, the MATLAB graphical user interface development environment, provides tools for easily creating custom user interfaces. See “App Building” (MATLAB) for more information on using GUIDE.

### More About

- “Create Your Own Simulink Block” on page 38-2
- “Comparison of Custom Block Functionality” on page 38-7
- “Create a Custom Block” on page 38-19

## Create a Custom Block

### In this section...

“How to Design a Custom Block” on page 38-19

“Defining Custom Block Behavior” on page 38-21

“Deciding on a Custom Block Type” on page 38-22

“Placing Custom Blocks in a Library” on page 38-26

“Adding a User Interface to a Custom Block” on page 38-29

“Adding Block Functionality Using Block Callbacks” on page 38-37

### How to Design a Custom Block

In general, use the following process to design a custom block:

- 1 “Defining Custom Block Behavior” on page 38-21
- 2 “Deciding on a Custom Block Type” on page 38-22
- 3 “Placing Custom Blocks in a Library” on page 38-26
- 4 “Adding a User Interface to a Custom Block” on page 38-29

Suppose you want to create a customized saturation block that limits the upper and lower bounds of a signal based on either a block parameter or the value of an input signal. In a second version of the block, you want the option to plot the saturation limits after the simulation is finished. The following tutorial steps you through designing these blocks. The library `ex_customsat_lib` contains the two versions of the customized saturation block.

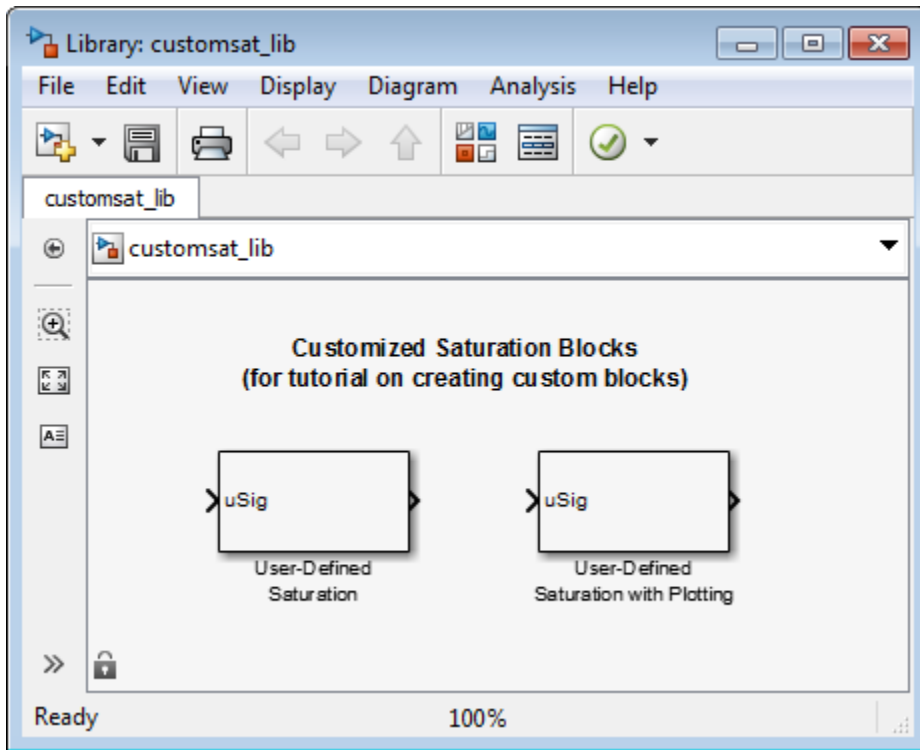

The example model `sldemo_customsat` uses the basic version of the block.

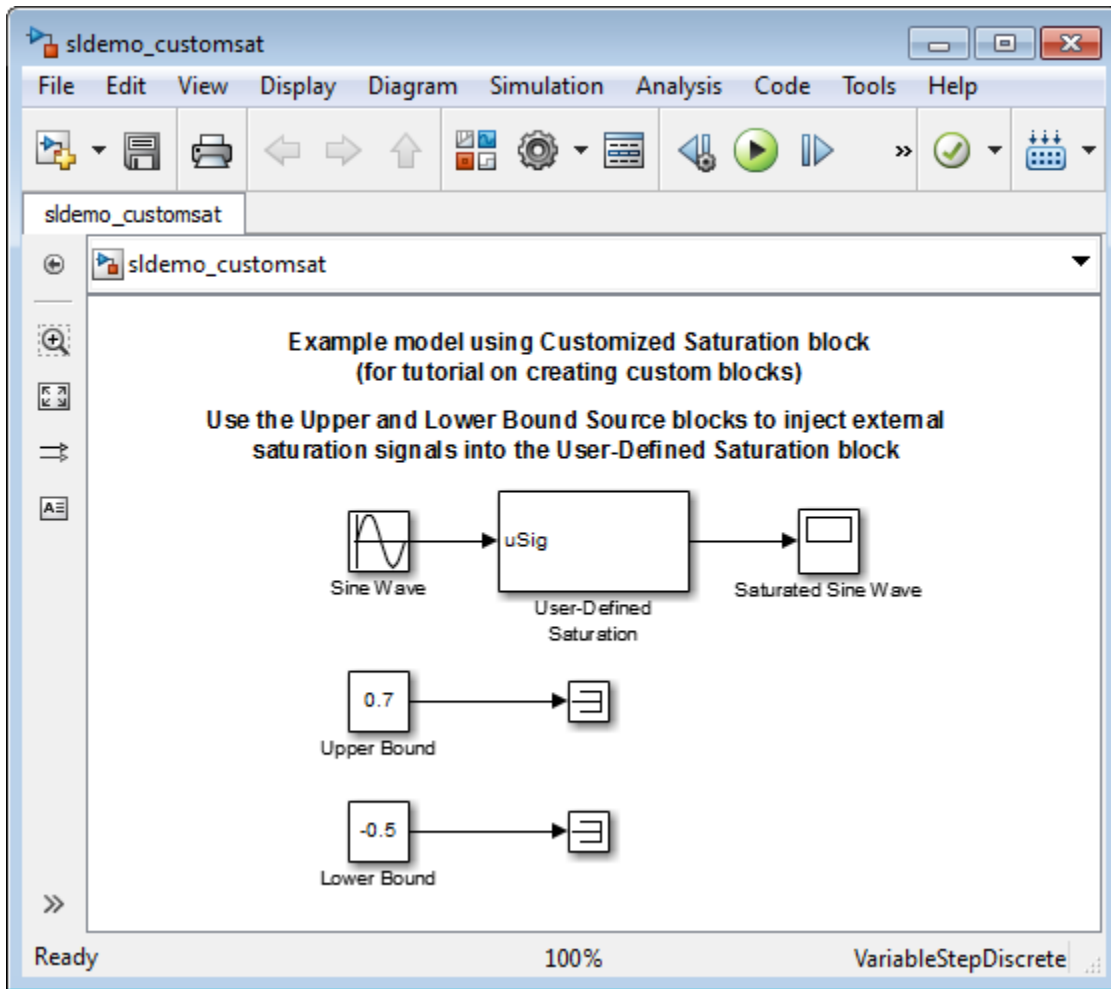

## Defining Custom Block Behavior

Begin by defining the features and limitations of your custom block. In this example, the block supports the following features:

- Turning on and off the upper or lower saturation limit.
- Setting the upper and/or lower limits via a block parameters.

- Setting the upper and/or lower limits using an input signal.

It also has the following restrictions:

- The input signal under saturation must be a scalar.
- The input signal and saturation limits must all have a data type of double.
- Code generation is not required.

## Deciding on a Custom Block Type

Based on the custom block features, the implementation needs to support the following:

- Multiple input ports
- A relatively simple algorithm
- No continuous or discrete system states

Therefore, this tutorial implements the custom block using a Level-2 MATLAB S-function. MATLAB S-functions support multiple inputs and, because the algorithm is simple, do not have significant overhead when updating the diagram or simulating the model. See “Comparison of Custom Block Functionality” on page 38-7 for a description of the different functionality provided by MATLAB S-functions as compared to other types of custom blocks.

### Parameterizing the MATLAB S-Function

Begin by defining the S-function parameters. This example requires four parameters:

- The first parameter indicates how the upper saturation limit is set. The limit can be off, set via a block parameter, or set via an input signal.
- The second parameter is the value of the upper saturation limit. This value is used only if the upper saturation limit is set via a block parameter. In the event this parameter is used, you should be able to change the parameter value during the simulation, i.e., the parameter is tunable.
- The third parameter indicates how the lower saturation limit is set. The limit can be off, set via a block parameter, or set via an input signal.
- The fourth parameter is the value of the lower saturation limit. This value is used only if the lower saturation limit is set via a block parameter. As with the upper saturation limit, this parameter is tunable when in use.

The first and third S-function parameters represent modes that must be translated into values the S-function can recognize. Therefore, define the following values for the upper and lower saturation limit modes:

- 1 indicates that the saturation limit is off.
- 2 indicates that the saturation limit is set via a block parameter.
- 3 indicates that the saturation limit is set via an input signal.

### Writing the MATLAB S-Function

After you define the S-function parameters and functionality, write the S-function. The template `msfuntmpl.m` provides a starting point for writing a Level-2 MATLAB S-function. You can find a completed version of the custom saturation block in the file `custom_sat.m`. Save this file to your working folder before continuing with this tutorial.

This S-function modifies the S-function template as follows:

- The `setup` function initializes the number of input ports based on the values entered for the upper and lower saturation limit modes. If the limits are set via input signals, the method adds input ports to the block. The `setup` method then indicates there are four S-function parameters and sets the parameter tunability. Finally, the method registers the S-function methods used during simulation.

```
function setup(block)

% The Simulink engine passes an instance of the Simulink.MSFcnRunTimeBlock
% class to the setup method in the input argument "block". This is known as
% the S-function block's run-time object.

% Register original number of input ports based on the S-function
% parameter values

try % Wrap in a try/catch, in case no S-function parameters are entered
    lowMode    = block.DialogPrm(1).Data;
    upMode     = block.DialogPrm(3).Data;
    numInPorts = 1 + isequal(lowMode,3) + isequal(upMode,3);
catch
    numInPorts=1;
end % try/catch
block.NumInputPorts = numInPorts;
block.NumOutputPorts = 1;

% Setup port properties to be inherited or dynamic
block.SetPreCompInpPortInfoToDynamic;
block.SetPreCompOutPortInfoToDynamic;

% Override input port properties
block.InputPort(1).DatatypeID = 0; % double
```

```

block.InputPort(1).Complexity = 'Real';

% Override output port properties
block.OutputPort(1).DatatypeID = 0; % double
block.OutputPort(1).Complexity = 'Real';

% Register parameters. In order:
% -- If the upper bound is off (1) or on and set via a block parameter (2)
%    or input signal (3)
% -- The upper limit value. Should be empty if the upper limit is off or
%    set via an input signal
% -- If the lower bound is off (1) or on and set via a block parameter (2)
%    or input signal (3)
% -- The lower limit value. Should be empty if the lower limit is off or
%    set via an input signal
block.NumDialogPrms = 4;
block.DialogPrmsTunable = {'Nontunable','Tunable','Nontunable', ...
    'Tunable'};

% Register continuous sample times [0 offset]
block.SampleTimes = [0 0];

%% -----
%% Options
%% -----
% Specify if Accelerator should use TLC or call back into
% MATLAB script
block.SetAcce1RunOnTLC(false);

%% -----
%% Register methods called during update diagram/compilation
%% -----

block.RegBlockMethod('CheckParameters', @CheckPrms);
block.RegBlockMethod('ProcessParameters', @ProcessPrms);
block.RegBlockMethod('PostPropagationSetup', @DoPostPropSetup);
block.RegBlockMethod('Outputs', @Outputs);
block.RegBlockMethod('Terminate', @Terminate);
%end setup function

```

- The **CheckParameters** method verifies the values entered into the Level-2 MATLAB S-Function block.

```

function CheckPrms(block)

lowMode = block.DialogPrm(1).Data;
lowVal = block.DialogPrm(2).Data;
upMode = block.DialogPrm(3).Data;
upVal = block.DialogPrm(4).Data;

% The first and third dialog parameters must have values of 1-3
if ~any(upMode == [1 2 3]);
    error('The first dialog parameter must be a value of 1, 2, or 3');
end

```



```

if ~any(lowMode == [1 2 3]);
    error('The first dialog parameter must be a value of 1, 2, or 3');
end

% If the upper or lower bound is specified via a dialog, make sure there
% is a specified bound. Also, check that the value is of type double
if isequal(upMode,2),
    if isempty(upVal),
        error('Enter a value for the upper saturation limit.');
```

```

    end
    if ~strcmp(class(upVal), 'double')
        error('The upper saturation limit must be of type double.');
```

```

    end
end

if isequal(lowMode,2),
    if isempty(lowVal),
        error('Enter a value for the lower saturation limit.');
```

```

    end
    if ~strcmp(class(lowVal), 'double')
        error('The lower saturation limit must be of type double.');
```

```

    end
end

% If a lower and upper limit are specified, make sure the specified
% limits are compatible.
if isequal(upMode,2) && isequal(lowMode,2),
    if lowVal >= upVal,
        error('The lower bound must be less than the upper bound.');
```

```

    end
end

%end CheckPrms function

```

- The `ProcessParameters` and `PostPropagationSetup` methods handle the S-function parameter tuning.

```

function ProcessPrms(block)

%% Update run time parameters
block.AutoUpdateRuntimePrms;

%end ProcessPrms function

function DoPostPropSetup(block)

%% Register all tunable parameters as runtime parameters.
block.AutoRegRuntimePrms;

%end DoPostPropSetup function

```

- The `Outputs` method calculates the block's output based on the S-function parameter settings and any input signals.

```
function Outputs(block)

lowMode    = block.DialogPrm(1).Data;
upMode     = block.DialogPrm(3).Data;
sigVal     = block.InputPort(1).Data;
lowPortNum = 2; % Initialize potential input number for lower saturation limit

% Check upper saturation limit
if isequal(upMode,2), % Set via a block parameter
    upVal = block.RuntimePrm(2).Data;
elseif isequal(upMode,3), % Set via an input port
    upVal = block.InputPort(2).Data;
    lowPortNum = 3; % Move lower boundary down one port number
else
    upVal = inf;
end

% Check lower saturation limit
if isequal(lowMode,2), % Set via a block parameter
    lowVal = block.RuntimePrm(1).Data;
elseif isequal(lowMode,3), % Set via an input port
    lowVal = block.InputPort(lowPortNum).Data;
else
    lowVal = -inf;
end

% Assign new value to signal
if sigVal > upVal,
    sigVal = upVal;
elseif sigVal < lowVal,
    sigVal=lowVal;
end

block.OutputPort(1).Data = sigVal;

%end Outputs function
```

## Placing Custom Blocks in a Library

Libraries allow you to share your custom blocks with other users, easily update the functionality of copies of the custom block, and collect blocks for a particular project into a single location. This example places the custom saturation block into a library.

- 1 In the Simulink Library Browser, select **File > New > Library**.
- 2 From the User-Defined Functions library, drag a Level-2 MATLAB S-Function block into your new library.

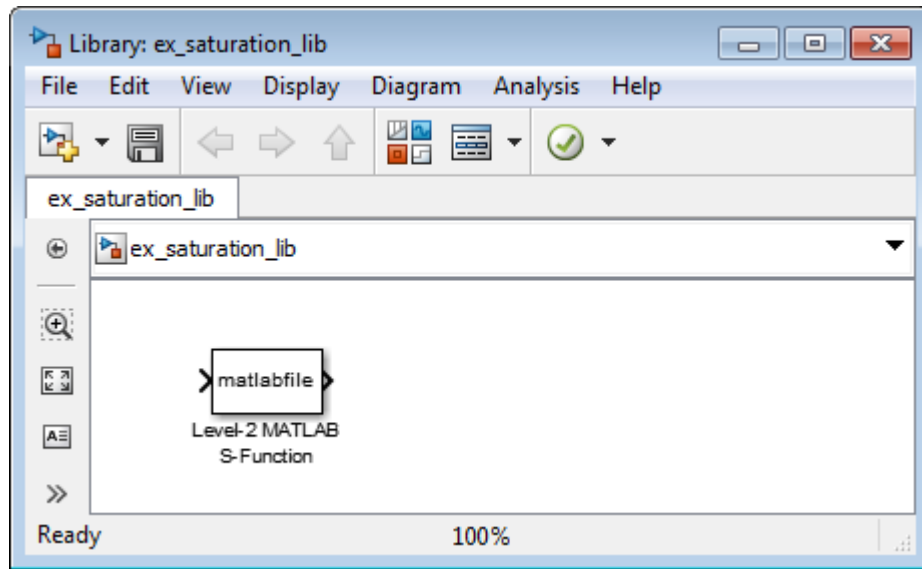

- 3 Save your library with the filename `saturation_lib`.
- 4 Double-click the block to open its Function Block Parameters dialog box.
- 5 In the **S-function name** field, enter the name of the S-function. For example, enter `custom_sat`. In the **Parameters** field enter `2, -1, 2, 1`.

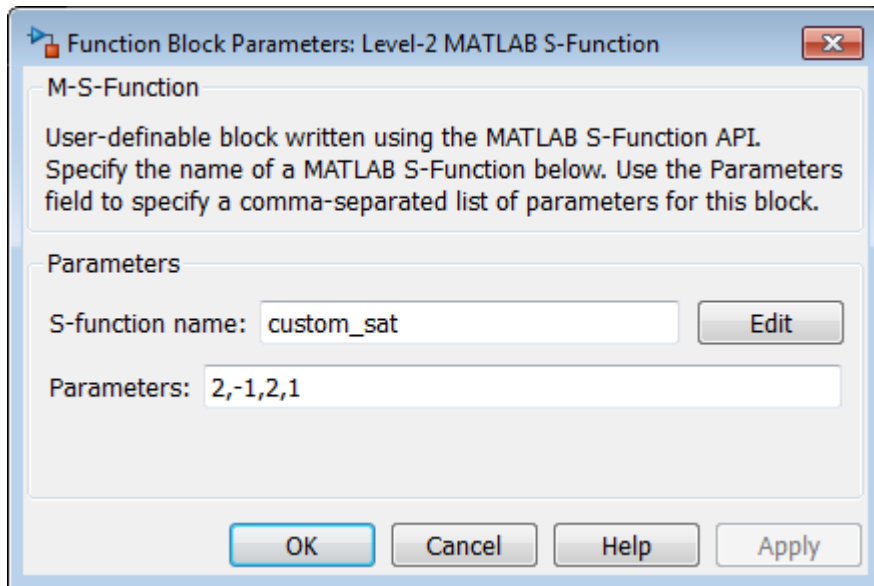

- 6 Click **OK**.

You have created a custom saturation block that you can share with other users.

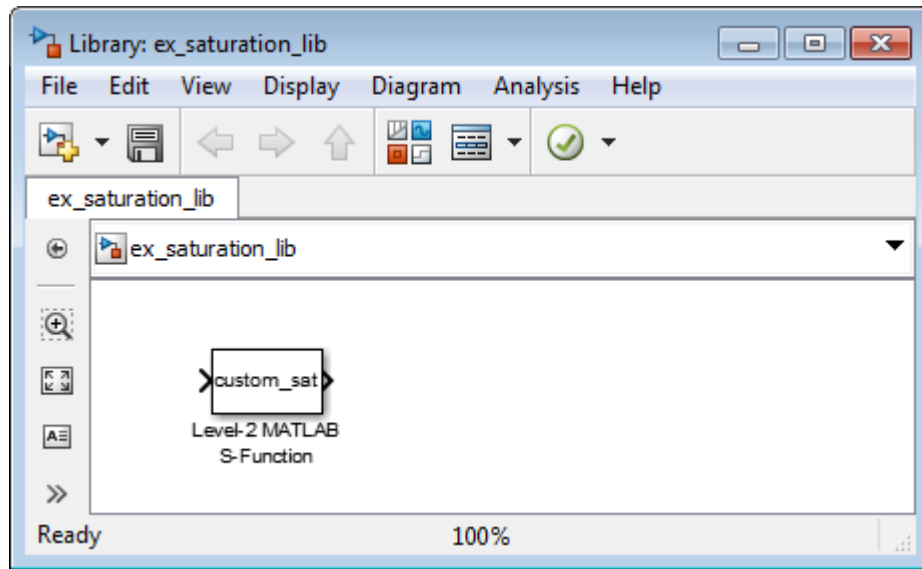

You can make the block easier to use by adding a customized user interface.

## Adding a User Interface to a Custom Block

You can create a block dialog box for a custom block using the masking features of Simulink. Masking the block also allows you to add port labels to indicate which ports corresponds to the input signal and the saturation limits.

- 1 Open the library `saturation_lib` that contains the custom block you created,
- 2 Right-click the Level-2 MATLAB S-Function block and select **Mask > Create Mask**.
- 3 On the **Icon & Ports** pane in the **Icons drawing commands** box, enter `port_label('input', 1, 'uSig')`, and then click **Apply**.

This command labels the default port as the input signal under saturation.

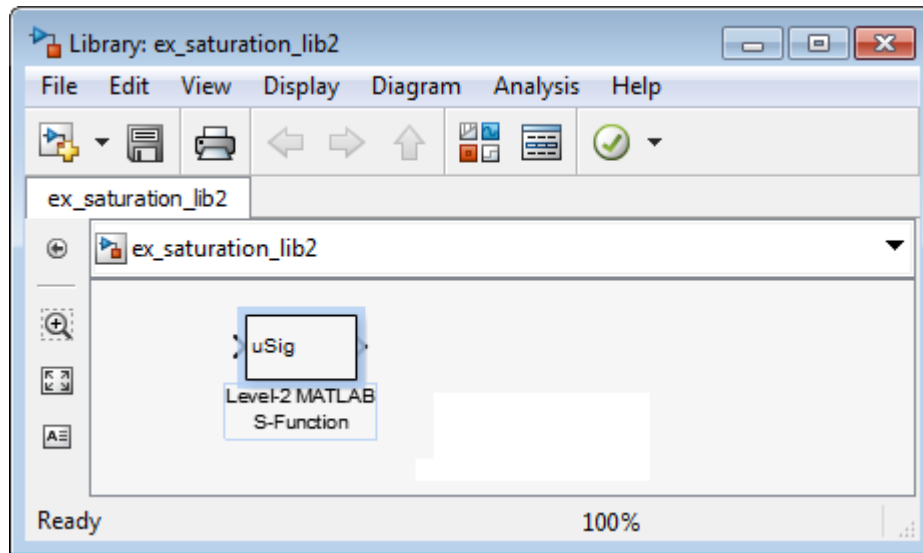

- 4 In the **Parameters & Dialog** pane, add four parameters corresponding to the four S-Function parameters. For each new parameter, drag a popup or edit control to the **Dialog box** section, as shown in the table. Drag each parameter into the Parameters group.

Type	Prompt	Name	Evaluate	Tunable	Popup options	Callback
popup	Upper boundary	upMode	✓		No limit  Enter limit as parameter  Limit using input signal	customsat_callback('upperbound_callback')
edit	Upper limit:	upVal	✓	✓	N/A	customsat_callback('upperparam_callback')

Type	Prompt	Name	Evaluate	Tunable	Popup options	Callback
popup	Lower boundary	lowMode	✓		No limit	customsat_callback('lowerbound_callback')

Type	Prompt	Name	Evaluate	Tunable	Popup options	Callback
					Enter limit as parameter	
					Limit using input signal	
edit	Lower limit:	lowVal	✓	✓	N/A	customsat_callback('lowerparam_callback')

The MATLAB S-Function script `custom_sat_final.m` contains the mask parameter callbacks. Save `custom_sat_final.m` to your working folder to define the callbacks in this example. This MATLAB script has two input arguments. The first input argument is a character vector indicating which mask parameter invoked the callback. The second input argument is the handle to the associated Level-2 MATLAB S-Function block.

The figure shows the completed **Parameters & Dialog** pane in the Mask Editor.

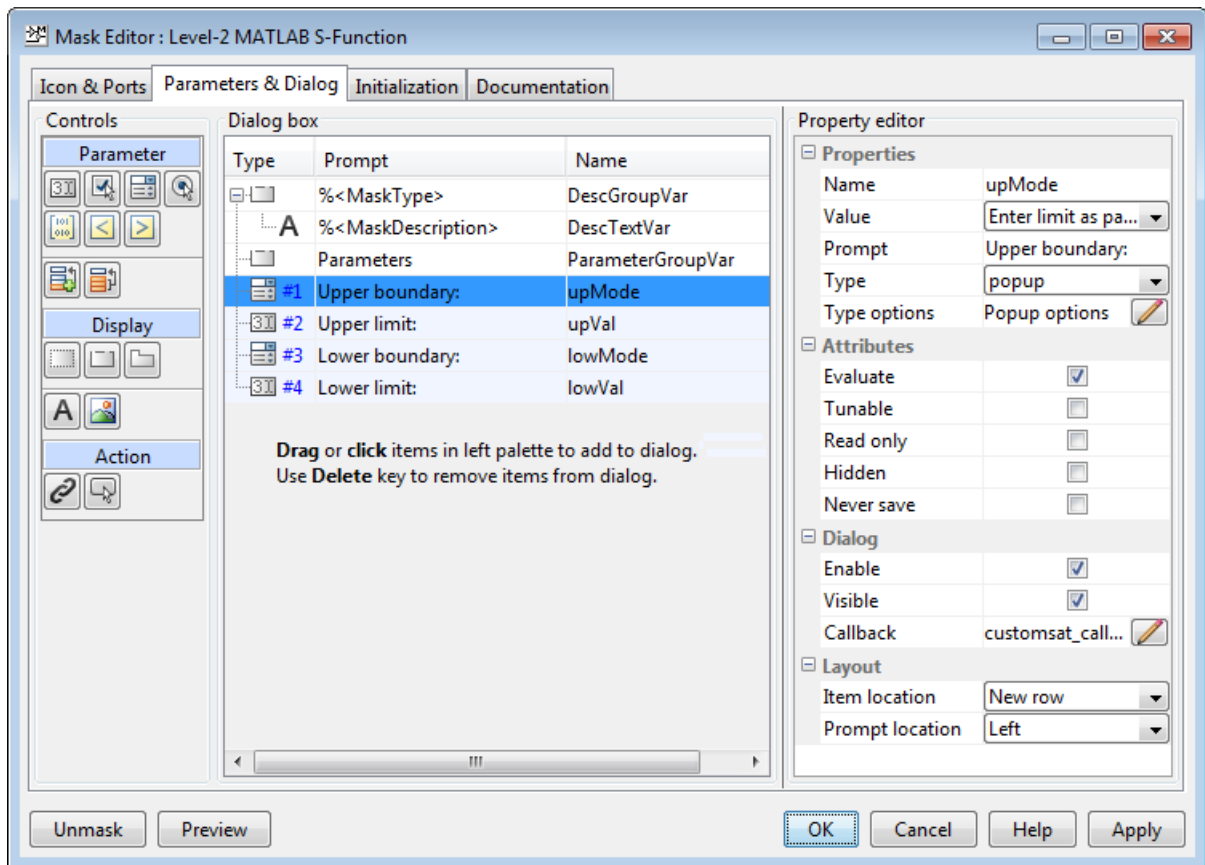

- 5 In the **Initialization** pane, select the **Allow library block to modify its contents** check box. This setting allows the S-function to change the number of ports on the block.
- 6 In the **Documentation** pane:
  - In the **Mask type** field, enter  
Customized Saturation
  - In the **Mask description** field, enter  
Limit the input signal to an upper and lower saturation value set either through a block parameter or input signal.



- 7 Click **OK**.
- 8 To map the S-function parameters to the mask parameters, right-click the Level-2 MATLAB S-Function block and select **Mask > Look Under Mask**.
- 9 Change the **S-function name** field to `custom_sat_final` and the **Parameters** field to `lowMode,lowVal,upMode,upVal`.

The figure shows the Function Block Parameters dialog box after the changes.

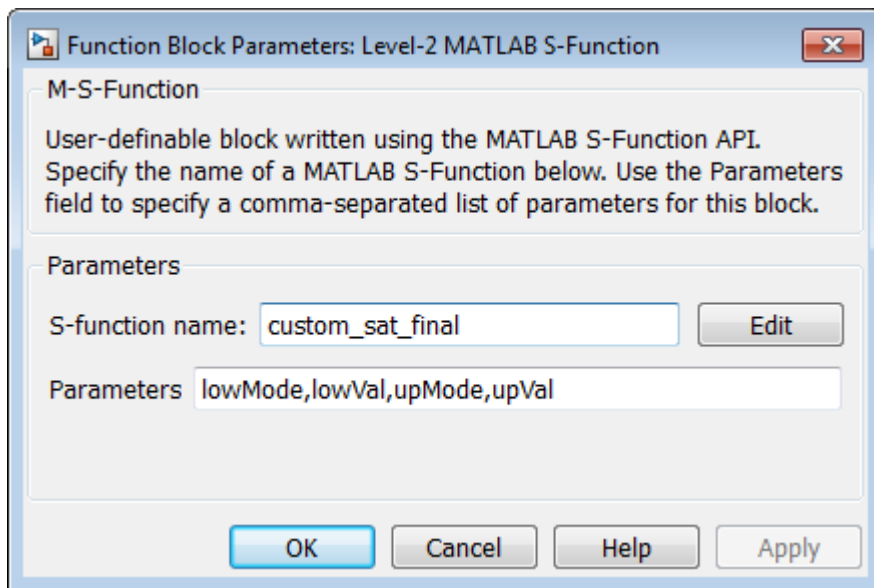

- 10 Click **OK**. Save and close the library to exit the edit mode.
- 11 Reopen the library and double-click the customized saturation block to open the masked parameter dialog box.

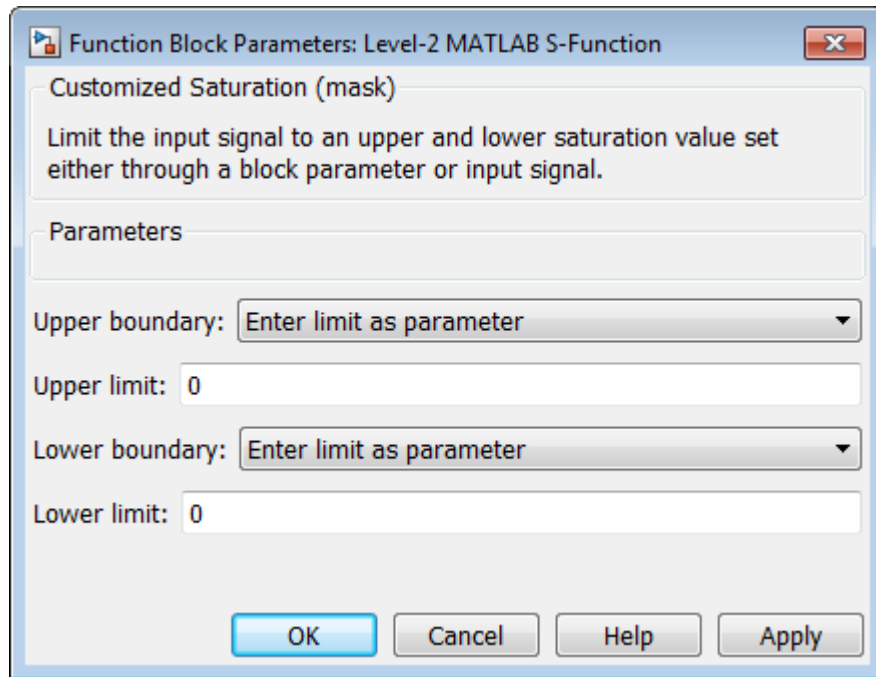

To create a more complicated user interface, place a MATLAB graphics user interface on top of the masked block. The block `OpenFcn` invokes the MATLAB graphics user interface, which uses calls to `set_param` to modify the S-function block parameters based on settings in the user interface.

### Writing the Mask Callback

The function `customsat_callback.m` contains the mask callback code for the custom saturation block mask parameter dialog box. This function invokes local functions corresponding to each mask parameter through a call to `feval`.

The following local function controls the visibility of the upper saturation limit's field based on the selection for the upper saturation limit's mode. The callback begins by obtaining values for all mask parameters using a call to `get_param` with the property name `MaskValues`. If the callback needed the value of only one mask parameter, it could call `get_param` with the specific mask parameter name, for example, `get_param(block, 'upMode')`. Because this example needs two of the mask parameter values, it uses the `MaskValues` property to reduce the calls to `get_param`.

The callback then obtains the visibilities of the mask parameters using a call to `get_param` with the property name `MaskVisibilities`. This call returns a cell array of character vectors indicating the visibility of each mask parameter. The callback alters the values for the mask visibilities based on the selection for the upper saturation limit's mode and then updates the port label text.

The callback finally uses the `set_param` command to update the block's `MaskDisplay` property to label the block's input ports.

```
function customsat_callback(action,block)
% CUSTOMSAT_CALLBACK contains callbacks for custom saturation block

% Copyright 2003-2007 The MathWorks, Inc.

%% Use function handle to call appropriate callback
feval(action,block)

%% Upper bound callback
function upperbound_callback(block)

vals = get_param(block,'MaskValues');
vis = get_param(block,'MaskVisibilities');
portStr = {'port_label(''input'',1,'uSig')'};
switch vals{1}
    case 'No limit'
        set_param(block,'MaskVisibilities',[vis(1);{'off'};vis(3:4)]);
    case 'Enter limit as parameter'
        set_param(block,'MaskVisibilities',[vis(1);{'on'};vis(3:4)]);
    case 'Limit using input signal'
        set_param(block,'MaskVisibilities',[vis(1);{'off'};vis(3:4)]);
        portStr = [portStr;{'port_label(''input'',2,'up')'}];
end
if strcmp(vals{3},'Limit using input signal'),
    portStr = [portStr;{'port_label(''input'',',num2str(length(portStr)+1), ...
        '','low')'}]];
end
set_param(block,'MaskDisplay',char(portStr));
```

The final call to `set_param` invokes the `setup` function in the MATLAB S-function `custom_sat.m`. Therefore, the `setup` function can be modified to set the number of input ports based on the mask parameter values instead of on the S-function parameter values. This change to the `setup` function keeps the number of ports on the Level-2 MATLAB S-Function block consistent with the values shown in the mask parameter dialog box.

The modified MATLAB S-function `custom_sat_final.m` contains the following new `setup` function. If you are stepping through this tutorial, open the file and save it to your working folder.

```
%% Function: setup =====
```

```

function setup(block)

% Register original number of ports based on settings in Mask Dialog
ud = getPortVisibility(block);
numInPorts = 1 + isequal(ud(1),3) + isequal(ud(2),3);

block.NumInputPorts = numInPorts;
block.NumOutputPorts = 1;

% Setup port properties to be inherited or dynamic
block.SetPreCompInpPortInfoToDynamic;
block.SetPreCompOutPortInfoToDynamic;

% Override input port properties
block.InputPort(1).DatatypeID = 0; % double
block.InputPort(1).Complexity = 'Real';

% Override output port properties
block.OutputPort(1).DatatypeID = 0; % double
block.OutputPort(1).Complexity = 'Real';

% Register parameters. In order:
% -- If the upper bound is off (1) or on and set via a block parameter (2)
%    or input signal (3)
% -- The upper limit value. Should be empty if the upper limit is off or
%    set via an input signal
% -- If the lower bound is off (1) or on and set via a block parameter (2)
%    or input signal (3)
% -- The lower limit value. Should be empty if the lower limit is off or
%    set via an input signal
block.NumDialogPrms = 4;
block.DialogPrmsTunable = {'Nontunable', 'Tunable', 'Nontunable', 'Tunable'};

% Register continuous sample times [0 offset]
block.SampleTimes = [0 0];

%% -----
%% Options
%% -----
% Specify if Accelerator should use TLC or call back into
% MATLAB script
block.SetAccelRunOnTLC(false);

%% -----
%% Register methods called during update diagram/compilation
%% -----

block.RegBlockMethod('CheckParameters', @CheckPrms);
block.RegBlockMethod('ProcessParameters', @ProcessPrms);
block.RegBlockMethod('PostPropagationSetup', @DoPostPropSetup);
block.RegBlockMethod('Outputs', @Outputs);
block.RegBlockMethod('Terminate', @Terminate);
%endfunction

```

The `getPortVisibility` local function in `custom_sat_final.m` uses the saturation limit modes to construct a flag that is passed back to the `setup` function. The `setup` function uses this flag to determine the necessary number of input ports.

```
%% Function: Get Port Visibilities =====
function ud = getPortVisibility(block)

ud = [0 0];

vals = get_param(block.BlockHandle, 'MaskValues');
switch vals{1}
    case 'No limit'
        ud(2) = 1;
    case 'Enter limit as parameter'
        ud(2) = 2;
    case 'Limit using input signal'
        ud(2) = 3;
end

switch vals{3}
    case 'No limit'
        ud(1) = 1;
    case 'Enter limit as parameter'
        ud(1) = 2;
    case 'Limit using input signal'
        ud(1) = 3;
end
```

## Adding Block Functionality Using Block Callbacks

The User-Defined Saturation with Plotting block in `customsat_lib` uses block callbacks to add functionality to the original custom saturation block. This block provides an option to plot the saturation limits when the simulation ends. The following steps show how to modify the original custom saturation block to create this new block.

- 1 Add a check box to the mask parameter dialog box to toggle the plotting option on and off.
  - a Right-click the Level-2 MATLAB S-Function block in `saturation_lib` and select **Mask+Create Mask**.
  - b On the Mask Editor **Parameters** pane, add a fifth mask parameter with the following properties.

Prompt	Name	Type	Tunable	Type options	Callback
Plot saturation limits	plotche	checkbox	No	NA	customsat_callback('plotsaturation

- c Click **OK**.

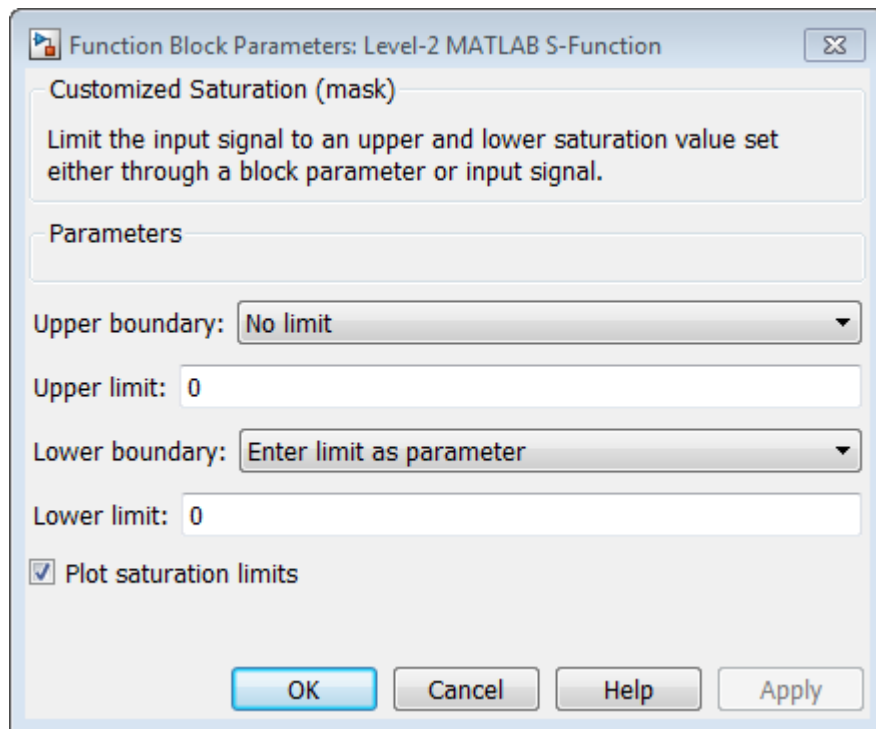

- 2 Write a callback for the new check box. The callback initializes a structure to store the saturation limit values during simulation in the Level-2 MATLAB S-Function block `UserData`. The MATLAB script `customsat_plotcallback.m` contains this new callback, as well as modified versions of the previous callbacks to handle the new mask parameter. If you are following through this example, open `customsat_plotcallback.m` and copy its local functions over the previous local functions in `customsat_callback.m`.

```

%% Plotting checkbox callback
function plotsaturation(block)

% Reinitialize the block's userdata
vals = get_param(block, 'MaskValues');
ud = struct('time', [], 'upBound', [], 'upVal', [], 'lowBound', [], 'lowVal', []);

if strcmp(vals{1}, 'No limit'),
    ud.upBound = 'off';
else
    ud.upBound = 'on';
end

if strcmp(vals{3}, 'No limit'),
    ud.lowBound = 'off';
else
    ud.lowBound = 'on';
end

set_param(gcb, 'UserData', ud);

```

- 3** Update the MATLAB S-function `Outputs` method to store the saturation limits, if applicable, as done in the new MATLAB S-function `custom_sat_plot.m`. If you are following through this example, copy the `Outputs` method in `custom_sat_plot.m` over the original `Outputs` method in `custom_sat_final.m`

```

%% Function: Outputs =====
function Outputs(block)

lowMode    = block.DialogPrm(1).Data;
upMode     = block.DialogPrm(3).Data;
sigVal     = block.InputPort(1).Data;
vals = get_param(block.BlockHandle, 'MaskValues');
plotFlag = vals{5};
lowPortNum = 2;

% Check upper saturation limit
if isequal(upMode, 2)
    upVal = block.RuntimePrm(2).Data;
elseif isequal(upMode, 3)
    upVal = block.InputPort(2).Data;
    lowPortNum = 3; % Move lower boundary down one port number
else
    upVal = inf;
end

% Check lower saturation limit
if isequal(lowMode, 2),
    lowVal = block.RuntimePrm(1).Data;
elseif isequal(lowMode, 3)
    lowVal = block.InputPort(lowPortNum).Data;
else
    lowVal = -inf;
end

```

```

% Use userdata to store limits, if plotFlag is on
if strcmp(plotFlag,'on');
    ud = get_param(block.BlockHandle,'UserData');
    ud.lowVal = [ud.lowVal;lowVal];
    ud.upVal = [ud.upVal;upVal];
    ud.time = [ud.time;block.CurrentTime];
    set_param(block.BlockHandle,'UserData',ud)
end

% Assign new value to signal
if sigVal > upVal,
    sigVal = upVal;
elseif sigVal < lowVal,
    sigVal=lowVal;
end

block.OutputPort(1).Data = sigVal;

%endfunction

```

- 4** Write the function `plotsat.m` to plot the saturation limits. This function takes the handle to the Level-2 MATLAB S-Function block and uses this handle to retrieve the block's `UserData`. If you are following through this tutorial, save `plotsat.m` to your working folder.

```

function plotSat(block)

% PLOTSAT contains the plotting routine for custom_sat_plot
% This routine is called by the S-function block's StopFcn.

ud = get_param(block,'UserData');
fig=[];
if ~isempty(ud.time)
    if strcmp(ud.upBound,'on')
        fig = figure;
        plot(ud.time,ud.upVal,'r');
        hold on
    end
    if strcmp(ud.lowBound,'on')
        if isempty(fig),
            fig = figure;
        end
        plot(ud.time,ud.lowVal,'b');
    end
    if ~isempty(fig)
        title('Upper bound in red. Lower bound in blue.')
    end

% Reinitialize userdata
ud.upVal=[];
ud.lowVal=[];
ud.time = [];
set_param(block,'UserData',ud);
end

```



- 5 Right-click the Level-2 MATLAB S-Function block and select **Properties**. The Block Properties dialog box opens. On the **Callbacks** pane, modify the **StopFcn** to call the plotting callback as shown in the following figure, then click **OK**.

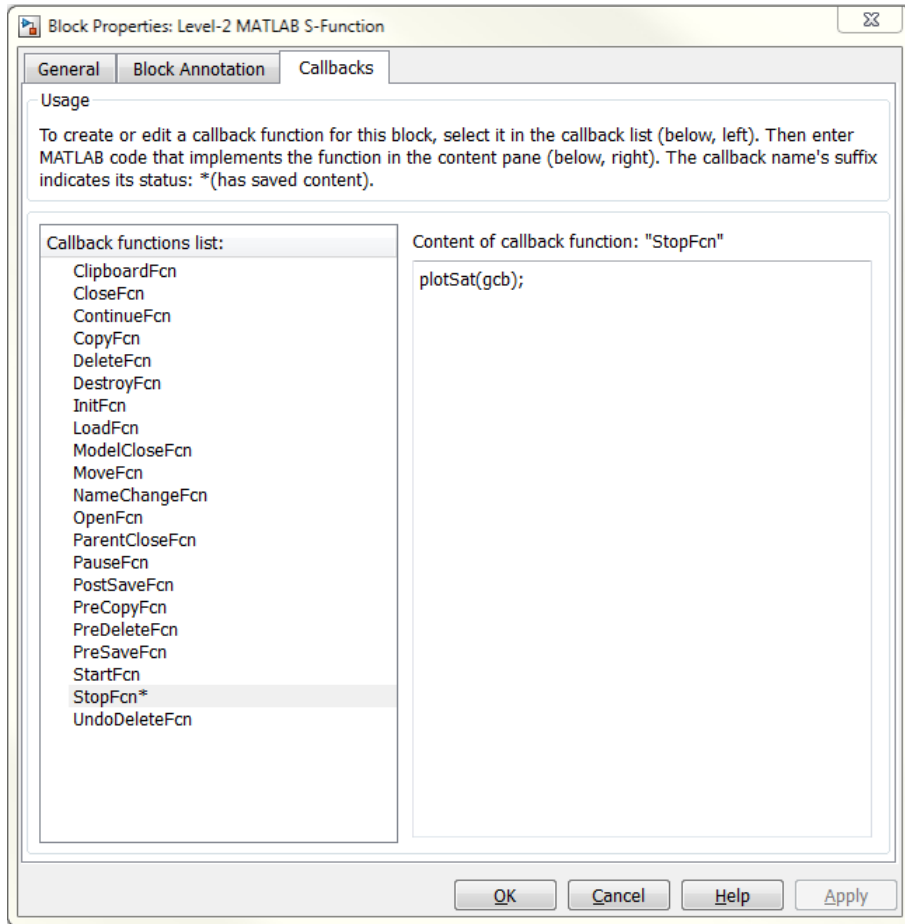

## More About

- “Create Your Own Simulink Block” on page 38-2
- “Comparison of Custom Block Functionality” on page 38-7
- “Expanding Custom Block Functionality” on page 38-18



# Working with Block Libraries

---

- “Custom Libraries and Linked Blocks” on page 39-2
- “Create a Custom Library” on page 39-4
- “Add Libraries to the Library Browser” on page 39-10
- “Linked Blocks” on page 39-15
- “Parameterized Links and Self-Modifiable Linked Subsystems” on page 39-19
- “Display Library Links” on page 39-25
- “Disable or Break Links to Library Blocks” on page 39-27
- “Lock Links to Blocks in a Library” on page 39-29
- “Restore Disabled or Parameterized Links” on page 39-31
- “Fix Unresolved Library Links” on page 39-34
- “Control Linked Block Programmatically” on page 39-37
- “Forwarding Tables” on page 39-40

## Custom Libraries and Linked Blocks

### Why Create Custom Libraries?

A *block library* is a collection of blocks that you can use to create instances of those blocks in a Simulink model. You can create instances of blocks from installed Simulink libraries, and you can create custom libraries to create and maintain instances of your own blocks in models.

You can access the installed libraries from the Simulink Library Browser. You cannot modify the installed libraries. Instead, if you want others to be able to create customized blocks, you can create your own library of your blocks and add it to the Library Browser. Otherwise, you can make your library accessible to the models that use it.

Creating your own libraries is a useful componentization technique for:

- Providing frequently used, and seldom changed, modeling utilities
- Reusing components in a model or in multiple models

To learn how using custom libraries compares to other Simulink componentization techniques, see “Manage Components Using Libraries” on page 21-11 and “Componentization Guidelines” on page 15-29.

### How Block Instances Connect to Libraries

When you add masked blocks, subsystems, or charts from a custom library to a model, the block you add becomes a *linked block*. A linked block connects to the library block by way of a *library link*. The library block is the *prototype block*, and the linked block in the model is an *instance* of the library block.

The linked block looks and acts like the library block. However, if you change the library block, you need to update the link on the instances. Making changes to an instance can also require additional steps. To learn about how linked blocks work, see “Linked Blocks” on page 39-15.

### Related Examples

- “Linked Blocks” on page 39-15
- “Create a Custom Library” on page 39-4

- “Manage Components Using Libraries” on page 21-11

## Create a Custom Library

### In this section...

- “Create a Library” on page 39-4
- “Blocks for Custom Libraries” on page 39-5
- “Annotations in Custom Libraries” on page 39-7
- “Lock and Unlock Libraries” on page 39-8
- “Prevent Disabling of Library Links” on page 39-8

### Create a Library

You can create your own library and, optionally, add it to the Simulink Library Browser. You save a library as a .SLX file as you do a model. However, you cannot simulate in a library, and a library becomes locked for editing each time you close it. You must unlock a library before you make changes to it. See “Lock and Unlock Libraries” on page 39-8.

- 1 From the Simulink start page, select **Blank Library** and click **Create Library**.
- 2 Add blocks from models or libraries to the new library. Make the changes you want to the blocks, such as changing block parameters, adding masks, or adding blocks to subsystems.

Subsystem names in a library hierarchy must be unique. For example, do not create a hierarchy such as `Subsystem_Name1/Subsystem_Name2/Subsystem_Name1`.

- 3 Add annotations or images. Right-click the ones you want to appear in the library in the Library Browser and select **Show in Library Browser**.
- 4 If you plan to add the library to the Library Browser, you can order the blocks and annotations in your library model. By default, they appear alphabetically in the Library Browser, with subsystems first, then blocks, and then annotations. The user of your library can use the Library Browser context menu to choose between viewing them in alphabetical order or the order you specified. When the user selects this option, the order in which they appear in your library model determines the order they appear on the grid in the library in the Library Browser.
- 5 If you want the library to appear in the Library Browser, enable the model property `EnableLBRepository` before you save the library.

```
set_param(gcs, 'EnableLBRepository', 'on');
```

## 6 Save the library.

Where you save the library depends on how you plan to use it. If you want to add it to the Library Browser, save it to a folder on the MATLAB path or add the location to the MATLAB path. Otherwise, save it to a location where the models that use the blocks can access it.

If you want the library to appear in the Library Browser, you must also create a function `slblocks` on your MATLAB path that adds the library to the browser. For an example that shows complete steps for adding a library to the browser, see “Add Libraries to the Library Browser” on page 39-10.

---

**Note:** To update the Library Browser with your custom libraries, right-click anywhere in the Library Browser library list and select **Refresh Library Browser**. Refreshing the Library Browser also updates the quick insert list to include the blocks in custom libraries currently in effect. The quick insert list lets you add blocks to a model without leaving the canvas. Click the canvas and start typing to add blocks from the quick insert list.

---

## Blocks for Custom Libraries

Your library can contain the blocks you need, configured for your purposes. Subsystems, masked blocks, and charts in your library become linked blocks as instances in the model and stay updated if you change them in your library. Knowing about custom blocks is also useful when you create a library. See “Create a Custom Block” on page 38-19.

You can create blocks in custom libraries with settings for specific purposes.

### Create a Sublibrary

If your library contains many blocks, you can group the blocks into subsystems or separate sublibraries. To create a sublibrary, you create a library of the sublibrary blocks and reference the library from a Subsystem block in the parent library.

- 1 In the library you want to add a sublibrary to, add a Subsystem block.
- 2 Inside the Subsystem block, delete the default input and output ports.
- 3 If you want, create a mask for the subsystem that displays text or an image that conveys the sublibrary’s purpose.

- 4 In the subsystem's block properties, set the `OpenFcn` callback to the name of the library you want to reference.

To learn more about masks, see “Create a Simple Mask” on page 37-7.

### Prevent Library Block from Linking to Instance

You can configure a library block so the instances created from it are not linked blocks and are instead copies. Set the block's `CopyFcn` callback.

```
set_param(gcbh, 'LinkStatus', 'none');
```

### Include Block Description in Linked Block

To add a description that appears in the linked block, mask the library block and add the description in the **Documentation** pane of the mask. Descriptions added to the library block through the block's properties do not appear on the linked block.

### Configure Subsystems with OpenFcn Callback for Library Browser

A common use of a Subsystem block in a custom library is to set the `OpenFcn` callback property to open a library, creating a library hierarchy. However, you can use the `OpenFcn` callback property of a Subsystem block for other purposes, for example to run MATLAB code or to open a link.

If your subsystem block in a library is empty and its `OpenFcn` callback contains code that performs an action other than point to a library or model, then you need to add a `ShowInLibBrowser` mask parameter to the subsystem to have it appear in the Library Browser.

- 1 Right-click the subsystem and select **Mask > Create Mask**. If the block already has a mask, select **Edit Mask** instead.
- 2 In the Mask Editor **Parameters & Dialog** tab, on the **Controls** pane, click **Check box**.
- 3 In the **Dialog box** pane, set the prompt and name for the new check box to `ShowInLibBrowser` and click **OK**.



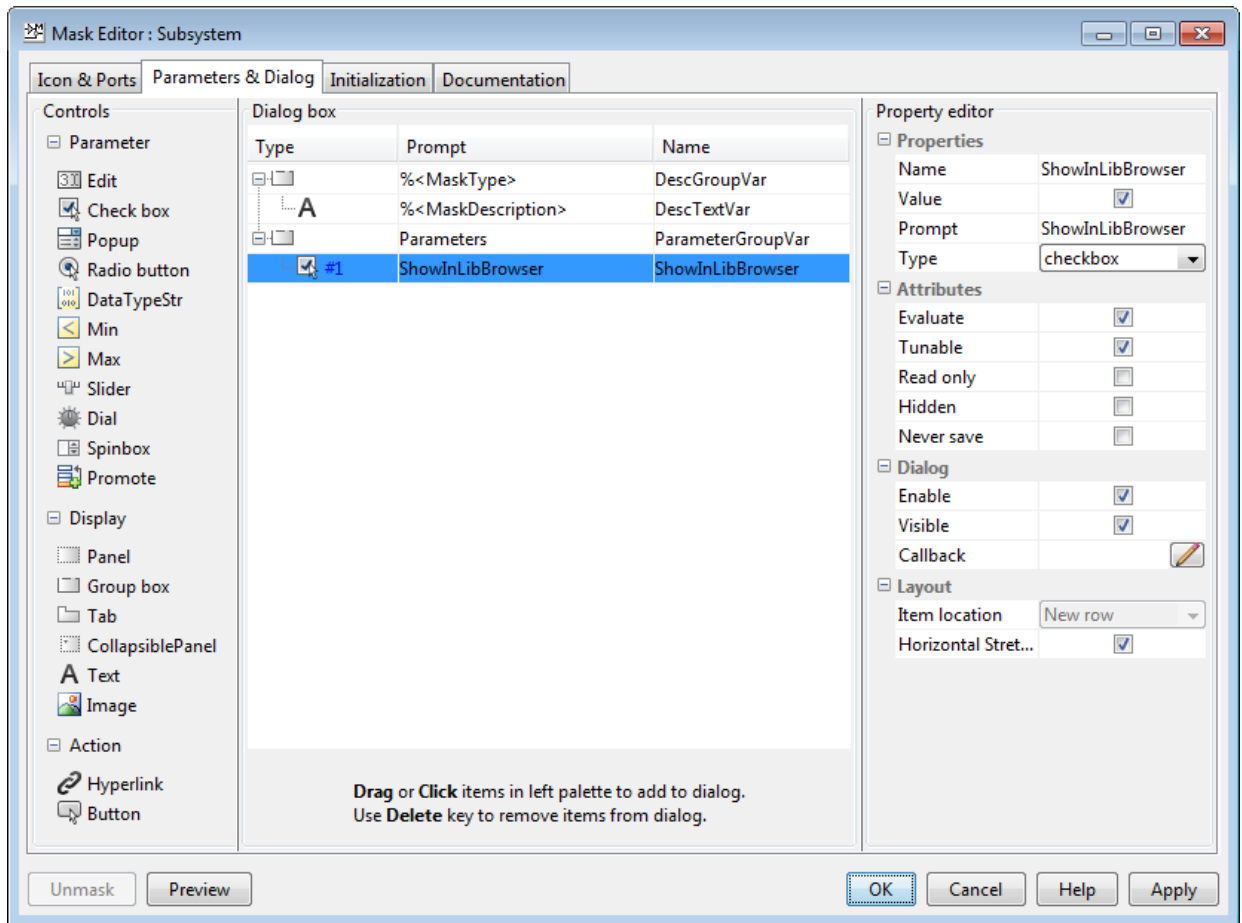

## Annotations in Custom Libraries

You can add annotations in your custom library and optionally have them appear in the Library Browser. For example, you can add an annotation that documents the library. You can also add annotations that the user of your library can add to their model from the Library Browser. Annotations can contain text and images or display an equation. Annotations can also perform an action when clicked. Learn more about annotations in “Describe Models Using Annotations” on page 4-3.

You can add callout lines from annotations to blocks in your library. However, the callouts do not appear in the Library Browser.

If you want the annotation to appear in the Library Browser, after you add it to your library, right-click it and select **Show in Library Browser**. If you want a description to appear in a tooltip when the user hovers over the annotation in the Library Browser, add the description to the annotation programmatically. At the MATLAB command prompt, enter:

```
set_param(annotationHandle,'Description','descriptionText')
```

To get the annotation handle, use `find_system`. This example gets all the annotations in the library `mylib`:

```
ann = find_system('mylib','FindAll','on','Type','annotation');
```

To get a specific annotation, turn on regular expression search and specify part of the annotation text with the `'Name'` argument:

```
ann = find_system('mylib2','FindAll','on','RegExp','on','Type','annotation',...  
'Name','matchingText');
```

“Add Libraries to the Library Browser” on page 39-10 includes instructions for adding an annotation that appears in the Library Browser.

## Lock and Unlock Libraries

When you close a library, it becomes locked for editing. When you next open it, unlock it if you want to make changes to it. Click the lock badge in the lower-left corner of the library to unlock it. Additionally, if you try to modify a locked library, a message prompts you to unlock it.

You can unlock a library programmatically. At the MATLAB command prompt, enter:

```
set_param('library_name','Lock','off');
```

To lock the library programmatically, enter:

```
set_param('library_name','Lock','on');
```

## Prevent Disabling of Library Links

By default, a user of the blocks in your library can disable the link to library blocks. If you want to control editing of linked blocks and prevent the block user from disabling

links, you can lock links to your library. Locking library links prevents the user from making any changes to the block instances.

- In your library, select **Diagram > Lock Links To Library**.

To understand how the block user interacts with blocks from locked libraries, see “Lock Links to Blocks in a Library” on page 39-29.

## **More About**

- “Create a Custom Block” on page 38-19
- “Custom Libraries and Linked Blocks” on page 39-2
- “Masking Fundamentals” on page 37-2
- “Describe Models Using Annotations” on page 4-3
- “Add Libraries to the Library Browser” on page 39-10
- “Linked Blocks” on page 39-15
- “Customize Library Browser Appearance” on page 65-23

## Add Libraries to the Library Browser

This example shows how to create a block library and add it to the Simulink Library Browser. You also add an annotation to the library that appears in the Library Browser.

You create a function `sliblocks` to specify information about your library. You can save the function as a `.m` or `.mlx` file. You cannot save it as a P-code file.

- 1 From the Simulink start page, select **Blank Library** and click **Create Library**.
- 2 Add a Gain block and two Subsystem blocks to the library. Name the Subsystem blocks Subsystem1 and Subsystem2. In the Subsystem2 properties, set the `OpenFcn` callback to `mylib2`.

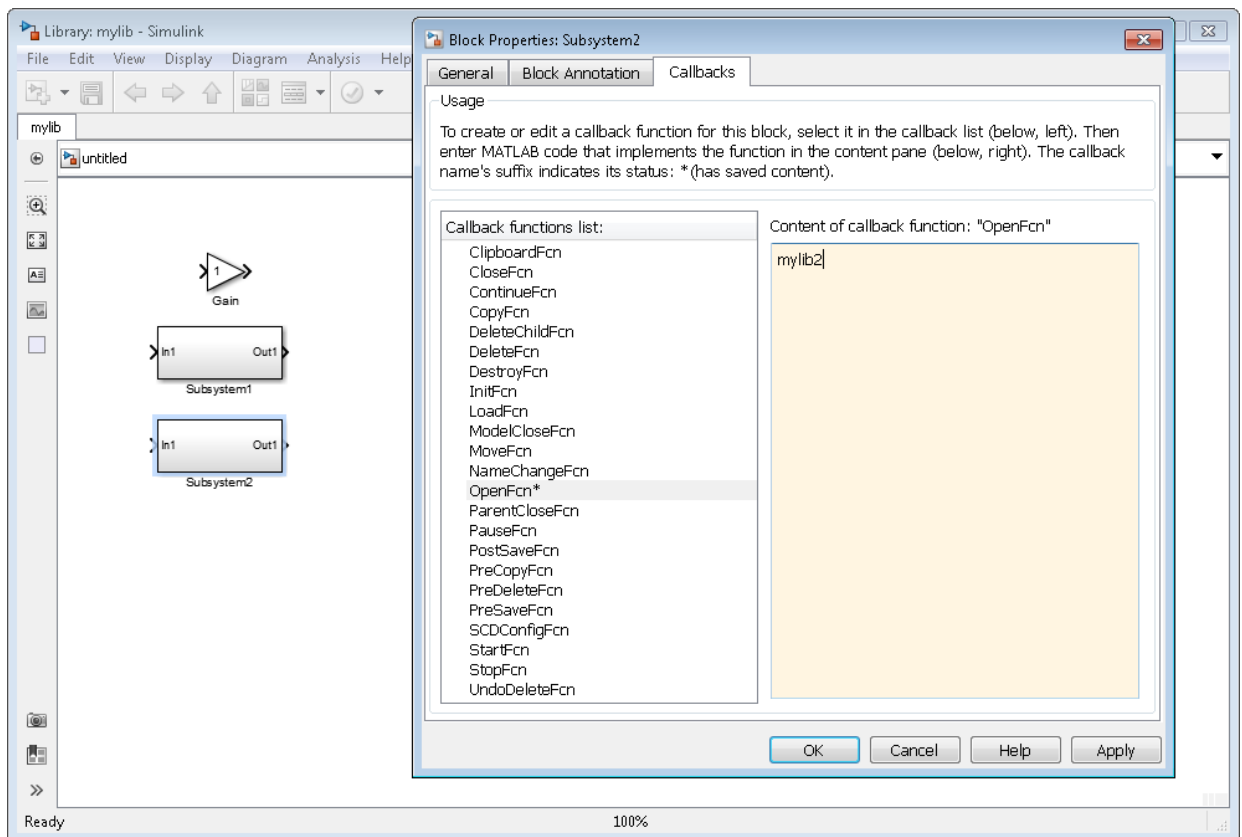

- 3 At the MATLAB command prompt, enter this command to enable the model property `EnableLBRepository`. Your library can appear in the browser only if this property is on when you save your library.

```
set_param(gcs, 'EnableLBRepository', 'on');
```

- 4 Save the library in a folder on the MATLAB path. For this example, name the library `mylib`.
- 5 Create another library `mylib2` and add some blocks and an annotation that contains the text `My annotation`. Right-click the annotation and select **Show in Library Browser**.
- 6 Add a description for the annotation. The description appears in the Library Browser when you hover over the annotation. You can do this programmatically using `set_param`. Use `find_system` to get the annotation handle. Use part of your annotation text with the `'Name'` argument. The `'RegExp'` argument enables partial matches.

```
ann = find_system('mylib2', 'findall', 'on', 'RegExp', 'on', 'Type', 'annotation', ...
    'Name', 'annotation');
set_param(ann, 'Description', 'Use this annotation to label the model.');
```

- 7 Save `mylib2` to the same folder you saved `mylib` to.

You can close both libraries if you want.

- 8 In MATLAB, right-click the folder you saved the library to and select **New File > Script**. Name the file `slblocks.m`.
- 9 Open `slblocks.m`. Add this function to it and save.

```
function blkStruct = slblocks
    % This function specifies that the library should appear
    % in the Library Browser
    % and be cached in the browser repository

    Browser.Library = 'mylib';
    % 'mylib' is the name of the library

    Browser.Name = 'My Library';
    % 'My Library' is the library name that appears in the Library Browser

    blkStruct.Browser = Browser;
```

- 10 In the Library Browser, refresh to see the new library. Right-click the library list and select **Refresh Library Browser**.

The figure shows the example library `mylib` with the Library Browser name **My Library**.

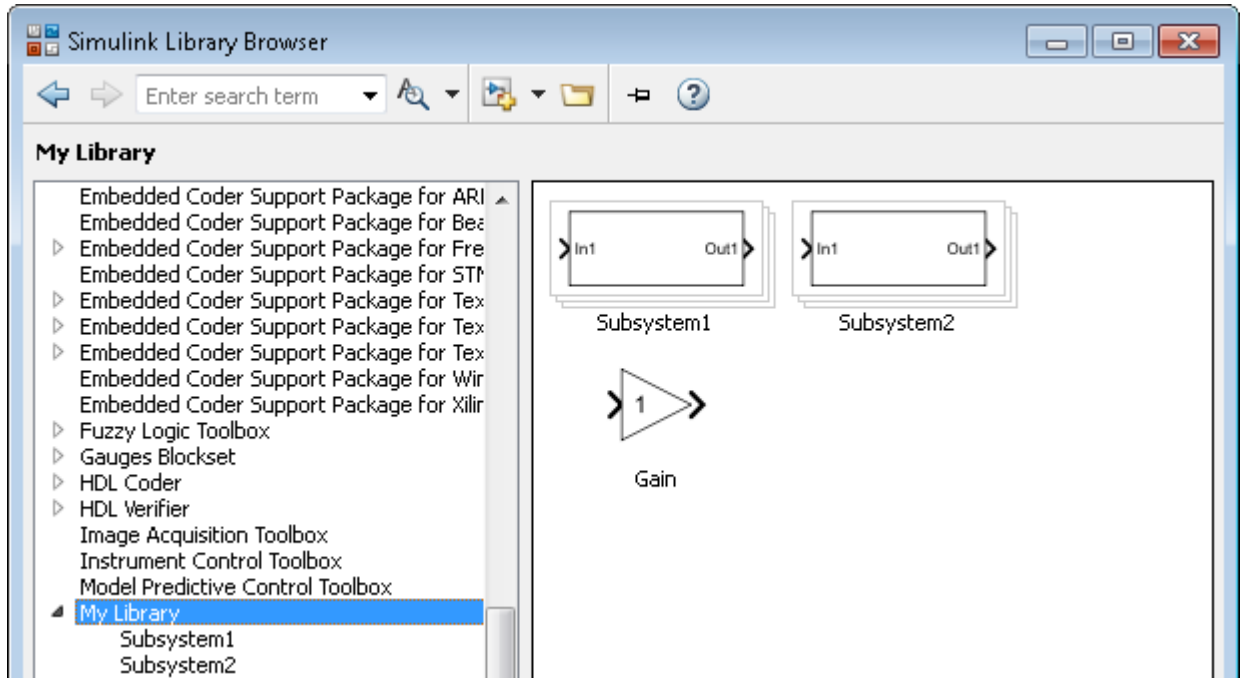

Because of the callback you created, clicking `Subsystem2` displays the contents of the `mylib2` library. Hovering over the annotation in the Library Browser displays the description.

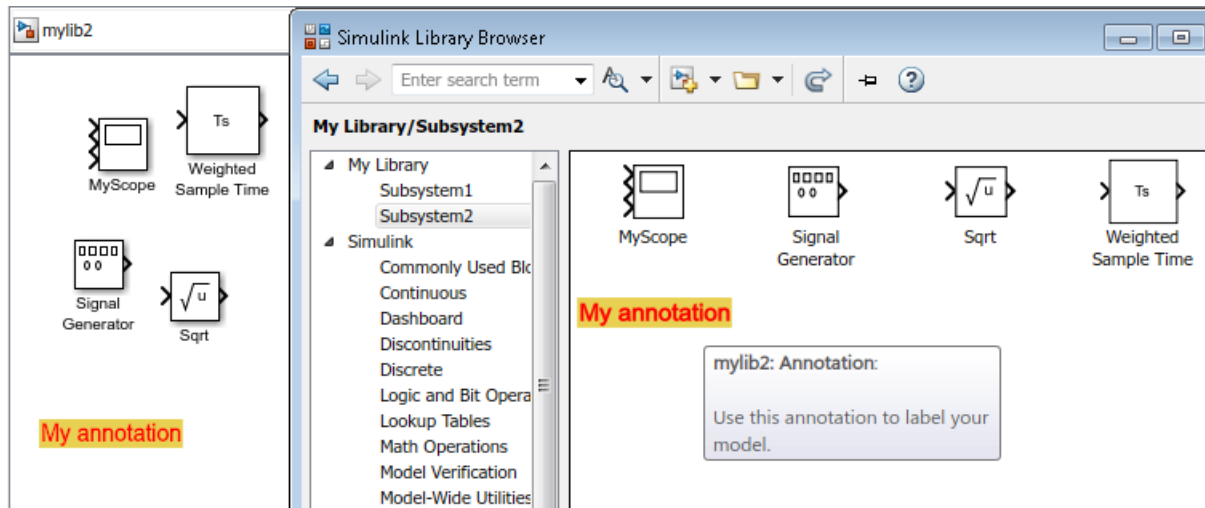

**Note:** If you saved your library without setting 'EnableLBRepository' to 'on', a message appears at the top of the Library Browser.

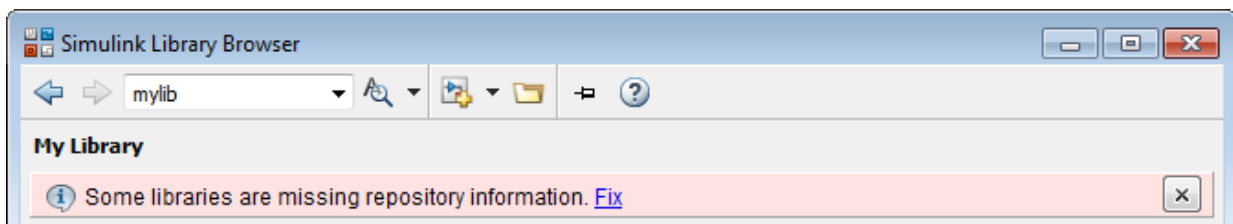

Click **Fix** and respond to the prompt as appropriate.

## Specify Library Order in the Library List

You can specify the order of your library relative to the other libraries in the list by adding a `sl_customization.m` file to the MATLAB path and setting the sort priority of your library. For example, to see your library at the top of the list, you can set the sort priority to `-2`. By default, the sort priority of the Simulink library is `-1`. The other libraries have a sort priority of `0` by default, and these libraries appear below the Simulink library. Libraries with the same sort priority appear in alphabetical order.

This sample content of the `sl_customization.m` file places the new library at the top of the list of libraries.

```
function sl_customization(cm)
% Change the order of libraries in the Simulink Library Browser.
cm.LibraryBrowserCustomizer.applyOrder({'My Library',-2});
end
```

To make the customization take effect immediately, at the command prompt, enter:

```
sl_refresh_customizations
```

## Related Examples

- “Create a Custom Library” on page 39-4
- “Customize Library Browser Appearance” on page 65-23

## More About

- “Registering Customizations” on page 65-26



## Linked Blocks

### In this section...

“Rules for Linked Blocks” on page 39-16  
 “Linked Block Terminology” on page 39-16

When you add a masked library block or a Subsystem block from a Library to a Simulink model, a referenced instance of the library block is created. Such referenced instance of a library block is called a linked block and contains link or path to the parent library block. The link or path allows the linked block to update when the library block is updated.

To locate the parent library block of a linked block, right-click the block and select **Library Link > Go To Library Link** (Ctrl + L). The **Go To Library Link** option is available only for the blocks that are linked and not for the Simulink built-in blocks. To prevent unintentional disabling of links to a library, use the locked links option on the library. For more information, see “Lock Links to Blocks in a Library” on page 39-29.

**Note:** The tooltip for a linked block shows the name of the referenced masked library block.



When you edit a library block (either in Simulink Editor or at the command line), Simulink updates the changes in the corresponding linked blocks. The outdated links are updated when you:

- Simulate or update the model.
- Use the `find_system` command.
- **Diagram > Refresh Blocks (or press Ctrl+K)**
- Load the model or library (only visible links are updated).
- Use `get_param` to query the link status of the block (see “Control Linked Block Programmatically” on page 39-37).

---

**Note:** You can use the `LinkStatus` parameter or the `StaticLinkStatus` parameter to query the link status.

- `LinkStatus`: First updates the linked block and then returns the link status.
- `StaticLinkStatus`: Returns the link status without updating the linked block.

Selective usage of `StaticLinkStatus` over `LinkStatus` can result in better Simulink performance. For more information on `StaticLinkStatus` and `LinkStatus`, see “Control Linked Block Programmatically” on page 39-37.

---

## Rules for Linked Blocks

- You can change the values of a linked block parameter (including the existing mask).

---

**Note:** The **Allow library block to modify its contents** check box in the **Initialization** pane of the library block must be selected.

---

- You cannot set callback parameters for a linked block.
- If the reference library block of a linked block is a subsystem, you can make nonstructural changes such as changing the parameter value of the linked subsystem. To make structural changes to a linked block, disable the link of the linked block from its library block (See “Disable or Break Links to Library Blocks” on page 39-27).

## Linked Block Terminology

Terminology	Definition
Parent library block	Library block from which the linked blocks are referenced.
Linked block	Reference instance of a library block that contains links or path to its parent library block.
Locked links	Prevents unintentional modification of a linked block. For more information, see “Lock Links to Blocks in a Library” on page 39-29.

Terminology	Definition
Disabled links	Library links that are temporarily disconnected from their parent library block. For more information, see “Disable or Break Links to Library Blocks” on page 39-27.
Restore links	Restores the disabled link of a linked block to their parent library block. For more information, see “Restore Disabled or Parameterized Links” on page 39-31.
Break links	Permanently breaks link of a linked block from its parent library block. For more information, see “Disable or Break Links to Library Blocks” on page 39-27.
Self-Modifiable links	Linked block with the ability to have structural changes in a linked Subsystem block. For more information, see “Self-Modifiable Linked Subsystems” on page 39-24.
Parameterized links	Created when the parameter values of a linked block are modified through MATLAB command prompt. For more information, see “Parameterized Links and Self-Modifiable Linked Subsystems” on page 39-19.
Forwarding Tables	Maps old library block path to new library block path. For more information, see “Forwarding Tables” on page 39-40.
Transformation function	Corrects the mismatch of parameters in the <code>InstanceData</code> of the new and old library links thus ensuring that the library links continue to work. For more information, see “Transformation Functions” on page 39-44.

## **See Also**

`find_system`

## **More About**

- “Display Library Links” on page 39-25
- “Control Linked Block Programmatically” on page 39-37
- “Custom Libraries and Linked Blocks” on page 39-2
- “Fix Unresolved Library Links” on page 39-34
- “Manage Components Using Libraries” on page 21-11

## Parameterized Links and Self-Modifiable Linked Subsystems

You can use the MATLAB command prompt to change the value of a parameter in a linked block. Such parameter changes on the linked block result in parameterized links.

Similarly, you can also modify the structure of a linked Subsystem block without changing the parent library block. Such changes can be applied using the mask initialization code and as called self-modifiable linked subsystem.

### Parameterized Links

A parameterized link is created when you change the parameter values of the child blocks of a masked subsystem linked block.

A parameterized link allows you to have a different parameter value for the linked block and the parent library block. For such library blocks, the link to the parent block is still retained.

---

**Note:** Changing the mask value of a parent library block does not create a parameterized link.

---

For example, you can use the `set_param` command to set a parameter value in the child blocks of a linked subsystem block. The `set_param` command overrides the parameter values of the child blocks of the subsystem linked block. Thus, differentiating the child block value from its parent library block and creating a parameterized link.

Consider a Subsystem library block (see Subsystem Library Block) that contains a Gain block within with its parameter value as 1.

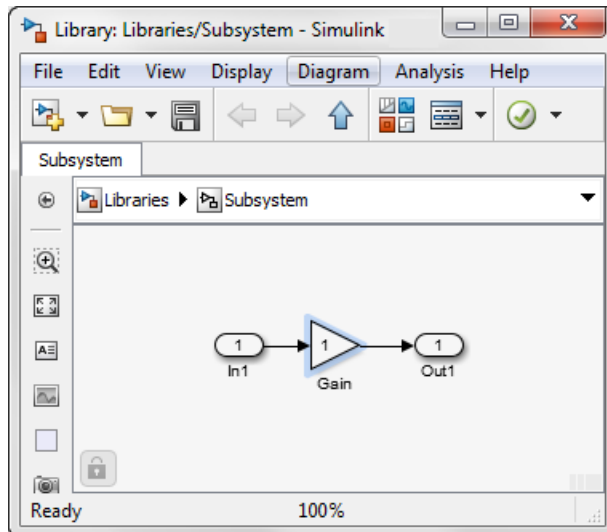

### Subsystem Library Block

Use this Subsystem block as a linked block in a model.

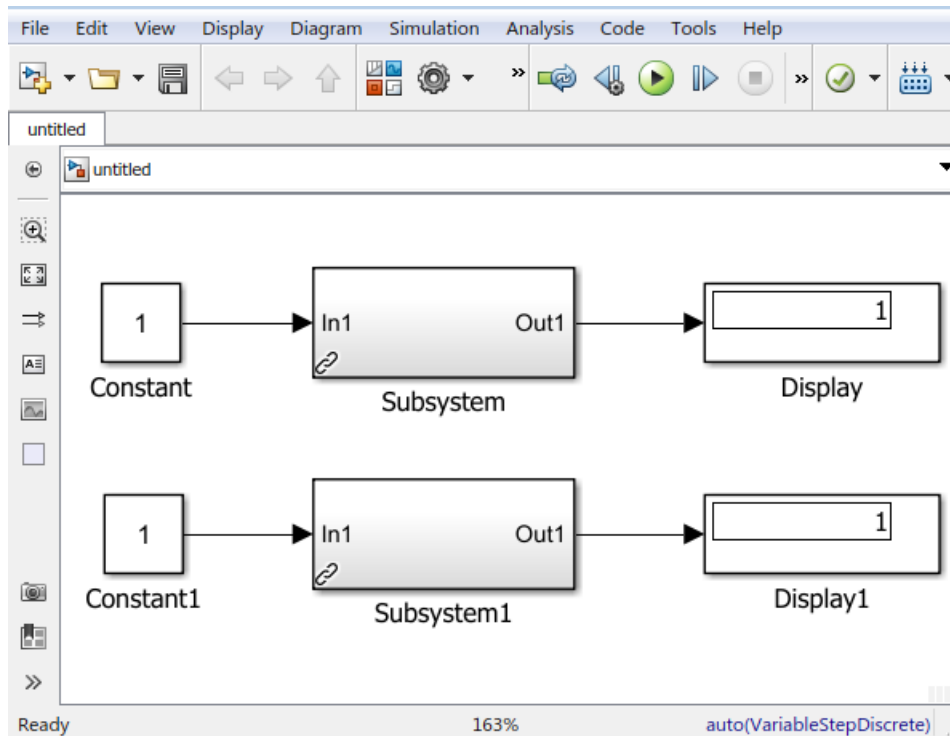

You can modify the parameter values of the child blocks of the linked block without changing the value of the parent library block. For example, you can change the parameter value of the Gain block within the **Subsystem** linked block.

To change the **Gain** parameter value of the Gain block within the **Subsystem** linked block to 100, sequentially type these commands at MATLAB command prompt:

```
pathName = [modelName, '/Gain_Subsystem1/Gain'];
set_param(pathName, 'Gain', '100')
```

A parameterized link is now created, overriding the parameter value (see, Parameterized Linked Block). Similarly, change the **Gain** parameter value of the **Subsystem1** linked block.

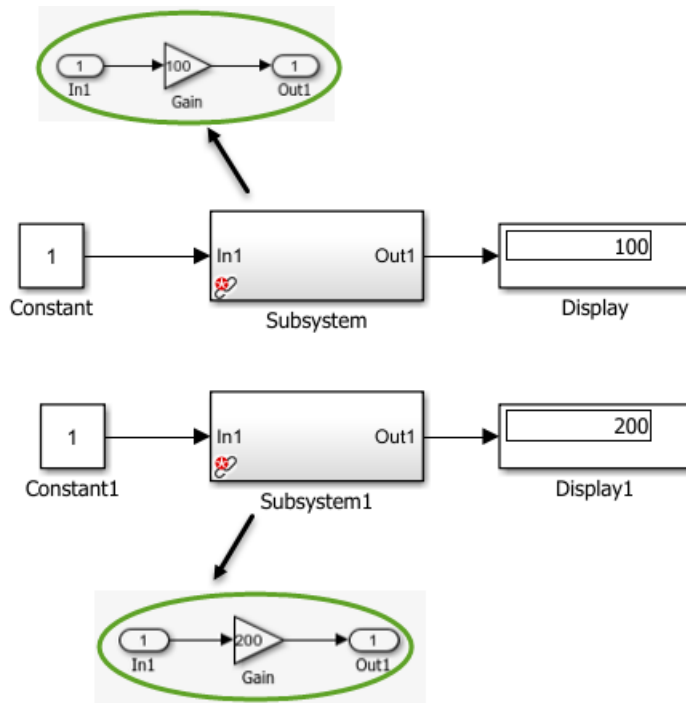

### Parameterized Linked Block

When you save a model containing a parameterized link, Simulink saves the changes to a local copy of the Subsystem with the path to the parent library. When you reopen the model, Simulink copies the library block into the loaded model and applies the saved changes.

---

**Note:** To view the parameterized changes on a block, right-click the block, and on the context menu, select **View Changes**. The **Link changes** dialog box opens displaying the list of modified blocks. You can also use this dialog box to remove parameterized changes from a block.



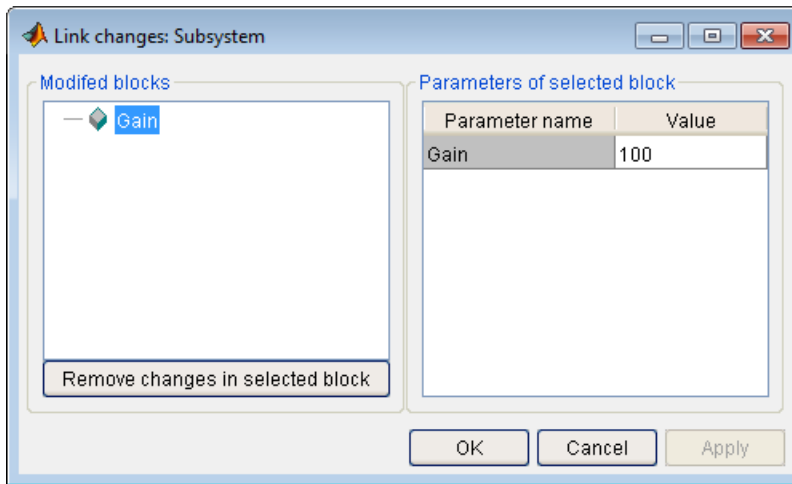

## Identifying Parameterized Links

A parameterized link displays these identifications:

- The link badge of a parameterized link contains a black link with a red star icon, . For more information, “Display Library Links” on page 39-25.
- The tooltip of a parameterized linked block displays **Modified parameter in link**.

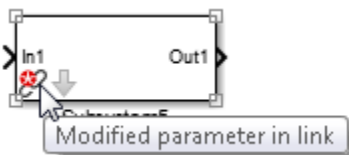

- Block dialog box of a linked Subsystem block contains **parametrized link**.

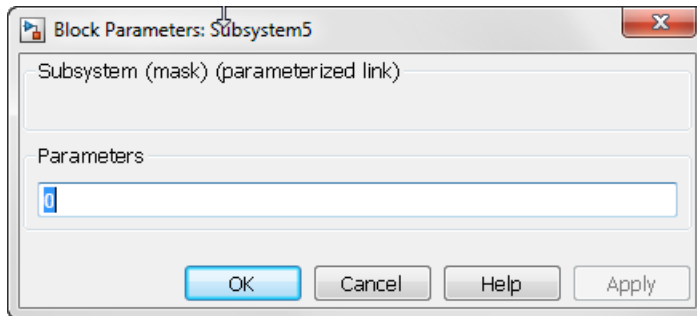

## Self-Modifiable Linked Subsystems

---

**Tip:** We recommend using variant blocks over self-modifiable linked subsystems.

---

A self-modifiable linked subsystem is a linked block with the ability to have structural changes in the subsystem without disabling the link. A self-modifiable linked subsystem is created when you use a library block containing a self-modifiable mask as a linked block. You can use the mask initialization code to change the structural contents.

For more information, see “Dynamic Masked Subsystem” on page 37-55 and Self-Modifiable Mask.

### See Also

“Linked Blocks” on page 39-15 | “Disable or Break Links to Library Blocks” on page 39-27 | “Restore Disabled or Parameterized Links” on page 39-31

## Display Library Links

Each linked block has a link badge associated with it. The badge makes it easier to identify the linked block in a model and also displays its link status.



To control the display of library link badges in a Simulink model, click **Display > Library Links** and use these options:

- **None** — displays no links.
- **Disabled** — displays only disabled links (the default for new models).
- **User Defined** — displays only links to user libraries.
- **All** — displays all links.

If activated, link badges are displayed at the bottom left corner of a linked block. You can right-click the link badge to access link menu options.



The color and icon of the link badge indicates the status of the link.

Link Badge	Status
Black links 	Active link
Gray separated links 	Inactive link
Black links with a red star icon 	Active and modified (parameterized link)

Link Badge	Status
White links, black background 	Locked link

**Note:** If you have a variant subsystem block inside a linked block, modifying the parameters on the variant subsystem creates instance data on the topmost linked block. If the link badge is visible, the presence of instance data is indicated by the red star on the link badge.

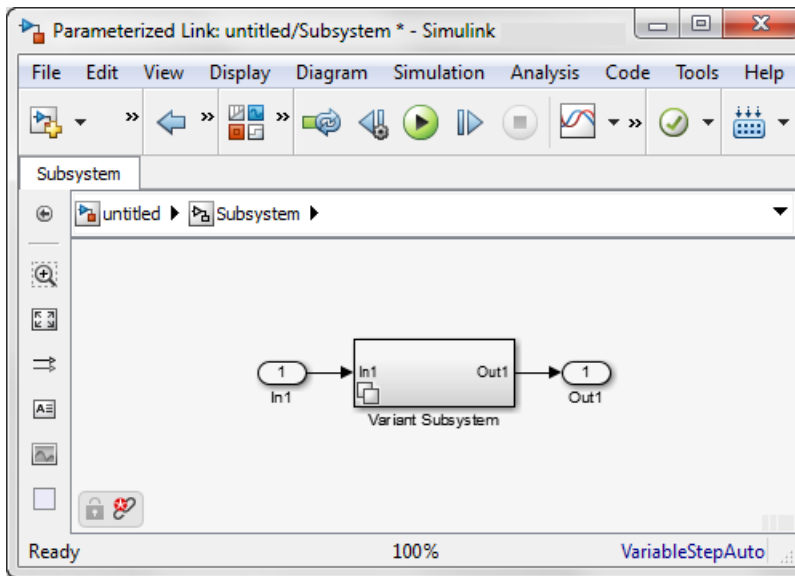

### See Also

“Linked Blocks” on page 39-15 | “Disable or Break Links to Library Blocks” on page 39-27 | “Restore Disabled or Parameterized Links” on page 39-31

## Disable or Break Links to Library Blocks

Structural changes in a model include addition or deletion of blocks or adding ports while non-structural changes include changes in parameter value.

A linked block does not allow structural changes to it. You can disable the link of a linked block from its parent library block and perform required modifications. A disabled linked block behaves like a local instance of a block and allows you to make structural and nonstructural changes.

To disable a link, right-click the linked block and, on the context menu, click **Library Link > Disable Link**. Alternatively, select the linked block and click **Diagram > Library Link > Disable Link**

To prevent unintentional disabling of a linked block, you can lock its links to the library. To lock a link, on the library window, click **Diagram > Lock Links To Library**. You can later choose to unlock the locked link by selecting **Diagram > Unlock Links To Library** on the library window.

---

**Note:** Simulink offers to disable the library links (unless the link is locked) when you try to make structural changes to a block that contains active library links.

Do not use `set_param` to make structural changes to an active link. The result of this type of change is undefined.

---

A disabled link of a linked block can be restored. For more information, see “Restore Disabled or Parameterized Links” on page 39-31.

### Break Links

You can permanently break links to the parent library. Before you break a library link, the link must first be disabled. When you break a link, the linked block is converted to a standalone block.

To break a link, use any of these options:

- For disabled links, right-click the linked block and, in the context menu, select **Library Link > Break Link**.

- To copy and break links to multiple blocks simultaneously, select multiple blocks and then drag. The locked links are ignored and not broken.
- When you save the model, you can break links by supplying arguments to the `save_system` command. For more information, see `save_system`.

---

**Note:**

- Some models can contain blocks from third-party libraries or optional Simulink block sets. Breaking the link for such models does not guarantee that you can run the model standalone. It is possible that a library block invokes functions supplied with the library and hence can run only if the library is installed on the system running the model.
  - Breaking a link can cause a model to fail when you install a new version of the library on a system. For example, if a model block invokes a function that is supplied from a library. If you break the link for such a block, the function can no longer be invoked from the model, causing simulation to fail. To avoid such problems, avoid breaking links to libraries.
- 

**See Also**

“Linked Blocks” on page 39-15 | “Restore Disabled or Parameterized Links” on page 39-31

## Lock Links to Blocks in a Library

You can lock links to a library. Lockable library links prevent unintentional disabling of these links. Lockable libraries ensure robust usage of mature stable libraries.

To lock links to a library, in the library window, click **Diagram > Lock Links To Library**. The linked block links to its parent library is now locked. When you refresh the Model Explorer, you see a change in the link badge. The locked link badges have a black background.



Locked linked block links cannot be disabled from the parent library block. Such links can only be disabled from the command line by changing the `LinkStatus` to `inactive`. For more information, see “Control Linked Block Programmatically” on page 39-37.

The context menu of a locked linked block displays **Locked Library Link** and not **Library Link**. Also notice that the only enabled option on this menu is **Go To Library Block**.

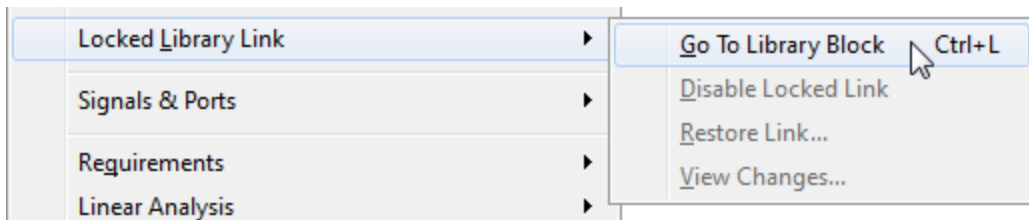

If you open a locked linked block, the window title displays **Locked Link: *blockname***. The bottom left corner shows a lock icon and a link badge.



To unlock links from the library window, select **Diagram > Unlock Links To Library**.

## Rules for Locked Links

- Locked links cannot be edited. If you try to make a structural change to a locked link (such as editing the diagram), you see a message that you cannot modify the link because it is either locked or inside another locked link.
- The mask and block parameter dialogs are disabled for blocks inside locked links. For a resolved linked block with a mask, its parameter dialog is always disabled.
- You cannot parameterize locked links in the Model Editor.
- When you copy a block, the library status determines the status of a link (locked or not). If you copy a block from a library with locked links, the link is locked. If you later unlock the library links, any existing linked blocks do not change to unlocked links until you refresh the links.
- If you use sublibraries, when you lock links to a library, lock links to the sublibraries.

## See Also

“Linked Blocks” on page 39-15 | “Restore Disabled or Parameterized Links” on page 39-31



## Restore Disabled or Parameterized Links

You can restore disabled library links and resolve any differences between the linked block and its parent library block.

- 1 In the Model Editor window, right-click a disabled linked block, and on the context menu, select **Library Link > Resolve Link**.

The Links Tool window opens.

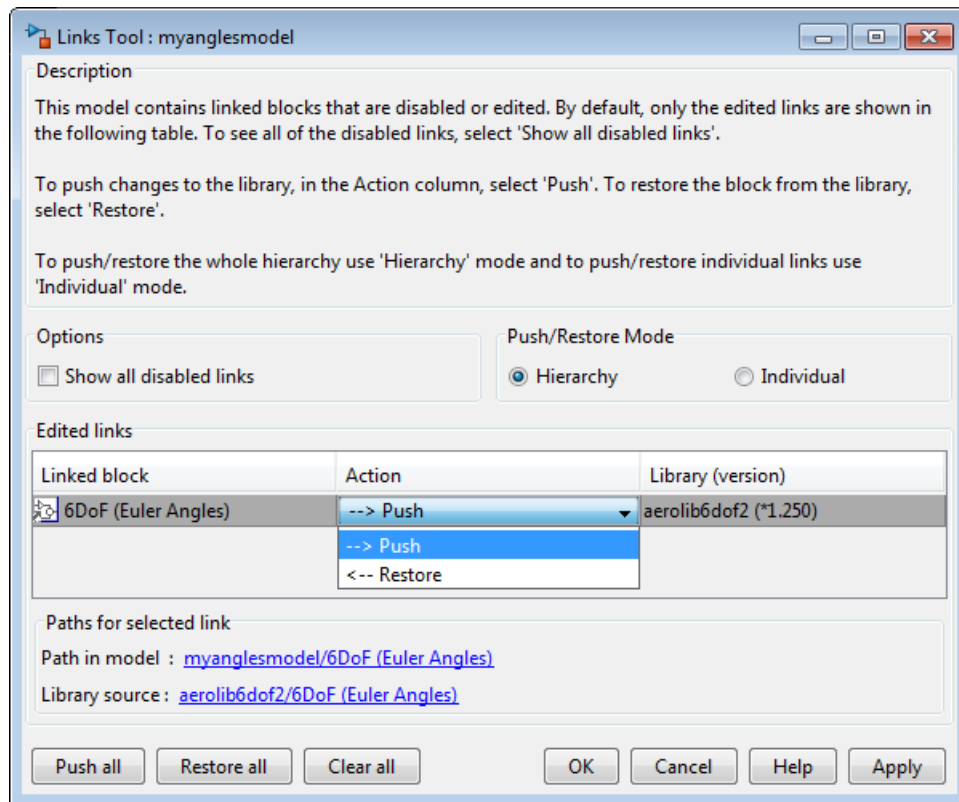

- 2 To view disabled links and the parameterized links, select **Show all disabled links** in the **Options** section.

- 3 To restore the links for an individual block or the whole hierarchy, select **Individual** or **Hierarchy** in the **Push/Restore Mode** section. For more information, see “Pushing or Restoring Link Hierarchies” on page 39-33.
- 4 The **Edited links** table has these columns:
  - **Linked block** — Displays the list of linked blocks that have disabled or parameterized links. Select a block to restore its links.
  - **Action** — Allows you to either push the linked block changes to the library or restore the linked block from the library.

Action Choice	Links Tool Action
Push	Replaces the version of the block in the library with the version in the model (linked block).
Restore	Replaces the version of the linked block in the model with the version in the library.
Push Individual	In the <b>Individual</b> mode, the disabled or edited block is pushed to the library, preserving the changes inside it without acting on the hierarchy. All other links are unaffected.
Restore Individual	In the <b>Individual</b> mode, the disabled or edited block is restored from the library, and all other links are unaffected.

To select the same action for all linked blocks, click **Push all**, **Restore all**, or **Clear all**.

- **Library** — Displays the library name and version number.
- 5 Click **OK** or **Apply** to complete the push or restore action. The version in the library and the linked block now match.

---

**Note:** Changes that you push to the library are not saved until you actively save the library.

---

If a linked block name has a cautionary icon , the model has other instances of this block linked from the same library block, and they have different changes. Choose one of the instances to push changes to the library block and restore links to the other blocks, or choose to restore all them with the library version.

## Pushing or Restoring Link Hierarchies

---

**Caution:** If you are using Push or Restore in the Hierarchy mode and you have a large hierarchy of edited and disabled links, ensure that you want to push or restore the whole hierarchy of links.

---

Pushing a hierarchy of disabled links affects the disabled links inside and outside the hierarchy for a given link. If you push changes from a disabled link in the middle of a hierarchy, the inside links are pushed and the outside links are restored if unchanged. This operation does not affect outer (parent) links with changes unless you also explicitly selected them for push. The Links Tool starts to push from the lowest inside links and then moves up in the hierarchy.

For examples:

- 1 Link A contains link B and both have changes.
  - Push A. The Links Tool pushes both A and B.
  - Push B. The Links Tool pushes B and not A.
- 2 Link A contains link B. A has no changes, and B has changes.
  - Push B. The Links Tool pushes B and restores A. When parent links are unmodified, they are restored.

If you have a hierarchy of parameterized links, the Links Tool can manipulate only the top level.

---

**Tip:** To compare files and view structural changes, use **Analysis > Compare Simulink XML Files**.

---

### See Also

“Linked Blocks” on page 39-15 | “Display Library Links” on page 39-25

## Fix Unresolved Library Links

If Simulink is unable to find either the library block or the source library on your MATLAB path during linked block update, the link becomes unresolved. Simulink changes the appearance of these blocks.

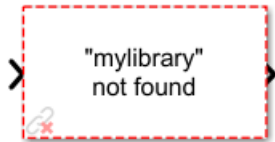

Simulink tries to help you find and install missing products that a model needs to run. If you open a model that contains built-in blocks or library links from missing products, you see labels and links to help you fix the problem.

- Blocks are labeled with missing products (for example, **SimEvents not installed**)
- Tooltips include the name of the missing product
- Messages provide links to open Add-On Explorer and install the missing products

For unresolved library links, double-click the block to view details. Click the link to open Add-On Explorer and install the product.

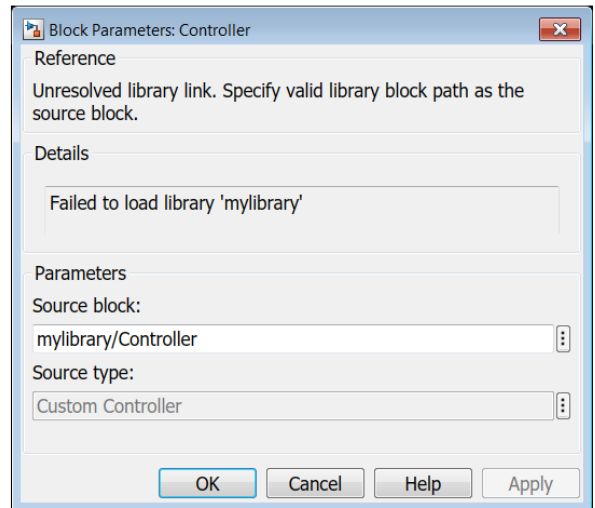
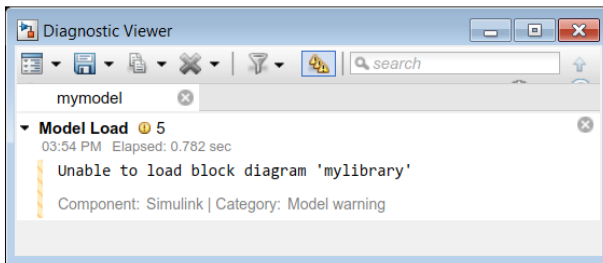
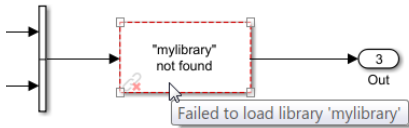
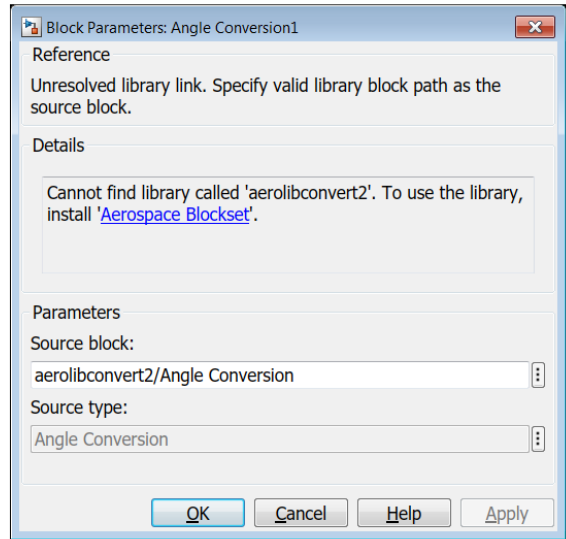
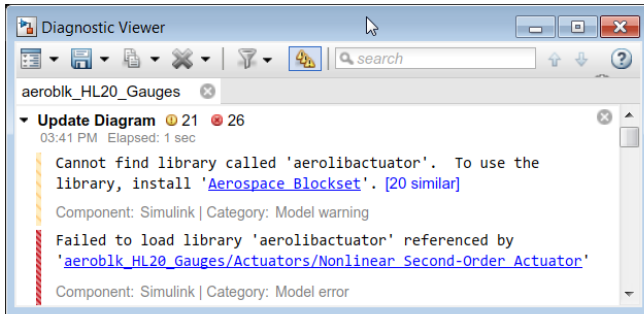
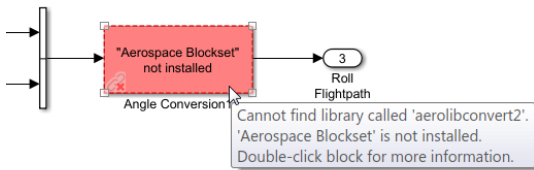

To fix an unresolved link, you can:

- Double-click the unresolved block to open its dialog box (see the Unresolved Link block reference page). If a product is missing, click the link to open Add-On Explorer

and install the product. Alternatively, correct the path name in the **Source block** field and click **OK**.

- Delete the unresolved block and copy the library block back into your model.
- Add the folder that contains the required library to the MATLAB path and select either **Simulation > Update Diagram** or **Diagram > Refresh Blocks**.

### **See Also**

“Linked Blocks” on page 39-15 | “Display Library Links” on page 39-25 | Unresolved Link

# Control Linked Block Programmatically

## Linked Block Information

Use the `libinfo` command to get information about the linked blocks in the model. `libinfo` also provides information about the parent library blocks of a linked block.

An example is as follows:

```
Block: 'tempModel/Subsystem1'%Linked block
      Library: 'temp'%Parent library block
ReferenceBlock: 'temp/Subsystem1'
LinkStatus: 'resolved' %Link status
```

The `ReferenceBlock` property gives the path of the library block to which a block links.

## Lock Linked Blocks

Use the `LockLinksToLibrary` command to lock or unlock a linked block in a library from the command line. When you set the value of `LockLinksToLibrary` to `on`, the linked block links to the library are locked.

```
set_param('MyModelName', 'LockLinksToLibrary', 'on') %Lock links
set_param('MyModelName', 'LockLinksToLibrary', 'off') %Unlock links
```

## Link Status

All blocks have a `LinkStatus` parameter and a `StaticLinkStatus` parameter that indicate whether the block is a linked block.

Use `get_param(gcb, 'StaticLinkStatus')` to query the link status without updating the linked blocks. You can use `StaticLinkStatus` to query the status of a linked block that either active or outdated.

Use `get_param` and `set_param` to query and set the `LinkStatus`, which can have these values.

Get LinkStatus Value	Description
none	Block is not a linked block.
resolved	Resolved link.

Get LinkStatus Value	Description
unresolved	Unresolved link.
implicit	Block resides in library block and is itself not a link to a library block. Suppose that A is a link to a subsystem in a library that contains the Gain block. If you open A and select the Gain block, <code>get_param(gcb, 'LinkStatus')</code> returns <code>implicit</code> .
inactive	Disabled link.

Set LinkStatus Value	Description
none	Breaks link. Use <code>none</code> to break a link, for example, <code>set_param(gcb, 'LinkStatus', 'none')</code> .
<code>breakWithoutHierarchy</code>	Breaks links in-place without breaking the nested parent hierarchy of link. For example, <code>set_param(gcb, 'LinkStatus', 'breakWithoutHierarchy')</code> .
inactive	Disables link. Use <code>inactive</code> to disable a link, for example, <code>set_param(gcb, 'LinkStatus', 'inactive')</code> .
restore	Restores an inactive or disabled link to a library block and discards any changes made to the local copy of the library block. For example, <code>set_param(gcb, 'LinkStatus', 'restore')</code> replaces the selected block with a link to a library block of the same type. It discards any changes in the local copy of the library block.  <code>restore</code> is equivalent to <b>Restore Individual</b> in the Links Tool.
propagate	Pushes any changes made to the disabled link to the library block and re-establishes its link. <code>propagate</code> is equivalent to <b>Push Individual</b> in the Links Tool.
restoreHierarchy	Restores all disabled links in the hierarchy with their corresponding library blocks. <code>restoreHierarchy</code> is equivalent to <b>Restore</b> in hierarchy mode in the Links Tool.
propagateHierarchy	Pushes all links with changes in the hierarchy to their libraries. <code>propagateHierarchy</code> is equivalent to <b>Push</b> in the <b>Hierarchy</b> mode of the Links Tool. See “Restore Disabled or Parameterized Links” on page 39-31.



---

**Note:**

- When you use `get_param` to query the link status of a block, the outdated block links also resolve.
  - Using the `StaticLinkStatus` command to query the link status when `get_param` is being used in the callback code of a child block is efficient. `StaticLinkStatus` command does not resolve any outdated links.
- 

If you call `get_param` on a block inside a library link, Simulink resolves the link wherever necessary. Executing `get_param` can involve loading part of the library and executing callbacks.

**See Also**

“Linked Blocks” on page 39-15 | “Display Library Links” on page 39-25

## Forwarding Tables

If you edit an existing library block, you would want to ensure that the changes do not break the model when the model is saved with an older version of the library block. The type of edits in the library block can include, library path change, library block name change, or addition, removal, or rename of parameters.

The Forwarding Table helps you to maintain compatibility of library blocks and thus ensures that the models continue to work. You can use the Forwarding table to create a map between the old and the new library blocks without any loss of data or functionality. After the mapping of old library blocks to new library blocks is specified in the forwarding table, links to the old library blocks update automatically during model load. For example, if you rename or move a block in a library, you can use a forwarding table to update the models that have link to the old library block.

### Create Forwarding Table

---

**Note:** Models that have broken or disabled links cannot be updated using the forwarding tables.

---

- 1 Open the library model.
- 2 Click **Diagram > Unlock Library**. The library is now unlocked for editing.
- 3 Click **File > Library Properties > Library Properties**. The **Library Properties** dialog box opens.
- 4 Click the **Forwarding Table** tab.
- 5 Click  (Add New Entry) button. A new row is added in the Forwarding Table.

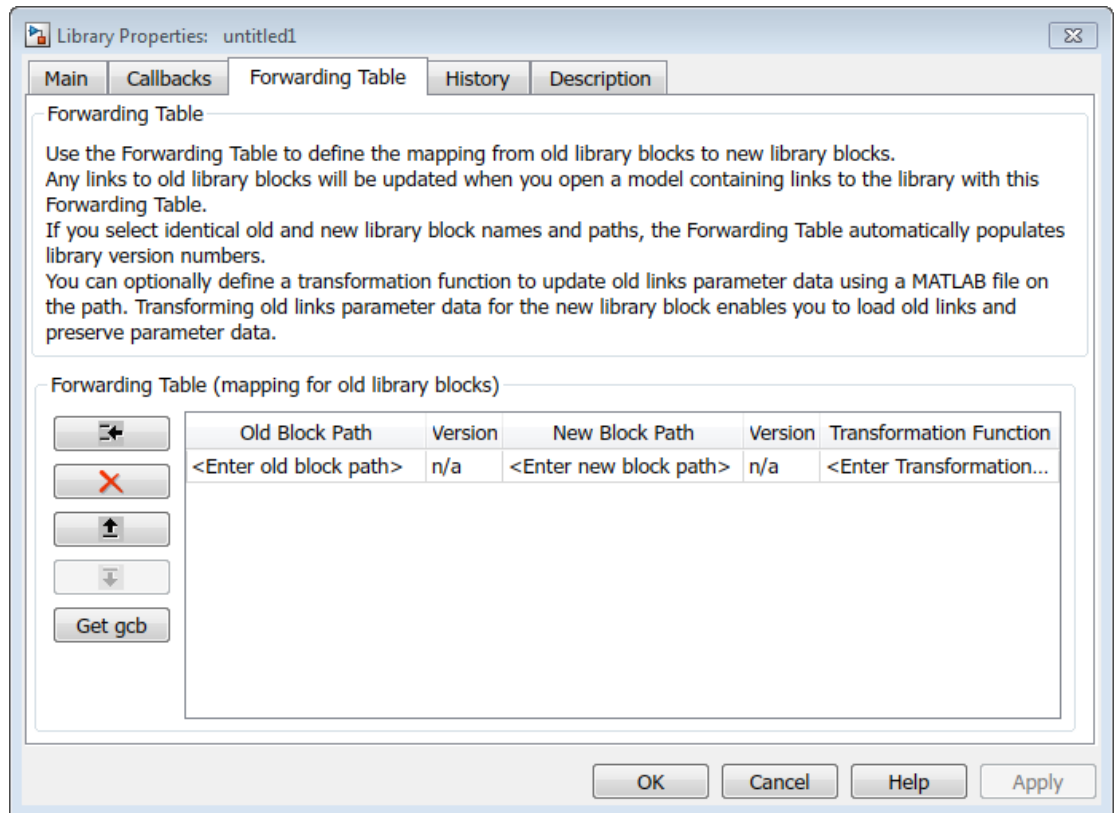

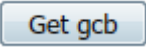
- 6 Specify values in the **Old Block Path** and **New Block Path** columns. To get the path of a block, select the block in the model and click .
- 7 In the **Version** column, you can choose to specify a version number for the library block.

If the old block name and the new block name are the same, the forwarding table populates the version number automatically. The initial value of the library version (`LibraryVersion`) is derived from the model version (`ModelVersion`) of the library at the time the library link is created. Any subsequent updated to the library block would update the library version to match the model version of the library.

---

**Note:**

- Version number must be a numeric value.
  - When the old and the new block paths are the same, the version number must be of the format <major\_version>.<minor\_version>. For example, while renaming a library block.
  - The version number cannot have more than one dot notation. For example, a version number of 1.3 is acceptable whereas, version number 1.3.1 is not acceptable.
  - When you use forwarding table to move a library block from one library to another, the version number format is not critical.
- 

- 8** In the **Transformation Function** column, you can specify a MATLAB file that corrects the mismatch of parameter data between the old and the new link. Transforming old link parameter data for the new library block enables you to load old links and preserve parameter data. For more information, see “Transformation Functions” on page 39-44.

If no transformation function is specified, the Transformation Function column displays **No Transformation** when you save the library.

- 9** To apply the changes and close the dialog box, click **OK**. The mapping of old path to new path is created in the Forwarding Table. The links to the old library blocks are updated automatically when you open a model containing links to the library.

An example of user-defined forwarding table is as shown:

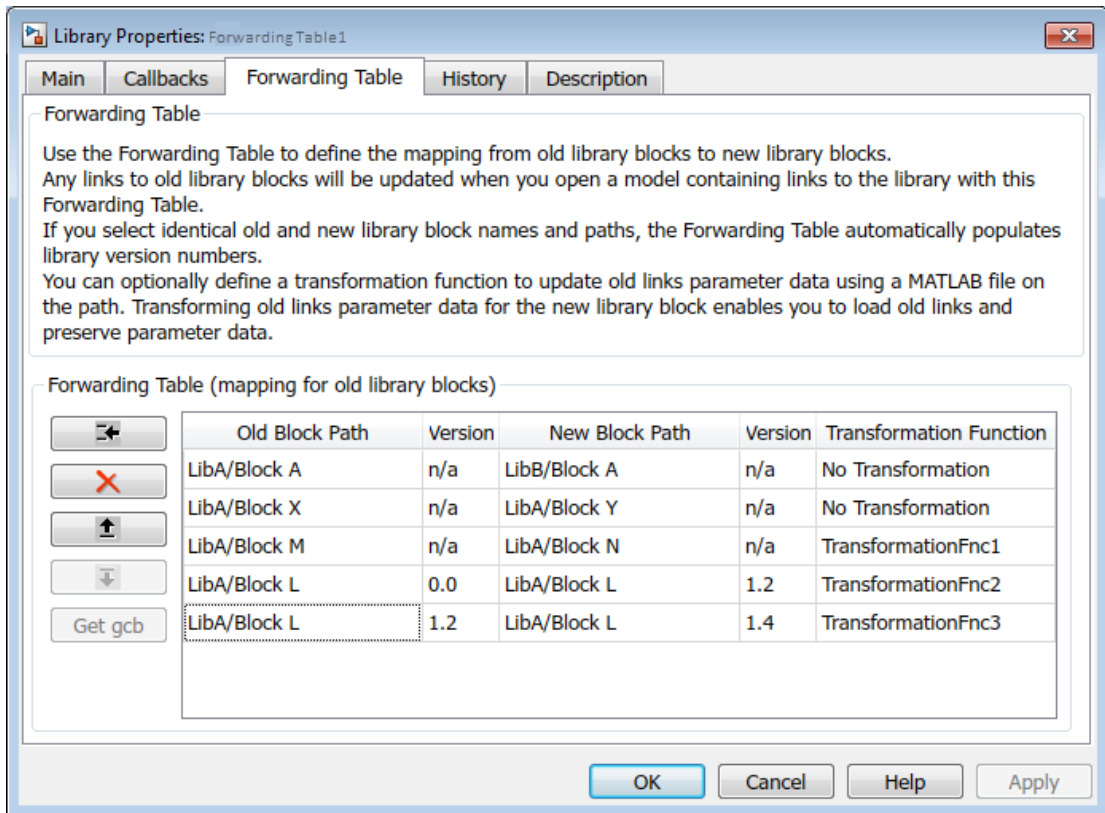

When you specify identical library block name and path for the older and the newer blocks, the Forwarding Table populates the version number automatically. For the first entry with identical names and path, the version number of the old block starts with 0, and the new version of the block is set as the model version of the library. You can view the model version of the library under the **History** tab of the Forwarding Table.

A transformation function must be specified when the instance-specific parameters (**InstanceData**) have changed in the old and the new library block.

In this example,

- Block path for **Block A** changes from **LibA** to **LibB**.
- Block name for **Block X** changes to **Block Y** while the library path remains the same.

- Block name for **Block M** changed to **Block N**. A transformation function is specified to take care of the instance-specific changes.
- Block version and instance-specific parameter changed for **Block L**.

### Create Forwarding Table Programmatically

At the command line, you can create a simple forwarding table specifying the old locations and new locations of blocks that have moved within the library or to another library. You associate a forwarding table with a library by setting its `ForwardingTable` parameter to a cell array of two-element cell arrays, each of which specifies the old and new path of a block that has moved. For example, the syntax to create a forwarding table and assign it to a library named `Lib1` is,

```
set_param('Lib1', 'ForwardingTable', {{'Lib1/A', 'Lib2/A'}  
{'Lib1/B', 'Lib1/C'}});
```

Here,

- `Lib1` is the library associated to the forwarding table.
- Block A is transferred from `Lib1` to `Lib2`.
- Block B is renamed to Block C in the same library.

### Transformation Functions

A linked block instance is associated with instance-specific parameters called `InstanceData`. When you create versions of a library block, parameter sets can get added or removed from the `InstanceData`.

A transformation function corrects the mismatch of parameters in the `InstanceData` of the new and old library links thus ensuring that the library links continue to work.

You can define a transformation function using a MATLAB file on the path, then specify the function in the **Transformation Function** column of the **Forwarding Table**.

The new block path defined in the forwarding table overrides the values defined in the transformation function. If the new block path is a dynamic value that changes based on certain conditions, then the new block path must be only defined using the transformation function.

The syntax for transformation function must be;

```
function outData = TransformationFcn(inData)
```

Here,

- `inData` is a structure with fields `ForwardingTableEntry` and `InstanceData`, and `ForwardingTableEntry` is also a structure.
- `outData` is a structure with fields `NewInstanceData` and `NewBlockPath`.

A general transformation function can have many local functions defined in it. The function calls the appropriate local functions based on old block names and versions. You can use this to combine multiple local functions into a single transformation function, to avoid having many transformation functions on the MATLAB path.

Consider the Compare to Const block in Simulink Library. Versions of this block are created without changing the name and the block path but parameters are added to the newer library block.

The table displays the parameter difference in two versions of the Compare to Const block. The instance data in each version has been highlighted.

Old Version	New Version
<pre>Block { BlockType      Reference Name           "Compare\nTo Constant" Ports          [1, 1] Position       [210, 60, 250, 100] SourceBlock    "fixpt_lib_4/Logic &amp; Com SourceType     "Fixed-Point Compare To relop          "==" const         "3.0" }</pre>	<pre>Block { BlockType      Reference Name           "Compare\nTo Constant" SID            "15" Ports          [1, 1] Position       [125, 50, 155, 80] ZOrder        -5 LibraryVersion "1.271" SourceBlock    "simulink/Logic and Bit\nOpen SourceType     "Compare To Constant" relop          "&lt;=" const         "3.0" OutDataTypeStr "boolean" ZeroCross     on }</pre>

The New Version of the Compare to Const block has additional parameters (`OutDataTypeStr` and `ZeroCross`) associated with it. For such cases, the

transformation function must ensure that the additional parameters in the `InstanceData` are set so that the old library links work.

An example of transformation function for the Compare to Const block to add the `OutDataTypeStr` parameter with a value of `uint8` is as follows,

```
function [outData] = TransformationCompConstBlk(inData)
outData.NewBlockPath = ''; % No change in the library block path
outData.NewInstanceData = [];
instanceData = inData.InstanceData;
% Get the field type 'Name' from instanceData
[ParameterNames{1:length(instanceData)}] = instanceData.Name;

if (~ismember('OutDataTypeStr',ParameterNames))
    % OutDataTypeStr parameter is not present in old link. Add it and set value uint8
    instanceData(end+1).Name = 'OutDataTypeStr';
    instanceData(end).Value = 'uint8';
end

outData.NewInstanceData = instanceData;
```

## Create Mask Parameter Aliases

If a mask parameter is renamed, you must ensure that the existing MATLAB scripts that use the old parameter names, continues to work. To ensure the compatibility, you can create alias (alternate names) for a mask parameter name. Alias allows you to change the name of a mask parameter in a library block without having to recreate links to the block in existing models.

Consider a masked block that contains an **Edit** parameter. The mask parameter name for this **Edit** parameter is `p1`.

```
MaskObj=
% MaskParameter with properties:
```

```
    Type: 'edit'
TypeOptions: {0x1 cell}
    Name: 'p1'
    Prompt: 'p1'
    Value: '0'
    Evaluate: 'on'
    Tunable: 'on'
    NeverSave: 'off'
    Hidden: 'off'
    Enabled: 'on'
    Visible: 'on'
    ToolTip: 'on'
```



```
Callback: ''  
Alias: ''
```

Notice that the **Edit** mask parameter does not have any alias name. To add an alias name for the mask parameter, you can set a value for the **Alias** mask parameter property.

```
MaskObj.Alias = 'pa'
```

You can either use the mask parameter name or the alias to do a function call on the mask parameter. For example, in this case you can either use `set_param(gcb, 'p1, '10)` (mask parameter name) `set_param(gcb, 'pa, '10)` (mask parameter alias) to set a value for the **Edit** mask parameter.

## More About

- “Linked Blocks” on page 39-15



# Using the MATLAB Function Block

---

- “Integrate MATLAB Algorithm in Model” on page 40-3
- “What Is a MATLAB Function Block?” on page 40-5
- “Why Use MATLAB Function Blocks?” on page 40-7
- “Use Nondirect Feedthrough in a MATLAB Function Block” on page 40-8
- “Create Model That Uses MATLAB Function Block” on page 40-9
- “Code Generation Readiness Tool” on page 40-15
- “Check Code Using the Code Generation Readiness Tool” on page 40-21
- “Debugging a MATLAB Function Block” on page 40-22
- “Prevent Algebraic Loop Errors in MATLAB Function and Stateflow Blocks” on page 40-32
- “MATLAB Function Block Editor” on page 40-34
- “MATLAB Function Reports” on page 40-48
- “Type Function Arguments” on page 40-61
- “Size Function Arguments” on page 40-68
- “Units in MATLAB Function Blocks” on page 40-71
- “Add Parameter Arguments” on page 40-72
- “Resolve Signal Objects for Output Data” on page 40-73
- “Types of Structures in MATLAB Function Blocks” on page 40-75
- “Attach Bus Signals to MATLAB Function Blocks” on page 40-76
- “How Structure Inputs and Outputs Interface with Bus Signals” on page 40-78
- “Rules for Defining Structures in MATLAB Function Blocks” on page 40-79
- “Index Substructures and Fields” on page 40-80
- “Create Structures in MATLAB Function Blocks” on page 40-82
- “Assign Values to Structures and Fields” on page 40-84
- “Initialize a Matrix Using a Nontunable Structure Parameter” on page 40-86

- “Define and Use Structure Parameters” on page 40-89
- “Limitations of Structures and Buses in MATLAB Function Blocks” on page 40-91
- “Control Support for Variable-Size Arrays in a MATLAB Function Block” on page 40-92
- “Declare Variable-Size Inputs and Outputs” on page 40-93
- “Use a Variable-Size Signal in a Filtering Algorithm” on page 40-94
- “Control Memory Allocation for Variable-Size Arrays in a MATLAB Function Block” on page 40-102
- “Use Dynamic Memory Allocation for Variable-Size Arrays in a MATLAB Function Block” on page 40-104
- “Code Generation for Enumerations” on page 40-108
- “Add Enumerated Inputs, Outputs, and Parameters to a MATLAB Function Block” on page 40-112
- “Use Enumerations to Control an LED Display” on page 40-113
- “Share Data Globally” on page 40-116
- “Create Custom Block Libraries” on page 40-124
- “Use Traceability in MATLAB Function Blocks” on page 40-144
- “Include MATLAB Code as Comments in Generated Code” on page 40-148
- “Integrate C Code Using the MATLAB Function Block” on page 40-153
- “Enhance Code Readability for MATLAB Function Blocks” on page 40-157
- “Control Run-Time Checks” on page 40-165
- “Track Object Using MATLAB Code” on page 40-167
- “Filter Audio Signal Using MATLAB Code” on page 40-191
- “Encapsulating the Interface to External Code” on page 40-219
- “Encapsulate Interface to an External C Library” on page 40-220
- “Best Practices for Using `coder.ExternalDependency`” on page 40-223
- “Update Build Information from MATLAB code” on page 40-225

## Integrate MATLAB Algorithm in Model

Here is an example of a Simulink model that contains a MATLAB Function block:

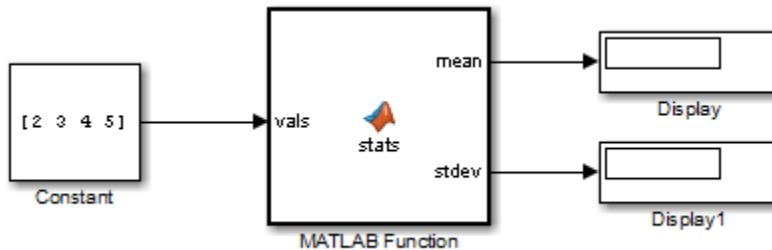

The MATLAB Function block contains the following algorithm:

```
function [mean,stdev] = stats(vals)

% calculates a statistical mean and a standard
% deviation for the values in vals.

len = length(vals);
mean = avg(vals,len);
stdev = sqrt(sum(((vals-avg(vals,len)).^2))/len);
plot(vals,'-+');

function mean = avg(array,size)
mean = sum(array)/size;
```

You build this model in “Create Model That Uses MATLAB Function Block” on page 40-9.

### Defining Local Variables for Code Generation

If you intend to generate code from the MATLAB algorithm in a MATLAB Function block, you must explicitly assign the class, size, and complexity of local variables before using them in operations or returning them as outputs (see “Data Definition for Code Generation” on page 47-2. In the example function `stats`, the local variable `len` is defined before being used to calculate mean and standard deviation:

```
len = length(vals);
```

Generally, once you assign properties to a variable, you cannot redefine its class, size, or complexity elsewhere in the function body, but there are exceptions (see “Reassignment of Variable Properties” on page 46-9).

### **Related Examples**

- “Create Model That Uses MATLAB Function Block” on page 40-9
- “Track Object Using MATLAB Code” on page 40-167

### **More About**

- “What Is a MATLAB Function Block?” on page 40-5

## What Is a MATLAB Function Block?

The MATLAB Function block allows you to add MATLAB functions to Simulink models for deployment to desktop and embedded processors. This capability is useful for coding algorithms that are better stated in the textual language of MATLAB than in the graphical language of Simulink. From the MATLAB Function block, you can generate readable, efficient, and compact C/C++ code for deployment to desktop and embedded applications.

### Calling Functions in MATLAB Function Blocks

MATLAB Function blocks can call any of the following types of functions:

- **Local functions**

Local functions are defined in the body of the MATLAB Function block.

- **MATLAB toolbox functions that support code generation**

From MATLAB Function blocks, you can call toolbox functions that support code generation. When you build your model with Simulink Coder, these functions generate C code that is optimized to meet the memory and performance requirements of desktop and embedded environments. For a list of supported functions, see “Functions and Objects Supported for C/C++ Code Generation — Alphabetical List” on page 44-2.

- **MATLAB functions that do not support code generation**

From MATLAB Function blocks, you can also call *extrinsic* functions. These are functions on the MATLAB path that the compiler dispatches to MATLAB software for execution because the target language does not support them. These functions do not generate code; they execute only in the MATLAB workspace during simulation of the model. The Simulink Coder software attempts to compile all MATLAB functions unless you explicitly declare them to be extrinsic by using `coder.extrinsic`. See “Declaring MATLAB Functions as Extrinsic Functions” on page 54-10.

The code generation software detects calls to many common visualization functions, such as `plot`, `disp`, and `figure`. For MEX code generation, it automatically calls out to MATLAB for these functions. For standalone code generation, it does not generate code for these visualization functions. This capability removes the requirement to declare these functions extrinsic using the `coder.extrinsic` function.

See “Resolution of Function Calls for Code Generation” on page 54-2.

- **Functions from Simulink Function blocks and Stateflow blocks**

From MATLAB Function blocks, you can also call functions defined in a Simulink Function block. You can call Stateflow functions with **Export Chart Level Functions (Make Global)** and **Allow exported functions to be called by Simulink** checked in the chart Properties dialog box.

### **Related Examples**

- “Create Model That Uses MATLAB Function Block” on page 40-9
- “Integrate MATLAB Algorithm in Model” on page 40-3
- “Track Object Using MATLAB Code” on page 40-167

### **More About**

- “Why Use MATLAB Function Blocks?” on page 40-7



## Why Use MATLAB Function Blocks?

MATLAB Function blocks provide the following capabilities:

- **Allow you to build MATLAB functions into embeddable applications** — MATLAB Function blocks support a subset of MATLAB toolbox functions that generate efficient C/C++ code. For information see “Functions and Objects Supported for C/C++ Code Generation — Alphabetical List” on page 44-2.. With this support, you can use Simulink Coder to generate embeddable C code from MATLAB Function blocks that implement a variety of sophisticated mathematical applications. In this way, you can build executables that harness MATLAB functionality, but run outside the MATLAB environment.
- **Inherit properties from Simulink input and output signals** — By default, both the size and type of input and output signals to a MATLAB Function block are inherited from Simulink signals. You can also choose to specify the size and type of inputs and outputs explicitly in the Ports and Data Manager (see “Ports and Data Manager” on page 40-36) or in the Model Explorer (see “Search and Edit Using Model Explorer” on page 12-2).

### Related Examples

- “Create Model That Uses MATLAB Function Block” on page 40-9
- “Integrate MATLAB Algorithm in Model” on page 40-3

### More About

- “What Is a MATLAB Function Block?” on page 40-5

## Use Nondirect Feedthrough in a MATLAB Function Block

By default, MATLAB Function blocks have direct feedthrough enabled. To disable, in the Ports and Data Manager, clear the **Allow direct feedthrough** check box. Nondirect feedthrough enables semantics to ensure that outputs rely only on current state.

To use nondirect feedthrough, do not program outputs to rely on inputs or updated persistent variables. For example, do not use the following code in a nondirect feedthrough block:

```
counter = counter + 1; % update state
output = counter;     % compute output based on updated state
```

Instead, use code such as:

```
output = counter;     % compute output based on current state
counter = counter + 1; % update state
```

Also, nondirect feedthrough semantics require function inlining. Do not disable inlining.

Using nondirect feedthrough enables you to use MATLAB Function blocks in a feedback loop and prevent algebraic loops.

### Related Examples

- “Integrate MATLAB Algorithm in Model” on page 40-3

### More About

- “MATLAB Function Block Editor” on page 40-34
- “What Is a MATLAB Function Block?” on page 40-5
- “Prevent Algebraic Loop Errors in MATLAB Function and Stateflow Blocks” on page 40-32

## Create Model That Uses MATLAB Function Block

### In this section...

“Adding a MATLAB Function Block to a Model” on page 40-9

“Programming the MATLAB Function Block” on page 40-10

“Building the Function and Checking for Errors” on page 40-11

“Defining Inputs and Outputs” on page 40-13

### Adding a MATLAB Function Block to a Model

- 1 Create a new Simulink model and add a MATLAB Function block to the model from the User-Defined Functions library:



- 2 Add the following Source and Sink blocks to the model:

- From the Sources library, add a Constant block to the left of the MATLAB Function block and set its value to the vector  $[2 \ 3 \ 4 \ 5]$ .
- From the Sinks library, add two Display blocks to the right of the MATLAB Function block.

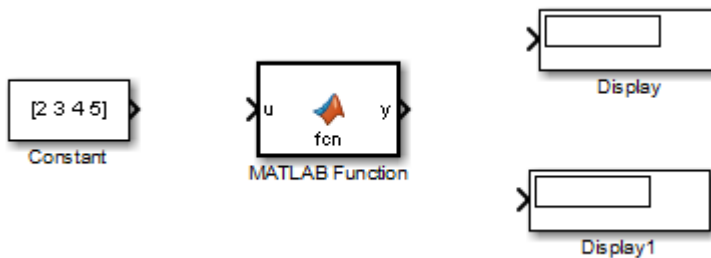

- 3 In the Simulink Editor, select **File > Save As** and save the model as `call_stats_block1`.

## Programming the MATLAB Function Block

The following exercise demonstrates programming the block to calculate the mean and standard deviation for a vector of values:

- 1 Open the `call_stats_block1` model that you saved at the end of “Adding a MATLAB Function Block to a Model” on page 40-9. Double-click the MATLAB Function block `fcn` to open it for editing.

A default function signature appears.

- 2 Edit the function header line:

```
function [mean,stdev] = stats(vals)
```

The function `stats` calculates a statistical mean and standard deviation for the values in the vector `vals`. The function header declares `vals` as an argument to the `stats` function, with `mean` and `stdev` as return values.

- 3 Save the model as `call_stats_block2`.
- 4 Complete the connections to the MATLAB Function block as shown.

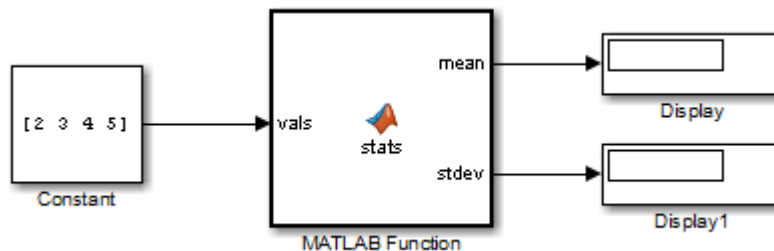

- 5 In the MATLAB Function Block Editor, enter a line space after the function header and add the following code:

```
% calculates a statistical mean and a standard
% deviation for the values in vals.

len = length(vals);
mean = avg(vals,len);
stdev = sqrt(sum(((vals-avg(vals,len)).^2))/len);
```

```
plot(vals, '-+');  
  
function mean = avg(array,size)  
mean = sum(array)/size;
```

### More about length

The function `length` is an example of a toolbox function that supports code generation. When you simulate this model, C code is generated for this function in the simulation application.

### More about len

The class, size, and complexity of local variable `len` matches the output of the toolbox function `length`, which returns a real scalar of type `double`.

By default, implicitly declared local variables like `len` are temporary. They come into existence only when the function is called and cease to exist when the function is exited. To make implicitly declared variables persist between function calls, see `persistent`.

### More about plot

The function `plot` is not supported for code generation. The code generation software detects calls to many common visualization functions, such as `plot`, `disp`, and `figure`. For MEX code generation, it automatically calls out to MATLAB for these functions. For standalone code generation, it does not generate code for these visualization functions.

- 6 Save the model as `call_stats_block2`.

## Building the Function and Checking for Errors

After programming a MATLAB Function block in a Simulink model, you can build the function and test for errors. This section describes the steps:

- 1 Set up your compiler.
- 2 Build the function.
- 3 Locate and fix errors.

## Setting Up Your Compiler

Building your MATLAB Function block requires a supported compiler. MATLAB automatically selects one as the default compiler. If you have multiple MATLAB-supported compilers installed on your system, you can change the default using the `mex -setup` command. See “Change Default Compiler” (MATLAB).

### Supported Compilers for Simulation Builds

To view a list of compilers for building models containing MATLAB Function blocks for simulation:

- 1 Navigate to the Supported and Compatible Compilers Web page.
- 2 Select your platform.
- 3 In the table for Simulink and related products, find the compilers checked in the column titled Simulink for MATLAB Function blocks.

### Supported Compilers for Code Generation

To generate code for models that contain MATLAB Function blocks, you can use any of the C compilers supported by Simulink software for code generation with Simulink Coder. For a list of these compilers:

- 1 Navigate to the Supported and Compatible Compilers Web page.
- 2 Select your platform.
- 3 In the table for Simulink and related products, find the compilers checked in the column titled Simulink Coder.

### How to Generate Code for the MATLAB Function Block

- 1 Open the `call_stats_block2` model that you saved at the end of “Programming the MATLAB Function Block” on page 40-10.
- 2 Double-click its MATLAB Function block `stats` to open it for editing.
- 3 In the MATLAB Function Block Editor, select **Build Model** > **Build** to compile and build the example model.

If no errors occur, the **Simulation Diagnostics** window displays a message indicating success. Otherwise, this window helps you locate errors, as described in “How to Locate and Fix Errors” on page 40-13.

## How to Locate and Fix Errors

If errors occur during the build process, the **Simulation Diagnostics** window lists the errors with links to the offending code.

The following exercise shows how to locate and fix an error in a MATLAB Function block.

- 1 In the `stats` function, change the local function `avg` to a fictitious local function `aug` and then compile again to see the following messages in window:

The **Simulation Diagnostics** window displays each detected error with a red button.

- 2 Click the first error line to display its diagnostic message in the bottom error window.

The message also links to a report about compile-time type information for variables and expressions in your MATLAB functions. This information helps you diagnose error messages and understand type propagation rules. For more information about the report, see “MATLAB Function Reports” on page 40-48.

- 3 In the diagnostic message for the selected error, click the blue link after the function name to display the offending code.

The offending line appears highlighted in the MATLAB Function Block Editor:

- 4 Correct the error by changing `aug` back to `avg` and recompile.

## Defining Inputs and Outputs

In the `stats` function header for the MATLAB Function block you defined in “Programming the MATLAB Function Block” on page 40-10, the function argument `vals` is an input, and `mean` and `stdev` are outputs. By default, function inputs and outputs inherit their data type and size from the signals attached to their ports. In this topic, you examine input and output data for the MATLAB Function block to verify that it inherits the correct type and size.

- 1 Open the `call_stats_block2` model that you saved at the end of “Programming the MATLAB Function Block” on page 40-10. Double-click the MATLAB Function block `stats` to open it for editing.
- 2 In the MATLAB Function Block Editor, select **Edit Data**.

The Ports and Data Manager opens to help you define arguments for MATLAB Function blocks.

The left pane displays the argument `vals` and the return values `mean` and `stdev` that you have already created for the MATLAB Function block. Notice that `vals` is assigned a **Scope** of **Input**, which is short for **Input from Simulink**. `mean` and `stdev` are assigned the **Scope** of **Output**, which is short for **Output to Simulink**.

- 3 In the left pane of the Ports and Data Manager, click anywhere in the row for `vals` to highlight it.

The right pane displays the **Data** properties dialog box for `vals`. By default, the class, size, units, and complexity of input and output arguments are inherited from the signals attached to each input or output port. Inheritance is specified by setting **Size** to `-1`, **Complexity** to **Inherited**, and **Type** to **Inherit: Same as Simulink**.

The actual inherited values for size and type are set during compilation of the model, and are reported in the **Compiled Type** and **Compiled Size** columns of the left pane.

You can specify the type of an input or output argument by selecting a type in the **Type** field of the **Data** properties dialog box, for example, `double`. You can also specify the size of an input or output argument by entering an expression in the **Size** field. For example, you can enter `[2 3]` in the **Size** field to specify `vals` as a 2-by-3 matrix. See “Type Function Arguments” on page 40-61 and “Size Function Arguments” on page 40-68 for more information on the expressions that you can enter for type and size.

---

**Note:** The default first index for any arrays that you add to a MATLAB Function block function is 1, just as it would be in MATLAB.

---

## Related Examples

- “Integrate MATLAB Algorithm in Model” on page 40-3

## More About

- “Ports and Data Manager” on page 40-36
- “What Is a MATLAB Function Block?” on page 40-5



## Code Generation Readiness Tool

The code generation readiness tool screens MATLAB code for features and functions that code generation does not support. The tool provides a report that lists the source files that contain unsupported features and functions. The report also indicates the amount of work required to make the MATLAB code suitable for code generation. It is possible that the tool does not detect all code generation issues. Under certain circumstances, it is possible that the tool can report false errors. Therefore, before you generate C code, verify that your code is suitable for code generation by generating a MEX function.

## Summary Tab

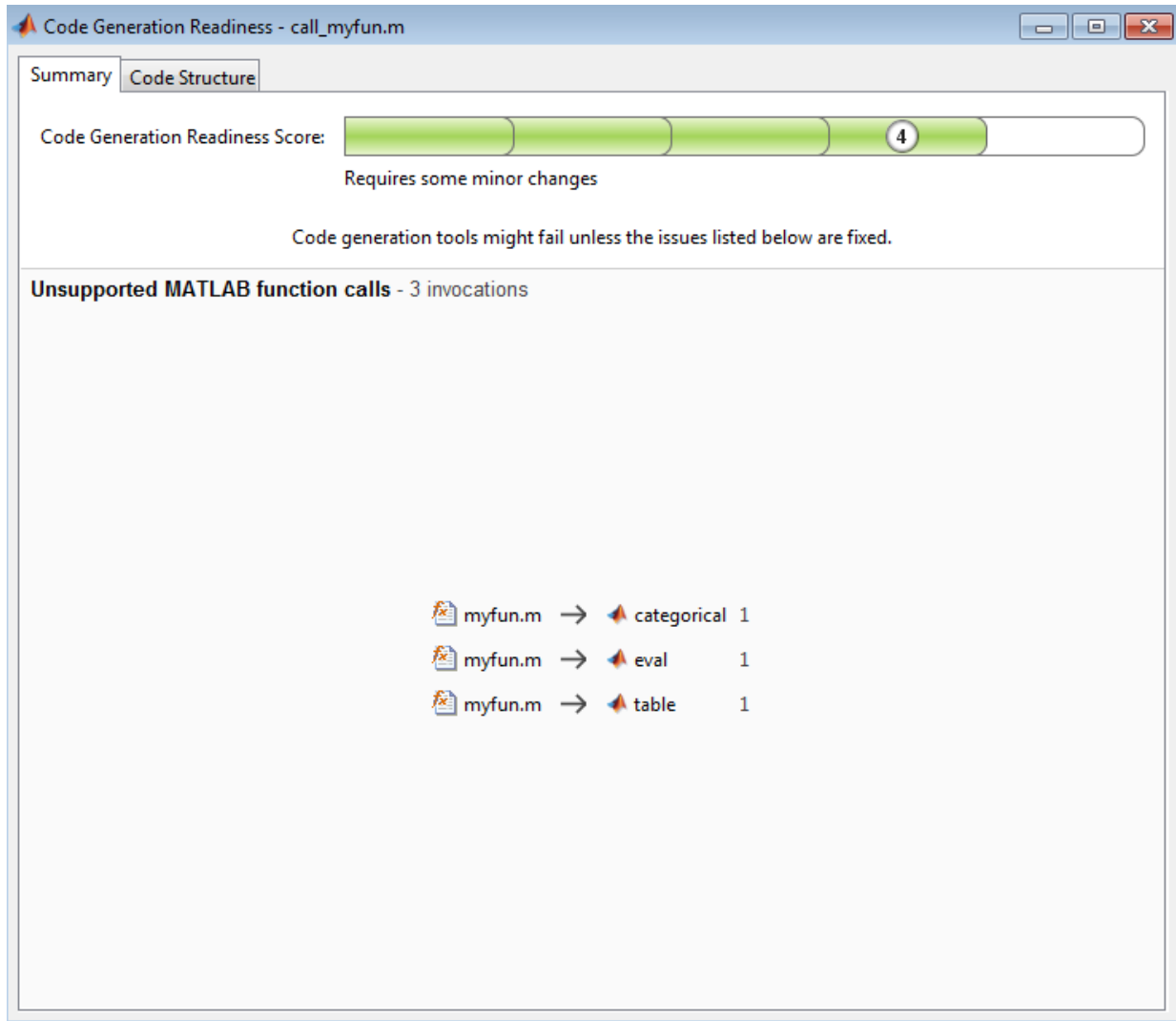

The **Summary** tab provides a **Code Generation Readiness Score**, which ranges from 1 to 5. A score of 1 indicates that the tool detects issues that require extensive changes to the MATLAB code to make it suitable for code generation. A score of 5 indicates that

the tool does not detect code generation issues; the code is ready to use with minimal or no changes.

On this tab, the tool also displays information about:

- MATLAB syntax issues. These issues are reported in the MATLAB editor. To learn more about the issues and how to fix them, use the Code Analyzer.
- Unsupported MATLAB function calls.
- Unsupported MATLAB language features.
- Unsupported data types.

## Code Structure Tab

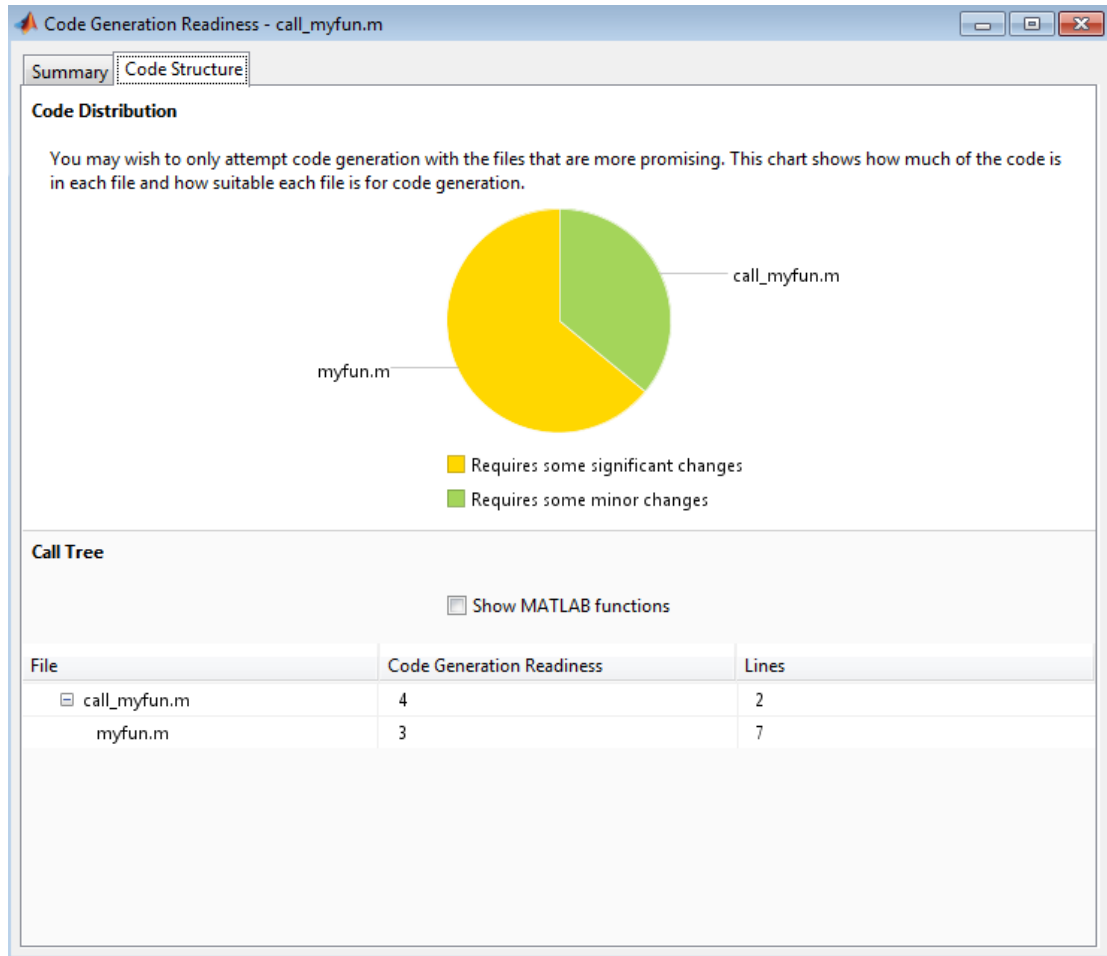

If the code that you are checking calls other MATLAB functions, or you are checking multiple entry-point functions, the tool displays the **Code Structure Tab**.

This tab displays information about the relative size of each file and how suitable each file is for code generation.

## Code Distribution

The **Code Distribution** pane displays a pie chart that shows the relative sizes of the files and how suitable each file is for code generation. During the planning phase of a project, you can use this information for estimation and scheduling. If the report indicates that multiple files are not suitable for code generation, consider fixing files that require minor changes before addressing files with significant issues.

## Call Tree

The **Call Tree** pane displays information about the nesting of function calls. For each called function, the report provides a **Code Generation Readiness** score, which ranges from 1 to 5. A score of 1 indicates that the tool detects issues that require extensive changes to the MATLAB code to make it suitable for code generation. A score of 5 indicates that the tool does not detect code generation issues. The code is ready to use with minimal or no changes. The report also lists the number of lines of code in each file.

## Show MATLAB Functions

If you select **Show MATLAB Functions**, the report also lists the MATLAB functions that your function calls. For each of these MATLAB functions, if code generation supports the function, the report sets **Code Generation Readiness** to **Yes**.

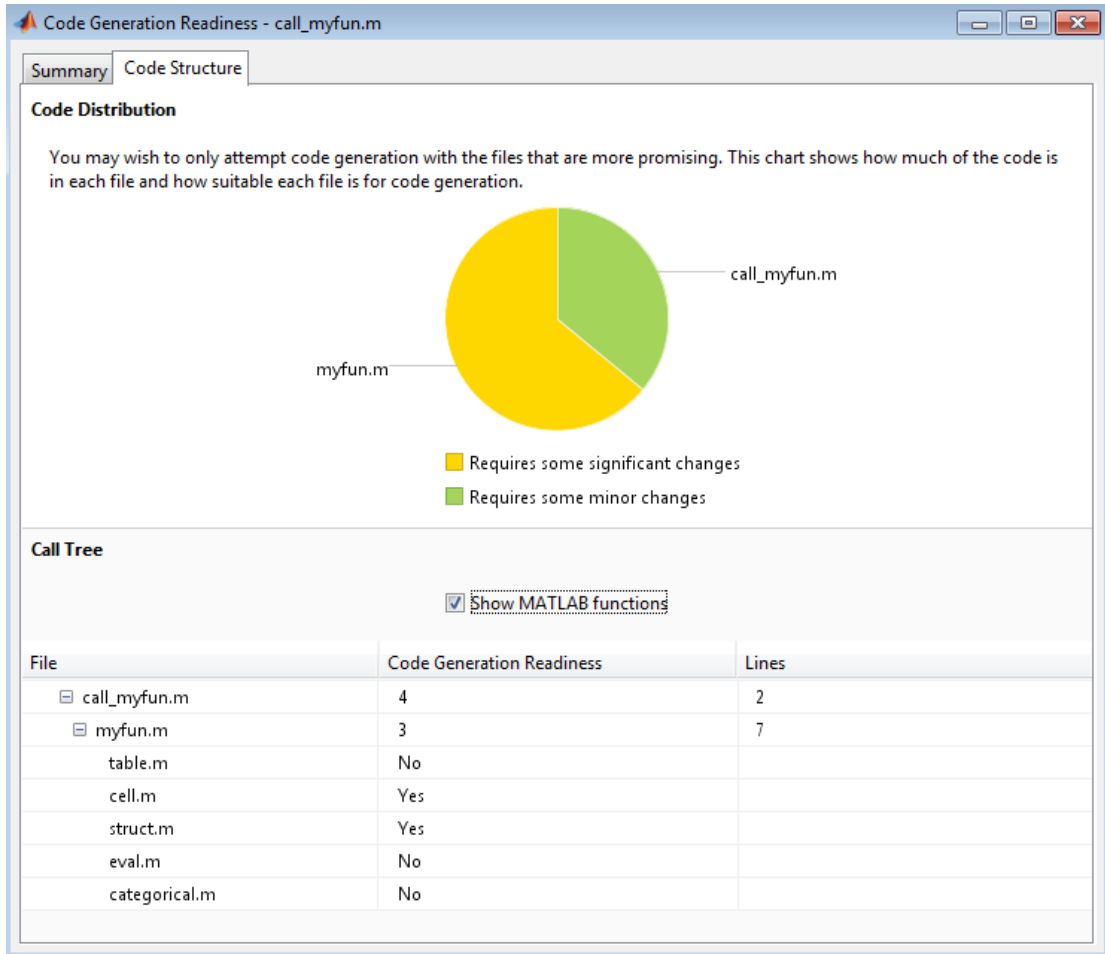

## Related Examples

- “Check Code Using the Code Generation Readiness Tool” on page 40-21

# Check Code Using the Code Generation Readiness Tool

## In this section...

“Run Code Generation Readiness Tool at the Command Line” on page 40-21

“Run the Code Generation Readiness Tool From the Current Folder Browser” on page 40-21

## Run Code Generation Readiness Tool at the Command Line

- 1 Navigate to the folder that contains the file that you want to check for code generation readiness.
- 2 At the MATLAB command prompt, enter:

```
coder.screener('filename')
```

The **Code Generation Readiness** tool opens for the file named `filename`, provides a code generation readiness score, and lists issues that must be fixed prior to code generation.

## Run the Code Generation Readiness Tool From the Current Folder Browser

- 1 In the current folder browser, right-click the file that you want to check for code generation readiness.
- 2 From the context menu, select **Check Code Generation Readiness**.

The **Code Generation Readiness** tool opens for the selected file and provides a code generation readiness score and lists issues that must be fixed prior to code generation.

## More About

- “Code Generation Readiness Tool” on page 40-15

## Debugging a MATLAB Function Block

### In this section...

“Debugging the Function in Simulation” on page 40-22

“Set Conditions on Breakpoints” on page 40-25

“Watching Function Variables During Simulation” on page 40-26

“Checking for Data Range Violations” on page 40-28

“Debugging Tools” on page 40-28

### Debugging the Function in Simulation

In “Create Model That Uses MATLAB Function Block” on page 40-9, you created an example model with a MATLAB Function block that calculates the mean and standard deviation for a set of input values. The software enables debugging for a MATLAB Function when you set a breakpoint.

To debug the MATLAB Function in this model:

- 1 Open the `call_stats_block2` model and double-click the MATLAB Function block `stats` to open the editor.
- 2 In the MATLAB Function Block Editor, click the dash (-) in the left margin of the line:

```
len = length(vals);
```

A red dot appears in the line margin, indicating the breakpoint.



```

1  function [mean, stdev] = stats(vals)
2  %#codegen
3
4  % Calculates a statistical mean and a standard deviation
5  % for the values in vals
6
7  - coder.extrinsic('plot');
8
9  ● len = length(vals);
10 - mean = avg(vals,len);
11 - stdev = sqrt(sum((vals-avg(vals,len)).^2)/len);
12 - plot(vals,'-+');
13
14  function mean = avg(array,size)
15 - mean = sum(array)/size;

```

- 3 Simulate the model.

Simulation pauses when execution reaches the breakpoint. This is indicated by a green arrow in the margin.

```

1  function [mean, stdev] = stats(vals)
2  %#codegen
3
4  % Calculates a statistical mean and a standard deviation
5  % for the values in vals
6
7  - coder.extrinsic('plot');
8
9  ● → len = length(vals);
10 - mean = avg(vals,len);
11 - stdev = sqrt(sum((vals-avg(vals,len)).^2)/len);
12 - plot(vals,'-+');
13
14  function mean = avg(array,size)
15 - mean = sum(array)/size;

```

- 4 In the toolbar, click **Step** to advance execution.

The execution arrow advances to the next line of `stats`, which calls the local function `avg`.

- 5 In the toolbar, click **Step In**.

Execution advances to enter the local function `avg`. Once you are in a local function, you can use the **Step** or **Step In** commands to advance execution. If the local function calls another local function, use **Step In** to enter it. If you want to execute the remaining lines of the local function, use **Step Out**.

- 6** Click **Step** to execute the only line in the local function `avg`. When the local function `avg` finishes executing, a green arrow, pointing down, appears under the last line of the function.
- 7** Click **Step** to return to the function `stats`.

Execution advances to the line after the call to the local function `avg`.

- 8** Click **Step** twice to calculate the `stdev` and to execute the `plot` function.

The `plot` function executes in MATLAB:

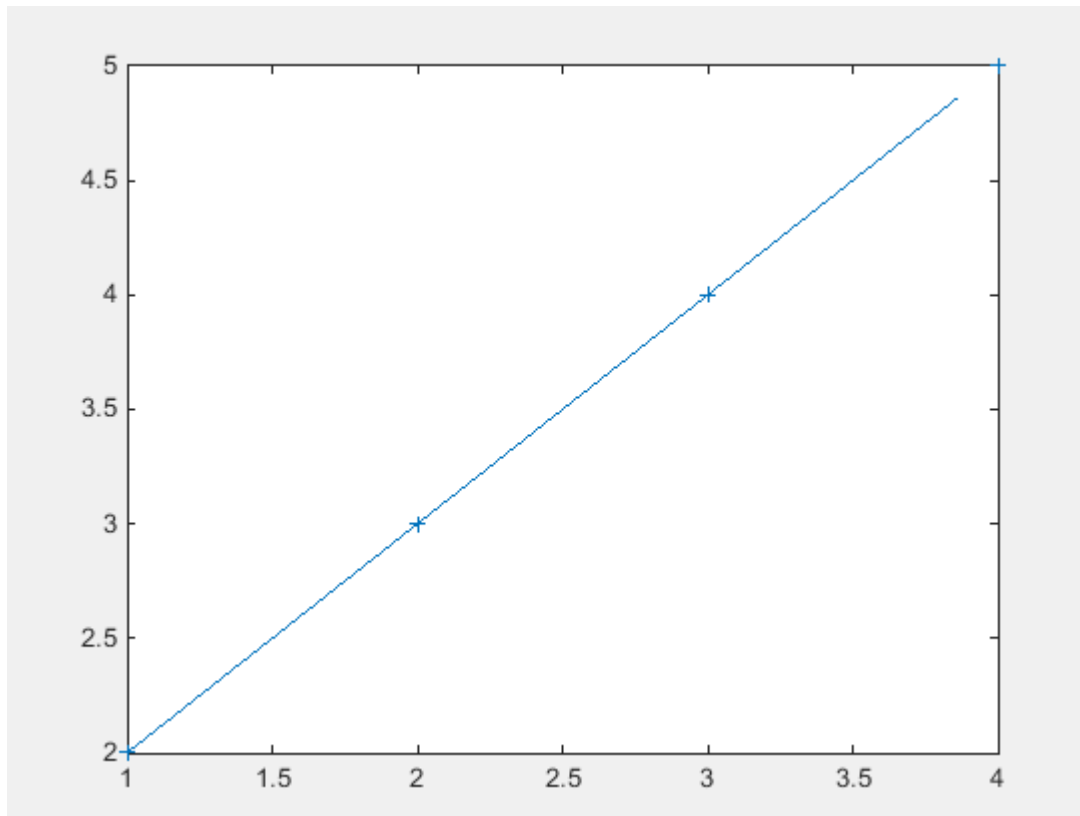

In the MATLAB Function Block Editor, a green arrow points down under the last line of code, indicating the completion of the function `stats`.

- 9 Click **Continue** to continue execution of the model.

The computed values of `mean` and `stdev` appear in the Display blocks.

- 10 In the MATLAB Function Block Editor, click **Quit Debugging** to stop simulation.

## Set Conditions on Breakpoints

To help you debug code, you can enter a MATLAB expression as a condition on a breakpoint inside a MATLAB Function block. Simulation then pauses on that breakpoint only when the condition is true. To set a conditional breakpoint, in the MATLAB

Function block editor, right-click beside the line of code and select **Set Conditional Breakpoint**. Type the condition in the pop-up window. You can use any valid MATLAB expression as a condition. This condition expression can include numerical values and any data that is in scope at the breakpoint.

To add or modify a condition on an existing breakpoint, right-click the breakpoint and select **Set/Modify the condition**. You can also perform these actions from the **Breakpoints** menu.

## Watching Function Variables During Simulation

While you simulate a MATLAB Function block, you can use several tools to keep track of variable values in the function.

### Watching with the Interactive Display

To display the value of a variable in the function of a MATLAB Function block during simulation:

- 1 In the MATLAB Function Block Editor, place the mouse cursor over the variable text and observe the pop-up display.

For example, to watch the variable `len` during simulation, place the mouse cursor over the text `len` in the code. The value of `len` appears adjacent to the cursor, as shown:

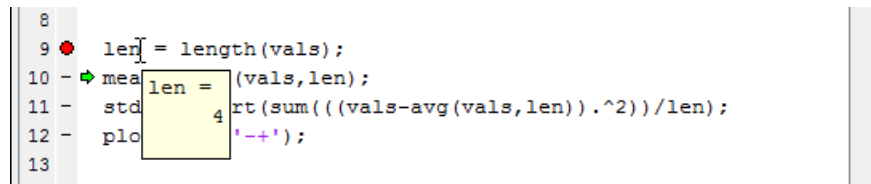

```

8
9 ● len = length(vals);
10 - → mea len = (vals, len);
11 - std 4 rt (sum((vals-avg(vals, len)).^2)/len);
12 - plo '-+');
13

```

### Watching with the Command Line Debugger

You can report the values for a function variable with the Command Line Debugger utility in the MATLAB window during simulation. When you reach a breakpoint, the Command Line Debugger prompt, `debug>>`, appears. At this prompt, you can see the value of a variable defined for the MATLAB Function block by entering its name:

```
debug>> stdev
```

1.1180

debug>>

The Command Line Debugger also provides the following commands during simulation:

Command	Description
ctrl-c	Quit debugging and terminate simulation.
dbcont	Continue execution to next breakpoint.
dbquit	Quit debugging and terminate simulation.
dbstep [in out]	Advance to next program step after a breakpoint is encountered. Step over or step into/out of a MATLAB local function.
help	Display help for command line debugging.
print <var>	Display the value of the variable <code>var</code> in the current scope. If <code>var</code> is a vector or matrix, you can also index into <code>var</code> . For example, <code>var(1,2)</code> .
save	Saves all variables in the current scope to the specified file. Follows the syntax of the MATLAB <code>save</code> command. To retrieve variables to the MATLAB base workspace, use <code>load</code> command after simulation has been ended.
<var>	Equivalent to "print <var>" if variable is in the current scope.
who	Display the variables in the current scope.
whos	Display the size and class (type) of all variables in the current scope.

You can issue any other MATLAB command at the `debug>>` prompt, but the results are executed in the workspace of the MATLAB Function block. To issue a command in the MATLAB base workspace at the `debug>>` prompt, use the `evalin` command with the first argument `'base'` followed by the second argument command, for example, `evalin('base','whos')`. To return to the MATLAB base workspace, use the `dbquit` command.

### Watching with MATLAB

You can display the execution result of a MATLAB Function block line by omitting the terminating semicolon. If you do, execution results for the line are echoed to the MATLAB window during simulation.

## Display Size Limits

The MATLAB Function Block Editor does not display the contents of matrices that have more than two dimensions or more than 200 elements. For matrices that exceed these limits, the MATLAB Function Block Editor displays the shape and base type only.

## Checking for Data Range Violations

MATLAB Function blocks check inputs and outputs for data range violations when the input or output values enter or leave the blocks. To enable data range violation checking, set **Simulation range checking** in the **Diagnostics: Data Validity** pane of the Configuration Parameters dialog box to **error**.

### Specifying a Range

To specify a range for input and output data, follow these steps:



- 1 In the Ports and Data Manager, select the input or output of interest.







The data properties dialog box opens.

- 2 In the data properties dialog box, select the General tab and enter a limit range, as described in “Setting General Properties” on page 40-41.

## Debugging Tools

Use the following tools during a MATLAB Function block debugging session:

Tool Button	Description	Shortcut Key
 <b>Build</b>	Access this tool from the <b>Editor</b> tab by selecting <b>Build Model &gt; Build</b> .  Check for errors and build a simulation application (if no errors are found) for the model containing this MATLAB Function block.	<b>Ctrl+B</b>
 <b>Update Diagram</b>	Access this tool from the <b>Editor</b> tab by selecting <b>Build Model &gt; Update Diagram</b> .  Check for errors based on the latest changes you make to the MATLAB Function block.	<b>Ctrl+D</b>

Tool Button	Description	Shortcut Key
 <b>Update Ports</b>	<p>Access this tool from the <b>Editor</b> tab by selecting <b>Build Model &gt; Update Ports</b>.</p> <p>Updates the ports of the MATLAB Function block with the latest changes made to the function argument and return values without closing the MATLAB Function Block Editor.</p>	<b>Ctrl+Shift+A</b>
 <b>Run Model</b>	<p>Start simulation of the model containing the MATLAB Function block. If execution is paused at a breakpoint, continues debugging.</p>	<b>F5</b>
 <b>Stop Model</b>	<p>Stop simulation of the model containing the MATLAB Function block. Alternatively, from the <b>Editor</b> tab, select <b>Quit Debugging</b> if execution is paused at a breakpoint.</p>	<b>Shift+F5</b>
 <b>Set/Clear</b>	<p>Access this tool by selecting <b>Breakpoints &gt; Set/Clear</b>.</p> <p>Set a new breakpoint or clear an existing breakpoint for the selected line of code in the MATLAB Function block. The presence of the text cursor or highlighted text selects the line. A breakpoint indicator  appears on the selected line.</p> <p>Alternatively, click the hyphen character (-) next to the line number. A breakpoint indicator appears in place of the hyphen. Click the breakpoint indicator to clear the breakpoint.</p>	<b>F12</b>
 <b>Enable/Disable</b>	<p>Access this tool by selecting <b>Breakpoints &gt; Enable/Disable</b>.</p> <p>Enable or disable an existing breakpoint for the selected line of code in the MATLAB Function block. If the breakpoint is disabled, an indicator  appears on the selected line.</p>	<b>None</b>

Tool Button	Description	Shortcut Key
 <p><b>Set Condition</b></p>	<p>Access this tool by selecting <b>Breakpoints &gt; Set Condition</b>.</p> <p>Set a condition on the breakpoint for the selected line of code in the MATLAB Function block. If the breakpoint has a condition associated with it, an indicator  appears on the selected line.</p>	
 <p><b>Clear All</b></p>	<p>Access this tool by selecting <b>Breakpoints &gt; Clear All</b>.</p> <p>Clear all existing breakpoints in the MATLAB Function block code.</p>	<b>None</b>
 <p><b>Step</b></p>	<p>Step through the execution of the next line of code in the MATLAB Function block. This tool steps past function calls and does not enter called functions for line-by-line execution. You can use this tool only after execution has stopped at a breakpoint.</p>	<b>F10</b>
 <p><b>Step In</b></p>	<p>Step through the execution of the next line of code in the MATLAB Function block. If the line calls a local function, step into the first line of the local function. You can use this tool only after execution has stopped at a breakpoint.</p>	<b>F11</b>
 <p><b>Step Out</b></p>	<p>Step out of line-by-line execution of the current function or local function. If in a local function, the debugger continues to the line following the call to this local function. You can use this tool only after execution has stopped at a breakpoint.</p>	<b>Shift+F11</b>
 <p><b>Continue</b></p>	<p>Continue debugging after a pause, such as stopping at a breakpoint. You can use this tool only after execution has stopped at a breakpoint.</p>	<b>F5</b>
 <p><b>Quit Debugging</b></p>	<p>Exit debug mode. You can use this tool only after execution has stopped at a breakpoint.</p>	<b>Shift+F5</b>



## **More About**

- “What Is a MATLAB Function Block?” on page 40-5
- “MATLAB Function Block Editor” on page 40-34
- “MATLAB Function Reports” on page 40-48

## Prevent Algebraic Loop Errors in MATLAB Function and Stateflow Blocks

You can use Stateflow charts, MATLAB Function blocks, and Stateflow Truth Tables in feedback loops in your model. You can also use these blocks with synchronous subsystems enabled by the State Control block. To prevent algebraic loop or synchronous semantic errors, apply these restrictions.

Simulink Block	Restrictions
Stateflow Chart	Use Moore charts to prevent an algebraic loop. In the Property Inspector, set the <b>State Machine Type</b> to <b>Moore</b> . Moore charts prevent algebraic loops by ensuring that outputs depend only on current state.
MATLAB Function block	<p>Nondirect feedthrough semantics prevent algebraic loop errors by ensuring that outputs depend only on current state. To enable these semantics, clear the <b>Allow direct feedthrough</b> property check box.</p> <p>If your block uses direct feedthrough, do not:</p> <ul style="list-style-type: none"> <li>• Call imported functions.</li> <li>• Define output function-call events.</li> <li>• Define or use persistent variables.</li> </ul> <p>When you apply these restrictions, you allow the Simulink solver to try to solve the algebraic loop.</p>
Truth Table	<p>Do not:</p> <ul style="list-style-type: none"> <li>• Call imported functions.</li> <li>• Define local or output function-call events.</li> <li>• Define local or data store memory data.</li> <li>• Define or use persistent variables.</li> </ul>

Simulink Block	Restrictions
	<ul style="list-style-type: none"><li data-bbox="793 303 1305 329">• Use machine-parented data or events.</li></ul> <p data-bbox="793 355 1338 454">When you apply these restrictions, you allow the Simulink solver to try to solve the algebraic loop.</p>

## See Also

Chart (Stateflow) | Truth Table (Stateflow) | Synchronous Subsystem

## More About

- “Design Considerations for Moore Charts” (Stateflow)
- “Use Nondirect Feedthrough in a MATLAB Function Block” on page 40-8
- “Algebraic Loops” on page 3-38
- “Control States When Function-Call Inputs Reenable Charts” (Stateflow)

## MATLAB Function Block Editor

### In this section...

“Customizing the MATLAB Function Block Editor” on page 40-34

“MATLAB Function Block Editor Tools” on page 40-34

“Editing and Debugging MATLAB Function Block Code” on page 40-35





“Ports and Data Manager” on page 40-36

### Customizing the MATLAB Function Block Editor

Use the toolbar icons to customize the appearance of the MATLAB Function Block Editor in the same manner as the MATLAB editor. See “Basic Settings” (MATLAB).

### MATLAB Function Block Editor Tools

Use the following tools to work with the MATLAB Function block:

Tool Button	Description
 <b>Edit Data</b>	Opens the Ports and Data Manager dialog to add or modify arguments for the current MATLAB Function block (see “Ports and Data Manager” on page 40-36).
 <b>View Report</b>	Opens the MATLAB Function report for the MATLAB Function block. For more information, see “MATLAB Function Reports” on page 40-48.
 <b>Simulation Target</b>	Opens the <b>Simulation Target</b> pane in the <b>Configuration Parameters</b> dialog to include custom code.
 <b>Go To Diagram</b>	Displays the MATLAB function in its native diagram without closing the editor.



See “Defining Inputs and Outputs” on page 40-13 for an example of defining an input argument for a MATLAB Function block.

## Editing and Debugging MATLAB Function Block Code

### Manual Indenting

To indent a block of code manually:

- 1 Highlight the text that you would like to indent.
- 2 Select one of the Indent tools on the Editor tab:

Tool	Description
	Applies smart indenting to selected text.
	Move selected text right one indent level.
	Move selected text left one indent level.

### Opening a Selection

You can open a local function, function, file, or variable from within a file in the MATLAB Function Block Editor.

To open a selection:

- 1 Position the cursor in the name of the item you would like to open.
- 2 Right-click and select **Open <selection>** from the context menu.

The Editor chooses the appropriate tool to open the selection. For more information, refer to “Manage Files and Folders” (MATLAB).

---

**Note:** If you open a MATLAB Function block input or output parameter, the Ports and Data Manager opens with the selected parameter highlighted. You can use the Ports and Data Manager to modify parameter attributes. For more information, refer to “Ports and Data Manager” on page 40-36.

---

### Evaluating a Selection

You can use the **Evaluate a Selection** menu option to report the value for a MATLAB function variable or equation in the MATLAB window during simulation.

To evaluate a selection:

- 1 Highlight the variable or equation that you would like to evaluate.
- 2 Hold the mouse over the highlighted text and then right-click and select **Evaluate Selection** from the context menu. (Alternatively, select **Evaluate Selection** from the **Text** menu).

When you reach a breakpoint, the MATLAB command Window displays the value of the variable or equation at the Command Line Debugger prompt.

```
debug>> stdev
```

```
1.1180
```

```
debug>>
```

---

**Note:** You cannot evaluate a selection while MATLAB is busy, for example, running a MATLAB file.

---

### Setting Data Scope

To set the data scope of a MATLAB Function block input parameter:

- 1 Highlight the input parameter that you would like to modify.
- 2 Hold the mouse over the highlighted text and then right-click and select **Data Scope for <selection>** from the context menu.
- 3 Select:
  - **Input** if your input data is provided by the Simulink model via an input port to the MATLAB Function block.
  - **Parameter** if your input is a variable of the same name in the MATLAB or model workspace or in the workspace of a masked subsystem containing this block.

For more information, refer to “Setting General Properties” on page 40-41.

### Ports and Data Manager

The Ports and Data Manager provides a convenient method for defining objects and modifying their properties in a MATLAB Function block.

The Ports and Data Manager provides the same data definition capabilities for individual MATLAB Function blocks as the Model Explorer provides across the model hierarchy (see “Search and Edit Using Model Explorer” on page 12-2).

### Ports and Data Manager Dialog Box

The Ports and Data Manager dialog box allows you to add and define data arguments, input triggers, and function call outputs for MATLAB Function blocks. Using this dialog, you can also modify properties for the MATLAB Function block and the objects it contains.

The dialog box consists of two panes:

- The **Contents** (left) pane lists the objects that have been defined for the MATLAB Function block.
- The **Dialog** (right) pane displays fields for modifying the properties of the selected object.

Properties vary according to the scope and type of the object. Therefore, the Ports and Data Manager properties dialogs are dynamic, displaying only the property fields that are relevant for the object you add or modify.

When you first open the dialog box, it displays the properties of the MATLAB Function block.

### Opening the Ports and Data Manager

To open the Ports and Data Manager from the MATLAB Function Block Editor, select **Edit Data** on the Editor tab. The Ports and Data Manager appears for the MATLAB Function block that is open and has focus.

### Ports and Data Manager Tools

The following tools are specific to the Ports and Data Manager:

Tool Button	Description
 <b>Go to Block Editor</b>	Displays the MATLAB function in the MATLAB Function Block Editor.

Tool Button	Description
 <b>Show Block Dialog</b>	Displays the default MATLAB function properties (see “MATLAB Function Block Properties” on page 40-38). Use this button to return to the settings used by the block after viewing data associated with the block arguments.

### MATLAB Function Block Properties

This section describes each property of a MATLAB Function block.

#### Name

Name of the MATLAB Function block.

#### Update method

Method for activating the MATLAB Function block. You can choose from the following update methods:

Update Method	Description
Inherited (default)	Input from the Simulink model activates the MATLAB Function block. If you define an input trigger, the MATLAB Function block executes in response to a Simulink signal or function-call event on the trigger port. If you do not define an input trigger, the MATLAB Function block implicitly inherits triggers from the model. These implicit events are the sample times (discrete or continuous) of the signals that provide inputs to the chart. If you define data inputs, the MATLAB Function block samples at the rate of the fastest data input. If you do not define data inputs, the MATLAB Function block samples as defined by its parent subsystem's execution behavior.
Discrete	The MATLAB Function block is sampled at the rate you specify as the block's <b>Sample Time</b> property. An implicit event is generated at regular time intervals corresponding to the specified rate. The sample time is in the same units as the Simulink simulation time. Note that other blocks in the model can have different sample times.
Continuous	The Simulink software wakes up (samples) the MATLAB Function block at each step in the simulation, as well as at intermediate time points that can be requested by the solver. This method is consistent with the continuous method.



**Saturate on integer overflow**

Option that determines how the MATLAB Function block handles overflow conditions during integer operations:

Setting	Action When Overflow Occurs
Enabled (default)	Saturates an integer by setting it to the maximum positive or negative value allowed by the word size. Matches MATLAB behavior.
Disabled	In simulation mode, generates a run-time error. For Simulink Coder code generation, the behavior depends on your C language compiler.

---

**Note:** The **Saturate on integer overflow** option is relevant only for integer arithmetic. It has no effect on fixed-point or double-precision arithmetic.

---

When you enable **Saturate on integer overflow**, MATLAB adds additional checks during simulation to detect integer overflow or underflow. Therefore, it is more efficient to disable this option if you are sure that integer overflow and underflow will not occur in your MATLAB Function block code.

Note that the code generated by Simulink Coder does *not* check for integer overflow or underflow and, therefore, may produce unpredictable results when **Saturate on integer overflow** is disabled. In this situation, it is recommended that you simulate first to test for overflow and underflow before generating code.

**Lock Editor**

Option for locking the MATLAB Function Block Editor. When enabled, this option prevents users from making changes to the MATLAB Function block.

**Treat these inherited Simulink signal types as fi objects**

Setting that determines whether to treat inherited fixed-point and integer signals as Fixed-Point Designer `fi` objects (“Ways to Construct `fi` Objects” (Fixed-Point Designer)).

- When you select **Fixed-point**, the MATLAB Function block treats all fixed-point inputs as Fixed-Point Designer `fi` objects.
- When you select **Fixed-point & Integer**, the MATLAB Function block treats all fixed-point and integer inputs as Fixed-Point Designer `fi` objects.

**MATLAB Function block fimath**

Setting that defines `fimath` properties for the MATLAB Function block. The block associates the `fimath` properties you specify with the following objects:

- All fixed-point and integer input signals to the MATLAB Function block that you choose to treat as `fi` objects.
- All `fi` and `fimath` objects constructed in the MATLAB Function block.

You can select one of the following options for the **MATLAB Function block fimath**.

Setting	Description
<b>Same as MATLAB</b>	When you select this option, the block uses the same <code>fimath</code> properties as the current default <code>fimath</code> . The edit box appears dimmed and displays the current global <code>fimath</code> in read-only form.
<b>Specify other</b>	<p>When you select this option, you can specify your own <code>fimath</code> object in the edit box. You can do so in one of two ways:</p> <ul style="list-style-type: none"> <li>• Constructing the <code>fimath</code> object inside the edit box.</li> <li>• Constructing the <code>fimath</code> object in the MATLAB or model workspace and then entering its variable name in the edit box. If you use this option and plan to share your model with others, make sure you define the variable in the model workspace. See “Sharing Models with Fixed-Point MATLAB Function Blocks” (Fixed-Point Designer).</li> </ul> <p>For more information on <code>fimath</code> objects, see “<code>fimath</code> Object Construction” (Fixed-Point Designer).</p>

**Description**

Description of the MATLAB Function block.

**Document link**

Link to documentation for the MATLAB Function block. To document a MATLAB Function block, set the **Document link** property to a Web URL address or MATLAB expression that displays documentation in a suitable format (for example, an HTML file or text in the MATLAB Command Window). The MATLAB Function block evaluates the expression when you click the blue **Document link** text.

## Adding Data to a MATLAB Function Block

You can define data arguments for MATLAB Function blocks using the following methods:

Method	For Defining	Reference
Define data directly in the MATLAB Function block code	Input and output data	See “Defining Inputs and Outputs” on page 40-13.
Use the Ports and Data Manager	Input, output, and parameter data in the MATLAB Function block that is open and has focus	See “Defining Data in the Ports and Data Manager” on page 40-41.
Use the Model Explorer	Input, output, and parameter data in MATLAB Function blocks at all levels of the model hierarchy	See “Search and Edit Using Model Explorer” on page 12-2

### Defining Data in the Ports and Data Manager

To add a data argument, in the Ports and Data Manager, select **Add > Data** and modify the data properties.

#### Setting General Properties

You can set the following properties in the General tab:

Property	Description
<b>Name</b>	Name of the data argument, following the same naming conventions used in MATLAB.
<b>Scope</b>	Where data resides in memory, relative to its parent. Scope determines the range of functionality of the data argument. You can set scope to one of the following values: <ul style="list-style-type: none"> <li><b>Parameter</b>— Specifies that the source for this data is a variable of the same name in the MATLAB or model workspace or in the workspace of a masked subsystem containing this block. If a variable of the same name exists in more than one of the workspaces visible to the block, the variable closest to the block in the workspace hierarchy is used (see “Model Workspaces” on page 57-106).</li> </ul>

Property	Description
	<ul style="list-style-type: none"> <li>• <b>Input</b>— Data provided by the model via an input port to the MATLAB Function block.</li> <li>• <b>Output</b>— Data provided by the MATLAB Function block via an output port to the model.</li> <li>• <b>Data Store Memory</b>— Data provided by a Data Store Memory block in the model.</li> </ul> <p>For more information, see “Defining Inputs and Outputs” on page 40-13 and “Add Parameter Arguments” on page 40-72.</p>
<b>Port</b>	Index of the port associated with the data argument. This property applies only to input and output data.
<b>Tunable</b>	Indicates whether the parameter used as the source of this data item is tunable (see “Tunable Parameters” on page 3-8). This property applies only to parameter data. Clear this option if the parameter must be a constant expression, such as for MATLAB toolbox functions supported for code generation (see “Functions and Objects Supported for C/C++ Code Generation — Alphabetical List” on page 44-2).
<b>Data must resolve to Simulink signal object</b>	Specifies that the data argument must resolve to a Simulink signal object. This property applies only to output data. This property appears only if you set the model configuration parameter <b>Signal resolution</b> to a value other than <b>None</b> . See “Symbol Resolution” on page 57-118 for more information.
<b>Size</b>	Size of the data argument. Size can be a scalar value or a MATLAB vector of values. Size defaults to $-1$ , which means that it is inherited, as described in “Inheriting Argument Sizes from Simulink” on page 40-68. This property does not apply to Data Store Memory data. For more details, see “Size Function Arguments” on page 40-68.
<b>Variable Size</b>	Indicates whether the size of this data item is variable. This property does not apply to Data Store Memory data.

Property	Description
<b>Complexity</b>	<p>Indicates real or complex data arguments. You can set complexity to one of the following values:</p> <ul style="list-style-type: none"> <li>• <b>Off</b>— Data argument is a real number</li> <li>• <b>On</b>— Data argument is a complex number</li> <li>• <b>Inherited</b>— Data argument inherits complexity based on its scope. Input and output data inherit complexity from the Simulink signals connected to them; parameter data inherits complexity from the parameter to which it is bound.</li> </ul>
<b>Type</b>	<p>Type of data object. You can specify the data type by:</p> <ul style="list-style-type: none"> <li>• Selecting a built-in type from the <b>Type</b> drop down list.</li> <li>• Entering an expression in the <b>Type</b> field that evaluates to a data type (see “About Data Types in Simulink” on page 57-3).</li> <li>• Using the Data Type Assistant to specify a data <b>Mode</b>, then specifying the data type based on that mode.</li> </ul> <hr/> <p><b>Note:</b> To display the Data Type Assistant, click the Show data type assistant button:</p> <div style="text-align: center; margin: 10px 0;">  </div> <hr/> <p>For more information, see “Specifying Argument Types” on page 40-61.</p>
<b>Unit (e.g., m, m/s<sup>2</sup>, N*m)</b>	<p>Specify physical units for input and output data. By default, the property is set to inherit the unit from the Simulink signal on the corresponding input or output port. See “Units in MATLAB Function Blocks” on page 40-71.</p>

Property	Description
<b>Limit range</b>	<p>Specify the range of acceptable values for input or output data. The MATLAB Function block uses this range to validate the input or output as it enters or leaves the block. You can enter an expression or parameter that evaluates to a numeric scalar value.</p> <ul style="list-style-type: none"> <li>• <b>Minimum</b> — The smallest value allowed for the data item during simulation. The default value is <code>-inf</code>.</li> <li>• <b>Maximum</b> — The largest value allowed for the data item during simulation. The default value is <code>inf</code>.</li> </ul>

### Setting Description Properties

You can set the following properties on the Description tab:

Property	Description
<b>Save final value to base workspace</b>	The MATLAB Function block assigns the value of the data argument to a variable of the same name in the MATLAB base workspace at the end of simulation.
<b>Description</b>	Description of the data argument.
<b>Document link</b>	Link to documentation for the data argument. You can enter a Web URL address or a MATLAB command that displays documentation in a suitable format, such as an HTML file or text in the MATLAB Command Window. When you click the blue text, <b>Document link</b> , displayed at the bottom of the <b>Data</b> properties dialog, the MATLAB Function block evaluates the link and displays the documentation.

### Adding Input Triggers to a MATLAB Function Block

An input trigger is an event on the input port that causes the MATLAB Function block to execute. See “Triggered Subsystems” on page 10-14.

You can define the following types of triggers in MATLAB Function blocks:

- Rising
- Falling
- Either (rising or falling)
- Function call

For a description of each trigger type, see “Setting Input Trigger Properties” on page 40-45.

Use the Ports and Data Manager to add input triggers to a MATLAB Function block that is open and has focus. To add an input trigger and modify its properties, follow these steps:

- 1 In the Ports and Data Manager, select **Add > Input Trigger**.

The Ports and Data Manager adds a default definition of the new input trigger to the MATLAB Function block and displays the Trigger properties dialog.

- 2 Modify trigger properties.
- 3 Return to the MATLAB Function block properties at any time by selecting **Tools > Block Dialog**.

### The Trigger Properties Dialog

The Trigger properties dialog in the Ports and Data Manager allows you to set and modify the properties of input triggers in MATLAB Function blocks.

To open the Trigger properties dialog, select an input trigger in the Contents pane.

### Setting Input Trigger Properties

You can set the following properties in the Trigger properties dialog:

Property	Description
<b>Name</b>	Name of the input trigger, following the same naming conventions used in MATLAB.
<b>Port</b>	Index of the port associated with the input trigger. The default value is 1.
<b>Trigger</b>	Type of event that triggers execution of the MATLAB Function block. You can select one of the following types of triggers: <ul style="list-style-type: none"> <li>• <b>Rising</b> (default) — Triggers execution of the MATLAB Function block when the control signal rises from a negative or zero value to a positive value (or zero if the initial value is negative).</li> <li>• <b>Falling</b>— Triggers execution of the MATLAB Function block when the control signal falls from a positive or zero value to a negative value (or zero if the initial value is positive).</li> </ul>

Property	Description
	<ul style="list-style-type: none"> <li>• <b>Either</b>— Triggers execution of the MATLAB Function block when the control signal is either rising or falling.</li> <li>• <b>Function call</b>— Triggers execution of the MATLAB Function block from a block that outputs function-call events, or from an S-function</li> </ul>
<b>Description</b>	Description of the input trigger.
<b>Document link</b>	Link to documentation for the input trigger. You can enter a Web URL address or a MATLAB command that displays documentation in a suitable format, such as an HTML file or text in the MATLAB Command Window. When you click the blue text that reads <b>Document link</b> displayed at the bottom of the <b>Trigger</b> properties dialog, the MATLAB Function block evaluates the link and displays the documentation.

### Adding Function Call Outputs to a MATLAB Function Block

A function call output is an event on the output port of a MATLAB Function block that causes a Function-Call Subsystem block in the Simulink model to execute. Another block can invoke a function-call subsystem directly during a simulation. See “Function-Call Subsystems” on page 10-23.

Use the Ports and Data Manager to add and modify function call outputs to a MATLAB Function block that is open and has focus. To add a function call output and modify its properties, follow these steps:

- 1 In the Ports and Data Manager, select **Add > Function Call Output**.

The Ports and Data Manager adds a default definition of the new function call output to the MATLAB Function block and displays the Function Call properties dialog.

- 2 Modify function call output properties.
- 3 Return to the MATLAB Function block properties at any time by selecting **Tools > Block Dialog**.

### Considerations when Supplying Output to the Function-Call Subsystem

If a MATLAB Function block triggers a function-call subsystem, and supplies an output signal to the same function-call subsystem, the signal to the function-call subsystem can



effectively be delayed by one time step compared to the function call. At the moment of the function call, the function-call subsystem sees the previous MATLAB Function block output value even if the output data has been updated within the block MATLAB code.

### The Function Call Properties Dialog

The Function Call properties dialog in the Ports and Data Manager allows you to edit the properties of function call outputs in MATLAB Function blocks.

To open the Function Call properties dialog, select a function call output in the Contents pane.

### Setting Function Call Output Properties

You can set the following properties in the Function Call properties dialog:

Property	Description
<b>Name</b>	Name of the function call output, following the same naming conventions used in MATLAB.
<b>Port</b>	Index of the port associated with the function call output. Function call output ports are numbered sequentially after input and output ports.
<b>Description</b>	Description of the function call output.
<b>Document link</b>	Link to documentation for the function call output. You can enter a Web URL address or a MATLAB command that displays documentation in a suitable format, such as an HTML file or text in the MATLAB Command Window. When you click <b>Document link</b> displayed at the bottom of the <b>Function Call</b> properties dialog, the MATLAB Function block evaluates the link and displays the documentation.

## Related Examples

- “Create Model That Uses MATLAB Function Block” on page 40-9

## More About

- “Debugging a MATLAB Function Block” on page 40-22
- “What Is a MATLAB Function Block?” on page 40-5

## MATLAB Function Reports

**In this section...**

“About MATLAB Function Reports” on page 40-48  
“Opening MATLAB Function Reports” on page 40-49  
“Description of MATLAB Function Reports” on page 40-49  
“Viewing Your MATLAB Function Code” on page 40-49  
“Viewing Call Stack Information” on page 40-50  
“Viewing the Compilation Summary Information” on page 40-51  
“Viewing Error and Warning Messages” on page 40-51  
“MATLAB Code Variables in a Report” on page 40-52  
“Keyboard Shortcuts for the MATLAB Function Report” on page 40-57  
“Searching in the MATLAB Function Report” on page 40-59  
“Report Limitations” on page 40-59

### About MATLAB Function Reports

When you build a Simulink model that contains MATLAB Function blocks, Simulink generates a report in HTML format for each MATLAB Function block in your model. You can use the report to debug your MATLAB functions and verify that they are suitable for code generation. The report provides links to your MATLAB functions and compile-time type information for the variables and expressions in these functions. If your model fails to build, this information simplifies finding sources of error messages and aids understanding of type propagation rules.

---

**Note:** If you have a Stateflow license, there is one report for each Stateflow chart, regardless of the number of MATLAB functions it contains.

---

---

**Note:** If you have identical MATLAB Function blocks in your model, for example, one in a library and one in the model, a single report is generated for the identical blocks.

---

## Opening MATLAB Function Reports

Use one of the following methods:

- In the MATLAB Function Block Editor, select **View Report**.
- If compilation errors occur, in the **Diagnostic Viewer** window, select the `report` link.

## Description of MATLAB Function Reports



When you build the MATLAB function, the code generation software generates an HTML report. The report provides the following information, as applicable:

- MATLAB code information, including a list of all functions and their compilation status
- Call stack information, providing information on the nesting of function calls
- Summary of compilation results, including type of target and number of warnings or errors
- List of error and warning messages
- List of variables in your MATLAB function

## Viewing Your MATLAB Function Code

To view your MATLAB function code, click the **MATLAB code** tab. The report displays the MATLAB code for the function highlighted in the list on this tab.

The **MATLAB code** tab provides:

- A list of the MATLAB functions that have been compiled. The report displays icons next to each function name to indicate whether compilation was successful:
  -  Errors in function.
  -  Warnings in function.
  -  Successful compilation, no errors or warnings.
- A filter control that you can use to sort your functions by:

- Size
- Complexity
- Class

### Viewing Local Functions

The report annotates the local function with the name of the parent function in the list of functions on the **MATLAB code** tab.

For example, if the MATLAB function `fcn1` contains the local function `subfcn` and `fcn2` contains the local function `subfcn2`, the report displays:

```
fcn1 > subfcn1  
fcn2 > subfcn2
```

### Viewing Specializations

If your MATLAB function calls the same function with different types of inputs, the report numbers each of these **specializations** in the list of functions on the **MATLAB code** tab.

For example, if the function `fcn` calls the function `subfcn` with different types of inputs:

```
function y = fcn(u)  
% Specializations  
y = y + subfcn(single(u));  
y = y + subfcn(double(u));
```

The report numbers the specializations in the list of functions.

```
fcn > subfcn > 1  
fcn > subfcn > 2
```

### Viewing Call Stack Information

The report provides call stack information:

- On the **Call stack** tab.
- In the list of **Callers**.

If a function is called from more than one function, this list provides details of each call site. Otherwise, the list is disabled.

## Viewing Call Stack Information on the Call Stack Tab

To view call stack information, click the **Call stack** tab. The call stack lists the functions in the order that the top-level function calls them. It also lists the local functions that each function calls.

## Viewing Function Call Sites in the Callers List

If a function is called from more than one function, this list provides details of each call site. To navigate between call sites, select a call site from the **Callers** list. If the function is not called more than once, this list is disabled.

## Viewing the Compilation Summary Information

To view a summary of the compilation results, including type of target and number of errors or warnings, click the **Summary** tab.

## Viewing Error and Warning Messages

The report provides information about errors and warnings. If errors occur during simulation of a Simulink model, simulation stops. If warnings occur, but no errors, simulation of the model continues.

The report provides information about warnings and errors by listing all errors and warnings in chronological order in the **All Messages** tab.

## Viewing Errors and Warnings in the All Messages Tab

If errors or warnings occurred during compilation, click the **All Messages** tab to view a complete list of these messages. The report lists the messages in the order that the compiler detects them. It is best practice to address the first message in the list, because often subsequent errors and warnings are related to the first message.

To locate the offending line of code for an error or warning in the list, click the message in the list. The report highlights errors in the list and MATLAB code in red and warnings in orange. Click the blue line number next to the offending line of code in the MATLAB code pane to go to the error in the source file.

---

**Note:** You can fix errors only in the source file.



---

Function: stats      Callers: Select a function call site:

```

1 function [mean, stdev] = stats(vals)
2 %#codegen
3
4 % Calculates a statistical mean and a standard deviation
5 % for the values in vals
6
7 coder.extrinsic('plot');
8
9 len = length(vals);
10 mean = avg(vals, len);
11 stdev = sqrt(sum(((vals-avg(vals, len)).^2))/len);
12 plot(vals, '-+');
13

```

Summary		All Messages (2)	Variables	
Order	Type	Function	Line	Description
1		stats	10	Undefined function or variable 'avg'.
2		stats	11	Undefined function or variable 'avg'.

### Viewing Error and Warning Information in Your MATLAB Code

If errors or warnings occurred during compilation, the report underlines them in your MATLAB code. The report underlines errors in red and warnings in orange. To learn more about a particular error or warning, place your pointer over the underlined text.

### MATLAB Code Variables in a Report

The report provides compile-time type information for the variables and expressions in your MATLAB code, including name, type, size, complexity, and class. It also provides type information for fixed-point data types, including word length and fraction length. You can use this type information to find the sources of error messages and to understand type propagation rules.

You can view information about the variables in your MATLAB code:

- On the **Variables** tab, view the list.

- In your MATLAB code, place your cursor over the variable name.

In the MATLAB code, an orange variable name indicates a compile-time constant argument to a specialized function. The information for a constant argument includes the value. This information helps you to see when code generation created function specializations for different constant argument values.

### Variables on the Variables Tab

To view a list of the variables in your MATLAB function, click the **Variables** tab. The report displays a complete list of variables in the order that they appear in the function that you selected on the **MATLAB code** tab. Clicking a variable in the list highlights instances of that variable, and scrolls the MATLAB code pane so that you can view the first instance.

As applicable, the report provides the following information about each variable:

- Order
- Name
- Type
- Size
- Complexity
- Class
- DataTypeMode (DT mode) — for fixed-point data types only. For more information, see “Data Type and Scaling Properties” (Fixed-Point Designer).
- Signed — sign information for built-in data types, signedness information for fixed-point data types.
- Word length (WL) — for fixed-point data types only.
- Fraction length (FL) — for fixed-point data types only.

---

**Note:** For more information on viewing fixed-point data types, see “Use Fixed-Point Code Generation Reports” (Fixed-Point Designer).

---

The report displays a column only if at least one variable in the code has information in that column. For example, if the code does not contain fixed-point data types, the report does not display the **DT mode**, **WL**, or **FL** columns.

### Sorting Variables on the Variables Tab

By default, the report lists the variables in the order that they appear in the selected function.

To sort the variables, click the column headings on the **Variables** tab. To sort the variables by multiple columns, hold down the **Shift** key when you click the column headings.

To restore the list to the original order, click the **Order** column heading.

### Structures on the Variables Tab

To display structure field properties, expand the structure on the **Variables** tab.

Summary	All Messages (0)	Variables	Target Build Log		
Order	Variable	Type	Size	Class	Complex
1	s	Output	1 x 1	struct	-
1.1	s.a	Field	1 x 1	double	No
1.2	s.b	Field	1 x 1	double	No

If you sort the variables by type, size, complexity, or class, it is possible that a structure and its fields do not appear sequentially in the list. To restore the list to the original order, click the **Order** column heading.

### Variable-Size Arrays in the Variables Tab

For variable-size arrays, the **Size** field includes information about the computed maximum size of the array. The size of each array dimension that varies is prefixed with a colon **:**. The size of an unbounded dimension is **:?**.

In the following report, variables **A** and **B** are variable-size. The second dimension of **A** has a maximum size of 100. The size of the second dimension of **B** is **:?**.

Summary	All Messages (0)	Variables	Target Build Log		
Order	Variable	Type	Size	Class	Complex
1	C	Output	1 x :100	double	No
2	A	Input	1 x :100	double	No
3	B	Input	1 x :?	double	No



If you declare a variable-size array, and then fix the dimensions of this array in the code, the report appends \* to the size of the variable. In the generated C code, this variable appears as a variable-size array, but the sizes of its dimensions do not change during execution.

Summary	All Messages (0)	Variables	Target Build Log		
Order	Variable	Type	Size	Class	Complex
1	y	Output	1 x 1 *	double	No

For information about how to use the size information for variable-size arrays, see “Code Generation for Variable-Size Arrays” on page 48-2.

### Renamed Variables in the Variables Tab

If your MATLAB function reuses a variable with a different size, type, or complexity, the code generator attempts to create separate, uniquely named variables. For more information, see “Reuse the Same Variable with Different Properties” on page 46-10. The report numbers the renamed variables in the list on the **Variables** tab. When you place your cursor over a renamed variable, the report highlights only the instances of this variable that share data type, size, and complexity.

For example, suppose that your code uses the variable `t` to hold a scalar double, and reuses it outside the for-loop to hold a vector of doubles. In the list on the **Variables** tab, the report displays two variables, `t>1` and `t>2`,

Summary	All Messages (0)	Variables	Target Build Log		
Order	Variable	Type	Size	Class	Complex
1	y	Output	1 x 1	double	No
2	u	Input	5 x 5	double	No
3	t > 1	Local	1 x 1	double	No
4	t > 2	Local	:25 x 1	double	No

### Viewing Information About Variables and Expressions in Your MATLAB Function Code

To view information about a particular variable or expression in your MATLAB function code, on the MATLAB code pane, place your cursor over the variable name or expression. The report highlights variables and expressions in different colors:

Green, when the variable has data type information at this location in the code

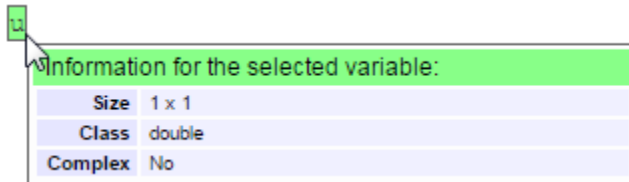

Information for the selected variable:	
Size	1 x 1
Class	double
Complex	No

For variable-size arrays, the **Size** field includes information on the computed maximum size of the array. The size of each array dimension that varies is prefixed with a colon **:**.

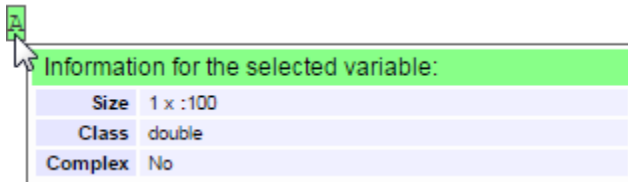

Information for the selected variable:	
Size	1 x :100
Class	double
Complex	No

Green with orange text, when a constant argument has data type and value information

When the variable is a compile-time constant argument to a specialized function:

- The variable name is orange.
- The information for the variable includes the value.

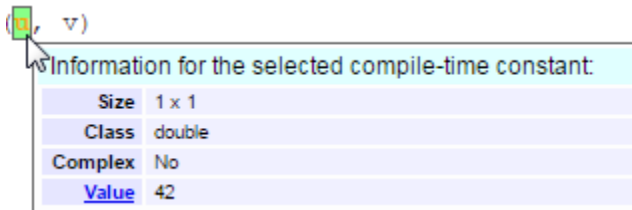

Information for the selected compile-time constant:	
Size	1 x 1
Class	double
Complex	No
Value	42

If you export the value as a variable to the base workspace, you can use the Workspace browser to view detailed information about the variable.

To export the value to the base workspace:

- 1 Click the **Value** link.
- 2 In the Export Constant Value dialog box, specify the **Variable name**.
- 3 Click **OK**.

The variable and its value appear in the Workspace browser.

#### Pink, when the variable has no data type information

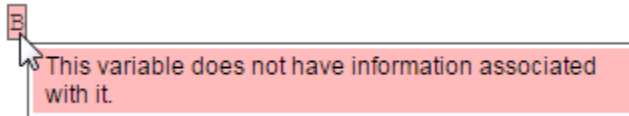

#### Purple, information about expressions

You can also view information about expressions in your MATLAB code. On the MATLAB code pane, place your cursor over an expression. The report highlights expressions in purple and provides more detailed information.

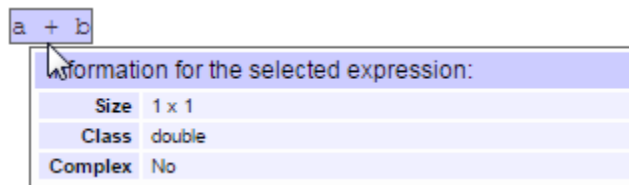

#### Red, when there is error information

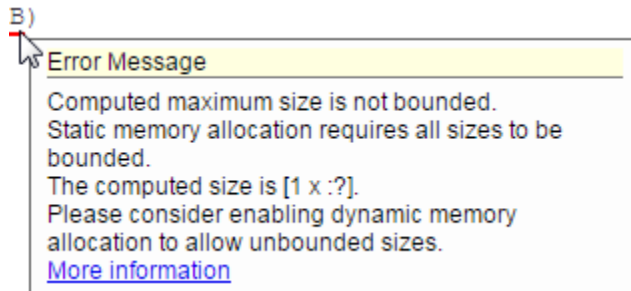

## Keyboard Shortcuts for the MATLAB Function Report

You can use keyboard shortcuts settings to perform actions in the report.

This table lists actions that you can associate with a keyboard shortcut. The keyboard shortcuts are defined in your MATLAB preferences. See “Define Keyboard Shortcuts” (MATLAB).

Action	Default Keyboard Shortcut for a Windows Platform
Zoom in	Ctrl+Plus
Zoom out	Ctrl+Minus
Evaluate selected MATLAB code	F9
Open help for selected MATLAB code	F1
Open selected MATLAB code	Ctrl+D
Step backward through files that you opened in the code pane	Alt+Left
Step forward through files that you opened in the code pane	Alt+Right
Refresh	F5
Search	Ctrl+F

Alternatively, you can select these actions from a context menu. To open the context menu, right-click anywhere in the report.

Zoom In	Ctrl+Plus
Zoom Out	Ctrl+Minus
Evaluate Selection	F9
Help on Selection	F1
Open Selection	Ctrl+D
Back	Alt+Left
Forward	Alt+Right
Refresh	F5
Find...	Ctrl+F
Page Source	

This table lists keyboard shortcuts that help you navigate between panes and tabs in the code generation report. To advance through data in the selected pane, use the **Tab**

key. These keyboard shortcuts override the keyboard shortcut settings in your MATLAB preferences. See “Define Keyboard Shortcuts” (MATLAB).

To select	Use
<b>MATLAB code</b> tab	<b>Ctrl+M</b>
<b>Call stack</b> tab	<b>Ctrl+K</b>
<b>Code Pane</b>	<b>Ctrl+W</b>
<b>Summary Tab</b>	<b>Ctrl+S</b>
<b>All Messages Tab</b>	<b>Ctrl+A</b>
<b>Variables Tab</b>	<b>Ctrl+V</b>

## Searching in the MATLAB Function Report

Use the keyboard shortcut associated with `Find` in your MATLAB preferences. The default keyboard shortcut for `Find` on a Windows platform is **Ctrl+F**.

## Report Limitations

The report displays information about the variables and expressions in your MATLAB code with the following limitations:

### **varargin and varargout**

The report does not support `varargin` and `varargout` arrays.

### **Loop Unrolling**

The report does not display full information for unrolled loops. It displays data types of one arbitrary iteration.

### **Dead Code**

The report does not display information about dead code.

### **Structures**

The report does not provide complete information about structures.

- The report does not provide information about all structure fields in the `struct()` constructor.
- If a structure has a nonscalar field, and an expression accesses an element of this field, the report does not provide information for the field.

### **Column Headings on the Variables Tab**

If you scroll through the list of variables, the report does not display the column headings on the **Variables** tab.

### **Multiline Matrices**

On the **MATLAB code** pane, the report does not support selection of multiline matrices. It supports only selection of individual lines at a time. For example, if you place your cursor over the following matrix, you cannot select the entire matrix.

```
out1 = [1 2 3;  
        4 5 6];
```

The report does support selection of single line matrices.

```
out1 = [1 2 3; 4 5 6];
```

### **More About**

- “What Is a MATLAB Function Block?” on page 40-5
- “MATLAB Function Block Editor” on page 40-34

# Type Function Arguments

## In this section...

“About Function Arguments” on page 40-61

“Specifying Argument Types” on page 40-61

“Inheriting Argument Data Types” on page 40-63

“Built-In Data Types for Arguments” on page 40-63

“Specifying Argument Types with Expressions” on page 40-64

“Specifying Fixed-Point Designer Data Properties” on page 40-64

## About Function Arguments

You create function arguments for a MATLAB Function block by entering them in its function header in the MATLAB Function Block Editor. When you define arguments, the Simulink software creates corresponding ports on the MATLAB Function block that you can attach to signals. You can select a *data type mode* for each argument that you define for a MATLAB Function block. Each data type mode presents its own set of options for selecting a *data type*.

By default, the data type mode for MATLAB Function block function arguments is **Inherited**. This means that the function argument inherits its data type from the incoming or outgoing signal. To override the default type, you first choose a data type mode and then select a data type based on the mode.

## Specifying Argument Types

To specify the type of a MATLAB Function block function argument:

- 1 From the MATLAB Function Block Editor, select **Edit Data** to open the Ports and Data Manager.
- 2 In the left pane, select the argument of interest.
- 3 In the **Data** properties dialog box (right pane), click the Show data type assistant button  to display the Data Type Assistant. Then, choose an option from the **Mode** drop-down menu.

The **Data** properties dialog box changes dynamically to display additional fields for specifying the data type associated with the mode.

- 4 Based on the mode you select, specify a desired data type:

Mode	What to Specify
Inherit (default)	<p>You cannot specify a value. The data type is inherited from previously-defined data, based on the scope you selected for the MATLAB Function block function argument:</p> <ul style="list-style-type: none"> <li>• If scope is <b>Input</b>, data type is inherited from the input signal on the designated port.</li> <li>• If scope is <b>Output</b>, data type is inherited from the output signal on the designated port.</li> <li>• If scope is <b>Parameter</b>, data type is inherited from the associated parameter, which can be defined in the Simulink masked subsystem or the MATLAB workspace.</li> </ul> <p>See “Inheriting Argument Data Types” on page 40-63.</p>
Built in	<p>Select from the drop-down list of supported data types, as described in “Built-In Data Types for Arguments” on page 40-63.</p>
Fixed point	<p>Specify the fixed-point data properties as described in “Specifying Fixed-Point Designer Data Properties” on page 40-64.</p>
Expression	<p>Enter an expression that evaluates to a data type, as described in “Specifying Argument Types with Expressions” on page 40-64.</p>
Bus Object	<p>In the <b>Bus object</b> field, enter the name of a <code>Simulink.Bus</code> object to define the properties of a MATLAB structure. You must define the bus object in the base workspace. See “How Structure Inputs and Outputs Interface with Bus Signals” on page 40-78.</p> <hr/> <p><b>Note:</b> You can click the <b>Edit</b> button to create or modify <code>Simulink.Bus</code> objects using the Simulink Bus Editor (see “Attach Bus Signals to MATLAB Function Blocks” on page 40-76).</p>
Enumerated	<p>In the Enumerated field, enter the name of a <code>Simulink.IntEnumType</code> object that you define in the base workspace. See “Code Generation for Enumerations” on page 40-108.</p>



## Inheriting Argument Data Types

MATLAB Function block function arguments can inherit their data types, including fixed point types, from the signals to which they are connected.

- 1 Select the argument of interest in the Ports and Data Manager
- 2 In the **Data** properties dialog, select **Inherit: Same as Simulink** from the **Type** drop-down menu.

See “Built-In Data Types for Arguments” on page 40-63 for a list of supported data types.

---

**Note** An argument can also inherit its complexity (whether its value is a real or complex number) from the signal that is connected to it. To inherit complexity, set the **Complexity** field on the **Data** properties dialog to **Inherited**.

---

After you build the model, the **Compiled Type** column of the Ports and Data Manager gives the actual type inherited from Simulink in the compiled simulation application.

The inherited type of output data is inferred from diagram actions that store values in the specified output. In the preceding example, the variables `mean` and `stdev` are computed from operations with double operands, which yield results of type `double`. If the expected type matches the inferred type, inheritance is successful. In all other cases, a mismatch occurs during build time.

---

**Note** Library MATLAB Function blocks can have inherited data types, sizes, and complexities like ordinary MATLAB Function blocks. However, all instances of the library block in a given model must have inputs with the same properties.

---

## Built-In Data Types for Arguments

When you select **Built-in** for **Data type mode**, the **Data** properties dialog displays a **Data type** field that provides a drop-down list of supported data types. You can also choose a data type from the **Data Type** column in the Ports and Data Manager. The supported data types are:

Data Type	Description
double	64-bit double-precision floating point
single	32-bit single-precision floating point
int32	32-bit signed integer
int16	16-bit signed integer
int8	8-bit signed integer
uint32	32-bit unsigned integer
uint16	16-bit unsigned integer
uint8	8-bit unsigned integer
boolean	Boolean (1 = true; 0 = false)

## Specifying Argument Types with Expressions

You can specify the types of MATLAB Function block function arguments as expressions in the Ports and Data Manager.

- 1 Select `<data type expression>` from the **Type** drop-down menu of the Data properties dialog.
- 2 In the **Type** field, replace “`<data type expression>`” with an expression that evaluates to a data type. The following expressions are allowed:
  - Alias type from the MATLAB workspace, as described in “Creating a Data Type Alias”.
  - `fixdt` function to create a `Simulink.NumericType` object describing a fixed-point or floating-point data type
  - `type` (Stateflow) operator, to base the type on previously defined data

## Specifying Fixed-Point Designer Data Properties

MATLAB Function blocks can represent signals and parameter values as fixed-point numbers. To simulate models that use fixed-point data in MATLAB Function blocks, you must install the Fixed-Point Designer product on your system.

You can set the following fixed-point properties:

**Signedness.** Select whether you want the fixed-point data to be **Signed** or **Unsigned**. Signed data can represent positive and negative quantities. Unsigned data represents positive values only. The default is **Signed**.

**Word length.** Specify the size (in bits) of the word that will hold the quantized integer. Large word sizes represent large quantities with greater precision than small word sizes. Word length can be any integer between 0 and 128 bits. The default is 16.

**Scaling.** Specify the method for scaling your fixed point data to avoid overflow conditions and minimize quantization errors. You can select the following scaling modes:

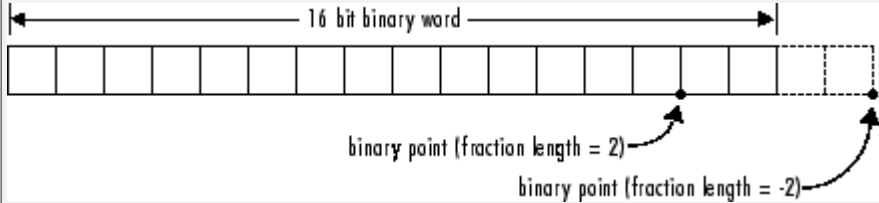
Scaling Mode	Description
Binary point (default)	<p>If you select this mode, the Data Type Assistant displays the <b>Fraction Length</b> field, specifying the binary point location.</p> <p>Binary points can be positive or negative integers. A positive integer moves the binary point left of the rightmost bit by that amount. For example, an entry of 2 sets the binary point in front of the second bit from the right. A negative integer moves the binary point further right of the rightmost bit by that amount, as in this example:</p>  <p>The default is 0.</p>
Slope and bias	<p>If you select this mode, the Data Type Assistant displays fields for entering the <b>Slope</b> and <b>Bias</b>.</p> <ul style="list-style-type: none"> <li>• Slope can be any <i>positive</i> real number. The default is 1.0.</li> <li>• Bias can be any real number. The default value is 0.0.</li> </ul> <p>You can enter slope and bias as expressions that contain parameters defined in the MATLAB workspace.</p>

---

**Note:** You should use binary-point scaling whenever possible to simplify the implementation of fixed-point data in generated code. Operations with fixed-point data using binary-point scaling are performed with simple bit shifts and eliminate the expensive code implementations required for separate slope and bias values.

---

**Data type override.** Specify whether the data type override setting is **Inherit** (default) or **Off**.

**Calculate Best-Precision Scaling.** The Simulink software can automatically calculate “best-precision” values for both **Binary point** and **Slope and bias** scaling, based on the **Limit range** properties you specify.

To automatically calculate best precision scaling values:

- 1 Specify **Minimum**, **Maximum**, or both **Limit range** properties.
- 2 Click **Calculate Best-Precision Scaling**.

The Simulink software calculates the scaling values, then displays them in either the **Fraction Length**, or **Slope** and **Bias** fields.

---

**Note:** The **Limit range** properties do not apply to **Constant** or **Parameter** scopes. Therefore, Simulink cannot calculate best-precision scaling for these scopes.

---

**Fixed-point Details.** You can view the following Fixed-point details:

Fixed-point Detail	Description
Representable maximum	The maximum number that can be represented by the chosen data type, sign, word length and fraction length (or data type, sign, slope and bias).
Maximum	The maximum value specified.
Minimum	The minimum value specified.
Representable minimum	The minimum number that can be represented by the chosen data type, sign, word length and fraction length (or data type, sign, slope and bias).

Fixed-point Detail	Description
Precision	The precision for the given word length and fraction length (or slope and bias).

### Using Data Type Override with the MATLAB Function Block

If you set the Data Type Override mode to **Double** or **Single** in Simulink, the MATLAB Function block sets the type of all inherited input signals and parameters to `fi_double` or `fi_single` objects respectively (see “MATLAB Function Block with Data Type Override” (Fixed-Point Designer) for more information). You must check the data types of your inherited input signals and parameters and use the Ports and Data Manager (see “Ports and Data Manager” on page 40-36) to set explicit types for any inputs that should not be fixed-point. Some operations, such as `sin`, are not applicable to fixed-point objects.

---

**Note:** If you do not set the correct input types explicitly, you may encounter compilation problems after setting Data Type Override.

---

### How Do I Set Data Type Override?

To set Data Type Override, follow these steps:

- 1 From the Simulink **Analysis** menu, select **Fixed-Point Tool**.
- 2 Set the value of the **Data type override** parameter to **Double** or **Single**.

### Related Examples

- “Add Parameter Arguments” on page 40-72

### More About

- “MATLAB Function Block Editor” on page 40-34
- “Size Function Arguments” on page 40-68

## Size Function Arguments

### In this section...

“Specifying Argument Size” on page 40-68

“Inheriting Argument Sizes from Simulink” on page 40-68

“Specifying Argument Sizes with Expressions” on page 40-69

### Specifying Argument Size

To examine or specify the size of an argument, follow these steps:

- 1 From the MATLAB Function Block Editor, select **Edit Data**.
- 2 Enter the size of the argument in the **Size** field of the Data properties dialog, located in the **General** pane.

---

**Note:** The default value is -1, indicating that size is inherited, as described in “Inheriting Argument Sizes from Simulink” on page 40-68.

---

### Inheriting Argument Sizes from Simulink

Size defaults to -1, which means that the data argument inherits its size from Simulink based on its scope:

For Scope	Inherits Size
Input	From the Simulink input signal connected to the argument.
Output	From the Simulink output signal connected to the argument.
Parameter	From the Simulink or MATLAB parameter to which it is bound. See “Add Parameter Arguments” on page 40-72.

After you compile the model, the **Compiled Size** column in the **Contents** pane displays the actual size used in the compiled simulation application.

The size of an output argument is the size of the value that is assigned to it. If the expected size in the Simulink model does not match, a mismatch error occurs during compilation of the model.

---

**Note:** No arguments with inherited sizes are allowed for MATLAB Function blocks in a library.

---

## Specifying Argument Sizes with Expressions

The size of a data argument can be a scalar value or a MATLAB vector of values.

To specify size as a scalar, set the **Size** field to 1 or leave it blank. To specify **Size** as a vector, enter an array of up to two dimensions in [row column] format where

- Number of dimensions equals the length of the vector.
- Size of each dimension corresponds to the value of each element of the vector.

For example, a value of [2 4] defines a 2-by-4 matrix. To define a row vector of size 5, set the **Size** field to [1 5]. To define a column vector of size 6, set the **Size** field to [6 1] or just 6. You can enter a MATLAB expression for each [row column] element in the **Size** field. Each expression can use one or more of the following elements:

- Numeric constants
- Arithmetic operators, restricted to +, -, \*, and /
- Parameters
- Calls to the MATLAB functions `min`, `max`, and `size`

The following examples are valid expressions for **Size**:

```
k+1
size(x)
min(size(y),k)
```

In these examples, `k`, `x`, and `y` are variables of scope `Parameter`.

Once you build the model, the **Compiled Size** column displays the actual size used in the compiled simulation application.

## Related Examples

- “Add Parameter Arguments” on page 40-72

## More About

- “MATLAB Function Block Editor” on page 40-34

- “Type Function Arguments” on page 40-61



## Units in MATLAB Function Blocks

### In this section...

“Units for Input and Output Data” on page 40-71

“Consistency Checking” on page 40-71

“Units for Stateflow Limitations” on page 40-71

### Units for Input and Output Data

MATLAB Function blocks support the specification of physical units as properties for data inputs and outputs. Specify units by using the **Unit (e.g., m, m/s<sup>2</sup>, N\*m)** parameter. When you start typing in the unit field, this parameter provides matching suggestions for units that Simulink supports. By default, the property is set to inherit the unit from the Simulink signal on the corresponding input or output port. If you select the **Data must resolve to Simulink signal object** property for output data, you cannot specify units. In this case, output data is assigned the same unit type as the Simulink signal connected to the output port.

To display the units on the Simulink lines in the model, select **Display > Signals and Ports > Port Units**.

### Consistency Checking

MATLAB Function blocks check the consistency of the signal line unit from Simulink with the unit setting for the corresponding input or output data in the block. If the units do not match, Simulink displays a warning during model update.

### Units for Stateflow Limitations

The unit property settings do not affect the execution of the MATLAB Function block. Simulink checks only consistency with the corresponding Simulink signal line connected to the input or output. It does not check consistency of assignments inside the MATLAB Function blocks. For example, Simulink does not warn against an assignment of an input with unit set to ft to an output with unit set to m. A MATLAB Function block does not perform unit conversions.

### More About

- “Unit Specification in Simulink Models” on page 9-2

## Add Parameter Arguments

Parameter arguments for MATLAB Function blocks do not take their values from signals in the Simulink model. Instead, Simulink searches up the workspace hierarchy. Simulink first looks in a masked workspace if the MATLAB Function block or a parent subsystem is masked. If the value is not found, it next looks in the model workspace and then the MATLAB base workspace.

You can provide a custom interface for parameters by masking the MATLAB Function block. Creating a mask for a block allows you to define the access for each parameter.

- 1 In the MATLAB Function Block Editor, add an argument to the function header of the MATLAB Function block. The name of the argument must match the name of the masked parameter or MATLAB variable that you want to pass to the MATLAB Function block.

The new argument appears as an input port on the MATLAB Function block in the model.

- 2 In the MATLAB Function Block Editor, click **Edit Data**.
- 3 Select the new argument.
- 4 Set **Scope** to **Parameter** and click **Apply**.

The input port for the parameter argument no longer appears in the MATLAB Function block.

---

**Note:** Parameter arguments appear as arguments in the function header of the MATLAB Function block to maintain MATLAB consistency. As a result, you can test functions in a MATLAB Function block by copying and pasting them to MATLAB.

---

### More About

- “Masking Fundamentals” on page 37-2
- “What Is a MATLAB Function Block?” on page 40-5
- “MATLAB Function Block Editor” on page 40-34

## Resolve Signal Objects for Output Data

### In this section...

“Implicit Signal Resolution” on page 40-73

“Eliminating Warnings for Implicit Signal Resolution in the Model” on page 40-73

“Disabling Implicit Signal Resolution for a MATLAB Function Block” on page 40-73

“Forcing Explicit Signal Resolution for an Output Data Signal” on page 40-74

### Implicit Signal Resolution

MATLAB Function blocks participate in signal resolution with Simulink signal objects. By default, output data from MATLAB Function blocks become associated with Simulink signal objects of the same name during a process called *implicit signal resolution*.

By default, implicit signal resolution generates a warning when you update the chart in the Simulink model. The following sections show you how to manage implicit signal resolution at various levels of the model hierarchy. See “Symbol Resolution” on page 57-118 and “Explicit and Implicit Symbol Resolution” on page 57-121 for more information.

### Eliminating Warnings for Implicit Signal Resolution in the Model

To enable implicit signal resolution for all signals in a model, but eliminate the attendant warnings, follow these steps:

- 1 In the Simulink Editor, select **Simulation > Model Configuration Parameters**.

The Configuration Parameters dialog appears.

- 2 In the left pane of the Configuration Parameters dialog, under Diagnostics, select **Data Validity**.

Data Validity configuration parameters appear in the right pane.

- 3 In the Signal resolution field, select **Explicit and implicit**.

### Disabling Implicit Signal Resolution for a MATLAB Function Block

To disable implicit signal resolution for a MATLAB Function block in your model, follow these steps:

- 1 Right-click the MATLAB Function block and select **Block Parameters (Subsystem)** in the context menu.

The Block Parameters dialog opens.

- 2 In the Permit hierarchical resolution field, select **ExplicitOnly** or **None**, and click **OK**.

## Forcing Explicit Signal Resolution for an Output Data Signal

To force signal resolution for an output signal in a MATLAB Function block, follow these steps:

- 1 In the Simulink model, right-click the signal line connected to the output that you want to resolve and select **Properties** from the context menu.
- 2 In the Signal Properties dialog, enter a name for the signal that corresponds to the signal object.
- 3 Select the **Signal name must resolve to Simulink signal object** check box and click **OK**.

### See Also

Simulink.Signal

### More About

- “Symbol Resolution” on page 57-118

## Types of Structures in MATLAB Function Blocks

In MATLAB Function blocks, you can define structure data as inputs or outputs that interact with bus signals. MATLAB Function blocks also support arrays of buses. You can also define structures inside MATLAB functions that are not part of MATLAB Function blocks.

The following table summarizes how to create different types of structures in MATLAB Function blocks:

Scope	How to Create	Details
Input	Create structure data with scope of Input.	You can create structure data as inputs or outputs in the top-level MATLAB function for interfacing to other environments. See “Create Structures in MATLAB Function Blocks” on page 40-82.
Output	Create structure data with scope of Output.	
Local	Create a local variable implicitly in a MATLAB function.	See “Define Scalar Structures for Code Generation” on page 49-4.
Persistent	Declare a variable to be persistent in a MATLAB function.	See <b>persistent</b> .
Parameter	Create structure data with scope of Parameter.	See “Define and Use Structure Parameters” on page 40-89.

Structures in MATLAB Function blocks can contain fields of any type and size, including muxed signals, buses, and arrays of structures.

### Related Examples

- “Combine Buses into an Array of Buses” on page 63-110

### More About

- “What Is a MATLAB Function Block?” on page 40-5
- “Structure Definition for Code Generation” on page 49-2

## Attach Bus Signals to MATLAB Function Blocks



For an example of how to use structures in a MATLAB Function block, open the model `emldemo_bus_struct`.

In this model, a MATLAB Function block receives a bus signal using the structure `inbus` at input port 1 and outputs two bus signals from the structures `outbus` at output port 1 and `outbus1` at output port 2. The input signal comes from the Bus Creator block `MainBusCreator`, which bundles signals `ele1`, `ele2`, and `ele3`. The signal `ele3` is the output of another Bus Creator block `SubBusCreator`, which bundles the signals `a1` and `a2`. The structure `outbus` connects to a Bus Selector block `BusSelector1`; the structure `outbus1` connects to another Bus Selector block `BusSelector3`.

To explore the MATLAB function `fcn`, double-click the MATLAB Function block. Notice that the code implicitly defines a local structure variable `mystruct` using the `struct` function, and uses this local structure variable to initialize the value of the first output `outbus`. It initializes the second output `outbus1` to the value of field `ele3` of structure `inbus`.

### Structure Definitions in Example

Here are the definitions of the structures in the MATLAB Function block in the example, as they appear in the Ports and Data Manager:

	Name	Scope	Port	Resolve Signal	Data Type	Size
	<code>inbus</code>	Input	1		Inherit: Same as Simulink	-1
	<code>outbus</code>	Output	1	<input type="checkbox"/>	Bus: MainBus	1
	<code>outbus1</code>	Output	2	<input type="checkbox"/>	Bus: SubBus	1

### Bus Objects Define Structure Inputs and Outputs

Each structure input and output must be defined by a `Simulink.Bus` object in the base workspace (see “Create Structures in MATLAB Function Blocks” on page 40-82). This means that the structure shares the same properties as the bus object, including number, name, type, and sequence of fields. In this example, the following bus objects define the structure inputs and outputs:

Name	Data Type	Complexity	Dimensions	Dimensionality
ele1	double	real	1	Fixed
ele2	single	real	1	Fixed
ele3(SubBus)	SubBus	real	1	Fixed

The `Simulink.Bus` object `MainBus` defines structure input `inbus` and structure output `outbus`. The `Simulink.Bus` object `SubBus` defines structure output `outbus1`. Based on these definitions, `inbus` and `outbus` have the same properties as `MainBus` and, therefore, reference their fields by the same names as the fields in `MainBus`, using dot notation (see “Index Substructures and Fields” on page 40-80). Similarly, `outbus1` references its fields by the same names as the fields in `SubBus`. Here are the field references for each structure in this example:

Structure	First Field	Second Field	Third Field
<code>inbus</code>	<code>inbus.ele1</code>	<code>inbus.ele2</code>	<code>inbus.ele3</code>
<code>outbus</code>	<code>outbus.ele1</code>	<code>outbus.ele2</code>	<code>outbus.ele3</code>
<code>outbus1</code>	<code>outbus1.a1</code>	<code>outbus1.a2</code>	—

## Related Examples

- “Create Structures in MATLAB Function Blocks” on page 40-82

## More About

- “What Is a MATLAB Function Block?” on page 40-5
- “Structure Definition for Code Generation” on page 49-2

## How Structure Inputs and Outputs Interface with Bus Signals

Buses in a Simulink model appear inside the MATLAB Function block as structures; structure outputs from the MATLAB Function block appear as buses in Simulink models. When you create structure inputs, the MATLAB Function block determines the type, size, and complexity of the structure from the input signal. When you create structure outputs, you must define their type, size, and complexity in the MATLAB function.

You connect structure inputs and outputs from MATLAB Function blocks to any bus signal, including:

- Blocks that output bus signals — such as Bus Creator blocks
- Blocks that accept bus signals as input — such as Bus Selector and Gain blocks
- S-Function blocks
- Other MATLAB Function blocks

You can use global bus type data in Data Store Memory blocks with MATLAB Function blocks. For more information on using buses and Data Store Memory, see “Data Stores with Buses and Arrays of Buses” on page 60-30.

### Working with Virtual and Nonvirtual Buses

MATLAB Function blocks supports nonvirtual buses only (see “Virtual and Nonvirtual Buses” on page 63-4). For MATLAB Function block bus inputs, incoming virtual bus signals are converted to nonvirtual buses.

### Related Examples

- “Create Structures in MATLAB Function Blocks” on page 40-82

### More About

- “What Is a MATLAB Function Block?” on page 40-5
- “Structure Definition for Code Generation” on page 49-2



## Rules for Defining Structures in MATLAB Function Blocks

Follow these rules when defining structures in MATLAB Function blocks:

- For each structure input or output in a MATLAB Function block, you must define a `Simulink.Bus` object in the base workspace to specify its type.
- MATLAB Function blocks support nonvirtual buses only.

### See Also

`Simulink.Bus`

### Related Examples

- “Create Structures in MATLAB Function Blocks” on page 40-82

### More About

- “What Is a MATLAB Function Block?” on page 40-5
- “Structure Definition for Code Generation” on page 49-2
- “Working with Virtual and Nonvirtual Buses” on page 40-78

## Index Substructures and Fields

As in MATLAB, you index substructures and fields structures in MATLAB Function blocks by using dot notation. However, for code generation from MATLAB, you must reference field values individually (see “Structure Definition for Code Generation” on page 49-2).

For example, in the `emldemo_bus_struct` model described in “Attach Bus Signals to MATLAB Function Blocks” on page 40-76, the MATLAB function uses dot notation to index fields and substructures:

```
function [outbus, outbus1] = fcn(inbus)
%#codegen
substruct.a1 = inbus.ele3.a1;
substruct.a2 = int8([1 2;3 4]);

mystruct = struct('ele1',20.5,'ele2',single(100),
                 'ele3',substruct);

outbus = mystruct;
outbus.ele3.a2 = 2*(substruct.a2);

outbus1 = inbus.ele3;
```

The following table shows how the code generation software resolves symbols in dot notation for indexing elements of the structures in this example:

Dot Notation	Symbol Resolution
<code>substruct.a1</code>	Field <code>a1</code> of local structure <code>substruct</code>
<code>inbus.ele3.a1</code>	Value of field <code>a1</code> of field <code>ele3</code> , a substructure of structure <code>inputinbus</code>
<code>inbus.ele3.a2(1,1)</code>	Value in row 1, column 1 of field <code>a2</code> of field <code>ele3</code> , a substructure of structure <code>input inbus</code>

### Related Examples

- “Create Structures in MATLAB Function Blocks” on page 40-82

### More About

- “What Is a MATLAB Function Block?” on page 40-5

- “Structure Definition for Code Generation” on page 49-2

## Create Structures in MATLAB Function Blocks

Here is the workflow for creating a structure in a MATLAB Function block:

- 1 Decide on the type (or scope) of the structure (see “Types of Structures in MATLAB Function Blocks” on page 40-75).
- 2 Based on the scope, follow these guidelines for creating the structure:

For Structure Scope:	Follow These Steps:
Input	<p><b>a</b> Create a <code>Simulink.Bus</code> object in the base workspace to define the structure input.</p> <p><b>b</b> Add data to the MATLAB Function block, as described in “Adding Data to a MATLAB Function Block” on page 40-41. The data should have the following properties</p> <ul style="list-style-type: none"> <li>• <b>Scope</b> = Input</li> <li>• <b>Type</b> = Bus: &lt;object name&gt;</li> </ul> <p>For &lt;object name&gt;, enter the name of the <code>Simulink.Bus</code> object that defines the structure input</p> <p>See “Rules for Defining Structures in MATLAB Function Blocks” on page 40-79.</p>
Output	<p><b>a</b> Create a <code>Simulink.Bus</code> object in the base workspace to define the structure output.</p> <p><b>b</b> Add data to the MATLAB Function block with the following properties:</p> <ul style="list-style-type: none"> <li>• <b>Scope</b> = Output</li> <li>• <b>Type</b> = Bus: &lt;object name&gt;</li> </ul> <p>For &lt;object name&gt;, enter the name of the <code>Simulink.Bus</code> object that defines the structure output</p> <p><b>c</b> Define and initialize the output structure implicitly as a variable in the MATLAB function, as described in “Structure Definition for Code Generation” on page 49-2.</p> <p><b>d</b> Make sure the number, type, and size of fields in the output structure variable definition match the properties of the <code>Simulink.Bus</code> object.</p>

<b>For Structure Scope:</b>	<b>Follow These Steps:</b>
Local	Define the structure implicitly as a local variable in the MATLAB function, as described in “Structure Definition for Code Generation” on page 49-2. By default, local variables in MATLAB Function blocks are temporary.
Persistent	Define the structure implicitly as a persistent variable in the MATLAB function.
Parameter	<p><b>a</b> Create a structure variable in the base workspace.</p> <p><b>b</b> Add data to the MATLAB Function block with the following properties:</p> <ul style="list-style-type: none"><li>• <b>Name</b> = same name as the structure variable you created in step 1.</li><li>• <b>Scope</b> = Parameter</li></ul> <p>See “Define and Use Structure Parameters” on page 40-89.</p>

## More About

- “What Is a MATLAB Function Block?” on page 40-5
- “Structure Definition for Code Generation” on page 49-2

## Assign Values to Structures and Fields

You can assign values to any structure, substructure, or field in a MATLAB Function block. Here are the guidelines:

Operation	Conditions
Assign one structure to another structure	You must define each structure with the same number, type, and size of fields, either as <code>Simulink.Bus</code> objects in the base workspace or locally as implicit structure declarations (see “Create Structures in MATLAB Function Blocks” on page 40-82).
Assign one structure to a substructure of a different structure and vice versa	You must define the structure with the same number, type, and size of fields as the substructure, either as <code>Simulink.Bus</code> objects in the base workspace or locally as implicit structure declarations.
Assign an element of one structure to an element of another structure	The elements must have the same type and size.

For example, the following table presents valid and invalid structure assignments based on the specifications for the model described in “Attach Bus Signals to MATLAB Function Blocks” on page 40-76:

Assignment	Valid or Invalid?	Rationale
<code>outbus = mystruct;</code>	Valid	Both <code>outbus</code> and <code>mystruct</code> have the same number, type, and size of fields. The structure <code>outbus</code> is defined by the <code>Simulink.Bus</code> object <code>MainBus</code> and <code>mystruct</code> is defined locally to match the field properties of <code>MainBus</code> .
<code>outbus = inbus;</code>	Valid	Both <code>outbus</code> and <code>inbus</code> are defined by the same <code>Simulink.Bus</code> object, <code>MainBus</code> .
<code>outbus1 = inbus.ele3;</code>	Valid	Both <code>outbus1</code> and <code>inbus.ele3</code> have the same type and size because each is defined by the <code>Simulink.Bus</code> object <code>SubBus</code> .

Assignment	Valid or Invalid?	Rationale
<code>outbus1 = inbus;</code>	Invalid	The structure <code>outbus1</code> is defined by a different <code>Simulink.Bus</code> object than the structure <code>inbus</code> .

### Related Examples

- “Create Structures in MATLAB Function Blocks” on page 40-82

### More About

- “What Is a MATLAB Function Block?” on page 40-5
- “Structure Definition for Code Generation” on page 49-2

## Initialize a Matrix Using a Nontunable Structure Parameter

The following simple example uses a nontunable structure parameter input to initialize a matrix output. The model looks like this:

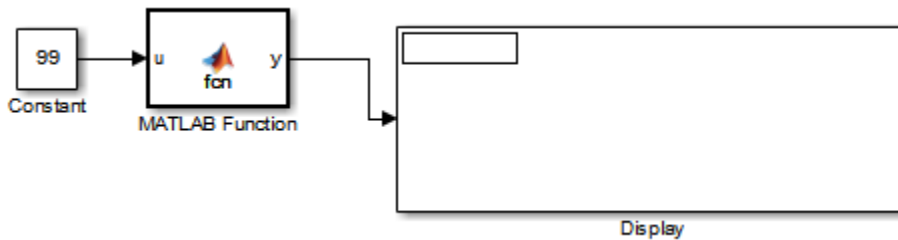

This model defines a structure variable `p` in its pre-load callback function, as follows:



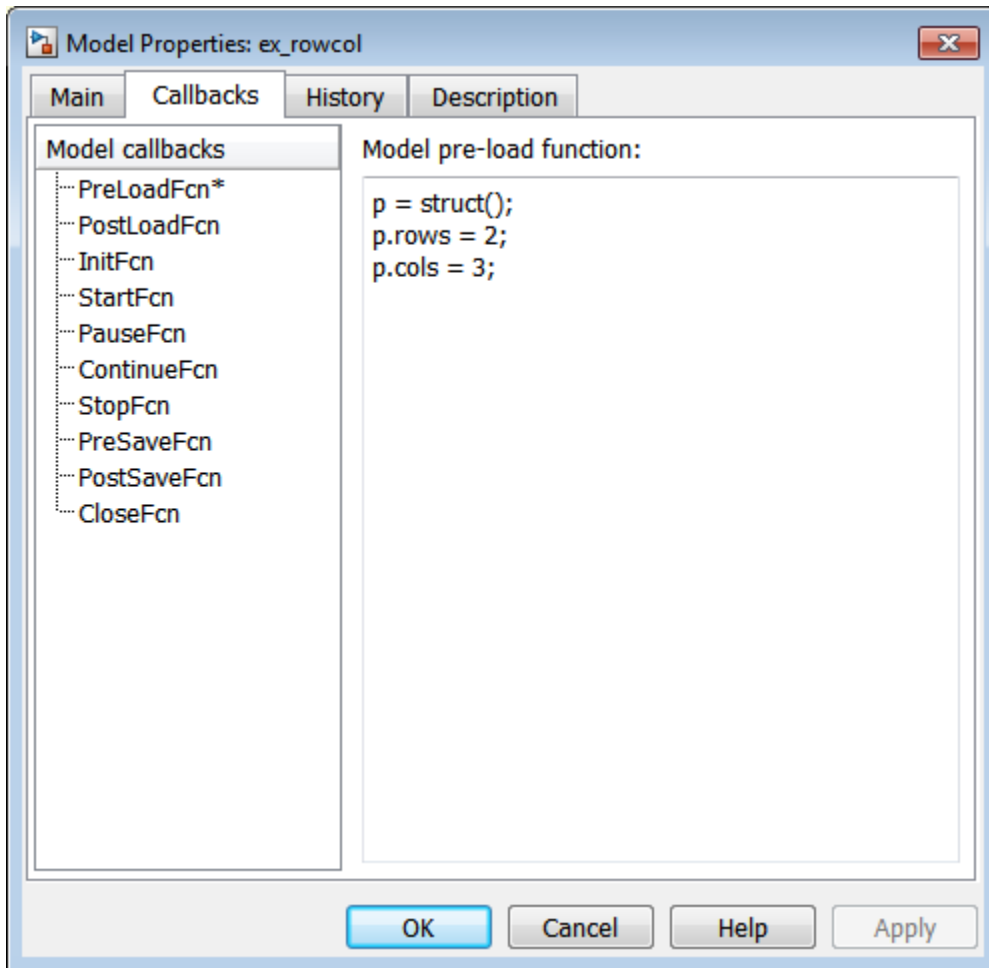

The structure `p` has two fields, `rows` and `cols`, which specify the dimensions of a matrix. The MATLAB Function block uses a constant input `u` to initialize the matrix output `y`. Here is the code:

```
function y = fcn(u, p)
y = zeros(p.rows,p.cols) + u;
```

Running the model initializes each element of the 2-by-3 matrix `y` to 99, the value of `u`:

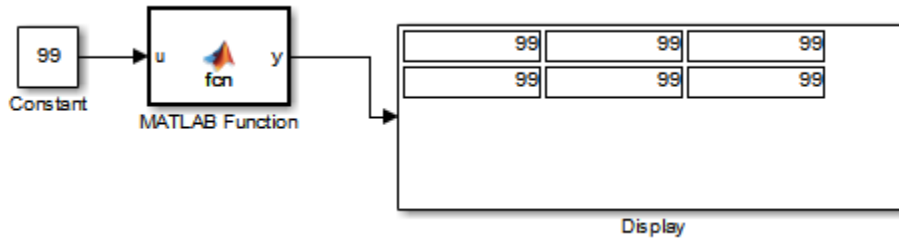

## Related Examples

- “Create Structures in MATLAB Function Blocks” on page 40-82

## More About

- “What Is a MATLAB Function Block?” on page 40-5
- “Structure Definition for Code Generation” on page 49-2
- “Define and Use Structure Parameters” on page 40-89

## Define and Use Structure Parameters

### In this section...

“Defining Structure Parameters” on page 40-89

“FIMATH Properties of Nontunable Structure Parameters” on page 40-89

### Defining Structure Parameters

To define structure parameters in MATLAB Function blocks, follow these steps:

- 1 Define and initialize a structure variable

A common method is to create a structure in the base workspace.

- 2 In the Ports and Data Manager, add data in the MATLAB Function block with the following properties:

Property	What to Specify
Name	Enter same name as the structure variable you defined in the base workspace
Scope	Select Parameter
Tunable	Leave checked if you want to change (tune) the value of the parameter during simulation; otherwise, clear to make the parameter nontunable and preserve the initial value during simulation
Type	Select Inherit: Same as Simulink

- 3 Click **Apply**.

### FIMATH Properties of Nontunable Structure Parameters

FIMATH properties for nontunable structure parameters containing fixed-point values are based on the initial values of the structure. They do *not* come from the FIMATH properties specified for fixed-point input signals to the parent MATLAB Function block. (These FIMATH properties appear in the properties dialog box for MATLAB Function blocks.)

## **Related Examples**

- “Create Structures in MATLAB Function Blocks” on page 40-82

## **More About**

- “What Is a MATLAB Function Block?” on page 40-5
- “Structure Definition for Code Generation” on page 49-2
- “Organize Related Block Parameter Definitions in Structures” on page 35-22

## Limitations of Structures and Buses in MATLAB Function Blocks

- Structures in MATLAB Function blocks support a subset of the operations available for MATLAB structures (see “Structures”).
- You cannot use variable-size data with arrays of buses (see “Array of Buses Requirements and Limitations” on page 63-115).

### Related Examples

- “Create Structures in MATLAB Function Blocks” on page 40-82
- “Define and Use Structure Parameters” on page 40-89

### More About

- “What Is a MATLAB Function Block?” on page 40-5
- “Structure Definition for Code Generation” on page 49-2

## Control Support for Variable-Size Arrays in a MATLAB Function Block

By default, support for variable-size arrays is enabled for a MATLAB Function block. To disable this support:

- 1** In the MATLAB Function Block Editor, select **Edit Data**.
- 2** Clear the **Support variable-size arrays** check box.

### More About

- “What Is a MATLAB Function Block?” on page 40-5
- “MATLAB Function Block Editor” on page 40-34
- “Declare Variable-Size Inputs and Outputs” on page 40-93
- “Code Generation for Variable-Size Arrays” on page 48-2

## Declare Variable-Size Inputs and Outputs

By default, a MATLAB Function block input signal or output signal is not variable-size. To make the signal variable-size:

- 1 In the MATLAB Function Block Editor, select **Edit Data**.
- 2 Select the input or output signal.
- 3 Select the **Variable size** check box.
- 4 Enter the size according to this table.

For:	Specify
Input	To inherit the size from Simulink, enter - 1.  Otherwise, specify the explicit size and upper bound. For example, to specify a 2-by-4 matrix, enter [2 4].
Output	Specify the explicit size and upper bound.

### More About

- “What Is a MATLAB Function Block?” on page 40-5
- “MATLAB Function Block Editor” on page 40-34
- “Control Support for Variable-Size Arrays in a MATLAB Function Block” on page 40-92
- “Code Generation for Variable-Size Arrays” on page 48-2
- “Use a Variable-Size Signal in a Filtering Algorithm” on page 40-94

## Use a Variable-Size Signal in a Filtering Algorithm

### In this section...

“About the Example” on page 40-94

“Simulink Model” on page 40-94

“Source Signal” on page 40-95

“MATLAB Function Block: uniquify” on page 40-95

“MATLAB Function Block: avg” on page 40-97

“Variable-Size Results” on page 40-98

### About the Example

This example uses a variable-size vector to store the values of a white noise signal. The size of the vector can vary at run time because the signal values get pruned by functions that:

- Filter out signal values that are not unique within a specified tolerance of each other.
- Average every two signal values and output only the resulting means.

### Simulink Model

Open the example model by typing `emldemo_process_signal` at the MATLAB command prompt. The model contains the following blocks:

Simulink Block	Description
Band-Limited White Noise	Generates a set of normally distributed random values as the source of the white noise signal.
MATLAB Function <code>uniquify</code>	Filters out signal values that are not unique to within a specified tolerance of each other.
MATLAB Function <code>avg</code>	Outputs the average of a specified number of unique signal values.
Unique values	Scope that displays the unique signal values output from the <code>uniquify</code> function.



Simulink Block	Description
Average values	Scope that displays the average signal values output from the <code>avg</code> function.

## Source Signal

The band-limited white noise signal has these properties:

**Parameters**

Noise power:

Sample time:

Seed:

Interpret vector parameters as 1-D

The size of the noise power value defines the size of the array that holds the signal values. This array is a 1-by-9 vector of double values.

## MATLAB Function Block: `uniquify`

This block filters out signal values that are not within a tolerance of 0.2 of each other. Here is the code:

```
function y = uniquify(u) %#codegen
y = emldemo_uniquetol(u,0.2);
```

The `uniquify` function calls an external MATLAB function `emldemo_uniquetol` to filter the signal values. `uniquify` passes the 1-by-9 vector of white noise signal values as the first argument and the tolerance value as the second argument. Here is the code for `emldemo_uniquetol`:

```
function B = emldemo_uniquetol(A,tol) %#codegen
```

```

A = sort(A);
coder.varsize('B',[1 100]);
B = A(1);
k = 1;
for i = 2:length(A)
    if abs(A(k) - A(i)) > tol
        B = [B A(i)];
        k = i;
    end
end
end

```

`emldemo_uniquetol` returns the filtered values of `A` in an output vector `B` so that  $\text{abs}(B(i) - B(j)) > \text{tol}$  for all `i` and `j`. Every time Simulink samples the Band-Limited White Noise block, it generates a different set of random values for `A`. As a result, `emldemo_uniquetol` may produce a different number of output signals in `B` each time it is called. To allow `B` to accommodate a variable number of elements, `emldemo_uniquetol` declares it as variable-size data with an explicit upper bound:

```
coder.varsize('B',[1 100]);
```

In this statement, `coder.varsize` declares `B` as a vector whose first dimension is fixed at 1 and whose second dimension can grow to a maximum size of 100. Accordingly, output `y` of the `uniquify` block must also be variable-size so that it can pass the values returned from `emldemo_uniquetol` to the **Unique values** scope. Here are the properties of `y`:

**Data y**

General Description

Name:

Scope:  Port:

Data must resolve to Simulink signal object

Size:   Variable size

Complexity:

Sampling mode:

Type:

For variable-size outputs, you must specify an explicit size and upper bound, shown here as [1 9].

## MATLAB Function Block: avg

This block averages signal values filtered by the `uniquify` block as follows:

If number of signal values is	The MATLAB Function block
> 1 and divisible by 2	Averages every consecutive pair of values
> 1 but <i>not</i> divisible by 2	Drops the first (smallest) value and average the remaining consecutive pairs
= 1	Returns the value unchanged

The `avg` function outputs the results to the **Average values** scope. Here is the code:

```
function y = avg(u) %#codegen

if numel(u) == 1
    y = u;
else
    k = numel(u)/2;
    if k ~= floor(k)
        u = u(2:numel(u));
    end
    y = emldemo_navg(u,2);
end
```

Both input `u` and output `y` of `avg` are declared as variable-size vectors because the number of elements varies depending on how the `uniquify` function block filters the signal values. Input `u` inherits its size from the output of `uniquify`.

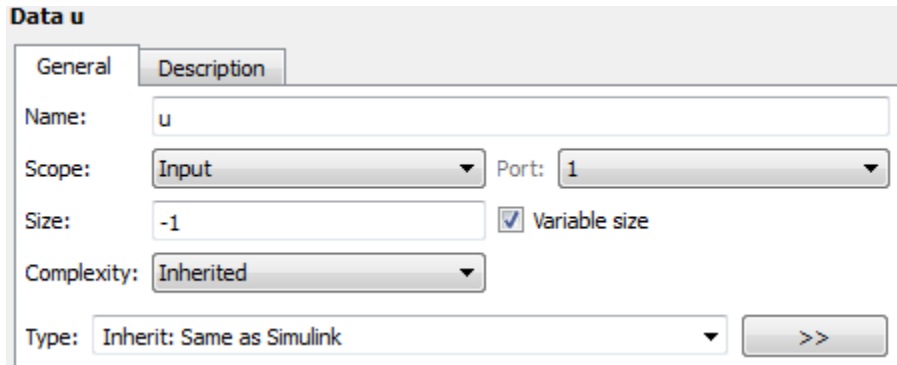

The `avg` function calls an external MATLAB function `emldemo_navg` to calculate the average of every two consecutive signal values. Here is the code for `emldemo_navg`:

```
function B = emldemo_navg(A,n) %#codegen
assert(n>=1 && n<=numel(A));

B = zeros(1,numel(A)/n);
k = 1;
for i = 1 : numel(A)/n
    B(i) = mean(A(k + (0:n-1)));
    k = k + n;
end
```

## Variable-Size Results

Simulating the model produces the following results:

- The `uniquify` block outputs a variable number of signal values each time it executes:

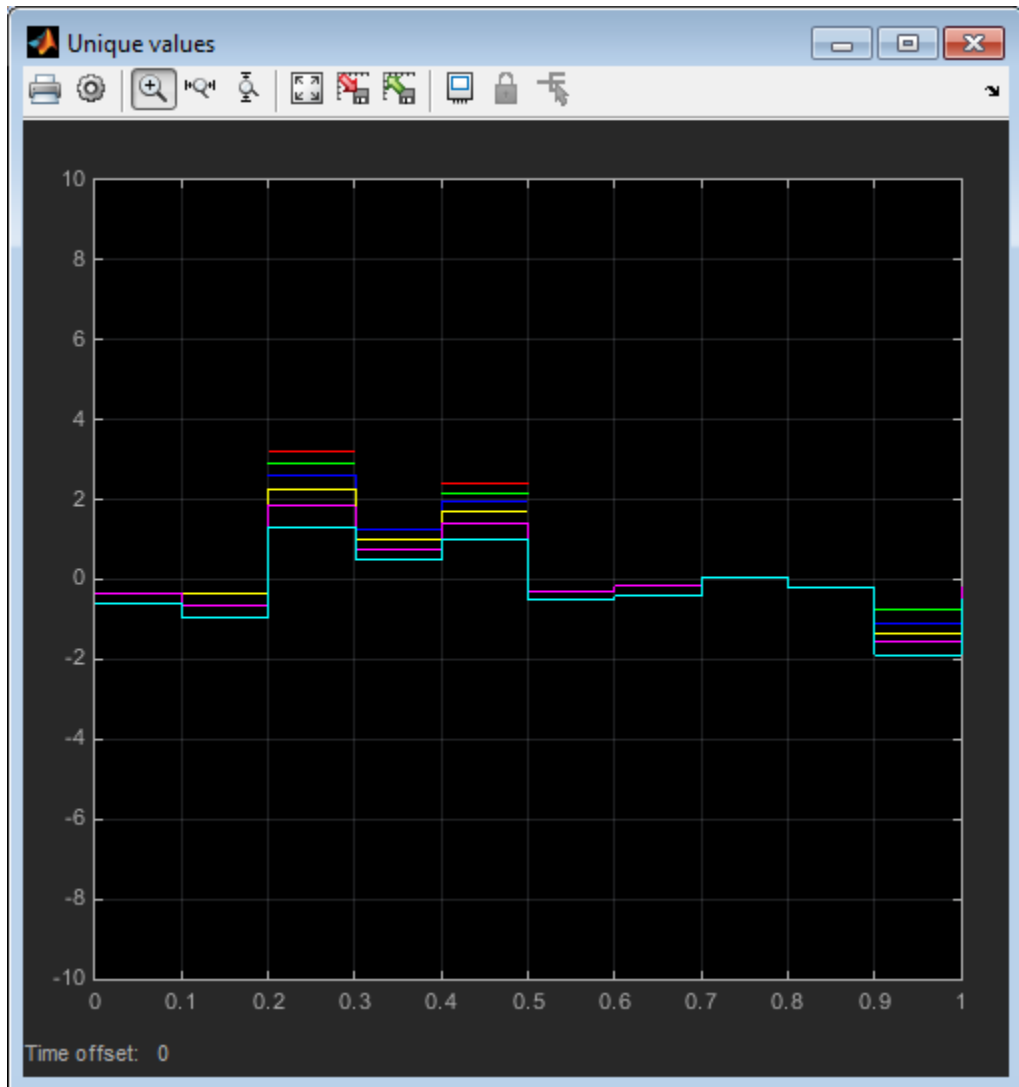

- The avg block outputs a variable number of signal values each time it executes — approximately half the number of the unique values:

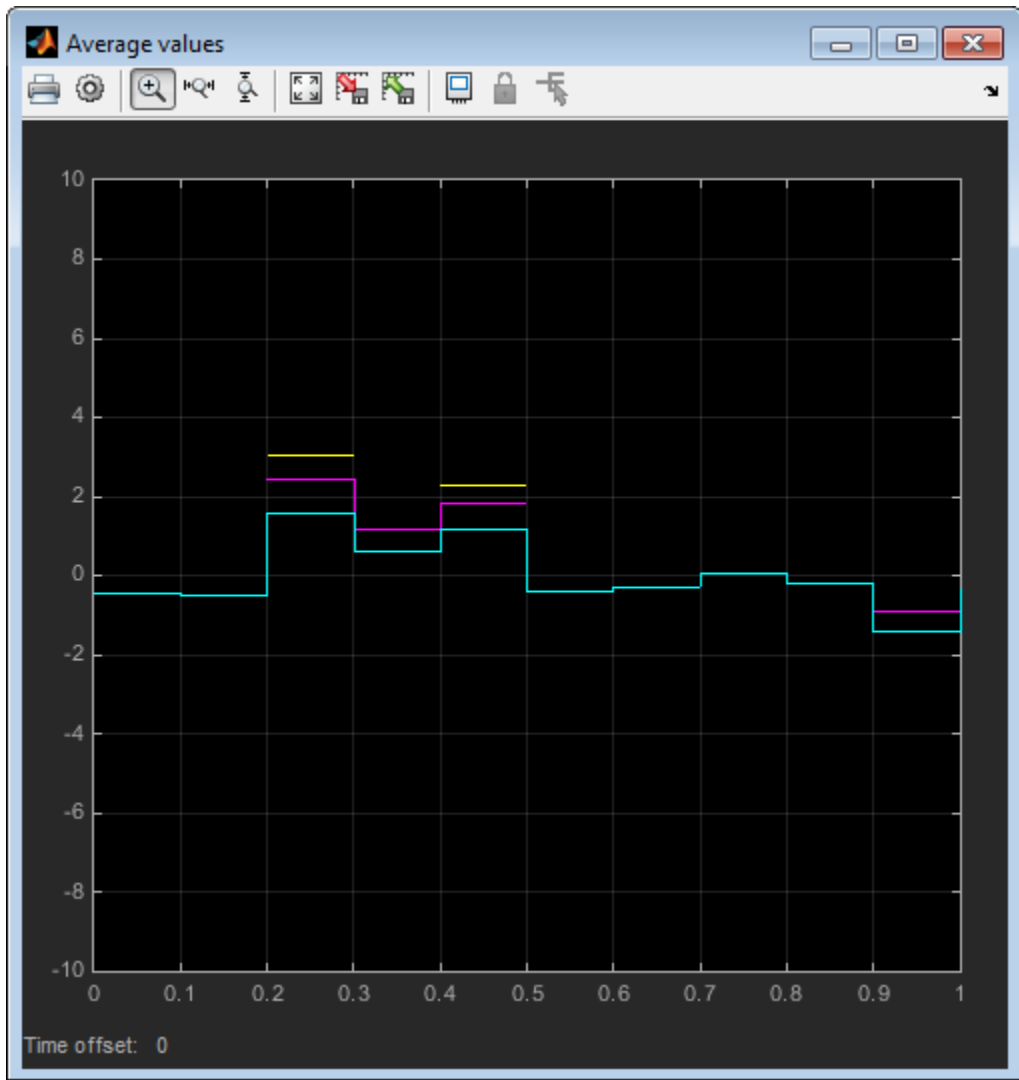

**See Also**

`coder.varsizes`

## **More About**

- “What Is a MATLAB Function Block?” on page 40-5
- “MATLAB Function Block Editor” on page 40-34

## Control Memory Allocation for Variable-Size Arrays in a MATLAB Function Block

Dynamic memory allocation allocates memory on the heap as needed at run time, instead of allocating memory statically on the stack. You can use dynamic memory allocation for arrays inside a MATLAB Function block.

You cannot use dynamic memory allocation for:

- Input and output signals. Variable-size input and output signals must have an upper bound.
- Parameters or global variables. Parameters and global variables must be fixed-size.
- Fields of bus arrays. Bus arrays cannot have variable-size fields.
- Discrete state properties of System objects associated with a MATLAB System block.

Dynamic memory allocation is beneficial when:

- You do not know the upper bound of an array.
- You do not want to allocate memory on the stack for large arrays.

Dynamic memory allocation and the freeing of this memory can result in slower execution of the generated code. To control the use of dynamic memory allocation for variable-size arrays in a MATLAB Function block, you can:

- Provide upper bounds for variable-size arrays.
- Disable dynamic memory allocation for MATLAB Function blocks.
- Modify the dynamic memory allocation threshold.

### Provide Upper Bounds for Variable-Size Arrays

For an unbounded variable-size array, the code generator allocates memory dynamically on the heap. For a bounded variable-size array, if the size, in bytes, is less than the dynamic memory allocation threshold, the code generator allocates memory statically on the stack. To avoid dynamic memory allocation, provide upper bounds for the array dimensions so that the size of the array, in bytes, is less than the dynamic memory allocation threshold. See “Specify Upper Bounds for Variable-Size Arrays” on page 48-5.



## Disable Dynamic Memory Allocation for MATLAB Function Blocks

By default, dynamic memory allocation for MATLAB Function blocks is enabled for GRT-based targets and disabled for ERT-based targets. To change the setting, in the Configuration Parameters dialog box, on the **All Parameters** tab, in the **Simulation Target > Advanced parameters** category, clear or select the **Dynamic memory allocation in MATLAB Function blocks** check box.

If you disable dynamic memory allocation, you must provide upper bounds for variable-size arrays.

## Modify the Dynamic Memory Allocation Threshold

Instead of disabling dynamic memory allocation for all variable-size arrays, you can use the dynamic memory allocation threshold to specify when the code generator uses dynamic memory allocation.

Use the dynamic memory allocation threshold to:

- Disable dynamic memory allocation for smaller arrays. For smaller arrays, static memory allocation can speed up generated code. However, static memory allocation can lead to unused storage space. You can decide that the unused storage space is not a significant consideration for smaller arrays.
- Enable dynamic memory allocation for larger arrays. For larger arrays, when you use dynamic memory allocation, you can significantly reduce storage requirements.

The default value of the dynamic memory allocation threshold is 64 kilobytes. To change the threshold, in the Configuration Parameters dialog box, on the **All Parameters** tab, in the **Simulation Target > Advanced parameters** category, set the **Dynamic memory allocation threshold in MATLAB Function blocks** parameter.

To use dynamic memory allocation for all variable-size arrays, set the threshold to 0.

## More About

- “Code Generation for Variable-Size Arrays” on page 48-2
- “Specify Upper Bounds for Variable-Size Arrays” on page 48-5
- “Use Dynamic Memory Allocation for Variable-Size Arrays in a MATLAB Function Block” on page 40-104

## Use Dynamic Memory Allocation for Variable-Size Arrays in a MATLAB Function Block

This example shows how to use dynamic memory allocation for variable-size arrays in a MATLAB Function block. Dynamic memory allocation allocates memory on the heap as needed at run time, instead of allocating memory statically on the stack. Dynamic memory allocation is beneficial when:

- You do not know the upper bound of an array.
- You do not want to allocate memory on the stack for large arrays.

You can use dynamic memory allocation only for arrays that are local to the MATLAB Function block.

You cannot use dynamic memory allocation for:

- Input and output signals. Variable-size input and output signals must have an upper bound.
- Parameters or global variables. Parameters and global variables must be fixed-size.
- Fields of bus arrays. Bus arrays cannot have variable-size fields.
- Discrete state properties of System objects associated with a MATLAB System block.

### Create Model

Create this Simulink model that has a MATLAB Function block with an unbounded variable-size array.

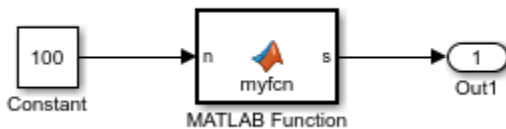

- 1 Create a Simulink model `mymodel`.
- 2 Add a MATLAB Function block to the model.
- 3 In the MATLAB Function block, add this code:

```
function s = myfcn(n)
Z = rand(1,n);
s = sum(Z);
end
```

- 4 Add a Constant block to the left of the MATLAB Function block.
- 5 Add an Outport block to the right of the MATLAB Function block.
- 6 Connect the blocks.

## Configure Model for Dynamic Memory Allocation

Make sure that you configure the model to use dynamic memory allocation for variable-size arrays in MATLAB Function blocks. In the Configuration Parameters dialog box, on the **All Parameters** tab, in the **Simulation Target > Advanced parameters** category, make sure that:

- The **Dynamic memory allocation in MATLAB Function blocks** check box is selected.
- The **Dynamic memory allocation threshold in MATLAB Function blocks** parameter has the default value 65536.

## Simulate Model Using Dynamic Memory Allocation

- 1 Simulate the model.
- 2 In the MATLAB Function Editor, to open the MATLAB Function report, click **View Report**.

The variables tab shows that Z is a 1-by-:? array. The colon (:) indicates that the second dimension is variable-size. The question mark (?) indicates that the second dimension is unbounded.

Simulation must use dynamic memory allocation for Z because the second dimension of Z does not have an upper bound.

## Use Dynamic Memory Allocation for Bounded Arrays

When an array is unbounded, the code generator must use dynamic memory allocation. If an array is bounded, the code generator uses dynamic memory allocation only if the

array size, in bytes, is greater than or equal to the dynamic memory allocation threshold. The default value for this threshold is 65536.

Dynamic memory has a run-time performance cost. By controlling its use, you can improve execution speed.

If you make `Z` a bounded variable-size array with a size that is greater than the threshold, the code generator uses dynamic memory allocation for `Z`. For example:

- 1 In `mymodel`, modify `myfcn` so that `Z` has an upper bound of 500.

```
function s = myfcn(n)
assert(n < 500);
Z = rand(1,n);
s = sum(Z);
end
```

- 2 Simulate the model.

In the MATLAB Function report, you see that `Z` is a 1-by-:500 array. It is variable-size with an upper bound of 500.

- 3 Lower the dynamic memory allocation to a value less than or equal to 4000, which is the size, in bytes, of `Z`. In the Configuration Parameters dialog box, on the **All Parameters** tab, in the **Simulation Target > Advanced parameters** category, set the **Dynamic memory allocation threshold in MATLAB Function blocks** parameter to 4000.
- 4 Simulate the model.

The code generator uses dynamic memory allocation because the size of `Z` is equal to the dynamic memory allocation threshold, 4000.

## Generate C Code That Uses Dynamic Memory Allocation

If you have Simulink Coder, you can generate C code for this model. Then, you can see how the code generator represents dynamically allocated arrays.

- 1 Configure the model to use a fixed-step solver. In the Configuration Parameters dialog box, in the **Solver** pane, under **Solver options**:
  - For **Type**, select **Fixed-step**.
  - For **Solver**, select **discrete (no continuous states)**.

- 2 Configure the model to create and use a code generation report. In the Configuration Parameters dialog box, in the **Code Generation > Report** pane, select **Create code generation report** and **Open report automatically**.
- 3 Edit the code in the MATLAB Function block so that it looks like this code:

```
function s = myfcn(n)
Z = rand(1,n);
s = sum(Z);
end
```

Z is an unbounded variable-size array.

- 4 Make sure that the model is configured for dynamic memory allocation:
  - The **Dynamic memory allocation in MATLAB Function blocks** check box is selected.
  - The **Dynamic memory allocation threshold in MATLAB Function blocks** parameter has the default value 65536.
- 5 Build the model.
- 6 In the code generation report, open `mymodel.c`. You can tell that the code generator used dynamic memory allocation for Z because you see the `emxArray` type `emxArray_real_T_mymodel_T` and `emxArray` utility functions, such as `mymodel_emxInit_real_T`. The code generator uses an `emxArray` type for variables whose memory is dynamically allocated. The generated code uses the `emxArray` utility functions to manage the `emxArrays`.

If you have Embedded Coder, you can customize the identifiers for `emxArray` types and the utility functions. See “Identifier Format Control” (Embedded Coder).

## More About

- “Code Generation for Variable-Size Arrays” on page 48-2
- “Control Memory Allocation for Variable-Size Arrays in a MATLAB Function Block” on page 40-102
- “Identifier Format Control” (Embedded Coder)

## Code Generation for Enumerations

Enumerations represent a fixed set of named values. Enumerations help make your MATLAB code and generated C/C++ code more readable. For example, the generated code can test equality with code such as `if (x == Red)` instead of using `strcmp`. To generate C/C++ code, you must have Simulink Coder.

When you use enumerations in a MATLAB Function block, adhere to these restrictions:

- “Define Enumerations for MATLAB Function Blocks” on page 40-108
- “Use Allowed Operations on Enumerations” on page 40-110
- “Use MATLAB Toolbox Functions That Support Enumerations” on page 40-110

### Define Enumerations for MATLAB Function Blocks

You can define enumerations for MATLAB Function blocks in two ways:

- To import an externally defined enumeration, use the `Simulink.defineIntEnumType` function. See “Import Enumerations Defined Externally to MATLAB” on page 58-12.
- In a class definition file, define an enumerated type. For example:

```
classdef PrimaryColors < Simulink.IntEnumType
    enumeration
        Red(1),
        Blue(2),
        Yellow(4)
    end
end
```

If you define an enumerated type in a class definition file, the class must derive from one of these base types: `Simulink.IntEnumType`, `int8`, `uint8`, `int16`, `uint16`, or `int32`. Then, you can exchange enumerated data between MATLAB Function blocks and other Simulink blocks in a model.

If you use Simulink Coder to generate C/C++ code, you can use the enumeration class base type to control the size of an enumerated type in generated C/C++ code. You can:

- Represent an enumerated type as a fixed-size integer that is portable to different targets.

- Reduce memory usage.
- Interface with legacy code.
- Match company standards.

The base type determines the representation of the enumerated type in generated C/C++ code.

If the base type is `Simulink.IntEnumType`, the code generator produces a C enumeration type. Consider the following MATLAB enumerated type definition:

```
classdef LEDcolor < Simulink.IntEnumType
    enumeration
        GREEN(1),
        RED(2)
    end
end
```

This enumerated type definition results in the following C code:

```
typedef enum {
    GREEN = 1,
    RED
} LEDcolor;
```

For built-in integer base types, the code generator produces a `typedef` statement for the enumerated type and `#define` statements for the enumerated values. Consider the following MATLAB enumerated type definition:

```
classdef LEDcolor < int16
    enumeration
        GREEN(1),
        RED(2)
    end
end
```

This enumerated type definition results in the following C code:

```
typedef int16_T LEDcolor;

#define GREEN ((LEDcolor)1)
#define RED ((LEDcolor)2)
```

To customize the code generated for an enumerated type, see “Customize Simulink Enumeration” on page 58-9.

## Use Allowed Operations on Enumerations

For code generation, you are restricted to the operations on enumerations listed in this table.

Operation	Example
assignment operator, =	<code>xon = LEDcolor.GREEN xoff = LEDcolor.RED</code>
relational operators, < > <= >= == ~=  You cannot use == or ~= to test equality between an enumeration member and a character array or cell array of character arrays.	<code>xon == xoff</code>
cast operation	<code>double(LEDcolor.RED)</code>
indexing operation	<code>m = [1 2] n = LEDcolor(m) p = n(LEDcolor.GREEN)</code>
control flow statements: if, switch, while	<code>if state == sysMode.ON     led = LEDcolor.GREEN; else     led = LEDcolor.RED; end</code>

## Use MATLAB Toolbox Functions That Support Enumerations

For code generation, you can use enumerations with these MATLAB toolbox functions:

- `cast`
- `cat`
- `circshift`
- `fliplr`
- `flipud`
- `histc`
- `intersect`
- `ipermute`



- `isequal`
- `isequaln`
- `isfinite`
- `isinf`
- `ismember`
- `isnan`
- `issorted`
- `length`
- `permute`
- `repmat`
- `reshape`
- `rot90`
- `setdiff`
- `setxor`
- `shiftdim`
- `sort`
- `sortrows`
- `squeeze`
- `union`
- `unique`

## **More About**

- “What Is a MATLAB Function Block?” on page 40-5
- “Add Enumerated Inputs, Outputs, and Parameters to a MATLAB Function Block” on page 40-112
- “Use Enumerations to Control an LED Display” on page 40-113

## Add Enumerated Inputs, Outputs, and Parameters to a MATLAB Function Block

When you add enumerated inputs, outputs, or parameters to a MATLAB Function block, follow these guidelines:

- For inputs, inherit the type from the enumerated type of the connected Simulink signal or specify the enumeration explicitly.
- For outputs, specify the enumerated type explicitly.
- For tunable parameters, specify the enumerated type explicitly. For nontunable parameters, derive properties from an enumerated parameter in a parent Simulink masked subsystem or enumerated variable defined in the MATLAB base workspace.

To add enumerated data to a MATLAB Function block:

- 1 In the MATLAB Function Block Editor, select **Edit Data**.
- 2 In the Ports and Data Manager, select **Add > Data**.
- 3 In the **Name** field, enter a name for the enumerated data.

For parameters, the name must match the enumerated masked parameter or workspace variable name.

- 4 In the **Type** field, specify an enumerated type.
  - For an explicit enumerated type, set **Type** to `Enum:<class name>`. Replace `<class name>` with the name of an enumerated data type that you defined in a MATLAB file on the MATLAB path.

The **Complexity** field is not visible because enumerated data types do not support complex values.

- To inherit the enumerated type from a connected Simulink signal (for inputs only), set **Type** to `Inherit:Same as Simulink`.

### More About

- “What Is a MATLAB Function Block?” on page 40-5
- “Code Generation for Enumerations” on page 40-108
- “Use Enumerations to Control an LED Display” on page 40-113

## Use Enumerations to Control an LED Display

### In this section...

“Simulink Model” on page 40-113

“Enumeration Class Definitions” on page 40-114

“MATLAB Function Block Function” on page 40-114

“Simulation” on page 40-115

This example shows how to use enumerations in a MATLAB Function block. The example shows how MATLAB Function blocks exchange enumerated data with other Simulink blocks.

The `emldemo_led_switch` model uses enumerations to represent the modes of a device that controls the colors of an LED display. The MATLAB Function block receives an enumerated input signal that represents the mode. The enumerated output signal represents the color that the LED displays.

### Simulink Model

To open the model, at the command prompt, enter:

```
emldemo_led_switch
```

The model contains the blocks listed in this table.

Simulink Block	Description
Step	Provides source of the on/off signal. Outputs an initial value of 0 (off) and at 10 seconds steps up to a value of 1 (on).
Data Type Conversion from <code>double</code> to <code>int32</code>	Converts the <code>Step</code> signal of type <code>double</code> to type <code>int32</code> .
Data Type Conversion from <code>int32</code> to enumerated type <code>switchmode</code>	Converts the value of type <code>int32</code> to the enumerated type <code>switchmode</code> .  TheData Type Conversion block parameters have these settings: <ul style="list-style-type: none"> <li>• Output minimum: [ ]</li> </ul>

Simulink Block	Description
	<ul style="list-style-type: none"> <li>• Output maximum: [ ]</li> <li>• Output data type: Enum:switchmode</li> </ul>
MATLAB Function block checkState	Evaluates the enumerated input <code>state</code> to determine the value of the enumerated output <code>ledval</code> . <code>state</code> inherits its enumerated type <code>switchmode</code> from the Simulink step signal. <code>ledval</code> has the type Enum:led.
Display	Displays the value of <code>ledval</code> .

## Enumeration Class Definitions

The `switchmode` enumeration represents the allowed modes for the input to the `checkstate` block.

```
classdef switchmode < Simulink.IntEnumType
    enumeration
        OFF(0)
        ON(1)
    end
end
```

The `led` enumeration represents the colors that the `checkstate` block can output.

```
classdef led < Simulink.IntEnumType
    enumeration
        GREEN(1),
        RED(8)
    end
end
```

Both enumeration classes inherit from the built-in type `Simulink.IntEnumType` and reside on the MATLAB path.

## MATLAB Function Block Function

The function `checkState` uses enumerations to activate an LED display, based on the state of a device. It lights a green LED display to indicate the ON state. It lights a red LED display to indicate the OFF state.

```
function ledval = checkState(state)
    %#codegen

    if state == switchmode.ON
        ledval = led.GREEN;
    else
        ledval = led.RED;
    end
```

## Simulation

When you simulate the model, the Display block displays the state of the LED display. If you simulate the model for less than 10 seconds, the state is off. The Display block displays **RED**. If you simulate the model for more than 10 seconds, the state is on. The Display block displays **GREEN**.

## More About

- “What Is a MATLAB Function Block?” on page 40-5
- “Code Generation for Enumerations” on page 40-108
- “Add Enumerated Inputs, Outputs, and Parameters to a MATLAB Function Block” on page 40-112
- “Enumerations and Scopes” on page 58-5

## Share Data Globally

### In this section...

“When Do You Need to Use Global Data?” on page 40-116

“Using Global Data with the MATLAB Function Block” on page 40-116

“Choosing How to Store Global Data” on page 40-117

“How to Use Data Store Memory Blocks” on page 40-118

“How to Use Simulink.Signal Objects” on page 40-120

“Using Data Store Diagnostics to Detect Memory Access Issues” on page 40-122

“Limitations of Using Shared Data in MATLAB Function Blocks” on page 40-122

### When Do You Need to Use Global Data?

You might need to use global data with a MATLAB Function block if:

- You have multiple MATLAB functions that use global variables and you want to call these functions from MATLAB Function blocks.
- You have an existing model that uses a large amount of global data and you are adding a MATLAB Function block to this model, and you want to avoid cluttering your model with additional inputs and outputs.
- You want to scope the visibility of data to parts of the model.

### Using Global Data with the MATLAB Function Block

In Simulink, you store global data using data store memory. You implement data store memory using either Data Store Memory blocks or Simulink.Signal objects. How you store global data depends on the number and scope of your global variables. For more information, see “Local and Global Data Stores” on page 60-3 and “Choosing How to Store Global Data” on page 40-117.

#### How MATLAB Globals Relate to Data Store Memory

In MATLAB functions in Simulink, global declarations are not mapped to the MATLAB global workspace. Instead, you register global data with the MATLAB Function block to map the data to data store memory. This difference allows global data in MATLAB functions to inter-operate with the Simulink solver and to provide diagnostics if they are misused.

A global variable resolves hierarchically to the closest data store memory with the same name in the model. The same global variable occurring in two different MATLAB Function blocks might resolve to different data store memory depending on the hierarchy of your model. You can use this ability to scope the visibility of data to a subsystem.

### How to Use Globals with the MATLAB Function Block

To use global data in your MATLAB Function block, or in any code that this block calls, you must:

- 1 Declare a global variable in your MATLAB Function block, or in any code that is called by the MATLAB Function block.
- 2 Register a Data Store Memory block or `Simulink.Signal` object that has the same name as the global variable with the MATLAB Function block.

For more information, see “How to Use Data Store Memory Blocks” on page 40-118 and “How to Use Simulink.Signal Objects” on page 40-120.

### Choosing How to Store Global Data

The following table summarizes whether to use Data Store Memory blocks or `Simulink.Signal` objects.

If you want to:	Use:	For more information:
Use a small number of global variables in a single model that does not use model reference.	Data Store Memory blocks.  <b>Note:</b> Using Data Store Memory blocks scopes the data to the model.	“How to Use Data Store Memory Blocks” on page 40-118
Use a large number of global variables in a single model that does not use model reference.	<code>Simulink.Signal</code> objects defined in the model workspace. <code>Simulink.Signal</code> objects offer these advantages: <ul style="list-style-type: none"> <li>• You do not have to add numerous Data Store Memory blocks to your model.</li> </ul>	“How to Use Simulink.Signal Objects” on page 40-120

If you want to:	Use:	For more information:
	<ul style="list-style-type: none"> <li>You can load the <code>Simulink.Signal</code> objects in from a MAT-file.</li> </ul>	
Share data between multiple models (including referenced models).	<p><code>Simulink.Signal</code> objects defined in the base workspace</p> <hr/> <p><b>Note:</b> If you use Data Store Memory blocks as well as <code>Simulink.Signal</code>, note that using Data Store Memory blocks scopes the data to the model.</p>	“How to Use Simulink.Signal Objects” on page 40-120

## How to Use Data Store Memory Blocks

- 1 Add a MATLAB Function block to your model.
- 2 Double-click the MATLAB Function block to open its editor.
- 3 Declare a global variable in the MATLAB Function block code, or in any MATLAB file that the MATLAB Function block code calls. For example:

```
global A;
```

- 4 Add a Data Store Memory block to your model and set the following:
  - a Set the **Data store name** to match the name of the global variable in your MATLAB Function block code.
  - b Set **Data type** to an explicit data type.
 

The data type cannot be `auto`.
  - c Set the **Signal type**.
  - d Specify an **Initial value**.

The initial value of the Data Store Memory block cannot be unspecified.

- 5 Register the variable to the MATLAB Function block.



- a In the Ports and Data Manager, add data with the same name as the global variable.
- b Set the **Scope** of the data to **Data Store Memory**.

For more information on using the Ports and Data Manager, see “Ports and Data Manager” on page 40-36.

### Example: Using Data Store Memory with the MATLAB Function Block

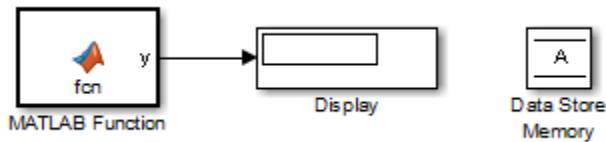

This simple model demonstrates how a MATLAB Function block uses the global data stored in Data Store Memory block A.

- 1 Open the `dsm_demo` model. At the MATLAB command line, enter:
 

```
run(docpath(fullfile(docroot, 'toolbox', 'simulink', 'examples', 'dsm_demo.mdl')))
```
- 2 Double-click the MATLAB Function block to open the MATLAB Function Block Editor.

The MATLAB Function block modifies the value of global data A each time it executes.

```
function y = fcn
%#codegen
global A;
A = A+1;
y = A;
```

- 3 In the MATLAB Function Block Editor, select **Edit Data**.
- 4 In the Ports and Data Manager, select the data A in the left pane.

The Ports and Data Manager displays the data attributes in the right pane. Note that A has a scope of **Data Store Memory**.

- 5 In the model, double-click the Data Store Memory block A.

The Block Parameters dialog box opens. Note that **A** has an initial value of 25.

- 6 Simulate the model.

The MATLAB Function block reads the initial value of global data stored in **A** and updates the value of **A** each time it executes.

## How to Use Simulink.Signal Objects

- 1 Create a `Simulink.Signal` object in the model workspace.

---

**Tip:** Create a `Simulink.Signal` object in the base workspace to use the global data with multiple models.

---

- a In the Model Explorer, navigate to ***model\_name*** > **Model Workspace** in the **Model Hierarchy** pane.
  - b Select **Add > Simulink Signal**.
  - c Ensure that these settings apply to the `Simulink.Signal` object:
    - i Set **Data type** to an explicit data type.

The data type cannot be `auto`.
    - ii Set **Dimensions** to be fully specified.

The signal dimensions cannot be `-1` or `inherited`.
    - iii Set the **Complexity**.
    - iv Specify an **Initial value**.

The initial value of the signal cannot be unspecified.
- 2 Register the `Simulink.Signal` object to the MATLAB Function block.
  - a In the Ports and Data Manager, add data with the same name as the `Simulink.Signal` object you created in the model (or base) workspace.
  - b Set the **Scope** of the data to **Data Store Memory**.
- 3 Declare a global variable with the same name in the code for your MATLAB Function block.

```
global Sig;
```

For more information on using the Ports and Data Manager, see “Ports and Data Manager” on page 40-36.

### Example: Using a Simulink.Signal Object with a MATLAB Function Block

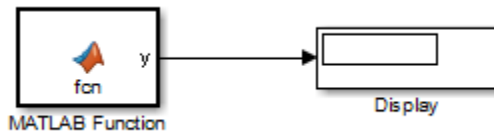

- 1 Open the `simulink_signal_local` model. At the MATLAB command line, enter:

```
addpath(fullfile(docroot, 'toolbox', 'simulink', 'examples'))
simulink_signal_local
```

- 2 Double-click the MATLAB Function block to open its editor.

The MATLAB Function block modifies the value of global data `A` each time it executes.

```
function y = fcn
%#codegen
global A;
A = A+1;
y = A;
```

- 3 From the MATLAB Function Block Editor menu, select **Edit Data**.
- 4 In the Ports and Data Manager, select the data `A` in the left pane.

The Ports and Data Manager displays the data attributes in the right pane. Note that `A` has a scope of **Data Store Memory**.

- 5 From the model menu, select **View > Model Explorer**.
- 6 In the left pane of the Model Explorer, select the model workspace for the `simulink_signal_local` model.

The **Contents** pane displays the data in the model workspace.

- 7 Click the `Simulink.Signal` object `A`.

The right pane displays attributes for A, including.

Attribute	Value
Data type	double
Complexity	real
Dimensions	1
Initial value	5

#### 8 Simulate the model.

The MATLAB Function block reads the initial value of global data stored in A and updates the value of A each time it executes.

## Using Data Store Diagnostics to Detect Memory Access Issues

You can configure your model to provide run-time and compile-time diagnostics for avoiding problems with data stores. Diagnostics are available in the Configuration Parameters dialog box and the parameters dialog box for the Data Store Memory block. These diagnostics are available for Data Store Memory blocks only, not for `Simulink.Signal` objects. For more information on using data store diagnostics, see “Data Store Diagnostics” on page 60-3.

---

**Note:** If you pass data store memory arrays to functions, optimizations such as `A=foo(A)` might result in the code generation software marking the entire contents of the array as read or written even though only some elements were accessed.

---

## Limitations of Using Shared Data in MATLAB Function Blocks

There is no Data Store Memory support for:

- MATLAB structures
- Variable-sized data

## Related Examples

- “Create Model That Uses MATLAB Function Block” on page 40-9

- “Track Object Using MATLAB Code” on page 40-167

## **More About**

- “What Is a MATLAB Function Block?” on page 40-5

## Create Custom Block Libraries

### In this section...

“When to Use MATLAB Function Block Libraries” on page 40-124

“How to Create Custom MATLAB Function Block Libraries” on page 40-124

“Example: Creating a Custom Signal Processing Filter Block Library” on page 40-125

“Code Reuse with Library Blocks” on page 40-137

“Debugging MATLAB Function Library Blocks” on page 40-142

“Properties You Can Specialize Across Instances of Library Blocks” on page 40-142

### When to Use MATLAB Function Block Libraries

In Simulink, you can create your own block libraries as a way to reuse the functionality of blocks or subsystems in one or more models. If you want to reuse a set of MATLAB algorithms in Simulink models, you can encapsulate your MATLAB code in a MATLAB Function block library.

As with other Simulink block libraries, you can specialize each instance of MATLAB Function library blocks in your model to use different data types, sample times, and other properties. Library instances that inherit the same properties can reuse generated code

### How to Create Custom MATLAB Function Block Libraries

Here is a basic workflow for creating custom block libraries with MATLAB Function blocks. To work through these steps with an example, see “Example: Creating a Custom Signal Processing Filter Block Library” on page 40-125.

- 1 Add polymorphic MATLAB code to MATLAB Function blocks in a Simulink model.

Polymorphic code is code that can process data with different properties, such as type, size, and complexity.

- 2 Configure the blocks to inherit the properties you want to specialize.

For a list of properties you can specialize, see “Properties You Can Specialize Across Instances of Library Blocks” on page 40-142.

- 3 Optionally, customize your library code using masking.
- 4 Add instances of MATLAB Function library blocks to a Simulink model.

---

**Note:** If your MATLAB Function block library is masked, you cannot modify contents of the block with mask initialization code. The **Allow library block to modify its contents** option in the Mask dialog box is not supported for MATLAB Function block libraries.

---

## Example: Creating a Custom Signal Processing Filter Block Library

- “What You Will Learn” on page 40-125
- “About the Filter Algorithms” on page 40-125
- “Step 1: Add the Filter Algorithms to MATLAB Function Library Blocks” on page 40-126
- “Step 2: Configure Blocks to Inherit Properties You Want to Specialize” on page 40-127
- “Step 3: Customize Your Library Using Masking” on page 40-128
- “Step 4: Add Instances of MATLAB Library Blocks to a Simulink Model” on page 40-132

### What You Will Learn

This simple example takes you through the workflow described in “How to Create Custom MATLAB Function Block Libraries” on page 40-124 to show you how to:

- Create a library of signal processing filter algorithms using MATLAB Function blocks
- Customize one of the library blocks using mask parameters
- Convert one of the filter algorithms to source-protected P-code that you can call from a MATLAB Function library block

### About the Filter Algorithms

The MATLAB filter algorithms are:

#### **my\_ff**

Performs a discrete Fourier transform on an input signal. The input can be a vector, matrix, or multidimensional array whose length is a power of 2.

**my\_conv**

Convolves two input vector signals. Outputs a subsection of the convolution with a size specified by a mask parameter, **Shape**.

**my\_sobel**

Convolves a 2D input matrix with a Sobel edge detection filter.

**Step 1: Add the Filter Algorithms to MATLAB Function Library Blocks**

- 1 In Simulink, create a library model by selecting **File > New > Library**
- 2 Drag three MATLAB Function blocks into the model from the User-Defined Functions section of the Simulink Library Browser and name them:
  - my\_fft\_filter
  - my\_conv\_filter
  - my\_sobel\_filter
- 3 Save the library model as my\_filter\_lib.
- 4 Open the MATLAB Function block named my\_fft\_filter, replace the template code with the following code, and save the block:

```
function y = my_fft(x)

y = fft(x);
```

- 5 Replace the template code in my\_conv\_filter block with the following code and save the block:

```
function c = my_conv(a, b)

c = conv(a, b);
```

- 6 Replace the template code in my\_sobel\_filter block with the following code and save the block:

```
function y = my_sobel(u)

%% "my_sobel_filter" is a MATLAB function
%% on the MATLAB path.
y = my_sobel_filter(u);
```

The my\_sobel function acts as a wrapper that calls a MATLAB function, my\_sobel\_filter, on the code generation path. my\_sobel\_filter implements



the algorithm that convolves a 2D input matrix with a Sobel edge detection filter. By calling the function rather than inlining the code directly in the MATLAB Function block, you can reuse the algorithm both as MATLAB code and in a Simulink model. You will create `my_sobel_filter` next.

- 7 In the same folder where you created `my_filter_lib`, create a new MATLAB function `my_sobel_filter` with the following code:

```
function y = my_sobel_filter(u)

% Sobel edge detection filter
h = [1  2  1;...
     0  0  0;...
    -1 -2 -1];

y = abs(conv2(u, h));
```

Save the file as `my_sobel_filter.m`.

## Step 2: Configure Blocks to Inherit Properties You Want to Specialize

In this example, the data in the signal processing filter algorithms must inherit size, type, and complexity from the Simulink model. By default, data in MATLAB Function blocks inherit these properties. To explicitly configure data to inherit properties:

- 1 Open a MATLAB Function block and select **Edit Data**.
- 2 In the left pane of the Ports and Data Manager, select the data of interest.
- 3 In the right pane, configure the data to inherit properties from Simulink:

To Inherit	What to Specify
Size	Enter -1 in Size field
Complexity	Select <b>Inherited</b> from the Complexity menu
Type	Select <b>Inherit: Same as Simulink</b> from the Type menu

For example, if you open the MATLAB Function block `my_fft_filter` and look at the properties of input `x` in the Ports and Data Manager, you see that size, type, and complexity are inherited by default.

---

**Note:** If your design has specific requirements or constraints, you can enter values for any of these properties, rather than inherit them from Simulink. For example, if your algorithm is not supposed to work with complex inputs, set **Complexity** to **Off**.

---

### Step 3: Customize Your Library Using Masking

In this exercise you will modify the convolution filter `my_conv` to use a custom parameter `shape` that specifies what subsection of the convolution to output. To customize this algorithm for your library, place the `my_conv_filter` block under a masked subsystem and define `shape` as a mask parameter.

1 Convert the block to a masked subsystem:

- a Right-click the `my_conv_filter` block and select **Subsystem & Model Reference > Create Subsystem from Selection**.

The `my_conv_filter` block changes to a subsystem block.

- b Change the name of the subsystem to `my_conv_filter`.
- c Right-click the `my_conv_filter` subsystem and select **Mask > Create Mask** from the context menu.

The Mask Editor appears with the **Icon & Ports** tab open.

- d Enter in the **Icon drawing commands** text box:

```
disp('my_conv');  
port_label('output', 1, 'c');  
port_label('input', 1, 'a');  
port_label('input', 2, 'b');
```

- e Select the **Parameters & Dialog** tab.
- f Highlight the **Parameters** line item in the Dialog box pane.
- g Add a popup-type parameter by clicking **Popup** under the **Parameter** list in the **Controls** pane.

A new parameter will appear in the Dialog box pane.

- h In the **Property editor** pane, set the **Properties**:

Property	Value
<b>Name</b>	shape
<b>Value</b>	full
<b>Prompt</b>	shape
<b>Type</b>	popup
<b>Type options</b>	Open the Type Options Editor and enter:  full same valid

- i Set the **Attributes**, **Dialog**, and **Layout** properties in the **Property editor** pane:

Attributes, Dialog, and Layout Items	Value
<b>Attributes</b>	<ul style="list-style-type: none"> <li>• Evaluate: Checked</li> <li>• Tunable: Cleared</li> <li>• Read only: Cleared</li> <li>• Hidden: Cleared</li> <li>• Never save: Cleared</li> </ul>
<b>Dialog</b>	<ul style="list-style-type: none"> <li>• Enable: Checked</li> <li>• Visible: Checked</li> <li>• Callback: no entry</li> </ul>
<b>Layout</b>	<ul style="list-style-type: none"> <li>• Item location: Grayed out</li> <li>• Prompt location: Left</li> </ul>

- i Click **OK**.

Your subsystem should now look like this:

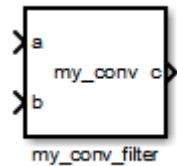

2 Set subsystem properties for code reuse:

- a Right-click the `my_conv_filter` subsystem and select **Block Parameters (Subsystem)** from the context menu.
- b In the subsystem parameters dialog box, select the **Treat as atomic unit** check box.

The dialog box expands to display new fields.

- c To generate a reusable function, select the Code Generation tab and in the **Function packaging** field, select **Reusable function** from the drop-down menu.

---

**Note:** This is an optional step, required for this example. If you leave the default setting of **Auto**, the code generation software uses an internal rule to determine whether to inline the function or not.

---

- d Click **OK**.

3 Define the `shape` parameter in the MATLAB Function `my_conv`:

- a Right-click the `my_conv_filter` subsystem and select **Mask > Look Under Mask** from the context menu.

The block diagram under the masked subsystem opens, containing the `my_conv_filter` block:

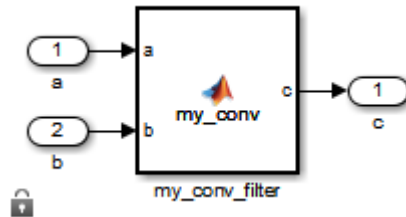

- b** Change the names of the port blocks to match the data names as follows:

Change:	To:
In1	a
In2	b
Out1	c

- c** Double-click the `my_conv_filter` block to open the MATLAB Function Block Editor.
- d** In the MATLAB Function Block Editor, select **Edit Data**.
- e** In the Ports and Data Manager, select **Add > Data**.

A new data element appears selected, along with its properties dialog.

- f** Enter the following properties:

Property	What To Specify
Name	Enter <b>shape</b> .
Scope	Select <b>Parameter</b> .
Tunable	Clear the box.

- g** Leave **Size**, **Complexity**, and **Type** as inherited (the defaults), as described in “Step 2: Configure Blocks to Inherit Properties You Want to Specialize” on page 40-127.
- h** Click **Apply**, close the Ports and Data Manager, and return to the MATLAB Function Block Editor.
- 4** Use the `shape` parameter to determine the size of the convolution to output:

- a In the MATLAB Function Block Editor, modify the `my_conv` function to call `conv` with the right shape:

```
function c = my_conv(a, b, shape)
if shape == 1
    c = conv(a, b, 'full');
elseif shape == 2
    c = conv(a, b, 'same');
else
    c = conv(a, b, 'valid');
end
```

- b Save your changes and close the MATLAB Function Block Editor.

**Step 4: Add Instances of MATLAB Library Blocks to a Simulink Model**

In this exercise, you will add specialized instances of the `my_conv_filter` library block to a simple test model.

- 1 Open a new Simulink model.

For purposes of this exercise, set the following configuration parameters for simulation:

Pane	Section	What to Specify
Solver	Solver options	<ul style="list-style-type: none"> <li>• Select <b>Fixed-Step</b> for <b>Type</b></li> <li>• Select <b>discrete (no continuous states)</b> for <b>Solver</b></li> <li>• Enter <b>1</b> for <b>Fixed-step size</b></li> </ul>
Data Import/Export	Save options	Structure for <b>Format</b>

- 2 Drag two instances of the `my_conv_filter` block from the `my_filter_lib` library into the model.
- 3 Add Constant, Outport, and Display blocks. Your model should look something like this:

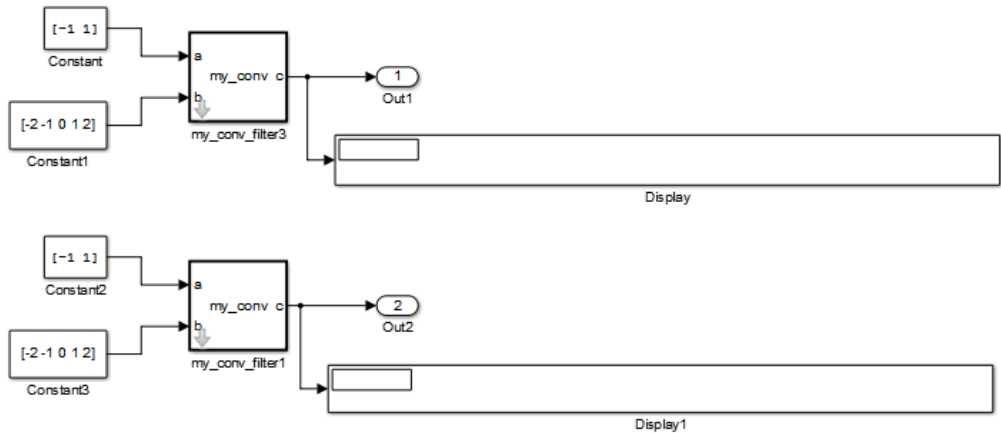

Both library instances share the same size, type, and complexity for inputs **a** and **b** respectively.

- 4 Double-click each library instance.

The **shape** parameter defaults to **full** for both instances.

- 5 Simulate the model.

Each library instance outputs the same result, the full 2D convolution:

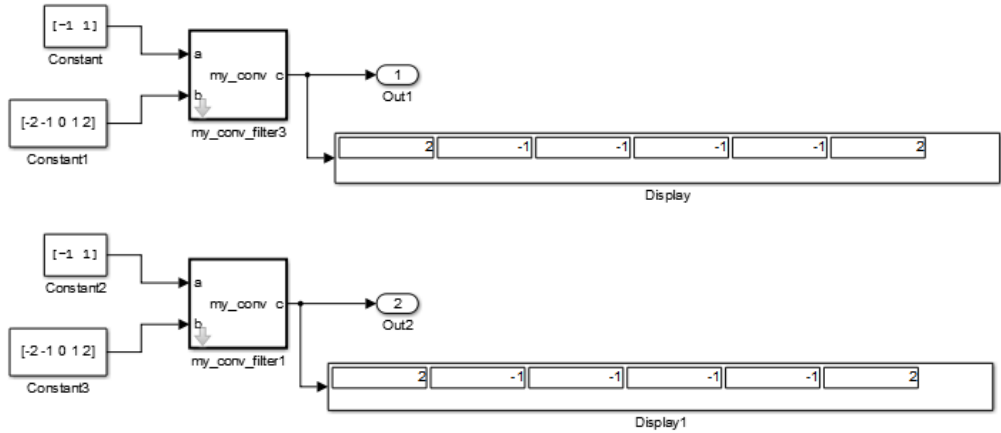

- 6 Specialize the second instance, `my_conv_filter1` by setting the value of its `shape` parameter to **same**.
- 7 Now simulate the model again.

This time, the outputs have different sizes: `my_conv_filter3` outputs the full 2D convolution, while `my_conv_filter1` displays the central part of the convolution as a 1-by-2 vector, the same size as `a`:



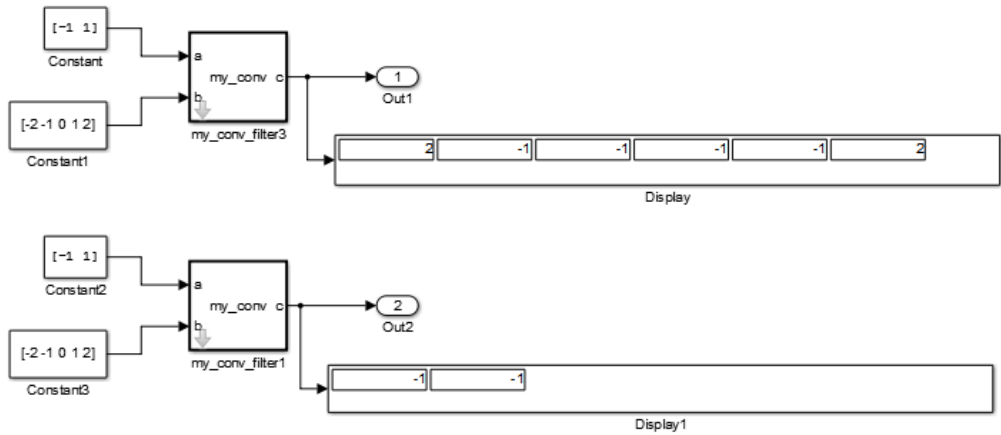

- 8 Now, add a third instance by copying `my_conv_filter1`. Specialize the new instance, `my_conv_filter2`, so that it does not inherit the same size inputs as the first two instances:

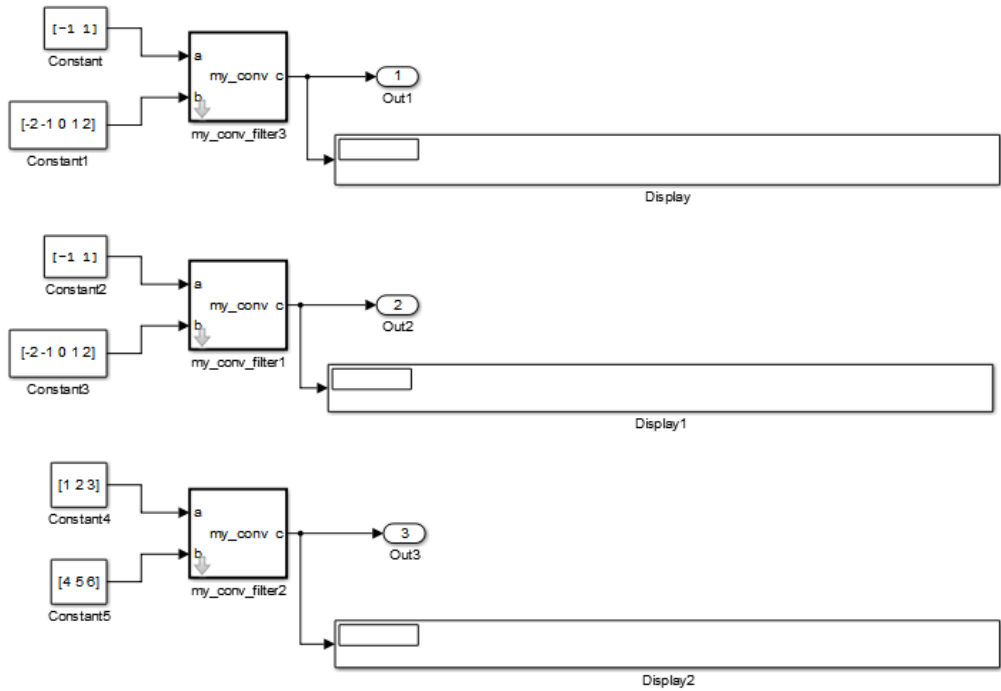

9 Simulate the model again.

This time, `my_conv_filter1` and `my_conv_filter2` each display the central part of the convolution, but the output sizes are different because each matches a different sized input `a`.

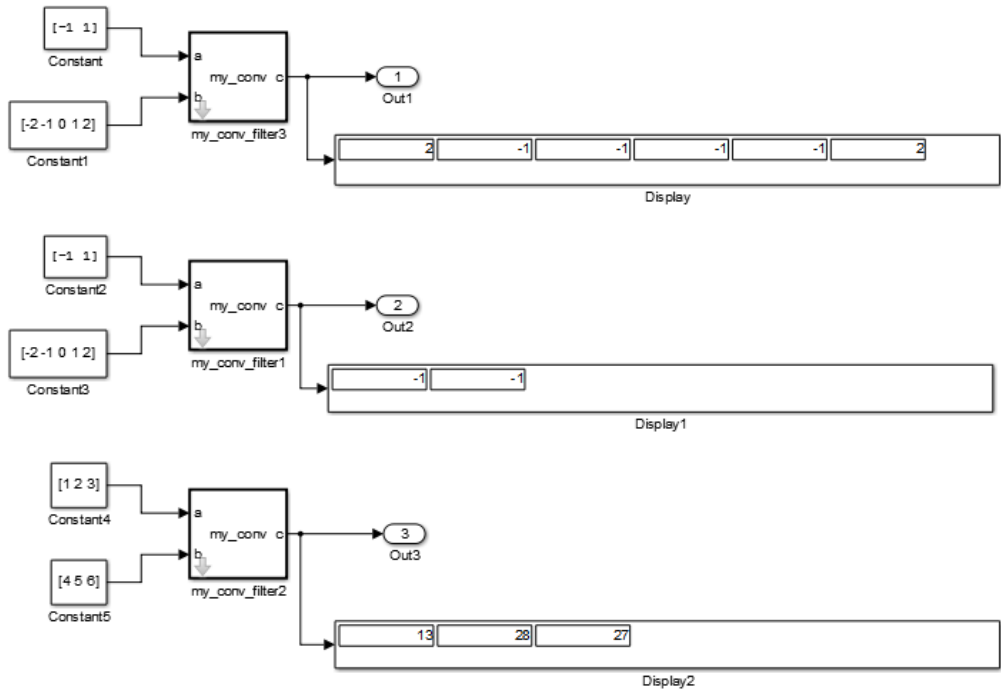

## Code Reuse with Library Blocks

When instances of MATLAB Function library blocks inherit the same properties, they can reuse generated code, as illustrated by an example based on “Step 4: Add Instances of MATLAB Library Blocks to a Simulink Model” on page 40-132:

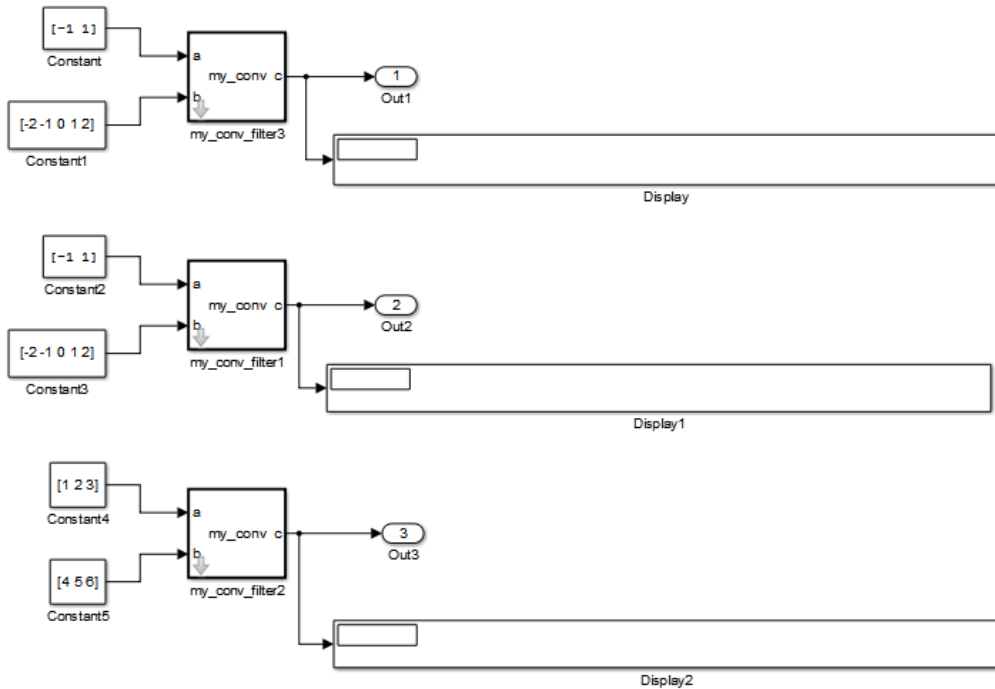

In this model, the library instances `my_conv_filter` and `my_conv_filter1` inherit the same size, type, and complexity for each respective input. For each instance, input `a` is a 1-by-2 vector and input `b` is a 1-by-5 vector. By comparison, the inputs of `my_conv_filter2` inherit different respective sizes; both are 1-by-3 vectors.

In addition, each library instance has a mask parameter called `shape` that determines what subsection of the convolution to output. Assume that the value of `shape` is the same for each instance.

To generate code for this example, follow these steps:

- 1 Enable code reuse for the library block:
  - a In the library, right-click the MATLAB Function block `my_conv_filter` and select **Block Parameters (Subsystem)** from the context menu.
  - b In the Function Block Parameters dialog box, set these parameters:

- Select the **Treat as atomic unit** check box.
  - In the **Function packaging** field, select **Reusable** function from the drop-down menu.
- 2 Configure the model for code generation.

For purposes of this exercise, set the following configuration parameters:

Pane	Section	What to Specify
<b>Code Generation</b>	<b>Target selection</b>	Enter <b>ert.tlc</b> for System target file
<b>Code Generation &gt; Report</b>		Select <b>Create code generation report</b> check box.

- 3 Build the model.

If you build this model, the generated C code reuses logic for the `my_conv_filter` and `my_conv_filter1` library instances because they inherit the same input properties:

```

/*
 * Output and update for atomic system:
 *   '<Root>/my_conv_filter'
 *   '<Root>/my_conv_filter1'
 */
void sp_algorithm_tes_my_conv_filter(const real32_T rtu_a[2], const real32_T
rtu_b[5], rtB_my_conv_filter_sp_algorithm *localB)
{
    int32_T jA;
    int32_T jA_0;
    real32_T s;
    int32_T jC;

    /* MATLAB Function Block: '<S1>/my_conv_filter' */
    /* MATLAB Function 'my_conv_filter/my_conv_filter': '<S4>:1' */
    /* '<S4>:1:4' */
    for (jC = 0; jC < 6; jC++) {
        if (5 < jC + 2) {
            jA = jC - 4;
        } else {
            jA = 0;
        }
    }
}

```

```
    }  
  
    if (2 < jC + 1) {  
        jA_0 = 2;  
    } else {  
        jA_0 = jC + 1;  
    }  
  
    s = 0.0F;  
    while (jA + 1 <= jA_0) {  
        s += rtu_b[jC - jA] * rtu_a[jA];  
        jA++;  
    }  
  
    localB->c[jC] = s;  
}  
  
/* end of MATLAB Function Block: '<S1>/my_conv_filter' */  
}
```

However, a separate function is generated for my\_conv\_filter2:

```

/* Output and update for atomic system: '<Root>/my_conv_filter2' */
void sp_algorithm_te_my_conv_filter2(const real_T rtu_a[3], const real_T rtu_b[3],
    rtB_my_conv_filter_sp_algorit_h *localB)
{
    int32_T jA;
    int32_T jA_0;
    real_T s;
    int32_T jC;

    /* MATLAB Function Block: '<S3>/my_conv_filter' */
    /* MATLAB Function 'my_conv_filter/my_conv_filter': '<S6>:1' */
    /* '<S6>:1:4' */
    for (jC = 0; jC < 5; jC++) {
        if (3 < jC + 2) {
            jA = jC - 2;
        } else {
            jA = 0;
        }

        if (3 < jC + 1) {
            jA_0 = 3;
        } else {
            jA_0 = jC + 1;
        }

        s = 0.0;
        while (jA + 1 <= jA_0) {
            s += rtu_b[jC - jA] * rtu_a[jA];
            jA++;
        }

        localB->c[jC] = s;
    }

    /* end of MATLAB Function Block: '<S3>/my_conv_filter' */
}

```

---

**Note:** Generating C code for this model requires a Simulink Coder or Embedded Coder license.

---

## Debugging MATLAB Function Library Blocks

You debug MATLAB Function library blocks the same way you debug any MATLAB Function block. However, when you add a breakpoint in a library block, the breakpoint is shared by all instances. As you continue execution, the debugger stops at the breakpoint in each instance.

## Properties You Can Specialize Across Instances of Library Blocks

You can specialize instances of MATLAB Function library blocks by allowing them to inherit any of the following properties from Simulink:

Property	Inherits by Default?	How to Specify Inheritance
Type	Yes	Set data type property to <b>Inherit: Same as Simulink</b> .
Size	Yes	Set data size property to <b>-1</b> .
Complexity	Yes	Set data complexity property to <b>Inherited</b> .
Limit range	No	Specify minimum and maximum values as Simulink parameters. For example, if minimum value = <code>aParam</code> and maximum value = <code>aParam + 3</code> , different instances of a MATLAB Function library block can resolve to different <code>aParam</code> parameters defined in their parent mask subsystems.
Sampling mode (input)	Yes	MATLAB Function block input ports always inherit sampling mode
Data type override mode for fixed-point data	Yes	Set data type override property to <b>Inherit</b> .
Sample time (block)	Yes	Set block sample time property to <b>-1</b> .

## Related Examples

- “Create Custom Block Libraries” on page 40-124
- “Type Function Arguments” on page 40-61



## **More About**

- “What Is a MATLAB Function Block?” on page 40-5
- “Custom Libraries and Linked Blocks” on page 39-2
- “MATLAB Function Block Editor” on page 40-34
- “Masking Fundamentals” on page 37-2
- “Debugging a MATLAB Function Block” on page 40-22

## Use Traceability in MATLAB Function Blocks

**In this section...**

“Extent of Traceability in MATLAB Function Blocks” on page 40-144

“Traceability Requirements” on page 40-144

“Basic Workflow for Using Traceability” on page 40-144

“Tutorial: Using Traceability in a MATLAB Function Block” on page 40-145

### Extent of Traceability in MATLAB Function Blocks

Like other Simulink blocks, MATLAB Function blocks support bidirectional traceability, but extend navigation to lines of source code. That is, you can navigate between a line of generated code and its corresponding line of source code. In other Simulink blocks, you can navigate between a line of generated code and its corresponding object.

In addition, you can select to include the source code as comments in the generated code. When you select this option, the MATLAB source code appears immediately after the associated traceability tag. For more information, see “Include MATLAB Code as Comments in Generated Code” on page 40-148.

For information about how traceability works in Simulink blocks, see “What Is Code Tracing?” (Embedded Coder).

### Traceability Requirements

To enable traceability comments in your code, you must have a license for Embedded Coder software. These comments appear only in code that you generate for an Embedded Real-Time (ERT) target.

---

**Note:** Traceability is not supported for MATLAB files that you call from a MATLAB Function block.

---

### Basic Workflow for Using Traceability

The workflow for using traceability is described in “Trace Model Objects to Generated Code” (Embedded Coder). Here are the basic steps:

- 1 Open the MATLAB Function block in your Simulink model.
- 2 Define your system target file to be an Embedded Real-Time (ERT) target.
  - a In the model, select **Simulation > Model Configuration Parameters**.
  - b In the **Code Generation** pane, enter `ert.tlc` for the system target file.
- 3 Enable traceability options.

- a In the **Code Generation > Report** pane, select **Create code generation report**.

This action automatically selects the **Open report automatically**, **Code-to-model**, and **Model-to-code** options.

- b In the **All Parameters** tab, verify that **Code-to-model** and **Model-to-code** parameters are enabled. The **Model-to-code** parameter:
  - Enables the **Configure** button, which opens a dialog box for loading existing trace information (Embedded Coder).
  - Enables and selects parameters for customizing the content of a traceability report (Embedded Coder).
- 4 Generate the source code and header files for your model.
- 5 Trace a line of code:

To Trace:	Do This:
Line of source code to lines of generated code	Right-click in a line in your source code and select <b>Code Generation &gt; Navigate to Code</b> from the context menu
Line of generated code to lines of source code	Click a hyperlink in the traceability comment in your generated code
Hyperlinked line number in generated code to lines of source code	Click a line number hyperlink in the source code

## Tutorial: Using Traceability in a MATLAB Function Block

This example shows how to trace between source code and generated code in a MATLAB Function block in the `eml_fire` model. Follow these steps:

- 1 Type `eml_fire` at the MATLAB prompt.

- 2 In the Simulink model window, double-click the `flame` block to open the MATLAB Function Block Editor.
- 3 In the Simulink model window, select **Simulation > Model Configuration Parameters**.
- 4 In the **Code Generation** pane, go to the **Target selection** section and enter `ert.tlc` for the system target file. Then click **Apply**.

---

**Note:** Traceability comments appear hyperlinked in generated code only for embedded real-time (`ert`) targets.

---

- 5 In the **Code Generation > Report** pane, select the **Create code generation report** option.

This action automatically selects the **Open report automatically**, **Code-to-model**, and **Model-to-code** parameters.

- 6 In the **All Parameters** tab, verify that **Code-to-model** and **Model-to-code** parameters are enabled.
- 7 Go to the **Code Generation > Interface** pane. In the **Software environment** section, select the **continuous time** option. Then click **Apply**.

---

**Note:** Because this example model contains a block with a continuous sample time, you must perform this step before generating code.

---

- 8 In the model window, press **Ctrl+B**.

This action generates source code and header files for the `eml_fire` model that contains the `flame` block. After the code generation process is complete, the code generation report appears automatically.

- 9 Click the `eml_fire.c` hyperlink in the report.
- 10 Scroll down through the code to see the traceability comments, which appear as links inside `/*...*/` brackets, as in this example.

```
for (b_x = 0; b_x < 256; b_x++) {
    /* '<S2>:1:19' */
    /* '<S2>:1:21' */
    yb = loopVar_i + 2;

    /* '<S2>:1:22' */
    xb = b_x - 1;
```

- 11** Click the `<S2>:1:19` hyperlink in this traceability comment:

```
/* '<S2>:1:19' */
```

Line 19 of the function appears highlighted in the MATLAB Function Block Editor.

- 12** You can trace a line in a MATLAB function to lines of generated code. For example, right-click in line 21 of your function and select **Code Generation > Navigate to Code** from the context menu.

The code location for line 21 appears highlighted in `eml_fire.c`.

- 13** You can trace a line of generated code to a line of source code in a MATLAB function using the line number hyperlinks in the generated code.

## Related Examples

- “Create Model That Uses MATLAB Function Block” on page 40-9
- “Track Object Using MATLAB Code” on page 40-167
- “Include MATLAB Code as Comments in Generated Code” on page 40-148

## More About

- “What Is a MATLAB Function Block?” on page 40-5
- “What Is Code Tracing?” (Embedded Coder)

## Include MATLAB Code as Comments in Generated Code

If you have a Simulink Coder license, you can include MATLAB source code as comments in the code generated for a MATLAB Function block. Including this information in the generated code enables you to:

- Correlate the generated code with your source code.
- Understand how the generated code implements your algorithm.
- Evaluate the quality of the generated code.

When you select this option, the generated code includes:

- The source code as a comment immediately after the traceability tag. When you enable traceability and generate code for ERT targets (requires an Embedded Coder license), the traceability tags are hyperlinks to the source code. For more information on traceability for the MATLAB Function block, see “Use Traceability in MATLAB Function Blocks” on page 40-144.

For examples and information on the location of the comments in the generated code, see “Location of Comments in Generated Code” on page 40-149.

- The function help text in the function body in the generated code. The function help text is the first comment after the MATLAB function signature. It provides information about the capabilities of the function and how to use it.

---

**Note:** With an Embedded Coder license, you can also include the function help text in the function banner of the generated code. For more information, see “Including MATLAB Function Help Text in the Function Banner” on page 40-151.

---

## How to Include MATLAB Code as Comments in the Generated Code

To include MATLAB source code as comments in the code generated for a MATLAB Function block:

- 1 In the model, select **Simulation > Model Configuration Parameters**.
- 2 In the **Code Generation > Comments** pane, select **MATLAB source code as comments** and click **Apply**.

## Location of Comments in Generated Code

The automatically generated comments containing the source code appear after the traceability tag in the generated code as follows.

### Straight-Line Source Code

The comment containing the source code precedes the generated code that implements the source code statement. This comment appears after any comments that you add that precede the generated code. The comments are separated from the generated code because the statements are assigned to function outputs.

#### MATLAB Code

```
function [x y] = straightline(r,theta)
%#codegen
% Convert polar to Cartesian
x = r * cos(theta);
y = r * sin(theta);
```

#### Commented C Code

```
/* MATLAB Function 'straightline': '<S1>:1' */
/* Convert polar to Cartesian */
/* '<S1>:1:4' x = r * cos(theta); */
/* '<S1>:1:5' y = r * sin(theta); */
straightline0_Y.x = straightline0_U.r * cos(straightline0_U.theta);

/* Output: '<Root>/y' incorporates:
 * Inport: '<Root>/r'
 * Inport: '<Root>/theta'
 * MATLAB Function Block: '<Root>/straightline'
 */
straightline0_Y.y = straightline0_U.r * sin(straightline0_U.theta);
```

### If Statements

The comment for the `if` statement immediately precedes the code that implements the statement. This comment appears after any comments that you add that precede the generated code. The comments for the `elseif` and `else` clauses appear immediately after the code that implements the clause, and before the code generated for statements in the clause.

#### MATLAB Code

```
function y = ifstmt(u,v)
```

```

%#codegen
if u > v
    y = v + 10;
elseif u == v
    y = u * 2;
else
    y = v - 10;
end

```

### Commented C Code

```

/* MATLAB Function 'MLFcn': '<S1>:1' */
/* '<S1>:1:3' if u > v */
if (MLFcn_U.u > MLFcn_U.v) {
    /* Output: '<Root>/y' */
    /* '<S1>:1:4' y = v + 10; */
    MLFcn_Y.y = MLFcn_U.v + 10.0;
} else if (MLFcn_U.u == MLFcn_U.v) {
    /* Output: '<Root>/y' */
    /* '<S1>:1:5' elseif u == v */
    /* '<S1>:1:6' y = u * 2; */
    MLFcn_Y.y = MLFcn_U.u * 2.0;
} else {
    /* Output: '<Root>/y' */
    /* '<S1>:1:7' else */
    /* '<S1>:1:8' y = v - 10; */
    MLFcn_Y.y = MLFcn_U.v - 10.0;
}

```

### For Statements

The comment for the `for` statement header immediately precedes the generated code that implements the header. This comment appears after any comments that you add that precede the generated code.

### MATLAB Code

```

function y = forstmt(u)
%#codegen
y = 0;
for i=1:u
    y = y + 1;
end

```

### Commented C Code

```

/* MATLAB Function 'MLFcn': '<S1>:1' */
/* '<S1>:1:3' y = 0; */

```



```
rtb_y = 0.0;

/* '<S1>:1:5' for i=1:u */
for (i = 1.0; i <= MLFcn_U.u; i++) {
    /* '<S1>:1:6' y = y + 1; */
    rtb_y++;
}
```

## While Statements

The comment for the `while` statement header immediately precedes the generated code that implements the statement header. This comment appears after any comments that you add that precede the generated code.

## Switch Statements

The comment for the `switch` statement header immediately precedes the generated code that implements the statement header. This comment appears after any comments that you add that precede the generated code. The comments for the `case` and `otherwise` clauses appear immediately after the generated code that implements the clause, and before the code generated for statements in the clause.

## Including MATLAB Function Help Text in the Function Banner

You can include the function help text in the function banner of the code generated for a MATLAB Function block. The function help text is the first comment after the MATLAB function signature. It provides information about the capabilities of the function and how to use it.

- 1 In the model, select **Simulation > Model Configuration Parameters**.
- 2 In the **Code Generation > Comments** pane, select **MATLAB function help text** and click **Apply**.

---

**Note:** If the function is inlined, the function help text is also inlined. Therefore, the help text for inlined functions appears in the function body in the generated code even when this option is selected.

---

## Limitations of MATLAB Source Code as Comments

The MATLAB Function block has the following limitations for including MATLAB source code as comments.

- You cannot include MATLAB source code as comments for:
  - MathWorks toolbox functions
  - P-code
  - Simulation targets
  - Stateflow Truth Table blocks
- The appearance or location of comments can vary depending on the following conditions:
  - Comments might still appear in the generated code even if the implementation code is eliminated, for example, due to constant folding.
  - Comments might be eliminated from the generated code if a complete function or code block is eliminated.
  - For certain optimizations, the comments might be separated from the generated code.
  - The generated code always includes legally required comments from the MATLAB source code, even if you do not choose to include source code comments in the generated code.

## **Related Examples**

- “Create Model That Uses MATLAB Function Block” on page 40-9
- “Track Object Using MATLAB Code” on page 40-167
- “Use Traceability in MATLAB Function Blocks” on page 40-144

## **More About**

- “What Is a MATLAB Function Block?” on page 40-5
- “What Is Code Tracing?” (Embedded Coder)

# Integrate C Code Using the MATLAB Function Block

## In this section...

“Call C Code from a Simulink model” on page 40-153

“Control Imported Bus and Enumeration Type Definitions” on page 40-155

## Call C Code from a Simulink model

You can call external C code from a Simulink model using a MATLAB Function block and the `coder.ceval` command. Follow these high-level steps:

- 1 Start with existing C code consisting of the source (.c) and header (.h) files.
- 2 In the MATLAB Function block, enter the MATLAB code that calls the C code. Use the command `coder.ceval`.
- 3 Specify the C source and header files for simulation in the **Simulation Target** pane of the Configuration Parameters dialog box.

Include the header file using double quotations, such as `#include "program.h"`.

- 4 If you need to access C source and header files outside your working folder, list the path in the **Simulation Target** pane of the Configuration Parameters dialog box, in the **Include Directories** text box.
- 5 Test your Simulink model and ensure it functions correctly.
- 6 To use the same source and header files for code generation, click **Use the same custom code settings as Simulation Target** in the **Code Generation > Custom Code** pane.

You can also specify different source and header files.

If you have a Simulink Coder license, you can generate code for targets using this method.

## Call the `doubleIt` Program Using a MATLAB Function Block

This example shows how to call the simple C program `doubleIt` from a MATLAB Function block.

- 1 Create the source file `doubleIt.c` in your current working folder.

```

/* doubleIt, a simple program that returns double the input */
#include "doubleIt.h"

double doubleIt(double u)
{
    return(u*2.0);
}

```

- 2 Create the header file `doubleIt.h` in your current working folder.

```
double doubleIt(double u);
```

- 3 Create a new Simulink model.
- 4 Add a MATLAB Function block to the model and double-click the block to open the editor.
- 5 Enter code that calls the `doubleIt` program:

```

function y = callingDoubleIt(u)

y = 0.0;
y = coder.ceval('doubleIt',u);

```

- 6 Connect a Constant block having a value of 3.5 to the input port of the MATLAB Function block.
- 7 Connect a Display block to the output port.

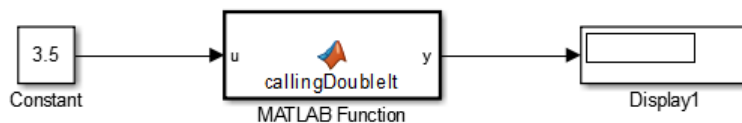

- 8 In the Configuration Parameters dialog box, open the **Simulation Target** pane.
- 9 In the **Insert custom C code in generated** section, select **Header file** from the list, and enter `#include "doubleIt.h"` in the **Header file** text box.
- 10 In the **Include list of additional** section, select **Source files** from the list, enter `doubleIt.c` in the **Source files** text box, and click **OK**.

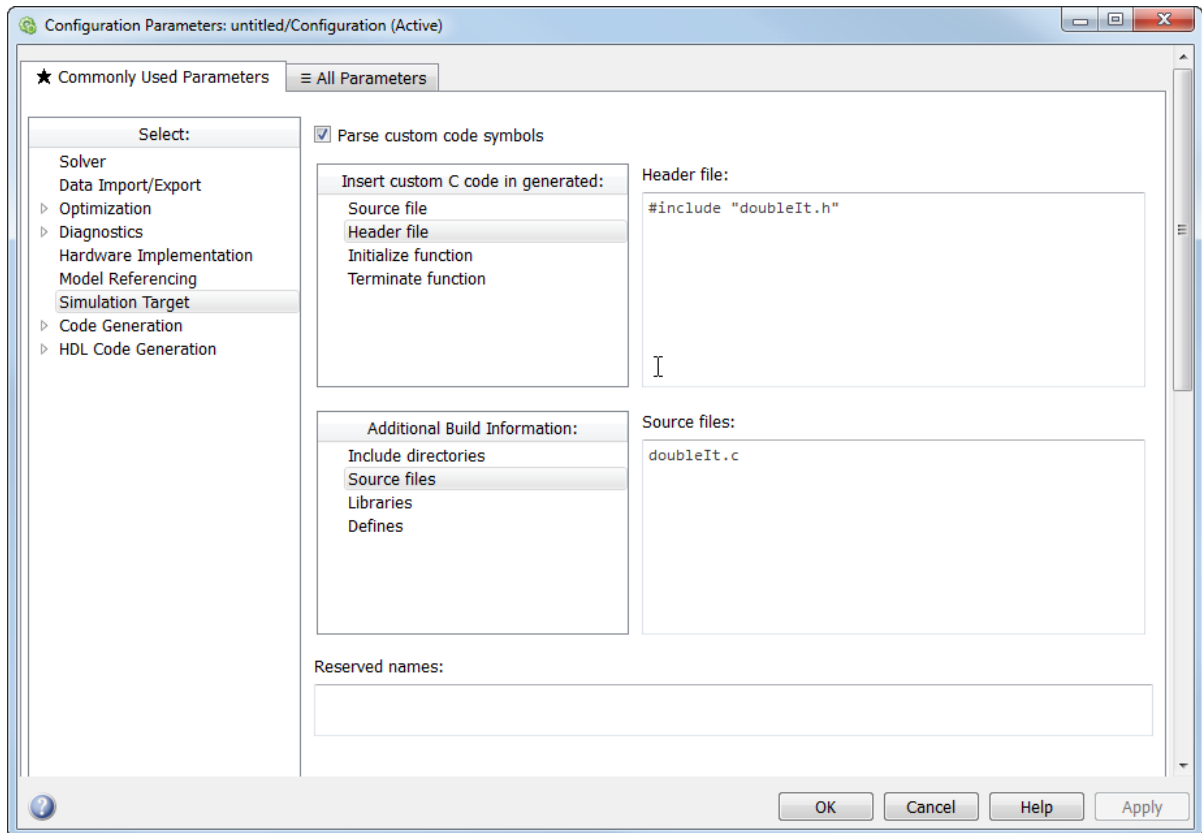

11 Simulate the model.

The value 7 appears in the Display block.

## Control Imported Bus and Enumeration Type Definitions

This procedure applies to simulation only.

Simulink generates code for MATLAB Function blocks and Stateflow to simulate the model. When you call external C code using MATLAB Function blocks or Stateflow, you can control the type definitions for imported buses and enumerations in model simulation.

Simulink can generate type definitions, or you can supply a header file containing the type definitions. You control this behavior using the **Generate typedefs for imported bus and enumeration types** check box in the **All Parameters** pane of the Configuration Parameters dialog box.

To include a custom header file defining the enumeration and bus types:

- 1 Clear the **Generate typedefs for imported bus and enumeration types** check box.
- 2 List the header file in the **Simulation Target** pane, in the **Header file** text box.

To configure Simulink to automatically generate type definitions:

- 1 Select the **Generate typedefs for imported bus and enumeration types** check box.
- 2 Do not list a header file that corresponds to the buses or enumerations.

## See Also

`coder.ceval`

## Related Examples

- “Create Model That Uses MATLAB Function Block” on page 40-9

## More About

- “Model Configuration Parameters: Simulation Target”
- “What Is a MATLAB Function Block?” on page 40-5

## Enhance Code Readability for MATLAB Function Blocks

### In this section...

“Requirements for Using Readability Optimizations” on page 40-157

“Converting If-Elseif-Else Code to Switch-Case Statements” on page 40-157

“Example of Converting Code for If-Elseif-Else Decision Logic to Switch-Case Statements” on page 40-159

### Requirements for Using Readability Optimizations

To use readability optimizations in your code, you must have an Embedded Coder license. These optimizations appear only in code that you generate for an embedded real-time (ert) target.

---

**Note:** These optimizations do not apply to MATLAB files that you call from the MATLAB Function block.

---

For more information, see “Select a System Target File” (Embedded Coder) and “Control Code Style” (Embedded Coder) in the Embedded Coder documentation.

### Converting If-Elseif-Else Code to Switch-Case Statements

When you generate code for embedded real-time targets, you can choose to convert `if-elseif-else` decision logic to `switch-case` statements. This conversion can enhance readability of the code.

For example, when a MATLAB Function block contains a long list of conditions, the `switch-case` structure:

- Reduces the use of parentheses and braces
- Minimizes repetition in the generated code

#### How to Convert If-Elseif-Else Code to Switch-Case Statements

The following procedure describes how to convert generated code for the MATLAB Function block from `if-elseif-else` to `switch-case` statements.

Step	Task	Reference
1	Verify that your block follows the rules for conversion.	“Verifying the Contents of the Block” on page 40-161
2	Enable the conversion.	“Enabling the Conversion” on page 40-162
3	Generate code for your model.	“Generating Code for Your Model” on page 40-163

### Rules for Conversion

For the conversion to occur, the following rules must hold. LHS and RHS refer to the left-hand side and right-hand side of a condition, respectively.

Construct	Rules to Follow
MATLAB Function block	<p>Must have two or more <i>unique</i> conditions, in addition to a default.</p> <p>For more information, see “How the Conversion Handles Duplicate Conditions” on page 40-159.</p>
Each condition	<p>Must test equality only.</p> <p>Must use the same variable or expression for the LHS.</p> <hr/> <p><b>Note:</b> You can reverse the LHS and RHS.</p>
Each LHS	<p>Must be a single variable or expression, not a compound statement.</p> <p>Cannot be a constant.</p> <p>Must have an integer or enumerated data type.</p> <p>Cannot have any side effects on simulation.</p> <p>For example, the LHS can read from but not write to global variables.</p>
Each RHS	<p>Must be a constant.</p> <p>Must have an integer or enumerated data type.</p>



## How the Conversion Handles Duplicate Conditions

If a MATLAB Function block has duplicate conditions, the conversion preserves only the first condition. The generated code discards all other instances of duplicate conditions.

After removal of duplicates, two or more unique conditions must exist. Otherwise, no conversion occurs and the generated code contains all instances of duplicate conditions.

The following examples show how the conversion handles duplicate conditions.

Example of Generated Code	Code After Conversion
<pre>if (x == 1) {     block1 } else if (x == 2) {     block2 } else if (x == 1) { // duplicate     block3 } else if (x == 3) {     block4 } else if (x == 1) { // duplicate     block5 } else {     block6 }</pre>	<pre>switch (x) {     case 1:         block1; break;     case 2:         block2; break;     case 3:         block4; break;     default:         block6; break; }</pre>
<pre>if (x == 1) {     block1 } else if (x == 1) { // duplicate     block2 } else {     block3 }</pre>	<p>No change, because only one unique condition exists</p>

## Example of Converting Code for If-Elseif-Else Decision Logic to Switch-Case Statements

Suppose that you have the following model with a MATLAB Function block. Assume that the output data type is `double` and the input data type is `Controller`, an enumerated type that you define. (For more information, see “Code Generation for Enumerations” on page 40-108.)

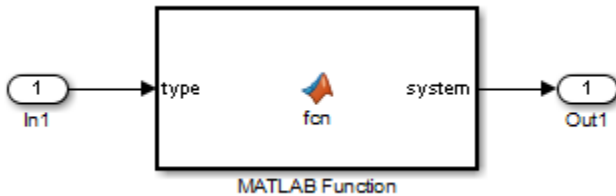

The block contains the following code:

```
function system = fcn(type)
%#codegen

if (type == Controller.P)
    system = 0;
elseif (type == Controller.I)
    system = 1;
elseif (type == Controller.PD)
    system = 2;
elseif (type == Controller.PI)
    system = 3;
elseif (type == Controller.PID)
    system = 4;
else
    system = 10;
end
```

The enumerated type definition in `Controller.m` is:

```
classdef Controller < Simulink.IntEnumType
    enumeration
        P(0)
        I(1)
        PD(2)
        PI(3)
        PID(4)
        UNKNOWN(10)
    end
end
```

If you generate code for an embedded real-time target using default settings, you see something like this:

```
if (if_to_switch_em1_blocks_U.In1 == P) {
```

```

/* '<S1>:1:4' */
/* '<S1>:1:5' */
if_to_switch_eml_blocks_Y.Out1 = 0.0;
} else if (if_to_switch_eml_blocks_U.In1 == I) {
/* '<S1>:1:6' */
/* '<S1>:1:7' */
if_to_switch_eml_blocks_Y.Out1 = 1.0;
} else if (if_to_switch_eml_blocks_U.In1 == PD) {
/* '<S1>:1:8' */
/* '<S1>:1:9' */
if_to_switch_eml_blocks_Y.Out1 = 2.0;
} else if (if_to_switch_eml_blocks_U.In1 == PI) {
/* '<S1>:1:10' */
/* '<S1>:1:11' */
if_to_switch_eml_blocks_Y.Out1 = 3.0;
} else if (if_to_switch_eml_blocks_U.In1 == PID) {
/* '<S1>:1:12' */
/* '<S1>:1:13' */
if_to_switch_eml_blocks_Y.Out1 = 4.0;
} else {
/* '<S1>:1:15' */
if_to_switch_eml_blocks_Y.Out1 = 10.0;
}

```

The LHS variable `if_to_switch_eml_blocks_U.In1` appears multiple times in the generated code.

---

**Note:** By default, variables that appear in the block do not retain their names in the generated code. Modified identifiers guarantee that no naming conflicts occur.

---

Traceability comments appear between each set of `/*` and `*/` markers. To learn more about traceability, see “Use Traceability in MATLAB Function Blocks” on page 40-144.

### Verifying the Contents of the Block

Check that the block follows all the rules in “Rules for Conversion” on page 40-158.

Construct	How the Construct Follows the Rules
MATLAB Function block	Five unique conditions exist, in addition to the default: <ul style="list-style-type: none"> <li>(type == Controller.P)</li> </ul>

Construct	How the Construct Follows the Rules
	<ul style="list-style-type: none"> <li>• (type == Controller.I)</li> <li>• (type == Controller.PD)</li> <li>• (type == Controller.PI)</li> <li>• (type == Controller.PID)</li> </ul>
Each condition	Each condition: <ul style="list-style-type: none"> <li>• Tests equality</li> <li>• Uses the same input for the LHS</li> </ul>
Each LHS	Each LHS: <ul style="list-style-type: none"> <li>• Contains a single variable</li> <li>• Is the input to the block and therefore not a constant</li> <li>• Is of enumerated type <code>Controller</code>, which you define in <code>Controller.m</code> on the MATLAB path</li> <li>• Has no side effects on simulation</li> </ul>
Each RHS	Each RHS: <ul style="list-style-type: none"> <li>• Is an enumerated value and therefore a constant</li> <li>• Is of enumerated type <code>Controller</code></li> </ul>

### Enabling the Conversion

- 1 Open the Configuration Parameters dialog box.
- 2 In the **Code Generation** pane, select `ert.tlc` for the **System target file**.

This step specifies an embedded real-time target for your model.

- 3 In the **Code Generation > Code Style** pane, select the **Convert if-elseif-else patterns to switch-case statements** check box.

---

**Tip:** This conversion works on a per-model basis. If you select this check box, the conversion applies to:

- All MATLAB Function blocks in a model
- MATLAB functions in all Stateflow charts of that model

- Flow charts in all Stateflow charts of that model

For more information, see “Enhance Readability of Code for Flow Charts” (Embedded Coder) in the Embedded Coder documentation.

---

## Generating Code for Your Model

In the model window, press **Ctrl+B**.

The code for the MATLAB Function block uses `switch-case` statements instead of `if-elseif-else` code:

```
switch (if_to_switch_eml_blocks_U.In1) {
  case P:
    /* '<S1>:1:4' */
    /* '<S1>:1:5' */
    if_to_switch_eml_blocks_Y.Out1 = 0.0;
    break;

  case I:
    /* '<S1>:1:6' */
    /* '<S1>:1:7' */
    if_to_switch_eml_blocks_Y.Out1 = 1.0;
    break;

  case PD:
    /* '<S1>:1:8' */
    /* '<S1>:1:9' */
    if_to_switch_eml_blocks_Y.Out1 = 2.0;
    break;

  case PI:
    /* '<S1>:1:10' */
    /* '<S1>:1:11' */
    if_to_switch_eml_blocks_Y.Out1 = 3.0;
    break;

  case PID:
    /* '<S1>:1:12' */
    /* '<S1>:1:13' */
    if_to_switch_eml_blocks_Y.Out1 = 4.0;
    break;

  default:
```

```
/* '<S1>:1:15' */  
if_to_switch_eml_blocks_Y.Out1 = 10.0;  
break;  
}
```

The `switch-case` statements provide the following benefits to enhance readability:

- The code reduces the use of parentheses and braces.
- The LHS variable `if_to_switch_eml_blocks_U.In1` appears only once, minimizing repetition in the code.

### **Related Examples**

- “Create Model That Uses MATLAB Function Block” on page 40-9
- “Use Traceability in MATLAB Function Blocks” on page 40-144
- “Code Generation for Enumerations” on page 40-108

### **More About**

- “What Is a MATLAB Function Block?” on page 40-5

# Control Run-Time Checks

**In this section...**

“Types of Run-Time Checks” on page 40-165

“When to Disable Run-Time Checks” on page 40-165

“How to Disable Run-Time Checks” on page 40-166

## Types of Run-Time Checks

In simulation, the code generated for your MATLAB Function block includes the following run-time checks:

- Memory integrity checks

These checks detect violations of memory integrity in code generated for MATLAB Function blocks and stop execution with a diagnostic message.

---

**Caution:** For safety, these checks are enabled by default. Without memory integrity checks, violations result in unpredictable behavior.

---

- Responsiveness checks in code generated for MATLAB Function blocks

These checks enable periodic checks for Ctrl+C breaks in the generated code. Enabling responsiveness checks also enables graphics refreshing.

---

**Caution:** For safety, these checks are enabled by default. Without these checks, the only way to end a long-running execution might be to terminate MATLAB.

---

## When to Disable Run-Time Checks

Generally, generating code with run-time checks enabled results in more lines of generated code and slower simulation than generating code with the checks disabled. Disabling run-time checks usually results in streamlined generated code and faster simulation, with these caveats:

Consider disabling:	Only if:
Memory integrity checks	You are sure that your code is safe and that all array bounds and dimension checking is unnecessary.
Responsiveness checks	You are sure that you will not need to stop execution of your application using Ctrl+C.

## How to Disable Run-Time Checks

MATLAB Function blocks enable run-time checks by default, but you can disable them explicitly for all MATLAB Function blocks in your Simulink model. Follow these steps:

- 1 Open your MATLAB Function block.
- 2 In the MATLAB Function Block Editor, select **Simulation Target**.
- 3 In the **All Parameters** tab of the Configuration Parameters dialog box, clear the **Ensure memory integrity** or **Ensure responsiveness** check boxes, as applicable, and click **Apply**.

## Related Examples

- “Create Model That Uses MATLAB Function Block” on page 40-9

## More About

- “What Is a MATLAB Function Block?” on page 40-5
- “MATLAB Function Block Editor” on page 40-34



# Track Object Using MATLAB Code

## In this section...

“Learning Objectives” on page 40-167

“Tutorial Prerequisites” on page 40-167

“Example: The Kalman Filter” on page 40-168

“Files for the Tutorial” on page 40-171

“Tutorial Steps” on page 40-172

“Best Practices Used in This Tutorial” on page 40-189

“Key Points to Remember” on page 40-189

## Learning Objectives

In this tutorial, you will learn how to:

- Use the MATLAB Function block to add MATLAB functions to Simulink models for modeling, simulation, and deployment to embedded processors.

This capability is useful for coding algorithms that are better stated in the textual language of MATLAB than in the graphical language of Simulink.

- Use `coder.extrinsic` to call MATLAB code from a MATLAB Function block.

This capability allows you to do rapid prototyping. You can call existing MATLAB code from Simulink without having to make this code suitable for code generation.

- Check that existing MATLAB code is suitable for code generation before generating code.

You must prepare your code before generating code.

- Specify variable-size inputs when generating code.

## Tutorial Prerequisites

- “What You Need to Know” on page 40-168
- “Required Products” on page 40-168

## What You Need to Know

To complete this tutorial, you should have basic familiarity with MATLAB software. You should also understand how to create and simulate a basic Simulink model.

## Required Products

To complete this tutorial, you must install the following products:

- MATLAB
- MATLAB Coder
- Simulink
- Simulink Coder
- C compiler

For a list of supported compilers, see [http://www.mathworks.com/support/compilers/current\\_release/](http://www.mathworks.com/support/compilers/current_release/).

You must set up the C compiler before generating C code. See “Setting Up Your C Compiler” on page 40-173.

For instructions on installing MathWorks products, see the MATLAB installation documentation for your platform. If you have installed MATLAB and want to check which other MathWorks products are installed, enter `ver` in the MATLAB Command Window.

## Example: The Kalman Filter

- “Description” on page 40-168
- “Algorithm” on page 40-169
- “Filtering Process” on page 40-170
- “Reference” on page 40-171

### Description

This section describes the example used by the tutorial. You do not have to be familiar with the algorithm to complete the tutorial.

The example for this tutorial uses a Kalman filter to estimate the position of an object moving in a two-dimensional space from a series of noisy inputs based on past positions.

The position vector has two components,  $x$  and  $y$ , indicating its horizontal and vertical coordinates.

Kalman filters have a wide range of applications, including control, signal and image processing; radar and sonar; and financial modeling. They are recursive filters that estimate the state of a linear dynamic system from a series of incomplete or noisy measurements. The Kalman filter algorithm relies on the state-space representation of filters and uses a set of variables stored in the state vector to characterize completely the behavior of the system. It updates the state vector linearly and recursively using a state transition matrix and a process noise estimate.

### Algorithm

This section describes the algorithm of the Kalman filter and is implemented in the MATLAB version of the filter supplied with this tutorial.

The algorithm predicts the position of a moving object based on its past positions using a Kalman filter estimator. It estimates the present position by updating the Kalman state vector, which includes the position ( $x$  and  $y$ ), velocity ( $V_x$  and  $V_y$ ), and acceleration ( $A_x$  and  $A_y$ ) of the moving object. The Kalman state vector, `x_est`, is a persistent variable.

```
% Initial conditions
persistent x_est p_est
if isempty(x_est)
    x_est = zeros(6, 1);
    p_est = zeros(6, 6);
end
```

`x_est` is initialized to an empty 6x1 column vector and updated each time the filter is used.

The Kalman filter uses the laws of motion to estimate the new state:

$$X = X_0 + V_x \cdot dt$$

$$Y = Y_0 + V_y \cdot dt$$

$$V_x = V_{x_0} + A_x \cdot dt$$

$$V_y = V_{y_0} + A_y \cdot dt$$

These laws of motion are captured in the state transition matrix  $A$ , which is a matrix that contains the coefficient values of  $x$ ,  $y$ ,  $V_x$ ,  $V_y$ ,  $A_x$ , and  $A_y$ .

```

% Initialize state transition matrix
dt=1;
A=[ 1 0 dt 0 0 0;...
    0 1 0 dt 0 0;...
    0 0 1 0 dt 0;...
    0 0 0 1 0 dt;...
    0 0 0 0 1 0 ;...
    0 0 0 0 0 1 ];

```

### Filtering Process

The filtering process has two phases:

- Predicted state and covariance

The Kalman filter uses the previously estimated state,  $x_{est}$ , to predict the current state,  $x_{prd}$ . The predicted state and covariance are calculated in:

```

% Predicted state and covariance
x_prd = A * x_est;
p_prd = A * p_est * A' + Q;

```

- Estimation

The filter also uses the current measurement,  $z$ , and the predicted state,  $x_{prd}$ , to estimate a more accurate approximation of the current state. The estimated state and covariance are calculated in:

```

% Measurement matrix
H = [ 1 0 0 0 0 0; 0 1 0 0 0 0 ];
Q = eye(6);
R = 1000 * eye(2);

% Estimation
S = H * p_prd' * H' + R;
B = H * p_prd';
klm_gain = (S \ B)';

% Estimated state and covariance
x_est = x_prd + klm_gain * (z - H * x_prd);
p_est = p_prd - klm_gain * H * p_prd;

% Compute the estimated measurements
y = H * x_est;

```

## Reference

Haykin, Simon. *Adaptive Filter Theory*. Upper Saddle River, NJ: Prentice-Hall, Inc., 1996.

## Files for the Tutorial

- “About the Tutorial Files” on page 40-171
- “Location of Files” on page 40-171
- “Names and Descriptions of Files” on page 40-171

### About the Tutorial Files

The tutorial uses the following files:

- Simulink model files for each step of the tutorial.
- Example MATLAB code files for each step of the tutorial.

Throughout this tutorial, you work with Simulink models that call MATLAB files containing a Kalman filter algorithm.

- A MAT-file that contains example input data.
- A MATLAB file for plotting.

### Location of Files

The tutorial files are available in the following folder: `docroot\toolbox\simulink\examples\kalman`. To run the tutorial, you must copy these files to a local folder. For instructions, see “Copying Files Locally” on page 40-172.

### Names and Descriptions of Files

Type	Name	Description
MATLAB function files	ex_kalman01	Baseline MATLAB implementation of a scalar Kalman filter.
	ex_kalman02	Version of the original algorithm suitable for code generation.
	ex_kalman03	Version of Kalman filter suitable for code generation and for use with frame-based and packet-based inputs.

Type	Name	Description
	ex_kalman04	Disabled inlining for code generation.
Simulink model files	ex_kalman00	Simulink model without a MATLAB Function block.
	ex_kalman11	Complete Simulink model with a MATLAB Function block for scalar Kalman filter.
	ex_kalman22	Simulink model with a MATLAB Function block for a Kalman filter that accepts fixed-size (frame-based) inputs.
	ex_kalman33	Simulink model with a MATLAB Function block for a Kalman filter that accepts variable-size (packet-based) inputs.
	ex_kalman44	Simulink model to call ex_kalman04.m, which has inlining disabled.
MATLAB data file	position	Contains the input data used by the algorithm.
Plot files	plot_trajectory	Plots the trajectory of the object and the Kalman filter estimated position.

## Tutorial Steps

- “Copying Files Locally” on page 40-172
- “Setting Up Your C Compiler” on page 40-173
- “About the ex\_kalman00 Model” on page 40-173
- “Adding a MATLAB Function Block to Your Model” on page 40-175
- “Simulating the ex\_kalman11 Model” on page 40-177
- “Modifying the Filter to Accept a Fixed-Size Input” on page 40-179
- “Using the Filter to Accept a Variable-Size Input” on page 40-183
- “Debugging the MATLAB Function Block” on page 40-186
- “Generating C Code” on page 40-187

### Copying Files Locally

Copy the tutorial files to a local working folder:

- 1 Create a local *solutions* folder, for example, `c:\simulink\kalman\solutions`.
- 2 Change to the `docroot\toolbox\simulink\examples` folder. At the MATLAB command line, enter:

```
cd(fullfile(docroot, 'toolbox', 'simulink', 'examples'))
```

- 3 Copy the contents of the `kalman` subfolder to your local *solutions* folder, specifying the full path name of the *solutions* folder:

```
copyfile('kalman', 'solutions')
```

For example:

```
copyfile('kalman', 'c:\simulink\kalman\solutions')
```

Your *solutions* folder now contains a complete set of solutions for the tutorial. If you do not want to perform the steps for each task in the tutorial, you can view the solutions to see how the code should look.

- 4 Create a local *work* folder, for example, `c:\simulink\kalman\work`.
- 5 Copy the following files from your *solutions* folder to your *work* folder.
  - `ex_kalman01`
  - `ex_kalman00`
  - `position`
  - `plot_trajectory`

Your *work* folder now contains all the files that you need to get started with the tutorial.

### Setting Up Your C Compiler

Building your MATLAB Function block requires a supported compiler. MATLAB automatically selects one as the default compiler. If you have multiple MATLAB-supported compilers installed on your system, you can change the default using the `mex -setup` command. See “Change Default Compiler” (MATLAB).

### About the `ex_kalman00` Model

First, examine the `ex_kalman00` model supplied with the tutorial to understand the problem that you are trying to solve using the Kalman filter.

- 1 Open the `ex_kalman00` model in Simulink:

- a** Set your MATLAB current folder to the folder that contains your working files for this tutorial. At the MATLAB command line, enter:

```
cd work
```

where *work* is the full path name of the folder containing your files.

- b** At the MATLAB command line, enter:

```
ex_kalman00
```

This model is an incomplete model to demonstrate how to integrate MATLAB code with Simulink. The complete model is `ex_kalman11`, which is also supplied with this tutorial.

### **InitFcn Model Callback Function**

The model uses this callback function to:

- Load position data from a MAT-file.
- Set up data used by the Index generator block, which provides the second input to the Selector block.

To view this callback:

- 1** Select **File > Model Properties > Model Properties**.
- 2** Select the **Callbacks** tab.
- 3** Select `InitFcn` in the **Model callbacks** pane.

The callback appears.

```
load position.mat;  
[R,C]=size(position);  
idx=(1:C)';  
t=idx-1;
```

### **Source Blocks**

The model uses two Source blocks to provide position data and a scalar index to a Selector block.



### Selector Block

The model uses a Selector block that selects elements of its input signal and generates an output signal based on its index input and its **Index Option** settings. By changing the configuration of this block, you can generate different size signals.

To view the Selector block settings, double-click the Selector block to view the function block parameters.

In this model, the **Index Option** for the first port is `Select all` and for the second port is `Index vector (port)`. Because the input is a  $2 \times 310$  position matrix, and the index data increments from 1 to 310, the Selector block simply outputs one  $2 \times 1$  output at each sample time.

### MATLAB Function Block

The model uses a MATLAB Function block to plot the trajectory of the object and the Kalman filter estimated position. This function:

- First declares the `figure`, `hold`, and `plot_trajectory` functions as extrinsic because these MATLAB visualization functions are not supported for code generation. When you call an unsupported MATLAB function, you must declare it to be extrinsic so MATLAB can execute it, but does not try to generate code for it.
- Creates a figure window and holds it for the duration of the simulation. Otherwise a new figure window appears for each sample time.
- Calls the `plot_trajectory` function, which plots the trajectory of the object and the Kalman filter estimated position.

### Simulation Stop Time

The simulation stop time is 309, because the input to the filter is a vector containing 310 elements and Simulink uses zero-based indexing.

### Adding a MATLAB Function Block to Your Model

To modify the model and code yourself, work through the exercises in this section. Otherwise, open the supplied model `ex_kalman11` in your *solutions* subfolder to see the modified model.

For the purposes of this tutorial, you add the MATLAB Function block to the `ex_kalman00.mdl` model supplied with the tutorial. You would have to develop your own test bench starting with an empty Simulink model.

### Adding the MATLAB Function Block

To add a MATLAB Function block to the `ex_kalman00` model:

- 1 Open `ex_kalman00` in Simulink.  
`ex_kalman00`
- 2 Add a MATLAB Function block to the model:
  - a At the MATLAB command line, type `slLibraryBrowser` to open the Simulink Library Browser.
  - b From the list of Simulink libraries, select the **User-Defined Functions** library.
  - c Click the MATLAB Function block and drag it into the `ex_kalman00` model. Place the block just above the red text annotation that reads **Place MATLAB Function Block here**.
  - d Delete the red text annotations from the model.
  - e Save the model in the current folder as `ex_kalman11`.

### Calling Your MATLAB Code from the MATLAB Function Block

To call your MATLAB code from the MATLAB Function block:

- 1 Double-click the MATLAB Function block to open the MATLAB Function Block Editor.
- 2 Delete the default code displayed in the editor.
- 3 Copy the following code to the MATLAB Function block.

```
function y = kalman(u)
%#codegen

y = ex_kalman01(u);
```

- 4 Save the model.

### Connecting the MATLAB Function Block Input and Output

- 1 Connect the MATLAB Function block input and output so that your model looks like this.

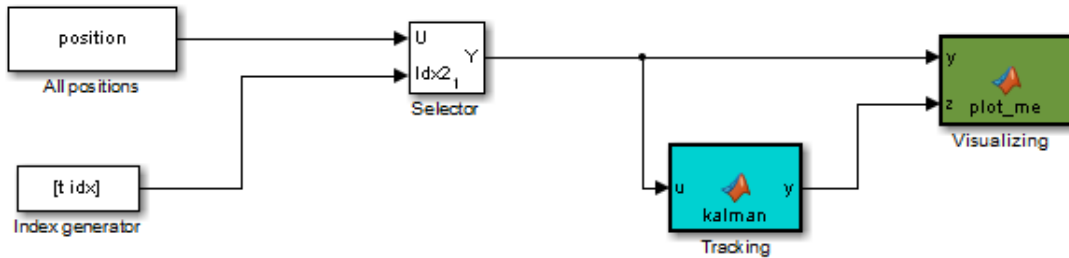

- 2 Save the model.

### Simulating the ex\_kalman11 Model

To simulate the model:

- 1 In the Simulink model window, select **Simulation > Run**.

As Simulink runs the model, it plots the trajectory of the object in blue and the Kalman filter estimated position in green. Initially, you see that it takes a short time for the estimated position to converge with the actual position of the object. Then three sudden shifts in position occur—each time the Kalman filter readjusts and tracks the object after a few iterations.

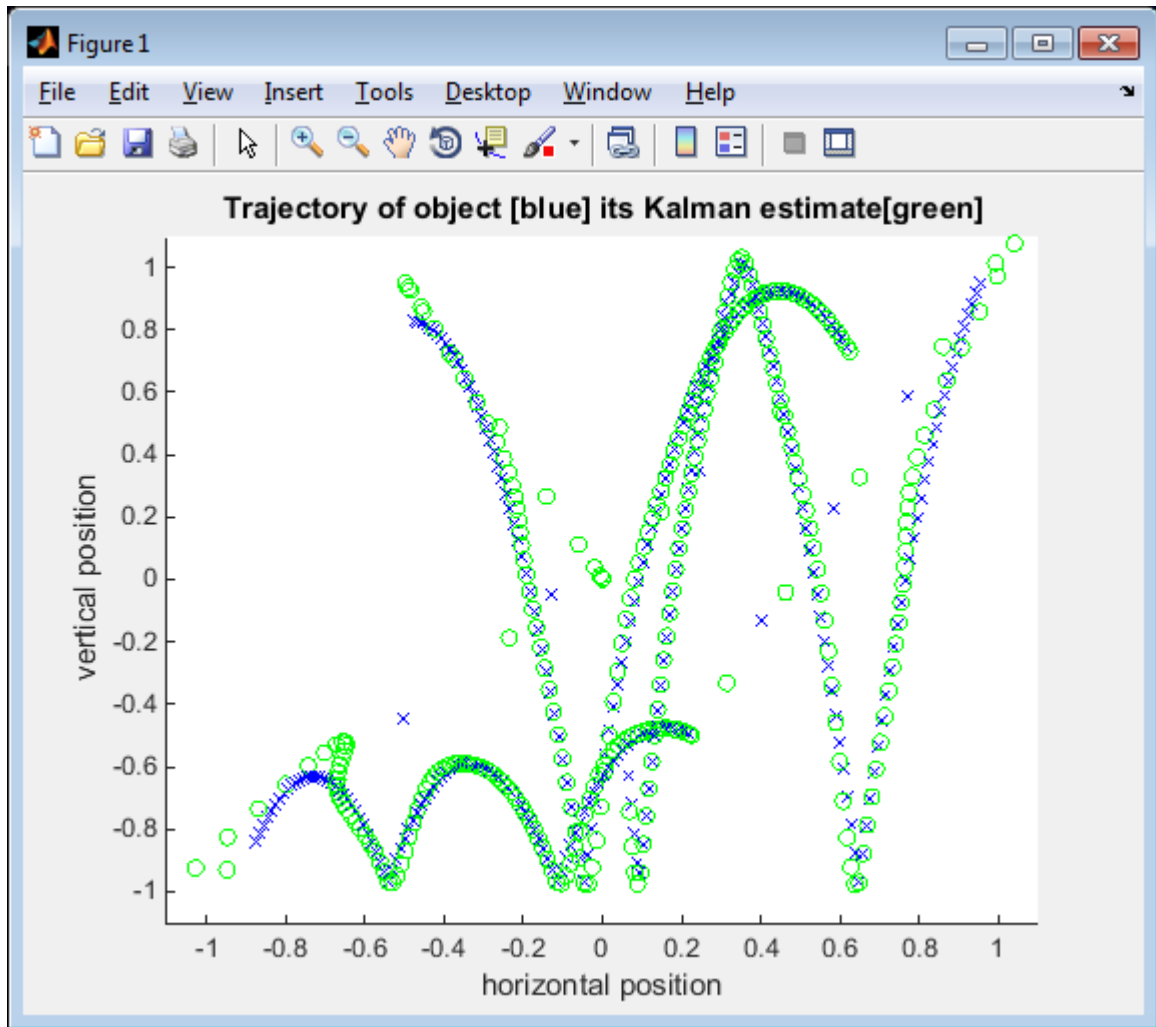

2 The simulation stops.

You have proved that your MATLAB algorithm works in Simulink. You are now ready to modify the filter to accept a fixed-size input, as described in “Modifying the Filter to Accept a Fixed-Size Input” on page 40-179.

## Modifying the Filter to Accept a Fixed-Size Input

The filter you have worked on so far in this tutorial uses a simple batch process that accepts one input at a time, so you must call the function repeatedly for each input. In this part of the tutorial, you learn how to modify the algorithm to accept a fixed-sized input, which makes the algorithm suitable for frame-based processing. You then modify the model to provide the input as fixed-size frames of data and call the filter passing in the data one frame at a time.

### Modifying Your MATLAB Code

To modify the code yourself, work through the exercises in this section. Otherwise, open the supplied file `ex_kalman03.m` in your *solutions* subfolder to see the modified algorithm.

You can now modify the algorithm to process a vector containing more than one input. You need to find the length of the vector and call the filter code for each element in the vector in turn. You do this by calling the filter algorithm in a `for` loop.

- 1 Open `ex_kalman02.m` in the MATLAB Editor. At the MATLAB command line, enter:

```
edit ex_kalman02.m
```

- 2 Add a `for` loop around the filter code.

- a Before the comment:

```
% Predicted state and covariance  
insert:
```

```
for i=1:size(z,2)
```

- b After:

```
% Compute the estimated measurements  
y = H * x_est;  
insert:
```

```
end
```

- c Select the code between the `for` statement and the `end` statement, right-click to open the context menu and select **Smart Indent** to indent the code.

Your filter code should now look like this:

```

for i=1:size(z,2)
    % Predicted state and covariance
    x_prd = A * x_est;
    p_prd = A * p_est * A' + Q;

    % Estimation
    S = H * p_prd' * H' + R;
    B = H * p_prd';
    klm_gain = (S \ B)';

    % Estimated state and covariance
    x_est = x_prd + klm_gain * (z - H * x_prd);
    p_est = p_prd - klm_gain * H * p_prd;

    % Compute the estimated measurements
    y = H * x_est;
end

```

- 3** Modify the line that calculates the estimated state and covariance to use the  $i^{\text{th}}$  element of input  $z$ .

Change:

```

x_est = x_prd + klm_gain * (z - H * x_prd);
to:

```

```

x_est = x_prd + klm_gain * (z(1:2,i) - H * x_prd);

```

- 4** Modify the line that computes the estimated measurements to append the result to the  $i^{\text{th}}$  element of the output  $y$ .

Change:

```

y = H * x_est;
to:

```

```

y(:,i) = H * x_est;

```

The code analyzer message indicator in the top right turns orange to indicate that the code analyzer has detected warnings. The code analyzer underlines the offending code in orange and places a orange marker to the right.

- 5** Move your pointer over the orange marker to view the error information.

The code analyzer detects that `y` must be fully defined before sub-scripting it and that you cannot grow variables through indexing in generated code.

- 6 To address this warning, preallocate memory for the output `y`, which is the same size as the input `z`. Add this code before the `for` loop.

```
% Pre-allocate output signal:
y=zeros(size(z));
```

The orange marker disappears and the code analyzer message indicator in the top right edge of the code turns green, which indicates that you have fixed all the errors and warnings detected by the code analyzer.

### Why Preallocate the Outputs?

You must preallocate outputs here because the code generation does not support increasing the size of an array over time. Repeatedly expanding the size of an array over time can adversely affect the performance of your program. See “Preallocating Memory” (MATLAB).

- 7 Change the function name to `ex_kalman03` and save the file as `ex_kalman03.m` in the current folder.

You are ready to begin the next task in the tutorial, “Modifying Your Model to Call the Updated Algorithm” on page 40-181.

### Modifying Your Model to Call the Updated Algorithm

To modify the model yourself, work through the exercises in this section. Otherwise, open the supplied model `ex_kalman22.mdl` in your *solutions* subfolder to see the modified model.

Next, update your model to provide the input as fixed-size frames of data and call `ex_kalman03` passing in the data one frame at a time.

- 1 Open `ex_kalman11` model in Simulink.

```
ex_kalman11
```

- 2 Double-click the MATLAB Function block to open the MATLAB Function Block Editor.
- 3 Replace the code that calls `ex_kalman02` with a call to `ex_kalman03`.

```
function y = kalman(u)
```

```
##codegen
```

```
y = ex_kalman03(u);
```

4 Close the editor.

5 Modify the InitFcn callback:

**a** Select **File > Model Properties > Model Properties**.

The Model Properties dialog box opens.

**b** In this dialog box, select the **Callbacks** tab.

**c** Select InitFcn in the **Model callbacks** pane.

**d** Replace the existing callback with:

```
load position.mat;
[R,C]=size(position);
FRAME_SIZE=5;
idx=(1:FRAME_SIZE:C)';
LEN=length(idx);
t=(1:LEN)' - 1;
```

This callback sets the frame size to 5, and the index to increment by 5.

**e** Click **Apply** and close the Model Properties dialog box.

6 Update the Selector block to use the correct indices.

**a** Double-click the Selector block to view the function block parameters.

The Function Block Parameters dialog box opens.

**b** Set the second **Index Option** to **Starting index (port)**.

**c** Set the **Output Size** for the second input to `FRAME_SIZE`, click **Apply** and close the dialog box.

Now, the **Index Option** for the first port is **Select all** and for the second port is **Starting index (port)**. Because the index increments by 5 each sample time, and the output size is 5, the Selector block outputs a 2x5 output at each sample time.

7 Change the model simulation stop time to 61. Now the frame size is 5, so the simulation completes in a fifth of the sample times.

**a** In the Simulink model window, select **Simulation > Model Configuration Parameters**.



- b** In the left pane of the Configuration Parameters dialog box, select **Solver**.
  - c** In the right pane, set **Stop time** to **61**.
  - d** Click **Apply** and close the dialog box.
- 8** Save the model as `ex_kalman22.mdl`.

### Testing Your Modified Algorithm

To simulate the model:

- 1** In the Simulink model window, select **Simulation > Run**.

As Simulink runs the model, it plots the trajectory of the object in blue and the Kalman filter estimated position in green as before when you used the batch filter.

- 2** The simulation stops.

You have proved that your algorithm accepts a fixed-size signal. You are now ready for the next task, “Using the Filter to Accept a Variable-Size Input” on page 40-183.

### Using the Filter to Accept a Variable-Size Input

In this part of the tutorial, you learn how to specify variable-size data in your Simulink model. Then you test your Kalman filter algorithm with variable-size inputs and see that the algorithm is suitable for processing packets of data of varying size. For more information on using variable-size data in Simulink, see “Variable-Size Signal Basics” on page 64-2.

### Updating the Model to Use Variable-Size Inputs

To modify the model yourself, work through the exercises in this section. Otherwise, open the supplied model `ex_kalman33.mdl` in your *solutions* subfolder to see the modified model.

- 1** Open `ex_kalman22.mdl` in Simulink.  
`ex_kalman22`
- 2** Modify the `InitFcn` callback:
  - a** Select **File > Model Properties > Model Properties**.

The Model Properties dialog box opens.

- b** Select the **Callbacks** tab.
- c** Select `InitFcn` in the **Model callbacks** pane.
- d** Replace the existing callback with:

```
load position.mat;  
idx=[ 1 1 ;2 3 ;4 6 ;7 10 ;11 15 ;16 30 ;  
      31 70 ;71 100 ;101 200 ;201 250 ;251 310];  
LEN=length(idx);  
t=(0:1:LEN-1)';
```

This callback sets up indexing to generate eleven different size inputs. It specifies the start and end indices for each sample time. The first sample time uses only the first element, the second sample time uses the second and third elements, and so on. The largest sample, 101 to 200, contains 100 elements.

- e** Click **Apply** and close the **Model Properties** dialog box.
- 3** Update the Selector block to use the correct indices.
- a** Double-click the Selector block to view the function block parameters.  
  
The Function Block Parameters dialog box opens.
  - b** Set the second **Index Option** to **Starting and ending indices (port)**, then click **Apply** and close the dialog box.  
  
This setting means that the input to the index port specifies the start and end indices for the input at each sample time. Because the index input specifies different starting and ending indices at each sample time, the Selector block outputs a variable-size signal as the simulation progresses.
- 4** Use the Ports and Data Manager to set the MATLAB Function input `x` and output `y` as variable-size data.
- a** Double-click the MATLAB Function block to open the MATLAB Function Block Editor.
  - b** From the editor menu, select **Edit Data**.
  - c** In the Ports and Data Manager left pane, select the input `u`.  
  
The Ports and Data Manager displays information about `u` in the right pane.
  - d** On the **General** tab, select the **Variable size** check box and click **Apply**.
  - e** In the left pane, select the output `y`.
  - f** On the **General** tab:

- i Set the **Size** of **y** to [2 100] to specify a 2-D matrix where the upper bounds are 2 for the first dimension and 100 for the second, which is the maximum size input specified in the `InitFcn` callback.
  - ii Select the **Variable size** check box.
  - iii Click **Apply**.
- g Close the Ports and Data Manager.
- 5 Now do the same for the other MATLAB Function block. Use the Ports and Data Manager to set the Visualizing block inputs **y** and **z** as variable-size data.
  - a Double-click the Visualizing block to open the MATLAB Function Block Editor.
  - b From the editor menu, select **Edit Data**.
  - c In the Ports and Data Manager left pane, select the input **y**.
  - d On the **General** tab, select the **Variable size** check box and click **Apply**.
  - e In the left pane, select the input **z**.
  - f On the **General** tab, select the **Variable size** check box and click **Apply**.
  - g Close the Ports and Data Manager.
- 6 Change the model simulation stop time to 10. This time, the filter processes one of the eleven different size inputs each sample time.
- 7 Save the model as `ex_kalman33.mdl`.

### Testing Your Modified Model

To simulate the model:

- 1 In the Simulink model window, select **Simulation > Run**.

As Simulink runs the model, it plots the trajectory of the object in blue and the Kalman filter estimated position in green as before.

Note that the signal lines between the Selector block and the Tracking and Visualization blocks change to show that these signals are variable-size.

- 2 The simulation stops.

You have successfully created an algorithm that accepts variable-size inputs. Next, you learn how to debug your MATLAB Function block, as described in “Debugging the MATLAB Function Block” on page 40-186.

## Debugging the MATLAB Function Block

You can debug your MATLAB Function block just like you can debug a function in MATLAB.

- 1 Double-click the MATLAB Function block that calls the Kalman filter to open the MATLAB Function Block Editor.

- 2 In the editor, click the dash (-) character in the left margin of the line:

```
y = kalman03(u);
```

A small red ball appears in the margin of this line, indicating that you have set a breakpoint.

- 3 In the Simulink model window, select **Simulation > Run**.

The simulation pauses when execution reaches the breakpoint and a small green arrow appears in the left margin.

- 4 Place the pointer over the variable `u`.

The value of `u` appears adjacent to the pointer.

- 5 From the MATLAB Function Block Editor menu, select **Step In**.

The `kalman03.m` file opens in the editor and you can now step through this code using **Step**, **Step In**, and **Step Out**.

- 6 Select **Step Out**.

The `kalman03.m` file closes and the MATLAB Function block code reappears in the editor.

- 7 Place the pointer over the output variable `y`.

You can now see the value of `y`.

- 8 Click the red ball to remove the breakpoint.

- 9 From the MATLAB Function Block Editor menu, select **Quit Debugging**.

- 10 Close the editor.

- 11 Close the figure window.

Now you are ready for the next task, “Generating C Code” on page 40-187.

## Generating C Code

You have proved that your algorithm works in Simulink. Next you generate code for your model.

---

**Note:** Before generating code, you must check that your MATLAB code is suitable for code generation. If you call your MATLAB code as an extrinsic function, you must remove extrinsic calls before generating code.

---

- 1 Rename the MATLAB Function block to **Tracking**. To rename the block, double-click the annotation **MATLAB Function** below the MATLAB Function block and replace the text with **Tracking**.

When you generate code for the MATLAB Function block, Simulink Coder uses the name of the block in the generated code. It is good practice to use a meaningful name.

- 2 Before generating code, ensure that Simulink Coder creates a code generation report. This HTML report provides easy access to the list of generated files with a summary of the configuration settings used to generate the code.

- a In the Simulink model window, select **Simulation > Model Configuration Parameters**.

The Configuration Parameters dialog box opens.

- b In the left pane of the Configuration Parameters dialog box, select **Report** under **Code Generation**.

- c In the right pane, select **Create code generation report**.

The **Open report automatically** option is also selected.

- d Click **Apply** and close the Configuration Parameters dialog box.

- e Save your model.

- 3 To generate code for the Tracking block:

- a In your model, select the Tracking block.

- b In the Simulink model window, select **Code > C/C++ Code > Build Selected Subsystem**.

- 4 The Simulink software generates an error informing you that it cannot log variable-size signals as arrays. You need to change the format of data saved to the MATLAB workspace. To change this format:

- In the Simulink model window, select **Simulation > Model Configuration Parameters**.

The Configuration Parameters dialog box opens.

- In the left pane of the Configuration Parameters dialog box, select **Data Import/Export** and set the **Format** to **Structure with time**.

The logged data is now a structure that has two fields: a time field and a signals field, enabling Simulink to log variable-size signals.

- Click **Apply** and close the Configuration Parameters dialog box.
- Save your model.

- 5 Repeat step 3 to generate code for the Tracking block.

The Simulink Coder software generates C code for the block and launches the code generation report.

For more information on using the code generation report, see “Reports for Code Generation” (Simulink Coder).

- 6 In the left pane of the code generation report, click the **Tracking.c** link to view the generated C code. Note that in the code generated for the MATLAB Function block, **Tracking**, there is no code for the **ex\_kalman03** function because inlining is enabled by default.
- 7 Modify your filter algorithm to disable inlining:

- a** In **ex\_kalman03.m**, after the function declaration, add:

```
coder.inline('never');
```

- b** Change the function name to **ex\_kalman04** and save the file as **ex\_kalman04.m** in the current folder.

- c** In your **ex\_kalman33** model, double-click the Tracking block.

The MATLAB Function Block Editor opens.

- d** Modify the call to the filter algorithm to call **ex\_kalman04**.

```
function y = kalman(u)
```

```
    %#codegen
```

```
    y = ex_kalman04(u);
```

- e Save the model as `ex_kalman44.mdl`.
- 8 Generate code for the updated model.
  - a Select the Tracking block.
  - b In the model window, select **Code > C/C++Code > Build Selected Subsystem**.

The **Build code for Subsystem** dialog box appears.

- c Click the **Build** button.

The Simulink Coder software generates C code for the block and launches the code generation report.

- d In the left pane of the code generation report, click the `Tracking.c` link to view the generated C code.

This time the `ex_kalman04` function has code because you disabled inlining.

```
/* Forward declaration for local functions */
static void Tracking_ex_kalman04(const real_T z_data[620], const int32_T
    z_sizes[2], real_T y_data[620], int32_T y_sizes[2]);

/* Function for MATLAB Function Block: '<Root>/Tracking' */
static void Tracking_ex_kalman04(const real_T z_data[620], const int32_T    48
    z_sizes[2], real_T y_data[620], int32_T y_sizes[2])
```

## Best Practices Used in This Tutorial

### Best Practice — Saving Incremental Code Updates

Save your code before making modifications. This practice provides a fallback in case of error and a baseline for testing and validation. Use a consistent file naming convention. For example, add a two-digit suffix to the file name for each file in a sequence.

### Key Points to Remember

- Back up your MATLAB code before you modify it.

- Decide on a naming convention for your files and save interim versions frequently. For example, this tutorial uses a two-digit suffix to differentiate the various versions of the filter algorithm.
- For simulation purposes, before generating code, call your MATLAB code using `coder.extrinsic` to check that your algorithm is suitable for use in Simulink. This practice provides these benefits:
  - You do not have to make the MATLAB code suitable for code generation.
  - You can debug your MATLAB code in MATLAB while calling it from Simulink.
- Create a Simulink Coder code generation report. This HTML report provides easy access to the list of generated files with a summary of the configuration settings used to generate the code.

## See Also

`coder.extrinsic`

## Related Examples

- “Filter Audio Signal Using MATLAB Code” on page 40-191
- “Create Model That Uses MATLAB Function Block” on page 40-9
- “Code Generation for Variable-Size Arrays” on page 48-2
- “Getting Started with Simulink Coder” (Simulink Coder)

## More About

- “What Is a MATLAB Function Block?” on page 40-5
- “When to Generate Code from MATLAB Algorithms” on page 43-2
- “Functions and Objects Supported for C/C++ Code Generation — Alphabetical List” on page 44-2



# Filter Audio Signal Using MATLAB Code

## In this section...

- “Learning Objectives” on page 40-191
- “Tutorial Prerequisites” on page 40-191
- “Example: The LMS Filter” on page 40-192
- “Files for the Tutorial” on page 40-194
- “Tutorial Steps” on page 40-196

## Learning Objectives

In this tutorial, you will learn how to:

- Use the MATLAB Function block to add MATLAB functions to Simulink models for modeling, simulation, and deployment to embedded processors.

This capability is useful for coding algorithms that are better stated in the textual language of MATLAB than in the graphical language of Simulink.

- Use `coder.extrinsic` to call MATLAB code from a MATLAB Function block.

This capability allows you to call existing MATLAB code from Simulink without first having to make this code suitable for code generation, allowing for rapid prototyping.

- Check that existing MATLAB code is suitable for code generation.
- Convert a MATLAB algorithm from batch processing to streaming.
- Use persistent variables in code that is suitable for code generation.

You need to make the filter weights persistent so that the filter algorithm does not reset their values each time it runs.

## Tutorial Prerequisites

- “What You Need to Know” on page 40-192
- “Required Products” on page 40-192

### What You Need to Know

To work through this tutorial, you should have basic familiarity with MATLAB software. You should also understand how to create a basic Simulink model and how to simulate that model. For more information, see “Create Simple Model”.

### Required Products

To complete this tutorial, you must install the following products:

- MATLAB
- MATLAB Coder
- Simulink
- Simulink Coder
- DSP System Toolbox
- C compiler

For a list of supported compilers, see [http://www.mathworks.com/support/compilers/current\\_release/](http://www.mathworks.com/support/compilers/current_release/).

For instructions on installing MathWorks products, refer to the installation documentation. If you have installed MATLAB and want to check which other MathWorks products are installed, enter `ver` in the MATLAB Command Window. For instructions on installing and setting up a C compiler, see “Setting Up the C or C++ Compiler” (MATLAB Coder).

### Example: The LMS Filter

- “Description” on page 40-192
- “Algorithm” on page 40-193
- “Filtering Process” on page 40-194
- “Reference” on page 40-194

#### Description

A least mean squares (LMS) filter is an adaptive filter that adjusts its transfer function according to an optimizing algorithm. You provide the filter with an example of the desired signal together with the input signal. The filter then calculates the filter weights, or coefficients, that produce the least mean squares of the error between the output signal and the desired signal.

This example uses an LMS filter to remove the noise in a music recording. There are two inputs. The first input is the distorted signal: the music recording plus the filtered noise. The second input is the desired signal: the unfiltered noise. The filter works to eliminate the difference between the output signal and the desired signal and outputs the difference, which, in this case, is the clean music recording. When you start the simulation, you hear both the noise and the music. Over time, the adaptive filter removes the noise so you hear only the music.

### Algorithm

This example uses the least mean squares (LMS) algorithm to remove noise from an input signal. The LMS algorithm computes the filtered output, filter error, and filter weights given the distorted and desired signals.

At the start of the tutorial, the LMS algorithm uses a batch process to filter the audio input. This algorithm is suitable for MATLAB, where you are likely to load in the entire signal and process it all at once. However, a batch process is not suitable for processing a signal in real time. As you work through the tutorial, you refine the design of the filter to convert the algorithm from batch-based to stream-based processing.

The baseline function signature for the algorithm is:

```
function [ signal_out, err, weights ] = ...
    lms_01(signal_in, desired)
```

The filtering is performed in the following loop:

```
for n = 1:SignalLength
    % Compute the output sample using convolution:
    signal_out(n,ch) = weights' * signal_in(n:n+FilterLength-1,ch);
    % Update the filter coefficients:
    err(n,ch) = desired(n,ch) - signal_out(n,ch) ;
    weights = weights + mu*err(n,ch)*signal_in(n:n+FilterLength-1,ch);
end
```

where `SignalLength` is the length of the input signal, `FilterLength` is the filter length, and `mu` is the adaptation step size.

### What Is the Adaptation Step Size?

LMS algorithms have a step size that determines the amount of correction to apply as the filter adapts from one iteration to the next. Choosing the appropriate step size requires experience in adaptive filter design. A step size that is too small increases the time for the filter to converge. Filter convergence is the process where the error

signal (the difference between the output signal and the desired signal) approaches an equilibrium state over time. A step size that is too large might cause the adapting filter to overshoot the equilibrium and become unstable. Generally, smaller step sizes improve the stability of the filter at the expense of the time it takes to adapt.

### Filtering Process

The filtering process has three phases:

- Convolution

The convolution for the filter is performed in:

```
signal_out(n,ch) = weights' * signal_in(n:n+FilterLength-1,ch);
```

### What Is Convolution?

Convolution is the mathematical foundation of filtering. In signal processing, convolving two vectors or matrices is equivalent to filtering one of the inputs by the other. In this implementation of the LMS filter, the convolution operation is the vector dot product between the filter weights and a subset of the distorted input signal.

- Calculation of error

The error is the difference between the desired signal and the output signal:

```
err(n,ch) = desired(n,ch) - signal_out(n,ch);
```

- Adaptation

The new value of the filter weights is the old value of the filter weights plus a correction factor that is based on the error signal, the distorted signal, and the adaptation step size:

```
weights = weights + mu*err(n,ch)*signal_in(n:n+FilterLength-1,ch);
```

### Reference

Haykin, Simon. *Adaptive Filter Theory*. Upper Saddle River, NJ: Prentice-Hall, Inc., 1996.

### Files for the Tutorial

- “About the Tutorial Files” on page 40-195

- “Location of Files” on page 40-195
- “Names and Descriptions of Files” on page 40-195

### About the Tutorial Files

The tutorial uses the following files:

- Simulink model files for each step of the tutorial.
- MATLAB code files for each step of the example.

Throughout this tutorial, you work with Simulink models that call MATLAB files that contain a simple least mean squares (LMS) filter algorithm.

### Location of Files

The tutorial files are available in the following folder: `docroot\toolbox\simulink\examples\lms`. To run the tutorial, you must copy these files to a local folder. For instructions, see “Copying Files Locally” on page 40-196.

### Names and Descriptions of Files

Type	Name	Description
MATLAB files	<code>lms_01</code>	Baseline MATLAB implementation of batch filter. Not suitable for code generation.
	<code>lms_02</code>	Filter modified from batch to streaming.
	<code>lms_03</code>	Frame-based streaming filter with Reset and Adapt controls.
	<code>lms_04</code>	Frame-based streaming filter with Reset and Adapt controls. Suitable for code generation.
	<code>lms_05</code>	Disabled inlining for code generation.
	<code>lms_06</code>	Demonstrates use of <code>coder.nullcopy</code> .
Simulink model files	<code>acoustic_environment</code>	Simulink model that provides an overview of the acoustic environment.
	<code>noise_cancel_00</code>	Simulink model without a MATLAB Function block.
	<code>noise_cancel_01</code>	Complete <code>noise_cancel_00</code> model including a MATLAB Function block.

Type	Name	Description
	noise_cancel_02	Simulink model for use with lms_02.m.
	noise_cancel_03	Simulink model for use with lms_03.m.
	noise_cancel_04	Simulink model for use with lms_04.m.
	noise_cancel_05	Simulink model for use with lms_05.m.
	noise_cancel_06	Simulink model for use with lms_06.m.
	design_templates	Simulink model containing Adapt and Reset controls.

## Tutorial Steps

- “Copying Files Locally” on page 40-196
- “Setting Up Your C Compiler” on page 40-197
- “Running the acoustic\_environment Model” on page 40-197
- “Adding a MATLAB Function Block to Your Model” on page 40-198
- “Calling Your MATLAB Code As an Extrinsic Function for Rapid Prototyping” on page 40-199
- “Simulating the noise\_cancel\_01 Model” on page 40-201
- “Modifying the Filter to Use Streaming” on page 40-203
- “Adding Adapt and Reset Controls” on page 40-208
- “Generating Code” on page 40-212
- “Optimizing the LMS Filter Algorithm” on page 40-216

## Copying Files Locally

Copy the tutorial files to a local folder:

- 1 Create a local *solutions* folder, for example, `c:\test\lms\solutions`.
- 2 Change to the `docroot\toolbox\simulink\examples` folder. At the MATLAB command line, enter:

```
cd(fullfile(docroot, 'toolbox', 'simulink', 'examples'))
```
- 3 Copy the contents of the `lms` subfolder to your *solutions* folder, specifying the full path name of the *solutions* folder:

```
copyfile('lms', 'solutions')
```

Your *solutions* folder now contains a complete set of solutions for the tutorial. If you do not want to perform the steps for each task, you can view the supplied solution to see how the code should look.

- 4 Create a local *work* folder, for example, `c:\test\lms\work`.
- 5 Copy the following files from your *solutions* folder to your *work* folder.
  - `lms_01`
  - `lms_02`
  - `noise_cancel_00`
  - `acoustic_environment`
  - `design_templates`

Your *work* folder now contains all the files that you need to get started.

You are now ready to set up your C compiler.

### Setting Up Your C Compiler

Building your MATLAB Function block requires a supported compiler. MATLAB automatically selects one as the default compiler. If you have multiple MATLAB-supported compilers installed on your system, you can change the default using the `mex -setup` command. See “Change Default Compiler” (MATLAB) and the list of .

### Running the `acoustic_environment` Model

Run the `acoustic_environment` model supplied with the tutorial to understand the problem that you are trying to solve using the LMS filter. This model adds band-limited white noise to an audio signal and outputs the resulting signal to a speaker.

To simulate the model:

- 1 Open the `acoustic_environment` model in Simulink:
  - a Set your MATLAB current folder to the folder that contains your working files for this tutorial. At the MATLAB command line, enter:

```
cd work
```

where *work* is the full path name of the folder containing your files. See “Find Files and Folders” (MATLAB) for more information.
  - b At the MATLAB command line, enter:

```
acoustic_environment
```

- 2 Ensure that your speakers are on.
- 3 To simulate the model, from the Simulink model window, select **Simulation > Run**.  
As Simulink runs the model, you hear the audio signal distorted by noise.
- 4 While the simulation is running, double-click the Manual Switch to select the audio source.

Now you hear the desired audio input without any noise.

The goal of this tutorial is to use a MATLAB LMS filter algorithm to remove the noise from the noisy audio signal. You do this by adding a MATLAB Function block to the model and calling the MATLAB code from this block.

### Adding a MATLAB Function Block to Your Model

To modify the model and code yourself, work through the exercises in this section. Otherwise, open the supplied model `noise_cancel_01` in your *solutions* subfolder to see the modified model.

For the purposes of this tutorial, you add the MATLAB Function block to the `noise_cancel_00` model supplied with the tutorial. In practice, you would have to develop your own test bench starting with an empty Simulink model.

To add a MATLAB Function block to the `noise_cancel_00` model:

- 1 Open `noise_cancel_00` in Simulink.  

```
noise_cancel_00
```
- 2 Add a MATLAB Function block to the model:
  - a At the MATLAB command line, type `slLibraryBrowser` to open the Simulink Library Browser.
  - b From the list of Simulink libraries, select the **User-Defined Functions** library.
  - c Click the MATLAB Function block and drag it into the `noise_cancel_00` model. Place the block just above the red text annotation **Place MATLAB Function Block here**.
  - d Delete the red text annotations from the model.
  - e Save the model in the current folder as `noise_cancel_01`.



## Calling Your MATLAB Code As an Extrinsic Function for Rapid Prototyping

In this part of the tutorial, you use the `coder.extrinsic` function to call your MATLAB code from the MATLAB Function block for rapid prototyping.

### Why Call MATLAB Code As an Extrinsic Function?

Calling MATLAB code as an extrinsic function provides these benefits:

- For rapid prototyping, you do not have to make the MATLAB code suitable for code generation.
- Using `coder.extrinsic` enables you to debug your MATLAB code in MATLAB. You can add one or more breakpoints in the `lms_01.m` file, and then start the simulation in Simulink. When the MATLAB execution engine encounters a breakpoint, it temporarily halts execution so that you can inspect the MATLAB workspace and view the current values of all variables in memory. For more information about debugging MATLAB code, see “Debug a MATLAB Program” (MATLAB).

### How to Call MATLAB Code As an Extrinsic Function

To call your MATLAB code from the MATLAB Function block:

- 1 Double-click the MATLAB Function block to open the MATLAB Function Block Editor.
- 2 Delete the default code displayed in the MATLAB Function Block Editor.
- 3 Copy the following code to the MATLAB Function block.

```
function [ Signal_Out, Weights ] = LMS(Noise_In, Signal_In) %#codegen
    % Extrinsic:
    coder.extrinsic('lms_01');

    % Compute LMS:
    [ ~, Signal_Out, Weights ] = lms_01(Noise_In, Signal_In);
end
```

### Why Use the Tilde (~) Operator?

Because the LMS function does not use the first output from `lms_01`, replace this output with the MATLAB `~` operator. MATLAB ignores inputs and outputs specified by `~`. This syntax helps avoid confusion in your program code and unnecessary clutter in your workspace, and allows you to reuse existing algorithms without modification.

- 4 Save the model.

The `lms_01` function inputs `Noise_In` and `Signal_In` now appear as input ports to the block and the function outputs `Signal_Out` and `Weights` appear as output ports.

### Connecting the MATLAB Function Block Inputs and Outputs

- 1 Connect the MATLAB Function block inputs and outputs so that your model looks like this.

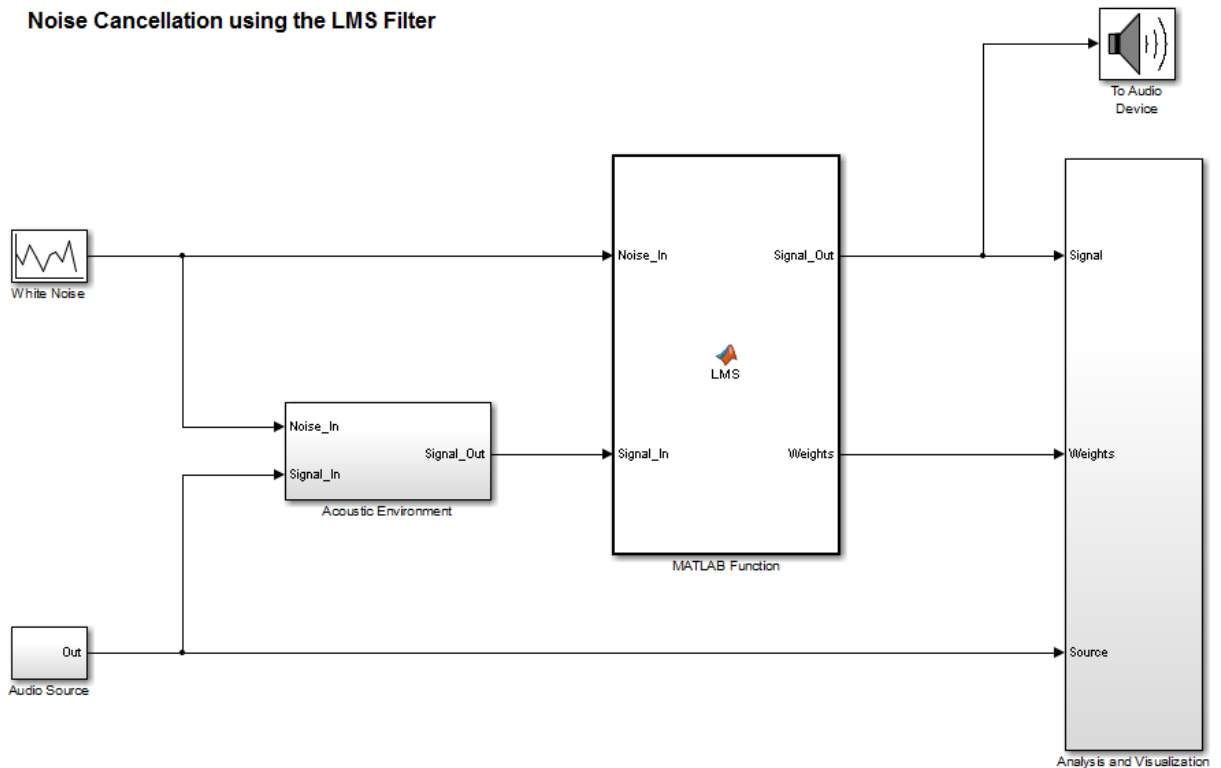

See “Block and Signal Line Shortcuts and Actions” on page 1-91 for more information.

- 2 In the MATLAB Function block code, preallocate the outputs by adding the following code after the extrinsic call:

```
% Outputs:  
Signal_Out = zeros(size(Signal_In));  
Weights = zeros(32,1);  
The size of Weights is set to match the Numerator coefficients of the Digital Filter  
in the Acoustic Environment subsystem.
```

### Why Preallocate the Outputs?

For code generation, you must assign variables explicitly to have a specific class, size, and complexity before using them in operations or returning them as outputs in MATLAB functions. For more information, see “Differences Between Generated Code and MATLAB Code” on page 43-9.

#### 3 Save the model.

You are now ready to check your model for errors.

### Simulating the noise\_cancel\_01 Model

To simulate the model:

#### 1 Ensure that you can see the **Time Domain** plots.

To view the plots, in the `noise_cancel_01` model, open the Analysis and Visualization block and then open the Time Domain block.

#### 2 In the Simulink model window, select **Simulation > Run**.

As Simulink runs the model, you see and hear outputs. Initially, you hear the audio signal distorted by noise. Then the filter attenuates the noise gradually, until you hear only the music playing with very little noise remaining. After two seconds, you hear the distorted noisy signal again and the filter attenuates the noise again. This cycle repeats continuously.

MATLAB displays the following plot showing this cycle.

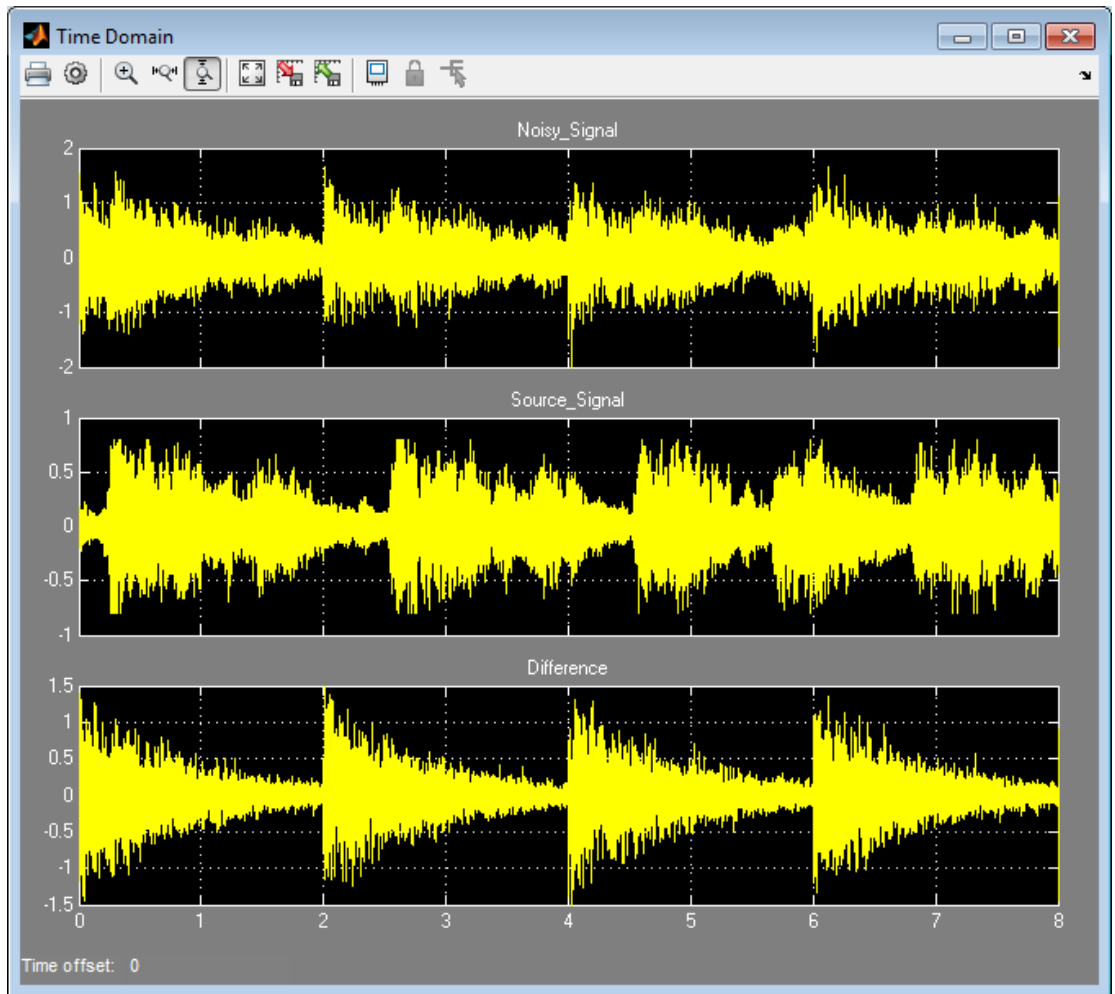

3 Stop the simulation.

### Why Does the Filter Reset Every 2 Seconds?

The filter resets every 2 seconds because the model uses 16384 samples per frame and a sampling rate of 8192, so the 16384 samples represent 2 seconds of audio.

To see the model configuration:

- 1 Double-click the White Noise subsystem and note that it uses a **Sample time** of  $1/F_s$  and **Samples per frame** of `FrameSize`. The music in the Audio Source subsystem also uses these values.
- 2 `FrameSize` is set in the model `InitFcn` callback. To view this callback:
  - a Right-click inside the model window and select **Model Properties** from the context menu.
  - b Select the **Callbacks** tab.
  - c Select `InitFcn` in the **Model callbacks** pane.

Note that `FrameSize = 16*1024`, which is 16384.

- 3 `Fs` is set in the model `PostLoadFcn` callback. To view this callback, select `PostLoadFcn` in the **Model callbacks** pane:

The following MATLAB commands set up `Fs`:

```
data = load('handel.mat');  
music = data.y;  
Fs = data.Fs;
```

### Modifying the Filter to Use Streaming

- “What Is Streaming?” on page 40-203
- “Why Use Streaming?” on page 40-203
- “Viewing the Modified MATLAB Code” on page 40-204
- “Summary of Changes to the Filter Algorithm” on page 40-204
- “Modifying Your Model to Call the Updated Algorithm” on page 40-205
- “Simulating the Streaming Algorithm” on page 40-206

### What Is Streaming?

A streaming filter is called repeatedly to process fixed-size chunks of input data, or *frames*, until it has processed the entire input signal. The frame size can be as small as a single sample, in which case the filter would be operating in a sample-based mode, or up to a few thousand samples, for frame-based processing.

### Why Use Streaming?

The design of the filter algorithm in `lms_01` has the following disadvantages:

- The algorithm does not use memory efficiently.

Preallocating a fixed amount of memory for each input signal for the lifetime of the program means more memory is allocated than is in use.

- You must know the size of the input signal at the time you call the function.

If the input signal is arriving in real time or as a stream of samples, you would have to wait to accumulate the entire signal before you could pass it, as a batch, to the filter.

- The signal size is limited to a maximum size.

In an embedded application, the filter is likely to be processing a continuous input stream. As a result, the input signal can be substantially longer than the maximum length that a filter working in batch mode could possibly handle. To make the filter work for any signal length, it must run in real time. One solution is to convert the filter from batch-based processing to stream-based processing.

### Viewing the Modified MATLAB Code

The conversion to streaming involves:

- Introducing a first-in, first-out (FIFO) queue

The FIFO queue acts as a temporary storage buffer, which holds a small number of samples from the input data stream. The number of samples held by the FIFO queue must be exactly the same as the number of samples in the filter's impulse response, so that the function can perform the convolution operation between the filter coefficients and the input signal.

- Making the FIFO queue and the filter weights persistent

The filter is called repeatedly until it has processed the entire input signal. Therefore, the FIFO queue and filter weights need to persist so that the adaptation process does not have to start over again after each subsequent call to the function.

Open the supplied file `lms_02.m` in your *work* subfolder to see the modified algorithm.

### Summary of Changes to the Filter Algorithm

Note the following important changes to the filter algorithm:

- The filter weights and the FIFO queue are declared as persistent:

```
persistent weights;  
persistent fifo;
```

- The FIFO queue is initialized:

```
fifo = zeros(FilterLength,ChannelCount);
```

- The FIFO queue is used in the filter update loop:

```
% For each channel:
for ch = 1:ChannelCount

    % For each sample time:
    for n = 1:FrameSize

        % Update the FIFO shift register:
        fifo(1:FilterLength-1,ch) = fifo(2:FilterLength,ch);
        fifo(FilterLength,ch) = signal_in(n,ch);

        % Compute the output sample using convolution:
        signal_out(n,ch) = weights' * fifo(:,ch);

        % Update the filter coefficients:
        err(n,ch) = desired(n,ch) - signal_out(n,ch) ;
        weights = weights + mu*err(n,ch)*fifo(:,ch);

    end
end
```

- You cannot output a persistent variable. Therefore, a new variable, `weights_out`, is used to output the filter weights:

```
function [ signal_out, err, weights_out ] = ...
    lms_02(distorted, desired)

weights_out = weights;
```

### Modifying Your Model to Call the Updated Algorithm

To modify the model yourself, work through the exercises in this section. Otherwise, open the supplied model `noise_cancel_02` in your *solutions* subfolder to see the modified model.

- 1 In the `noise_cancel_01` model, double-click the MATLAB Function block to open the MATLAB Function Block Editor.
- 2 Modify the MATLAB Function block code to call `lms_02`.
  - a Modify the extrinsic call.

```
% Extrinsic:  
coder.extrinsic('lms_02');
```

- b** Modify the call to the filter algorithm.

```
% Compute LMS:  
[ ~, Signal_Out, Weights ] = lms_02(Noise_In, Signal_In);
```

### Modified MATLAB Function Block Code

Your MATLAB Function block code should now look like this:

```
function [ Signal_Out, Weights ] = LMS(Noise_In, Signal_In)  
% Extrinsic:  
coder.extrinsic('lms_02');  
% Outputs:  
Signal_Out = zeros(size(Signal_In));  
Weights = zeros(32,1);  
% Compute LMS:  
[ ~, Signal_Out, Weights ] = lms_02(Noise_In, Signal_In);  
end
```

- 3** Change the frame size from 16384 to 64, which represents a more realistic value.
  - a** Right-click inside the model window and select **Model Properties** from the context menu.
  - b** Select the **Callbacks** tab.
  - c** In the **Model callbacks** list, select **InitFcn**.
  - d** Change the value of **FrameSize** to 64.
  - e** Click **Apply** and close the dialog box.
- 4** Save your model as `noise_cancel_02`.

### Simulating the Streaming Algorithm

To simulate the model:

- 1** Ensure that you can see the **Time Domain** plots.
- 2** Start the simulation.

As Simulink runs the model, you see and hear outputs. Initially, you hear the audio signal distorted by noise. Then, during the first few seconds, the filter attenuates the noise gradually, until you hear only the music playing with very little noise



remaining. MATLAB displays the following plot showing filter convergence after only a few seconds.

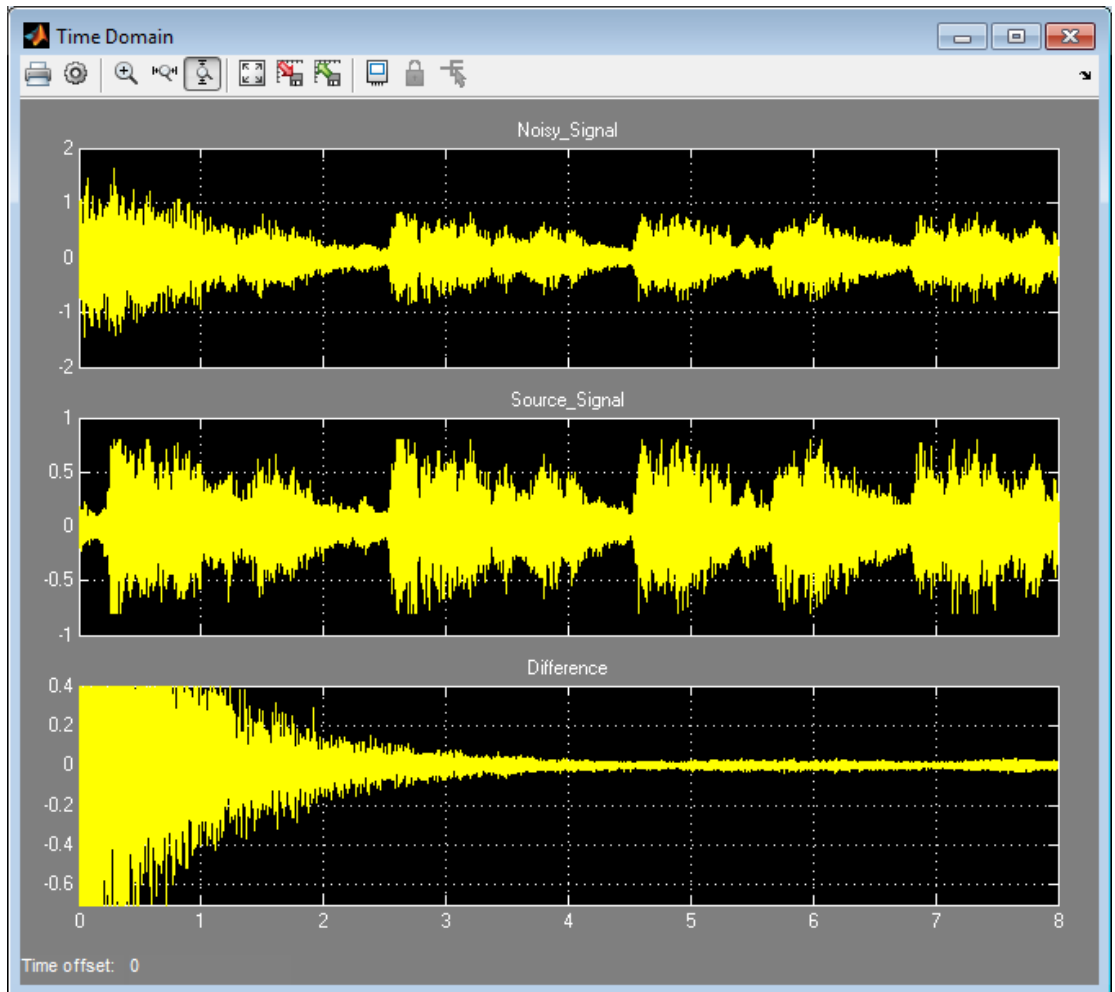

### 3 Stop the simulation.

The filter algorithm is now suitable for Simulink. You are ready to elaborate your model to use Adapt and Reset controls.

### Adding Adapt and Reset Controls

- “Why Add Adapt and Reset Controls?” on page 40-208
- “Modifying Your MATLAB Code” on page 40-208
- “Modifying Your Model to Use Reset and Adapt Controls” on page 40-209
- “Simulating the Model with Adapt and Reset Controls” on page 40-211

### Why Add Adapt and Reset Controls?

In this part of the tutorial, you add Adapt and Reset controls to your filter. Using these controls, you can turn the filtering on and off. When **Adapt** is enabled, the filter continuously updates the filter weights. When **Adapt** is disabled, the filter weights remain at their current values. If **Reset** is set, the filter resets the filter weights.

### Modifying Your MATLAB Code

To modify the code yourself, work through the exercises in this section. Otherwise, open the supplied file `lms_03.m` in your *solutions* subfolder to see the modified algorithm.

To modify your filter code:

- 1 Open `lms_02.m`.
- 2 In the **Set up** section, replace  

```
if ( isempty(weights) )  
with  
  
if ( reset || isempty(weights) )
```
- 3 In the filter loop, update the filter coefficients only if **Adapt** is **ON**.  

```
if adapt  
    weights = weights + mu*err(n,ch)*fifo(:,ch);  
end
```
- 4 Change the function signature to use the **Adapt** and **Reset** inputs and change the function name to `lms_03`.  

```
function [ signal_out, err, weights_out ] = ...  
    lms_03(signal_in, desired, reset, adapt)
```
- 5 Save the file in the current folder as `lms_03.m`:

### Summary of Changes to the Filter Algorithm

Note the following important changes to the filter algorithm:

- The new input parameter `reset` is used to determine if it is necessary to reset the filter coefficients:

```
if ( reset || isempty(weights) )
    % Filter coefficients:
    weights = zeros(L,1);
    % FIFO Shift Register:
    fifo = zeros(L,1);
end
```

- The new parameter `adapt` is used to control whether the filter coefficients are updated or not.

```
if adapt
    weights = weights + mu*err(n)*fifo;
end
```

### Modifying Your Model to Use Reset and Adapt Controls

To modify the model yourself, work through the exercises in this section. Otherwise, open the supplied model `noise_cancel_03` in your *solutions* subfolder to see the modified model.

- 1 Open the `noise_cancel_02` model.
- 2 Double-click the MATLAB Function block to open the MATLAB Function Block Editor.
- 3 Modify the MATLAB Function block code:

- a Update the function declaration.

```
function [ Signal_Out, Weights ] = ...
    LMS(Adapt, Reset, Noise_In, Signal_In )
```

- b Update the extrinsic call.

```
coder.extrinsic('lms_03');
```

- c Update the call to the LMS algorithm.

```
% Compute LMS:
[ ~, Signal_Out, Weights ] = ...
    lms_03(Noise_In, Signal_In, Reset, Adapt);
```

- d Close the MATLAB Function Block Editor.

The `lms_03` function inputs `Reset` and `Adapt` now appear as input ports to the MATLAB Function block.

- 4 Open the `design_templates` model.

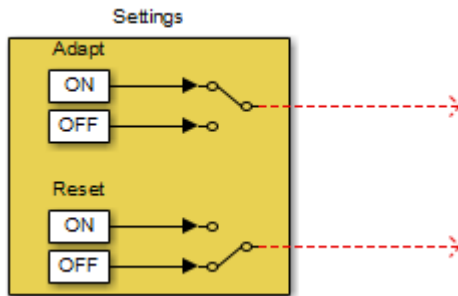

- 5 Copy the `Settings` block from this model to your `noise_cancel_02` model:
  - a From the `design_templates` model menu, select **Edit > Select All**.
  - b Select **Edit > Copy**.
  - c From the `noise_cancel_02` model menu, select **Edit > Paste**.
- 6 Connect the `Adapt` and `Reset` outputs of the `Settings` subsystem to the corresponding inputs on the MATLAB Function block. Your model should now appear as follows.

## Noise Cancellation using the LMS Filter

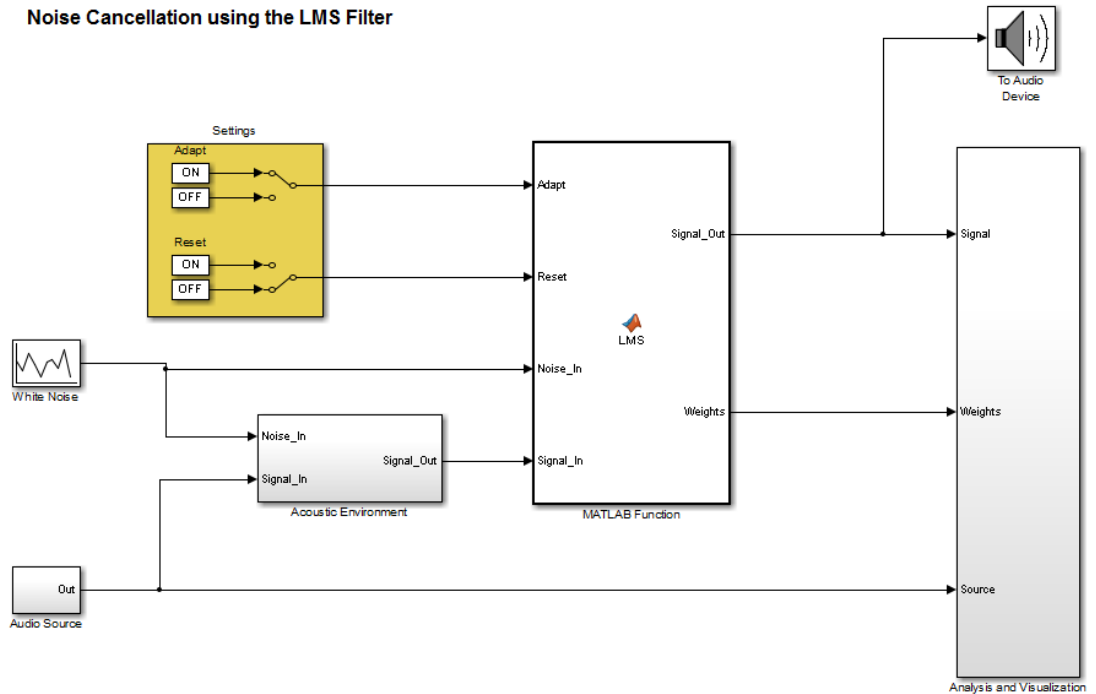

7 Save the model as `noise_cancel_03`.

### Simulating the Model with Adapt and Reset Controls

To simulate the model and see the effect of the Adapt and Reset controls:

- 1 In the `noise_cancel_03` model, view the Convergence scope:
  - a Double-click the Analysis and Visualization subsystem.
  - b Double-click the Convergence scope.
- 2 In the Simulink model window, select **Simulation > Run**.

Simulink runs the model as before. While the model is running, toggle the Adapt and Reset controls and view the Convergence scope to see their effect on the filter.

The filter converges when **Adapt** is ON and **Reset** is OFF, then resets when you toggle **Reset**. The results might look something like this:

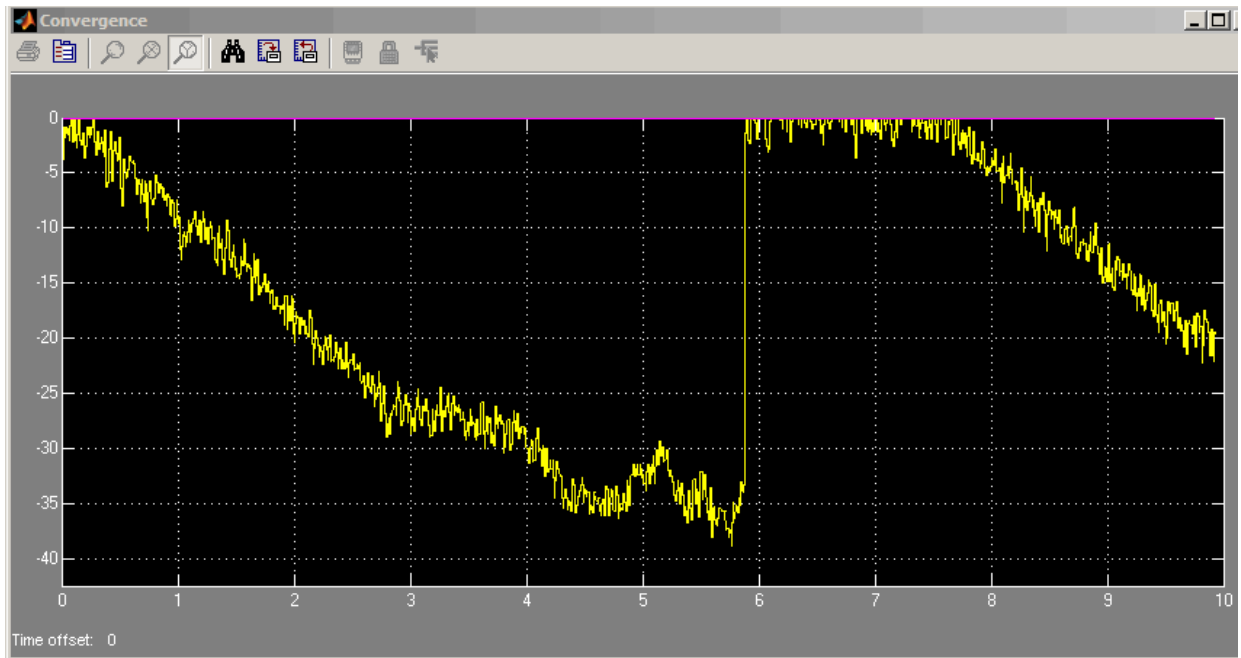

- 3 Stop the simulation.

### Generating Code

You have proved that your algorithm works in Simulink. Next you generate code for your model. Before generating code, you must ensure that your MATLAB code is suitable for code generation. For code generation, you must remove the extrinsic call to your code.

#### Making Your Code Suitable for Code Generation

To modify the model and code yourself, work through the exercises in this section. Otherwise, open the supplied model `noise_cancel_04` and file `lms_04.m` in your *solutions* subfolder to see the modifications.

- 1 Rename the MATLAB Function block to `LMS_Filter`. Select the annotation `MATLAB Function` below the MATLAB Function block and replace the text with `LMS_Filter`.

When you generate code for the MATLAB Function block, Simulink Coder uses the name of the block in the generated code. It is good practice to use a meaningful name.

- 2 In your `noise_cancel_03` model, double-click the MATLAB Function block.

The MATLAB Function Block Editor opens.

- 3 Delete the extrinsic declaration.

```
% Extrinsic:
coder.extrinsic('lms_03');
```

- 4 Delete the preallocation of outputs.

```
% Outputs:
Signal_Out = zeros(size(Signal_In));
Weights = zeros(32,1);
```

- 5 Modify the call to the filter algorithm.

```
% Compute LMS:
[~, Signal_Out, Weights] = ...
    lms_04(Noise_In, Signal_In, Reset, Adapt);
```

- 6 Save the model as `noise_cancel_04`.

- 7 Open `lms_03.m`

- a Modify the function name to `lms_04`.
- b Turn on error checking specific to code generation by adding the `%codegen` compilation directive after the function declaration.

```
function [ signal_out, err, weights_out ] = ...
    lms_04(signal_in, desired, reset, adapt) %codegen
```

The code analyzer message indicator in the top right turns red to indicate that the code analyzer has detected code generation issues. The code analyzer underlines the offending code in red and places a red marker to the right of it.

- 8 Move your pointer over the first red marker to view the error information.

The code analyzer detects that code generation requires `signal_out` to be fully defined before subscripting it and does not support growth of variable size data through indexing.

- 9 Move your pointer over the second red marker and note that the code analyzer detects the same errors for `err`.
- 10 To address these errors, preallocate the outputs `signal_out` and `err`. Add this code after the filter setup.

```
% Output Arguments:  
  
% Pre-allocate output and error signals:  
signal_out = zeros(FrameSize,ChannelCount);  
err = zeros(FrameSize,ChannelCount);
```

### Why Preallocate the Outputs?

You must preallocate outputs here because code generation does not support increasing the size of an array over time. Repeatedly expanding the size of an array over time can adversely affect the performance of your program. See “Preallocating Memory” (MATLAB).

The red error markers for the two lines of code disappear. The code analyzer message indicator in the top right edge of the code turns green, which indicates that you have fixed all the errors and warnings detected by the code analyzer.

- 11 Save the file as `lms_04.m`.

### Generating Code for `noise_cancel_04`

- 1 Before generating code, ensure that Simulink Coder creates a code generation report. This HTML report provides easy access to the list of generated files with a summary of the configuration settings used to generate the code.
  - a In the Simulink model window, select **Simulation > Model Configuration Parameters**.
  - b In the left pane of the Configuration Parameters dialog box, select **Code Generation > Report**.
  - c In the right pane, select **Create code generation report**.  
  
The **Launch report automatically** option is also selected.
  - d Click **Apply** and close the Configuration Parameters dialog box.
  - e Save your model.
- 2 To generate code for the LMS Filter subsystem:



- a In your model, select the LMS Filter subsystem.
- b From the Build Model tool menu, select **Build Selected Subsystem**.

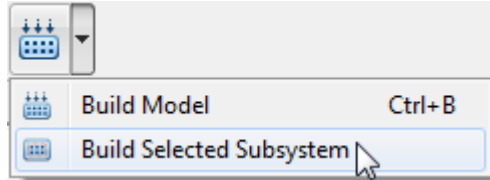

The **Build code for subsystem** dialog box appears. Click the **Build** button.

The Simulink Coder software generates C code for the subsystem and launches the code generation report.

For more information on using the code generation report, see “Generate a Code Generation Report” (Simulink Coder) in the Simulink Coder documentation.

- c In the left pane of the code generation report, click the `LMS_Filter.c` link to view the generated C code. Note that the `lms_04` function has no code because inlining is enabled by default.
- 3** Modify your filter algorithm to disable inlining:
- a In `lms_04.m`, after the function declaration, add:
 

```
coder.inline('never')
```
  - b Change the function name to `lms_05` and save the file as `lms_05.m` in the current folder.
  - c In your `noise_cancel_04` model, double-click the MATLAB Function block.
 

The MATLAB Function Block Editor opens.
  - d Modify the call to the filter algorithm to call `lms_05`.
 

```
% Compute LMS:
[ ~, Signal_Out, Weights ] = ...
    lms_05(Noise_In, Signal_In, Reset, Adapt);
```
  - e Save the model as `noise_cancel_05`.
- 4** Generate code for the updated model.
- a In the model, select the LMS Filter subsystem.

- b** From the Build Model tool menu, select **Build Selected Subsystem**.

The **Build code for subsystem** dialog box appears.

- c** Click the **Build** button.

The Simulink Coder software generates C code for the subsystem and launches the code generation report.

- d** In the left pane of the code generation report, click the `LMS_Filter.c` link to view the generated C code.

This time the `lms_05` function has code because you disabled inlining.

```
/* Forward declaration for local functions */
static void LMS_Filter_lms_05 ...
    (const real_T signal_in[64],const real_T ...
     desired[64], real_T reset, real_T adapt, ...
     real_T signal_out[64], ...
     real_T err[64], real_T weights_out[32]);

/* Function for MATLAB Function Block: 'root/LMS_Filter' */
static void LMS_Filter_lms_05 ...
    (const real_T signal_in[64], const real_T ...
     desired[64], real_T reset, real_T adapt, ...
     real_T signal_out[64], ...
     real_T err[64], real_T weights_out[32])
```

### Optimizing the LMS Filter Algorithm

This part of the tutorial demonstrates when and how to preallocate memory for a variable without incurring the overhead of initializing memory in the generated code.

In `lms_05.m`, the MATLAB code not only declares `signal_out` and `err` to be a `FrameSize-by-ChannelCount` vector of real doubles, but also initializes each element of `signal_out` and `err` to zero. These signals are initialized to zero in the generated C code.

MATLAB Code	Generated C Code
<pre>% Pre-allocate output and error signals: signal_out = zeros(FrameSize,ChannelCount); err = zeros(FrameSize,ChannelCount);</pre>	<pre>/* Pre-allocate output and error signals: */ 79 for (i = 0; i &lt; 64; i++) { 80 signal_out[i] = 0.0;</pre>

MATLAB Code	Generated C Code
	81 err[i] = 0.0; 82 }

This forced initialization is unnecessary because both `signal_out` and `err` are explicitly initialized in the MATLAB code before they are read.

---

**Note:** You should not use `coder.nullcopy` when declaring the variables `weights` and `fifo` because these variables need to be initialized in the generated code. Neither variable is explicitly initialized in the MATLAB code before they are read.

---

Use `coder.nullcopy` in the declaration of `signal_out` and `err` to eliminate the unnecessary initialization of memory in the generated code:

- 1 In `lms_05.m`, preallocate `signal_out` and `err` using `coder.nullcopy`:

```
% Pre-allocate output and error signals:
signal_out = coder.nullcopy(zeros(FrameSize, ChannelCount));
err = coder.nullcopy(zeros(FrameSize, ChannelCount));
```

---

**Caution:** After declaring a variable with `coder.nullcopy`, you must explicitly initialize the variable in your MATLAB code before reading it. Otherwise, you might get unpredictable results.

---

- 2 Change the function name to `lms_06` and save the file as `lms_06.m` in the current folder.
- 3 In your `noise_cancel_05` model, double-click the MATLAB Function block.

The MATLAB Function Block Editor opens.

- 4 Modify the call to the filter algorithm.

```
% Compute LMS:
[~, Signal_Out, Weights] = ...
    lms_06(Noise_In, Signal_In, Reset, Adapt);
```

- 5 Save the model as `noise_cancel_06`.

Generate code for the updated model.

- 1 Select the LMS Filter subsystem.

- 2 From the Build Model tool menu, select **Build Selected Subsystem**.

The **Build code for subsystem** dialog box appears. Click the **Build** button.

The Simulink Coder software and generates C code for the subsystem and launches the code generation report.

- 3 In the left pane of the code generation report, click the `LMS_Filter.c` link to view the generated C code.

In the generated C code, this time there is no initialization to zero of `signal_out` and `err`.

## See Also

`coder.extrinsic`

## Related Examples

- “Create Model That Uses MATLAB Function Block” on page 40-9
- “Track Object Using MATLAB Code” on page 40-167

## More About

- “What Is a MATLAB Function Block?” on page 40-5
- “MATLAB Function Block Editor” on page 40-34
- “MATLAB Function Reports” on page 40-48

## Encapsulating the Interface to External Code

Use the `coder.ExternalDependency` class to encapsulate the interface between external code and MATLAB code intended for code generation. With the encapsulation, you can separate the details of the interface from your MATLAB code. The methods of `coder.ExternalDependency`:

- specify the location of external files
- update build information
- define the programming interface for external functions

In your MATLAB code, you can call the external code without providing build information.

The workflow is:

- 1 Write a class definition file for a class that derives from `coder.ExternalDependency`.
- 2 Store the class definition file in a folder on the MATLAB path.
- 3 In your MATLAB code, use a method of the class to call an external function.
- 4 Generate code from your MATLAB code.

### See Also

`coder.ExternalDependency`

### Related Examples

- “Encapsulate Interface to an External C Library” on page 40-220

### More About

- “Best Practices for Using `coder.ExternalDependency`” on page 40-223

## Encapsulate Interface to an External C Library

Use `coder.ExternalDependency` to encapsulate the interface to an external C dynamic linked library .

Write a function `adder` that returns the sum of its inputs.

```
function c = adder(a,b)
    %#codegen
    c = a + b;
end
```

Generate a library that contains `adder`.

```
codegen('adder', '-args', {-2,5}, '-config:dll', '-report');
```

Write the class definition file `AdderAPI.m` to encapsulate the library interface.

```
%=====
% This class abstracts the API to an external Adder library.
% It implements static methods for updating the build information
% at compile time and build time.
%=====

classdef AdderAPI < coder.ExternalDependency
    %#codegen

    methods (Static)

        function bName = getDescriptiveName(~)
            bName = 'AdderAPI';
        end

        function tf = isSupportedContext(ctx)
            if ctx.isMatlabHostTarget()
                tf = true;
            else
                error('adder library not available for this target');
            end
        end

        function updateBuildInfo(buildInfo, ctx)
            [~, linkLibExt, execLibExt, ~] = ctx.getStdLibInfo();

            % Header files
        end
    end
end
```

```
hdrFilePath = fullfile(pwd, 'codegen', 'dll', 'adder');
buildInfo.addIncludePaths(hdrFilePath);

% Link files
linkFiles = strcat('adder', linkLibExt);
linkPath = hdrFilePath;
linkPriority = '';
linkPrecompiled = true;
linkLinkOnly = true;
group = '';
buildInfo.addLinkObjects(linkFiles, linkPath, ...
    linkPriority, linkPrecompiled, linkLinkOnly, group);

% Non-build files
nbFiles = 'adder';
nbFiles = strcat(nbFiles, execLibExt);
buildInfo.addNonBuildFiles(nbFiles, '', '');
end

%API for library function 'adder'
function c = adder(a, b)
    if coder.target('MATLAB')
        % running in MATLAB, use built-in addition
        c = a + b;
    else
        % running in generated code, call library function
        coder.cinclude('adder.h');

        % Because MATLAB Coder generated adder, use the
        % housekeeping functions before and after calling
        % adder with coder.ceval.
        % Call initialize function before calling adder for the
        % first time.

        coder.ceval('adder_initialize');
        c = 0;
        c = coder.ceval('adder', a, b);

        % Call the terminate function after
        % calling adder for the last time.

        coder.ceval('adder_terminate');
    end
end
```

```
        end
    end
end
```

Write a function `adder_main` that calls the external library function `adder`.

```
function y = adder_main(x1, x2)
%#codegen
    y = AdderAPI.adder(x1, x2);
end
```

Generate a MEX function for `adder_main`. The MEX Function exercises the `coder.ExternalDependency` methods.

```
codegen('adder_main', '-args', {7,9}, '-report')
```

Copy the library to the current folder using the file extension for your platform.

For Windows, use:

```
copyfile(fullfile(pwd, 'codegen', 'dll', 'adder', 'adder.dll'));
```

For Linux, use:

```
copyfile(fullfile(pwd, 'codegen', 'dll', 'adder', 'adder.so'));
```

For Mac, use:

```
copyfile(fullfile(pwd, 'codegen', 'dll', 'adder', 'adder.dylib'));
```

Run the MEX function and verify the result.

```
adder_main_mex(2,3)
```

## See Also

[coder.BuildConfig](#) | [coder.ExternalDependency](#) | [error](#)

## More About

- “Encapsulating the Interface to External Code” on page 40-219



## Best Practices for Using `coder.ExternalDependency`

### In this section...

“Terminate Code Generation for Unsupported External Dependency” on page 40-223

“Parameterize Methods for MATLAB and Generated Code” on page 40-223

“Parameterize `updateBuildInfo` for Multiple Platforms” on page 40-224

### Terminate Code Generation for Unsupported External Dependency

The `isSupportedContext` method returns true if the external code interface is supported in the build context. If the external code interface is not supported, do not return false. Instead, use `error` to terminate code generation with an error message. For example:

```
function tf = isSupportedContext(ctx)
    if ctx.isMatlabHostTarget()
        tf = true;
    else
        error('MyLibrary is not available for this target');
    end
end
```

### Parameterize Methods for MATLAB and Generated Code

Parameterize methods that call external functions so that the methods run in MATLAB. For example:

```
...
if coder.target('MATLAB')
    % running in MATLAB, use built-in addition
    c = a + b;
else
    % running in generated code, call library function
    coder.ceval('adder_initialize');
end
...
```

## Parameterize updateBuildInfo for Multiple Platforms

Parameterize the `updateBuildInfo` method to support multiple platforms. For example, use `coder.BuildConfig.getStdLibInfo` to get the platform-specific library file extensions.

```
...
    [~, linkLibExt, execLibExt, ~] = ctx.getStdLibInfo()
% Link files
linkFiles = strcat('adder', linkLibExt);
buildInfo.addLinkObjects(linkFiles, linkPath, linkPriority, ...
    linkPrecompiled, linkLinkOnly, group);
...
```

### See Also

`coder.BuildConfig` | `coder.ExternalDependency` | `error`

### Related Examples

- “Encapsulate Interface to an External C Library” on page 40-220

## Update Build Information from MATLAB code

You can control aspects of the build process that occur after code generation but before compilation. For example, you can specify compiler or linker options.

To customize the build from your MATLAB code:

- 1 In your MATLAB code, call `coder.updateBuildInfo` to update the build information object. You specify a build information object method and the input arguments for the method.
- 2 Generate code from your MATLAB code.

### See Also

`coder.updateBuildInfo`



# Define New System Objects

---

- “Customize System Block Appearance” on page 41-2
- “Customize System Block Dialog Box” on page 41-7
- “Specify Output” on page 41-20
- “Set Model Reference Discrete Sample Time Inheritance” on page 41-32
- “Use Update and Output for Nondirect Feedthrough” on page 41-34
- “Enable For Each Subsystem Support” on page 41-37
- “Define System Object for Use in Simulink” on page 41-39
- “Use Enumerations in System Objects” on page 41-45
- “Use Global Variables in System Objects” on page 41-46
- “Use System Objects in Simulink” on page 41-50
- “System Design in Simulink Using System Objects” on page 41-51

## Customize System Block Appearance

### In this section...

“Specify Input and Output Names” on page 41-2

“Add Text to Block Icon” on page 41-3

“Add Image to Block Icon” on page 41-5

### Specify Input and Output Names

Specify the names of the input and output ports of a System object–based block implemented using a MATLAB System block.

Use `getInputNamesImpl` and `getOutputNamesImpl` to specify the names of the input port as “source data” and the output port as “count.”

If you do not specify the `getInputNamesImpl` and `getOutputNamesImpl` methods, the object uses the `stepImpl` method input and output variable names for the input and output port names, respectively. If the `stepImpl` method uses *varargin* and *varargout* instead of variable names, the port names default to empty character vectors.

```
methods (Access = protected)
    function inputName = getInputNamesImpl(~)
        inputName = 'source data';
    end

    function outputName = getOutputNamesImpl(~)
        outputName = 'count';
    end
end
```

### Complete Class Definition File with Named Inputs and Outputs

```
classdef MyCounter < matlab.System

    % MyCounter Count values above a threshold

    properties
        Threshold = 1
    end
    properties (DiscreteState)
        Count
    end
end
```

```

methods
    function obj = MyCounter(varargin)
        setProperties (obj,nargin,varargin{:});
    end
end

methods (Access = protected)
    function setupImpl(obj)
        obj.Count = 0;
    end
    function resetImpl(obj)
        obj.Count = 0;
    end
    function y = stepImpl(obj,u)
        if (u > obj.Threshold)
            obj.Count = obj.Count + 1;
        end
        y = obj.Count;
    end
    function inputName = getInputNamesImpl(~)
        inputName = 'source data';
    end
    function outputName = getOutputNamesImpl(~)
        outputName = 'count';
    end
end
end

```

## Add Text to Block Icon

Add text to the block icon of a System object–based block implemented using a MATLAB System block.

- 1 Subclass from custom icon class.

```
classdef MyCounter < matlab.System & matlab.system.mixin.CustomIcon
```

- 2 Use `setIconImpl` to specify the block icon as `New Counter` with a line break between the two words.

```

methods (Access = protected)
    function icon = getIconImpl(~)
        icon = {'New', 'Counter'};
    end
end

```

end

### Complete Class Definition File with Defined Icon

```
classdef MyCounter < matlab.System & ...
    matlab.system.mixin.CustomIcon

    % MyCounter Count values above a threshold

    properties
        Threshold = 1
    end
    properties (DiscreteState)
        Count
    end

    methods
        function obj = MyCounter(varargin)
            setProperties(obj,nargin,varargin{:});
        end
    end

    methods (Access = protected)
        function setupImpl(obj)
            obj.Count = 0;
        end
        function resetImpl(obj)
            obj.Count = 0;
        end
        function y = stepImpl(obj,u)
            if (u > obj.Threshold)
                obj.Count = obj.Count + 1;
            end
            y = obj.Count;
        end
        function icon = getIconImpl(~)
            icon = {'New', 'Counter'};
        end
    end
end
end
```



## Add Image to Block Icon

Define an image on the block icon of a System object–based block implemented using a MATLAB System block.

- 1 Subclass from custom icon class.

```
classdef MyCounter < matlab.System & matlab.system.mixin.CustomIcon
```

- 2 Use `getIconImpl` method to call the `matlab.system.display.Icon` class and specify the image.

```
methods (Access = protected)
    function icon = getIconImpl(~)
        icon = matlab.system.display.Icon('counter.png');
    end
end
```

### Complete Class Definition File with Icon Image

```
classdef MyCounter < matlab.System & ...
    matlab.system.mixin.CustomIcon

    % MyCounter Count values above a threshold

    properties
        Threshold = 1
    end
    properties (DiscreteState)
        Count
    end

    methods
        function obj = MyCounter(varargin)
            setProperties(obj,nargin,varargin{:});
        end
    end

    methods (Access = protected)
        function setupImpl(obj)
            obj.Count = 0;
        end
        function resetImpl(obj)
            obj.Count = 0;
        end
    end
```

```
function y = stepImpl(obj,u)
    if (u > obj.Threshold)
        obj.Count = obj.Count + 1;
    end
    y = obj.Count;
end
function icon = getIconImpl(~)
    icon = matlab.system.display.Icon('counter.png');
end
end
end
```

## See Also

[matlab.system.mixin.CustomIcon](#) | [getIconImpl](#) | [getInputNamesImpl](#) | [getNumInputsImpl](#) | [getNumOutputsImpl](#) | [getOutputNamesImpl](#)

## Related Examples

- “Change Number of Inputs or Outputs” (MATLAB)
- “System Object Input Arguments and ~ in Code Examples” (MATLAB)
- “Subclassing Multiple Classes” (MATLAB)

## Customize System Block Dialog Box

### In this section...

“Add Header to MATLAB System Block” on page 41-7

“Add Data Types Tab to MATLAB System Block” on page 41-8

“Add Property Groups to System Object and MATLAB System Block” on page 41-10

“Control Simulation Type in MATLAB System Block” on page 41-15

“Add Button to MATLAB System Block” on page 41-17

### Add Header to MATLAB System Block

Add a header panel to a System object–based block implemented using a MATLAB System block.

#### Define Header Title and Text

Use `getHeaderImpl` to specify a panel title and text for the `MyCounter` System object.

If you do not specify the `getHeaderImpl`, the block does not display any title or text for the panel.

You always set the `getHeaderImpl` method access to `protected` because it is an internal method that end users do not directly call or run.

```
methods (Static, Access = protected)
    function header = getHeaderImpl
        header = matlab.system.display.Header('MyCounter',...
            'Title','My Enhanced Counter');
    end
end
```

#### Complete Class Definition File with Defined Header

```
classdef MyCounter < matlab.System

    % MyCounter Count values

    properties
        Threshold = 1
    end
    properties (DiscreteState)
```

```
        Count
    end

    methods (Static, Access = protected)
        function header = getHeaderImpl
            header = matlab.system.display.Header('MyCounter',...
                'Title', 'My Enhanced Counter',...
                'Text', 'This counter is an enhanced version.');
```

```
        end
    end

    methods (Access = protected)
        function setupImpl(obj,u)
            obj.Count = 0;
        end
        function y = stepImpl(obj,u)
            if (u > obj.Threshold)
                obj.Count = obj.Count + 1;
            end
            y = obj.Count;
        end
        function resetImpl(obj)
            obj.Count = 0;
        end
    end
end
```

## Add Data Types Tab to MATLAB System Block

Add a Data Types tab to the MATLAB System block dialog box. This tab includes fixed-point data type settings.

### Display Data Types Tab

Use `matlab.system.showFiSettingsImpl` to display the Data Types tab in the MATLAB System block dialog.

```
methods (Static, Access = protected)
    function showTab = showFiSettingsImpl
        showTab = true;
    end
end
```

## Complete Class Definition File with Data Types Tab

Use `showFiSettingsImpl` to display the Data Types tab for a System object that adds an offset to a fixed-point input.

```
classdef FiTabAddOffset < matlab.System
% FiTabAddOffset Add an offset to input

    properties
        Offset = 1;
    end

    methods
        function obj = FiTabAddOffset(varargin)
            setProperties(obj,nargin,varargin{:});
        end
    end

    methods (Access = protected)
        function y = stepImpl(~,u)
            y = u + obj.Offset;
        end
    end

    methods(Static, Access=protected)
        function header = getHeaderImpl
            header = matlab.system.display.Header('Title',...
                'Add Offset','Text','Add an offset to the input');
        end

        function isVisible = showFiSettingsImpl
            isVisible = true;
        end
    end
end
```

### Dialog Box with the Data Types Tab

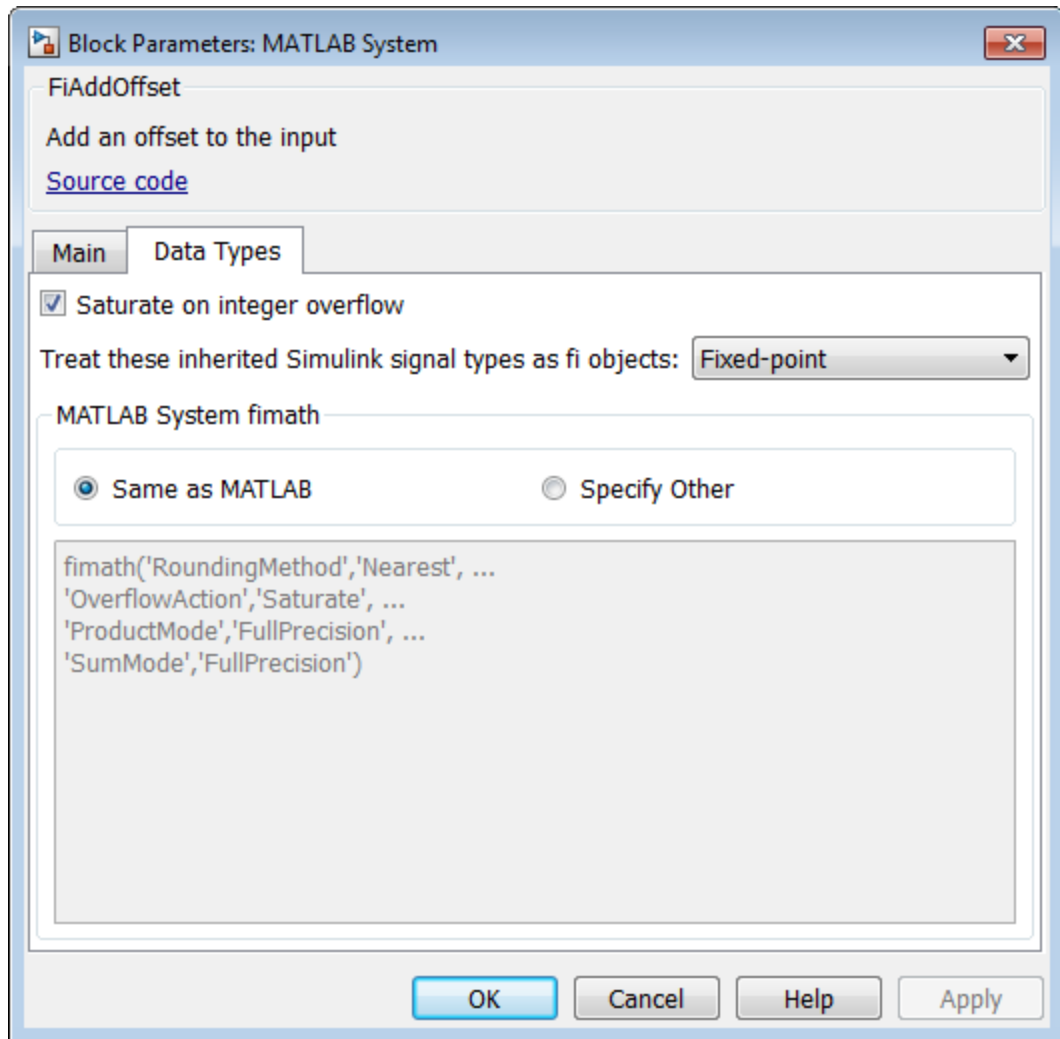

### Add Property Groups to System Object and MATLAB System Block

Define property sections and section groups for System object display. The sections and section groups display as panels and tabs, respectively, in the MATLAB System block dialog.

## Define Section of Properties

Use `matlab.system.display.Section` and `getPropertyGroupsImpl` to define two property group sections by specifying their titles and property lists.

If you do not specify a property in `getPropertyGroupsImpl`, the block does not display that property.

```
methods (Static, Access = protected)
    function groups = getPropertyGroupsImpl
        valueGroup = matlab.system.display.Section(...
            'Title', 'Value parameters', ...
            'PropertyList', {'StartValue', 'EndValue'});

        thresholdGroup = matlab.system.display.Section(...
            'Title', 'Threshold parameters', ...
            'PropertyList', {'Threshold', 'UseThreshold'});
        groups = [valueGroup, thresholdGroup];
    end
end
```

## Define Group of Sections

Use `matlab.system.display.SectionGroup`, `matlab.system.display.Section`, and `getPropertyGroupsImpl` to define two tabs, each containing specific properties.

```
methods (Static, Access = protected)
    function groups = getPropertyGroupsImpl
        upperGroup = matlab.system.display.Section(...
            'Title', 'Upper threshold', ...
            'PropertyList', {'UpperThreshold'});
        lowerGroup = matlab.system.display.Section(...
            'Title', 'Lower threshold', ...
            'PropertyList', {'UseLowerThreshold', 'LowerThreshold'});

        thresholdGroup = matlab.system.display.SectionGroup(...
            'Title', 'Parameters', ...
            'Sections', [upperGroup, lowerGroup]);

        valuesGroup = matlab.system.display.SectionGroup(...
            'Title', 'Initial conditions', ...
            'PropertyList', {'StartValue'});

        groups = [thresholdGroup, valuesGroup];
    end
end
```

end

### Complete Class Definition File with Property Group and Separate Tab

```
classdef EnhancedCounter < matlab.System
    % EnhancedCounter Count values considering thresholds

    properties
        UpperThreshold = 1;
        LowerThreshold = 0;
    end

    properties (Nontunable)
        StartValue = 0;
    end

    properties(Logical,Nontunable)
        % Count values less than lower threshold
        UseLowerThreshold = true;
    end

    properties (DiscreteState)
        Count;
    end

    methods (Static, Access = protected)
        function groups = getPropertyGroupsImpl
            upperGroup = matlab.system.display.Section(...
                'Title', 'Upper threshold', ...
                'PropertyList', {'UpperThreshold'});
            lowerGroup = matlab.system.display.Section(...
                'Title', 'Lower threshold', ...
                'PropertyList', {'UseLowerThreshold', 'LowerThreshold'});

            thresholdGroup = matlab.system.display.SectionGroup(...
                'Title', 'Parameters', ...
                'Sections', [upperGroup, lowerGroup]);

            valuesGroup = matlab.system.display.SectionGroup(...
                'Title', 'Initial conditions', ...
                'PropertyList', {'StartValue'});

            groups = [thresholdGroup, valuesGroup];
        end
    end
end
```



```
methods (Access = protected)
function setupImpl(obj)
    obj.Count = obj.StartValue;
end

function y = stepImpl(obj,u)
    if obj.UseLowerThreshold
        if (u > obj.UpperThreshold) || ...
            (u < obj.LowerThreshold)
            obj.Count = obj.Count + 1;
        end
    else
        if (u > obj.UpperThreshold)
            obj.Count = obj.Count + 1;
        end
    end
    y = obj.Count;
end
function resetImpl(obj)
    obj.Count = obj.StartValue;
end

function flag = isInactivePropertyImpl(obj, prop)
    flag = false;
    switch prop
        case 'LowerThreshold'
            flag = ~obj.UseLowerThreshold;
        end
    end
end
end
```

### Customized Dialog Box

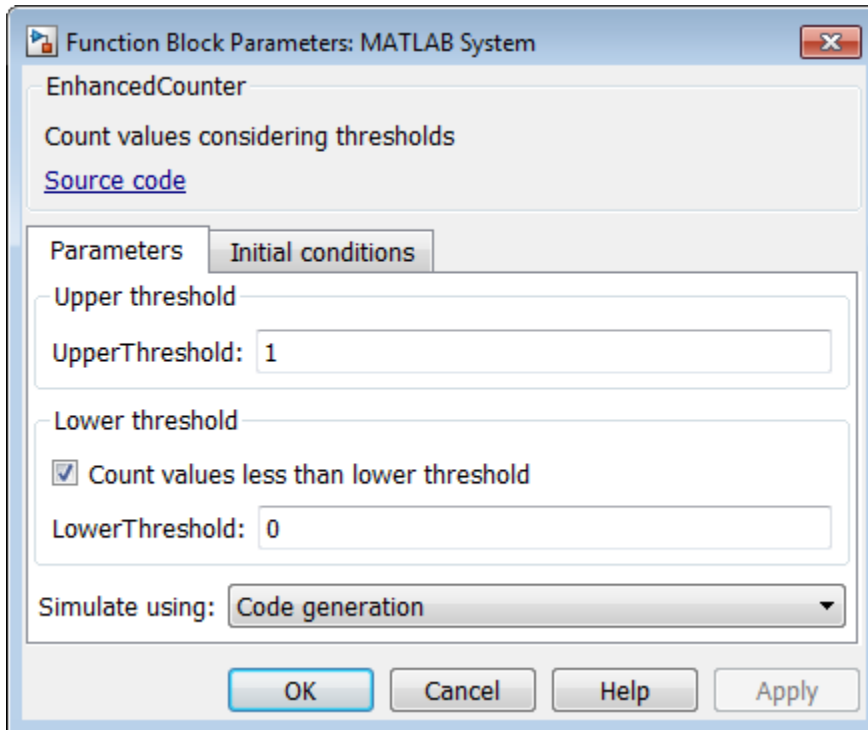

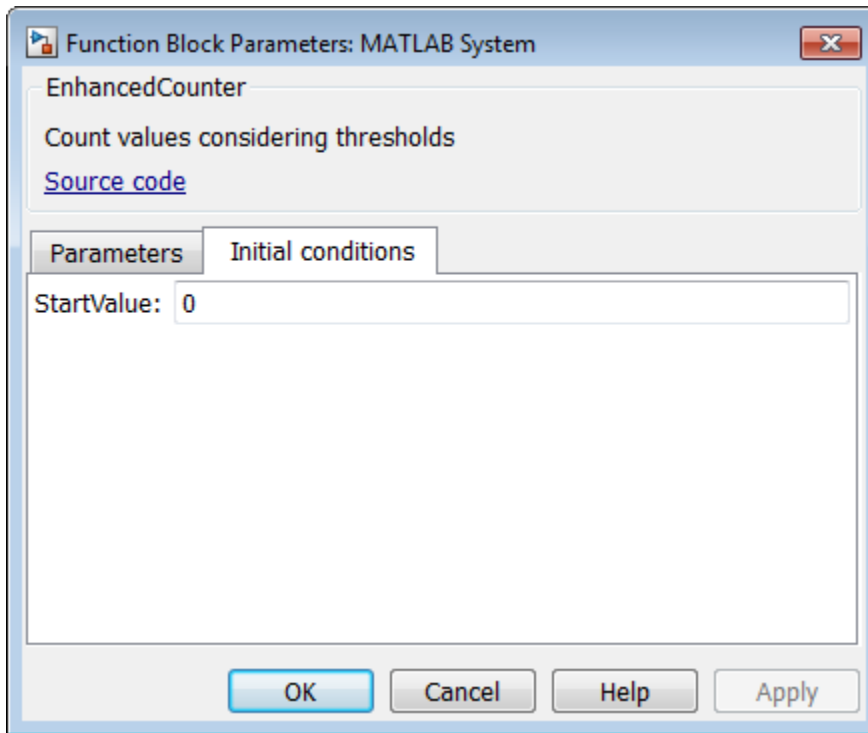

## Control Simulation Type in MATLAB System Block

Specify a simulation type and whether the **Simulate using** parameter appears on the Simulink MATLAB System block dialog box. The simulation options are 'Code generation' and 'Interpreted mode'.

If you do not include the `getSimulateUsingImpl` method in your class definition file, the System object allows both simulation modes and defaults to 'Code generation'. If you do not include the `showSimulateUsingImpl` method, the **Simulate using** parameter appears on the block dialog box.

You must set the `getSimulateUsingImpl` and `showSimulateUsingImpl` methods to `static` and the access for these methods to `protected`.

Use `getSimulateUsingImpl` to specify that only interpreted execution is allowed for the System object.

```
methods(Static,Access = protected)
    function simMode = getSimulateUsingImpl
        simMode = 'Interpreted execution';
    end
end
```

View the method in the complete class definition file.

```
classdef PlotRamp < matlab.System
    % Display a button to launch a plot figure.

    properties (Nontunable)
        RampLimit = 10;
    end

    methods(Static, Access=protected)
        function group = getPropertyGroupsImpl
            group = matlab.system.display.Section(mfilename('class'));
            group.Actions = matlab.system.display.Action(@(~,obj)...
                visualize(obj),'Label','Visualize');
        end

        function simMode = getSimulateUsingImpl
            simMode = 'Interpreted execution';
        end
    end

    methods
        function obj = ActionDemo(varargin)
            setProperties(obj,nargin,varargin{:});
        end

        function visualize(obj)
            figure;
            d = 1:obj.RampLimit;
            plot(d);
        end
    end
end
end
```

## Dialog Box with Simulation Type Parameter

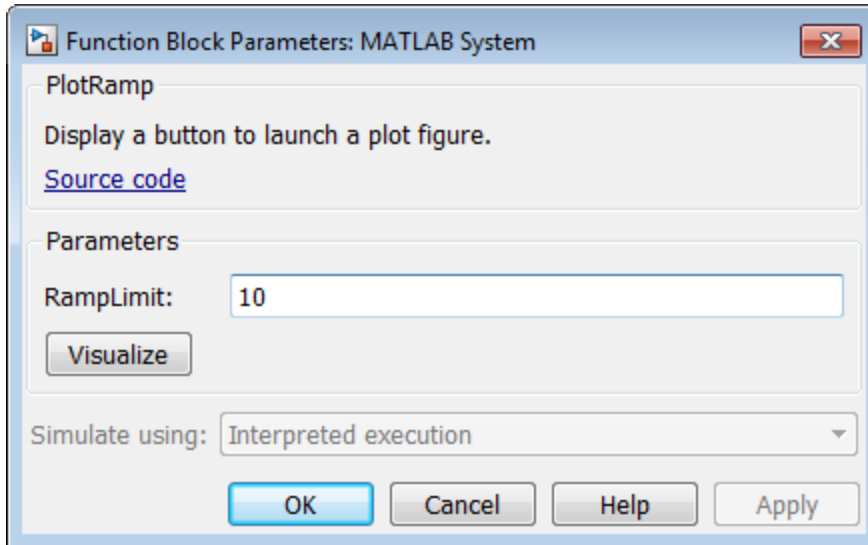

## Add Button to MATLAB System Block

Add a button to the MATLAB System block dialog box. This button launches a figure that plots a ramp function.

### Define Action for Dialog Button

Use `matlab.system.display.Action` to define the MATLAB function or code associated with a button in the MATLAB System block dialog. The example also shows how to set button options and use an `actionData` object input to store a figure handle. This part of the code example uses the same figure when the button is clicked multiple times, rather than opening a new figure for each button click.

```
methods(Static,Access = protected)
    function group = getPropertyGroupsImpl
        group = matlab.system.display.Section(mfilename('class'));
        group.Actions = matlab.system.display.Action(@(actionData,obj)...
            visualize(obj,actionData),'Label','Visualize');
    end
end
```

```

methods
function obj = ActionDemo(varargin)
    setProperties(obj,nargin,varargin{:});
end

function visualize(obj,actionData)
    f = actionData.UserData;
    if isempty(f) || ~ishandle(f)
        f = figure;
        actionData.UserData = f;
    else
        figure(f); % Make figure current
    end

    d = 1:obj.RampLimit;
    plot(d);
end
end

```

## Complete Class Definition File for Dialog Button

Define a property group and a second tab in the class definition file.

```

classdef PlotRamp < matlab.System
    % Display a button to launch a plot figure.

    properties (Nontunable)
        RampLimit = 10;
    end

    methods(Static,Access = protected)
        function group = getPropertyGroupsImpl
            group = matlab.system.display.Section(mfilename('class'));
            group.Actions = matlab.system.display.Action(@(actionData,obj)...
                visualize(obj,actionData),'Label','Visualize');
        end
    end

    methods
        function obj = ActionDemo(varargin)
            setProperties(obj,nargin,varargin{:});
        end

        function visualize(obj,actionData)
            f = actionData.UserData;

```

```

if isempty(f) || ~ishandle(f)
    f = figure;
    actionData.UserData = f;
else
    figure(f); % Make figure current
end

d = 1:obj.RampLimit;
plot(d);
end
end
end

```

### Dialog Box with Visualize Button

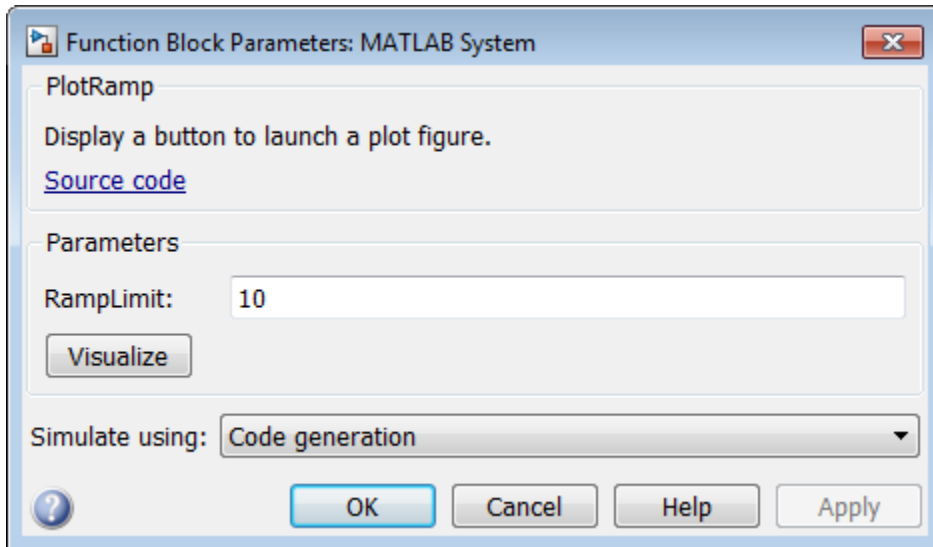

### See Also

[matlab.system.display.Section](#) | [matlab.system.display.SectionGroup](#) | [matlab.system.display.Header](#) | [getHeaderImpl](#) | [getPropertyGroupsImpl](#) | [getSimulateUsingImp](#) | [showSimulateUsingImpl](#)

### More About

- “System Object Input Arguments and ~ in Code Examples” (MATLAB)

## Specify Output

### In this section...

“Set Output Size” on page 41-20

“Specify Whether Output Is Fixed-Size or Variable-Size” on page 41-22

“Set Output Data Type” on page 41-24

“Set Output Complexity” on page 41-27

“Specify Discrete State Output Specification” on page 41-29

Sometimes, Simulink cannot infer the output characteristics of your System object during model compilation. To give Simulink more information about the System object output, use these methods.

### Set Output Size

Specify the size of a System object output using the `getOutputSizeImpl` method. Use this method when Simulink cannot infer the output size from the inputs during model compilation.

For variable-size inputs, the propagated input size from `propagatedInputSizeImpl` differs depending on the environment.

- MATLAB — When you first run an object, it uses the actual sizes of the inputs.
- Simulink — The maximum of all the input sizes is set before the model runs and does not change during the run.

Subclass from both the `matlab.System` base class and the `Propagates` mixin class.

```
classdef CounterReset < matlab.System & ...
    matlab.system.mixin.Propagates
```

Use the `getOutputSizeImpl` method to specify the output size.

```
methods (Access = protected)
    function sizeout = getOutputSizeImpl(~)
        sizeout = [1 1];
    end
```



end

View the method in the complete class definition file.

```

classdef CounterReset < matlab.System & matlab.system.mixin.Propagates
    % CounterReset Count values above a threshold

    properties
        Threshold = 1
    end

    properties (DiscreteState)
        Count
    end

    methods (Access = protected)
        function setupImpl(obj)
            obj.Count = 0;
        end

        function y = stepImpl(obj,u1,u2)
            % Add to count if u1 is above threshold
            % Reset if u2 is true
            if (u2)
                obj.Count = 0;
            elseif (any(u1 > obj.Threshold))
                obj.Count = obj.Count + 1;
            end
            y = obj.Count;
        end

        function resetImpl(obj)
            obj.Count = 0;
        end

        function [sz,dt,cp] = getDiscreteStateSpecificationImpl(~,name)
            if strcmp(name,'Count')
                sz = [1 1];
                dt = 'double';
                cp = false;
            else
                error(['Error: Incorrect State Name: ', name.]);
            end
        end

        function dataout = getOutputDataTypeImpl(~)
    end
end

```

```
        dataout = 'double';
    end
    function sizeout = getOutputSizeImpl(~)
        sizeout = [1 1];
    end
    function cplxout = isOutputComplexImpl(~)
        cplxout = false;
    end
    function fixedout = isOutputFixedSizeImpl(~)
        fixedout = true;
    end
    function inLocked = isInputSizeLockedImpl(~, idx)
        if idx == 1
            inLocked = false;
        else
            inLocked = true;
        end
    end
end
end
end
```

## Specify Whether Output Is Fixed-Size or Variable-Size

Specify System object output is fixed-sized or variable-size.

Specify the System object output is fixed-size. Fixed-size output is always the same size, while variable-size output can be different size vectors. `isOutputSizeLockedImpl` accepts the port index and returns `true` if the input size is locked (variable sized vectors are disallowed) and `false` if the input size is not locked (variable sized vectors are allowed). Use the `isOutputFixedSizeImpl` method when Simulink cannot infer the output type from the inputs during model compilation.

Subclass from both the `matlab.System` base class and the `matlab.system.mixin.Propagates` mixin class.

```
classdef CounterReset < matlab.System & ...
    matlab.system.mixin.Propagates
```

Use the `isOutputFixedSizeImpl` method to specify that the output is fixed size.

```
methods (Access = protected)
    function fixedout = isOutputFixedSizeImpl(~)
        fixedout = true;
```

```

end
end

```

View the method in the complete class definition file.

```

classdef CounterReset < matlab.System & matlab.system.mixin.Propagates
    % CounterReset Count values above a threshold

    properties
        Threshold = 1
    end

    properties (DiscreteState)
        Count
    end

    methods (Access = protected)
        function setupImpl(obj)
            obj.Count = 0;
        end

        function resetImpl(obj)
            obj.Count = 0;
        end

        function y = stepImpl(obj,u1,u2)
            % Add to count if u1 is above threshold
            % Reset if u2 is true
            if (u2)
                obj.Count = 0;
            elseif (u1 > obj.Threshold)
                obj.Count = obj.Count + 1;
            end
            y = obj.Count;
        end

        function [sz,dt,cp] = getDiscreteStateSpecificationImpl(~,name)
            if strcmp(name,'Count')
                sz = [1 1];
                dt = 'double';
                cp = false;
            else
                error(['Error: Incorrect State Name: ', name.]);
            end
        end
    end
end

```

```
function dataout = getOutputDataTypeImpl(~)
    dataout = 'double';
end
function sizeout = getOutputSizeImpl(~)
    sizeout = [1 1];
end
function cplxout = isOutputComplexImpl(~)
    cplxout = false;
end
function fixedout = isOutputFixedSizeImpl(~)
    fixedout = true;
end
end
end
```

For a System object with variable-size output, you do not need to add any method to the class definition file because variable-size output is the default.

## Set Output Data Type

Specify the data type of a System object output using the `getOutputDataTypeImpl` method. A second example shows how to specify a gain object with bus output. Use this method when Simulink cannot infer the data type from the inputs during model compilation or when you want different input and output data types. You also use the `getOutputDataTypeImpl` method if you want bus output. To use bus output, you must define the bus data type in the base work space and you must include the `getOutputDataTypeImpl` method in your class definition file.

For both examples, subclass from both the `matlab.System` base class and the `matlab.system.mixin.Propagates` mixin class.

```
classdef DataTypeChange < matlab.System & ...
    matlab.system.mixin.Propagates
```

Specify, in your class definition file, how to control the output data type from a MATLAB System block. Use the `getOutputDataTypeImpl` method to change the output data type from double to single, or propagate the input as a double. It also shows how to cast the data type to change the output data type in the `stepImpl` method, if necessary.

```
methods (Access = protected)
    function out = getOutputDataTypeImpl(obj)
        if obj.Quantize == true
            out = 'single';
```

```

else
    out = propagatedInputDataType(obj,1);
end
end
end

classdef DataTypeChange < matlab.System & ...
    matlab.system.mixin.Propagates

    properties(Nontunable)
        Quantize = false;
    end

    methods(Access = protected)
        function y = stepImpl(obj,u)
            if obj.Quantize == true
                % Cast for output data type to differ from input.
                y = single(u);
            else
                % Propagate output data type.
                y = u;
            end
        end

        function out = getOutputDataTypeImpl(obj)
            if obj.Quantize == true
                out = 'single';
            else
                out = propagatedInputDataType(obj,1);
            end
        end
    end
end
end

```

This model shows propagated double data type.

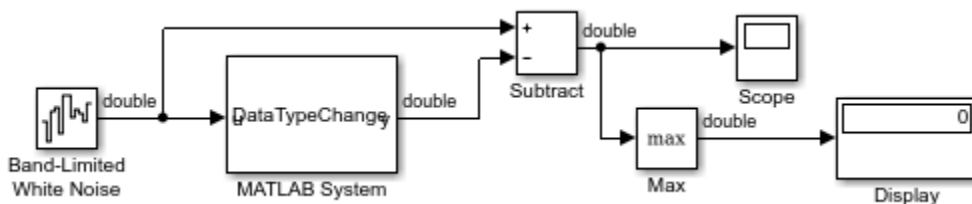

This model shows the result of changing the data type from double to single. The Display block shows the effect of quantizing the data.

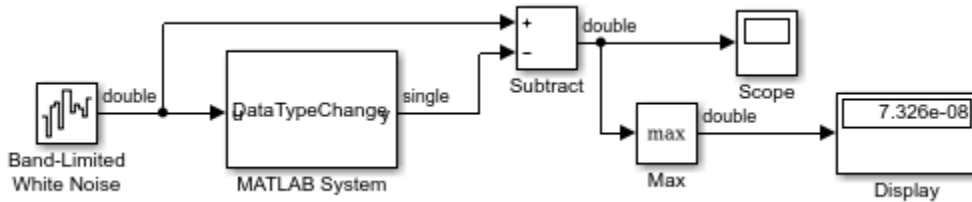

The block mask for the MATLAB System block includes an edit field to switch between using propagation (**Quantize = false**) and switching from double to single (**Quantize = true**).

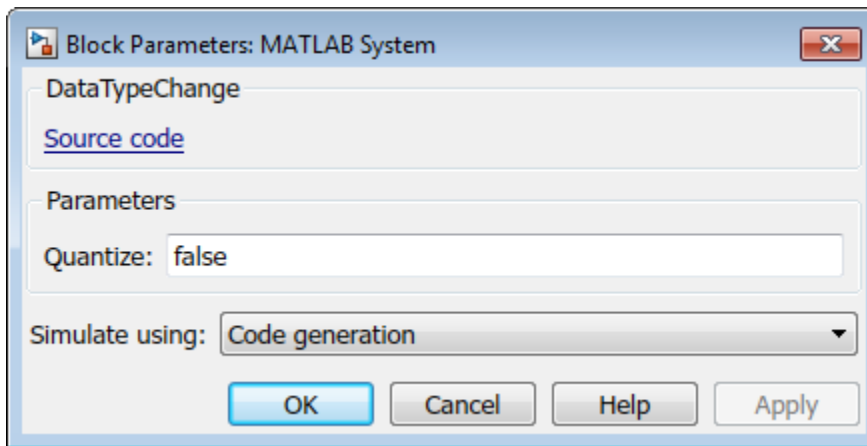

Use the `getOutputDataTypeImpl` method to specify the output data type as a bus. Specify the bus name in a property.

```
properties(Nontunable)
    OutputBusName = 'bus_name';
end

methods (Access = protected)
    function out = getOutputDataTypeImpl(obj)
        out = obj.OutputBusName;
    end
end
```

View the method in the complete class definition file. This class definition file also includes code to implement a custom icon for this object in the MATLAB System block

```
classdef busGain < matlab.System & matlab.system.mixin.Propagates
% busGain Apply a gain of two to bus input.
```

```
    properties
        GainK = 2;
    end

    properties(Nontunable)
        OutputBusName = 'bus_name';
    end

    methods (Access=protected)
        function out = stepImpl(obj,in)
            out.a = obj.GainK * in.a;
            out.b = obj.GainK * in.b;
        end

        function out = getOutputSizeImpl(obj)
            out = propagatedInputSize(obj, 1);
        end

        function out = isOutputComplexImpl(obj)
            out = propagatedInputComplexity(obj, 1);
        end

        function out = getOutputDataTypeImpl(obj)
            out = obj.OutputBusName;
        end

        function out = isOutputFixedSizeImpl(obj)
            out = propagatedInputFixedSize(obj,1);
        end
    end
end
```

## Set Output Complexity

Specify whether a System object output is complex or real using the `isOutputComplexImpl` method. Use this method when Simulink cannot infer the output complexity from the inputs during model compilation.

Subclass from both the `matlab.System` base class and the `Propagates` mixin class.

```
classdef CounterReset < matlab.System & ...  
    matlab.system.mixin.Propagates
```

Use the `isOutputComplexImpl` method to specify that the output is real.

```
methods (Access = protected)  
    function cplxout = isOutputComplexImpl(~)  
        cplxout = false;  
    end  
end
```

View the method in the complete class definition file.

```
classdef CounterReset < matlab.System & matlab.system.mixin.Propagates  
    % CounterReset Count values above a threshold  
  
    properties  
        Threshold = 1  
    end  
  
    properties (DiscreteState)  
        Count  
    end  
  
    methods (Access = protected)  
        function setupImpl(obj)  
            obj.Count = 0;  
        end  
  
        function resetImpl(obj)  
            obj.Count = 0;  
        end  
  
        function y = stepImpl(obj,u1,u2)  
            % Add to count if u1 is above threshold  
            % Reset if u2 is true  
            if (u2)  
                obj.Count = 0;  
            elseif (u1 > obj.Threshold)  
                obj.Count = obj.Count + 1;  
            end  
            y = obj.Count;  
        end  
    end
```



```

function [sz,dt,cp] = getDiscreteStateSpecificationImpl(~,name)
    if strcmp(name,'Count')
        sz = [1 1];
        dt = 'double';
        cp = false;
    else
        error(['Error: Incorrect State Name: ', name.']);
    end
end
function dataout = getOutputDataTypeImpl(~)
    dataout = 'double';
end
function sizeout = getOutputSizeImpl(~)
    sizeout = [1 1];
end
function cplxout = isOutputComplexImpl(~)
    cplxout = false;
end
function fixedout = isOutputFixedSizeImpl(~)
    fixedout = true;
end
end
end

```

## Specify Discrete State Output Specification

Specify the size, data type, and complexity of a discrete state property using the `getDiscreteStateSpecificationImpl` method. Use this method when your System object has a property with the `DiscreteState` attribute and Simulink cannot infer the output specifications during model compilation.

Subclass from both the `matlab.System` base class and from the `Propagates` mixin class.

```

classdef CounterReset < matlab.System & ...
    matlab.system.mixin.Propagates

```

Use the `getDiscreteStateSpecificationImpl` method to specify the size and data type. Also specify the complexity of a discrete state property, which is used in the counter reset example.

```

methods (Access = protected)

```

```
function [sz,dt,cp] = getDiscreteStateSpecificationImpl(~,name)
    sz = [1 1];
    dt = 'double';
    cp = false;
end
end
```

View the method in the complete class definition file.

```
classdef CounterReset < matlab.System & matlab.system.mixin.Propagates
    % CounterReset Count values above a threshold

    properties
        Threshold = 1
    end

    properties (DiscreteState)
        Count
    end

    methods (Access = protected)
        function setupImpl(obj)
            obj.Count = 0;
        end

        function resetImpl(obj)
            obj.Count = 0;
        end

        function y = stepImpl(obj,u1,u2)
            % Add to count if u1 is above threshold
            % Reset if u2 is true
            if (u2)
                obj.Count = 0;
            elseif (u1 > obj.Threshold)
                obj.Count = obj.Count + 1;
            end
            y = obj.Count;
        end

        function [sz,dt,cp] = getDiscreteStateSpecificationImpl(~,name)
            sz = [1 1];
            dt = 'double';
            cp = false;
        end
    end
end
```

```
function dataout = getOutputDataTypeImpl(~)
    dataout = 'double';
end
function sizeout = getOutputSizeImpl(~)
    sizeout = [1 1];
end
function cplxout = isOutputComplexImpl(~)
    cplxout = false;
end
function fixedout = isOutputFixedSizeImpl(~)
    fixedout = true;
end
end
end
```

## See Also

[matlab.system.mixin.Propagates](#) | [getDiscreteStateSpecificationImpl](#) | [getOutputDataTypeImpl](#) | [getOutputSizeImpl](#) | [isOutputComplexImpl](#) | [isOutputFixedSizeImpl](#)

## More About

- “Subclassing Multiple Classes” (MATLAB)
- “System Object Input Arguments and ~ in Code Examples” (MATLAB)

## Set Model Reference Discrete Sample Time Inheritance

Disallow model reference discrete sample time inheritance for a System object. The System object defined in this example has one input, so by default, it allows sample time inheritance. To override the default and disallow inheritance, the class definition file for this example includes the `allowModelReferenceDiscreteSampleTimeInheritanceImpl` method, with its output set to `false`.

```
methods (Access = protected)
    function flag = ...
        allowModelReferenceDiscreteSampleTimeInheritanceImpl(obj)
        flag = false;
    end
end
```

View the method in the complete class definition file.

```
classdef MyCounter < matlab.System

    % MyCounter Count values

    properties
        Threshold = 1;
    end

    properties (DiscreteState)
        Count
    end

    methods (Static, Access = protected)
        function header = getHeaderImpl
            header = matlab.system.display.Header('MyCounter',...
                'Title', 'My Enhanced Counter',...
                'Text', 'This counter is an enhanced version.');
```

```
        obj.Count = 0;
    end
    function y = stepImpl(obj,u)
        if (u > obj.Threshold)
            obj.Count = obj.Count + 1;
        end
        y = obj.Count;
    end
    function resetImpl(obj)
        obj.Count = 0;
    end
end
end
```

## See Also

matlab.System | allowModelReferenceDiscreteSampleTimeInheritanceImpl

## Use Update and Output for Nondirect Feedthrough

Implement nondirect feedthrough for a System object by using the `updateImpl`, `outputImpl` and `isInputDirectFeedthroughImpl` methods. In nondirect feedthrough, the object's outputs depend only on the internal states and properties of the object, rather than the input at that instant in time. You use these methods to separate the output calculation from the state updates of a System object. Implementing these two methods overrides the `stepImpl` method. This enables you to use the object in a feedback loop and prevent algebraic loops.

### Subclass from the Nondirect Mixin Class

To use the `updateImpl`, `outputImpl`, and `isInputDirectFeedthroughImpl` methods, you must subclass from both the `matlab.System` base class and the `Nondirect` mixin class.

```
classdef IntegerDelaySysObj < matlab.System & ...  
    matlab.system.mixin.Nondirect
```

### Implement Updates to the Object

Implement an `updateImpl` method to update the object with previous inputs.

```
methods (Access = protected)  
    function updateImpl(obj,u)  
        obj.PreviousInput = [u obj.PreviousInput(1:end-1)];  
    end  
end
```

### Implement Outputs from Object

Implement an `outputImpl` method to output the previous, not the current input.

```
methods (Access = protected)  
    function [y] = outputImpl(obj,~)  
        y = obj.PreviousInput(end);  
    end  
end
```

### Implement Whether Input Is Direct Feedthrough

Implement an `isInputDirectFeedthroughImpl` method to indicate that the input is nondirect feedthrough.

```

methods (Access = protected)
    function flag = isInputDirectFeedthroughImpl(~,~)
        flag = false;
    end
end

```

### Complete Class Definition File with Update and Output

```

classdef intDelaySysObj < matlab.System &...
    matlab.system.mixin.Nondirect
    % intDelaySysObj Delay input by specified number of samples.

    properties
        InitialOutput = 0;
    end
    properties (Nontunable)
        NumDelays = 1;
    end
    properties (DiscreteState)
        PreviousInput;
    end

    methods (Access = protected)
        function validatePropertiesImpl(obj)
            if ((numel(obj.NumDelays)>1) || (obj.NumDelays <= 0))
                error('Number of delays must be positive non-zero scalar value.');
            end
            if (numel(obj.InitialOutput)>1)
                error('Initial Output must be scalar value.');
            end
        end

        function setupImpl(obj)
            obj.PreviousInput = ones(1,obj.NumDelays)*obj.InitialOutput;
        end

        function resetImpl(obj)
            obj.PreviousInput = ones(1,obj.NumDelays)*obj.InitialOutput;
        end

        function [y] = outputImpl(obj,~)
            y = obj.PreviousInput(end);
        end
        function updateImpl(obj, u)
            obj.PreviousInput = [u obj.PreviousInput(1:end-1)];
        end
    end
end

```

```
    end
    function flag = isInputDirectFeedthroughImpl(~,~)
        flag = false;
    end
end
end
```

### See Also

matlab.system.mixin.Nondirect | isInputDirectFeedthroughImpl | outputImpl | updateImpl

### More About

- “Subclassing Multiple Classes” (MATLAB)
- “System Object Input Arguments and ~ in Code Examples” (MATLAB)



## Enable For Each Subsystem Support

Enable For Each subsystem support by using a System object in a Simulink For Each subsystem. Include the `supportsMultipleInstanceImpl` method in your class definition file. This method applies only when the System object is used in Simulink via the MATLAB System block.

Use the `supportsMultipleInstanceImpl` method and have it return `true` to indicate that the System object supports multiple calls in a Simulink For Each subsystem.

```
methods (Access = protected)
    function flag = supportsMultipleInstanceImpl(obj)
        flag = true;
    end
end
```

View the method in the complete class definition file.

```
classdef RandSeed < matlab.System
% RANDSEED Random noise with seed for use in For Each subsystem

    properties (DiscreteState)
        count;
    end

    properties (Nontunable)
        seed = 20;
    end

    properties (Nontunable,Logical)
        useSeed = false;
    end

    methods (Access = protected)
        function y = stepImpl(obj,u1)
            % Initial use after reset/setup
            % and use the seed
            if (obj.useSeed && ~obj.count)
                rng(obj.seed);
            end
            obj.count = obj.count + 1;
            [m,n] = size(u1);
            % Uses default rng seed
            y = rand(m,n) + u1;
        end
    end
end
```

```
    end

    function setupImpl(obj)
        obj.count = 0;
    end
    function resetImpl(obj)
        obj.count = 0;
    end

    function flag = supportsMultipleInstanceImpl(obj)
        flag = obj.useSeed;
    end
end
end
```

### See Also

matlab.System | supportsMultipleInstanceImpl

## Define System Object for Use in Simulink

In this section...
“Develop System Object for Use in System Block” on page 41-39
“Define Block Dialog Box for Plot Ramp” on page 41-40

### Develop System Object for Use in System Block

You can develop a System object for use in a System block and interactively preview the block dialog box. This feature requires Simulink.

With the **System Block** editing options, the MATLAB Editor inserts predefined code into the System object. This coding technique helps you create and modify your System object faster and increases accuracy by reducing typing errors.

Using these options, you can also:

- View and interact with the block dialog design as you define the System object.
- Add dialog customization methods. If the block dialog box is open when you make changes, the block dialog design preview updates the display on saving the file.
- Add icon methods. However, these elements display only on the MATLAB System Block in Simulink, not in the Preview Dialog Box.

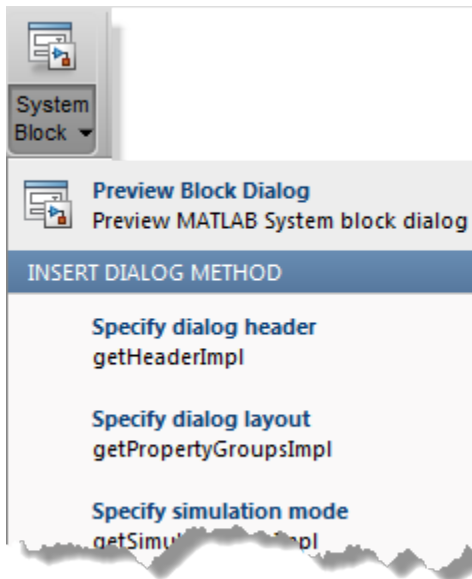

## Define Block Dialog Box for Plot Ramp

- 1 Create a System object and name it `PlotRamp`. This name becomes the block dialog box title. Save the System object.
- 2 Add a comment that contains the block description.

```
% Display a button to launch a plot figure.
```

This comment becomes the block parameters dialog box description, under the block title.

- 3 Select **System Block > Preview Block Dialog**. The block dialog box displays as you develop the System object.

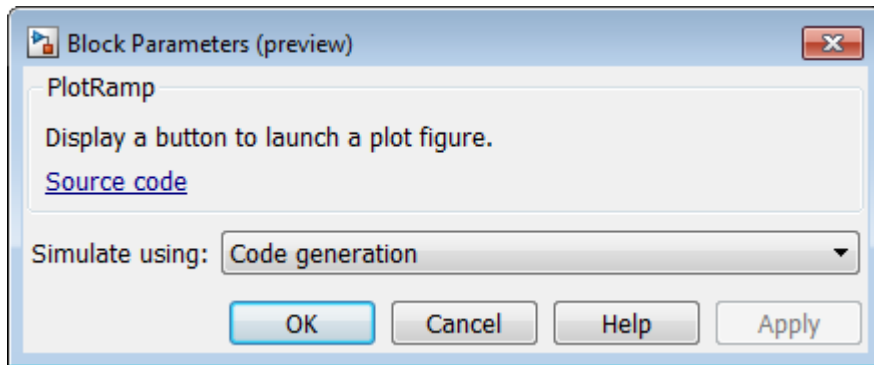

- 4 Add a ramp limit by selecting **Insert Property > Numeric**. Then change the property name and set the value to 10.

```
properties (Nontunable)
    RampLimit = 10;
end
```

- 5 Using the **System Block** menu, insert the `getPropertyGroupsImpl` method.

```
methods(Access = protected, Static)
    function group = getPropertyGroupsImpl
        % Define property section(s) for System block dialog
        group = matlab.system.display.Section(mfilename('class'));
    end
end
```

- 6 Add code to create the group for the visualize action.

```
methods(Access = protected, Static)
    function group = getPropertyGroupsImpl
        % Define property section(s) for System block dialog
        group = matlab.system.display.Section(mfilename('class'));
        group.Actions = matlab.system.display.Action(@(~,obj)...
            visualize(obj), 'Label', 'Visualize');
    end
end
```

- 7 Add a function that adds code to display the **Visualize** button on the dialog box.

```
methods
    function visualize(obj)
        figure;
```

```
        d = 1:obj.RampLimit;  
        plot(d);  
    end  
end
```

- 8 As you add elements to the System block definition, save your file. Observe the effects of your code additions to the System block definition.

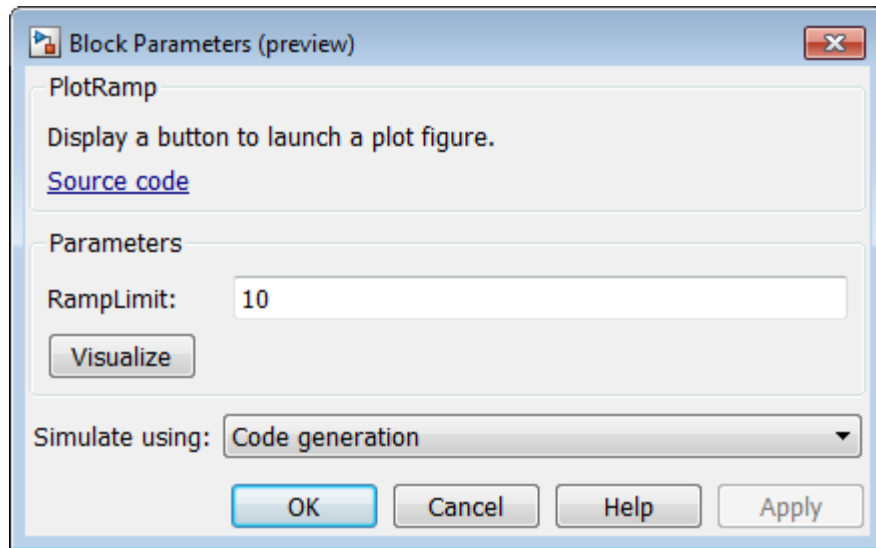

The **System Block** menu also displays checks next to the methods you have implemented, which can help you track your development.

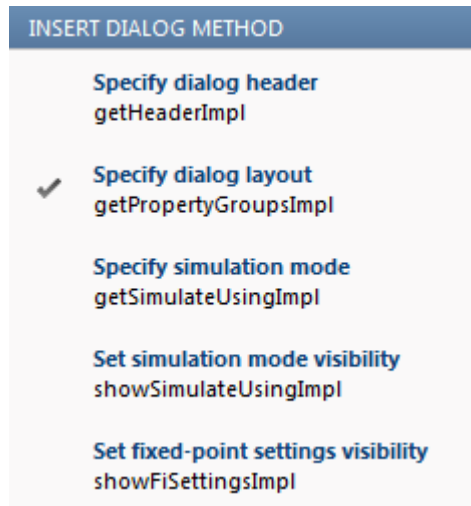

The class definition file now has all the code necessary for the PlotRamp System object.

```
classdef PlotRamp < matlab.System
    % Display a button to launch a plot figure.

    properties (Nontunable)
        RampLimit = 10;
    end

    methods(Static, Access=protected)
        function group = getPropertyGroupsImpl
            group = matlab.system.display.Section(mfilename('class'));
            group.Actions = matlab.system.display.Action(@(~,obj)...
                visualize(obj), 'Label', 'Visualize');
        end
    end

    methods
        function visualize(obj)
            figure;
            d = 1:obj.RampLimit;
            plot(d);
        end
    end
end
```

After you complete your System block definition, save it, and then load it into a MATLAB System block in Simulink.

### **Related Examples**

- “Insert System Object Code Using MATLAB Editor” (MATLAB)



## Use Enumerations in System Objects

Enumerated data is data that is restricted to a finite set of values. To use enumerated data in a System object in MATLAB or Simulink, you refer to them in your System object class definition and define your enumerated class in a separate class definition file.

For a System object that will be used in MATLAB only, see “Enumerations” (MATLAB).

For a System object that will be used in a MATLAB System block in Simulink, see “Enumerated Data”

Enumerations can derive from any integer type smaller than or equal to an `int32`. For example,

```
classdef Bearing < uint8
    enumeration
        North (0)
        East  (90)
        South (180)
        West  (270)
    end
end
```

Enumerations can also derive from `Simulink.IntEnumType`. You use this type of enumeration to add attributes, such as custom headers, to the input or output of the MATLAB System block. See “Use Enumerated Data in Simulink Models” on page 58-7.

## Use Global Variables in System Objects

Global variables are variables that you can access in other MATLAB functions or Simulink blocks.

### System Object Global Variables in MATLAB

For System objects that are used only in MATLAB, you define global variables in System object class definition files in the same way that you define global variables in other MATLAB code (see “Global Variables” (MATLAB)).

### System Object Global Variables in Simulink

For System objects that are used in the MATLAB System block in Simulink, you also define global variables as you do in MATLAB. However, to use global variables in Simulink, you need to declare global variables in the `stepImpl`, `updateImpl`, or `outputImpl` method if you have declared them in methods called by `stepImpl`, `updateImpl`, or `outputImpl`, respectively.

You set up and use global variables for the MATLAB System block in the same way as you do for the MATLAB Function block (see “Data Stores” and “Share Data Globally” on page 40-116). Like the MATLAB Function block, you must also use variable name matching with a Data Store Memory block to use global variables in Simulink.

For example, this class definition file defines a System object that increments the first row of a matrix by 1 at each time step. You must include `getGlobalNamesImpl` if the class file is P-coded.

```
classdef GlobalSysObjMatrix < matlab.System
    methods (Access = protected)
        function y = stepImpl(obj)
            global B;
            B(1,:) = B(1,:)+1;
            y = B;
        end

        % Include getGlobalNamesImpl only if the class file is P-coded.
        function globalNames = getGlobalNamesImpl(~)
            globalNames = {'B'};
        end
end
```

```
end  
end
```

This model includes the `GlobalSysObjMatrix` object in a MATLAB System block and the associated Data Store Memory block.

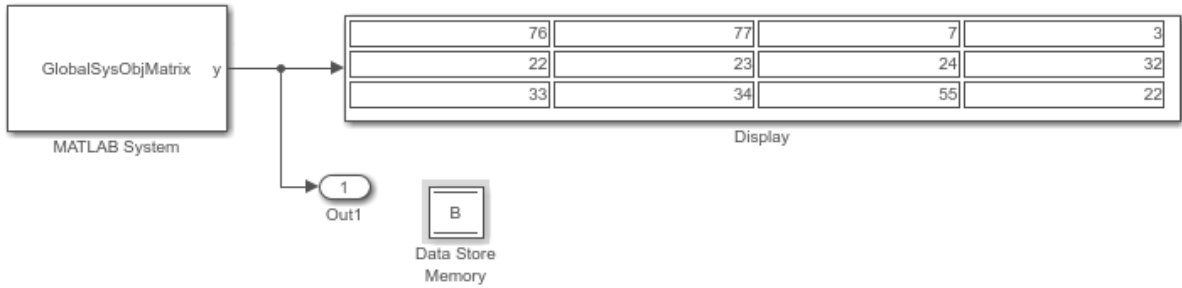



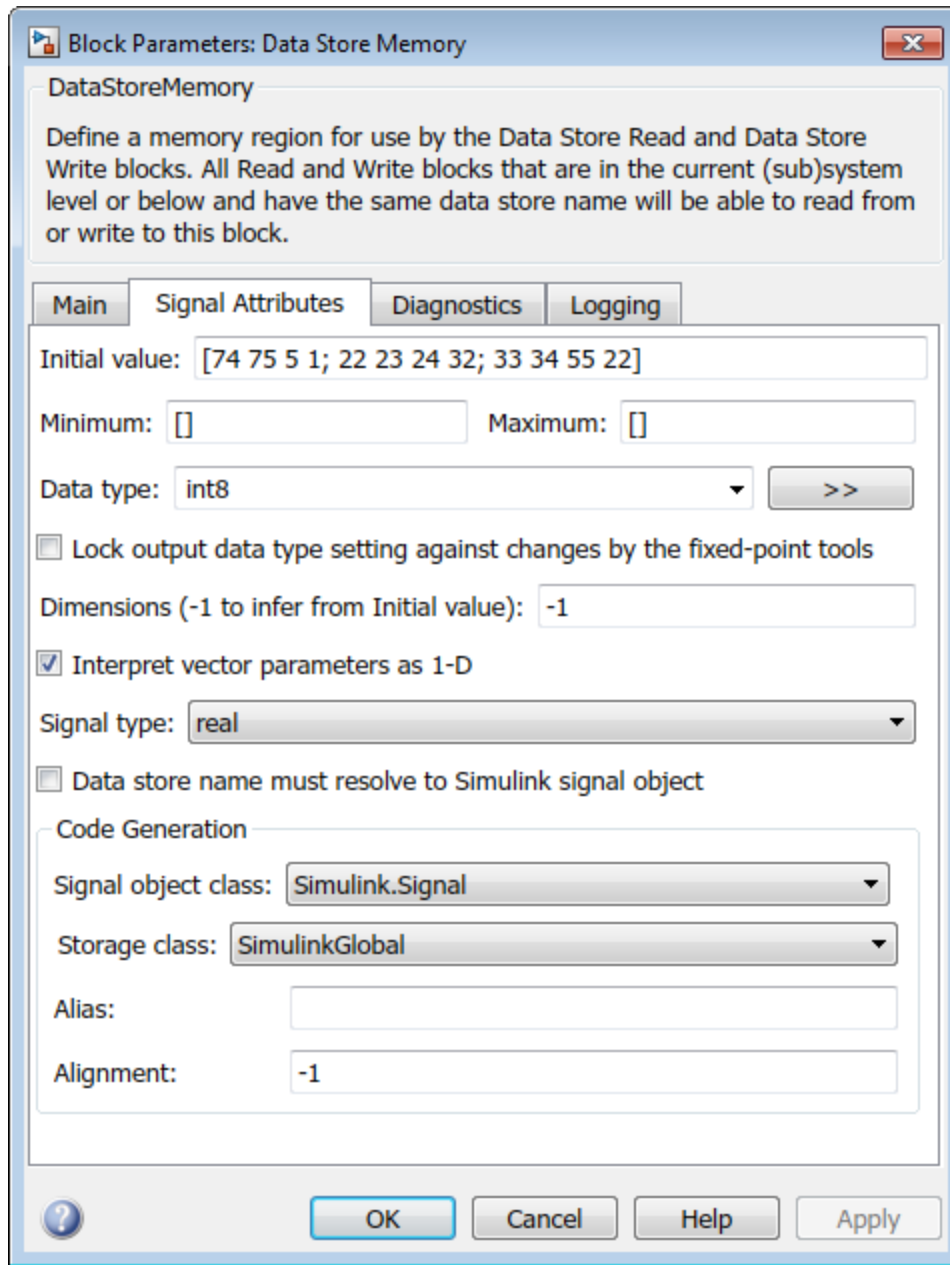

## Use System Objects in Simulink

<b>In this section...</b>
“System Objects in the MATLAB Function Block” on page 41-50
“System Objects in the MATLAB System Block” on page 41-50

### System Objects in the MATLAB Function Block

You can include System object code in Simulink models with the MATLAB Function block. Your function can include one or more System objects. Portions of your system may be easier to implement in the MATLAB environment than directly in Simulink. Many System objects have Simulink block counterparts with equivalent functionality. Before writing MATLAB code to include in a Simulink model, check for existing blocks that perform the desired operation.

### System Objects in the MATLAB System Block

You can include individual System objects that you create with a class definition file into Simulink with the MATLAB System block. This provides one way to add your own algorithm blocks into your Simulink models. For information, see “System Object Integration”.

# System Design in Simulink Using System Objects

**In this section...**

“System Design and Simulation in Simulink” on page 41-51

“Define New Kinds of System Objects for Use in Simulink” on page 41-51

“Test New System Objects in MATLAB” on page 41-57

“Add System Objects to Your Simulink Model” on page 41-57

## System Design and Simulation in Simulink

You can use System objects in your model to simulate in Simulink.

- 1 Create a System object to be used in your model. See “Define New Kinds of System Objects for Use in Simulink” on page 41-51 for information.
- 2 Test your new System object in MATLAB. See “Test New System Objects in MATLAB” on page 41-57
- 3 Add the System object to your model by using the MATLAB System block. See “Add System Objects to Your Simulink Model” on page 41-57 for information.
- 4 Add other Simulink blocks as needed and connect the blocks to construct your system.
- 5 Run the system

## Define New Kinds of System Objects for Use in Simulink

- “Define System Object with Block Customizations” on page 41-51
- “Define System Object with Nondirect Feedthrough” on page 41-54

A System object is a component you can use to create your system in MATLAB. You can write the code in MATLAB and use that code to create a block in Simulink. To define your own System object, you write a class definition file, which is a text-based MATLAB file that contains the code defining your object. See “System Object Integration”.

### Define System Object with Block Customizations

Create a System object for use in Simulink. The example performs system identification using a least mean squares (LMS) adaptive filter.

Create a class definition text file to define your System object. The code in this example creates a least mean squares (LMS) filter and includes customizations to the block icon and dialog appearance. It is similar to the System Identification Using MATLAB System Blocks Simulink example.

---

**Note:** Instead of manually creating your class definition file, you can use the **New > System Object > Simulink Extension** menu option to open a template. This template includes customizations of the System object for use in the Simulink MATLAB System block. You edit the template file, using it as guideline, to create your own System object.

---

On the first line of the class definition file, specify the name of your System object and subclass from both `matlab.System` and `matlab.system.mixin.CustomIcon`. The `matlab.System` base class enables you to use all the basic System object methods and specify the block input and output names, title, and property groups. The `CustomIcon` mixin class enables the method that lets you specify the block icon.

Add the appropriate basic System object methods to set up, reset, set the number of inputs and outputs, and run your algorithm. See the reference pages for each method and the full class definition file below for the implementation of each of these methods.

- Use the `setUpImpl` method to perform one-time calculations and initialize variables.
- Use the `stepImpl` method to implement the block's algorithm.
- Use the `resetImpl` method to reset the state properties or `DiscreteState` properties.
- Use the `getNumInputsImpl` and `getNumOutputsImpl` methods to specify the number of inputs and outputs, respectively.

Add the appropriate `CustomIcon` methods to define the appearance of the MATLAB System block in Simulink. See the reference pages for each method and the full class definition file below for the implementation of each of these methods.

- Use the `getHeaderImpl` method to specify the title and description to display on the block dialog.
- Use the `getPropertyGroupsImpl` method to specify groups of properties to display on the block dialog.
- Use the `getIconImpl` method to specify the text to display on the block icon.
- Use the `getInputNamesImpl` and `getOutputNamesImpl` methods to specify the labels to display for the block input and output ports.



The full class definition file for the least mean squares filter is:

```
classdef lmsSysObj < matlab.System &...
    matlab.system.mixin.CustomIcon
    % lmsSysObj Least mean squares (LMS) adaptive filtering.
    % #codegen

    properties
        % Mu Step size
        Mu = 0.005;
    end

    properties (Nontunable)
        % Weights Filter weights
        Weights = 0;
        % N Number of filter weights
        N = 32;
    end

    properties (DiscreteState)
        X;
        H;
    end

    methods (Access = protected)
        function setupImpl(obj)
            obj.X = zeros(obj.N,1);
            obj.H = zeros(obj.N,1);
        end

        function [y, e_norm] = stepImpl(obj,d,u)
            tmp = obj.X(1:obj.N-1);
            obj.X(2:obj.N,1) = tmp;
            obj.X(1,1) = u;
            y = obj.X'*obj.H;
            e = d-y;
            obj.H = obj.H + obj.Mu*e*obj.X;
            e_norm = norm(obj.Weights' -obj.H);
        end

        function resetImpl(obj)
            obj.X = zeros(obj.N,1);
            obj.H = zeros(obj.N,1);
        end
    end
end
```

```
end

% Block icon and dialog customizations
methods (Static, Access = protected)
    function header = getHeaderImpl
        header = matlab.system.display.Header(...
            'lmsSysObj', ...
            'Title', 'LMS Adaptive Filter');
    end

    function groups = getPropertyGroupsImpl
        upperGroup = matlab.system.display.SectionGroup(...
            'Title', 'General', ...
            'PropertyList', {'Mu'});

        lowerGroup = matlab.system.display.SectionGroup(...
            'Title', 'Coefficients', ...
            'PropertyList', {'Weights', 'N'});

        groups = [upperGroup, lowerGroup];
    end
end

methods (Access = protected)
    function icon = getIconImpl(~)
        icon = sprintf('LMS Adaptive\nFilter');
    end
    function [in1name, in2name] = getInputNamesImpl(~)
        in1name = 'Desired';
        in2name = 'Actual';
    end
    function [out1name, out2name] = getOutputNamesImpl(~)
        out1name = 'Output';
        out2name = 'EstError';
    end
end
end
```

### Define System Object with Nondirect Feedthrough

Create a System object for use in Simulink. The example performs system identification using a least mean squares (LMS) adaptive filter and uses feedback loops.

Create a class definition text file to define your System object. The code in this example creates an integer delay and includes feedback loops, and customizations to the block icon. For information on feedback loops, see “Use System Objects in Feedback Loops” on page 42-15. This example implements a System object that you can use for nondirect feedthrough. It is similar to the System Identification Using MATLAB System Blocks Simulink example.

On the first line of the class definition file, subclass from `matlab.System` and `matlab.system.mixin.CustomIcon`. The `matlab.System` base class enables you to use all the basic System object methods and specify the block input and output names, title, and property groups. The `CustomIcon` mixin class enables the method that lets you specify the block icon. The `Nondirect` mixin enables the methods that let you specify how the block is updated and what it outputs.

Add the appropriate basic System object methods to set up and reset the object and set and validate the properties. Since this object supports nondirect feedthrough, you do not implement the `stepImpl` method. You implement the `updateImpl` and `outputImpl` methods instead. See the reference pages for each method and the full class definition file below for the implementation of each of these methods.

- Use the `setupImpl` method to initialize some of the object’s properties.
- Use the `resetImpl` method to reset the property states.
- Use the `validatePropertiesImpl` method to check that the property values are valid.

Add the following `Nondirect` mixin class methods instead of the `stepImpl` method to specify how the block updates its state and its output. See the reference pages and the full class definition file below for the implementation of each of these methods.

- Use the `outputImpl` method to implement code to calculate the block output.
- Use the `updateImpl` method to implement code to update the block’s internal states.
- Use the `isInputDirectFeedthroughImpl` method to specify that the block is not direct feedthrough. Its inputs do not directly affect its outputs.

Add the `getIconImpl` method to define the block icon when it is used in Simulink via the MATLAB System block. See the reference page and the full class definition file below for the implementation of this method.

The full class definition file for the delay is:

```
classdef intDelaySysObj < matlab.System &...
```

```

    matlab.system.mixin.Nondirect &...
    matlab.system.mixin.CustomIcon
% intDelaySysObj Delay input by specified number of samples.
% #codegen

properties
    % InitialOutput Initial output
    InitialOutput = 0;
end

properties (Nontunable)
    % NumDelays Number of delays
    NumDelays = 1;
end

properties (DiscreteState)
    PreviousInput;
end

methods (Access = protected)
    function setupImpl(obj, ~)
        obj.PreviousInput = ones(1,obj.NumDelays)*obj.InitialOutput;
    end

    function [y] = outputImpl(obj, ~)
        % Output does not directly depend on input
        y = obj.PreviousInput(end);
    end

    function updateImpl(obj, u)
        obj.PreviousInput = [u obj.PreviousInput(1:end-1)];
    end

    function flag = isInputDirectFeedthroughImpl(~,~)
        flag = false;
    end

    function validatePropertiesImpl(obj)
        if ((numel(obj.NumDelays)>1) || (obj.NumDelays <= 0))
            error('Number of delays must be positive non-zero scalar value.');
```

```
end

function resetImpl(obj)
    obj.PreviousInput = ones(1,obj.NumDelays)*obj.InitialOutput;
end

function icon = getIconImpl(~)
    icon = sprintf('Integer\nDelay');
end
end
end
```

## Test New System Objects in MATLAB

- 1 Create an instance of your new System object. For example, create an instance of the `lmsSysObj`.

```
s = lmsSysObj;
```

- 2 Run the object multiple times with different inputs. This tests for syntax errors and other possible issues before you add it to Simulink. For example,

```
desired = 0;
actual = 0.2;
s(desired,actual);
```

## Add System Objects to Your Simulink Model

- 1 Add your System objects to your Simulink model by using the MATLAB System block as described in “Mapping System Objects to Block Dialog Box” on page 42-20.
- 2 Add other Simulink blocks, connect them, and configure any needed parameters to complete your model as described in the Simulink documentation. See the System Identification for an FIR System Using MATLAB System Blocks Simulink example.
- 3 Run your model in the same way you run any Simulink model.



# System Objects in Simulink

---

- “MATLAB System Block” on page 42-2
- “Implement a MATLAB System Block” on page 42-8
- “Change Blocks Implemented with System Objects” on page 42-11
- “Change Block Icon and Port Labels” on page 42-12
- “Nonvirtual Buses and MATLAB System Block” on page 42-14
- “Use System Objects in Feedback Loops” on page 42-15
- “Simulation Modes” on page 42-17
- “Mapping System Objects to Block Dialog Box” on page 42-20
- “Considerations for Using System Objects in Simulink” on page 42-25
- “Simulink Engine Interaction with System Object Methods” on page 42-28
- “Add and Implement Propagation Methods” on page 42-31
- “Share Data with Other Blocks” on page 42-34
- “Troubleshoot System Objects in Simulink” on page 42-43

## MATLAB System Block

### In this section...

“Why Use the MATLAB System Block?” on page 42-2

“Choosing the Right Block Type” on page 42-2

“System Objects” on page 42-3

“Interpreted Execution or Code Generation” on page 42-3

“Default Input Signal Attributes” on page 42-4

“MATLAB System Block Limitations” on page 42-4

“MATLAB System and System Objects Examples” on page 42-5

### Why Use the MATLAB System Block?

System objects let you implement algorithms using the MATLAB language. The MATLAB System block enables you to use System objects in Simulink.

The MATLAB System block lets you:

- Share the same System object in MATLAB and Simulink
- Dedicate integration of System objects with Simulink
- Unit test your algorithm in MATLAB before using it in Simulink
- Customize dialog box customization
- Simulate efficiently with better initialization
- Handle states
- Customize block icons with port labels
- Access two simulation modes

### Choosing the Right Block Type

There are several mechanisms for including MATLAB algorithms in Simulink, such as:

- MATLAB System block
- MATLAB Function block



- Interpreted MATLAB Function block
- Level-2 MATLAB S-Function block
- Fcn block

For help on choosing the right block, see “Comparison of Custom Block Functionality” on page 38-7.

## System Objects

Before you use a MATLAB System block, you must have a System object to associate with the block. A System object is a specialized kind of MATLAB class. System objects are designed specifically for implementing and simulating dynamic systems with inputs that change over time.

For more information on creating System objects, see “Customize System Objects for Simulink”.

---

**Note:** To use your System object in the Simulink environment, it must have a constructor that you can call with no arguments. By default, the System object constructor has this capability and you do not need to define your own constructor. However, if you create your own System object constructor, you must be able to call it with no arguments.

---

System objects exist in other MATLAB products. MATLAB System block supports only the System objects written in the MATLAB language. In addition, if a System object has a corresponding Simulink block, you cannot implement a MATLAB System block for it.

## Interpreted Execution or Code Generation

You can use MATLAB System blocks in Simulink models for simulation via interpreted execution or code generation.

- With interpreted execution, the model simulates the block using the MATLAB execution engine.
- With code generation, the model simulates the block using code generation (requires the use the subset of MATLAB code supported for code generation). For a list of supported functions, see “Functions and Objects Supported for C/C++ Code Generation — Alphabetical List” on page 44-2.

## Default Input Signal Attributes

If a MATLAB System block has one or more inputs that are unconnected to another block's output port or connected to a port that has underspecified attributes, the default input signal attributes for the unspecified attributes are:

Data Attribute	Default
Data Type	double
Size	[1 1] scalar
Complexity	real

## MATLAB System Block Limitations

These capabilities are currently not supported.

Category	Limitation Description	Workaround
System Objects	Tunable logical and character vector properties of the System object are nontunable parameters in the MATLAB System block.	—
Data Types	<ul style="list-style-type: none"> <li>The MATLAB System block does not support virtual buses as input or output.</li> <li>System objects cannot use fixed-point signals with nonbinary point scaling or nonzero bias.</li> <li>System objects cannot use user-defined opaque data types.</li> </ul>	—
Sample Time	Cannot use MATLAB System blocks to model continuous time or multirate systems.	—
Linearizations	Cannot use Jacobian based linearization.	—
Global Variables	Global variables defined in the model Configuration Parameters <b>Simulation Target &gt; Custom</b>	—

Category	Limitation Description	Workaround
	<b>Code</b> pane and referenced by the System object are not shared with Stateflow and the MATLAB Function block.	
Debugging	MATLAB debugging for code-generation-based simulation.	Set the MATLAB System block <b>Simulate using</b> parameter to <b>Interpreted execution</b> , and then debug. When you are done, set <b>Simulate using</b> back to <b>Code generation</b> .
Fixed-Point Tool	The Fixed-Point Tool does not return design min/max, min/max logging, and autoscaling information for MATLAB System blocks.	—
Model coverage analysis (Simulink Verification and Validation software)	Simulink Verification and Validation cannot perform model analysis for MATLAB System block with <b>Simulate using</b> parameter set to <b>Interpreted execution</b> .	—
Check model compatibility (Simulink Design Verifier software)	Simulink Design Verifier cannot perform compatibility checks for a model or subsystem that contains a MATLAB System block.	—

## MATLAB System and System Objects Examples

For examples of MATLAB System and System objects, see:

Example	Description
System Identification for an FIR System Using MATLAB System Blocks	This example shows how to use the MATLAB System block to implement Simulink blocks using a System object. It highlights two MATLAB System blocks. Access the MATLAB source code for each System object by clicking the <b>Source code</b> link from the block dialog box.

Example	Description
Variable-Size Input and Output Signals Using MATLAB System Blocks	This example shows how to use the MATLAB System block to implement Simulink blocks with variable-size input and output signals. Due to the use of variable-size signals, the example uses propagation methods.
Illustration of Law of Large Numbers Using MATLAB System Blocks	This example shows how to use MATLAB System blocks to illustrate the law of large numbers. Due to the use of MATLAB functions not supported for code generation, the example uses propagation methods and interpreted execution.
Using Buses with MATLAB System Blocks	This example shows how to use MATLAB System blocks with nonvirtual buses at input or output. Due to the use Simulink buses, the example uses propagation methods. The example defines the bus types in the MATLAB base workspace using model callbacks.

## See Also

MATLAB System

## Related Examples

- “Implement a MATLAB System Block” on page 42-8
- “Change Blocks Implemented with System Objects” on page 42-11
- “Change Block Icon and Port Labels” on page 42-12
- “Add and Implement Propagation Methods” on page 42-31
- “Use System Objects in Feedback Loops” on page 42-15
- “Troubleshoot System Objects in Simulink” on page 42-43

## More About

- “Customize System Objects for Simulink”
- “Mapping System Objects to Block Dialog Box” on page 42-20
- “Simulation Modes” on page 42-17

- “Simulink Engine Interaction with System Object Methods” on page 42-28
- “Nonvirtual Buses and MATLAB System Block” on page 42-14
- “Considerations for Using System Objects in Simulink” on page 42-25
- “Comparison of Custom Block Functionality” on page 38-7

## Implement a MATLAB System Block

Implement a block and assign a System object to it. You can then explore the block to see the effect.

- 1 Create a new model and add the MATLAB System block from the User-Defined Functions library.

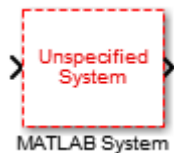

- 2 In the block dialog box, from the **New** list, select **Basic**, **Advanced**, or **Simulink Extension** if you want to create a new System object from a template. Modify the template according to your needs and save the System object.
- 3 Enter the full path name for the System object in the **System object name**. Click the list arrow. If valid System objects exist in the current folder, the names appear in the list.

The MATLAB System block icon and port labels update to those of the corresponding System object. For example, suppose you selected a System object named `lmsSysObj` in your current folder. The block updates as shown in the figure:

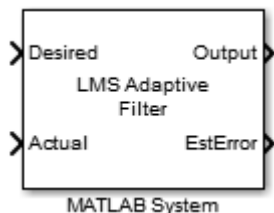



---

**Note:** After you associate the block with a System object class name, you cannot assign a new System object using the same MATLAB System block dialog box. Instead, right-click the MATLAB System block, select **Block Parameters (MATLABSystem)** and enter a new class name in **System object name**.

---

## Understanding the MATLAB System Block

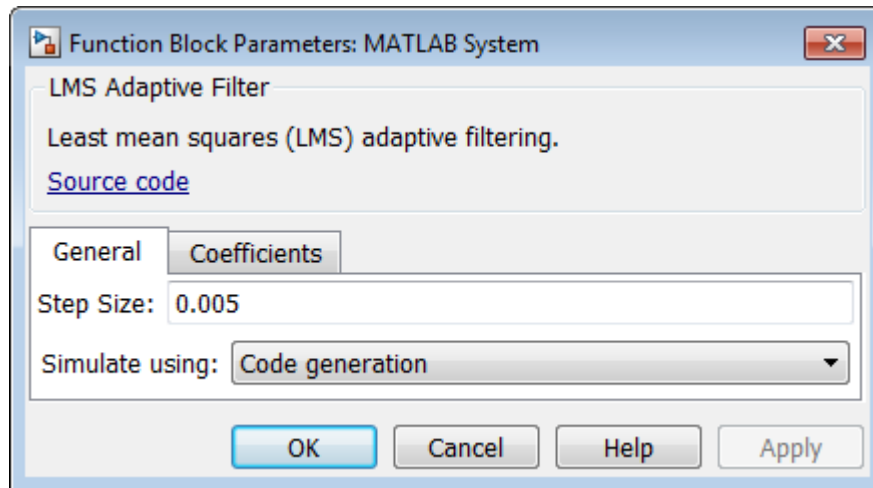
- 1 Double-click the block. The MATLAB System dialog box reflects the System object parameters. The dialog box usually includes a **Source code** link that leads to the System object class file. For example:



The **Source code** link appears if the System object uses MATLAB language. It does not appear if you have:

- Converted the System object to P-code
  - Overridden the default behavior using the `getHeaderImpl` method
- 2 Click **Source code** and observe that the public and active properties in the System object appear in the MATLAB System block dialog box as block parameters.
  - 3 Select how you want the model to simulate the block using the **Simulate using** parameter. (This parameter appears at the bottom of each MATLAB System block if there is only one tab, or the bottom of the first of multiple tabs.)

## Related Examples

- “Change Blocks Implemented with System Objects” on page 42-11

## More About

- “MATLAB System Block” on page 42-2

- “Mapping System Objects to Block Dialog Box” on page 42-20
- “Simulation Modes” on page 42-17



## Change Blocks Implemented with System Objects

To implement a block with another System object, right-click the MATLAB System block and select Block Parameters (MATLABSystem). Then, use the block dialog box to identify a new class name in **System object name**. For more information, see “Implement a MATLAB System Block” on page 42-8.

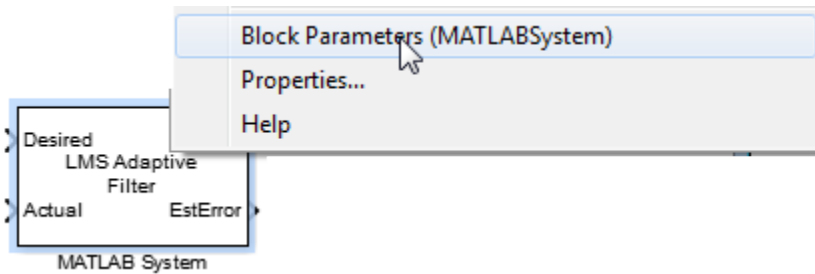

### Related Examples

- “System Identification for an FIR System Using MATLAB System Blocks”

## Change Block Icon and Port Labels

To change the icon appearance of your block, you must use the `matlab.system.mixin.CustomIcon` class. You can define port labels using System object methods.

- 1 Add the `matlab.system.mixin.CustomIcon` class name to the System object, after the `matlab.System` class. For example:

```
classdef lmsSysObj < matlab.System & matlab.system.mixin.CustomIcon
```

This code subclasses from the `matlab.system.mixin.CustomIcon` class in addition to the `matlab.System` base class.

- 2 To define the icon, implement the `getIconImpl` method.
- 3 To define the port labels, implement the following optional methods to change the input and output port labels. You do not need the `matlab.system.mixin.CustomIcon` class to use these methods.

```
getInputNamesImpl  
getOutputNamesImpl
```

If you do not implement these methods, the System object uses the input and output port names from the `stepImpl` method. If you are using the `matlab.system.mixin.Nondirect` class and do not implement these methods, the System object uses the input names from `updateImpl` and the output port names from `OutputImpl`.

## Modify MATLAB System Block Dialog

To change the MATLAB System block dialog, implement the methods for the following classes:

Description	<code>matlab.system.display</code> Methods
Define header text for property group.	<code>matlab.system.display.Header</code>
Group properties together.	<code>matlab.system.display.Section</code>
Group properties into a separate tab.	<code>matlab.system.display.SectionGroup</code>

## Change the MATLAB System Block Icon to an Image

You can change the image of MATLAB System block in MATLAB Editor. For a list of accepted image files, see `image`. To use an existing image file for the MATLAB System block:

- 1 Double-click your MATLAB System block.
- 2 In the block dialog box, click the **Source code**. The MATLAB Editor that contains the System object code opens.
- 3 In the MATLAB Editor, from the **System Block** drop-down list, select **Add Image Icon**.
- 4 In the **Add image icon** dialog window, click **Browse** to select an image of your choice.
- 5 Click **OK** to insert the corresponding code for the `getIconImpl` method in your System object.

For more information, see “Customize System Block Appearance” on page 41-2.

### See Also

`matlab.system.display.Icon` | MATLAB System

### Related Examples

- “System Identification for an FIR System Using MATLAB System Blocks”
- “Customize System Objects for Simulink”

## Nonvirtual Buses and MATLAB System Block

The MATLAB System block supports nonvirtual buses as input and output signals. The corresponding System object input or output must be a MATLAB structure whose fields match those defined by the nonvirtual bus. If the System object output is a MATLAB structure, it must define propagator methods. In addition, the `getOutputDataTypeImpl` method must return the name of the corresponding bus object. This bus object must exist in the base workspace or a data dictionary linked to the model.

---

**Note:** If the output is the same bus type as the input, do not use the `propagatedInputDataType` method to obtain the name of the bus object. Instead, you must return the name of the bus object directly.

---

### Related Examples

- Using Buses with MATLAB System Blocks

### More About

- “Customize System Objects for Simulink”

## Use System Objects in Feedback Loops

If your algorithm needs to process nondirect feedthrough data through the System object, use the `matlab.system.mixin.Nondirect` class. This class uses the `output` and `update` methods to process nondirect feedthrough data through a System object.

Most System objects use direct feedthrough, where the object's input is needed to generate the output. For these direct feedthrough objects, the `step` method calculates the output and updates the state values. For nondirect feedthrough, however, the object's output depends on internal states and not directly on the inputs. The inputs, or a subset of the inputs, are used to update the object states. For these objects, calculating the output is separated from updating the state values. This enables you to use an object as a feedback element in a feedback loop.

A delay object is an example of a nondirect feedthrough object.

- 1 Add the `matlab.system.mixin.Nondirect` class to the top of the parent class file for the System object, after the `matlab.System` class. For example:

```
IntegerDelaySysObj < matlab.System & matlab.system.mixin.Nondirect
```

This step subclasses from the `matlab.system.mixin.Nondirect` class in addition to the `matlab.System` base class.

- 2 Implement the following methods:

```
outputImpl
updateImpl
```

When implementing the `outputImpl` method, do not access the System object inputs for which the direct feedthrough flag is false.

- 3 If the System object supports code generation and does not inherit from `matlab.system.mixin.Propagates`, Simulink can automatically infer the direct feedthrough settings from the System object MATLAB code. However, if the System object does not support code generation, the default `isInputDirectFeedthroughImpl` method returns false (no direct feedthrough). In this case, override this method if you want nondefault behavior.

The processing of the nondirect feedthrough changes the way that the software calls the System object methods within the context of the Simulink engine.

### **Related Examples**

- “System Identification for an FIR System Using MATLAB System Blocks”

### **More About**

- “Simulink Engine Interaction with System Object Methods” on page 42-28
- “Customize System Objects for Simulink”

# Simulation Modes

## Interpreted Execution vs. Code Generation

You can use MATLAB System block in Simulink models for simulation via interpreted execution or code generation. Implementing a MATLAB System block with a valid System object class name enables the **Simulate using** parameter. This parameter appears at the bottom of each MATLAB System block if there is only one tab, or the bottom of the first of multiple tabs. Use the **Simulate using** parameter to control how the block simulates. The table describes how to choose the right value for your purpose.

- With interpreted execution, the model simulates the block using the MATLAB execution engine.

---

**Note:** With interpreted execution, if you set the **Optimization > Use division for fixed-point net slope computation** parameter to On or Use division for reciprocals of integers only in the Configuration Parameters dialog box, you might get unoptimized numeric results. This is because MATLAB code does not support this parameter.

---

- With code generation, the model simulates the block using code generation, using the subset of MATLAB code supported for code generation.

Action	Select	Pros	Cons
Upon first model run, simulate and generate code for MATLAB System using only the subset of MATLAB functions supported for code generation. Choosing this option causes the simulation to run the generated code.	Code generation (default)	Potentially better performance.	System object is limited to the subset of MATLAB functions supported for code generation. Simulation may start more slowly.
Simulate model using all supported MATLAB functions.	Interpreted execution	System object can contain any supported	Potentially slower performance. If the MATLAB functions in the System object do not

Action	Select	Pros	Cons
Choosing this option can slow simulation performance.		MATLAB function. Faster startup time.	support code generation, the System object must contain propagation methods.

To take advantage of faster performance, consider using propagation methods in your System object. For more information, see “Add and Implement Propagation Methods” on page 42-31.

## Simulation Using Code Generation

While simulating and generating code for one or more simulation targets (in this case, System object blocks), the model displays status messages in the bottom left of the Simulink Editor window. A model can have multiple copies of the same block, where blocks are considered the same if they

- Use the same System object.
- Have inputs and tunable parameters that have identical signals, data types, and complexities.
- Have nontunable parameters that have the same value.

When the model has multiple copies of the same block, the software does not regenerate the code for each block. It reuses the code from the first time that code was generated for one of these blocks. The status messages reflect this and do not show status messages for each of these blocks.

When the code generation process is complete, Simulink creates a MEX-file for the generated code.

### See Also

MATLAB System

### Related Examples

- “Implement a MATLAB System Block” on page 42-8
- “Change Blocks Implemented with System Objects” on page 42-11
- “Change Block Icon and Port Labels” on page 42-12
- “Add and Implement Propagation Methods” on page 42-31



- “Use System Objects in Feedback Loops” on page 42-15
- “Troubleshoot System Objects in Simulink” on page 42-43

## **More About**

- “Customize System Objects for Simulink”
- “Mapping System Objects to Block Dialog Box” on page 42-20
- “Simulink Engine Interaction with System Object Methods” on page 42-28
- “Nonvirtual Buses and MATLAB System Block” on page 42-14
- “Considerations for Using System Objects in Simulink” on page 42-25
- “Comparison of Custom Block Functionality” on page 38-7

## Mapping System Objects to Block Dialog Box

The System object source code controls the appearance of the block dialog box. This section describes System object to block dialog box mapping using the System Identification for an FIR System Using MATLAB System Blocks example. This example uses two System objects, one that uses default System object to block dialog box mapping, and one that uses a custom mapping.

In this section...
“System Object to Block Dialog Box Default Mapping” on page 42-20
“System Object to Block Dialog Box Custom Mapping” on page 42-22

### System Object to Block Dialog Box Default Mapping

The following figure shows how the source code corresponds to the dialog box elements if you do not customize the dialog using the `getHeaderImpl` or `getPropertyGroupsImpl` methods. (The link to open the source code and the **Simulate using** parameter appear on all MATLAB System block dialog boxes.)

Header description from class help summary

Header title from class name

Labels from property help summary

Property type and default value from property attributes

Simulate mode widget included in all dialogs

Link to open source MATLAB code

```

classdef WidgetTypes < matlab.System
%WidgetTypes Show available dialog widget types
% This class contains properties to illustrate how System block dialog
% widgets are rendered for different System object property types.

properties(Nontunable, Logical)
%LogicalProperty A logical property
% This property has the logical attribute.
LogicalProperty = true;
end

|
properties(Nontunable)
StringSetProperty = 'default'; % A string set property
EditFieldProperty = 10; % An edit field property
end
properties(SetAccess = protected, Nontunable, Logical)
ReadOnlyLogicalProperty = true;
end
properties(SetAccess = protected, Nontunable)
ReadOnlyStringSetProperty = 'default';
ReadOnlyEditFieldProperty = 10;
end

properties(Constant, Hidden)
StringSetPropertySet = ...
matlab.system.StringSet({'default', 'nondefault'});
end

methods
function obj = WidgetTypes(varargin)
setProperties(obj, nargin, varargin{:});
end
end
methods(Access = protected)
function y = stepImpl(~, u)
y = u;
end
end
end
end
    
```

Function Block Parameters: MATLAB System

WidgetTypes

Show available dialog widget types

[Source code](#)

Parameters

A logical property

A string set property: default

An edit field property: 10

ReadOnlyLogicalProperty: true

ReadOnlyStringSetProperty: default

ReadOnlyEditFieldProperty: 10

Simulate using: Code generation

OK Cancel Help Apply

The Delay block from the System Identification for an FIR System Using MATLAB System Blocks is an example of a block that uses a System object that draws the dialog box using the default mapping. This block has one input and one output.

This block uses a System object that has direct feedthrough set to false (nondirect feedthrough). This setting means that the System object does not directly use the input to compute the output, enabling the model to use this block safely in a feedback system without introducing an algebraic loop. For more information on nondirect feedthrough, see “Use System Objects in Feedback Loops” on page 42-15.

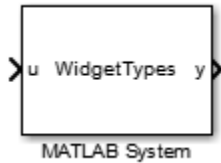

For an example of a custom block dialog box, see “System Object to Block Dialog Box Custom Mapping” on page 42-22.

## System Object to Block Dialog Box Custom Mapping

The LMS Adaptive block is an example of a block with a custom header and property groups. The System object code uses the `getHeaderImpl` and `getPropertyGroupsImpl` methods from `matlab.System` to customize these block dialog elements.

The LMS Adaptive Filter block estimates the coefficients of an unknown system (formed by the Unknown System and Delay blocks). Its inputs are the desired signal and the actual signal. Its outputs are the estimated signal and the vector norm of the error in the estimated coefficients. It uses the `lmsSysObj` System object.

```

classdef lmsSysObj < matlab.System & matlab.system.mixin.CustomIcon
%lmsSysObj Least mean squares (LMS) adaptive filtering.

methods(Static, Access=protected)

function header = getHeaderImpl
header = matlab.system.display.Header(...
'Title', 'LMS Adaptive Filter');
end

function groups = getPropertyGroupsImpl
firstGroup = matlab.system.display.SectionGroup(...
'Title', 'General', ...
'PropertyList', {'Mu'});

secondGroup = matlab.system.display.SectionGroup(...
'Title', 'Coefficients', ...
'PropertyList', {'TrueCoefficients', 'NumCoeff'});

groups = [firstGroup, secondGroup];
end
end
    
```

Header description from class help summary

Specified header title overrides class name

Tabs from SectionGroups

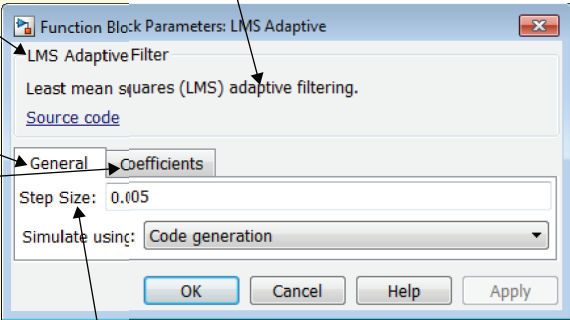

```

properties
% Mu Step Size
Mu = 0.005;
end
    
```

Label from product help summary

The source code for this System object also defines two input and output ports for the block.

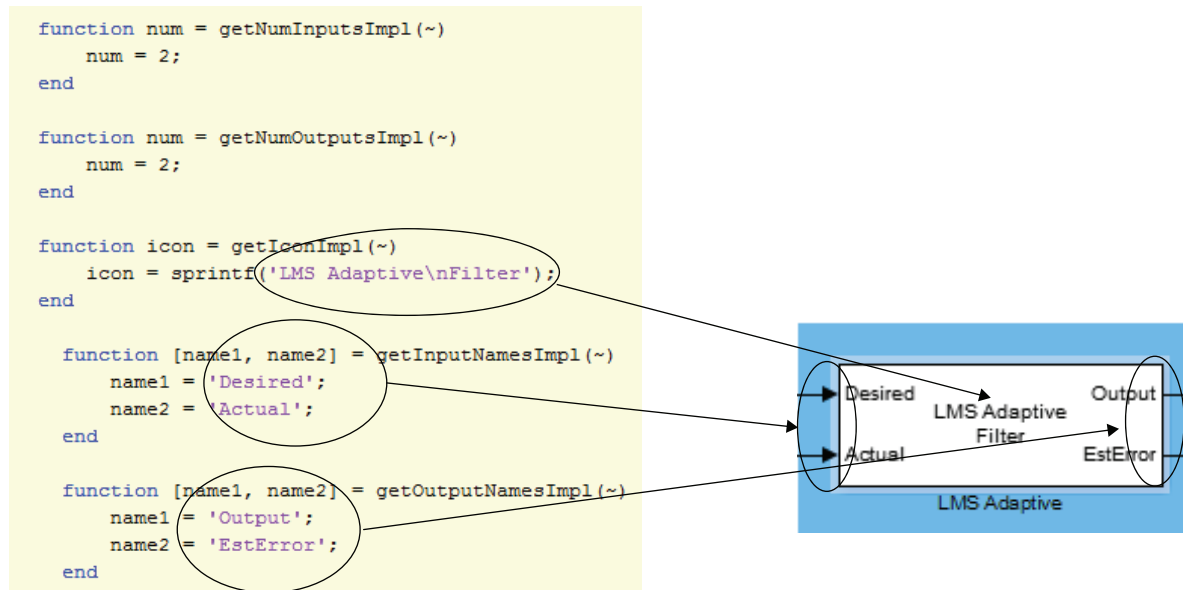

## More About

- “Change Block Icon and Port Labels” on page 42-12
- “Modify MATLAB System Block Dialog” on page 42-12

# Considerations for Using System Objects in Simulink

## In this section...

“System Objects in Simulink” on page 42-25

“System Objects in For Each Subsystems” on page 42-26

“Input Validation” on page 42-26

## System Objects in Simulink

There are differences in how you can use System objects in a MATLAB System block in Simulink versus using the same object in MATLAB. You see these differences when working with variable-size signals and tunable parameters and when using System objects as properties.

### Variable-Size Signals

To use variable-size signals in a System object, you must implement `matlab.system.mixin.Propagates` methods. In particular, use the `isOutputFixedSizeImpl` method to specify if an output is variable-size or fixed-size. This is true for interpreted execution and code generation simulation methods.

### Tunable Parameters

Simulink registers public tunable properties of a System object as tunable parameters of the corresponding MATLAB System block. If a System object property is tunable, it is also tunable in the MATLAB System block. At runtime, you can change the parameter using one of the following approaches. The change applies at the top of the simulation loop.

- At the MATLAB command line, use the `set_param` to change the parameter value.
- In the Simulink editor, edit the MATLAB System block dialog box to change the parameter value, and then update the block diagram.

You cannot change public tunable properties from System object internal methods such as `stepImpl`.

During simulation, setting an invalid value on a tunable parameter causes an error message and stops simulation.

### **System Objects as Properties**

The MATLAB System block allows a System object to have other System objects as public or private properties. However:

- System objects and other MATLAB objects stored as public properties are read only. As a result, you cannot set the value of the parameter, you can only get the value of a parameter.
- System objects stored as property values appear dimmed in the MATLAB System block dialog box.

### **Default Property Values**

MATLAB does not require that objects assign default values to properties. However, in Simulink, if your System object has properties with no assigned default values, the associated dialog box parameter requires that the value data type be a built-in Simulink data type.

### **System Objects in For Each Subsystems**

To use the MATLAB System block within a For Each Subsystem block, implement the `matlab.system.supportsMultipleInstanceImpl` method. This method should return `true`. The MATLAB System block clones the System object for each For Each Subsystem iteration.

### **Input Validation**

In Simulink, use the `validateInputsImpl` method to validate only attributes (size, data type, and complexity) of the input. Do not use this method to validate the value of the input.

### **See Also**

MATLAB System

### **Related Examples**

- “Implement a MATLAB System Block” on page 42-8
- “Change Blocks Implemented with System Objects” on page 42-11
- “Change Block Icon and Port Labels” on page 42-12



- “Add and Implement Propagation Methods” on page 42-31
- “Use System Objects in Feedback Loops” on page 42-15
- “Troubleshoot System Objects in Simulink” on page 42-43

## **More About**

- “Customize System Objects for Simulink”
- “Mapping System Objects to Block Dialog Box” on page 42-20
- “Simulink Engine Interaction with System Object Methods” on page 42-28
- “Simulation Modes” on page 42-17
- “Nonvirtual Buses and MATLAB System Block” on page 42-14
- “Comparison of Custom Block Functionality” on page 38-7

## **Simulink Engine Interaction with System Object Methods**

### **Simulink Engine Phases Mapped to System Object Methods**

This diagram shows a process view of the order in which the MATLAB System block invokes System object methods within the context of the Simulink engine.

## Initialization

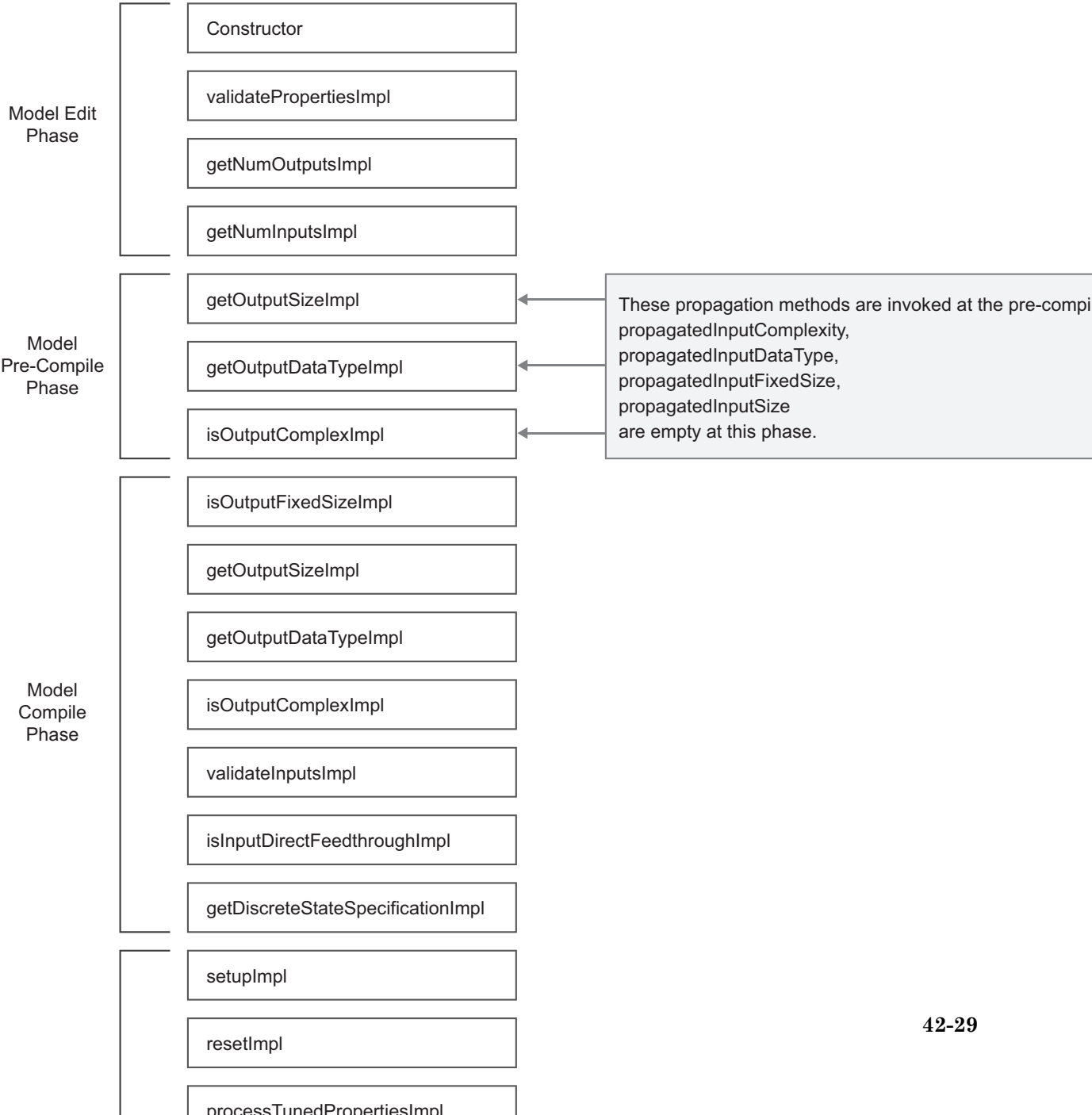

Note the following:

- Simulink calls the `stepImpl`, `outputImpl`, and `updateImpl` methods multiple times during simulation at each time step. Simulink typically calls other methods once per simulation.
- The Simulink engine calls the `isOutputFixedSizeImpl`, `getDiscreteStateSpecificationImpl`, `isOutputComplexImpl`, `getOutputDataTypeImpl`, `getOutputSizeImpl` when using `matlab.system.mixin.Propagates`.
- Simulink calls `saveObjectImpl` and `loadObjectImpl` for saving and restoring `SimState`, the Simulation Stepper, and Fast Restart.
- Default implementations save and restore all properties with public access, including `DiscreteState`.

## See Also

MATLAB System

## Related Examples

- “Implement a MATLAB System Block” on page 42-8
- “Change Blocks Implemented with System Objects” on page 42-11
- “Change Block Icon and Port Labels” on page 42-12
- “Add and Implement Propagation Methods” on page 42-31
- “Use System Objects in Feedback Loops” on page 42-15
- “Troubleshoot System Objects in Simulink” on page 42-43

## More About

- “Customize System Objects for Simulink”
- “Mapping System Objects to Block Dialog Box” on page 42-20
- “Simulation Modes” on page 42-17
- “Nonvirtual Buses and MATLAB System Block” on page 42-14
- “Considerations for Using System Objects in Simulink” on page 42-25
- “Comparison of Custom Block Functionality” on page 38-7

## Add and Implement Propagation Methods

### In this section...

“When to Use Propagation Methods” on page 42-31

“Add Propagation Methods to System Objects” on page 42-31

“Implement Propagation Methods” on page 42-32

### When to Use Propagation Methods

Propagation methods define output specifications. Use them when the output specifications cannot be inferred directly from the inputs during Simulink model compilation.

Consider using propagation methods in your System object when:

- The System object requires access to all MATLAB functions that do not support code generation, which means that you cannot generate code for simulation. You must use propagation methods in this case. Use these methods to specify information for the outputs.
- You want to use variable-size signals.
- You do not care whether code is generated, but you want to improve startup performance. Use propagation methods to specify information for the inputs and outputs, enabling quicker startup time.

At startup, the Simulink software tries to evaluate the input and output ports of the model blocks for signal attribute propagation. In the case of MATLAB System blocks, if the software cannot perform this evaluation, it displays a message prompting you to add propagation methods to the System object.

### Add Propagation Methods to System Objects

Propagation methods are in the class `matlab.system.mixin.Propagates`. To add these methods to the System object, add the `matlab.system.mixin.Propagates` class to the top of the parent class file for the System object, after the `matlab.System` class. For example:

```
classdef Counter < matlab.System & matlab.system.mixin.Propagates
```

## Implement Propagation Methods

Simulink evaluates the uses of the propagation methods to evaluate the input and output ports of the MATLAB System block for startup.

Each method has a default implementation, listed in the **Default Implementation Should Suffice if** column. If your System object does not use the default implementation, you must implement a version of the propagation method for your System object.

Description	Propagation Method	Default Implementation Should Suffice if	Example
Gets dimensions of output ports. The associated method is <code>getOutputSize</code> .	<code>getOutputSizeImpl</code>	<ul style="list-style-type: none"> <li>• Only one input</li> <li>• Only one output</li> <li>• An input size that is the same as the output size</li> </ul>	<ul style="list-style-type: none"> <li>• <code>FindIfFixedInput</code> or <code>FindIfVarSizeInput</code> block in MATLAB System Block with Variable-Size Input and Output Signals</li> <li>• Analysis block in Illustration of Law of Large Numbers</li> </ul>
Gets data types of output ports. The associated method is <code>getOutputDataType</code> .	<code>getOutputDataTypeImpl</code>	<ul style="list-style-type: none"> <li>• Only one input</li> <li>• Only one output</li> <li>• Output data type always the same as the input data type</li> </ul>	<ul style="list-style-type: none"> <li>• <code>FindIfFixedInput</code> or <code>FindIfVarSizeInput</code> block in MATLAB System Block with Variable-Size Input and Output Signals</li> <li>• Analysis block in Illustration of Law of Large Numbers</li> </ul>
Indicates whether output ports are complex or not. The associated method is <code>isOutputComplex</code> .	<code>isOutputComplexImpl</code>	<ul style="list-style-type: none"> <li>• Only one input</li> <li>• Only one output</li> <li>• Output complexity always the same as the input complexity</li> </ul>	<ul style="list-style-type: none"> <li>• <code>FindIfFixedInput</code> or <code>FindIfVarSizeInput</code> block in MATLAB System Block with Variable-Size Input and Output Signals</li> </ul>

Description	Propagation Method	Default Implementation Should Suffice if	Example
			<ul style="list-style-type: none"> <li>Analysis block in Illustration of Law of Large Numbers</li> </ul>
Whether output ports are fixed size. The associated method is <code>isOutputFixed Size</code> .	<code>isOutputFixedSizeImpl</code>	<ul style="list-style-type: none"> <li>Only one input</li> <li>Only one output</li> <li>Output and input are fixed-size</li> </ul>	<ul style="list-style-type: none"> <li><code>FindIfFixedInput</code> or <code>FindIfVarSizeInput</code> block in MATLAB System Block with Variable-Size Input and Output Signals</li> <li>Analysis block in Illustration of Law of Large Numbers</li> </ul>
Gets the size, data type, and complexity of a discrete state property. The associated method is <code>getDiscrete-State-Specification</code>	<code>getDiscreteState-SpecificationImpl</code>	No <code>DiscreteState</code> properties	N/A

## More About

- “Customize System Objects for Simulink”

## Share Data with Other Blocks

### In this section...

“Data Sharing with the MATLAB System Block” on page 42-34

“Choose How to Store Shared Data” on page 42-35

“How to Use Data Store Memory Blocks for the MATLAB System Block” on page 42-36

“How to Set Up Simulink.Signal Objects” on page 42-38

“Using Data Store Diagnostics to Detect Memory Access Issues” on page 42-41

“Limitations of Using Shared Data in MATLAB System Blocks” on page 42-41

“Use Shared Data with P-Coded System Objects” on page 42-41

Share data between MATLAB System and other blocks using the `global` keyword and the Data Store Memory block or `Simulink.Signal` object. You might need to use global data with a MATLAB System block if:

- You have an existing model that uses a large amount of global data, you are adding a MATLAB System block to this model, and you want to avoid cluttering your model with additional inputs and outputs.
- You want to scope the visibility of data to parts of the model.

### Data Sharing with the MATLAB System Block

In Simulink, you store global data using data store memory. You implement data store memory using either Data Store Memory blocks or `Simulink.Signal` objects. How you store global data depends on the number and scope of your global variables.

#### Scoping Rules for Shared Data in MATLAB System Blocks

The MATLAB System block uses these scoping rules:

- If you use the same name for both Data Store Memory block and `Simulink.Signal` object, Data Store Memory block scopes the data to the model.
- A global variable resolves hierarchically to the closest Data Store Memory block with the same name in the model. The same global variable appearing in two different MATLAB System blocks might resolve to different Data Store Memory blocks depending on the hierarchy of the model. You can use this ability to scope the visibility of data to a subsystem.



## Using Shared Data in MATLAB System Blocks

MATLAB System blocks support data store memory for:

- MATLAB structures (buses)
- Enumerated data types

### How to Use Data Sharing with the MATLAB System Block

To use shared data in your MATLAB System block:

- 1 Declare a global variable in the System object that you associate with the MATLAB System block.

You can use the `global` keyword in these methods of the System object:

- `stepImpl`
  - `outputImpl`
  - `updateImpl`
- 2 Add a Data Store Memory block or `Simulink.Signal` object that has the same name as the global variable in the System object.

To share data between referenced models using the `Simulink.Signal` object, define the `Simulink.Signal` object in the base workspace and use the same global variable name as in the MATLAB System block.

## Choose How to Store Shared Data

You can use Data Store Memory blocks or `Simulink.Signal` objects to store shared data.

Type of Data	Global Data Storage Method	Related Links
A small number of global variables in a single model that does not use model reference.	Data Store Memory blocks.  <b>Note:</b> Using Data Store Memory blocks scopes the data to the model.	“How to Use Data Store Memory Blocks for the MATLAB System Block” on page 42-36
A large number of global variables in a single model	<code>Simulink.Signal</code> objects defined in the	“How to Set Up Simulink.Signal Objects” on page 42-38

Type of Data	Global Data Storage Method	Related Links
that does not use model reference.	model workspace. <b>Simulink.Signal</b> objects offer these advantages: <ul style="list-style-type: none"> <li>• You do not have to add numerous Data Store Memory blocks to your model.</li> <li>• You can load the <b>Simulink.Signal</b> objects in from a MAT-file.</li> </ul>	
Data shared between multiple models (including referenced models).	<b>Simulink.Signal</b> objects defined in the base workspace  <b>Note:</b> If you use Data Store Memory blocks as well as <b>Simulink.Signal</b> , note that using Data Store Memory blocks scopes the data to the model.	“How to Set Up <b>Simulink.Signal</b> Objects” on page 42-38

## How to Use Data Store Memory Blocks for the MATLAB System Block

- 1 Declare a global keyword in the System object methods that support globals. For example:
 

```
global A;
```
- 2 Add a MATLAB System block to your model.
- 3 Double-click the MATLAB System block and associate the System object.
- 4 Add a Data Store Memory block to your model and set:
  - a **Data store name** to match the name of the global variable in your MATLAB System block code.
  - b **Data type** to an explicit data type.

The data type cannot be `auto`.

- c** **Signal type.**
- d** **Initial value.**

The initial value of the Data Store Memory block cannot be unspecified.

### Use Data Store Memory with the MATLAB System Block

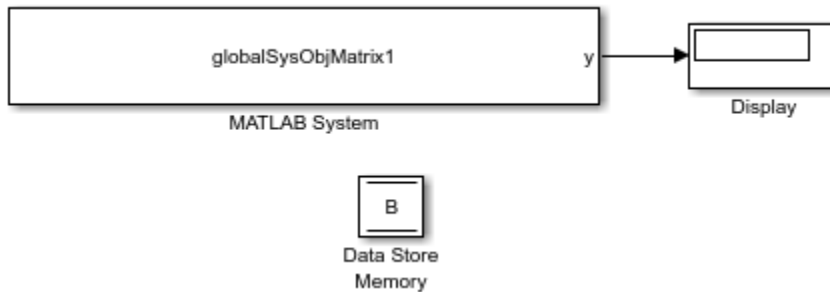

This model demonstrates how a MATLAB System block uses the global data stored in Data Store Memory block B. The MATLAB System block is associated with the `globalSysObjMatrix1` System object. To see the completed model, open the `ex_globalsys_objmatrix1` model.

- 1** Drag these blocks into a new model:
  - MATLAB System
  - Data Store Memory
  - Display
- 2** Create a System object to associate with the MATLAB System block. To start, from the MATLAB System block, create a Basic System object template file.
- 3** In MATLAB Editor, create a System object with code like the following. Save the System object as `globalSysObjMatrix1.m`. The System object modifies B each time it executes.

```
classdef globalSysObjMatrix1 < matlab.System
    % Global/DSM support scalar example

    methods(Access = protected)
        function setupImpl(obj)
```

```

        % Perform one-time calculations, such as computing constants
    end

    function y = stepImpl(obj)
        global B;
        B(:,1)= B(:,1)+100;
        y = B;
    end
end
end
end

```

- 4 Double-click the MATLAB System block and associate the `globalSysObjMatrix1` System object with the block.
- 5 In the model, double-click the Data Store Memory block `B`.
- 6 In the Signal Attributes tab, enter an initial value, for example:  
`[74 75 5 1;22 23 24 32;33 44 55 22]`
- 7 Simulate the model.

The MATLAB System block reads the initial value of global data stored in `B` and updates the value of `B` each time it executes. This model executes for five time steps.

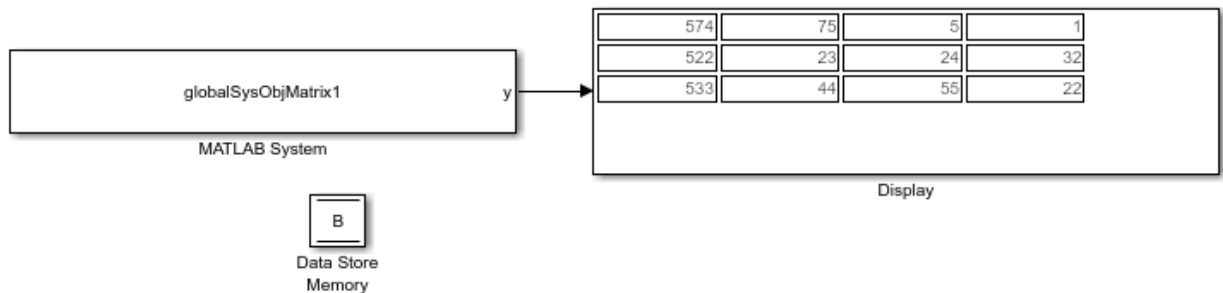

- 8 Save and close your model.

## How to Set Up Simulink.Signal Objects

Create a `Simulink.Signal` object in the model workspace.

---

**Tip:** Create a `Simulink.Signal` object in the base workspace to use the global data with multiple models.

---

- 1 In the Model Explorer, navigate to *model\_name* > **Model Workspace** in the **Model Hierarchy** pane.

Select **Add > Simulink Signal**.

- 2 Ensure that these settings apply to the `Simulink.Signal` object:

- a Set **Data type** to an explicit data type.

The data type cannot be `auto`.

- b Set **Dimensions** to be fully specified.

The signal dimensions cannot be `-1` or `inherited`.

- c Set the **Complexity**.

- d Specify an **Initial value**.

The initial value of the signal cannot be unspecified.

- e Set **Name** to the name of the global variable.

### Use a `Simulink.Signal` Object with a MATLAB System Block



This simple model demonstrates how a MATLAB System block uses a `Simulink.Signal` with signal `B`. The MATLAB System block is associated with the `globalSysObjScalar` System object. To see the completed model, open the `ex_globalsys_simulink_signal_share` model.

- 1 Drag these blocks into a new model:
  - MATLAB System
  - Display
- 2 Create a System object to associate with the MATLAB System block. To start, from the MATLAB System block, create a Basic System object template file.
- 3 In MATLAB Editor, create a System object. Save the System object as `globalSysObjScalar.m`. The System object modifies `B` each time it executes.

```

classdef globalSysObjScalar < matlab.System
    % Global/DSM support scalar example

    methods(Access = protected)
        function setupImpl(obj)
            % Perform one-time calculations, such as computing constants
            end

        function y = stepImpl(obj)
            global B;
            B= B+100;
            y = B;
            end
        end
    end
end

```

- 4 Double-click the MATLAB System block and associate the `globalSysObjScalar` System object with the block.
- 5 From the model menu, select **View > Model Explorer**.
- 6 In the left pane of the Model Explorer, select the model workspace for this model.

The **Contents** pane displays the data in the model workspace.

- 7 In the Model Explorer, in the **Model Hierarchy** pane, navigate to *model\_name* > **Model Workspace**. In the **Contents** pane, set **Name** to **B**.
- 8 Navigate back to *model\_name* > **Model Workspace**.
  - Select **Add > Simulink Signal**.
  - Make these settings for the `Simulink.Signal` object:

Attribute	Value
Data type	double
Complexity	real
Dimensions	1
Initial value	25

- 9 Simulate the model.

The MATLAB System block reads the initial value of global data stored in **B** and updates the value of **B** each time it executes. The model runs for five time steps.

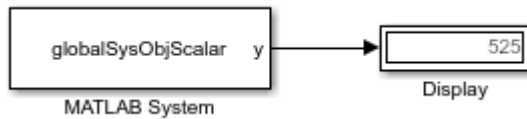

10 Save and close your model.

## Using Data Store Diagnostics to Detect Memory Access Issues

You can configure your model to provide run-time and compile-time diagnostics to avoid problems with data stores. Diagnostics are available in the Configuration Parameters dialog box and the Parameters dialog box for the Data Store Memory block. These diagnostics are available for Data Store Memory blocks only, not for `Simulink.Signal` objects. For more information on using data store diagnostics, see “Data Store Diagnostics” on page 60-3.

## Limitations of Using Shared Data in MATLAB System Blocks

The MATLAB System block does not support data store memory for variable-sized data

## Use Shared Data with P-Coded System Objects

If the System object is P-code, you must implement the `getGlobalNamesImpl` method to provide the global variable names you use in the System object. For example:

```

classdef GlobalSysObjMatrix < matlab.System
    % Matrix DSM support: Increment first row by 1 at each time step
    methods (Access = protected)
        function y = stepImpl(obj)
            global B;
            B(1,:) = B(1,:)+1;
            y = B;
        end

        function globalNames = getGlobalNamesImpl(~)
            globalNames = {'B'};
        end
    end
end
end
end
  
```

### **See Also**

Data Store Memory | MATLAB System | Simulink.Signal

### **More About**

- “Determine Where to Store Variables and Objects for Simulink Models” on page 57-85
- “Local and Global Data Stores” on page 60-3



## Troubleshoot System Objects in Simulink

### In this section...

“Class Not Found” on page 42-43

“Error Invoking Object Method” on page 42-43

“Performance” on page 42-44

### Class Not Found

The MATLAB System block **System object name** parameter requires that you enter the full path to the System object class. In addition:

- Check that the System object class is on your MATLAB path.
- Check capitalization to make sure it matches.
- Check that the class name is a supported System object.
- Do not include the file extension.

### Error Invoking Object Method

The MATLAB System block supports only System objects written in the MATLAB language. If the software can identify an alternative block, it suggests that block in the error message, for example:

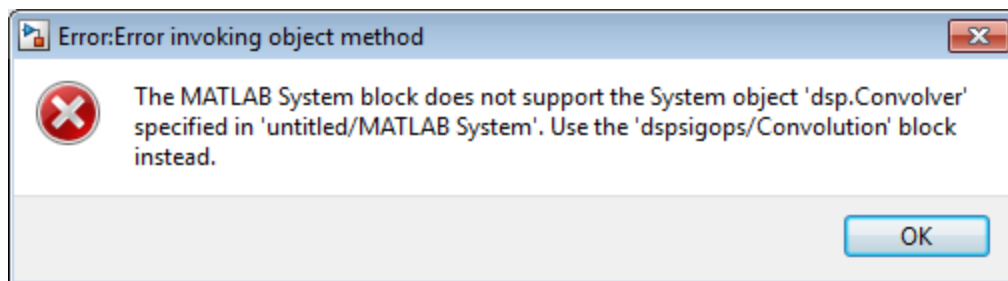

This message indicates that there is an existing dedicated and optimized block that you should use.

## Performance

For fastest performance, set the block **Simulate using** parameter to **Code generation**. This setting allows the MATLAB System block to run as fast as it can. The parameter is set to this value by default.

This setting causes a slower startup time, as the software generates C code and creates a MEX-file from it. However, after code generation, later simulations have better performance. When the block uses generated code to simulate, performance is typically better than simulation without generated code.

In some cases, the implementation of your System object does not allow you to generate code, which requires you to set **Simulate using** to **Interpreted execution**. For example, your System object can require MATLAB functions beyond the subset supported for code generation. In this case, use propagation methods to specify the block input and output port information. The MATLAB System block then propagates this signal attribution information.

## More About

- “Add and Implement Propagation Methods” on page 42-31

# Design Considerations for C/C++ Code Generation

---

- “When to Generate Code from MATLAB Algorithms” on page 43-2
- “Which Code Generation Feature to Use” on page 43-4
- “Prerequisites for C/C++ Code Generation from MATLAB” on page 43-6
- “MATLAB Code Design Considerations for Code Generation” on page 43-7
- “Differences Between Generated Code and MATLAB Code” on page 43-9
- “MATLAB Language Features Supported for C/C++ Code Generation” on page 43-14

## When to Generate Code from MATLAB Algorithms

Generating code from MATLAB algorithms for desktop and embedded systems allows you to perform your software design, implementation, and testing completely within the MATLAB workspace. You can:

- Verify that your algorithms are suitable for code generation
- Generate efficient, readable, and compact C/C++ code automatically, which eliminates the need to manually translate your MATLAB algorithms and minimizes the risk of introducing errors in the code.
- Modify your design in MATLAB code to take into account the specific requirements of desktop and embedded applications, such as data type management, memory use, and speed.
- Test the generated code and easily verify that your modified algorithms are functionally equivalent to your original MATLAB algorithms.
- Generate MEX functions to:
  - Accelerate MATLAB algorithms in certain applications.
  - Speed up fixed-point MATLAB code.
- Generate hardware description language (HDL) from MATLAB code.

## When Not to Generate Code from MATLAB Algorithms

Do not generate code from MATLAB algorithms for the following applications. Use the recommended MathWorks product instead.

To:	Use:
Deploy an application that uses handle graphics	MATLAB Compiler™
Use Java	MATLAB Compiler SDK™
Use toolbox functions that do not support code generation	Toolbox functions that you rewrite for desktop and embedded applications
Deploy MATLAB based GUI applications on a supported MATLAB host	MATLAB Compiler
Deploy web-based or Windows applications	MATLAB Compiler SDK

<b>To:</b>	<b>Use:</b>
Interface C code with MATLAB	MATLAB <code>mex</code> function

## Which Code Generation Feature to Use

To...	Use...	Required Product	To Explore Further...
Generate MEX functions for verifying generated code	<code>codegen</code> function	MATLAB Coder	Try this in “MEX Function Generation at the Command Line” (MATLAB Coder).
Produce readable, efficient, and compact code from MATLAB algorithms for deployment to desktop and embedded systems.	MATLAB Coder app	MATLAB Coder	Try this in “C Code Generation Using the MATLAB Coder App” (MATLAB Coder).
	<code>codegen</code> function	MATLAB Coder	Try this in “C Code Generation at the Command Line” (MATLAB Coder).
Generate MEX functions to accelerate MATLAB algorithms	MATLAB Coder app	MATLAB Coder	See “Accelerate MATLAB Algorithms” (MATLAB Coder).
	<code>codegen</code> function	MATLAB Coder	
Integrate MATLAB code into Simulink	MATLAB Function block	Simulink	Try this in “Track Object Using MATLAB Code” on page 40-167.
Speed up fixed-point MATLAB code	<code>fiaccel</code> function	Fixed-Point Designer	Learn more in “Code Acceleration and Code Generation from MATLAB” (Fixed-Point Designer).
Integrate custom C code into MATLAB and generate efficient, readable code	<code>codegen</code> function	MATLAB Coder	Learn more in “Specify External File Locations” (MATLAB Coder).
Integrate custom C code into code generated from MATLAB	<code>coder.ceval</code> function	MATLAB Coder	Learn more in <code>coder.ceval</code> .
Generate HDL from MATLAB code	MATLAB Function block	Simulink and HDL Coder	Learn more at <a href="http://www.mathworks.com/">www.mathworks.com/</a>

To...	Use...	Required Product	To Explore Further...
			products/ slhdlcoder.

## Prerequisites for C/C++ Code Generation from MATLAB

To generate C/C++ or MEX code from MATLAB algorithms, you must install the following software:

- MATLAB Coder product
- C/C++ compiler



## MATLAB Code Design Considerations for Code Generation

When writing MATLAB code that you want to convert into efficient, standalone C/C++ code, you must consider the following:

- Data types

C and C++ use static typing. To determine the types of your variables before use, MATLAB Coder requires a complete assignment to each variable.

- Array sizing

Variable-size arrays and matrices are supported for code generation. You can define inputs, outputs, and local variables in MATLAB functions to represent data that varies in size at run time.

- Memory

You can choose whether the generated code uses static or dynamic memory allocation.

With dynamic memory allocation, you potentially use less memory at the expense of time to manage the memory. With static memory, you get better speed, but with higher memory usage. Most MATLAB code takes advantage of the dynamic sizing features in MATLAB, therefore dynamic memory allocation typically enables you to generate code from existing MATLAB code without modifying it much. Dynamic memory allocation also allows some programs to compile even when upper bounds cannot be found.

Static allocation reduces the memory footprint of the generated code, and therefore is suitable for applications where there is a limited amount of available memory, such as embedded applications.

- Speed

Because embedded applications must run in real time, the code must be fast enough to meet the required clock rate.

To improve the speed of the generated code:

- Choose a suitable C/C++ compiler. Do not use the default compiler that MathWorks supplies with MATLAB for Windows 64-bit platforms.
- Consider disabling run-time checks.

By default, for safety, the code generated for your MATLAB code contains memory integrity checks and responsiveness checks. Generally, these checks result in more generated code and slower simulation. Disabling run-time checks usually results in streamlined generated code and faster simulation. Disable these checks only if you have verified that array bounds and dimension checking is unnecessary.

### See Also

- “Data Definition Basics”
- “Code Generation for Variable-Size Arrays” on page 48-2

## Differences Between Generated Code and MATLAB Code

To convert MATLAB code to efficient C/C++ code, the code generator introduces optimizations that intentionally cause the generated code to behave differently, and sometimes produce different results, than the original source code.

Here are some of the differences:

- “Character Size” on page 43-9
- “Order of Evaluation in Expressions” on page 43-9
- “Termination Behavior” on page 43-11
- “Size of Variable-Size N-D Arrays” on page 43-11
- “Size of Empty Arrays” on page 43-11
- “Size of Empty Array That Results from Deleting Elements of an Array” on page 43-11
- “Floating-Point Numerical Results” on page 43-12
- “NaN and Infinity Patterns” on page 43-13
- “Code Generation Target” on page 43-13
- “MATLAB Class Initial Values” on page 43-13
- “Variable-Size Data” on page 43-13
- “Complex Numbers” on page 43-13

### Character Size

MATLAB supports 16-bit characters, but the generated code represents characters in 8 bits, the standard size for most embedded languages like C. See “Code Generation for Character Arrays” on page 47-8.

### Order of Evaluation in Expressions

Generated code does not enforce order of evaluation in expressions. For most expressions, order of evaluation is not significant. However, for expressions with side effects, the generated code may produce the side effects in different order from the original MATLAB code. Expressions that produce side effects include those that:

- Modify persistent or global variables
- Display data to the screen
- Write data to files
- Modify the properties of handle class objects

In addition, the generated code does not enforce order of evaluation of logical operators that do not short circuit.

For more predictable results, it is good coding practice to split expressions that depend on the order of evaluation into multiple statements.

- Rewrite

```
A = f1() + f2();
```

as

```
A = f1();  
A = A + f2();
```

so that the generated code calls `f1` before `f2`.

- Assign the outputs of a multi-output function call to variables that do not depend on one another. For example, rewrite

```
[y, y.f, y.g] = foo;
```

as

```
[y, a, b] = foo;  
y.f = a;  
y.g = b;
```

- When you access the contents of multiple cells of a cell array, assign the results to variables that do not depend on one another. For example, rewrite

```
[y, y.f, y.g] = z{:};
```

as

```
[y, a, b] = z{:};  
y.f = a;  
y.g = b;
```

## Termination Behavior

Generated code does not match the termination behavior of MATLAB source code. For example, if infinite loops do not have side effects, optimizations remove them from generated code. As a result, the generated code can possibly terminate even though the corresponding MATLAB code does not.

## Size of Variable-Size N-D Arrays

For variable-size N-D arrays, the `size` function might return a different result in generated code than in MATLAB source code. The `size` function sometimes returns trailing ones (singleton dimensions) in generated code, but always drops trailing ones in MATLAB. For example, for an N-D array `X` with dimensions `[4 2 1 1]`, `size(X)` might return `[4 2 1 1]` in generated code, but always returns `[4 2]` in MATLAB. See “Incompatibility with MATLAB in Determining Size of Variable-Size N-D Arrays” on page 48-19.

## Size of Empty Arrays

The size of an empty array in generated code might be different from its size in MATLAB source code. See “Incompatibility with MATLAB in Determining Size of Empty Arrays” on page 48-20.

## Size of Empty Array That Results from Deleting Elements of an Array

Deleting all elements of an array results in an empty array. The size of this empty array in generated code might differ from its size in MATLAB source code.

Case	Example Code	Size of Empty Array in MATLAB	Size of Empty Array in Generated Code
Delete all elements of an m-by-n array by using the colon operator (:).	<pre>coder.varsize('X',[4,4],[1,1]); X = zeros(2); X(:) = [];</pre>	0-by-0	1-by-0
Delete all elements of a row vector by using the colon operator (:).	<pre>coder.varsize('X',[1,4],[0,1]); X = zeros(1,4); X(:) = [];</pre>	0-by-0	1-by-0

Case	Example Code	Size of Empty Array in MATLAB	Size of Empty Array in Generated Code
Delete all elements of a column vector by using the colon operator (:).	<pre>coder.varsize('X',[4,1],[1,0]); X = zeros(4,1); X(:) = [];</pre>	0-by-0	0-by-1
Delete all elements of a column vector by deleting one element at a time.	<pre>coder.varsize('X',[4,1],[1,0]); X = zeros(4,1); for i = 1:4     X(i) = []; end</pre>	1-by-0	0-by-1

## Floating-Point Numerical Results

The generated code might not produce the same floating-point numerical results as MATLAB in the following situations:

### When computer hardware uses extended precision registers

Results vary depending on how the C/C++ compiler allocates extended precision floating-point registers. Computation results might not match MATLAB calculations because of different compiler optimization settings or different code surrounding the floating-point calculations.

### For certain advanced library functions

The generated code might use different algorithms to implement certain advanced library functions, such as `fft`, `svd`, `eig`, `mldivide`, and `mrdivide`.

For example, the generated code uses a simpler algorithm to implement `svd` to accommodate a smaller footprint. Results might also vary according to matrix properties. For example, MATLAB might detect symmetric or Hermitian matrices at run time and switch to specialized algorithms that perform computations faster than implementations in the generated code.

### For implementation of BLAS library functions

For implementations of BLAS library functions, generated C/C++ code uses reference implementations of BLAS functions. These reference implementations might produce different results from platform-specific BLAS implementations in MATLAB.

## NaN and Infinity Patterns

The generated code might not produce exactly the same pattern of NaN and inf values as MATLAB code when these values are mathematically meaningless. For example, if MATLAB output contains a NaN, output from the generated code should also contain a NaN, but not necessarily in the same place.

## Code Generation Target

The `coder.target` function returns different values in MATLAB than in the generated code. The intent is to help you determine whether your function is executing in MATLAB or has been compiled for a simulation or code generation target. See `coder.target`.

## MATLAB Class Initial Values

Before code generation, at class loading time, MATLAB computes class initial values. The code generator uses the value that MATLAB computes. It does not recompute the initial value. If the initialization uses a function call to compute the initial value, the code generator does not execute this function. If the function modifies a global state, for example, a persistent variable, code generator might provide a different initial value than MATLAB. For more information, see “Defining Class Properties for Code Generation” on page 51-4.

## Variable-Size Data

See “Incompatibilities with MATLAB in Variable-Size Support for Code Generation” on page 48-17.

## Complex Numbers

See “Code Generation for Complex Data” on page 47-4.

# MATLAB Language Features Supported for C/C++ Code Generation

## MATLAB Features That Code Generation Supports

Code generation from MATLAB code supports the following language features:

- n-dimensional arrays (see “Array Size Restrictions for Code Generation” on page 47-9)
- matrix operations, including deletion of rows and columns
- variable-sized data (see “Code Generation for Variable-Size Arrays” on page 48-2)
- subscripting (see “Incompatibility with MATLAB in Matrix Indexing Operations for Code Generation” on page 48-23)
- complex numbers (see “Code Generation for Complex Data” on page 47-4)
- numeric classes (see “Supported Variable Types” on page 46-16)
- double-precision, single-precision, and integer math
- fixed-point arithmetic
- program control statements `if`, `switch`, `for`, `while`, and `break`
- arithmetic, relational, and logical operators
- local functions
- persistent variables
- global variables
- structures (see “Structure Definition for Code Generation” on page 49-2)
- cell arrays (see “Cell Arrays”)
- characters (see “Code Generation for Character Arrays” on page 47-8)
- function handles (see “Function Handle Limitations for Code Generation” on page 52-2)
- anonymous functions (see “Code Generation for Anonymous Functions” on page 53-5)
- recursive functions
- nested functions
- variable length input and output argument lists



- subset of MATLAB toolbox functions (see “Functions and Objects Supported for C/C++ Code Generation — Alphabetical List” on page 44-2)
- subset of functions and System objects in several toolboxes (see “Functions and Objects Supported for C/C++ Code Generation — Category List” on page 44-67)
- MATLAB classes (see “MATLAB Classes Definition for Code Generation” on page 51-2)
- function calls (see “Resolution of Function Calls for Code Generation” on page 54-2)

## **MATLAB Language Features That Code Generation Does Not Support**

Code generation from MATLAB does not support the following frequently used MATLAB features:

- implicit expansion

Code generation does not support implicit expansion of arrays with compatible sizes during execution of element-wise operations or functions. If your MATLAB code relies on implicit expansion, code generation results in a size-mismatch error. For fixed-size arrays, the error occurs at compile time. For variable-size arrays, the error occurs at run time. For more information about implicit expansion, see “Compatible Array Sizes for Basic Operations” (MATLAB).

- string arrays
- categorical arrays
- date and time arrays
- Java
- Map containers
- sparse matrices
- tables
- time series objects
- try/catch statements

This list is not exhaustive. To see if a feature is supported for code generation, see “MATLAB Features That Code Generation Supports” on page 43-14.



# Functions, Classes, and System Objects Supported for Code Generation

---

- “Functions and Objects Supported for C/C++ Code Generation — Alphabetical List” on page 44-2
- “Functions and Objects Supported for C/C++ Code Generation — Category List” on page 44-67

## Functions and Objects Supported for C/C++ Code Generation — Alphabetical List

You can generate efficient C/C++ code for a subset of MATLAB built-in functions and toolbox functions, classes, and System objects that you call from MATLAB code. These function, classes, and System objects appear in alphabetical order in the following table.

To find supported functions, classes, and System objects by MATLAB category or toolbox, see “Functions and Objects Supported for C/C++ Code Generation — Category List” on page 44-67.

---

**Note:** For more information on code generation for fixed-point algorithms, refer to “Code Acceleration and Code Generation from MATLAB” (Fixed-Point Designer).

---

In the following table, an asterisk (\*) indicates that the reference page has usage notes and limitations for C/C++ code generation.

Name	Product
abs	MATLAB
abs	Fixed-Point Designer
accumneg	Fixed-Point Designer
accumpos	Fixed-Point Designer
acos*	MATLAB
acosd	MATLAB
acosh*	MATLAB
acot	MATLAB
acotd	MATLAB
acoth	MATLAB
acsc	MATLAB
acscd	MATLAB
acsch	MATLAB
adaptthresh*	Image Processing Toolbox™

Name	Product
add*	Fixed-Point Designer
affine2d*	Image Processing Toolbox
aicctest*	Phased Array System Toolbox™
airy*	MATLAB
albersheim*	Phased Array System Toolbox
alignsignals	Signal Processing Toolbox™
all*	MATLAB
all	Fixed-Point Designer
ambgfun*	Phased Array System Toolbox
and	MATLAB
angdiff	Robotics System Toolbox™
angle	MATLAB
any*	MATLAB
any	Fixed-Point Designer
aperture2gain*	Phased Array System Toolbox
appcoef*	Wavelet Toolbox™
appcoef2*	Wavelet Toolbox
asec	MATLAB
asecd	MATLAB
asech	MATLAB
asin*	MATLAB
asind	MATLAB
asinh	MATLAB
assert*	MATLAB
assignDetectionsToTracks	Computer Vision System Toolbox
atan	MATLAB
atan2	MATLAB

<b>Name</b>	<b>Product</b>
atan2	Fixed-Point Designer
atan2d	MATLAB
atand	MATLAB
atanh*	MATLAB
audioDeviceReader*	Audio System Toolbox™
audioDeviceWriter*	Audio System Toolbox
audioDeviceWriter*	DSP System Toolbox
audioOscillator*	Audio System Toolbox
audioPluginInterface	Audio System Toolbox
audioPluginParameter	Audio System Toolbox
audioPlugin	Audio System Toolbox
audioPluginSource	Audio System Toolbox
axang2quat	Robotics System Toolbox
axang2rotm	Robotics System Toolbox
axang2tform	Robotics System Toolbox
az2broadside*	Phased Array System Toolbox
azel2phitheta*	Phased Array System Toolbox
azel2phithetapat*	Phased Array System Toolbox
azel2uv*	Phased Array System Toolbox
azel2uvpat*	Phased Array System Toolbox
azelaxes*	Phased Array System Toolbox
bandwidth	MATLAB
barthannwin*	Signal Processing Toolbox
bartlett*	Signal Processing Toolbox
bboxOverlapRatio*	Computer Vision System Toolbox
bbox2points	Computer Vision System Toolbox
bchgenpoly*	Communications System Toolbox
beat2range*	Phased Array System Toolbox

Name	Product
besselap*	Signal Processing Toolbox
besseli*	MATLAB
besselj*	MATLAB
beta	MATLAB
betacdf	Statistics and Machine Learning Toolbox™
betafit	Statistics and Machine Learning Toolbox
betainc*	MATLAB
betaincinv*	MATLAB
betainv	Statistics and Machine Learning Toolbox
betalike	Statistics and Machine Learning Toolbox
betaln	MATLAB
betapdf	Statistics and Machine Learning Toolbox
betarnd*	Statistics and Machine Learning Toolbox
betastat	Statistics and Machine Learning Toolbox
bi2de	Communications System Toolbox
billingsleyicm*	Phased Array System Toolbox
bin2dec*	MATLAB
bin2gray	Communications System Toolbox
binocdf	Statistics and Machine Learning Toolbox
binoinv	Statistics and Machine Learning Toolbox

<b>Name</b>	<b>Product</b>
binopdf	Statistics and Machine Learning Toolbox
binornd*	Statistics and Machine Learning Toolbox
binostat	Statistics and Machine Learning Toolbox
bitand	MATLAB
bitand*	Fixed-Point Designer
bitandreduce	Fixed-Point Designer
bitcmp	MATLAB
bitcmp	Fixed-Point Designer
bitconcat	Fixed-Point Designer
bitget	MATLAB
bitget	Fixed-Point Designer
bitor	MATLAB
bitor*	Fixed-Point Designer
bitorreduce	Fixed-Point Designer
bitreplicate	Fixed-Point Designer
bitrevorder	Signal Processing Toolbox
bitrol	Fixed-Point Designer
bitror	Fixed-Point Designer
bitset	MATLAB
bitset	Fixed-Point Designer
bitshift	MATLAB
bitshift	Fixed-Point Designer
bitsliceget	Fixed-Point Designer
bitsll*	Fixed-Point Designer
bitsra*	Fixed-Point Designer



Name	Product
bitsrl*	Fixed-Point Designer
bitxor*	MATLAB
bitxor	Fixed-Point Designer
bitxorreduce	Fixed-Point Designer
blackman*	Signal Processing Toolbox
blackmanharris*	Signal Processing Toolbox
blanks	MATLAB
blkdiag	MATLAB
bohmanwin*	Signal Processing Toolbox
boundarymask*	Image Processing Toolbox
break	MATLAB
BRISKPoints*	Computer Vision System Toolbox
broadside2az*	Phased Array System Toolbox
bsxfun*	MATLAB
buttap*	Signal Processing Toolbox
butter*	Signal Processing Toolbox
buttord*	Signal Processing Toolbox
bw2range*	Phased Array System Toolbox
bwareaopen*	Image Processing Toolbox
bwboundaries*	Image Processing Toolbox
bwconncomp*	Image Processing Toolbox
bwdist*	Image Processing Toolbox
bweuler*	Image Processing Toolbox
bwlabel*	Image Processing Toolbox
bwlookup*	Image Processing Toolbox
bwmorph*	Image Processing Toolbox
bwpack*	Image Processing Toolbox

<b>Name</b>	<b>Product</b>
bwperim*	Image Processing Toolbox
bwselect*	Image Processing Toolbox
bwtraceboundary*	Image Processing Toolbox
bwunpack*	Image Processing Toolbox
cameas	Automated Driving System Toolbox™
cameasjac	Automated Driving System Toolbox
cameraMatrix*	Computer Vision System Toolbox
cameraParameters*	Computer Vision System Toolbox
cameraPose*	Computer Vision System Toolbox
cameraPoseToExtrinsics	Computer Vision System Toolbox
cart2hom	Robotics System Toolbox
cart2pol	MATLAB
cart2sph	MATLAB
cart2sphvec*	Phased Array System Toolbox
cast	MATLAB
cat*	MATLAB
cbfweights*	Phased Array System Toolbox
cconv	Signal Processing Toolbox
cdf	Statistics and Machine Learning Toolbox
ceil	MATLAB
ceil	Fixed-Point Designer
cell*	MATLAB
cfirpm*	Signal Processing Toolbox
char*	MATLAB
cheb1ap*	Signal Processing Toolbox
cheb1ord*	Signal Processing Toolbox

Name	Product
cheb2ap*	Signal Processing Toolbox
cheb2ord*	Signal Processing Toolbox
chebwin*	Signal Processing Toolbox
cheby1*	Signal Processing Toolbox
cheby2*	Signal Processing Toolbox
chi2cdf	Statistics and Machine Learning Toolbox
chi2inv	Statistics and Machine Learning Toolbox
chi2pdf	Statistics and Machine Learning Toolbox
chi2rnd*	Statistics and Machine Learning Toolbox
chi2stat	Statistics and Machine Learning Toolbox
chol	MATLAB
cholupdate	MATLAB
circpol2pol*	Phased Array System Toolbox
circshift	MATLAB
c12tf*	DSP System Toolbox
class	MATLAB
ClassificationECOC* or CompactClassificationECOC*	Statistics and Machine Learning Toolbox
ClassificationEnsemble*, ClassificationBaggedEnsemble*, or CompactClassificationEnsemble*	Statistics and Machine Learning Toolbox
ClassificationLinear*	Statistics and Machine Learning Toolbox
ClassificationSVM* or CompactClassificationSVM*	Statistics and Machine Learning Toolbox

Name	Product
ClassificationTree* or CompactClassificationTree*	Statistics and Machine Learning Toolbox
colon*	MATLAB
comm.ACPR*	Communications System Toolbox
comm.AGC*	Communications System Toolbox
comm.AlgebraicDeinterleaver*	Communications System Toolbox
comm.AlgebraicInterleaver*	Communications System Toolbox
comm.APPDecoder*	Communications System Toolbox
comm.AWGNChannel*	Communications System Toolbox
comm.BarkerCode*	Communications System Toolbox
comm.BasebandFileReader*	Communications System Toolbox
comm.BasebandFileWriter*	Communications System Toolbox
comm.BCHDecoder*	Communications System Toolbox
comm.BCHEncoder*	Communications System Toolbox
comm.BinarySymmetricChannel*	Communications System Toolbox
comm.BlockDeinterleaver*	Communications System Toolbox
comm.BlockInterleaver*	Communications System Toolbox
comm.BPSKDemodulator*	Communications System Toolbox
comm.BPSKModulator*	Communications System Toolbox
comm.CarrierSynchronizer*	Communications System Toolbox
comm.CCDF*	Communications System Toolbox
comm.CoarseFrequencyCompensator*	Communications System Toolbox
comm.ConstellationDiagram*	Communications System Toolbox
comm.ConvolutionalDeinterleaver*	Communications System Toolbox
comm.ConvolutionalEncoder*	Communications System Toolbox
comm.ConvolutionalInterleaver*	Communications System Toolbox
comm.CPFSKDemodulator*	Communications System Toolbox
comm.CPFSKModulator*	Communications System Toolbox

Name	Product
comm.CPMCarrierPhaseSynchronizer*	Communications System Toolbox
comm.CPMDemodulator*	Communications System Toolbox
comm.CPMModulator*	Communications System Toolbox
comm.CRCDetector*	Communications System Toolbox
comm.CRCGenerator*	Communications System Toolbox
comm.DBPSKDemodulator*	Communications System Toolbox
comm.DBPSKModulator*	Communications System Toolbox
comm.Descrambler*	Communications System Toolbox
comm.DifferentialDecoder*	Communications System Toolbox
comm.DifferentialEncoder*	Communications System Toolbox
comm.DiscreteTimeVCO*	Communications System Toolbox
comm.DPSKDemodulator*	Communications System Toolbox
comm.DPSKModulator*	Communications System Toolbox
comm.DQPSKDemodulator*	Communications System Toolbox
comm.DQPSKModulator*	Communications System Toolbox
comm.ErrorRate*	Communications System Toolbox
comm.EVM*	Communications System Toolbox
comm.EyeDiagram*	Communications System Toolbox
comm.FMBroadcastDemodulator*	Communications System Toolbox
comm.FMBroadcastModulator*	Communications System Toolbox
comm.FMDemodulator*	Communications System Toolbox
comm.FMModulator*	Communications System Toolbox
comm.FSKDemodulator*	Communications System Toolbox
comm.FSKModulator*	Communications System Toolbox
comm.GeneralQAMDemodulator*	Communications System Toolbox
comm.GeneralQAMModulator*	Communications System Toolbox
comm.GeneralQAMTCMDemodulator*	Communications System Toolbox
comm.GeneralQAMTCMModulator*	Communications System Toolbox

Name	Product
comm.GMSKDemodulator*	Communications System Toolbox
comm.GMSKModulator*	Communications System Toolbox
comm.GMSKTimingSynchronizer*	Communications System Toolbox
comm.GoldSequence*	Communications System Toolbox
comm.HadamardCode*	Communications System Toolbox
comm.HDLCRCDetector*	Communications System Toolbox
comm.HDLCRCGenerator*	Communications System Toolbox
comm.HDLRSDecoder*	Communications System Toolbox
comm.HDLRSEncoder*	Communications System Toolbox
comm.HelicalDeinterleaver*	Communications System Toolbox
comm.HelicalInterleaver*	Communications System Toolbox
comm.IntegrateAndDumpFilter*	Communications System Toolbox
comm.IQImbalanceCompensator*	Communications System Toolbox
comm.KasamiSequence*	Communications System Toolbox
comm.LDPCDecoder*	Communications System Toolbox
comm.LDPCEncoder*	Communications System Toolbox
comm.LTEMIMOChannel*	Communications System Toolbox
comm.MatrixDeinterleaver*	Communications System Toolbox
comm.MatrixHelicalScanDeinterleaver*	Communications System Toolbox
comm.MatrixHelicalScanInterLeaver*	Communications System Toolbox
comm.MatrixInterleaver*	Communications System Toolbox
comm.MemorylessNonlinearity*	Communications System Toolbox
comm.MER*	Communications System Toolbox
comm.MIMOChannel*	Communications System Toolbox
comm.MLSEEqualizer*	Communications System Toolbox
comm.MSKDemodulator*	Communications System Toolbox
comm.MSKModulator*	Communications System Toolbox
comm.MSKTimingSynchronizer*	Communications System Toolbox

Name	Product
comm.MultiplexedDeinterleaver*	Communications System Toolbox
comm.MultiplexedInterleaver*	Communications System Toolbox
comm.OFDMDemodulator*	Communications System Toolbox
comm.OFDModulator*	Communications System Toolbox
comm.OSTBCCombiner*	Communications System Toolbox
comm.OSTBCEncoder*	Communications System Toolbox
comm.OQPSKDemodulator*	Communications System Toolbox
comm.OQPSKModulator*	Communications System Toolbox
comm.PAMDemodulator*	Communications System Toolbox
comm.PAMModulator*	Communications System Toolbox
comm.PhaseFrequencyOffset*	Communications System Toolbox
comm.PhaseNoise*	Communications System Toolbox
comm.PNSequence*	Communications System Toolbox
comm.PreambleDetector*	Communications System Toolbox
comm.PSKCoarseFrequencyEstimator*	Communications System Toolbox
comm.PSKDemodulator*	Communications System Toolbox
comm.PSKModulator*	Communications System Toolbox
comm.PSKTCMDemodulator*	Communications System Toolbox
comm.PSKTCMModulator*	Communications System Toolbox
comm.QAMCoarseFrequencyEstimator*	Communications System Toolbox
comm.QPSKDemodulator*	Communications System Toolbox
comm.QPSKModulator*	Communications System Toolbox
comm.RaisedCosineReceiveFilter*	Communications System Toolbox
comm.RaisedCosineTransmitFilter*	Communications System Toolbox
comm.RayleighChannel*	Communications System Toolbox
comm.RBDSWaveformGenerator*	Communications System Toolbox
comm.RectangularQAMDemodulator*	Communications System Toolbox
comm.RectangularModulator*	Communications System Toolbox

<b>Name</b>	<b>Product</b>
comm.RectangularQAMTCMDemodulator*	Communications System Toolbox
comm.RectangularQAMTCMModulator*	Communications System Toolbox
comm.RicianChannel*	Communications System Toolbox
comm.RSDecoder*	Communications System Toolbox
comm.RSEncoder*	Communications System Toolbox
comm.Scrambler*	Communications System Toolbox
comm.SphereDecoder*	Communications System Toolbox
comm.SymbolSynchronizer*	Communications System Toolbox
comm.ThermalNoise*	Communications System Toolbox
comm.TurboDecoder*	Communications System Toolbox
comm.TurboEncoder*	Communications System Toolbox
comm.ViterbiDecoder*	Communications System Toolbox
comm.WalshCode*	Communications System Toolbox
compan	MATLAB
complex	MATLAB
complex	Fixed-Point Designer
compressor*	Audio System Toolbox
computer*	MATLAB
cond	MATLAB
conj	MATLAB
conj	Fixed-Point Designer
conndef*	Image Processing Toolbox
constacc	Automated Driving System Toolbox
constaccjac	Automated Driving System Toolbox
constturn	Automated Driving System Toolbox
constturnjac	Automated Driving System Toolbox
constvel	Automated Driving System Toolbox
constveljac	Automated Driving System Toolbox



<b>Name</b>	<b>Product</b>
continue	MATLAB
conv*	MATLAB
conv*	Fixed-Point Designer
conv2	MATLAB
convenc	Communications System Toolbox
convergent	Fixed-Point Designer
convmtx	Signal Processing Toolbox
convn	MATLAB
cordicabs*	Fixed-Point Designer
cordicangle*	Fixed-Point Designer
cordicatan2*	Fixed-Point Designer
cordiccart2pol*	Fixed-Point Designer
cordicexp*	Fixed-Point Designer
cordiccos*	Fixed-Point Designer
cordicpol2cart*	Fixed-Point Designer
cordicrotate*	Fixed-Point Designer
cordicsin*	Fixed-Point Designer
cordicsincos*	Fixed-Point Designer
cordicsqrt*	Fixed-Point Designer
cornerPoints*	Computer Vision System Toolbox
corrcoef*	MATLAB
corrmtx	Signal Processing Toolbox
cos	MATLAB
cos	Fixed-Point Designer
cosd	MATLAB
cosh	MATLAB
cot	MATLAB

<b>Name</b>	<b>Product</b>
cotd*	MATLAB
coth	MATLAB
cov*	MATLAB
cplxpair	MATLAB
cross*	MATLAB
crossoverFilter*	Audio System Toolbox
csc	MATLAB
cscd*	MATLAB
csch	MATLAB
ctmeas	Automated Driving System Toolbox
ctmeasjac	Automated Driving System Toolbox
ctranspose	MATLAB
ctranspose	Fixed-Point Designer
cummin	MATLAB
cummax	MATLAB
cumprod*	MATLAB
cumsum*	MATLAB
cumtrapz	MATLAB
cvmeas	Automated Driving System Toolbox
cvmeasjac	Automated Driving System Toolbox
db2pow	Signal Processing Toolbox
dct*	Signal Processing Toolbox
ddencmp*	Wavelet Toolbox
de2bi	Communications System Toolbox
deal	MATLAB
deblank*	MATLAB
dec2bin*	MATLAB

Name	Product
dec2hex*	MATLAB
dechirp*	Phased Array System Toolbox
deconv*	MATLAB
deg2rad	MATLAB
del2	MATLAB
delayseq*	Phased Array System Toolbox
demosaic*	Image Processing Toolbox
depressionang*	Phased Array System Toolbox
designMultirateFIR*	DSP System Toolbox
designParamEQ	Audio System Toolbox
designShelvingEQ	Audio System Toolbox
designVarSlopeFilter	Audio System Toolbox
det	MATLAB
detcoef*	Wavelet Toolbox
detcoef2*	Wavelet Toolbox
detectBRISKFeatures*	Computer Vision System Toolbox
detectCheckerboardPoints*	Computer Vision System Toolbox
detectFASTFeatures*	Computer Vision System Toolbox
detectHarrisFeatures*	Computer Vision System Toolbox
detectMinEigenFeatures*	Computer Vision System Toolbox
detectMSERFeatures*	Computer Vision System Toolbox
detectSURFFeatures*	Computer Vision System Toolbox
detrend*	MATLAB
diag*	MATLAB
diag*	Fixed-Point Designer
diagbfweights*	Phased Array System Toolbox
diff*	MATLAB

<b>Name</b>	<b>Product</b>
disparity*	Computer Vision System Toolbox
divide*	Fixed-Point Designer
dop2speed*	Phased Array System Toolbox
dopsteeringvec*	Phased Array System Toolbox
doppler*	Communications System Toolbox
dot	MATLAB
double	MATLAB
double*	Fixed-Point Designer
downsample	Signal Processing Toolbox
dpskdemod	Communications System Toolbox
dpskmod	Communications System Toolbox
dpss*	Signal Processing Toolbox
dsp.AdaptiveLatticeFilter*	DSP System Toolbox
dsp.AffineProjectionFilter*	DSP System Toolbox
dsp.AllpassFilter*	DSP System Toolbox
dsp.AllpoleFilter*	DSP System Toolbox
dsp.AnalyticSignal*	DSP System Toolbox
dsp.ArrayPlot*	DSP System Toolbox
dsp.ArrayVectorAdder*	DSP System Toolbox
dsp.ArrayVectorDivider*	DSP System Toolbox
dsp.ArrayVectorMultiplier*	DSP System Toolbox
dsp.ArrayVectorSubtractor*	DSP System Toolbox
dsp.AsyncBuffer*	
dsp.AudioFileReader*	DSP System Toolbox
dsp.AudioFileWriter*	DSP System Toolbox
dsp.Autocorrelator*	DSP System Toolbox
dsp.BinaryFileReader*	DSP System Toolbox
dsp.BinaryFileWriter*	DSP System Toolbox

Name	Product
dsp.BiquadFilter*	DSP System Toolbox
dsp.BurgAREstimator*	DSP System Toolbox
dsp.BurgSpectrumEstimator*	DSP System Toolbox
dsp.CepstralToLPC*	DSP System Toolbox
dsp.Channelizer*	DSP System Toolbox
dsp.ChannelSynthesizer*	DSP System Toolbox
dsp.CICCompensationDecimator*	DSP System Toolbox
dsp.CICCompensationInterpolator*	DSP System Toolbox
dsp.CICDecimator*	DSP System Toolbox
dsp.CICInterpolator*	DSP System Toolbox
dsp.Convolver*	DSP System Toolbox
dsp.Counter*	DSP System Toolbox
dsp.Crosscorrelator*	DSP System Toolbox
dsp.CrossSpectrumEstimator*	DSP System Toolbox
dsp.CumulativeProduct *	DSP System Toolbox
dsp.CumulativeSum *	DSP System Toolbox
dsp.DCBlocker*	DSP System Toolbox
dsp.DCT*	DSP System Toolbox
dsp.Delay*	DSP System Toolbox
dsp.DelayLine*	DSP System Toolbox
dsp.Differentiator*	DSP System Toolbox
dsp.DigitalDownConverter*	DSP System Toolbox
dsp.DigitalUpConverter*	DSP System Toolbox
dsp.DigitalFilter*	DSP System Toolbox
dsp.FarrowRateConverter*	DSP System Toolbox
dsp.FastTransversalFilter*	DSP System Toolbox
dsp.FFT*	DSP System Toolbox
dsp.FilterCascade*	DSP System Toolbox

Name	Product
dsp.FilteredXLMSFilter*	DSP System Toolbox
dsp.FIRDecimator*	DSP System Toolbox
dsp.FIRFilter*	DSP System Toolbox
dsp.FIRHalfbandDecimator*	DSP System Toolbox
dsp.FIRHalfbandInterpolator*	DSP System Toolbox
dsp.FIRInterpolator*	DSP System Toolbox
dsp.FIRRateConverter*	DSP System Toolbox
dsp.FrequencyDomainAdaptiveFilter*	DSP System Toolbox
dsp.HampelFilter*	
dsp.HighpassFilter*	DSP System Toolbox
dsp.Histogram*	DSP System Toolbox
dsp.IDCT*	DSP System Toolbox
dsp.IFFT*	DSP System Toolbox
dsp.IIRFilter*	DSP System Toolbox
dsp.IIRHalfbandDecimator*	DSP System Toolbox
dsp.IIRHalfbandInterpolator*	DSP System Toolbox
dsp.Interpolator*	DSP System Toolbox
dsp.KalmanFilter*	DSP System Toolbox
dsp.LDLFactor*	DSP System Toolbox
dsp.LevinsonSolver*	DSP System Toolbox
dsp.LMSFilter*	DSP System Toolbox
dsp.LowerTriangularSolver*	DSP System Toolbox
dsp.LowpassFilter*	DSP System Toolbox
dsp.LPCToAutocorrelation*	DSP System Toolbox
dsp.LPCToCepstral*	DSP System Toolbox
dsp.LPCToLSF*	DSP System Toolbox
dsp.LPCToLSP*	DSP System Toolbox
dsp.LPCToRC*	DSP System Toolbox

Name	Product
dsp.LSFToLPC*	DSP System Toolbox
dsp.LSPToLPC*	DSP System Toolbox
dsp.LUFactor*	DSP System Toolbox
dsp.Maximum*	DSP System Toolbox
dsp.Mean*	DSP System Toolbox
dsp.Median*	DSP System Toolbox
dsp.MedianFilter*	DSP System Toolbox
dsp.MovingAverage*	DSP System Toolbox
dsp.MovingMaximum*	DSP System Toolbox
dsp.MovingMinimum*	DSP System Toolbox
dsp.MovingRMS*	DSP System Toolbox
dsp.MovingStandardDeviation*	DSP System Toolbox
dsp.MovingVariance*	DSP System Toolbox
dsp.Minimum*	DSP System Toolbox
dsp.NCO*	DSP System Toolbox
dsp.Normalizer*	DSP System Toolbox
dsp.PeakFinder*	DSP System Toolbox
dsp.PeakToPeak*	DSP System Toolbox
dsp.PeakToRMS*	DSP System Toolbox
dsp.PhaseExtractor*	DSP System Toolbox
dsp.PhaseUnwrapper*	DSP System Toolbox
dsp.RCToAutocorrelation*	DSP System Toolbox
dsp.RCToLPC*	DSP System Toolbox
dsp.RMS*	DSP System Toolbox
dsp.RLSFilter*	DSP System Toolbox
dsp.SampleRateConverter*	DSP System Toolbox
dsp.ScalarQuantizerDecoder*	DSP System Toolbox
dsp.ScalarQuantizerEncoder*	DSP System Toolbox

<b>Name</b>	<b>Product</b>
dsp.SignalSource*	DSP System Toolbox
dsp.SineWave*	DSP System Toolbox
dsp.SpectrumAnalyzer*	DSP System Toolbox
dsp.SpectrumEstimator*	DSP System Toolbox
dsp.StandardDeviation*	DSP System Toolbox
dsp.StateLevels*	DSP System Toolbox
dsp.SubbandAnalysisFilter*	DSP System Toolbox
dsp.SubbandSynthesisFilter*	DSP System Toolbox
dsp.TimeScope*	DSP System Toolbox
dsp.TransferFunctionEstimator*	DSP System Toolbox
dsp.UDPReceiver*	DSP System Toolbox
dsp.UDPSender*	DSP System Toolbox
dsp.UpperTriangularSolver*	DSP System Toolbox
dsp.VariableBandwidthFIRFilter*	DSP System Toolbox
dsp.VariableBandwidthIIRFilter*	DSP System Toolbox
dsp.VariableFractionDelay*	DSP System Toolbox
dsp.VariableIntegerDelay*	DSP System Toolbox
dsp.Variance*	DSP System Toolbox
dsp.VectorQuantizerDecoder*	DSP System Toolbox
dsp.VectorQuantizerEncoder*	DSP System Toolbox
dsp.Window*	DSP System Toolbox
dsp.ZeroCrossingDetector*	DSP System Toolbox
dvbs21dpc*	Communications System Toolbox
dwt*	Wavelet Toolbox
dwt2*	Wavelet Toolbox
dyadup*	Wavelet Toolbox
edge*	Image Processing Toolbox
effearthradius*	Phased Array System Toolbox



Name	Product
eig*	MATLAB
ellip*	Signal Processing Toolbox
ellipap*	Signal Processing Toolbox
ellipke	MATLAB
ellipord*	Signal Processing Toolbox
end	MATLAB
end	Fixed-Point Designer
envelope*	Signal Processing Toolbox
epipolarLine	Computer Vision System Toolbox
eps	MATLAB
eps*	Fixed-Point Designer
eq*	MATLAB
eq*	Fixed-Point Designer
erf	MATLAB
erfc	MATLAB
erfcinv	MATLAB
erfcx	MATLAB
erfinv	MATLAB
error*	MATLAB
espritdoa*	Phased Array System Toolbox
estimateEssentialMatrix*	Computer Vision System Toolbox
estimateFundamentalMatrix*	Computer Vision System Toolbox
estimateGeometricTransform*	Computer Vision System Toolbox
estimateUncalibratedRectification	Computer Vision System Toolbox
estimateWorldCameraPose*	Computer Vision System Toolbox
eul2quat	Robotics System Toolbox
eul2rotm	Robotics System Toolbox

<b>Name</b>	<b>Product</b>
eul2tform	Robotics System Toolbox
evcdf	Statistics and Machine Learning Toolbox
evinv	Statistics and Machine Learning Toolbox
evpdf	Statistics and Machine Learning Toolbox
evrnd*	Statistics and Machine Learning Toolbox
evstat	Statistics and Machine Learning Toolbox
exp	MATLAB
expander*	Audio System Toolbox
expcdf	Statistics and Machine Learning Toolbox
expint	MATLAB
expinv	Statistics and Machine Learning Toolbox
expm	MATLAB
expm1	MATLAB
exppdf	Statistics and Machine Learning Toolbox
exprnd	Statistics and Machine Learning Toolbox
expstat	Statistics and Machine Learning Toolbox
extendedKalmanFilter*	Control System Toolbox
extendedKalmanFilter*	System Identification Toolbox
extractFeatures*	Computer Vision System Toolbox
extractHOGFeatures*	Computer Vision System Toolbox

Name	Product
extractLBPFeatures*	Computer Vision System Toolbox
extrinsics*	Computer Vision System Toolbox
extrinsicsToCameraPose	Computer Vision System Toolbox
eye*	MATLAB
factor*	MATLAB
factorial	MATLAB
false*	MATLAB
fcdf	Statistics and Machine Learning Toolbox
fclose	MATLAB
feof	MATLAB
fft*	MATLAB
fft2	MATLAB
fftn*	MATLAB
fftshift	MATLAB
fi*	Fixed-Point Designer
fieldnames*	MATLAB
filter*	MATLAB
filter*	Fixed-Point Designer
filter2	MATLAB
filtfilt*	Signal Processing Toolbox
fimath*	Fixed-Point Designer
find*	MATLAB
finddelay	Signal Processing Toolbox
findpeaks	Signal Processing Toolbox
finv	Statistics and Machine Learning Toolbox
fir1*	Signal Processing Toolbox

<b>Name</b>	<b>Product</b>
<code>fir2*</code>	Signal Processing Toolbox
<code>firceqrip*</code>	DSP System Toolbox
<code>fircls*</code>	Signal Processing Toolbox
<code>fircls1*</code>	Signal Processing Toolbox
<code>fireqint*</code>	DSP System Toolbox
<code>firgr*</code>	DSP System Toolbox
<code>firhalfband*</code>	DSP System Toolbox
<code>firlpnorm*</code>	DSP System Toolbox
<code>firls*</code>	Signal Processing Toolbox
<code>firminphase*</code>	DSP System Toolbox
<code>firnyquist*</code>	DSP System Toolbox
<code>firpr2chfb*</code>	DSP System Toolbox
<code>firpm*</code>	Signal Processing Toolbox
<code>firpmord*</code>	Signal Processing Toolbox
<code>fitgeotrans*</code>	Image Processing Toolbox
<code>fix</code>	MATLAB
<code>fix</code>	Fixed-Point Designer
<code>fixed.Quantizer</code>	Fixed-Point Designer
<code>flattopwin*</code>	Signal Processing Toolbox
<code>flintmax</code>	MATLAB
<code>flip*</code>	MATLAB
<code>flip*</code>	Fixed-Point Designer
<code>flipdim*</code>	MATLAB
<code>fliplr*</code>	MATLAB
<code>fliplr</code>	Fixed-Point Designer
<code>flipud*</code>	MATLAB
<code>flipud</code>	Fixed-Point Designer

<b>Name</b>	<b>Product</b>
floor	MATLAB
floor	Fixed-Point Designer
fminbnd*	MATLAB
fminbnd*	Optimization Toolbox
fminsearch*	MATLAB
fminsearch*	Optimization Toolbox
fogpl*	Phased Array System Toolbox
fopen*	MATLAB
for	MATLAB
for	Fixed-Point Designer
fpdf	Statistics and Machine Learning Toolbox
fprintf*	MATLAB
fread*	MATLAB
freqspace	MATLAB
freqz*	Signal Processing Toolbox
frewind	MATLAB
frnd*	Statistics and Machine Learning Toolbox
fseek*	MATLAB
fspecial*	Image Processing Toolbox
fspl*	Phased Array System Toolbox
fstat	Statistics and Machine Learning Toolbox
ftell*	MATLAB
full	MATLAB
fwrite*	MATLAB
fzero*	MATLAB

<b>Name</b>	<b>Product</b>
fzero*	Optimization Toolbox
gain2aperture*	Phased Array System Toolbox
gamcdf	Statistics and Machine Learning Toolbox
gaminv	Statistics and Machine Learning Toolbox
gamma	MATLAB
gammainc*	MATLAB
gammaincinv*	MATLAB
gammaln	MATLAB
gampdf	Statistics and Machine Learning Toolbox
gamrnd*	Statistics and Machine Learning Toolbox
gamstat	Statistics and Machine Learning Toolbox
gaspl*	Phased Array System Toolbox
gausswin*	Signal Processing Toolbox
gccphat*	Phased Array System Toolbox
gcd	MATLAB
ge	MATLAB
ge*	Fixed-Point Designer
GeneralizedLinearModel* or CompactGeneralizedLinearModel*	Statistics and Machine Learning Toolbox
generateCheckerboardPoints*	Computer Vision System Toolbox
genqamdemod	Communications System Toolbox
geocdf	Statistics and Machine Learning Toolbox
geoinv	Statistics and Machine Learning Toolbox

Name	Product
geomean	Statistics and Machine Learning Toolbox
geopdf	Statistics and Machine Learning Toolbox
geornd*	Statistics and Machine Learning Toolbox
geostat	Statistics and Machine Learning Toolbox
get*	Fixed-Point Designer
getlsb	Fixed-Point Designer
getmsb	Fixed-Point Designer
getNumInputs*	MATLAB
getNumOutputs*	MATLAB
getrangefromclass*	Image Processing Toolbox
getTrackPositions	Automated Driving System Toolbox
getTrackVelocities	Automated Driving System Toolbox
gevcdf	Statistics and Machine Learning Toolbox
gevinv	Statistics and Machine Learning Toolbox
gevpdf	Statistics and Machine Learning Toolbox
gevrnd*	Statistics and Machine Learning Toolbox
gevstat	Statistics and Machine Learning Toolbox
glmval*	Statistics and Machine Learning Toolbox
global2localcoord*	Phased Array System Toolbox
gpcdf	Statistics and Machine Learning Toolbox

<b>Name</b>	<b>Product</b>
gpinv	Statistics and Machine Learning Toolbox
gppdf	Statistics and Machine Learning Toolbox
gprnd*	Statistics and Machine Learning Toolbox
gpstat	Statistics and Machine Learning Toolbox
gradient	MATLAB
gray2bin	Communications System Toolbox
grayconnected*	Image Processing Toolbox
grazingang*	Phased Array System Toolbox
gt	MATLAB
gt*	Fixed-Point Designer
hadamard*	MATLAB
hamming*	Signal Processing Toolbox
hankel	MATLAB
hann*	Signal Processing Toolbox
harmmean	Statistics and Machine Learning Toolbox
hex2dec*	MATLAB
hex2num*	MATLAB
hilb	MATLAB
hilbert	Signal Processing Toolbox
hist*	MATLAB
histc*	MATLAB
histcounts*	MATLAB
histeq*	Image Processing Toolbox
hom2cart	Robotics System Toolbox



Name	Product
horizonrange*	Phased Array System Toolbox
horzcat	Fixed-Point Designer
hough*	Image Processing Toolbox
houghlines*	Image Processing Toolbox
houghpeaks*	Image Processing Toolbox
hygecdf	Statistics and Machine Learning Toolbox
hygeinv	Statistics and Machine Learning Toolbox
hygepdf	Statistics and Machine Learning Toolbox
hygernd*	Statistics and Machine Learning Toolbox
hygestat	Statistics and Machine Learning Toolbox
hypot	MATLAB
icdf	Statistics and Machine Learning Toolbox
idct*	Signal Processing Toolbox
if, elseif, else	MATLAB
idivide*	MATLAB
idwt*	Wavelet Toolbox
idwt2*	Wavelet Toolbox
ifft*	MATLAB
ifft2*	MATLAB
ifftn*	MATLAB
ifftshift	MATLAB
ifir*	DSP System Toolbox
iircomb*	DSP System Toolbox

<b>Name</b>	<b>Product</b>
iirgrpdelay*	DSP System Toolbox
iirlpnorm*	DSP System Toolbox
iirlpnormc*	DSP System Toolbox
iirnotch*	DSP System Toolbox
iirpeak*	DSP System Toolbox
im2double	MATLAB
im2int16*	Image Processing Toolbox
im2single*	Image Processing Toolbox
im2uint8*	Image Processing Toolbox
im2uint16*	Image Processing Toolbox
imabsdiff*	Image Processing Toolbox
imadjust*	Image Processing Toolbox
imag	MATLAB
imag	Fixed-Point Designer
imaq.VideoDevice*	Image Acquisition Toolbox™
imbinarize*	Image Processing Toolbox
imbothat*	Image Processing Toolbox
imboxfilt*	Image Processing Toolbox
imclearborder*	Image Processing Toolbox
imclose*	Image Processing Toolbox
imcomplement*	Image Processing Toolbox
imcrop*	Image Processing Toolbox
imdilate*	Image Processing Toolbox
imerode*	Image Processing Toolbox
imextendedmax*	Image Processing Toolbox
imextendedmin*	Image Processing Toolbox
imfill*	Image Processing Toolbox

Name	Product
imfilter*	Image Processing Toolbox
imfindcircles*	Image Processing Toolbox
imgaborfilt*	Image Processing Toolbox
imgaussfilt*	Image Processing Toolbox
imgradient3*	Image Processing Toolbox
imgradientxyz*	Image Processing Toolbox
imhist*	Image Processing Toolbox
imhmax*	Image Processing Toolbox
imhmin*	Image Processing Toolbox
imlincomb*	Image Processing Toolbox
immse*	Image Processing Toolbox
imodwpt*	Wavelet Toolbox
imodwt*	Wavelet Toolbox
imopen*	Image Processing Toolbox
imoverlay*	Image Processing Toolbox
impyramid*	Image Processing Toolbox
imquantize*	Image Processing Toolbox
imread*	Image Processing Toolbox
imreconstruct*	Image Processing Toolbox
imref2d*	Image Processing Toolbox
imref3d*	Image Processing Toolbox
imregionalmax*	Image Processing Toolbox
imregionalmin*	Image Processing Toolbox
imresize*	Image Processing Toolbox
imrotate*	Image Processing Toolbox
imtophat*	Image Processing Toolbox
imtranslate*	Image Processing Toolbox
imwarp*	Image Processing Toolbox

<b>Name</b>	<b>Product</b>
ind2sub*	MATLAB
inf*	MATLAB
initcaekf	Automated Driving System Toolbox
initcakf	Automated Driving System Toolbox
initcaukf	Automated Driving System Toolbox
initctekf	Automated Driving System Toolbox
initctukf	Automated Driving System Toolbox
initcvekf	Automated Driving System Toolbox
initcvkf	Automated Driving System Toolbox
initcvukf	Automated Driving System Toolbox
inpolygon*	MATLAB
insertMarker*	Computer Vision System Toolbox
insertObjectAnnotation*	Computer Vision System Toolbox
insertShape*	Computer Vision System Toolbox
insertText*	Computer Vision System Toolbox
int8, int16, int32, int64	MATLAB
int8, int16, int32, int64	Fixed-Point Designer
integralBoxFilter*	Image Processing Toolbox
integralImage	Computer Vision System Toolbox
integratedLoudness	Audio System Toolbox
interp1*	MATLAB
interp1q*	MATLAB
interp2*	MATLAB
interp3*	MATLAB
interp*	MATLAB
intersect*	MATLAB
intfilt*	Signal Processing Toolbox

<b>Name</b>	<b>Product</b>
intlut*	Image Processing Toolbox
intmax	MATLAB
intmin	MATLAB
inv*	MATLAB
invhilb	MATLAB
ipermute*	MATLAB
ipermute	Fixed-Point Designer
iptcheckconn*	Image Processing Toolbox
iptcheckmap*	Image Processing Toolbox
iqcoef2imbal	Communications System Toolbox
iqimbal	Communications System Toolbox
iqimbal2coef	Communications System Toolbox
iqr	Statistics and Machine Learning Toolbox
isa	MATLAB
isbanded	MATLAB
iscell	MATLAB
iscellstr	MATLAB
ischar	MATLAB
iscolumn	MATLAB
iscolumn	Fixed-Point Designer
isdeployed*	MATLAB Compiler
isdiag	MATLAB
isempty	MATLAB
isempty	Fixed-Point Designer
isenum	MATLAB
isEpipoleInImage	Computer Vision System Toolbox
isequal	MATLAB

<b>Name</b>	<b>Product</b>
isequal	Fixed-Point Designer
isequaln	MATLAB
isfi*	Fixed-Point Designer
isfield*	MATLAB
isfimath	Fixed-Point Designer
isfimathlocal	Fixed-Point Designer
isfinite	MATLAB
isfinite	Fixed-Point Designer
isfloat	MATLAB
ishermitian	MATLAB
isinf	MATLAB
isinf	Fixed-Point Designer
isinteger	MATLAB
isletter*	MATLAB
isLocked*	MATLAB
islogical	MATLAB
ismac*	MATLAB
ismatrix	MATLAB
ismcc*	MATLAB Compiler
ismember*	MATLAB
ismethod	MATLAB
isnan	MATLAB
isnan	Fixed-Point Designer
isnumeric	MATLAB
isnumeric	Fixed-Point Designer
isnumericitype	Fixed-Point Designer
isobject	MATLAB

Name	Product
ispc*	MATLAB
isprime*	MATLAB
isreal	MATLAB
isreal	Fixed-Point Designer
isrow	MATLAB
isrow	Fixed-Point Designer
isscalar	MATLAB
isscalar	Fixed-Point Designer
assigned	Fixed-Point Designer
issorted*	MATLAB
isspace*	MATLAB
issparse	MATLAB
isstrprop*	MATLAB
isstruct	MATLAB
issymmetric	MATLAB
istrellis	Communications System Toolbox
istril	MATLAB
istriu	MATLAB
isunix*	MATLAB
isvector	MATLAB
isvector	Fixed-Point Designer
kaiser	Signal Processing Toolbox
kaiserord	Signal Processing Toolbox
kron	MATLAB
kmeans*	Statistics and Machine Learning Toolbox
kurtosis	Statistics and Machine Learning Toolbox

<b>Name</b>	<b>Product</b>
lab2rgb*	Image Processing Toolbox
label2idx*	Image Processing Toolbox
label2rgb*	Image Processing Toolbox
lcm	MATLAB
lcmvweights*	Phased Array System Toolbox
ldivide	MATLAB
le	MATLAB
le*	Fixed-Point Designer
length	MATLAB
length	Fixed-Point Designer
levinson*	Signal Processing Toolbox
limiter*	Audio System Toolbox
LinearModel* or CompactLinearModel*	Statistics and Machine Learning Toolbox
lineToBorderPoints	Computer Vision System Toolbox
linsolve*	MATLAB
linspace	MATLAB
load*	MATLAB
loadCompactModel*	Statistics and Machine Learning Toolbox
local2globalcoord*	Phased Array System Toolbox
log*	MATLAB
log2	MATLAB
log10	MATLAB
log1p	MATLAB
logical	MATLAB
logical	Fixed-Point Designer



Name	Product
logncdf	Statistics and Machine Learning Toolbox
logninv	Statistics and Machine Learning Toolbox
lognpdf	Statistics and Machine Learning Toolbox
lognrnd*	Statistics and Machine Learning Toolbox
lognstat	Statistics and Machine Learning Toolbox
logspace	MATLAB
loudnessMeter*	Audio System Toolbox
lower*	MATLAB
lowerbound	Fixed-Point Designer
lsb*	Fixed-Point Designer
lsqnonneg*	MATLAB
lsqnonneg*	Optimization Toolbox
lt	MATLAB
lt*	Fixed-Point Designer
lteZadoffChuSeq	Communications System Toolbox
lu	MATLAB
mad*	Statistics and Machine Learning Toolbox
magic*	MATLAB
matchFeatures*	Computer Vision System Toolbox
max*	MATLAB
max	Fixed-Point Designer
maxflat*	Signal Processing Toolbox
mdltest*	Phased Array System Toolbox

<b>Name</b>	<b>Product</b>
mean*	MATLAB
mean	Fixed-Point Designer
mean2*	Image Processing Toolbox
medfilt2*	Image Processing Toolbox
median*	MATLAB
median	Fixed-Point Designer
meshgrid	MATLAB
mfilename	MATLAB
min*	MATLAB
min	Fixed-Point Designer
minus	MATLAB
minus*	Fixed-Point Designer
mkpp*	MATLAB
mldivide	MATLAB
mnpdf	Statistics and Machine Learning Toolbox
mod*	MATLAB
mode*	MATLAB
modwpt*	Wavelet Toolbox
modwptdetails*	Wavelet Toolbox
modwt*	Wavelet Toolbox
modwtmra*	Wavelet Toolbox
moment*	Statistics and Machine Learning Toolbox
mpower*	MATLAB
mpower*	Fixed-Point Designer
mpy*	Fixed-Point Designer
mrdivide	MATLAB

Name	Product
mrdivide	Fixed-Point Designer
MSERRegions*	Computer Vision System Toolbox
mtimes*	MATLAB
mtimes*	Fixed-Point Designer
multibandParametricEQ*	Audio System Toolbox
multiObjectTracker*	Automated Driving System Toolbox
multithresh*	Image Processing Toolbox
musicdoa*	Phased Array System Toolbox
mvdrweights*	Phased Array System Toolbox
NaN or nan*	MATLAB
nancov*	Statistics and Machine Learning Toolbox
nanmax	Statistics and Machine Learning Toolbox
nanmean	Statistics and Machine Learning Toolbox
nanmedian	Statistics and Machine Learning Toolbox
nanmin	Statistics and Machine Learning Toolbox
nanstd	Statistics and Machine Learning Toolbox
nansum	Statistics and Machine Learning Toolbox
nanvar	Statistics and Machine Learning Toolbox
nargin*	MATLAB
narginchk	MATLAB
nargout*	MATLAB
nargoutchk	MATLAB

<b>Name</b>	<b>Product</b>
nbincdf	Statistics and Machine Learning Toolbox
nbiniinv	Statistics and Machine Learning Toolbox
nbincpdf	Statistics and Machine Learning Toolbox
nbincrnd*	Statistics and Machine Learning Toolbox
nbincstat	Statistics and Machine Learning Toolbox
ncfcdf	Statistics and Machine Learning Toolbox
ncfinv	Statistics and Machine Learning Toolbox
ncfpdf	Statistics and Machine Learning Toolbox
ncfrnd*	Statistics and Machine Learning Toolbox
ncfstat	Statistics and Machine Learning Toolbox
nchoosek*	MATLAB
nctcdf	Statistics and Machine Learning Toolbox
nctinv	Statistics and Machine Learning Toolbox
nctpdf	Statistics and Machine Learning Toolbox
nctrnd*	Statistics and Machine Learning Toolbox
nctstat	Statistics and Machine Learning Toolbox

Name	Product
ncx2cdf	Statistics and Machine Learning Toolbox
ncx2rnd*	Statistics and Machine Learning Toolbox
ncx2stat	Statistics and Machine Learning Toolbox
ndgrid	MATLAB
ndims	MATLAB
ndims	Fixed-Point Designer
ne*	MATLAB
ne*	Fixed-Point Designer
nearest	Fixed-Point Designer
nextpow2	MATLAB
nnz	MATLAB
noiseGate*	Audio System Toolbox
noisepow*	Phased Array System Toolbox
nonzeros	MATLAB
norm	MATLAB
normcdf	Statistics and Machine Learning Toolbox
normest	MATLAB
norminv	Statistics and Machine Learning Toolbox
normpdf	Statistics and Machine Learning Toolbox
normrnd*	Statistics and Machine Learning Toolbox
normstat	Statistics and Machine Learning Toolbox
not	MATLAB

<b>Name</b>	<b>Product</b>
npwgnthresh*	Phased Array System Toolbox
nthroot	MATLAB
null*	MATLAB
num2hex	MATLAB
numberofelements*	Fixed-Point Designer
numel	MATLAB
numel	Fixed-Point Designer
numerictype*	Fixed-Point Designer
nuttallwin*	Signal Processing Toolbox
objectDetection	Automated Driving System Toolbox
ocr*	Computer Vision System Toolbox
ocrText*	Computer Vision System Toolbox
oct2dec	Communications System Toolbox
octaveFilter*	Audio System Toolbox
ode23*	MATLAB
ode45 *	MATLAB
odeget *	MATLAB
odeset *	MATLAB
offsetstrel*	Image Processing Toolbox
ones *	MATLAB
opticalFlowFarneback*	Computer Vision System Toolbox
opticalFlowHS*	Computer Vision System Toolbox
opticalFlowLK*	Computer Vision System Toolbox
opticalFlowLKDoG*	Computer Vision System Toolbox
optimget*	MATLAB
optimget*	Optimization Toolbox
optimset*	MATLAB
optimset*	Optimization Toolbox

Name	Product
ordfilt2*	Image Processing Toolbox
or	MATLAB
orth*	MATLAB
otsuthresh*	Image Processing Toolbox
padarray*	Image Processing Toolbox
pambgfun*	Phased Array System Toolbox
parfor*	MATLAB
parzenwin*	Signal Processing Toolbox
pascal	MATLAB
pca*	Statistics and Machine Learning Toolbox
pchip*	MATLAB
pdf	Statistics and Machine Learning Toolbox
peak2peak	Signal Processing Toolbox
peak2rms	Signal Processing Toolbox
pearsrnd*	Statistics and Machine Learning Toolbox
permute*	MATLAB
permute*	Fixed-Point Designer
phased.ADPCACanceller*	Phased Array System Toolbox
phased.AngleDopplerResponse*	Phased Array System Toolbox
phased.ArrayGain*	Phased Array System Toolbox
phased.ArrayResponse*	Phased Array System Toolbox
phased.BackscatterRadarTarget*	Phased Array System Toolbox
phased.BackScatterSonarTarget*	Phased Array System Toolbox
phased.BarrageJammer*	Phased Array System Toolbox
phased.BeamscanEstimator*	Phased Array System Toolbox

Name	Product
phased.BeamscanEstimator2D*	Phased Array System Toolbox
phased.BeamspaceESPRITEstimator*	Phased Array System Toolbox
phased.CFARDetector*	Phased Array System Toolbox
phased.CFARDetector2D*	Phased Array System Toolbox
phased.Collector*	Phased Array System Toolbox
phased.ConformalArray*	Phased Array System Toolbox
phased.ConstantGammaClutter*	Phased Array System Toolbox
phased.CosineAntennaElement*	Phased Array System Toolbox
phased.CrossedDipoleAntennaElement*	Phased Array System Toolbox
phased.CustomAntennaElement*	Phased Array System Toolbox
phased.CustomMicrophoneElement*	Phased Array System Toolbox
phased.DopplerEstimator	Phased Array System Toolbox
phased.DPCACanceller*	Phased Array System Toolbox
phased.ElementDelay*	Phased Array System Toolbox
phased.ESPRITEstimator*	Phased Array System Toolbox
phased.FMCWWaveform*	Phased Array System Toolbox
phased.FreeSpace*	Phased Array System Toolbox
phased.FrostBeamformer*	Phased Array System Toolbox
phased.GSCBeamformer*	Phased Array System Toolbox
phased.GCCEstimator*	Phased Array System Toolbox
phased.IsoSpeedUnderWaterPaths*	Phased Array System Toolbox
phased.IsotropicAntennaElement*	Phased Array System Toolbox
phased.IsotropicHydrophone*	Phased Array System Toolbox
phased.IsotropicProjector*	Phased Array System Toolbox
phased.LCMVBeamformer*	Phased Array System Toolbox
phased.LOSChannel*	Phased Array System Toolbox
phased.LinearFMWaveform*	Phased Array System Toolbox
phased.MatchedFilter*	Phased Array System Toolbox



Name	Product
phased.MFSKWaveform*	Phased Array System Toolbox
phased.MUSICEstimator*	Phased Array System Toolbox
phased.MUSICEstimator2D*	Phased Array System Toolbox
phased.MVDRBeamformer*	Phased Array System Toolbox
phased.MVDREstimator*	Phased Array System Toolbox
phased.MVDREstimator2D*	Phased Array System Toolbox
phased.MultipathChannel*	Phased Array System Toolbox
phased.OmnidirectionalMicrophoneElement*	Phased Array System Toolbox
phased.PartitionedArray*	Phased Array System Toolbox
phased.PhaseCodedWaveform*	Phased Array System Toolbox
phased.PhaseShiftBeamformer*	Phased Array System Toolbox
phased.Platform*	Phased Array System Toolbox
phased.RadarTarget*	Phased Array System Toolbox
phased.Radiator*	Phased Array System Toolbox
phased.RangeDopplerResponse*	Phased Array System Toolbox
phased.RangeEstimator*	Phased Array System Toolbox
phased.RangeResponse*	Phased Array System Toolbox
phased.RectangularWaveform*	Phased Array System Toolbox
phased.ReceiverPreamp*	Phased Array System Toolbox
phased.ReplicatedSubarray*	Phased Array System Toolbox
phased.RootMUSICEstimator*	Phased Array System Toolbox
phased.RootWSFEstimator	Phased Array System Toolbox
phased.ScatteringMIMOChannel*	Phased Array System Toolbox
phased.ShortDipoleAntennaElement*	Phased Array System Toolbox
phased.STAPSMIBeamformer*	Phased Array System Toolbox
phased.SteeringVector*	Phased Array System Toolbox
phased.SteppedFMWaveform*	Phased Array System Toolbox
phased.StretchProcessor*	Phased Array System Toolbox

Name	Product
phased.SubbandMVDRBeamformer*	Phased Array System Toolbox
phased.SubbandPhaseShiftBeamformer*	Phased Array System Toolbox
phased.SumDifferenceMonopulseTracker*	Phased Array System Toolbox
phased.SumDifferenceMonopulseTracker2D*	Phased Array System Toolbox
phased.TimeDelayBeamformer*	Phased Array System Toolbox
phased.TimeDelayLCMVBeamformer*	Phased Array System Toolbox
phased.TimeVaryingGain*	Phased Array System Toolbox
phased.Transmitter*	Phased Array System Toolbox
phased.TwoRayChannel*	Phased Array System Toolbox
phased.UCA*	Phased Array System Toolbox
phased.ULA*	Phased Array System Toolbox
phased.URA*	Phased Array System Toolbox
phased.WidebandBackscatterRadarTarget*	Phased Array System Toolbox
phased.WidebandCollector*	Phased Array System Toolbox
phased.WidebandFreeSpace	Phased Array System Toolbox
phased.WidebandLOSChannel*	Phased Array System Toolbox
phased.WidebandRadiator*	Phased Array System Toolbox
phased.WidebandTwoRayChannel*	Phased Array System Toolbox
phitheta2azel*	Phased Array System Toolbox
phitheta2azelpat*	Phased Array System Toolbox
phitheta2uv*	Phased Array System Toolbox
phitheta2uvpat*	Phased Array System Toolbox
physconst*	Phased Array System Toolbox
pi	MATLAB
pilotcalib*	Phased Array System Toolbox
pinv	MATLAB
planerot*	MATLAB
plus	MATLAB

Name	Product
plus*	Fixed-Point Designer
poisscdf	Statistics and Machine Learning Toolbox
poissinv	Statistics and Machine Learning Toolbox
poisspdf	Statistics and Machine Learning Toolbox
poissrnd*	Statistics and Machine Learning Toolbox
poisstat	Statistics and Machine Learning Toolbox
pol2cart	MATLAB
pol2circpol*	Phased Array System Toolbox
polellip*	Phased Array System Toolbox
polloss*	Phased Array System Toolbox
polratio*	Phased Array System Toolbox
polsignature*	Phased Array System Toolbox
poly*	MATLAB
polyarea	MATLAB
poly2trellis	Communications System Toolbox
polyder*	MATLAB
polyeig*	MATLAB
polyfit*	MATLAB
polyint	MATLAB
polyval	MATLAB
polyvalm	MATLAB
pow2	Fixed-Point Designer
pow2db	Signal Processing Toolbox
power*	MATLAB

<b>Name</b>	<b>Product</b>
power*	Fixed-Point Designer
ppval*	MATLAB
prctile*	Statistics and Machine Learning Toolbox
predict* method of ClassificationECOC and Compact-ClassificationECOC	Statistics and Machine Learning Toolbox
predict* method of ClassificationEnsemble, ClassificationBaggedEnsemble, and CompactClassificationEnsemble	Statistics and Machine Learning Toolbox
predict* method of ClassificationLinear	Statistics and Machine Learning Toolbox
predict* method of ClassificationSVM and Compact-ClassificationSVM	Statistics and Machine Learning Toolbox
predict* method of ClassificationTree and CompactClassificationTree	Statistics and Machine Learning Toolbox
predict* method of GeneralizedLinearModel and CompactGeneralizedLinearModel	Statistics and Machine Learning Toolbox
predict* method of LinearModel and CompactLinearModel	Statistics and Machine Learning Toolbox
predict* method of RegressionTree or CompactRegressionTree	Statistics and Machine Learning Toolbox
primes*	MATLAB
prod*	MATLAB
projective2d*	Image Processing Toolbox
psi	MATLAB
psnr*	Image Processing Toolbox
pulsint*	Phased Array System Toolbox
qamdemod	Communications System Toolbox
qammod	Communications System Toolbox
qmf*	Wavelet Toolbox

Name	Product
qr	MATLAB
qr	Fixed-Point Designer
quad2d*	MATLAB
quadgk	MATLAB
quantile	Statistics and Machine Learning Toolbox
quantize	Fixed-Point Designer
quat2axang	Robotics System Toolbox
quat2eul	Robotics System Toolbox
quat2rotm	Robotics System Toolbox
quat2tform	Robotics System Toolbox
quatconj*	Aerospace Toolbox
quatdivide*	Aerospace Toolbox
quatinv*	Aerospace Toolbox
quatmod*	Aerospace Toolbox
quatmultiply*	Aerospace Toolbox
quatnorm*	Aerospace Toolbox
quatnormalize*	Aerospace Toolbox
rad2deg	MATLAB
radareqpow*	Phased Array System Toolbox
radareqrng*	Phased Array System Toolbox
radareqsnr*	Phased Array System Toolbox
radarvcd*	Phased Array System Toolbox
radialspeed*	Phased Array System Toolbox
rainpl*	Phased Array System Toolbox
rand*	MATLAB
randg	Statistics and Machine Learning Toolbox

<b>Name</b>	<b>Product</b>
randi*	MATLAB
randn*	MATLAB
random	Statistics and Machine Learning Toolbox
random* method of <code>GeneralizedLinearModel</code> and <code>CompactGeneralizedLinearModel</code>	Statistics and Machine Learning Toolbox
random* method of <code>LinearModel</code> and <code>CompactLinearModel</code>	Statistics and Machine Learning Toolbox
randperm	MATLAB
randsample*	Statistics and Machine Learning Toolbox
range	Fixed-Point Designer
range2beat*	Phased Array System Toolbox
range2bw*	Phased Array System Toolbox
range2time*	Phased Array System Toolbox
rangeangle*	Phased Array System Toolbox
rank	MATLAB
raylcdf	Statistics and Machine Learning Toolbox
raylinv	Statistics and Machine Learning Toolbox
raylpdf	Statistics and Machine Learning Toolbox
raylrnd*	Statistics and Machine Learning Toolbox
raylstat	Statistics and Machine Learning Toolbox
rcond	MATLAB
rcosdesign*	Signal Processing Toolbox
rdcoupling*	Phased Array System Toolbox

Name	Product
rdivide	MATLAB
rdivide	Fixed-Point Designer
real	MATLAB
real	Fixed-Point Designer
reallog	MATLAB
realmax	MATLAB
realmax	Fixed-Point Designer
realmin	MATLAB
realmin	Fixed-Point Designer
realpow	MATLAB
realsqrt	MATLAB
reconstructScene*	Computer Vision System Toolbox
rectifyStereoImages*	Computer Vision System Toolbox
rectint	MATLAB
rectwin*	Signal Processing Toolbox
recursiveAR*	System Identification Toolbox
recursiveARMA*	System Identification Toolbox
recursiveARMAX*	System Identification Toolbox
recursiveARX*	System Identification Toolbox
recursiveBJ*	System Identification Toolbox
recursiveLS*	System Identification Toolbox
recursiveOE*	System Identification Toolbox
regionprops*	Image Processing Toolbox
RegressionTree* or CompactRegressionTree*	Statistics and Machine Learning Toolbox
reinterpretcast	Fixed-Point Designer
relativeCameraPose*	Computer Vision System Toolbox
release*	MATLAB

<b>Name</b>	<b>Product</b>
rem*	MATLAB
removefimath	Fixed-Point Designer
repelem*	MATLAB
repmat*	MATLAB
repmat*	Fixed-Point Designer
resample*	Signal Processing Toolbox
rescale	Fixed-Point Designer
reset*	MATLAB
reshape*	MATLAB
reshape	Fixed-Point Designer
return	MATLAB
reverberator*	Audio System Toolbox
rgb2gray	MATLAB
rgb2lab*	Image Processing Toolbox
rgb2ycbcr*	Image Processing Toolbox
rms	Signal Processing Toolbox
rng*	MATLAB
robotics.AimingConstraint	Robotics System Toolbox
robotics.BinaryOccupancyGrid*	Robotics System Toolbox
robotics.Cartesianbounds	Robotics System Toolbox
robotics.GeneralizedInverseKinematics*	Robotics System Toolbox
robotics.InverseKinematics*	Robotics System Toolbox
robotics.Joint	Robotics System Toolbox
robotics.JointPositionBounds	Robotics System Toolbox
robotics.OccupancyGrid*	Robotics System Toolbox
robotics.OdometryMotionModel*	Robotics System Toolbox
robotics.OrientationTarget	Robotics System Toolbox
robotics.ParticleFilter*	Robotics System Toolbox



Name	Product
robotics.PoseTarget	Robotics System Toolbox
robotics.PositionTarget	Robotics System Toolbox
robotics.PRM*	Robotics System Toolbox
robotics.PurePursuit*	Robotics System Toolbox
robotics.RigidBody	Robotics System Toolbox
robotics.RigidBodyTree*	Robotics System Toolbox
robotics.VectorFieldHistogram*	Robotics System Toolbox
rocpga*	Phased Array System Toolbox
rocsnr*	Phased Array System Toolbox
rootmusicdoa*	Phased Array System Toolbox
roots*	MATLAB
rosser	MATLAB
rot90*	MATLAB
rot90*	Fixed-Point Designer
rotationMatrixToVector	Computer Vision System Toolbox
rotationVectorToMatrix	Computer Vision System Toolbox
rotm2axang	Robotics System Toolbox
rotm2eul	Robotics System Toolbox
rotm2quat	Robotics System Toolbox
rotm2tform	Robotics System Toolbox
rotx*	Phased Array System Toolbox
roty*	Phased Array System Toolbox
rotz*	Phased Array System Toolbox
round*	MATLAB
round	Fixed-Point Designer
rsf2csf	MATLAB
rsgenpoly	Communications System Toolbox
rsgenpolycoeffs	Communications System Toolbox

<b>Name</b>	<b>Product</b>
schur*	MATLAB
sec	MATLAB
secd*	MATLAB
sech	MATLAB
selectStrongestBbox*	Computer Vision System Toolbox
sensorcov*	Phased Array System Toolbox
sensorsig*	Phased Array System Toolbox
setdiff*	MATLAB
setfimath	Fixed-Point Designer
setxor*	MATLAB
sfi*	Fixed-Point Designer
sgolay	Signal Processing Toolbox
sgolayfilt	Signal Processing Toolbox
shiftdim*	MATLAB
shiftdim*	Fixed-Point Designer
shnidman*	Phased Array System Toolbox
sign	MATLAB
sign	Fixed-Point Designer
sin	MATLAB
sin	Fixed-Point Designer
sinc	Signal Processing Toolbox
sind	MATLAB
single	MATLAB
single*	Fixed-Point Designer
sinh	MATLAB
size	MATLAB
size	Fixed-Point Designer

Name	Product
skewness	Statistics and Machine Learning Toolbox
sort*	MATLAB
sort*	Fixed-Point Designer
sortrows*	MATLAB
sosfilt	Signal Processing Toolbox
scatteringchanmtx*	Phased Array System Toolbox
speed2dop*	Phased Array System Toolbox
sph2cart	MATLAB
sph2cartvec*	Phased Array System Toolbox
spline*	MATLAB
spsmooth*	Phased Array System Toolbox
squeeze*	MATLAB
squeeze	Fixed-Point Designer
sqrt*	MATLAB
sqrt*	Fixed-Point Designer
sqrtm	MATLAB
std*	MATLAB
steervec*	Phased Array System Toolbox
step*	MATLAB
stereoAnaglyph	Computer Vision System Toolbox
stereoParameters*	Computer Vision System Toolbox
stokes*	Phased Array System Toolbox
storedInteger	Fixed-Point Designer
storedIntegerToDouble	Fixed-Point Designer
str2double*	MATLAB
str2func*	MATLAB
strcmp*	MATLAB

<b>Name</b>	<b>Product</b>
strcmpi*	MATLAB
strel*	Image Processing Toolbox
stretchfreq2rng*	Phased Array System Toolbox
stretchlim*	Image Processing Toolbox
strfind*	MATLAB
strjoin*	MATLAB
strjust*	MATLAB
strncmp*	MATLAB
strncmpi*	MATLAB
strrep*	MATLAB
strtok*	MATLAB
strtrim*	MATLAB
struct*	MATLAB
struct2cell*	MATLAB
structfun*	MATLAB
sub*	Fixed-Point Designer
sub2ind*	MATLAB
subsasgn	Fixed-Point Designer
subspace	MATLAB
subsref	Fixed-Point Designer
sum*	MATLAB
sum*	Fixed-Point Designer
superpixels*	Image Processing Toolbox
surfacegamma*	Phased Array System Toolbox
surfclutterrcs*	Phased Array System Toolbox
SURFPoints*	Computer Vision System Toolbox
svd*	MATLAB
swapbytes*	MATLAB

Name	Product
switch, case, otherwise*	MATLAB
systemp*	Phased Array System Toolbox
tan	MATLAB
tand*	MATLAB
tanh	MATLAB
taylortaperc*	Phased Array System Toolbox
taylorwin*	Signal Processing Toolbox
tcdf	Statistics and Machine Learning Toolbox
tf2ca*	DSP System Toolbox
tf2cl*	DSP System Toolbox
tform2axang	Robotics System Toolbox
tform2eul	Robotics System Toolbox
tform2quat	Robotics System Toolbox
tform2rotm	Robotics System Toolbox
tform2trvec	Robotics System Toolbox
thselect*	Wavelet Toolbox
time2range*	Phased Array System Toolbox
times*	MATLAB
times*	Fixed-Point Designer
tinv	Statistics and Machine Learning Toolbox
toeplitz	MATLAB
tpdf	Statistics and Machine Learning Toolbox
trace	MATLAB
trackingEKF	Automated Driving System Toolbox
trackingKF	Automated Driving System Toolbox

<b>Name</b>	<b>Product</b>
trackingUKF	Automated Driving System Toolbox
transformScan	Robotics System Toolbox
transpose	MATLAB
transpose	Fixed-Point Designer
trapz*	MATLAB
triang*	Signal Processing Toolbox
triangulate*	Computer Vision System Toolbox
tril*	MATLAB
tril*	Fixed-Point Designer
triu*	MATLAB
triu*	Fixed-Point Designer
trnd*	Statistics and Machine Learning Toolbox
true*	MATLAB
trvec2tform	Robotics System Toolbox
tstat	Statistics and Machine Learning Toolbox
tukeywin*	Signal Processing Toolbox
typecast*	MATLAB
ufi*	Fixed-Point Designer
uint8, uint16, uint32, uint64	MATLAB
uint8, uint16, uint32, uint64	Fixed-Point Designer
uminus	MATLAB
uminus	Fixed-Point Designer
undistortImage*	Computer Vision System Toolbox
unidcdf	Statistics and Machine Learning Toolbox
unidinv	Statistics and Machine Learning Toolbox

Name	Product
unidpdf	Statistics and Machine Learning Toolbox
unidrnd*	Statistics and Machine Learning Toolbox
unidstat	Statistics and Machine Learning Toolbox
unifcdf	Statistics and Machine Learning Toolbox
unifinv	Statistics and Machine Learning Toolbox
unifpdf	Statistics and Machine Learning Toolbox
unifrnd*	Statistics and Machine Learning Toolbox
unifstat	Statistics and Machine Learning Toolbox
unigrid*	Phased Array System Toolbox
union*	MATLAB
unique*	MATLAB
unmkpp*	MATLAB
unscentedKalmanFilter*	Control System Toolbox
unscentedKalmanFilter*	System Identification Toolbox
unwrap*	MATLAB
upfirdn*	Signal Processing Toolbox
uplus	MATLAB
uplus	Fixed-Point Designer
upper*	MATLAB
upperbound	Fixed-Point Designer
upsample*	Signal Processing Toolbox
uv2azel*	Phased Array System Toolbox

<b>Name</b>	<b>Product</b>
uv2azelpat*	Phased Array System Toolbox
uv2phitheta*	Phased Array System Toolbox
uv2phithetapat*	Phased Array System Toolbox
val2ind*	Phased Array System Toolbox
vander	MATLAB
var*	MATLAB
vertcat	Fixed-Point Designer
vision.AlphaBlender*	Computer Vision System Toolbox
vision.Autocorrelator*	Computer Vision System Toolbox
vision.BlobAnalysis*	Computer Vision System Toolbox
vision.CascadeObjectDetector*	Computer Vision System Toolbox
vision.ChromaResampler*	Computer Vision System Toolbox
vision.Convolver*	Computer Vision System Toolbox
vision.Crosscorrelator*	Computer Vision System Toolbox
vision.DemosaicInterpolator*	Computer Vision System Toolbox
vision.DCT*	Computer Vision System Toolbox
vision.Deinterlacer*	Computer Vision System Toolbox
vision.DeployableVideoPlayer *	Computer Vision System Toolbox
vision.FFT*	Computer Vision System Toolbox
vision.ForegroundDetector*	Computer Vision System Toolbox
vision.GammaCorrector*	Computer Vision System Toolbox
vision.GeometricShearer*	Computer Vision System Toolbox
vision.HistogramBasedTracker*	Computer Vision System Toolbox
vision.HoughLines*	Computer Vision System Toolbox
vision.IDCT*	Computer Vision System Toolbox
vision.IFFT*	Computer Vision System Toolbox
vision.ImageDataTypeConverter*	Computer Vision System Toolbox
vision.KalmanFilter*	Computer Vision System Toolbox



Name	Product
vision.LocalMaximaFinder*	Computer Vision System Toolbox
vision.MarkerInserter*	Computer Vision System Toolbox
vision.Maximum*	Computer Vision System Toolbox
vision.Median*	Computer Vision System Toolbox
vision.Mean*	Computer Vision System Toolbox
vision.Minimum*	Computer Vision System Toolbox
vision.PeopleDetector*	Computer Vision System Toolbox
vision.PointTracker*	Computer Vision System Toolbox
vision.Pyramid*	Computer Vision System Toolbox
vision.ShapeInserter*	Computer Vision System Toolbox
vision.StandardDeviation*	Computer Vision System Toolbox
vision.TemplateMatcher*	Computer Vision System Toolbox
vision.Variance*	Computer Vision System Toolbox
vision.VideoFileReader*	Computer Vision System Toolbox
vision.VideoFileWriter*	Computer Vision System Toolbox
vitdec	Communications System Toolbox
waterfill*	Phased Array System Toolbox
watershed*	Image Processing Toolbox
wavedec*	Wavelet Toolbox
wavedec2*	Wavelet Toolbox
waverec*	Wavelet Toolbox
waverec2*	Wavelet Toolbox
wavetableSynthesizer*	Audio System Toolbox
wblcdf	Statistics and Machine Learning Toolbox
wblinv	Statistics and Machine Learning Toolbox

<b>Name</b>	<b>Product</b>
wblpdf	Statistics and Machine Learning Toolbox
wblrnd*	Statistics and Machine Learning Toolbox
wblstat	Statistics and Machine Learning Toolbox
wden*	Wavelet Toolbox
wdencmp*	Wavelet Toolbox
weightingFilter*	Audio System Toolbox
wextend*	Wavelet Toolbox
while	MATLAB
wilkinson*	MATLAB
wlanCoarseCFOEstimate*	WLAN System Toolbox™
wlanDMGConfig*	WLAN System Toolbox
wlanFieldIndices*	WLAN System Toolbox
wlanFineCFOEstimate*	WLAN System Toolbox
wlanFormatDetect*	WLAN System Toolbox
wlanHTConfig*	WLAN System Toolbox
wlanHTData*	WLAN System Toolbox
wlanHTDataRecover*	WLAN System Toolbox
wlanHTLTFChannelEstimate*	WLAN System Toolbox
wlanHTLTFDemodulate*	WLAN System Toolbox
wlanHTLTF*	WLAN System Toolbox
wlanHTSIG*	WLAN System Toolbox
wlanHTSIGRecover*	WLAN System Toolbox
wlanHTSTF*	WLAN System Toolbox
wlanLLTF*	WLAN System Toolbox
wlanLLTFChannelEstimate*	WLAN System Toolbox

Name	Product
wlanLLTFDemodulate*	WLAN System Toolbox
wlanLSIG*	WLAN System Toolbox
wlanLSIGRecover*	WLAN System Toolbox
wlanLSTF*	WLAN System Toolbox
wlanNonHTConfig*	WLAN System Toolbox
wlanNonHTData*	WLAN System Toolbox
wlanNonHTDataRecover*	WLAN System Toolbox
wlanPacketDetect*	WLAN System Toolbox
wlanRecoveryConfig*	WLAN System Toolbox
wlanSIGConfig*	WLAN System Toolbox
wlanSymbolTimingEstimate*	WLAN System Toolbox
wlanTGacChannel*	WLAN System Toolbox
wlanTGahChannel*	WLAN System Toolbox
wlanTGnChannel*	WLAN System Toolbox
wlanVHTConfig*	WLAN System Toolbox
wlanVHTData*	WLAN System Toolbox
wlanVHTDataRecover*	WLAN System Toolbox
wlanVHTLTF*	WLAN System Toolbox
wlanVHTLTFChannelEstimate*	WLAN System Toolbox
wlanVHTLTFDemodulate*	WLAN System Toolbox
wlanVHTSIGA*	WLAN System Toolbox
wlanVHTSIGAREcover*	WLAN System Toolbox
wlanVHTSIGBRecover*	WLAN System Toolbox
wlanVHTSIGB*	WLAN System Toolbox
wlanVHTSTF*	WLAN System Toolbox
wlanWaveformGenerator*	WLAN System Toolbox
wnoisest*	Wavelet Toolbox
wthcoef*	Wavelet Toolbox

<b>Name</b>	<b>Product</b>
wthcoef2*	Wavelet Toolbox
wthresh*	Wavelet Toolbox
xcorr*	Signal Processing Toolbox
xcorr2	Signal Processing Toolbox
xcov	Signal Processing Toolbox
xor	MATLAB
ycbcr2rgb*	Image Processing Toolbox
yulewalk*	Signal Processing Toolbox
zeros*	MATLAB
zp2tf	MATLAB
zscore	Statistics and Machine Learning Toolbox

## Functions and Objects Supported for C/C++ Code Generation — Category List

You can generate efficient C/C++ code for a subset of MATLAB built-in functions and toolbox functions, classes, and System objects that you call from MATLAB code. These functions, classes, and System objects are listed by MATLAB category or toolbox category in the following tables.

For an alphabetical list of supported functions, classes, and System objects, see “Functions and Objects Supported for C/C++ Code Generation — Alphabetical List” on page 44-2.

---

**Note:** For more information on code generation for fixed-point algorithms, refer to “Code Acceleration and Code Generation from MATLAB” (Fixed-Point Designer).

---

### In this section...

“Aerospace Toolbox” on page 44-69  
“Arithmetic Operations in MATLAB” on page 44-69  
“Audio System Toolbox” on page 44-70  
“Automated Driving System Toolbox” on page 44-71  
“Bit-Wise Operations MATLAB” on page 44-72  
“Casting in MATLAB” on page 44-73  
“Character Functions in MATLAB” on page 44-73  
“Communications System Toolbox” on page 44-74  
“Complex Numbers in MATLAB” on page 44-80  
“Computer Vision System Toolbox” on page 44-81  
“Control Flow in MATLAB” on page 44-85  
“Control System Toolbox” on page 44-85  
“Data and File Management in MATLAB” on page 44-85  
“Data Types in MATLAB” on page 44-86  
“Desktop Environment in MATLAB” on page 44-87  
“Discrete Math in MATLAB” on page 44-87

**In this section...**

- “DSP System Toolbox” on page 44-87
- “Error Handling in MATLAB” on page 44-93
- “Exponents in MATLAB” on page 44-93
- “Filtering and Convolution in MATLAB” on page 44-94
- “Fixed-Point Designer” on page 44-94
- “Histograms in MATLAB” on page 44-100
- “Image Acquisition Toolbox” on page 44-100
- “Image Processing in MATLAB” on page 44-101
- “Image Processing Toolbox” on page 44-101
- “Input and Output Arguments in MATLAB” on page 44-105
- “Interpolation and Computational Geometry in MATLAB” on page 44-105
- “Linear Algebra in MATLAB” on page 44-106
- “Logical and Bit-Wise Operations in MATLAB” on page 44-107
- “MATLAB Compiler” on page 44-107
- “Matrices and Arrays in MATLAB” on page 44-108
- “Neural Network Toolbox” on page 44-111
- “Numerical Integration and Differentiation in MATLAB” on page 44-111
- “Optimization Functions in MATLAB” on page 44-112
- “Optimization Toolbox” on page 44-112
- “Phased Array System Toolbox” on page 44-113
- “Polynomials in MATLAB” on page 44-119
- “Programming Utilities in MATLAB” on page 44-120
- “Relational Operators in MATLAB” on page 44-120
- “Robotics System Toolbox” on page 44-120
- “Rounding and Remainder Functions in MATLAB” on page 44-122
- “Set Operations in MATLAB” on page 44-122
- “Signal Processing in MATLAB” on page 44-123
- “Signal Processing Toolbox” on page 44-123
- “Special Values in MATLAB” on page 44-126

**In this section...**

“Specialized Math in MATLAB” on page 44-127

“Statistics in MATLAB” on page 44-127

“Statistics and Machine Learning Toolbox” on page 44-128

“System Identification Toolbox” on page 44-134

“System object Methods” on page 44-135

“Trigonometry in MATLAB” on page 44-135

“Wavelet Toolbox” on page 44-137

“WLAN System Toolbox” on page 44-138

## Aerospace Toolbox

C and C++ code generation for the following Aerospace Toolbox quaternion functions requires the Aerospace Blockset™ software.

An asterisk (\*) indicates that the reference page has usage notes and limitations for C/C++ code generation.

quatconj\*

quatdivide\*

quatinv\*

quatmod\*

quatmultiply\*

quatnorm\*

quatnormalize\*

## Arithmetic Operations in MATLAB

See “Array vs. Matrix Operations” (MATLAB) for detailed descriptions of the following operator equivalent functions.

An asterisk (\*) indicates that the reference page has usage notes and limitations for C/C++ code generation.

ctranspose

idivide*
isa
ldivide
minus
mldivide
mpower*
mrdivide
mtimes*
plus
power*
rdivide
times*
transpose
uminus
uplus

## Audio System Toolbox

C and C++ code generation for the following functions and System objects requires the Audio System Toolbox software.

An asterisk (\*) indicates that the reference page has usage notes and limitations for C/C++ code generation.

Name
<b>Audio I/O and Waveform Generation</b>
audioDeviceReader*
audioDeviceWriter*
audioPlayerRecorder*
wavetableSynthesizer*
audioOscillator*
<b>Audio Processing Algorithm Design</b>



<b>Name</b>
designVarSlopeFilter
designParamEQ
designShelvingEQ
integratedLoudness
crossoverFilter*
compressor*
expander*
noiseGate*
limiter*
multibandParametricEQ*
octaveFilter*
weightingFilter*
loudnessMeter*
reverberator*
<b>Audio Plugins</b>
audioPluginInterface
audioPluginParameter
audioPlugin
audioPluginSource

## Automated Driving System Toolbox

C and C++ code generation for the following functions and classes requires the Automated Driving System Toolbox software.

An asterisk (\*) indicates that the reference page has usage notes and limitations for C/C++ code generation.

cameas
cameasjac
constacc

constaccjac
constturn
constturnjac
constvel
constveljac
ctmeas
ctmeasjac
cvmeas
cvmeasjac
getTrackPositions
getTrackVelocities
initcaekf
initcakf
initcaukf
initctekf
initctukf
initcvekf
initcvkf
initcvukf
multiObjectTracker*
objectDetection
trackingEKF
trackingKF
trackingUKF

### **Bit-Wise Operations MATLAB**

An asterisk (\*) indicates that the reference page has usage notes and limitations for C/C++ code generation.

flintmax
----------

swapbytes*
------------

## Casting in MATLAB

An asterisk (\*) indicates that the reference page has usage notes and limitations for C/C++ code generation.

cast
------

char*
-------

class
-------

double
--------

int8, int16, int32, int64
---------------------------

logical
---------

single
--------

typecast*
-----------

uint8, uint16, uint32, uint64
-------------------------------

## Character Functions in MATLAB

An asterisk (\*) indicates that the reference page has usage notes and limitations for C/C++ code generation.

bin2dec*
----------

blanks
--------

char
------

deblank*
----------

dec2bin*
----------

dec2hex*
----------

hex2dec*
----------

hex2num*
----------

iscellstr
-----------

ischar
--------

isletter*
-----------

isspace*
isstrprop*
lower*
num2hex
str2double*
strcmp*
strncmpi*
strfind*
strjoin*
strjust*
strncmp*
strncmpi*
strrep*
strtok*
strtrim*
upper*

### **Communications System Toolbox**

C and C++ code generation for the following functions and System objects requires the Communications System Toolbox software.

An asterisk (\*) indicates that the reference page has usage notes and limitations for C/C++ code generation.

<b>Input and Output</b>
comm.BasebandFileReader*
comm.BasebandFileWriter*
comm.BarkerCode*
comm.GoldSequence*
comm.HadamardCode*
comm.KasamiSequence*

comm.RBDSWaveformGenerator*
comm.WalshCode*
comm.PNSequence*
lteZadoffChuSeq
<b>Signal and Delay Management</b>
bi2de
de2bi
<b>Display and Visual Analysis</b>
comm.ConstellationDiagram*
comm.EyeDiagram*
dsp.ArrayPlot*
dsp.SpectrumAnalyzer*
dsp.TimeScope*
<b>Source Coding</b>
comm.DifferentialDecoder*
comm.DifferentialEncoder*
<b>Cyclic Redundancy Check Coding</b>
comm.CRCDetector*
comm.CRCGenerator*
comm.HDLCRCDetector*
comm.HDLCRCGenerator*
<b>BCH Codes</b>
bchgenpoly*
comm.BCHDecoder*
comm.BCHEncoder*
<b>Reed-Solomon Codes</b>
comm.RSDecoder*
comm.RSEncoder*
comm.HDLRSDecoder*

comm.HDLRSEncoder*
rsgenpoly*
rsgenpolycoeffs*
<b>LDPC Codes</b>
comm.LDPCDecoder*
comm.LDPCEncoder*
dvbs2ldpc*
<b>Convolutional Coding</b>
comm.APPDecoder*
comm.ConvolutionalEncoder*
comm.TurboDecoder*
comm.TurboEncoder*
comm.ViterbiDecoder*
convenc
istrellis
oct2dec
poly2trellis
vitdec
<b>Signal Operations</b>
bin2gray
comm.Descrambler*
comm.Scrambler*
gray2bin
<b>Interleaving</b>
comm.AlgebraicDeinterleaver*
comm.AlgebraicInterleaver*
comm.BlockDeinterleaver*
comm.BlockInterleaver*
comm.ConvolutionalDeinterleaver*

comm.ConvolutionalInterleaver*
comm.HelicalDeinterleaver*
comm.HelicalInterleaver*
comm.MatrixDeinterleaver*
comm.MatrixInterleaver*
comm.MatrixHelicalScanDeinterleaver*
comm.MatrixHelicalScanInterleaver*
comm.MultiplexedDeinterleaver*
comm.MultiplexedInterleaver*
<b>Frequency Modulation</b>
comm.FSKDemodulator*
comm.FSKModulator*
<b>Phase Modulation</b>
comm.BPSKDemodulator*
comm.BPSKModulator*
comm.DBPSKDemodulator*
comm.DBPSKModulator*
comm.DPSKDemodulator*
comm.DPSKModulator*
comm.DQPSKDemodulator*
comm.DQPSKModulator*
comm.OQPSKDemodulator*
comm.OQPSKModulator*
comm.PSKDemodulator*
comm.PSKModulator*
comm.QPSKDemodulator*
comm.QPSKModulator*
dpskdemod
dpskmod

<b>Amplitude Modulation</b>
comm.GeneralQAMDemodulator*
comm.GeneralQAMModulator*
comm.PAMDemodulator*
comm.PAMModulator*
comm.RectangularQAMDemodulator*
comm.RectangularQAMModulator*
genqamdemod
qammod
qamdemod
<b>Continuous Phase Modulation</b>
comm.CPFSKDemodulator*
comm.CPFSKModulator*
comm.CPMDemodulator*
comm.CPMModulator*
comm.GMSKDemodulator*
comm.GMSKModulator*
comm.MSKDemodulator*
comm.MSKModulator*
<b>Trellis Coded Modulation</b>
comm.GeneralQAMTCMDemodulator*
comm.GeneralQAMTCMModulator*
comm.PSKTCMDemodulator*
comm.PSKTCMModulator*
comm.RectangularQAMTCMDemodulator*
comm.RectangularQAMTCMModulator*
<b>Orthogonal Frequency-Division Modulation</b>
comm.OFDMDemodulator*
comm.OFDMModulator*



<b>Analog Baseband Modulation</b>
comm.FMBroadcastDemodulator*
comm.FMBroadcastModulator*
comm.FMDemodulator*
comm.FMModulator*
<b>Filtering</b>
comm.IntegrateAndDumpFilter*
comm.RaisedCosineReceiveFilter*
comm.RaisedCosineTransmitFilter*
<b>Carrier Phase Synchronization</b>
comm.CarrierSynchronizer*
comm.CPMCarrierPhaseSynchronizer*
comm.CoarseFrequencyCompensator*
<b>Timing Phase Synchronization</b>
comm.SymbolSynchronizer*
comm.PreambleDetector*
comm.GMSKTimingSynchronizer*
comm.MSKTimingSynchronizer*
<b>Synchronization Utilities</b>
comm.DiscreteTimeVCO*
<b>Equalization</b>
comm.MLSEEqualizer*
<b>MIMO</b>
comm.LTEMIMOChannel*
comm.MIMOChannel*
comm.OSTBCCCombiner*
comm.OSTBCEncoder*
comm.SphereDecoder*
<b>Channel Modeling and RF Impairments</b>

comm.AGC*
comm.AWGNChannel*
comm.BinarySymmetricChannel*
comm.IQImbalanceCompensator*
comm.LTEMIMOChannel*
comm.MemorylessNonlinearity*
comm.MIMOChannel*
comm.PhaseFrequencyOffset*
comm.PhaseNoise*
comm.RayleighChannel*
comm.RicianChannel*
comm.ThermalNoise*
comm.PSKCoarseFrequencyEstimator*
comm.QAMCoarseFrequencyEstimator*
doppler*
iqcoef2imbal
iqimbal
iqimbal2coef
<b>Measurements and Analysis</b>
comm.ACPR*
comm.CCDF*
comm.ErrorRate*
comm.EVM*
comm.MER*

## Complex Numbers in MATLAB

An asterisk (\*) indicates that the reference page has usage notes and limitations for C/C++ code generation.

complex
---------

conj
cplxpair
imag
isnumeric
isreal
isscalar
real
unwrap*

## Computer Vision System Toolbox

C and C++ code generation for the following functions and System objects requires the Computer Vision System Toolbox software.

An asterisk (\*) indicates that the reference page has usage notes and limitations for C/C++ code generation.

Name
<b>Feature Detection, Extraction, and Matching</b>
BRISKPoints*
cornerPoints*
detectBRISKFeatures*
detectFASTFeatures*
detectHarrisFeatures*
detectMinEigenFeatures*
detectMSERFeatures*
detectSURFFeatures*
extractFeatures*
extractHOGFeatures*
extractLBPFeatures*
matchFeatures*
MSERRegions*

<b>Name</b>
SURFPoints*
<b>Image Registration and Geometric Transformations</b>
estimateGeometricTransform*
vision.GeometricShearer*
<b>Object Detection and Recognition</b>
ocr*
ocrText*
vision.PeopleDetector*
vision.CascadeObjectDetector*
<b>Tracking and Motion Estimation</b>
assignDetectionsToTracks
opticalFlowFarneback*
opticalFlowHS*
opticalFlowLKDoG*
opticalFlowLK*
vision.ForegroundDetector*
vision.HistogramBasedTracker*
vision.KalmanFilter*
vision.PointTracker*
vision.TemplateMatcher*
<b>Camera Calibration and Stereo Vision</b>
bboxOverlapRatio*
bbox2points
disparity*
cameraPoseToExtrinsics
cameraMatrix*
cameraPose*
cameraParameters*

<b>Name</b>
detectCheckerboardPoints*
epipolarline
estimateEssentialMatrix*
estimateFundamentalMatrix*
estimateUncalibratedRectification
estimateWorldCameraPose*
extrinsics*
extrinsicsToCameraPose
generateCheckerboardPoints*
isEpipoleInImage
lineToBorderPoints
reconstructScene*
rectifyStereoImages*
relativeCameraPose*
rotationMatrixToVector
rotationVectorToMatrix
selectStrongestBbox*
stereoAnaglyph
stereoParameters*
triangulate*
undistortImage*
<b>Statistics</b>
vision.Autocorrelator*
vision.BlobAnalysis*
vision.Crosscorrelator*
vision.LocalMaximaFinder*
vision.Maximum*
vision.Mean*

<b>Name</b>
vision.Median*
vision.Minimum*
vision.StandardDeviation*
vision.Variance*
<b>Filters, Transforms, and Enhancements</b>
integralImage
vision.Convolver*
vision.DCT*
vision.Deinterlacer*
vision.FFT*
vision.HoughLines*
vision.IDCT*
vision.IFFT*
vision.Pyramid*
<b>Video Loading, Saving, and Streaming</b>
vision.DeployableVideoPlayer*
vision.VideoFileReader*
vision.VideoFileWriter*
<b>Color Space Formatting and Conversions</b>
vision.ChromaResampler*
vision.DemosaicInterpolator*
vision.GammaCorrector*
<b>Graphics</b>
insertMarker*
insertShape*
insertObjectAnnotation*
insertText*
vision.AlphaBlender*

Name
vision.MarkerInserter*
vision.ShapeInserter*

## Control Flow in MATLAB

An asterisk (\*) indicates that the reference page has usage notes and limitations for C/C++ code generation.

break
continue
end
for
if, elseif, else
parfor*
return
switch, case, otherwise*
while

## Control System Toolbox

C and C++ code generation for the following functions requires the Control System Toolbox software.

An asterisk (\*) indicates that the reference page has usage notes and limitations for C/C++ code generation.

extendedKalmanFilter*
unscentedKalmanFilter*

## Data and File Management in MATLAB

An asterisk (\*) indicates that the reference page has usage notes and limitations for C/C++ code generation.

computer*
-----------

fclose
feof
fopen*
fprintf*
fread*
frewind
fseek*
ftell*
fwrite*
load*

### Data Types in MATLAB

An asterisk (\*) indicates that the reference page has usage notes and limitations for C/C++ code generation.

cell*
deal
fieldnames*
iscell
isenum
isfield*
ismethod
isobject
isstruct
narginchk
nargoutchk
str2func*
struct*
struct2cell*
structfun*



## Desktop Environment in MATLAB

An asterisk (\*) indicates that the reference page has usage notes and limitations for C/C++ code generation.

ismac*
ispc*
isunix*

## Discrete Math in MATLAB

An asterisk (\*) indicates that the reference page has usage notes and limitations for C/C++ code generation.

factor*
gcd
isprime*
lcm
nchoosek*
primes*

## DSP System Toolbox

C code generation for the following functions and System objects requires the DSP System Toolbox license. Many DSP System Toolbox functions require constant inputs for code generation.

An asterisk (\*) indicates that the reference page has usage notes and limitations for C/C++ code generation.

Name
<b>Estimation</b>
dsp.BurgAREstimator*
dsp.BurgSpectrumEstimator*
dsp.CepstralToLPC*
dsp.CrossSpectrumEstimator*

<b>Name</b>
dsp.LevinsonSolver*
dsp.LPCToAutocorrelation*
dsp.LPCToCepstral*
dsp.LPCToLSF*
dsp.LPCToLSP*
dsp.LPCToRC*
dsp.LSFToLPC*
dsp.LSPToLPC*
dsp.RCToAutocorrelation*
dsp.RCToLPC*
dsp.SpectrumEstimator*
dsp.TransferFunctionEstimator*
<b>Filters</b>
ca2tf*
c12tf*
dsp.AdaptiveLatticeFilter*
dsp.AffineProjectionFilter*
dsp.AllpassFilter*
dsp.AllpoleFilter*
dsp.BiquadFilter*
dsp.Channelizer*
dsp.ChannelSynthesizer*
dsp.CICCompensationDecimator*
dsp.CICCompensationInterpolator*
dsp.CICDecimator*
dsp.CICInterpolator*
dsp.Differentiator*
dsp.FarrowRateConverter*

<b>Name</b>
dsp.FastTransversalFilter*
dsp.FilterCascade*
dsp.FilteredXLMSFilter*
dsp.FIRDecimator*
dsp.FIRFilter*
dsp.FIRHalfbandDecimator*
dsp.FIRHalfbandInterpolator*
dsp.FIRInterpolator*
dsp.FIRRateConverter*
dsp.FrequencyDomainAdaptiveFilter*
dsp.HampelFilter*
dsp.HighpassFilter*
dsp.IIRFilter*
dsp.IIRHalfbandDecimator*
dsp.IIRHalfbandInterpolator*
dsp.KalmanFilter*
dsp.LMSFilter*
dsp.LowpassFilter*
dsp.MedianFilter*
dsp.RLSFilter*
dsp.SampleRateConverter*
dsp.SubbandAnalysisFilter*
dsp.SubbandSynthesisFilter*
dsp.VariableBandwidthFIRFilter*
dsp.VariableBandwidthIIRFilter*
firceqrip*
fireqint*
firgr*

<b>Name</b>
firhalfband*
firlpnorm*
firminphase*
firnyquist*
firpr2chfb*
ifir*
iircomb*
iingrpdelay*
iirlpnorm*
iirlpnormc*
iirnotch*
iirpeak*
tf2ca*
tf2cl*
<b>Filter Design</b>
designMultirateFIR*
<b>Math Operations</b>
dsp.ArrayVectorAdder*
dsp.ArrayVectorDivider*
dsp.ArrayVectorMultiplier*
dsp.ArrayVectorSubtractor*
dsp.CumulativeProduct *
dsp.CumulativeSum*
dsp.LDLFactor*
dsp.LevinsonSolver*
dsp.LowerTriangularSolver*
dsp.LUFactor*
dsp.Normalizer*

<b>Name</b>
dsp.UpperTriangularSolver*
<b>Quantizers</b>
dsp.ScalarQuantizerDecoder*
dsp.ScalarQuantizerEncoder*
dsp.VectorQuantizerDecoder*
dsp.VectorQuantizerEncoder*
<b>Scopes</b>
dsp.ArrayPlot*
dsp.SpectrumAnalyzer*
dsp.TimeScope*
<b>Signal Management</b>
dsp.AsyncBuffer*
dsp.Counter*
dsp.DelayLine*
<b>Signal Operations</b>
dsp.Convolver*
dsp.DCBlocker*
dsp.Delay*
dsp.DigitalDownConverter*
dsp.DigitalUpConverter*
dsp.Interpolator*
dsp.NCO*
dsp.PeakFinder*
dsp.PhaseExtractor*
dsp.PhaseUnwrapper*
dsp.VariableFractionalDelay*
dsp.VariableIntegerDelay*
dsp.Window*

<b>Name</b>
dsp.ZeroCrossingDetector*
<b>Sinks</b>
audioDeviceWriter*
dsp.AudioFileWriter*
dsp.BinaryFileWriter*
dsp.UDPSender*
<b>Sources</b>
dsp.AudioFileReader*
dsp.BinaryFileReader*
dsp.SignalSource*
dsp.SineWave*
dsp.UDPReceiver*
<b>Statistics</b>
dsp.Autocorrelator*
dsp.Crosscorrelator*
dsp.Histogram*
dsp.Maximum*
dsp.Mean*
dsp.Median*
dsp.MedianFilter*
dsp.Minimum*
dsp.MovingAverage*
dsp.MovingMaximum*
dsp.MovingMinimum*
dsp.MovingRMS*
dsp.MovingStandardDeviation*
dsp.MovingVariance*
dsp.PeakToPeak*

<b>Name</b>
dsp.PeakToRMS*
dsp.RMS*
dsp.StandardDeviation*
dsp.StateLevels*
dsp.Variance*
<b>Transforms</b>
dsp.AnalyticSignal*
dsp.DCT*
dsp.FFT*
dsp.IDCT*
dsp.IFFT*

## Error Handling in MATLAB

An asterisk (\*) indicates that the reference page has usage notes and limitations for C/C++ code generation.

assert*
error*

## Exponents in MATLAB

exp
expm
expm1
factorial
log*
log2
log10
log1p
nextpow2

nthroot
reallog
realpow
realsqrt
sqrt*

## Filtering and Convolution in MATLAB

An asterisk (\*) indicates that the reference page has usage notes and limitations for C/C++ code generation.

conv*
conv2
convn
deconv*
detrend*
filter*
filter2

## Fixed-Point Designer

The following general limitations apply to the use of Fixed-Point Designer functions in generated code, with `fiaccl`:

- `fipref` and `quantizer` objects are not supported.
- Word lengths greater than 128 bits are not supported.
- You cannot change the `fimath` or `numericType` of a given `fi` variable after that variable has been created.
- The boolean value of the `DataTypeMode` and `DataType` properties are not supported.
- For all `SumMode` property settings other than `FullPrecision`, the `CastBeforeSum` property must be set to `true`.
- You can use parallel for (`parfor`) loops in code compiled with `fiaccl`, but those loops are treated like regular `for` loops.



- When you compile code containing `fi` objects with nontrivial slope and bias scaling, you may see different results in generated code than you achieve by running the same code in MATLAB.
- The general limitations of C/C++ code generated from MATLAB apply. For more information, see “MATLAB Language Features Supported for C/C++ Code Generation” (MATLAB Coder).

An asterisk (\*) indicates that the reference page has usage notes and limitations for C/C++ code generation.

<code>abs</code>
<code>accumneg</code>
<code>accumpos</code>
<code>add*</code>
<code>all</code>
<code>any</code>
<code>atan2</code>
<code>bitand*</code>
<code>bitandreduce</code>
<code>bitcmp</code>
<code>bitconcat</code>
<code>bitget</code>
<code>bitor*</code>
<code>bitorreduce</code>
<code>bitreplicate</code>
<code>bitrol</code>
<code>bitror</code>
<code>bitset</code>
<code>bitshift</code>
<code>bitsliceget</code>
<code>bitsll*</code>
<code>bitsra*</code>

bitsrl*
bitxor*
bitxorreduce
ceil
complex
conj
conv*
convergent
cordicabs*
cordicangle*
cordicatan2*
cordiccart2pol*
cordicceexp*
cordicccos*
cordicpol2cart*
cordicrotate*
cordicsin*
cordicsincos*
cordicsqrt*
cos
ctranspose
diag*
divide*
double*
end
eps*
eq*
fi*

filter*
fimath*
fix
fixed.Quantizer
flip*
fliplr
flipud
floor
for
ge*
get*
getlsb
getmsb
gt*
horzcat
imag
int8, int16, int32, int64
ipermute
iscolumn
isempty
isequal
isfi*
isfimath
isfimathlocal
isfinite
isinf
isnan
isnumeric

isnumericitype
isreal
isrow
isscalar
issigned
isvector
le*
length
logical
lowerbound
lsb*
lt*
max
mean
median
min
minus*
mpower*
mpy*
mrdivide
mtimes*
ndims
ne*
nearest
numberofelements*
numel
numericitype*
permute*

plus*
pow2
power*
qr
quantize
range
rdivide
real
realmax
realmin
reinterpretpcast
removefimath
repmat*
rescale
reshape
rot90*
round
setfimath
sfi*
shiftdim*
sign
sin
single*
size
sort*
sqrt*
squeeze
storedInteger

storedIntegerToDouble
sub*
subsasgn
subsref
sum*
times*
transpose
tril*
triu*
ufi*
uint8, uint16, uint32, uint64
uminus
uplus
upperbound
vertcat

## Histograms in MATLAB

An asterisk (\*) indicates that the reference page has usage notes and limitations for C/C++ code generation.

hist*
histc*
histcounts*

## Image Acquisition Toolbox

If you install Image Acquisition Toolbox software, you can generate C and C++ code for the VideoDevice System object. See `imaq.VideoDevice` and “Code Generation with VideoDevice System Object” (Image Acquisition Toolbox).

## Image Processing in MATLAB

Function	Remarks and Limitations
im2double	—
rgb2gray	—

## Image Processing Toolbox

The following table lists the Image Processing Toolbox functions that have been enabled for code generation. You must have the MATLAB Coder software installed to generate C code from MATLAB for these functions.

Image Processing Toolbox provides three types of code generation support:

- Functions that generate C code.
- Functions that generate C code that depends on a platform-specific shared library (.dll, .so, or .dylib). Use of a shared library preserves performance optimizations in these functions, but this limits the target platforms for which you can generate code. For more information, see “Code Generation for Image Processing” (Image Processing Toolbox).
- Functions that generate C code or C code that depends on a shared library, depending on which target platform you specify in MATLAB Coder. If you specify the generic **MATLAB Host Computer** target platform, these functions generate C code that depends on a shared library. If you specify any other target platform, these functions generate C code.

In generated code, each supported toolbox function has the same name, arguments, and functionality as its Image Processing Toolbox counterpart. However, some functions have limitations. The following table includes information about code generation limitations that might exist for each function. In the following table, all the functions generate C code. The table identifies those functions that generate C code that depends on a shared library, and those functions that can do both, depending on which target platform you choose.

An asterisk (\*) indicates that the reference page has usage notes and limitations for C/C++ code generation.

adapthresh*
-------------

affine2d*
-----------

boundarymask*
bwareaopen*
bwboundaries*
bwconncomp*
bwdist*
bweuler*
bwlabel*
bwlookup*
bwmorph*
bwpack*
bwperim*
bwselect*
bwtraceboundary*
bwunpack*
conndef*
demosaic*
edge*
fitgeotrans*
fspecial*
getrangefromclass*
grayconnected*
histeq*
hough*
houghlines*
houghpeaks*
im2int16*
im2uint8*
im2uint16*



im2single*
im2double*
imabsdiff*
imadjust*
imbinarize*
imbothat*
imboxfilt*
imclearborder*
imclose*
imcomplement*
imcrop*
imdilate*
imerode*
imextendedmax*
imextendedmin*
imfill*
imfilter*
imfindcircles*
imgaborfilt*
imgaussfilt*
imgradient3*
imgradientxyz*
imhist*
imhmax*
imhmin*
imlincomb*
immse*
imopen*

<code>imoverlay*</code>
<code>impyramid*</code>
<code>imquantize*</code>
<code>imread*</code>
<code>imreconstruct*</code>
<code>imref2d*</code>
<code>imref3d*</code>
<code>imregionalmax*</code>
<code>imregionalmin*</code>
<code>imresize*</code>
<code>imrotate*</code>
<code>imtophat*</code>
<code>imtranslate*</code>
<code>imwarp*</code>
<code>integralBoxFilter*</code>
<code>intlut*</code>
<code>iptcheckconn*</code>
<code>iptcheckmap*</code>
<code>lab2rgb*</code>
<code>label2idx*</code>
<code>label2rgb*</code>
<code>mean2*</code>
<code>medfilt2*</code>
<code>multithresh*</code>
<code>offsetstrel*</code>
<code>ordfilt2*</code>
<code>otsuthresh*</code>
<code>padarray*</code>
<code>projective2d*</code>

psnr*
regionprops*
rgb2gray*
rgb2lab*
rgb2ycbcr*
strel*
stretchlim*
superpixels*
watershed*
ycbcr2rgb*

## Input and Output Arguments in MATLAB

Function	Remarks and Limitations
nargin*	—
nargout*	<ul style="list-style-type: none"> <li>For a function with no output arguments, returns 1 if called without a terminating semicolon.</li> </ul> <p><b>Note:</b> This behavior also affects extrinsic calls with no terminating semicolon. <code>nargout</code> is 1 for the called function in MATLAB.</p>

## Interpolation and Computational Geometry in MATLAB

An asterisk (\*) indicates that the reference page has usage notes and limitations for C/C++ code generation.

cart2pol
cart2sph
inpolygon*
interp1*

interp1q*
interp2*
interp3*
interp*
meshgrid
mkpp*
pchip*
pol2cart
polyarea
ppval*
rectint
sph2cart
spline*
unmkpp*

## Linear Algebra in MATLAB

An asterisk (\*) indicates that the reference page has usage notes and limitations for C/C++ code generation.

bandwidth
cholupdate
isbanded
isdiag
ishermitian
istril
istriu
issymmetric
linsolve*
lsqnonneg*

null*
orth*
rsf2csf
schur*
sqrtm

## Logical and Bit-Wise Operations in MATLAB

Function	Remarks and Limitations
and	—
bitand	—
bitcmp	—
bitget	—
bitor	—
bitset	—
bitshift	—
bitxor	—
not	—
or	—
xor	—

## MATLAB Compiler

C and C++ code generation for the following functions requires the MATLAB Compiler software.

An asterisk (\*) indicates that the reference page has usage notes and limitations for C/C++ code generation.

isdeployed*
ismcc*

## Matrices and Arrays in MATLAB

An asterisk (\*) indicates that the reference page has usage notes and limitations for C/C++ code generation.

abs
all*
angle
any*
blkdiag
bsxfun*
cat*
circshift
colon*
compan
cond
cov*
cross*
cumprod*
cumsum*
det
diag*
diff*
dot
eig*
eye*
false*
find*
flip*
flipdim*

fliplr*
flipud*
full
hadamard*
hankel
hilb
ind2sub*
inv*
invhilb
ipermute*
iscolumn
isempty
isequal
isequaln
isfinite
isfloat
isinf
isinteger
islogical
ismatrix
isnan
isrow
issparse
isvector
kron
length
linspace
logspace

lu
magic*
max*
min*
ndgrid
ndims
nnz
nonzeros
norm
normest
numel
ones*
pascal
permute*
pinv
planerot*
prod*
qr
rand*
randi*
randn*
randperm
rank
rcond
repelem*
repmat*
reshape*
rng*



rosser
rot90*
shiftdim*
sign
size
sort*
sortrows*
squeeze*
sub2ind*
subspace
sum*
toeplitz
trace
tril*
triu*
true*
vander
wilkinson*
zeros*

## Neural Network Toolbox

You can use `genFunction` in the Neural Network Toolbox™ to generate a standalone MATLAB function for a trained neural network. You can generate C/C++ code from this standalone MATLAB function. To generate Simulink blocks, use the `genSim` function. See “Deploy Trained Neural Network Functions” (Neural Network Toolbox).

## Numerical Integration and Differentiation in MATLAB

An asterisk (\*) indicates that the reference page has usage notes and limitations for C/C++ code generation.

cumtrapz
del2
diff
gradient
ode23*
ode45*
odeget*
odeset*
quad2d*
quadgk
trapz*

## Optimization Functions in MATLAB

An asterisk (\*) indicates that the reference page has usage notes and limitations for C/C++ code generation.

fminbnd*
fminsearch*
fzero*
lsqnonneg*
optimget*
optimset*

## Optimization Toolbox

C and C++ code generation for the following functions and System objects requires the Optimization Toolbox.

An asterisk (\*) indicates that the reference page has usage notes and limitations for C/C++ code generation.

fminbnd*
fminsearch*

fzero*
lsqnonneg*
optimget*
optimset*

## Phased Array System Toolbox

C and C++ code generation for the following functions and System objects requires the Phased Array System Toolbox software.

An asterisk (\*) indicates that the reference page has usage notes and limitations for C/C++ code generation.

<b>Antenna and Microphone Elements</b>
aperture2gain*
azel2phithetapat*
azel2uvpat*
circpol2pol*
gain2aperture*
phased.CosineAntennaElement*
phased.CrossedDipoleAntennaElement*
phased.CustomAntennaElement*
phased.CustomMicrophoneElement*
phased.IsotropicAntennaElement*
phased.IsotropicHydrophone*
phased.IsotropicProjector*
phased.OmnidirectionalMicrophoneElement*
phased.ShortDipoleAntennaElement*
phitheta2azelpat*
phitheta2uvpat*
pol2circpol*
polellip*

polloss*
polratio*
polsignature*
stokes*
uv2azelpat*
uv2phithetapat*
<b>Array Geometries and Analysis</b>
az2broadside*
broadside2az*
pilotcalib*
phased.ArrayGain*
phased.ArrayResponse*
phased.ConformalArray*
phased.ElementDelay*
phased.PartitionedArray*
phased.ReplicatedSubarray*
phased.SteeringVector*
phased.UCA*
phased.ULA*
phased.URA*
tayloraperc*
<b>Signal Radiation and Collection</b>
phased.Collector*
phased.Radiator*
phased.WidebandCollector*
phased.WidebandRadiator*
sensorsig*
<b>Transmitters and Receivers</b>
delayseq*

noisepow*
phased.ReceiverPreamp*
phased.Transmitter*
systemp*
<b>Waveform Design and Analysis</b>
ambgfun*
pambgfun*
phased.FMCWWaveform*
phased.LinearFMWaveform*
phased.MFSKWaveform*
phased.PhaseCodedWaveform*
phased.RectangularWaveform*
phased.SteppedFMWaveform*
range2bw*
range2time*
time2range*
unigrd*
<b>Beamforming</b>
cbfweights*
lcmvweights*
mvdrweights*
phased.FrostBeamformer*
phased.GSCBeamformer*
phased.LCMVBeamformer*
phased.MVDRBeamformer*
phased.PhaseShiftBeamformer*
phased.SteeringVector*
phased.SubbandMVDRBeamformer*
phased.SubbandPhaseShiftBeamformer*

phased.TimeDelayBeamformer*
phased.TimeDelayLCMVBeamformer*
sensorcov*
steervec*
<b>Direction of Arrival (DOA) Estimation</b>
aictest*
espritdoa*
gccphat*
mdltest*
musicdoa*
phased.BeamscanEstimator*
phased.BeamscanEstimator2D*
phased.BeamspaceESPRITEstimator*
phased.ESPRITEstimator*
phased.GCCEstimator*
phased.MUSICEstimator*
phased.MUSICEstimator2D*
phased.MVDREstimator*
phased.MVDREstimator2D*
phased.RootMUSICEstimator*
phased.RootWSFEstimator*
phased.SumDifferenceMonopulseTracker*
phased.SumDifferenceMonopulseTracker2D*
rootmusicdoa*
spsmooth*
<b>Space-Time Adaptive Processing (STAP)</b>
dopsteeringvec*
phased.ADPCACanceller*
phased.AngleDopplerResponse*

phased.DPCACanceller*
phased.STAPSMIBeamformer*
val2ind*
<b>Detection, Range, and Doppler Estimation</b>
albersheim*
beat2range*
bw2range*
dechirp*
npwgnthresh*
phased.CFARDetector*
phased.CFARDetector2D*
phased.DopplerEstimator*
phased.MatchedFilter*
phased.RangeDopplerResponse*
phased.RangeEstimator*
phased.RangeResponse*
phased.StretchProcessor*
phased.TimeVaryingGain*
pulsint*
radareqpow*
radareqrng*
radareqsnr*
radarvcd*
range2beat*
rdcoupling*
rocpfa*
rocsnr*
shnidman*
stretchfreq2rng*

<b>Targets, Interference, and Signal Propagation</b>
billingsleyicm*
depressionang*
diagbfweights*
effearthradius*
fspl*
fogpl*
gaspl*
grazingang*
horizonrange*
phased.BackscatterRadarTarget*
phased.BackScatterSonarTarget*
phased.BarrageJammer*
phased.ConstantGammaClutter*
phased.FreeSpace*
phased.IsoSpeedUnderWaterPaths*
phased.LOSChannel*
phased.MultipathChannel*
phased.RadarTarget*
phased.ScatteringMIMOChannel*
phased.TwoRayChannel*
phased.WidebandFreeSpace*
phased.WidebandBackscatterRadarTarget*
phased.WidebandLOSChannel*
phased.WidebandTwoRayChannel*
physconst*
scatteringchanmtx*
surfacegamma*
surfclutterrcs*



rainpl*
waterfill*
<b>Motion Modeling and Coordinate Systems</b>
azel2phitheta*
azel2uv*
azelaxes*
cart2sphvec*
dop2speed*
global2localcoord*
local2globalcoord*
phased.Platform*
phitheta2azel*
phitheta2uv*
radialspeed*
rangeangle*
rotx*
roty*
rotz*
speed2dop*
sph2cartvec*
uv2azel*
uv2phitheta*

## Polynomials in MATLAB

An asterisk (\*) indicates that the reference page has usage notes and limitations for C/C++ code generation.

poly*
polyder*
polyeig*

polyfit*
polyint
polyval
polyvalm
roots*

### Programming Utilities in MATLAB

Function	Remarks and Limitations
mfilename	—

### Relational Operators in MATLAB

An asterisk (\*) indicates that the reference page has usage notes and limitations for C/C++ code generation.

eq*
ge
gt
le
lt
ne*

### Robotics System Toolbox

C/C++ code generation for the following functions requires the Robotics System Toolbox software.

An asterisk (\*) indicates that the reference page has usage notes and limitations for C/C++ code generation.

Algorithm Design
robotics.AimingConstraint
robotics.BinaryOccupancyGrid*
robotics.Cartesianbounds

robotics.GeneralizedInverseKinematics*
robotics.InverseKinematics*
robotics.Joint
robotics.JointPositionBounds
robotics.OccupancyGrid*
robotics.OdometryMotionModel*
robotics.OrientationTarget
robotics.ParticleFilter*
robotics.PoseTarget
robotics.PositionTarget
robotics.PRM*
robotics.PurePursuit*
robotics.RigidBody
robotics.RigidBodyTree*
transformScan
robotics.VectorFieldHistogram*
<b>Coordinate System Transformations</b>
angdiff
axang2quat
axang2rotm
axang2tform
cart2hom
eul2quat
eul2rotm
eul2tform
hom2cart
quat2axang
quat2eul
quat2rotm

quat2tform
rotm2axang
rotm2eul
rotm2quat
rotm2tform
tform2axang
tform2eul
tform2quat
tform2rotm
tform2trvec
trvec2tform

## **Rounding and Remainder Functions in MATLAB**

An asterisk (\*) indicates that the reference page has usage notes and limitations for C/C++ code generation.

ceil
fix
floor
mod*
rem*
round*

## **Set Operations in MATLAB**

An asterisk (\*) indicates that the reference page has usage notes and limitations for C/C++ code generation.

intersect*
ismember*
issorted*
setdiff*

setxor*
union*
unique*

## Signal Processing in MATLAB

An asterisk (\*) indicates that the reference page has usage notes and limitations for C/C++ code generation.

chol
conv
fft*
fft2
fftn*
fftshift
filter
freqspace
ifft*
ifft2*
ifftn*
ifftshift
svd*
zp2tf

## Signal Processing Toolbox

C and C++ code generation for the following functions requires the Signal Processing Toolbox software. These functions do not support variable-size inputs, you must define the size and type of the function inputs. For more information, see “Specifying Inputs in Code Generation from MATLAB” (Signal Processing Toolbox).

---

**Note:** Many Signal Processing Toolbox functions require constant inputs in generated code. To specify a constant input for `codegen`, use `coder.Constant`.

---

An asterisk (\*) indicates that the reference page has usage notes and limitations for C/C++ code generation.

alignsignals
barthannwin*
bartlett*
besselap*
bitrevorder
blackman*
blackmanharris*
bohmanwin*
buttap*
butter*
buttord*
cconv
cfirpm*
cheb1ap*
cheb2ap*
cheb1ord*
cheb2ord*
chebwin*
cheby1*
cheby2*
convmtx
corrmtx
db2pow
dct*
downsample
dpss*
ellip*

ellipap*
ellipord*
envelope*
filtfilt*
finddelay
findpeaks
fir1*
fir2*
fircls*
fircls1*
firls*
firpm*
firpmord*
flattopwin*
freqz*
gausswin*
hamming*
hann*
hilbert
idct*
intfilt*
kaiser
kaiserord
levinson*
maxflat*
nutallwin*
parzenwin*
peak2peak

peak2rms
pow2db
rcosdesign*
rectwin*
resample*
rms
sgolay
sgolayfilt
sinc
sosfilt
taylorwin*
triang*
tukeywin*
upfirdn*
upsample*
xcorr*
xcorr2
xcov
yulewalk*
zp2tf*

### Special Values in MATLAB

An asterisk (\*) indicates that the reference page has usage notes and limitations for C/C++ code generation.

eps
inf*
intmax
intmin
NaN or nan*



pi
realmax
realmin

## Specialized Math in MATLAB

An asterisk (\*) indicates that the reference page has usage notes and limitations for C/C++ code generation.

airy*
besseli*
besselj*
beta
betainc*
betaincinv*
betaln
ellipke
erf
erfc
erfcinv
erfcx
erfinv
expint
gamma
gammainc*
gammaincinv*
gammaaln
psi

## Statistics in MATLAB

corrcoef*
-----------

cummin
cummax
mean*
median*
mode*
std*
var*

### Statistics and Machine Learning Toolbox

C and C++ code generation for the following functions requires the Statistics and Machine Learning Toolbox software.

An asterisk (\*) indicates that the reference page has usage notes and limitations for C/C++ code generation.

<b>Descriptive Statistics and Visualization</b>
geomean
harmmean
iqr
kurtosis
mad*
moment*
nancov*
nanmax
nanmean
nanmedian
nanmin
nanstd
nansum
nanvar
prctile*

quantile
skewness
zscore
<b>Probability Distributions</b>
betacdf
betafit
betainv
betalike
betapdf
betarnd*
betastat
binocdf
binoinv
binopdf
binornd*
binostat
cdf
chi2cdf
chi2inv
chi2pdf
chi2rnd*
chi2stat
evcdf
evinv
evpdf
evrnd*
evstat
expcdf

expinv
exppdf
exprnd*
expstat
fcdf
finv
fpdf
frnd*
fstat
gamcdf
gaminv
gampdf
gamrnd*
gamstat
geocdf
geoinv
geopdf
geornnd*
geostat
gevcdf
gevinv
gevpdf
gevrnd*
gevstat
gpcdf
gpinv
gppdf
gprnd*

gpstat
hygecdf
hygeinv
hygepdf
hygernd*
hygestat
icdf
logncdf
logninv
lognpdf
lognrnd*
lognstat
mnpdf
nbincdf
nbininv
nbinpdf
nbinrnd*
nbinstat
ncfcdf
ncfinv
ncfpdf
ncfrnd*
ncfstat
nctcdf
nctinv
nctpdf
nctrnd*
nctstat

ncx2cdf
ncx2rnd*
ncx2stat
normcdf
norminv
normpdf
normrnd*
normstat
pdf
pearsrnd*
poisscdf
poissinv
poisspdf
poissrnd*
poisstat
randg
random
randsample*
raylcdf
raylinv
raylpdf
raylrnd*
raylstat
tcdf
tin
tpdf
trnd*
tstat

unidcdf
unidinv
unidpdf
unidrnd*
unidstat
unifcdf
unifinv
unifpdf
unifrnd*
unifstat
wblcdf
wblinv
wblpdf
wblrnd*
wblstat
<b>Cluster Analysis</b>
kmeans*
<b>Regression</b>
GeneralizedLinearModel* or CompactGeneralizedLinearModel*
glmval*
LinearModel* or CompactLinearModel*
predict* method of GeneralizedLinearModel and CompactGeneralizedLinearModel
predict* method of LinearModel and CompactLinearModel
predict* method of RegressionTree or CompactRegressionTree
random* method of GeneralizedLinearModel and CompactGeneralizedLinearModel
random* method of LinearModel and CompactLinearModel
RegressionTree* or CompactRegressionTree*
<b>Classification</b>
loadCompactModel*

ClassificationECOC* or CompactClassificationECOC*
ClassificationEnsemble*, ClassificationBaggedEnsemble*, or CompactClassificationEnsemble*
ClassificationLinear*
ClassificationSVM* or CompactClassificationSVM*
ClassificationTree* or CompactClassificationTree*
predict* method of ClassificationECOC and CompactClassificationECOC
predict* method of ClassificationEnsemble, ClassificationBaggedEnsemble, and CompactClassificationEnsemble
predict* method of ClassificationLinear
predict* method of ClassificationSVM and CompactClassificationSVM
predict* method of ClassificationTree and CompactClassificationTree
<b>Dimensionality Reduction</b>
pca*

## System Identification Toolbox

C and C++ code generation for the following functions and System objects requires the System Identification Toolbox software.

An asterisk (\*) indicates that the reference page has usage notes and limitations for C/C++ code generation.

extendedKalmanFilter*
recursiveAR*
recursiveARMA*
recursiveARMAX*
recursiveARX*
recursiveBJ*
recursiveLS*
recursiveOE*
unscentedKalmanFilter*



## System object Methods

An asterisk (\*) indicates that the reference page has usage notes and limitations for C/C++ code generation.

getNumInputs*
getNumOutputs*
isLocked*
release*
reset*
step*

## Trigonometry in MATLAB

An asterisk (\*) indicates that the reference page has usage notes and limitations for C/C++ code generation.

acos*
acosd
acosh*
acot
acotd
acoth
acsc
acscd
acsch
asec
asecd
asech
asin*
asind
asinh

atan
atan2
atan2d
atand
atanh*
cos
cosd
cosh
cot
cotd*
coth
csc
cscd*
csch
deg2rad
hypot
rad2deg
sec
secd*
sech
sin
sind
sinh
tan
tand*
tanh

## Wavelet Toolbox

C and C++ code generation for the following functions requires the Wavelet Toolbox software.

An asterisk (\*) indicates that the reference page has usage notes and limitations for C/C++ code generation.

<b>Signal Analysis</b>
appcoef*
detcoef*
dwt*
dyadup*
idwt*
imodwpt*
imodwt*
modwpt*
modwptdetails*
modwt*
modwtmra*
wavedec*
waverec*
wextend*
<b>Image Analysis</b>
appcoef2*
detcoef2*
dwt2*
idwt2*
wavedec2*
waverec2*
<b>Denoising</b>

ddencmp*
thselect*
wden*
wdencmp*
wnoisest*
wthcoef*
wthcoef2*
wthresh*
<b>Orthogonal and Biorthogonal Filter Banks</b>
qmf*

## WLAN System Toolbox

C and C++ code generation for the following functions and System objects requires the WLAN System Toolbox software.

An asterisk (\*) indicates that the reference page has usage notes and limitations for C/C++ code generation.

<b>WLAN Modeling</b>
wlanHTConfig*
wlanNonHTConfig*
wlanRecoveryConfig*
wlanSIGConfig*
wlanVHTConfig*
<b>Signal Transmission</b>
wlanDMGConfig*
wlanHTData*
wlanHTLTF*
wlanHTSIG*
wlanHTSTF*
wlanLLTF*

wlanLSIG*
wlanLSTF*
wlanNonHTData*
wlanVHTData*
wlanVHTLTF*
wlanVHTSIGA*
wlanVHTSIGB*
wlanVHTSTF*
wlanWaveformGenerator*
<b>Signal Reception</b>
wlanCoarseCFOEstimate*
wlanFormatDetect*
wlanFieldIndices*
wlanFineCFOEstimate*
wlanHTDataRecover*
wlanHTLTFChannelEstimate*
wlanHTLTFDemodulate*
wlanHTSIGRecover*
wlanLLTFChannelEstimate*
wlanLLTFDemodulate*
wlanLSIGRecover*
wlanNonHTDataRecover*
wlanPacketDetect*
wlanSymbolTimingEstimate*
wlanVHTDataRecover*
wlanVHTLTFChannelEstimate*
wlanVHTLTFDemodulate*
wlanVHTSIGAREcover*

wlanVHTSIGBRecover*
---------------------

<b>Propagation Channel</b>
----------------------------

wlanTGacChannel*
------------------

wlanTGahChannel*
------------------

wlanTGnChannel*
-----------------

---

**Note:** WLAN System Toolbox functionality with the MATLAB Function block is not supported.

---

# System Objects Supported for Code Generation

---

## Code Generation for System Objects

You can generate C and C++ code for a subset of System objects provided by the following toolboxes.

Toolbox Name	See
Communications System Toolbox	“System Objects in MATLAB Code Generation” (MATLAB Coder)
Computer Vision System Toolbox	“System Objects in MATLAB Code Generation” (MATLAB Coder)
DSP System Toolbox	“System Objects in MATLAB Code Generation” (MATLAB Coder)
Image Acquisition Toolbox	<ul style="list-style-type: none"> <li>• <code>imaq.VideoDevice</code></li> <li>• “Code Generation with VideoDevice System Object” (Image Acquisition Toolbox)</li> </ul>
Phased Array System Toolbox	“Code Generation” (Phased Array System Toolbox)
System Identification Toolbox	“Generate Code for Online Parameter Estimation in MATLAB” (System Identification Toolbox)
WLAN System Toolbox	“System Objects in MATLAB Code Generation” (MATLAB Coder)

To use these System objects, you need to install the requisite toolbox. For a list of System objects supported for C and C++ code generation, see “Functions and Objects Supported for C/C++ Code Generation — Alphabetical List” on page 44-2 and “Functions and Objects Supported for C/C++ Code Generation — Category List” on page 44-67.

System objects are MATLAB object-oriented implementations of algorithms. They extend MATLAB by enabling you to model dynamic systems represented by time-varying algorithms. System objects are well integrated into the MATLAB language, regardless of whether you are writing simple functions, working interactively in the command window, or creating large applications.

In contrast to MATLAB functions, System objects automatically manage state information, data indexing, and buffering, which is particularly useful for iterative



computations or stream data processing. This enables efficient processing of long data sets. For general information about MATLAB objects, see “Object-Oriented Programming” (MATLAB).



# Defining MATLAB Variables for C/C++ Code Generation

---

- “Variables Definition for Code Generation” on page 46-2
- “Best Practices for Defining Variables for C/C++ Code Generation” on page 46-3
- “Eliminate Redundant Copies of Variables in Generated Code” on page 46-7
- “Reassignment of Variable Properties” on page 46-9
- “Reuse the Same Variable with Different Properties” on page 46-10
- “Avoid Overflows in for-Loops” on page 46-14
- “Supported Variable Types” on page 46-16

## Variables Definition for Code Generation

In the MATLAB language, variables can change their properties dynamically at run time so you can use the same variable to hold a value of any class, size, or complexity. For example, the following code works in MATLAB:

```
function x = foo(c) %#codegen
if(c>0)
    x = 0;
else
    x = [1 2 3];
end
disp(x);
end
```

However, statically-typed languages like C must be able to determine variable properties at compile time. Therefore, for C/C++ code generation, you must explicitly define the class, size, and complexity of variables in MATLAB source code before using them. For example, rewrite the above source code with a definition for *x*:

```
function x = foo(c) %#codegen
x = zeros(1,3);
if(c>0)
    x = 0;
else
    x = [1 2 3];
end
disp(x);
end
```

For more information, see “Best Practices for Defining Variables for C/C++ Code Generation” on page 46-3.

## Best Practices for Defining Variables for C/C++ Code Generation

### In this section...

“Define Variables By Assignment Before Using Them” on page 46-3

“Use Caution When Reassigning Variables” on page 46-5

“Use Type Cast Operators in Variable Definitions” on page 46-5

“Define Matrices Before Assigning Indexed Variables” on page 46-6

### Define Variables By Assignment Before Using Them

For C/C++ code generation, you should explicitly and unambiguously define the class, size, and complexity of variables before using them in operations or returning them as outputs. Define variables by assignment, but note that the assignment copies not only the value, but also the size, class, and complexity represented by that value to the new variable. For example:

Assignment:	Defines:
<code>a = 14.7;</code>	a as a real double scalar.
<code>b = a;</code>	b with properties of a (real double scalar).
<code>c = zeros(5,2);</code>	c as a real 5-by-2 array of doubles.
<code>d = [1 2 3 4 5; 6 7 8 9 0];</code>	d as a real 5-by-2 array of doubles.
<code>y = int16(3);</code>	y as a real 16-bit integer scalar.

Define properties this way so that the variable is defined on the required execution paths during C/C++ code generation (see Defining a Variable for Multiple Execution Paths).

The data that you assign to a variable can be a scalar, matrix, or structure. If your variable is a structure, define the properties of each field explicitly (see Defining Fields in a Structure).

Initializing the new variable to the value of the assigned data sometimes results in redundant copies in the generated code. To avoid redundant copies, you can define variables without initializing their values by using the `coder.nullcopy` construct as described in “Eliminate Redundant Copies of Variables in Generated Code” on page 46-7.

When you define variables, they are local by default; they do not persist between function calls. To make variables persistent, see `persistent`.

### Defining a Variable for Multiple Execution Paths

Consider the following MATLAB code:

```
...
if c > 0
    x = 11;
end
% Later in your code ...
if c > 0
    use(x);
end
...
```

Here,  $x$  is assigned only if  $c > 0$  and used only when  $c > 0$ . This code works in MATLAB, but generates a compilation error during code generation because it detects that  $x$  is undefined on some execution paths (when  $c \leq 0$ ),.

To make this code suitable for code generation, define  $x$  before using it:

```
x = 0;
...
if c > 0
    x = 11;
end
% Later in your code ...
if c > 0
    use(x);
end
...
```

### Defining Fields in a Structure

Consider the following MATLAB code:

```
...
if c > 0
    s.a = 11;
    disp(s);
else
    s.a = 12;
    s.b = 12;
end
```

```

end
% Try to use s
use(s);
...

```

Here, the first part of the `if` statement uses only the field `a`, and the `else` clause uses fields `a` and `b`. This code works in MATLAB, but generates a compilation error during C/C++ code generation because it detects a structure type mismatch. To prevent this error, do not add fields to a structure after you perform certain operations on the structure. For more information, see “Structure Definition for Code Generation” on page 49-2.

To make this code suitable for C/C++ code generation, define all fields of `s` before using it.

```

...
% Define all fields in structure s
s = struct('a',0, 'b', 0);
if c > 0
    s.a = 11;
    disp(s);
else
    s.a = 12;
    s.b = 12;
end
% Use s
use(s);
...

```

## Use Caution When Reassigning Variables

In general, you should adhere to the "one variable/one type" rule for C/C++ code generation; that is, each variable must have a specific class, size and complexity. Generally, if you reassign variable properties after the initial assignment, you get a compilation error during code generation, but there are exceptions, as described in “Reassignment of Variable Properties” on page 46-9.

## Use Type Cast Operators in Variable Definitions

By default, constants are of type `double`. To define variables of other types, you can use type cast operators in variable definitions. For example, the following code defines variable `y` as an integer:

```

...
x = 15; % x is of type double by default.

```

```
y = uint8(x); % y has the value of x, but cast to uint8.  
...
```

## Define Matrices Before Assigning Indexed Variables

When generating C/C++ code from MATLAB, you cannot grow a variable by writing into an element beyond its current size. Such indexing operations produce run-time errors. You must define the matrix first before assigning values to its elements.

For example, the following initial assignment is not allowed for code generation:

```
g(3,2) = 14.6; % Not allowed for creating g  
           % OK for assigning value once created
```

For more information about indexing matrices, see “Incompatibility with MATLAB in Matrix Indexing Operations for Code Generation” on page 48-23.



# Eliminate Redundant Copies of Variables in Generated Code

## In this section...

“When Redundant Copies Occur” on page 46-7

“How to Eliminate Redundant Copies by Defining Uninitialized Variables” on page 46-7

“Defining Uninitialized Variables” on page 46-8

## When Redundant Copies Occur

During C/C++ code generation, the code generator checks for statements that attempt to access uninitialized memory. If it detects execution paths where a variable is used but is potentially not defined, it generates a compile-time error. To prevent these errors, define variables by assignment before using them in operations or returning them as function outputs.

Note, however, that variable assignments not only copy the properties of the assigned data to the new variable, but also initialize the new variable to the assigned value. This forced initialization sometimes results in redundant copies in C/C++ code. To eliminate redundant copies, define uninitialized variables by using the `coder.nullcopy` function, as described in “How to Eliminate Redundant Copies by Defining Uninitialized Variables” on page 46-7.

## How to Eliminate Redundant Copies by Defining Uninitialized Variables

- 1 Define the variable with `coder.nullcopy`.
- 2 Initialize the variable before reading it.

When the uninitialized variable is an array, you must initialize all of its elements before passing the array as an input to a function or operator — even if the function or operator does not read from the uninitialized portion of the array.

### What happens if you access uninitialized data?

Uninitialized memory contains arbitrary values. Therefore, accessing uninitialized data may lead to segmentation violations or nondeterministic program behavior (different runs of the same program may yield inconsistent results).

## Defining Uninitialized Variables

In the following code, the assignment statement `X = zeros(1,N)` not only defines `X` to be a 1-by-5 vector of real doubles, but also initializes each element of `X` to zero.

```
function X = fcn %#codegen

N = 5;
X = zeros(1,N);
for i = 1:N
    if mod(i,2) == 0
        X(i) = i;
    else
        X(i) = 0;
    end
end
```

This forced initialization creates an extra copy in the generated code. To eliminate this overhead, use `coder.nullcopy` in the definition of `X`:

```
function X = fcn2 %#codegen

N = 5;
X = coder.nullcopy(zeros(1,N));
for i = 1:N
    if mod(i,2) == 0
        X(i) = i;
    else
        X(i) = 0;
    end
end
```

## Reassignment of Variable Properties

For C/C++ code generation, there are certain variables that you can reassign after the initial assignment with a value of different class, size, or complexity:

### **Dynamically sized variables**

A variable can hold values that have the same class and complexity but different sizes. If the size of the initial assignment is not constant, the variable is dynamically sized in generated code. For more information, see “Variable-Size Data”.

### **Variables reused in the code for different purposes**

You can reassign the type (class, size, and complexity) of a variable after the initial assignment if each occurrence of the variable can have only one type. In this case, the variable is renamed in the generated code to create multiple independent variables. For more information, see “Reuse the Same Variable with Different Properties” on page 46-10.

## Reuse the Same Variable with Different Properties

### In this section...

“When You Can Reuse the Same Variable with Different Properties” on page 46-10

“When You Cannot Reuse Variables” on page 46-10

“Limitations of Variable Reuse” on page 46-13

### When You Can Reuse the Same Variable with Different Properties

You can reuse (reassign) an input, output, or local variable with different class, size, or complexity if the code generator can unambiguously determine the properties of each occurrence of this variable during C/C++ code generation. If so, MATLAB creates separate uniquely named local variables in the generated code. You can view these renamed variables in the code generation report (see “MATLAB Code Variables in a Report” on page 40-52).

A common example of variable reuse is in `if-elseif-else` or `switch-case` statements. For example, the following function `example1` first uses the variable `t` in an `if` statement, where it holds a scalar double, then reuses `t` outside the `if` statement to hold a vector of doubles.

```
function y = example1(u) %#codegen
if all(all(u>0))
    % First, t is used to hold a scalar double value
    t = mean(mean(u)) / numel(u);
    u = u - t;
end
% t is reused to hold a vector of doubles
t = find(u > 0);
y = sum(u(t(2:end-1)));
```

To compile this example and see how MATLAB renames the reused variable `t`, see Variable Reuse in an `if` Statement.

### When You Cannot Reuse Variables

You cannot reuse (reassign) variables if it is not possible to determine the class, size, and complexity of an occurrence of a variable unambiguously during code generation. In this case, variables cannot be renamed and a compilation error occurs.

For example, the following `example2` function assigns a fixed-point value to `x` in the `if` statement and reuses `x` to store a matrix of doubles in the `else` clause. It then uses `x` after the `if-else` statement. This function generates a compilation error because after the `if-else` statement, variable `x` can have different properties depending on which `if-else` clause executes.

```
function y = example2(use_fixpoint, data) %#codegen
    if use_fixpoint
        % x is fixed-point
        x = fi(data, 1, 12, 3);
    else
        % x is a matrix of doubles
        x = data;
    end
    % When x is reused here, it is not possible to determine its
    % class, size, and complexity
    t = sum(sum(x));
    y = t > 0;
end
```

### Variable Reuse in an if Statement

To see how MATLAB renames a reused variable `t`:

- 1 Create a MATLAB file `example1.m` containing the following code.

```
function y = example1(u) %#codegen
    if all(all(u>0))
        % First, t is used to hold a scalar double value
        t = mean(mean(u)) / numel(u);
        u = u - t;
    end
    % t is reused to hold a vector of doubles
    t = find(u > 0);
    y = sum(u(t(2:end-1)));
end
```

- 2 Compile `example1`.

For example, to generate a MEX function, enter:

```
codegen -o example1x -report example1.m -args {ones(5,5)}
```

---

**Note:** `codegen` requires a MATLAB Coder license.

---

When the compilation is complete, `codegen` generates a MEX function, `example1x` in the current folder, and provides a link to the code generation report.

- 3 Open the code generation report.
- 4 In the MATLAB code pane of the code generation report, place your pointer over the variable `t` inside the `if` statement.

The code generation report highlights both instances of `t` in the `if` statement because they share the same class, size, and complexity. It displays the data type information for `t` at this point in the code. Here, `t` is a scalar double.

```
% First time t is used to hold a scalar double value.
t = mean(mean(u)) / numel(u);
u = u - t;
```

Information for the selected variable:	
Size	1 x 1
Complex	No
Class	double

- 5 In the MATLAB code pane of the report, place your pointer over the variable `t` outside the for-loop.

This time, the report highlights both instances of `t` outside the `if` statement. The report indicates that `t` might hold up to 25 doubles. The size of `t` is `:25`, that is, a column vector containing a maximum of 25 doubles.

```
t = find(u);
y = sum(u(t(2:end-1)));
```

Information for the selected variable:	
Size	:25
Complex	No
Class	double

- 6 Click the **Variables** tab to view the list of variables used in `example1`.

The report displays a list of the variables in `example1`. There are two uniquely named local variables `t>1` and `t>2`.

- 7 In the list of variables, place your pointer over `t>1`.

The code generation report highlights both instances of `t` in the `if` statement.

- 8 In the list of variables, place your pointer over `t>2`

The code generation report highlights both instances of `t` outside the `if` statement.

## Limitations of Variable Reuse

The following variables cannot be renamed in generated code:

- Persistent variables.
- Global variables.
- Variables passed to C code using `coder.ref`, `coder.rref`, `coder.wref`.
- Variables whose size is set using `coder.ysize`.
- Variables whose names are controlled using `coder.cstructname`.
- The index variable of a `for`-loop when it is used inside the loop body.
- The block outputs of a MATLAB Function block in a Simulink model.
- Chart-owned variables of a MATLAB function in a Stateflow chart.

## Avoid Overflows in for-Loops

When memory integrity checks are enabled, if the code generator detects that a loop variable might overflow on the last iteration of the `for`-loop, it reports an error.

To avoid this error, use the workarounds provided in the following table.

Loop conditions causing the error	Workaround
<ul style="list-style-type: none"> <li>The loop counter increments by 1</li> <li>The end value equals the maximum value of the integer type</li> <li>The loop is not covering the full range of the integer type</li> </ul>	<p>Rewrite the loop so that the end value is not equal to the maximum value of the integer type. For example, replace:</p> <pre>N=intmax('int16') for k=N-10:N</pre> <p>with:</p> <pre>for k=1:10</pre>
<ul style="list-style-type: none"> <li>The loop counter decrements by 1</li> <li>The end value equals the minimum value of the integer type</li> <li>The loop is not covering the full range of the integer type</li> </ul>	<p>Rewrite the loop so that the end value is not equal to the minimum value of the integer type. For example, replace:</p> <pre>N=intmin('int32') for k=N+10:-1:N</pre> <p>with:</p> <pre>for k=10:-1:1</pre>
<ul style="list-style-type: none"> <li>The loop counter increments or decrements by 1</li> <li>The start value equals the minimum or maximum value of the integer type</li> <li>The end value equals the maximum or minimum value of the integer type</li> </ul> <p>The loop covers the full range of the integer type.</p>	<p>Rewrite the loop casting the type of the loop counter start, step, and end values to a bigger integer or to double. For example, rewrite:</p> <pre>M= intmin('int16'); N= intmax('int16'); for k=M:N % Loop body end to  M= intmin('int16'); N= intmax('int16'); for k=int32(M):int32(N) % Loop body</pre>



Loop conditions causing the error	Workaround
<ul style="list-style-type: none"><li>• The loop counter increments or decrements by a value not equal to 1</li><li>• On last loop iteration, the loop variable value is not equal to the end value</li></ul>	end  Rewrite the loop so that the loop variable on the last loop iteration is equal to the end value.
<b>Note:</b> The software error checking is conservative. It may incorrectly report a loop as being potentially infinite.	

## Supported Variable Types

You can use the following data types for C/C++ code generation from MATLAB:

Type	Description
char	Character array
complex	Complex data. Cast function takes real and imaginary components
double	Double-precision floating point
int8, int16, int32, int64	Signed integer
logical	Boolean true or false
single	Single-precision floating point
struct	Structure
uint8, uint16, uint32, uint64	Unsigned integer
Fixed-point	See “Fixed-Point Data Types” (Fixed-Point Designer).

# Defining Data for Code Generation

---

- “Data Definition for Code Generation” on page 47-2
- “Code Generation for Complex Data” on page 47-4
- “Code Generation for Character Arrays” on page 47-8
- “Array Size Restrictions for Code Generation” on page 47-9
- “Code Generation for Constants in Structures and Arrays” on page 47-10

## Data Definition for Code Generation

To generate efficient standalone code, you must define the following types and classes of data differently than you normally would when running your code in MATLAB.

Data	What's Different	More Information
Arrays	Maximum number of elements is restricted	“Array Size Restrictions for Code Generation” on page 47-9
Complex numbers	<ul style="list-style-type: none"> <li>Complexity of variables must be set at time of assignment and before first use</li> <li>Expressions containing a complex number or variable evaluate to a complex result, even if the result is zero</li> </ul> <p><b>Note:</b> Because MATLAB does not support complex integer arithmetic, you cannot generate code for functions that use complex integer arithmetic</p>	“Code Generation for Complex Data” on page 47-4
Characters	Restricted to 8 bits of precision	“Code Generation for Character Arrays” on page 47-8
Enumerated data	<ul style="list-style-type: none"> <li>Supports integer-based enumerated types only</li> <li>Restricted use in <code>switch</code> statements and <code>for</code>-loops</li> </ul>	“Enumerations”
Function handles	<ul style="list-style-type: none"> <li>Using the same bound variable to reference different function</li> </ul>	“Function Handles”

Data	What's Different	More Information
	<p>handles can cause a compile-time error.</p> <ul style="list-style-type: none"><li>• Cannot pass function handles to or from primary or extrinsic functions</li><li>• Cannot view function handles from the debugger</li></ul>	

## Code Generation for Complex Data

### In this section...

“Restrictions When Defining Complex Variables” on page 47-4

“Code Generation for Complex Data with Zero-Valued Imaginary Parts” on page 47-4

“Results of Expressions That Have Complex Operands” on page 47-7

### Restrictions When Defining Complex Variables

For code generation, you must set the complexity of variables at the time of assignment. Assign a complex constant to the variable or use the `complex` function. For example:

```
x = 5 + 6i; % x is a complex number by assignment.
y = complex(5,6); % y is the complex number 5 + 6i.
```

After assignment, you cannot change the complexity of a variable. Code generation for the following function fails because  $x(k) = 3 + 4i$  changes the complexity of  $x$ .

```
function x = test1( )
x = zeros(3,3); % x is real
for k = 1:numel(x)
    x(k) = 3 + 4i;
end
end
```

To resolve this issue, assign a complex constant to  $x$ .

```
function x = test1( )
x = zeros(3,3)+ 0i; %x is complex
for k = 1:numel(x)
    x(k) = 3 + 4i;
end
end
```

### Code Generation for Complex Data with Zero-Valued Imaginary Parts

For code generation, complex data that has all zero-valued imaginary parts remains complex. This data does not become real. This behavior has the following implications:

- In some cases, results from functions that sort complex data by absolute value can differ from the MATLAB results. See “Functions That Sort Complex Values by Absolute Value” on page 47-5.
- For functions that require that complex inputs are sorted by absolute value, complex inputs with zero-valued imaginary parts must be sorted by absolute value. These functions include `ismember`, `union`, `intersect`, `setdiff`, and `setxor`.

### Functions That Sort Complex Values by Absolute Value

Functions that sort complex values by absolute value include `sort`, `issorted`, `sortrows`, `median`, `min`, and `max`. These functions sort complex numbers by absolute value even when the imaginary parts are zero. In general, sorting the absolute values produces a different result than sorting the real parts. Therefore, when inputs to these functions are complex with zero-valued imaginary parts in generated code, but real in MATLAB, the generated code can produce different results than MATLAB. In the following examples, the input to `sort` is real in MATLAB, but complex with zero-valued imaginary parts in the generated code:

- **You Pass Real Inputs to a Function Generated for Complex Inputs**

- 1 Write this function:

```
function myout = mysort(A)
myout = sort(A);
end
```

- 2 Call `mysort` in MATLAB.

```
A = -2:2;
mysort(A)

ans =

    -2    -1     0     1     2
```

- 3 Generate a MEX function for complex inputs.

```
A = -2:2;
codegen mysort -args {complex(A)} -report
```

- 4 Call the MEX Function with real inputs.

```
mysort_mex(A)

ans =
```

```
0    1    -1    2    -2
```

You generated the MEX function for complex inputs, therefore, it treats the real inputs as complex numbers with zero-valued imaginary parts. It sorts the numbers by the absolute values of the complex numbers. Because the imaginary parts are zero, the MEX function returns the results to the MATLAB workspace as real numbers.

- **Input to `sort` Is Output from a Function That Returns Complex in Generated Code**

- 1 Write this function:

```
function y = myfun(A)
x = eig(A);
y = sort(x, 'descend');
```

The output from `eig` is the input to `sort`. In generated code, `eig` returns a complex result. Therefore, in the generated code, `x` is complex.

- 2 Call `myfun` in MATLAB.

```
A = [2 3 5;0 5 5;6 7 4];
myfun(A)
```

```
ans =
```

```
12.5777
 2.0000
-3.5777
```

The result of `eig` is real. Therefore, the inputs to `sort` are real.

- 3 Generate a MEX function for complex inputs.

```
codegen myfun -args {complex(A)}
```

- 4 Call the MEX function.

```
myfun_mex(A)
```

```
ans =
```

```
12.5777
-3.5777
 2.0000
```



In the MEX function, `eig` returns a complex result. Therefore, the inputs to `sort` are complex. The MEX function sorts the inputs in descending order of the absolute values.

## Results of Expressions That Have Complex Operands

In general, expressions that contain one or more complex operands produce a complex result in generated code, even if the value of the result is zero. Consider the following line of code:

```
z = x + y;
```

Suppose that at run time, `x` has the value  $2 + 3i$  and `y` has the value  $2 - 3i$ . In MATLAB, this code produces the real result  $z = 4$ . During code generation, the types for `x` and `y` are known, but their values are not known. Because either or both operands in this expression are complex, `z` is defined as a complex variable requiring storage for a real and an imaginary part. `z` equals the complex result  $4 + 0i$  in generated code, not  $4$ , as in MATLAB code.

Exceptions to this behavior are:

- Functions that take complex arguments but produce real results return real values.

```
y = real(x); % y is the real part of the complex number x.  
y = imag(x); % y is the real-valued imaginary part of x.  
y = isreal(x); % y is false (0) for a complex number x.
```

- Functions that take real arguments but produce complex results return complex values.

```
z = complex(x,y); % z is a complex number for a real x and y.
```

## Code Generation for Character Arrays

The code generator translates the 16-bit Unicode encoding of a character in MATLAB to an 8-bit encoding that the locale setting determines. The code generator does not support characters that require more than 1 byte in MATLAB. This restriction applies to character arrays that are passed between MATLAB and the code generator. For example, the restriction applies to entry-point function inputs and to outputs from extrinsic calls. For code generation, some MATLAB functions accept only 7-bit ASCII characters. See “Functions and Objects Supported for C/C++ Code Generation — Alphabetical List” on page 44-2.

If a character is not in the 7-bit ASCII codeset, casting the character to a numeric type, such as double, produces a different result in the generated code than in MATLAB. A best practice for code generation is to avoid performing arithmetic with characters.

### More About

- “Locale Settings for MATLAB Process” (MATLAB)

## Array Size Restrictions for Code Generation

For code generation, the maximum number of elements of an array is constrained by the code generator and the target hardware. The maximum number of elements is the smaller of:

- `intmax('int32')`.
- The largest integer that fits in the C `int` data type on the target hardware.

These restrictions apply even on a 64-bit platform.

For a fixed-size array, if the number of elements exceeds the maximum, the code generator reports an error at compile time. For a variable-size array, if the number of elements exceeds the maximum during simulation, the software reports an error. Generated standalone code cannot report array size violations.

### See Also

- “Variable-Size Data”

## Code Generation for Constants in Structures and Arrays

The code generator does not recognize constant structure fields or array elements in the following cases:

### Fields or elements are assigned inside control constructs

In the following code, the code generator recognizes that the structure fields `s.a` and `s.b` are constants.

```
function y = mystruct()  
s.a = 3;  
s.b = 5;  
y = zeros(s.a,s.b);
```

If any structure field is assigned inside a control construct, the code generator does not recognize the constant fields. This limitation also applies to arrays with constant elements. Consider the following code:

```
function y = mystruct(x)  
s.a = 3;  
if x > 1  
    s.b = 4;  
else  
    s.b = 5;  
end  
y = zeros(s.a,s.b);
```

The code generator does not recognize that `s.a` and `s.b` are constant. If variable-sizing is enabled, `y` is treated as a variable-size array. If variable-sizing is disabled, the code generator reports an error.

### Constants are assigned to array elements using non-scalar indexing

In the following code, the code generator recognizes that `a(1)` is constant.

```
function y = myarray()  
a = zeros(1,3);  
a(1) = 20;  
y = coder.const(a(1));
```

In the following code, because `a(1)` is assigned using non-scalar indexing, the code generator does not recognize that `a(1)` is constant.

```
function y = myarray()  
a = zeros(1,3);  
a(1:2) = 20;  
y = coder.const(a(1));
```

### **A function returns a structure or array that has constant and nonconstant elements**

For an output structure that has both constant and nonconstant fields, the code generator does not recognize the constant fields. This limitation also applies to arrays that have constant and nonconstant elements. Consider the following code:

```
function y = mystruct_out(x)  
s = create_structure(x);  
y = coder.const(s.a);  
  
function s = create_structure(x)  
s.a = 10;  
s.b = x;
```

Because `create_structure` returns a structure `s` that has one constant field and one nonconstant field, the code generator does not recognize that `s.a` is constant. The `coder.const` call fails because `s.a` is not constant.



# Code Generation for Variable-Size Data

---

- “Code Generation for Variable-Size Arrays” on page 48-2
- “Specify Upper Bounds for Variable-Size Arrays” on page 48-5
- “Define Variable-Size Data for Code Generation” on page 48-7
- “Diagnose and Fix Variable-Size Data Errors” on page 48-13
- “Incompatibilities with MATLAB in Variable-Size Support for Code Generation” on page 48-17
- “Variable-Sizing Restrictions for Code Generation of Toolbox Functions” on page 48-26

## Code Generation for Variable-Size Arrays

For code generation, an array dimension is *fixed-size* or *variable-size*. If the code generator can determine the size of the dimension and that the size of the dimension does not change, then the dimension is fixed-size. When all dimensions of an array are fixed-size, the array is a *fixed-size* array. In the following example, Z is a fixed-size array.

```
function Z = myfcn()  
Z = zeros(1,4);  
end
```

The size of the first dimension is 1 and the size of the second dimension is 4.

If the code generator cannot determine the size of a dimension or the code generator determines that the size changes, then the dimension is variable-size. When at least one of its dimensions is variable-size, an array is a *variable-size* array.

A variable-size dimension is either *bounded* or *unbounded*. A bounded dimension has a fixed upper size. An unbounded dimension does not have a fixed upper size.

In the following example, the second dimension of Z is bounded, variable-size. It has an upper bound of 16.

```
function s = myfcn(n)  
if (n > 0)  
    Z = zeros(1,4);  
else  
    Z = zeros(1,16);  
end  
s = length(Z);
```

In the following example, if the value of n is unknown at compile time, then the second dimension of Z is unbounded.

```
function s = myfcn(n)  
Z = rand(1,n);  
s = sum(Z);  
end
```

You can define variable-size arrays by:

- Using constructors, such as `zeros`, with a nonconstant dimension
- Assigning multiple, constant sizes to the same variable before using it



- Declaring all instances of a variable to be variable-size by using `coder.varsizes`

For more information, see “Define Variable-Size Data for Code Generation” on page 48-7.

You can control whether variable-size arrays are allowed for code generation. See “Enabling and Disabling Support for Variable-Size Arrays” on page 48-3.

## Memory Allocation for Variable-Size Arrays

For fixed-size arrays and variable-size arrays whose size is less than a threshold, the code generator allocates memory statically on the stack. For unbounded, variable-size arrays and variable-size arrays whose size is greater than or equal to a threshold, the code generator allocates memory dynamically on the heap.

For a MATLAB Function block, you cannot use dynamic memory allocation for:

- Input and output signals. Variable-size input and output signals must have an upper bound.
- Parameters or global variables. Parameters and global variables must be fixed-size.
- Fields of bus arrays. Bus arrays cannot have variable-size fields.

You can control whether dynamic memory allocation is allowed or when it is used for code generation. See “Control Memory Allocation for Variable-Size Arrays in a MATLAB Function Block” on page 40-102.

The code generator represents dynamically allocated data as a structure type called `emxArray`. The code generator generates utility functions that create and interact with `emxArrays`. If you use Embedded Coder, you can customize the generated identifiers for the `emxArray` types and utility functions. See “Identifier Format Control” (Embedded Coder).

## Enabling and Disabling Support for Variable-Size Arrays

By default, for MATLAB Function blocks, support for variable-size arrays is enabled. To disable this support:

- 1 In the MATLAB Function Block Editor, select **Edit Data**.
- 2 Clear the **Support variable-size arrays** check box.

## Variable-Size Arrays in a MATLAB Function Report

You can tell whether an array is fixed-size or variable-size by looking at the **Size** column of the **Variables** tab in a MATLAB Function Report.

Variable	Type	Size
y	Output	1 x 1
n	Input	1 x 1
x	Local	1 x :?

A colon (:) indicates that a dimension is variable-size. A question mark (?) indicates that the size is unbounded. For example, a size of 2-by-:? indicates that the size of the first dimension is fixed-size 2 and the size of the second dimension is unbounded, variable-size. An asterisk (\*) indicates that your code specifies that an array is variable-size, but the code generator determined that it does not change size.

Variable	Type	Size
y	Output	1 x 2
n	Input	1 x 1
Z	Local	1 x 4 *

### More About

- “Control Memory Allocation for Variable-Size Arrays in a MATLAB Function Block” on page 40-102
- “Specify Upper Bounds for Variable-Size Arrays” on page 48-5
- “Define Variable-Size Data for Code Generation” on page 48-7
- “Use Dynamic Memory Allocation for Variable-Size Arrays in a MATLAB Function Block” on page 40-104

## Specify Upper Bounds for Variable-Size Arrays

Specify upper bounds for an array when:

- Dynamic memory allocation is disabled.

If dynamic memory allocation is disabled, you must specify upper bounds for all arrays.

- You do not want the code generator to use dynamic memory allocation for the array.

Specify upper bounds that result in an array size (in bytes) that is less than the dynamic memory allocation threshold.

## Specify Upper Bounds for MATLAB Function Block Inputs and Outputs

See “Declare Variable-Size Inputs and Outputs” on page 40-93.

## Specify Upper Bounds for Local Variables

When using static allocation, the code generator uses a sophisticated analysis to calculate the upper bounds of local data. However, when the analysis fails to detect an upper bound or calculates an upper bound that is not precise enough for your application, you must specify upper bounds explicitly for local variables.

### Constrain the Value of Variables That Specify the Dimensions of Variable-Size Arrays

To constrain the value of variables that specify the dimensions of variable-size arrays, use the `assert` function with relational operators. For example:

```
function y = dim_need_bound(n) %#codegen
assert (n <= 5);
L = ones(n,n);
M = zeros(n,n);
M = [L; M];
y = M;
```

This `assert` statement constrains input `n` to a maximum size of 5. `L` is variable-size with upper bounds of 5 in each dimension. `M` is variable-size with an upper bound of 10 in the first dimension and 5 in the second dimension.

### Specify the Upper Bounds for All Instances of a Local Variable

To specify the upper bounds for all instances of a local variable in a function, use the `coder.versize` function. For example:

```
function Y = example_bounds1(u) %#codegen
Y = [1 2 3 4 5];
coder.versize('Y',[1 10]);
if (u > 0)
    Y = [Y Y+u];
else
    Y = [Y Y*u];
end
```

The second argument of `coder.versize` specifies the upper bound for each instance of the variable specified in the first argument. In this example, the argument `[1 10]` indicates that for every instance of `Y`:

- The first dimension is fixed at size 1.
- The second dimension can grow to an upper bound of 10.

### See Also

`coder.versize`

### More About

- “Code Generation for Variable-Size Arrays” on page 48-2
- “Define Variable-Size Data for Code Generation” on page 48-7

## Define Variable-Size Data for Code Generation

For code generation, before using variables in operations or returning them as outputs, you must assign them a specific class, size, and complexity. Generally, after the initial assignment, you cannot reassign variable properties. Therefore, after assigning a fixed size to a variable or structure field, attempts to grow the variable or structure field might cause a compilation error. In these cases, you must explicitly define the data as variable-size by using one of these methods.

Method	See
Assign the data from a variable-size matrix constructor such as: <ul style="list-style-type: none"> <li>• ones</li> <li>• zeros</li> <li>• repmat</li> </ul>	“Use a Matrix Constructor with Nonconstant Dimensions” on page 48-7
Assign multiple, constant sizes to the same variable before using (reading) the variable.	“Assign Multiple Sizes to the Same Variable” on page 48-8
Define all instances of a variable to be variable-size.	“Define Variable-Size Data Explicitly by Using <code>coder.varsize</code> ” on page 48-8

### Use a Matrix Constructor with Nonconstant Dimensions

You can define a variable-size matrix by using a constructor with nonconstant dimensions. For example:

```
function s = var_by_assign(u) %#codegen
y = ones(3,u);
s = numel(y);
```

If you are not using dynamic memory allocation, you must also add an `assert` statement to provide upper bounds for the dimensions. For example:

```
function s = var_by_assign(u) %#codegen
assert (u < 20);
y = ones(3,u);
s = numel(y);
```

## Assign Multiple Sizes to the Same Variable

Before you use (read) a variable in your code, you can make it variable-size by assigning multiple, constant sizes to it. When the code generator uses static allocation on the stack, it infers the upper bounds from the largest size specified for each dimension. When you assign the same size to a given dimension across all assignments, the code generator assumes that the dimension is fixed at that size. The assignments can specify different shapes and sizes.

When the code generator uses dynamic memory allocation, it does not check for upper bounds. It assumes that the variable-size data is unbounded.

### Inferring Upper Bounds from Multiple Definitions with Different Shapes

```
function s = var_by_multiassign(u) %#codegen
if (u > 0)
    y = ones(3,4,5);
else
    y = zeros(3,1);
end
s = numel(y);
```

When the code generator uses static allocation, it infers that `y` is a matrix with three dimensions:

- The first dimension is fixed at size 3
- The second dimension is variable-size with an upper bound of 4
- The third dimension is variable-size with an upper bound of 5

When the code generator uses dynamic allocation, it analyzes the dimensions of `y` differently:

- The first dimension is fixed at size 3.
- The second and third dimensions are unbounded.

## Define Variable-Size Data Explicitly by Using `coder.varsize`

To explicitly define variable-size data, use the function `coder.varsize`. Optionally, you can also specify which dimensions vary along with their upper bounds. For example:

- Define `B` as a variable-size 2-dimensional array, where each dimension has an upper bound of 64.

```
coder.varsize('B', [64 64]);
```

- Define **B** as a variable-size array:

```
coder.varsize('B');
```

When you supply only the first argument, `coder.varsize` assumes that all dimensions of **B** can vary and that the upper bound is `size(B)`.

If a MATLAB Function block input or output signal is variable-size, in the Ports and Data Manager, you must specify that the signal is variable-size. You must also provide the upper bounds. You do not have to use `coder.varsize` with the corresponding input or output variable inside the MATLAB Function block. However, if you specify upper bounds with `coder.varsize`, they must match the upper bounds in the Ports and Data Manager.

### Specify Which Dimensions Vary

You can use the function `coder.varsize` to specify which dimensions vary. For example, the following statement defines **B** as an array whose first dimension is fixed at 2, but whose second dimension can grow to a size of 16:

```
coder.varsize('B', [2, 16], [0 1])
```

The third argument specifies which dimensions vary. This argument must be a logical vector or a double vector containing only zeros and ones. Dimensions that correspond to zeros or `false` have fixed size. Dimensions that correspond to ones or `true` vary in size. `coder.varsize` usually treats dimensions of size 1 as fixed. See “Define Variable-Size Matrices with Singleton Dimensions” on page 48-10.

For an input or output signal, if you specify the upper bounds with `coder.varsize` inside the MATLAB Function block, they must match the upper bounds in the Ports and Data Manager.

### Allow a Variable to Grow After Defining Fixed Dimensions

Function `var_by_if` defines matrix **Y** with fixed 2-by-2 dimensions before the first use (where the statement `Y = Y + u` reads from **Y**). However, `coder.varsize` defines **Y** as a variable-size matrix, allowing it to change size based on decision logic in the `else` clause:

```
function Y = var_by_if(u) %#codegen
```

```
if (u > 0)
    Y = zeros(2,2);
    coder.varsize('Y');
    if (u < 10)
        Y = Y + u;
    end
else
    Y = zeros(5,5);
end
```

Without `coder.varsize`, the code generator infers `Y` to be a fixed-size, 2-by-2 matrix. It generates a size mismatch error.

### Define Variable-Size Matrices with Singleton Dimensions

A singleton dimension is a dimension for which `size(A,dim) = 1`. Singleton dimensions are fixed in size when:

- You specify a dimension with an upper bound of 1 in `coder.varsize` expressions.

For example, in this function, `Y` behaves like a vector with one variable-size dimension:

```
function Y = dim_singleton(u) %#codegen
Y = [1 2];
coder.varsize('Y', [1 10]);
if (u > 0)
    Y = [Y 3];
else
    Y = [Y u];
end
```

- You initialize variable-size data with singleton dimensions by using matrix constructor expressions or matrix functions.

For example, in this function, `X` and `Y` behave like vectors where only their second dimensions are variable-size.

```
function [X,Y] = dim_singleton_vects(u) %#codegen
Y = ones(1,3);
X = [1 4];
coder.varsize('Y','X');
if (u > 0)
    Y = [Y u];
else
```



```

        X = [X u];
    end

```

You can override this behavior by using `coder.versize` to specify explicitly that singleton dimensions vary. For example:

```

function Y = dim_singleton_vary(u) %#codegen
Y = [1 2];
coder.versize('Y', [1 10], [1 1]);
if (u > 0)
    Y = [Y Y+u];
else
    Y = [Y Y*u];
end

```

In this example, the third argument of `coder.versize` is a vector of ones, indicating that each dimension of `Y` varies in size.

### Define Variable-Size Structure Fields

To define structure fields as variable-size arrays, use a colon (`:`) as the index expression. The colon (`:`) indicates that all elements of the array are variable-size. For example:

```

function y=struct_example() %#codegen

d = struct('values', zeros(1,0), 'color', 0);
data = repmat(d, [3 3]);
coder.versize('data(:).values');

for i = 1:numel(data)
    data(i).color = rand-0.5;
    data(i).values = 1:i;
end

y = 0;
for i = 1:numel(data)
    if data(i).color > 0
        y = y + sum(data(i).values);
    end
end

```

The expression `coder.versize('data(:).values')` defines the field `values` inside each element of matrix `data` to be variable-size.

Here are other examples:

- `coder.ysize('data.A(:).B')`

In this example, `data` is a scalar variable that contains matrix `A`. Each element of matrix `A` contains a variable-size field `B`.

- `coder.ysize('data(:).A(:).B')`

This expression defines field `B` inside each element of matrix `A` inside each element of matrix `data` to be variable-size.

## See Also

`coder.ysize`

## More About

- “Code Generation for Variable-Size Arrays” on page 48-2
- “Specify Upper Bounds for Variable-Size Arrays” on page 48-5

## Diagnose and Fix Variable-Size Data Errors

### In this section...

“Diagnosing and Fixing Size Mismatch Errors” on page 48-13

“Diagnosing and Fixing Errors in Detecting Upper Bounds” on page 48-15

### Diagnosing and Fixing Size Mismatch Errors

Check your code for these issues:

#### Assigning Variable-Size Matrices to Fixed-Size Matrices

You cannot assign variable-size matrices to fixed-size matrices in generated code. Consider this example:

```
function Y = example_mismatch1(n) %#codegen
assert(n < 10);
B = ones(n,n);
A = magic(3);
A(1) = mean(A(:));
if (n == 3)
    A = B;
end
Y = A;
```

Compiling this function produces this error:

```
??? Dimension 1 is fixed on the left-hand side
but varies on the right ...
```

There are several ways to fix this error:

- Allow matrix A to grow by adding the `coder.varsize` construct:

```
function Y = example_mismatch1_fix1(n) %#codegen
coder.varsize('A');
assert(n < 10);
B = ones(n,n);
A = magic(3);
A(1) = mean(A(:));
if (n == 3)
    A = B;
end
Y = A;
```

```
Y = A;
```

- Explicitly restrict the size of matrix B to 3-by-3 by modifying the `assert` statement:

```
function Y = example_mismatch1_fix2(n) %#codegen
coder.varsize('A');
assert(n == 3)
B = ones(n,n);
A = magic(3);
A(1) = mean(A(:));
if (n == 3)
    A = B;
end
Y = A;
```

- Use explicit indexing to make B the same size as A:

```
function Y = example_mismatch1_fix3(n) %#codegen
assert(n < 10);
B = ones(n,n);
A = magic(3);
A(1) = mean(A(:));
if (n == 3)
    A = B(1:3, 1:3);
end
Y = A;
```

### Empty Matrix Reshaped to Match Variable-Size Specification

If you assign an empty matrix `[]` to variable-size data, MATLAB might silently reshape the data in generated code to match a `coder.varsize` specification. For example:

```
function Y = test(u) %#codegen
Y = [];
coder.varsize('Y', [1 10]);
if u < 0
    Y = [Y u];
end
```

In this example, `coder.varsize` defines Y as a column vector of up to 10 elements, so its first dimension is fixed at size 1. The statement `Y = []` designates the first dimension of Y as 0, creating a mismatch. The right hand side of the assignment is an empty matrix and the left hand side is a variable-size vector. In this case, MATLAB reshapes the empty matrix `Y = []` in generated code to `Y = zeros(1,0)` so it matches the `coder.varsize` specification.

## Performing Binary Operations on Fixed and Variable-Size Operands

You cannot perform binary operations on operands of different sizes. Operands have different sizes if one has fixed dimensions and the other has variable dimensions. For example:

```
function z = mismatch_operands(n) %#codegen
assert(n >= 3 && n < 10);
x = ones(n,n);
y = magic(3);
z = x + y;
```

When you compile this function, you get an error because `y` has fixed dimensions (3 x 3), but `x` has variable dimensions. Fix this problem by using explicit indexing to make `x` the same size as `y`:

```
function z = mismatch_operands_fix(n) %#codegen
assert(n >= 3 && n < 10);
x = ones(n,n);
y = magic(3);
z = x(1:3,1:3) + y;
```

## Diagnosing and Fixing Errors in Detecting Upper Bounds

Check your code for these issues:

### Using Nonconstant Dimensions in a Matrix Constructor

You can define variable-size data by assigning a variable to a matrix with nonconstant dimensions. For example:

```
function y = dims_vary(u) %#codegen
if (u > 0)
    y = ones(3,u);
else
    y = zeros(3,1);
end
```

However, compiling this function generates an error because you did not specify an upper bound for `u`.

To fix the problem, add an `assert` statement before the first use of `u`:

```
function y = dims_vary_fix(u) %#codegen
```

```
assert (u < 20);  
if (u > 0)  
    y = ones(3,u);  
else  
    y = zeros(3,1);  
end
```

## Incompatibilities with MATLAB in Variable-Size Support for Code Generation

### In this section...

“Incompatibility with MATLAB for Scalar Expansion” on page 48-17

“Incompatibility with MATLAB in Determining Size of Variable-Size N-D Arrays” on page 48-19

“Incompatibility with MATLAB in Determining Size of Empty Arrays” on page 48-20

“Incompatibility with MATLAB in Determining Class of Empty Arrays” on page 48-21

“Incompatibility with MATLAB in Matrix-Matrix Indexing” on page 48-22

“Incompatibility with MATLAB in Vector-Vector Indexing” on page 48-22

“Incompatibility with MATLAB in Matrix Indexing Operations for Code Generation” on page 48-23

“Incompatibility with MATLAB in Concatenating Variable-Size Matrices” on page 48-24

“Differences When Curly-Brace Indexing of Variable-Size Cell Array Inside Concatenation Returns No Elements” on page 48-24

### Incompatibility with MATLAB for Scalar Expansion

Scalar expansion is a method of converting scalar data to match the dimensions of vector or matrix data. If one operand is a scalar and the other is not, scalar expansion applies the scalar to every element of the other operand.

During code generation, scalar expansion rules apply except when operating on two variable-size expressions. In this case, both operands must be the same size. The generated code does not perform scalar expansion even if one of the variable-size expressions turns out to be scalar at run time. Therefore, when run-time error checks are enabled, a run-time error can occur.

Consider this function:

```
function y = scalar_exp_test_err1(u) %#codegen
y = ones(3);
switch u
```

```

case 0
    z = 0;
case 1
    z = 1;
otherwise
    z = zeros(3);
end
y(:) = z;

```

When you generate code for this function, the code generator determines that `z` is variable size with an upper bound of `3`.

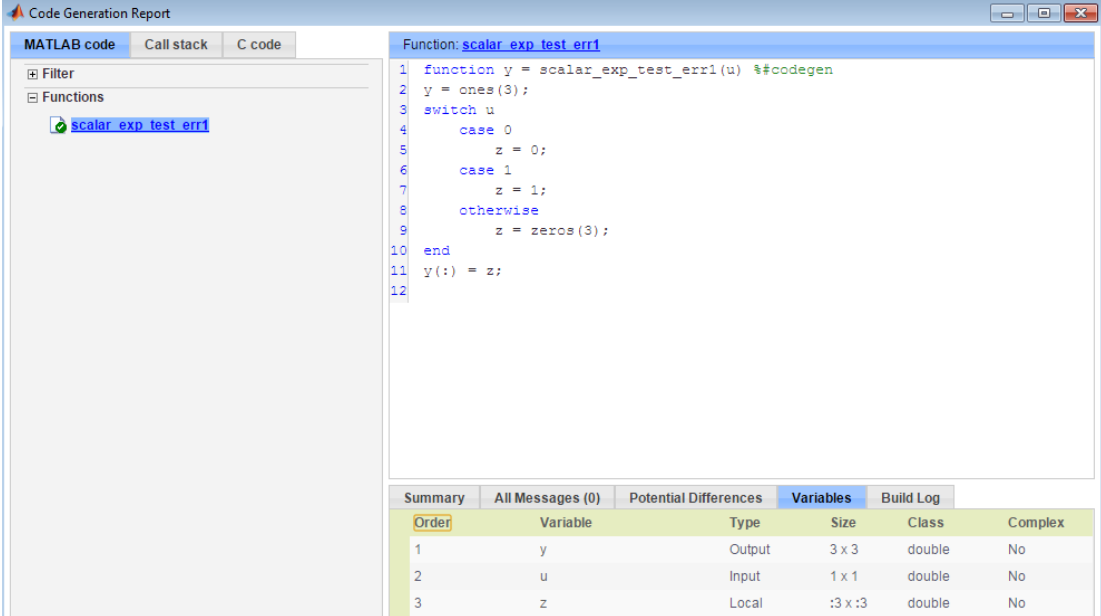

The screenshot shows the Code Generation Report window for the function `scalar_exp_test_err1`. The MATLAB code is displayed on the left, and the generated C code is shown on the right. The C code includes a `switch` statement that handles the variable `z` based on the input `u`. The report also includes a table of variables.

Order	Variable	Type	Size	Class	Complex
1	y	Output	3 x 3	double	No
2	u	Input	1 x 1	double	No
3	z	Local	:3 x :3	double	No

If you run the MEX function with `u` equal to 0 or 1, the generated code does not perform scalar expansion, even though `z` is scalar at run time. Therefore, when run-time error checks are enabled, a run-time error can occur.

```

scalar_exp_test_err1_mex(0)
Sizes mismatch: 9 ~= 1.

```

```

Error in scalar_exp_test_err1 (line 11)
y(:) = z;

```



To avoid this issue, use indexing to force `z` to be a scalar value.

```
function y = scalar_exp_test_err1(u) %#codegen
y = ones(3);
switch u
    case 0
        z = 0;
    case 1
        z = 1;
    otherwise
        z = zeros(3);
end
y(:) = z(1);
```

## Incompatibility with MATLAB in Determining Size of Variable-Size N-D Arrays

For variable-size N-D arrays, the `size` function can return a different result in generated code than in MATLAB. In generated code, `size(A)` returns a fixed-length output because it does not drop trailing singleton dimensions of variable-size N-D arrays. By contrast, `size(A)` in MATLAB returns a variable-length output because it drops trailing singleton dimensions.

For example, if the shape of array `A` is `?x:?x:?` and `size(A,3)==1`, `size(A)` returns:

- Three-element vector in generated code
- Two-element vector in MATLAB code

### Workarounds

If your application requires generated code to return the same size of variable-size N-D arrays as MATLAB code, consider one of these workarounds:

- Use the two-argument form of `size`.

For example, `size(A,n)` returns the same answer in generated code and MATLAB code.

- Rewrite `size(A)`:

```
B = size(A);
X = B(1:ndims(A));
```

This version returns `X` with a variable-length output. However, you cannot pass a variable-size `X` to matrix constructors such as `zeros` that require a fixed-size argument.

## Incompatibility with MATLAB in Determining Size of Empty Arrays

The size of an empty array in generated code might be different from its size in MATLAB source code. The size might be `1x0` or `0x1` in generated code, but `0x0` in MATLAB. Therefore, you should not write code that relies on the specific size of empty matrices.

For example, consider the following code:

```
function y = foo(n) %#codegen
x = [];
i = 0;
while (i < 10)
    x = [5 x];
    i = i + 1;
end
if n > 0
    x = [];
end
y = size(x);
end
```

Concatenation requires its operands to match on the size of the dimension that is not being concatenated. In the preceding concatenation, the scalar value has size `1x1` and `x` has size `0x0`. To support this use case, the code generator determines the size for `x` as `[1 x :?]`. Because there is another assignment `x = []` after the concatenation, the size of `x` in the generated code is `1x0` instead of `0x0`.

For incompatibilities with MATLAB in determining the size of an empty array that results from deleting elements of an array, see “Size of Empty Array That Results from Deleting Elements of an Array” on page 43-11.

### Workaround

If your application checks whether a matrix is empty, use one of these workarounds:

- Rewrite your code to use the `isempty` function instead of the `size` function.
- Instead of using `x=[]` to create empty arrays, create empty arrays of a specific size using `zeros`. For example:

```

function y = test_empty(n) %#codegen
x = zeros(1,0);
i=0;
while (i < 10)
    x = [5 x];
    i = i + 1;
end
if n > 0
    x = zeros(1,0);
end
y=size(x);
end

```

## Incompatibility with MATLAB in Determining Class of Empty Arrays

The class of an empty array in generated code can be different from its class in MATLAB source code. Therefore, do not write code that relies on the class of empty matrices.

For example, consider the following code:

```

function y = fun(n)
x = [];
if n > 1
    x = ['a' x];
end
y=class(x);
end

```

`fun(0)` returns `double` in MATLAB, but `char` in the generated code. When the statement `n > 1` is false, MATLAB does not execute `x = ['a' x]`. The class of `x` is `double`, the class of the empty array. However, the code generator considers all execution paths. It determines that based on the statement `x = ['a' x]`, the class of `x` is `char`.

### Workaround

Instead of using `x=[]` to create an empty array, create an empty array of a specific class. For example, use `blanks(0)` to create an empty array of characters.

```

function y = fun(n)
x = blanks(0);
if n > 1
    x = ['a' x];
end

```

```
end
y=class(x);
end
```

## Incompatibility with MATLAB in Matrix-Matrix Indexing

In matrix-matrix indexing, you use one matrix to index into another matrix. In MATLAB, the general rule for matrix-matrix indexing is that the size and orientation of the result match the size and orientation of the index matrix. For example, if **A** and **B** are matrices, `size(A(B))` equals `size(B)`. When **A** and **B** are vectors, MATLAB applies a special rule. The special vector-vector indexing rule is that the orientation of the result is the orientation of the data matrix. For example, if **A** is 1-by-5 and **B** is 3-by-1, then `A(B)` is 1-by-3.

The code generator applies the same matrix-matrix indexing rules as MATLAB. If **A** and **B** are variable-size matrices, to apply the matrix-matrix indexing rules, the code generator assumes that the `size(A(B))` equals `size(B)`. If, at run time, **A** and **B** become vectors and have different orientations, then the assumption is incorrect. Therefore, when run-time error checks are enabled, an error can occur.

To avoid this issue, force your data to be a vector by using the colon operator for indexing. For example, suppose that your code intentionally toggles between vectors and regular matrices at run time. You can do an explicit check for vector-vector indexing.

```
...
if isvector(A) && isvector(B)
    C = A(:);
    D = C(B(:));
else
    D = A(B);
end
...
```

The indexing in the first branch specifies that **C** and `B(:)` are compile-time vectors. Therefore, the code generator applies the indexing rule for indexing one vector with another vector. The orientation of the result is the orientation of the data vector, **C**.

## Incompatibility with MATLAB in Vector-Vector Indexing

In MATLAB, the special rule for vector-vector indexing is that the orientation of the result is the orientation of the data vector. For example, if **A** is 1-by-5 and **B** is 3-by-1,

then  $A(B)$  is 1-by-3. If, however, the data vector  $A$  is a scalar, then the orientation of  $A(B)$  is the orientation of the index vector  $B$ .

The code generator applies the same vector-vector indexing rules as MATLAB. If  $A$  and  $B$  are variable-size vectors, to apply the indexing rules, the code generator assumes that the orientation of  $B$  matches the orientation of  $A$ . At run time, if  $A$  is scalar and the orientation of  $A$  and  $B$  do not match, then the assumption is incorrect. Therefore, when run-time error checks are enabled, a run-time error can occur.

To avoid this issue, make the orientations of the vectors match. Alternatively, index single elements by specifying the row and column. For example,  $A(\text{row}, \text{column})$ .

## Incompatibility with MATLAB in Matrix Indexing Operations for Code Generation

The following limitation applies to matrix indexing operations for code generation:

- Initialization of the following style:

```
for i = 1:10
    M(i) = 5;
end
```

In this case, the size of  $M$  changes as the loop is executed. Code generation does not support increasing the size of an array over time.

For code generation, preallocate  $M$ .

```
M = zeros(1,10);
for i = 1:10
    M(i) = 5;
end
```

The following limitation applies to matrix indexing operations for code generation when dynamic memory allocation is disabled:

- $M(i:j)$  where  $i$  and  $j$  change in a loop

During code generation, memory is not dynamically allocated for the size of the expressions that change as the program executes. To implement this behavior, use `for`-loops as shown:

```
...
```

```
M = ones(10,10);  
for i=1:10  
    for j = i:10  
        M(i,j) = 2*M(i,j);  
    end  
end  
...
```

---

**Note:** The matrix *M* must be defined before entering the loop.

---

## Incompatibility with MATLAB in Concatenating Variable-Size Matrices

For code generation, when you concatenate variable-size arrays, the dimensions that are not being concatenated must match exactly.

## Differences When Curly-Brace Indexing of Variable-Size Cell Array Inside Concatenation Returns No Elements

Suppose that:

- *c* is a variable-size cell array.
- You access the contents of *c* by using curly braces. For example, *c*{2:4}.
- You include the results in concatenation. For example, [*a* *c*{2:4} *b*].
- *c*{*I*} returns no elements. Either *c* is empty or the indexing inside the curly braces produces an empty result.

For these conditions, MATLAB omits *c*{*I*} from the concatenation. For example, [*a* *c*{*I*} *b*] becomes [*a* *b*]. The code generator treats *c*{*I*} as the empty array [*c*{*I*}]. The concatenation becomes [... [*c*{*i*}] ...]. This concatenation then omits the array [*c*{*I*}]. So that the properties of [*c*{*I*}] are compatible with the concatenation [... [*c*{*i*}] ...], the code generator assigns the class, size, and complexity of [*c*{*I*}] according to these rules:

- The class and complexity are the same as the base type of the cell array.
- The size of the second dimension is always 0.
- For the rest of the dimensions, the size of *N<sub>i</sub>* depends on whether the corresponding dimension in the base type is fixed or variable size.

- If the corresponding dimension in the base type is variable size, the dimension has size 0 in the result.
- If the corresponding dimension in the base type is fixed size, the dimension has that size in the result.

Suppose that `c` has a base type with class `int8` and size `10x7x8x?`. In the generated code, the class of `[c{I}]` is `int8`. The size of `[c{I}]` is `0x0x8x0`. The second dimension is 0. The first and last dimensions are 0 because those dimensions are variable size in the base type. The third dimension is 8 because the size of the third dimension of the base type is a fixed size 8.

Inside concatenation, if curly-brace indexing of a variable-size cell array returns no elements, the generated code can have the following differences from MATLAB:

- The class of `[...c{i}...]` in the generated code can differ from the class in MATLAB.

When `c{I}` returns no elements, MATLAB removes `c{I}` from the concatenation. Therefore, `c{I}` does not affect the class of the result. MATLAB determines the class of the result based on the classes of the remaining arrays, according to a precedence of classes. See “Valid Combinations of Unlike Classes” (MATLAB). In the generated code, the class of `[c{I}]` affects the class of the result of the overall concatenation `[...[c{I}]...]` because the code generator treats `c{I}` as `[c{I}]`. The previously described rules determine the class of `[c{I}]`.

- In the generated code, the size of `[c{I}]` can differ from the size in MATLAB.

In MATLAB, the concatenation `[c{I}]` is a `0x0 double`. In the generated code, the previously described rules determine the size of `[c{I}]`.

## Variable-Sizing Restrictions for Code Generation of Toolbox Functions

### In this section...

“Common Restrictions” on page 48-26

“Toolbox Functions with Restrictions for Variable-Size Data” on page 48-27

### Common Restrictions

The following common restrictions apply to multiple toolbox functions, but only for code generation. To determine which of these restrictions apply to specific library functions, see the table in “Toolbox Functions with Restrictions for Variable-Size Data” on page 48-27.

#### Variable-length vector restriction

Inputs to the library function must be variable-length vectors or fixed-size vectors. A variable-length vector is a variable-size array that has the shape  $1 \times n$  or  $n \times 1$  (one dimension is variable sized and the other is fixed at size 1). Other shapes are not permitted, even if they are vectors at run time.

#### Automatic dimension restriction

This restriction applies to functions that take the working dimension (the dimension along which to operate) as input. In MATLAB and in code generation, if you do not supply the working dimension, the function selects it. In MATLAB, the function selects the first dimension whose size does not equal 1. For code generation, the function selects the first dimension that has a variable size or that has a fixed size that does not equal 1. If the working dimension has a variable size and it becomes 1 at run time, then the working dimension is different from the working dimension in MATLAB. Therefore, when run-time error checks are enabled, an error can occur.

For example, suppose that  $X$  is a variable-size matrix with dimensions  $1 \times 3 \times 5$ . In the generated code, `sum(X)` behaves like `sum(X,2)`. In MATLAB, `sum(X)` behaves like `sum(X,2)` unless `size(X,2)` is 1. In MATLAB, when `size(X,2)` is 1, `sum(X)` behaves like `sum(X,3)`.

To avoid this issue, specify the intended working dimension explicitly as a constant value. For example, `sum(X,2)`.



**Array-to-vector restriction**

The function issues an error when a variable-size array that is not a variable-length vector assumes the shape of a vector at run time. To avoid the issue, specify the input explicitly as a variable-length vector instead of a variable-size array.

**Array-to-scalar restriction**

The function issues an error if a variable-size array assumes a scalar value at run time. To avoid this issue, specify scalars as fixed size.

**Toolbox Functions with Restrictions for Variable-Size Data**

The following table lists functions that have code generation restrictions for variable-size data. For additional restrictions for these functions, and restrictions for all functions and objects supported for code generation, see “Functions and Objects Supported for C/C++ Code Generation — Alphabetical List” (MATLAB Coder).

Function	Restrictions for Variable-Size Data
all	<ul style="list-style-type: none"> <li>• See “Automatic dimension restriction” on page 48-26.</li> <li>• An error occurs if you pass the first argument a variable-size matrix that is 0-by-0 at run time.</li> </ul>
any	<ul style="list-style-type: none"> <li>• See “Automatic dimension restriction” on page 48-26.</li> <li>• An error occurs if you pass the first argument a variable-size matrix that is 0-by-0 at run time.</li> </ul>
bsxfun	<ul style="list-style-type: none"> <li>• Dimensions expand only where one input array or the other has a fixed length of 1.</li> </ul>
cat	<ul style="list-style-type: none"> <li>• Dimension argument must be a constant.</li> <li>• An error occurs if variable-size inputs are empty at run time.</li> </ul>
conv	<ul style="list-style-type: none"> <li>• See “Variable-length vector restriction” on page 48-26.</li> <li>• Input vectors must have the same orientation, either both row vectors or both column vectors.</li> </ul>

Function	Restrictions for Variable-Size Data
cov	<ul style="list-style-type: none"> <li>For <code>cov(X)</code>, see “Array-to-vector restriction” on page 48-27.</li> </ul>
cross	<ul style="list-style-type: none"> <li>Variable-size array inputs that become vectors at run time must have the same orientation.</li> </ul>
deconv	<ul style="list-style-type: none"> <li>For both arguments, see “Variable-length vector restriction” on page 48-26.</li> </ul>
detrend	<ul style="list-style-type: none"> <li>For first argument for row vectors only, see “Array-to-vector restriction” on page 48-27 .</li> </ul>
diag	<ul style="list-style-type: none"> <li>See “Array-to-vector restriction” on page 48-27 .</li> </ul>
diff	<ul style="list-style-type: none"> <li>See “Automatic dimension restriction” on page 48-26.</li> <li>Length of the working dimension must be greater than the difference order input when the input is variable sized. For example, if the input is a variable-size matrix that is 3-by-5 at run time, <code>diff(x,2,1)</code> works but <code>diff(x,5,1)</code> generates a run-time error.</li> </ul>
fft	<ul style="list-style-type: none"> <li>See “Automatic dimension restriction” on page 48-26.</li> </ul>
filter	<ul style="list-style-type: none"> <li>For first and second arguments, see “Variable-length vector restriction” on page 48-26.</li> <li>See “Automatic dimension restriction” on page 48-26.</li> </ul>
hist	<ul style="list-style-type: none"> <li>For second argument, see “Variable-length vector restriction” on page 48-26.</li> <li>For second input argument, see “Array-to-scalar restriction” on page 48-27.</li> </ul>
histc	<ul style="list-style-type: none"> <li>See “Automatic dimension restriction” on page 48-26.</li> </ul>
ifft	<ul style="list-style-type: none"> <li>See “Automatic dimension restriction” on page 48-26.</li> </ul>
ind2sub	<ul style="list-style-type: none"> <li>First input (the size vector input) must be fixed size.</li> </ul>

Function	Restrictions for Variable-Size Data
interp1	<ul style="list-style-type: none"><li>• For the xq input, see “Array-to-vector restriction” on page 48-27.</li><li>• If v becomes a row vector at run time, the array to vector restriction applies. If v becomes a column vector at run time, this restriction does not apply.</li></ul>
ipermute	<ul style="list-style-type: none"><li>• Order input must be fixed size.</li></ul>
issorted	<ul style="list-style-type: none"><li>• For optional rows input, see “Variable-length vector restriction” on page 48-26.</li></ul>
magic	<ul style="list-style-type: none"><li>• Argument must be a constant.</li><li>• Output can be fixed-size matrices only.</li></ul>
max	<ul style="list-style-type: none"><li>• See “Automatic dimension restriction” on page 48-26.</li></ul>
mean	<ul style="list-style-type: none"><li>• See “Automatic dimension restriction” on page 48-26.</li><li>• An error occurs if you pass as the first argument a variable-size matrix that is 0-by-0 at run time.</li></ul>
median	<ul style="list-style-type: none"><li>• See “Automatic dimension restriction” on page 48-26.</li><li>• An error occurs if you pass as the first argument a variable-size matrix that is 0-by-0 at run time.</li></ul>
min	<ul style="list-style-type: none"><li>• See “Automatic dimension restriction” on page 48-26.</li></ul>
mode	<ul style="list-style-type: none"><li>• See “Automatic dimension restriction” on page 48-26.</li><li>• An error occurs if you pass as the first argument a variable-size matrix that is 0-by-0 at run time.</li></ul>

Function	Restrictions for Variable-Size Data
mtimes	<p>Consider the multiplication <math>A*B</math>. If the code generator is aware that <math>A</math> is scalar and <math>B</math> is a matrix, the code generator produces code for scalar-matrix multiplication. However, if the code generator is aware that <math>A</math> and <math>B</math> are variable-size matrices, it produces code for a general matrix multiplication. At run time, if <math>A</math> turns out to be scalar, the generated code does not change its behavior. Therefore, when run-time error checks are enabled, a size mismatch error can occur.</p>
nchoosek	<ul style="list-style-type: none"> <li>• The second input, <math>k</math>, must be a fixed-size scalar.</li> <li>• The second input, <math>k</math>, must be a constant for static allocation..</li> <li>• You cannot create a variable-size array by passing in a variable, <math>k</math>, .</li> </ul>
permute	<ul style="list-style-type: none"> <li>• Order input must be fixed-size.</li> </ul>
planerot	<ul style="list-style-type: none"> <li>• Input must be a fixed-size, two-element column vector. It cannot be a variable-size array that takes on the size 2-by-1 at run time.</li> </ul>
poly	<ul style="list-style-type: none"> <li>• See “Variable-length vector restriction” on page 48-26.</li> </ul>
polyfit	<ul style="list-style-type: none"> <li>• For first and second arguments, see “Variable-length vector restriction” on page 48-26.</li> </ul>
prod	<ul style="list-style-type: none"> <li>• See “Automatic dimension restriction” on page 48-26.</li> <li>• An error occurs if you pass as the first argument a variable-size matrix that is 0-by-0 at run time.</li> </ul>
rand	<ul style="list-style-type: none"> <li>• For an upper-bounded variable <math>N</math>, <code>rand(1,N)</code> produces a variable-length vector of <math>1 \times M</math> where <math>M</math> is the upper bound on <math>N</math>.</li> <li>• For an upper-bounded variable <math>N</math>, <code>rand([1 N])</code> may produce a variable-length vector of <math>:1 \times M</math> where <math>M</math> is the upper bound on <math>N</math>.</li> </ul>

Function	Restrictions for Variable-Size Data
randi	<ul style="list-style-type: none"> <li>• For an upper-bounded variable <math>N</math>, <code>randi(imax, 1, N)</code> produces a variable-length vector of <math>1 \times M</math> where <math>M</math> is the upper bound on <math>N</math>.</li> <li>• For an upper-bounded variable <math>N</math>, <code>randi(imax, [1 N])</code> may produce a variable-length vector of <math>:1 \times M</math> where <math>M</math> is the upper bound on <math>N</math>.</li> </ul>
randn	<ul style="list-style-type: none"> <li>• For an upper-bounded variable <math>N</math>, <code>randn(1, N)</code> produces a variable-length vector of <math>1 \times M</math> where <math>M</math> is the upper bound on <math>N</math>.</li> <li>• For an upper-bounded variable <math>N</math>, <code>randn([1 N])</code> may produce a variable-length vector of <math>:1 \times M</math> where <math>M</math> is the upper bound on <math>N</math>.</li> </ul>
reshape	<ul style="list-style-type: none"> <li>• If the input is a variable-size array and the output array has at least one fixed-length dimension, do not specify the output dimension sizes in a size vector <code>SZ</code>. Instead, specify the output dimension sizes as scalar values, <code>SZ1, . . . , SZN</code>. Specify fixed-size dimensions as constants.</li> <li>• When the input is a variable-size empty array, the maximum dimension size of the output array (also empty) cannot be larger than that of the input.</li> </ul>
roots	<ul style="list-style-type: none"> <li>• See “Variable-length vector restriction” on page 48-26.</li> </ul>
shiftdim	<ul style="list-style-type: none"> <li>• If you do not supply the second argument, the number of shifts is determined at compilation time by the upper bounds of the dimension sizes. Therefore, at run time the number of shifts is constant.</li> <li>• An error occurs if the dimension that is shifted to the first dimension has length 1 at run time. To avoid the error, supply the number of shifts as the second input argument (must be a constant).</li> <li>• First input argument must have the same number of dimensions when you supply a positive number of shifts.</li> </ul>

Function	Restrictions for Variable-Size Data
std	<ul style="list-style-type: none"><li>• See “Automatic dimension restriction” on page 48-26.</li><li>• An error occurs if you pass a variable-size matrix with 0-by-0 dimensions at run time.</li></ul>
sub2ind	<ul style="list-style-type: none"><li>• First input (the size vector input) must be fixed size.</li></ul>
sum	<ul style="list-style-type: none"><li>• See “Automatic dimension restriction” on page 48-26.</li><li>• An error occurs if you pass as the first argument a variable-size matrix that is 0-by-0 at run time.</li></ul>
trapz	<ul style="list-style-type: none"><li>• See “Automatic dimension restriction” on page 48-26.</li><li>• An error occurs if you pass as the first argument a variable-size matrix that is 0-by-0 at run time.</li></ul>
typecast	<ul style="list-style-type: none"><li>• See “Variable-length vector restriction” on page 48-26 on first argument.</li></ul>
var	<ul style="list-style-type: none"><li>• See “Automatic dimension restriction” on page 48-26.</li><li>• An error occurs if you pass a variable-size matrix with 0-by-0 dimensions at run time.</li></ul>

# Code Generation for MATLAB Structures

---

- “Structure Definition for Code Generation” on page 49-2
- “Structure Operations Allowed for Code Generation” on page 49-3
- “Define Scalar Structures for Code Generation” on page 49-4
- “Define Arrays of Structures for Code Generation” on page 49-6
- “Index Substructures and Fields” on page 49-8
- “Assign Values to Structures and Fields” on page 49-10
- “Pass Large Structures as Input Parameters” on page 49-12

## Structure Definition for Code Generation

To generate efficient standalone code for structures, you must define and use structures differently than you normally would when running your code in the MATLAB environment:

<b>What's Different</b>	<b>More Information</b>
Use a restricted set of operations.	“Structure Operations Allowed for Code Generation” on page 49-3
Observe restrictions on properties and values of scalar structures.	“Define Scalar Structures for Code Generation” on page 49-4
Make structures uniform in arrays.	“Define Arrays of Structures for Code Generation” on page 49-6
Reference structure fields individually during indexing.	“Index Substructures and Fields” on page 40-80
Avoid type mismatch when assigning values to structures and fields.	“Assign Values to Structures and Fields” on page 40-84



## Structure Operations Allowed for Code Generation

To generate efficient standalone code for MATLAB structures, you are restricted to the following operations:

- Define structures as local and persistent variables by assignment and using the `struct` function
- Index structure fields using dot notation
- Define primary function inputs as structures
- Pass structures to local functions

## Define Scalar Structures for Code Generation

### In this section...

“Restrictions When Defining Scalar Structures by Assignment” on page 49-4  
 “Adding Fields in Consistent Order on Each Control Flow Path” on page 49-4  
 “Restriction on Adding New Fields After First Use” on page 49-5

### Restrictions When Defining Scalar Structures by Assignment

When you define a scalar structure by assigning a variable to a preexisting structure, you do not need to define the variable before the assignment. However, if you already defined that variable, it must have the same class, size, and complexity as the structure you assign to it. In the following example, `p` is defined as a structure that has the same properties as the predefined structure `S`:

```
...
S = struct('a', 0, 'b', 1, 'c', 2);
p = S;
...
```

### Adding Fields in Consistent Order on Each Control Flow Path

When you create a structure, you must add fields in the same order on each control flow path. For example, the following code generates a compiler error because it adds the fields of structure `x` in a different order in each `if` statement clause:

```
function y = fcn(u) %#codegen
if u > 0
    x.a = 10;
    x.b = 20;
else
    x.b = 30; % Generates an error (on variable x)
    x.a = 40;
end
y = x.a + x.b;
```

In this example, the assignment to `x.a` comes before `x.b` in the first `if` statement clause, but the assignments appear in reverse order in the `else` clause. Here is the corrected code:

```

function y = fcn(u) %#codegen
if u > 0
    x.a = 10;
    x.b = 20;
else
    x.a = 40;
    x.b = 30;
end
y = x.a + x.b;

```

## Restriction on Adding New Fields After First Use

You cannot add fields to a structure after you perform the following operations on the structure:

- Reading from the structure
- Indexing into the structure array
- Passing the structure to a function

For example, consider this code:

```

...
x.c = 10; % Defines structure and creates field c
y = x; % Reads from structure
x.d = 20; % Generates an error
...

```

In this example, the attempt to add a new field `d` after reading from structure `x` generates an error.

This restriction extends across the structure hierarchy. For example, you cannot add a field to a structure after operating on one of its fields or nested structures, as in this example:

```

function y = fcn(u) %#codegen

x.c = 10;
y = x.c;
x.d = 20; % Generates an error

```

In this example, the attempt to add a new field `d` to structure `x` after reading from the structure's field `c` generates an error.

## Define Arrays of Structures for Code Generation

### In this section...

“Ensuring Consistency of Fields” on page 49-6

“Using repmat to Define an Array of Structures with Consistent Field Properties” on page 49-6

“Defining an Array of Structures by Using struct” on page 49-7

“Defining an Array of Structures Using Concatenation” on page 49-7

### Ensuring Consistency of Fields

For code generation, when you create an array of MATLAB structures, corresponding fields in the array elements must have the same size, type, and complexity.

Once you have created the array of structures, you can make the structure fields variable-size using `coder. varsizes`. For more information, see “Declare a Variable-Size Structure Field.” (MATLAB Coder).

### Using repmat to Define an Array of Structures with Consistent Field Properties

You can create an array of structures from a scalar structure by using the MATLAB `repmat` function, which replicates and tiles an existing scalar structure:

- 1 Create a scalar structure, as described in “Define Scalar Structures for Code Generation” on page 49-4.
- 2 Call `repmat`, passing the scalar structure and the dimensions of the array.
- 3 Assign values to each structure using standard array indexing and structure dot notation.

For example, the following code creates `X`, a 1-by-3 array of scalar structures. Each element of the array is defined by the structure `s`, which has two fields, `a` and `b`:

```
...  
s.a = 0;  
s.b = 0;  
X = repmat(s,1,3);
```

```

X(1).a = 1;
X(2).a = 2;
X(3).a = 3;
X(1).b = 4;
X(2).b = 5;
X(3).b = 6;
...

```

## Defining an Array of Structures by Using `struct`

To create an array of structures using the `struct` function, specify the field value arguments as cell arrays. Each cell array element is the value of the field in the corresponding structure array element. For code generation, corresponding fields in the structures must have the same type. Therefore, the elements in a cell array of field values must have the same type.

For example, the following code creates a 1-by-3 structure array. For each structure in the array of structures, `a` has type `double` and `b` has type `char`.

```
s = struct('a', {1 2 3}, 'b', {'a' 'b' 'c'});
```

## Defining an Array of Structures Using Concatenation

To create a small array of structures, you can use the concatenation operator, square brackets ( `[ ]` ), to join one or more structures into an array (see “Concatenating Matrices” (MATLAB)). For code generation, the structures that you concatenate must have the same size, class, and complexity.

For example, the following code uses concatenation and a local function to create the elements of a 1-by-3 structure array:

```

...
W = [ sab(1,2) sab(2,3) sab(4,5) ];

function s = sab(a,b)
    s.a = a;
    s.b = b;
...

```

## Index Substructures and Fields

Use these guidelines when indexing substructures and fields for code generation:

### Reference substructure field values individually using dot notation

For example, the following MATLAB code uses dot notation to index fields and substructures:

```

...
substruct1.a1 = 15.2;
substruct1.a2 = int8([1 2;3 4]);

mystruct = struct('ele1',20.5,'ele2',single(100),
                 'ele3',substruct1);

substruct2 = mystruct;
substruct2.ele3.a2 = 2*(substruct1.a2);
...

```

The generated code indexes elements of the structures in this example by resolving symbols as follows:

Dot Notation	Symbol Resolution
substruct1.a1	Field a1 of local structure substruct1
substruct2.ele3.a1	Value of field a1 of field ele3, a substructure of local structure substruct2
substruct2.ele3.a2(1,1)	Value in row 1, column 1 of field a2 of field ele3, a substructure of local structure substruct2

### Reference field values individually in structure arrays

To reference the value of a field in a structure array, you must index into the array to the structure of interest and then reference that structure's field individually using dot notation, as in this example:

```

...
y = X(1).a % Extracts the value of field a
           % of the first structure in array X
...

```

To reference all the values of a particular field for each structure in an array, use this notation in a `for` loop, as in this example:

```
...  
s.a = 0;  
s.b = 0;  
X = repmat(s,1,5);  
for i = 1:5  
    X(i).a = i;  
    X(i).b = i+1;  
end
```

This example uses the `repmat` function to define an array of structures, each with two fields `a` and `b` as defined by `s`. See “Define Arrays of Structures for Code Generation” on page 49-6 for more information.

### **Do not reference fields dynamically**

You cannot reference fields in a structure by using dynamic names, which express the field as a variable expression that MATLAB evaluates at run time (see “Generate Field Names from Variables” (MATLAB)).

## Assign Values to Structures and Fields

When assigning values to a structure, substructure, or field for code generation, use these guidelines:

### Field properties must be consistent across structure-to-structure assignments

If:	Then:
Assigning one structure to another structure.	Define each structure with the same number, type, and size of fields.
Assigning one structure to a substructure of a different structure and vice versa.	Define the structure with the same number, type, and size of fields as the substructure.
Assigning an element of one structure to an element of another structure.	The elements must have the same type and size.

### For structures with constant fields, do not assign field values inside control flow constructs

In the following code, the code generator recognizes that the structure fields `s.a` and `s.b` are constants.

```
function y = mystruct()
s.a = 3;
s.b = 5;
y = zeros(s.a,s.b);
```

If a field of a structure is assigned inside a control flow construct, the code generator does not recognize that `s.a` and `s.b` are constant. Consider the following code:

```
function y = mystruct(x)
s.a = 3;
if x > 1
    s.b = 4;
else
    s.b = 5;
end
y = zeros(s.a,s.b);
```

If variable-sizing is enabled, `y` is treated as a variable-size array. If variable-sizing is disabled, `y`, the code generator reports an error.



**Do not assign mxArray to structures**

You cannot assign mxArray to structure elements; convert mxArray to known types before code generation (see “Working with mxArray” on page 54-15).

**Do not assign classes to structure fields**

You cannot assign classes to structure fields.

**Do not assign cell arrays to structure fields**

You cannot assign cell arrays to structure fields.

## Pass Large Structures as Input Parameters

If you generate a MEX function for a MATLAB function that takes a large structure as an input parameter, for example, a structure containing fields that are matrices, the MEX function might fail to load. This load failure occurs because, when you generate a MEX function from a MATLAB function that has input parameters, the code generator allocates memory for these input parameters on the stack. To avoid this issue, pass the structure by reference to the MATLAB function. For example, if the original function signature is:

```
y = foo(a, S)
```

where **S** is the structure input, rewrite the function to:

```
[y, S] = foo(a, S)
```

# Code Generation for Cell Arrays

---

- “Code Generation for Cell Arrays” on page 50-2
- “Control Whether a Cell Array Is Variable-Size” on page 50-5
- “Cell Array Limitations for Code Generation” on page 50-8

## Code Generation for Cell Arrays

When you generate code from MATLAB code that contains cell arrays, the code generator classifies the cell arrays as *homogeneous* or *heterogeneous*. This classification determines how a cell array is represented in the generated code. It also determines how you can use the cell array in MATLAB code from which you generate code.

When you use cell arrays in MATLAB code that is intended for code generation, you must adhere to certain restrictions. See “Cell Array Limitations for Code Generation” on page 50-8.

### Homogeneous vs. Heterogeneous Cell Arrays

A homogeneous cell array has these characteristics:

- The cell array is represented as an array in the generated code.
- All elements have the same properties. The type associated with the cell array specifies the properties of all elements rather than the properties of individual elements.
- The cell array can be variable-size.
- You can index into the cell array with an index whose value is determined at run time.

A heterogeneous cell array has these characteristics:

- The cell array is represented as a structure in the generated code. Each element is represented as a field of the structure.
- The elements can have different properties. The type associated with the cell array specifies the properties of each element individually.
- The cell array cannot be variable-size.
- You must index into the cell array with a constant index or with `for`-loops that have constant bounds.

The code generator uses heuristics to determine the classification of a cell array as homogeneous or heterogeneous. It considers the properties (class, size, complexity) of the elements and other factors, such as how you use the cell array in your program. Depending on how you use a cell array, the code generator can classify a cell array as

homogeneous in one case and heterogeneous in another case. For example, consider the cell array `{1 [2 3]}`. The code generator can classify this cell array as a heterogeneous 1-by-2 cell array. The first element is double scalar. The second element is a 1-by-2 array of doubles. However, if you index into this cell array with an index whose value is determined at run time, the code generator classifies it as a homogeneous cell array. The elements are variable-size arrays of doubles with an upper bound of 2.

## Controlling Whether a Cell Array Is Homogeneous or Heterogeneous

For cell arrays with certain characteristics, you cannot control the classification as homogeneous or heterogeneous:

- If the elements have different classes, the cell array must be heterogeneous.
- If the cell array is variable-size, it must be homogeneous.
- If you index into the cell array with an index whose value is determined at run time, the cell array must be homogeneous.

For other cell arrays, you can control the classification as homogeneous or heterogeneous.

- If the cell array is fixed-size, you can force an otherwise homogeneous cell array to be heterogeneous by using `coder.cstructname`. For example:

```
...
c = {1 2 3};
coder.cstructname(c, 'myname');
...
```

- If the cell array elements have the same class, you can force a cell array to be homogeneous by using `coder.varsizes`. See “Control Whether a Cell Array Is Variable-Size” on page 50-5.

## Cell Arrays in Reports

To see whether a cell array is homogeneous or heterogeneous, view the variable in the MATLAB Function report.

For a homogeneous cell array, the report has one entry that specifies the properties of all elements. The notation `{:}` indicates that all elements of the cell array have the same properties.

Summary	All Messages (0)	Variables				
Order	Variable	Type	Size	Class	Complex	
1	z	Output	1 x 1	double	No	
2	c	Local	1 x 2	cell	-	
2.1	<i>c{1}</i>	Element	1 x 1	double	No	

For a heterogeneous cell array, the report has an entry for each element. For example, for a heterogeneous cell array `c` with two elements, the entry for `c{1}` shows the properties for the first element. The entry for `c{2}` shows the properties for the second element.

Summary	All Messages (0)	Variables				
Order	Variable	Type	Size	Class	Complex	
1	z	Output	1 x 1	double	No	
2	c	Local	1 x 2	cell	-	
2.1	<i>c{1}</i>	Element	1 x 1	double	No	
2.2	<i>c{2}</i>	Element	1 x 1	char	-	

## See Also

`coder.cstructname` | `coder.varsizes`

## More About

- “Control Whether a Cell Array Is Variable-Size” on page 50-5
- “Cell Array Limitations for Code Generation” on page 50-8
- “MATLAB Function Reports” on page 40-48

## Control Whether a Cell Array Is Variable-Size

The code generator classifies a variable-size cell array as homogeneous. The cell array elements must have the same class. In the generated code, the cell array is represented as an array.

To make a cell array variable-size:

- Create the cell array by using the `cell` function. For example:

```
function z = mycell(n, j)
%#codegen
assert (n < 100);
x = cell(1,n);
for i = 1:n
    x{i} = i;
end
z = x{j};
end
```

For code generation, when you create a variable-size cell array by using `cell`, you must adhere to certain restrictions. See “Definition of Variable-Size Cell Array by Using `cell`” on page 50-9.

- Grow the cell array. For example:

```
function z = mycell(n)
%#codegen
c = {1 2 3};
if n > 3
    c = {1 2 3 4};
end
z = c{n};
end
```

- Force the cell array to be variable-size by using `coder. varsize`. Consider this code:

```
function y = mycellfun()
%#codegen
c = {1 2 3};
coder. varsize('c', [1 10]);
y = c{1};
end
```

Without `coder.versize`, `c` is fixed-size with dimensions 1-by-3. With `coder.versize`, `c` is variable-size with an upper bound of 10.

Sometimes, using `coder.versize` changes the classification of a cell array from heterogeneous to homogeneous. Consider this code:

```
function y = mycell()
%#codegen
c = {1 [2 3]};
y = c{2};
end
```

The code generator classifies `c` as heterogeneous because the elements have different sizes. `c` is fixed-size with dimensions 1-by-2. If you use `coder.versize` with `c`, it becomes homogeneous. For example:

```
function y = mycell()
%#codegen
c = {1 [2 3]};
coder.versize('c', [1 10], [0 1]);
y = c{2};
end
```

`c` becomes a variable-size homogeneous cell array with dimensions 1-by-:10.

To force `c` to be homogeneous, but not variable-size, specify that none of the dimensions vary. For example:

```
function y = mycell()
%#codegen
c = {1 [2 3]};
coder.versize('c', [1 2], [0 0]);
y = c{2};
end
```

## See Also

`coder.versize`

## More About

- “Code Generation for Cell Arrays” on page 50-2
- “Cell Array Limitations for Code Generation” on page 50-8



- “Code Generation for Variable-Size Arrays” on page 48-2

## Cell Array Limitations for Code Generation

When you use cell arrays in MATLAB code that is intended for code generation, you must adhere to these restrictions:

- “Cell Array Element Assignment” on page 50-8
- “Definition of Variable-Size Cell Array by Using `cell`” on page 50-9
- “Cell Array Indexing” on page 50-13
- “Growing a Cell Array by Using `{end + 1}`” on page 50-13
- “Variable-Size Cell Arrays” on page 50-14
- “Cell Array Contents” on page 50-15
- “Cell Arrays in Structures” on page 50-15
- “Passing Cell Arrays to External C/C++ Functions” on page 50-15
- “Use in MATLAB Function Block” on page 50-15

### Cell Array Element Assignment

You must assign a cell array element on all execution paths before you use it. For example:

```
function z = foo(n)
%#codegen
c = cell(1,3);
if n < 1
    c{2} = 1;

else
    c{2} = n;
end
z = c{2};
end
```

The code generator considers passing a cell array to a function or returning it from a function as a use of all elements of the cell array. Therefore, before you pass a cell array to a function or return it from a function, you must assign all of its elements. For example, the following code is not allowed because it does not assign a value to `c{2}` and `c` is a function output.

```
function c = foo()
%#codegen
```

```
c = cell(1,3);
c{1} = 1;
c{3} = 3;
end
```

The assignment of values to elements must be consistent on all execution paths. The following code is not allowed because `y{2}` is double on one execution path and char on the other execution path.

```
function y = foo(n)
y = cell(1,3)
if n > 1;
    y{1} = 1;
    y{2} = 2;
    y{3} = 3;
else
    y{1} = 10;
    y{2} = 'a';
    y{3} = 30;
end
```

## Definition of Variable-Size Cell Array by Using `cell`

For code generation, before you use a cell array element, you must assign a value to it. When you use `cell` to create a variable-size cell array, for example, `cell(1,n)`, MATLAB assigns an empty matrix to each element. However, for code generation, the elements are unassigned. For code generation, after you use `cell` to create a variable-size cell array, you must assign all elements of the cell array before any use of the cell array. For example:

```
function z = mycell(n, j)
%#codegen
assert(n < 100);
x = cell(1,n);
for i = 1:n
    x{i} = i;
end
z = x{j};
end
```

The code generator analyzes your code to determine whether all elements are assigned before the first use of the cell array. If the code generator detects that some elements are not assigned, code generation fails with a message like this message:

Unable to determine that every element of 'y' is assigned before this line.

Sometimes, even though your code assigns all elements of the cell array, the code generator reports this message because the analysis does not detect that all elements are assigned. See “Unable to Determine That Every Element of Cell Array Is Assigned” on page 56-10.

To avoid this error, follow these guidelines:

- When you use `cell` to define a variable-size cell array, write code that follows this pattern:

```
function z = mycell(n, j)
%#codegen
assert(n < 100);
x = cell(1,n);
for i = 1:n
    x{i} = i;
end
z = x{j};
end
```

Here is the pattern for a multidimensional cell array:

```
function z = mycell(m,n,p)
%#codegen
assert(m < 100);
assert(n < 100);
assert(p < 100);
x = cell(m,n,p);
for i = 1:m
    for j = 1:n
        for k = 1:p
            x{i,j,k} = i+j+k;
        end
    end
end
z = x{m,n,p};
end
```

- Increment or decrement the loop counter by 1.
- Define the cell array within one loop or one set of nested loops. For example, this code is not allowed:

```
function z = mycell(n, j)
```

```

assert(n < 50);
assert(j < 50);
x = cell(1,n);
for i = 1:5
    x{i} = 5;
end
for i = 6:n
    x{i} = 5;
end
z = x{j};
end

```

- Use the same variables for the cell dimensions and loop initial and end values. For example, code generation fails for the following code because the cell creation uses `n` and the loop end value uses `m`:

```

function z = mycell(n, j)
assert(n < 50);
assert(j < 50);
x = cell(1,n);
m = n;
for i = 1:m
    x{i} = 2;
end
z = x{j};
end

```

Rewrite the code to use `n` for the cell creation and the loop end value:

```

function z = mycell(n, j)
assert(n < 50);
assert(j < 50);
x = cell(1,n);
for i = 1:n
    x{i} = 2;
end
z = x{j};
end

```

- Create the cell array with this pattern:

```
x = cell(1,n)
```

Do not assign the cell array to a field of a structure or a property of an object. For example, this code is not allowed:

```
myobj.prop = cell(1,n)
for i = 1:n
    ...
end
```

Do not use the `cell` function inside the cell array constructor `{}`. For example, this code is not allowed:

```
x = {cell(1,n)};
```

- The cell array creation and the loop that assigns values to the cell array elements must be together in a unique execution path. For example, the following code is not allowed.

```
function z = mycell(n)
assert(n < 100);
if n > 3
    c = cell(1,n);
else
    c = cell(n,1);
end
for i = 1:n
    c{i} = i;
end
z = c{n};
end
```

To fix this code, move the assignment loop inside the code block that creates the cell array.

```
function z = cellerr(n)
assert(n < 100);
if n > 3
    c = cell( 1,n);
    for i = 1:n
        c{i} = i;
    end
else
    c = cell(n,1);
    for i = 1:n
        c{i} = i;
    end
end
z = c{n};
```

```
end
```

## Cell Array Indexing

- You cannot index cell arrays by using smooth parentheses (). Consider indexing cell arrays by using curly braces{} to access the contents of the cell.
- You must index into heterogeneous cell arrays by using constant indices or by using for-loops with constant bounds.

For example, the following code is not allowed.

```
x = {1, 'mytext'};
disp(x{randi});
```

You can index into a heterogeneous cell array in a for-loop with constant bounds because the code generator unrolls the loop. Unrolling creates a separate copy of the loop body for each loop iteration, which makes the index in each loop iteration constant. However, if the for-loop has a large body or it has many iterations, the unrolling can increase compile time and generate inefficient code.

If A and B are constant, the following code shows indexing into a heterogeneous cell array in a for-loop with constant bounds.

```
x = {1, 'mytext'};
for i = A:B
    disp(x{i});
end
```

## Growing a Cell Array by Using {end + 1}

To grow a cell array X, you can use X{end + 1}. For example:

```
...
X = {1 2};
X{end + 1} = 'a';
...
```

When you use {end + 1} to grow a cell array, follow these restrictions:

- In a MATLAB Function block, do not use {end + 1} in a for-loop.
- Use only {end + 1}. Do not use {end + 2}, {end + 3}, and so on.

- Use `{end + 1}` with vectors only. For example, the following code is not allowed because `X` is a matrix, not a vector:

```
...  
X = {1 2; 3 4};  
X{end + 1} = 5;
```

```
...
```

- Use `{end + 1}` only with a variable. In the following code, `{end + 1}` does not cause `{1 2 3}` to grow. In this case, the code generator treats `{end + 1}` as an out-of-bounds index into `X{2}`.

```
...  
X = {'a' { 1 2 3 }};  
X{2}{end + 1} = 4;
```

```
...
```

- When `{end + 1}` grows a cell array in a loop, the cell array must be variable-size. Therefore, the cell array must be homogeneous.

This code is allowed because `X` is homogeneous.

```
...  
X = {1 2};  
for i=1:n  
    X{end + 1} = 3;  
end  
...
```

This code is not allowed because `X` is heterogeneous.

```
...  
X = {1 'a' 2 'b'};  
for i=1:n  
    X{end + 1} = 3;  
end  
...
```

## Variable-Size Cell Arrays

- Heterogeneous cell arrays cannot be variable-size.
- If you use `coder.varsize` to make a variable-size cell array, define the cell array with curly braces. For example:



```
...  
c = {1 [2 3]};  
coder.varsize('c')  
...
```

Do not use the `cell` function. For example, this code is not allowed:

```
...  
c = cell(1,3);  
coder.varsize('c')  
...
```

## Cell Array Contents

Cell arrays cannot contain `mxarrays`. In a cell array, you cannot store a value that an extrinsic function returns.

## Cell Arrays in Structures

Structures cannot contain cell arrays.

## Passing Cell Arrays to External C/C++ Functions

You cannot pass a cell array to `coder.ceval`. If a variable is an input argument to `coder.ceval`, define the variable as an array or structure instead of as a cell array.

## Use in MATLAB Function Block

You cannot use cell arrays for Simulink signals, parameters, or data store memory.

## More About

- “Code Generation for Cell Arrays” on page 50-2
- “Differences Between Generated Code and MATLAB Code” on page 43-9



# Code Generation for MATLAB Classes

---

- “MATLAB Classes Definition for Code Generation” on page 51-2
- “Classes That Support Code Generation” on page 51-8
- “Generate Code for MATLAB Value Classes” on page 51-9
- “Generate Code for MATLAB Handle Classes and System Objects” on page 51-14
- “MATLAB Classes in Code Generation Reports” on page 51-17
- “Troubleshooting Code Generation Issues with MATLAB Classes” on page 51-20
- “Handle Object Limitations for Code Generation” on page 51-22
- “System Objects in MATLAB Code Generation” on page 51-25

## MATLAB Classes Definition for Code Generation

To generate efficient standalone code for MATLAB classes, you must use classes differently than when running your code in the MATLAB environment.

What's Different	More Information
Class must be in a single file. Because of this limitation, code generation is not supported for a class definition that uses an @-folder.	“Create a Single, Self-Contained Class Definition File” (MATLAB)
Restricted set of language features.	“Language Limitations” on page 51-2
Restricted set of code generation features.	“Code Generation Features Not Compatible with Classes” on page 51-3
Definition of class properties.	“Defining Class Properties for Code Generation” on page 51-4
Use of handle classes.	“Generate Code for MATLAB Handle Classes and System Objects” on page 51-14  “Handle Object Limitations for Code Generation” on page 51-22
Calls to base class constructor.	“Calls to Base Class Constructor” on page 51-6
Global variables containing MATLAB objects are not supported for code generation.	N/A
Inheritance from built-in MATLAB classes is not supported.	“Inheritance from Built-In MATLAB Classes Not Supported” on page 51-7

### Language Limitations

Although code generation support is provided for common features of classes such as properties and methods, there are a number of advanced features which are not supported, such as:

- Events

- Listeners
- Arrays of objects
- Recursive data structures
  - Linked lists
  - Trees
  - Graphs
- Overloadable operators `subsref`, `subsassign`, and `subsindex`

In MATLAB, classes can define their own versions of the `subsref`, `subsassign`, and `subsindex` methods. Code generation does not support classes that have their own definitions of these methods.

- The `empty` method

In MATLAB, classes have a built-in static method, `empty`, which creates an empty array of the class. Code generation does not support this method.

- The following MATLAB handle class methods:
  - `addlistener`
  - `delete`
  - `eq`
  - `findobj`
  - `findpro`
- The `AbortSet` property attribute

## Code Generation Features Not Compatible with Classes

- You can generate code for entry-point MATLAB functions that use classes, but you cannot generate code directly for a MATLAB class.

For example, if `ClassNameA` is a class definition, you cannot generate code by executing:

```
codegen ClassNameA
```

- A handle class object cannot be an entry-point function input or output.
- A value class object can be an entry-point function input or output. However, if a value class object contains a handle class object, then the value class object cannot be

an entry-point function input or output. A handle class object cannot be an entry-point function input or output.

- Code generation does not support classes in matrices or structures. As a workaround, consider using cell arrays because code generation supports classes in cell arrays.
- Code generation does not support assigning an object of a value class into a nontunable property. For example, `obj.prop=v`; is invalid when `prop` is a nontunable property and `v` is an object based on a value class.
- You cannot use `coder.extrinsic` to declare a class or method as extrinsic.
- You cannot pass a MATLAB class to the `coder.ceval` function.
- If you use classes in code in the MATLAB Function block, you cannot use the debugger to view class information.
- The `coder.nullcopy` function does not support MATLAB classes as inputs.
- The `coder.Constant` function does not support MATLAB classes as inputs.

## Defining Class Properties for Code Generation

For code generation, you must define class properties differently than you do when running your code in the MATLAB environment:

- Code generation does not support the property restriction syntax. For example, the following class definition is not allowed because it uses the property restriction syntax to restrict the types of the `Number` and `Today` properties.

```
classdef Myclass
    properties
        Number double
        Today char = date;
    end
end
```

- After defining a property, do not assign it an incompatible type. Do not use a property before attempting to grow it.

When you define class properties for code generation, consider the same factors that you take into account when defining variables. In the MATLAB language, variables can change their class, size, or complexity dynamically at run time so you can use the same variable to hold a value of varying class, size, or complexity. C and C++ use static typing. Before using variables, to determine their type, the code generator requires a complete assignment to each variable. Similarly, before using properties, you must explicitly define their class, size, and complexity.

- Initial values:
  - If the property does not have an explicit initial value, the code generator assumes that it is undefined at the beginning of the constructor. The code generator does not assign an empty matrix as the default.
  - If the property does not have an initial value and the code generator cannot determine that the property is assigned prior to first use, the software generates a compilation error.
  - For System objects, if a nontunable property is a structure, you must completely assign the structure. You cannot do partial assignment using subscripting.

For example, for a nontunable property, you can use the following assignment:

```
mySystemObject.nonTunableProperty=struct('fieldA','a','fieldB','b');
```

You cannot use the following partial assignments:

```
mySystemObject.nonTunableProperty.fieldA = 'a';
mySystemObject.nonTunableProperty.fieldB = 'b';
```

- `coder. varsize` is not supported for class properties.
- If the initial value of a property is an object, then the property must be constant. To make a property constant, declare the `Constant` attribute in the property block. For example:
 

```
classdef MyClass
    properties (Constant)
        p1 = MyClass2;
    end
end
```
- MATLAB computes class initial values at class loading time before code generation. If you use persistent variables in MATLAB class property initialization, the value of the persistent variable computed when the class loads belongs to MATLAB; it is not the value used at code generation time. If you use `coder.target` in MATLAB class property initialization, `coder.target('MATLAB')` returns `true (1)`.
- If dynamic memory allocation is enabled, code generation supports variable-size properties for handle classes. Without dynamic memory allocation, you cannot generate code for handle classes that have variable-size properties.
- If a property is constant and its value is an object, you cannot change the value of a property of that object. For example, suppose that:

- `obj` is an object of `myClass1`.
- `myClass1` has a constant property `p1` that is an object of `myClass2`.
- `myClass2` has a property `p2`.

Code generation does not support the following code:

```
obj.p1.p2 = 1;
```

## Calls to Base Class Constructor

If a class constructor contains a call to the constructor of the base class, the call to the base class constructor must come before `for`, `if`, `return`, `switch` or `while` statements.

For example, if you define a class `B` based on class `A`:

```
classdef B < A
    methods
        function obj = B(varargin)
            if nargin == 0
                a = 1;
                b = 2;
            elseif nargin == 1
                a = varargin{1};
                b = 1;
            elseif nargin == 2
                a = varargin{1};
                b = varargin{2};
            end
            obj = obj@A(a,b);
        end
    end
end
```

Because the class definition for `B` uses an `if` statement before calling the base class constructor for `A`, you cannot generate code for function `callB`:

```
function [y1,y2] = callB
x = B;
y1 = x.p1;
y2 = x.p2;
end
```



However, you can generate code for `callB` if you define class `B` as:

```
classdef B < A
    methods
        function obj = NewB(varargin)
            [a,b] = getaandb(varargin{:});
            obj = obj@A(a,b);
        end
    end
end

function [a,b] = getaandb(varargin)
if nargin == 0
    a = 1;
    b = 2;
elseif nargin == 1
    a = varargin{1};
    b = 1;
elseif nargin == 2
    a = varargin{1};
    b = varargin{2};
end
end
```

## Inheritance from Built-In MATLAB Classes Not Supported

You cannot generate code for classes that inherit from built-in MATLAB classes. For example, you cannot generate code for the following class:

```
classdef myclass < double
```

## Classes That Support Code Generation

You can generate code for MATLAB value and handle classes and user-defined System objects. Your class can have multiple methods and properties and can inherit from multiple classes.

To generate code for:	Example:
Value classes	“Generate Code for MATLAB Value Classes” on page 51-9
Handle classes including user-defined System objects	“Generate Code for MATLAB Handle Classes and System Objects” on page 51-14

For more information, see:

- “Role of Classes in MATLAB” (MATLAB)
- “MATLAB Classes Definition for Code Generation” on page 51-2

## Generate Code for MATLAB Value Classes

This example shows how to generate code for a MATLAB value class and then view the generated code in the code generation report.

- 1 In a writable folder, create a MATLAB value class, `Shape`. Save the code as `Shape.m`.

```

classdef Shape
% SHAPE Create a shape at coordinates
% centerX and centerY
    properties
        centerX;
        centerY;
    end
    properties (Dependent = true)
        area;
    end
    methods
        function out = get.area(obj)
            out = obj.getarea();
        end
        function obj = Shape(centerX,centerY)
            obj.centerX = centerX;
            obj.centerY = centerY;
        end
    end
end
methods(Abstract = true)
    getarea(obj);
end
methods(Static)
    function d = distanceBetweenShapes(shape1,shape2)
        xDist = abs(shape1.centerX - shape2.centerX);
        yDist = abs(shape1.centerY - shape2.centerY);
        d = sqrt(xDist^2 + yDist^2);
    end
end
end
end

```

- 2 In the same folder, create a class, `Square`, that is a subclass of `Shape`. Save the code as `Square.m`.

```

classdef Square < Shape
% Create a Square at coordinates center X and center Y

```

```
% with sides of length of side
properties
    side;
end
methods
    function obj = Square(side,centerX,centerY)
        obj@Shape(centerX,centerY);
        obj.side = side;
    end
    function Area = getarea(obj)
        Area = obj.side^2;
    end
end
end
```

- 3 In the same folder, create a class, Rhombus, that is a subclass of Shape. Save the code as Rhombus.m.

```
classdef Rhombus < Shape
    properties
        diag1;
        diag2;
    end
    methods
        function obj = Rhombus(diag1,diag2,centerX,centerY)
            obj@Shape(centerX,centerY);
            obj.diag1 = diag1;
            obj.diag2 = diag2;
        end
        function Area = getarea(obj)
            Area = 0.5*obj.diag1*obj.diag2;
        end
    end
end
end
```

- 4 Write a function that uses this class.

```
function [TotalArea, Distance] = use_shape
    %#codegen
    s = Square(2,1,2);
    r = Rhombus(3,4,7,10);
    TotalArea = s.area + r.area;
    Distance = Shape.distanceBetweenShapes(s,r);
```

- 5 Generate a static library for use\_shape and generate a code generation report.

codegen -config:lib -report use\_shape

codegen generates a C static library with the default name, use\_shape, and supporting files in the default folder, codegen/lib/use\_shape.

- 6 Click the **View report** link.
- 7 In the report, on the **MATLAB code** tab, click the link to the Rhombus class.

The report displays the class definition of the Rhombus class and highlights the class constructor. On the **Variables** tab, it provides details of the variables used in the class. If a variable is a MATLAB object, by default, the report displays the object without displaying its properties. To view the list of properties, expand the list. Within the list of properties, the list of inherited properties is collapsed. In the following report, the lists of properties and inherited properties are expanded.

The screenshot shows the Code Generation Report window with the MATLAB code tab selected. The code defines the Rhombus class, its properties (diag1, diag2), and methods (constructor, getarea). The Variables tab is also visible, showing a table of variables used in the code.

Order	Variable	Type	Size	Class	Complex
1	obj	Output	1 x 1	Rhombus	-
1.1		Inherited		Shape	
1.2	diag1	Property	1 x 1	double	No
1.3	diag2	Property	1 x 1	double	No
2	diag1	Input	1 x 1	double	No
3	diag2	Input	1 x 1	double	No
4	centerX	Input	1 x 1	double	No
5	centerY	Input	1 x 1	double	No

- 8 At the top right side of the report, expand the **Calls** list.

The **Calls** list shows that there is a call to the Rhombus constructor from `use_shape` and that this constructor calls the Shape constructor.

The screenshot shows the 'Code Generation Report' window. On the left, a tree view shows the project structure with 'Rhombus' selected under 'Classes'. The main pane displays the MATLAB code for the 'Rhombus' class, including the constructor call `obj = Rhombus(diag1,diag2,centerX,centerY)` on line 7. A 'Calls' dropdown menu is open, showing a call from 'use\_shape line 4'. Below the code is a 'Variables' table.

Order	Variable	Type	Size	Class	Complex
1	obj	Output	1 x 1	Rhombus	-
1.1		Inherited		Shape	
1.2	diag1	Property	1 x 1	double	No
1.3	diag2	Property	1 x 1	double	No
2	diag1	Input	1 x 1	double	No
3	diag2	Input	1 x 1	double	No
4	centerX	Input	1 x 1	double	No
5	centerY	Input	1 x 1	double	No

- 9 The constructor for the Rhombus class calls the Shape method of the base Shape class: `obj@Shape`. In the report, click the Shape link in this call.

The link takes you to the Shape method in the Shape class definition.

The screenshot shows the 'Code Generation Report' window with the 'MATLAB code' tab selected. On the left, a tree view shows the project structure with 'use\_shape' under Functions and 'Rhombus', 'Shape', and 'Square' under Classes. The main area displays the MATLAB code for the 'Shape' method, including a constructor and a distance calculation function. Below the code is a table with columns for 'Summary', 'All Messages (0)', 'Variables', and 'Target Build Log'. The 'Variables' column is active, showing a table with 7 columns: Order, Variable, Type, Size, Class, and Complex.

```
11 methods
12     function out = get.area(obj)
13         out = obj.getarea();
14     end
15     function obj = Shape(centerX,centerY)
16         obj.centerX = centerX;
17         obj.centerY = centerY;
18     end
19 end
20 methods(Abstract = true)
21     getarea(obj);
22 end
23 methods(Static)
24     function d = distanceBetweenShapes(shape1,shape2)
25         xDist = abs(shape1.centerX - shape2.centerX);
26         yDist = abs(shape1.centerY - shape2.centerY);
27         d = sqrt(xDist^2 + yDist^2);
28     end
29 end
30 end
31
```

Order	Variable	Type	Size	Class	Complex
1	obj	Output	1 x 1	Rhombus	-
2	centerX	Input	1 x 1	double	No
3	centerY	Input	1 x 1	double	No

## Generate Code for MATLAB Handle Classes and System Objects

This example shows how to generate code for a user-defined System object and then view the generated code in the code generation report.

- 1 In a writable folder, create a System object, `AddOne`, which subclasses from `matlab.System`. Save the code as `AddOne.m`.

```
classdef AddOne < matlab.System
% ADDONE Compute an output value that increments the input by one

    methods (Access=protected)
        % stepImpl method is called by the step method
        function y = stepImpl(~,x)
            y = x+1;
        end
    end
end
```

- 2 Write a function that uses this System object.

```
function y = testAddOne(x)
%#codegen
    p = AddOne();
    y = p.step(x);
end
```

- 3 Generate a MEX function for this code.

```
codegen -report testAddOne -args {0}
```

The `-report` option instructs `codegen` to generate a code generation report, even if no errors or warnings occur. The `-args` option specifies that the `testAddOne` function takes one scalar double input.

- 4 Click the **View report** link.
- 5 In the report, on the **MATLAB Code** tab **Functions** panel, click `testAddOne`, then click the **Variables** tab. You can view information about the variable `p` on this tab.



The screenshot shows the 'Code Generation Report' window with the following content:

**MATLAB code** | Call stack | C code

Function: `testAddOne` | Calls: Select a function call:

```

1 function y = testAddOne(x)
2 %#codegen
3 p = AddOne();
4 y
5 end

```

Information for the selected variable:

Size	1 x 1
Class	AddOne

Summary	All Messages (0)	Variables	Target Build Log		
Order	Variable	Type	Size	Class	Complex
1	y	Output	1 x 1	double	No
2	x	Input	1 x 1	double	No
3	p	Local	1 x 1	AddOne	-

- To view the class definition, on the **Classes** panel, click AddOne.

The screenshot shows the 'Code Generation Report' window with the following structure:

- Navigation:** MATLAB code (selected), Call stack, C code.
- Filter:** testAddOne
- Classes:** AddOne
  - AddOne (selected)
    - AddOne (selected)
    - stepImpl

The main content area displays the MATLAB code for the `AddOne` method:

```

1 classdef AddOne < matlab.System
2 % ADDONE Compute an output value that increments the input by one
3
4     methods (Access=protected)
5         % stepImpl method is called by the step method
6         function y = stepImpl(~,x)
7             y = x+1;
8         end
9     end
10 end
11

```

Below the code is a table with the following tabs: Summary, All Messages (0), Variables (selected), Target Build Log.

Order	Variable	Type	Size	Class	Complex

# MATLAB Classes in Code Generation Reports

## What Reports Tell You About Classes

Code generation reports:

- Provide a hierarchical tree of the classes used in your MATLAB code.
- Display a list of methods for each class in the MATLAB code tab.
- Display the objects used in your MATLAB code together with their properties on the **Variables** tab.
- Provide a filter so that you can sort methods by class, size, and complexity.
- List the set of calls from and to the selected method in the **Calls** list.

## How Classes Appear in Code Generation Reports

### In the MATLAB Code Tab

The report displays an alphabetical hierarchical list of the classes used in the your MATLAB code. For each class, you can:

- Expand the class information to view the class methods.
- View a class method by clicking its name. The report displays the methods in the context of the full class definition.
- Filter the methods by size, complexity, and class by using the **Filter functions and methods** option.

### Default Constructors

If a class has a default constructor, the report displays the constructor in italics.

### Specializations

If the same class is specialized into multiple different classes, the report differentiates the specializations by grouping each one under a single node in the tree. The report associates the class definition functions and static methods with the primary node. It associates the instance-specific methods with the corresponding specialized node.

For example, consider a base class, **Shape** that has two specialized subclasses, **Rhombus** and **Square**. The **Shape** class has an abstract method, `getarea`, and a static method, `distanceBetweenShapes`. The code generation report, displays a

node for the specialized `Rhombus` and `Square` classes with their constructors and `getarea` method. It displays a node for the `Shape` class and its associated static method, `distanceBetweenShapes`, and two instances of the `Shape` class, `Shape1` and `Shape2`.

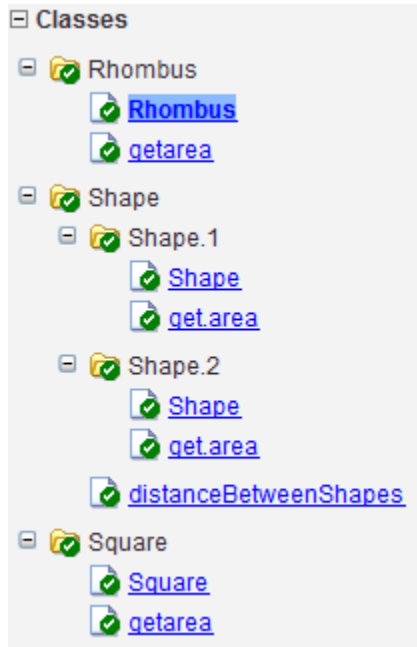

### Packages

If you define classes as part of a package, the report displays the package in the list of classes. You can expand the package to view the classes that it contains. For more information about packages, see “Packages Create Namespaces” (MATLAB).

### In the Variables Tab

The report displays the objects in the selected function or class. By default, for classes that have properties, the list of properties is collapsed. To expand the list, click the + symbol next to the object name. Within the list of properties, the list of inherited properties is collapsed. To expand the list of inherited properties, click the + symbol next to `Inherited`.

The report displays the properties using just the base property name, not the fully qualified name. For example, if your code uses variable `obj1` that is a MATLAB object

with property `prop1`, then the report displays the property as `prop1` not `obj1.prop1`. When you sort the **Variables** column, the sort order is based on the fully qualified property name.

### **In the Call Stack**

The call stack lists the functions and methods in the order that the top-level function calls them. It also lists the local functions that each function calls.

## Troubleshooting Code Generation Issues with MATLAB Classes

### Class *cClass* does not have a property with name *name*

If a MATLAB class has a method, `mymethod`, that returns a handle class with a property, `myprop`, you cannot generate code for the following type of assignment:

```
obj.mymethod().myprop=...
```

For example, consider the following classes:

```
classdef MyClass < handle
    properties
        myprop
    end
    methods
        function this = MyClass
            this.myprop = MyClass2;
        end
        function y = mymethod(this)
            y = this.myprop;
        end
    end
end

classdef MyClass2 < handle
    properties
        aa
    end
end
```

You cannot generate code for function `foo`.

```
function foo
    h = MyClass;
```

```
    h.mymethod().aa = 12;
```

In this function, `h.mymethod()` returns a handle object of type `MyClass2`. In MATLAB, the assignment `h.mymethod().aa = 12;` changes the property of that object. Code generation does not support this assignment.

**Solution**

Rewrite the code to return the object and then assign a value to a property of the object.

```
function foo  
h = MyClass;  
  
b=h.mymethod();  
b.aa=12;
```

## Handle Object Limitations for Code Generation

The code generator statically determines the lifetimes of handle objects. It can reuse memory rather than rely on a dynamic memory management scheme such as reference counting or garbage collection. It generates code that does not use dynamic memory allocation or incur the overhead of run-time automatic memory management. These characteristics of the generated code are important for some safety-critical and real-time applications.

When you use handle objects, the static analysis that the code generator uses requires that you adhere to the following restrictions:

- “A Variable Outside a Loop Cannot Refer to a Handle Object Created Inside a Loop” on page 51-22
- “A Handle Object That a Persistent Variable Refers To Must Be a Singleton Object” on page 51-22

### A Variable Outside a Loop Cannot Refer to a Handle Object Created Inside a Loop

Consider the handle class `mycls` and the function `usehandle1`. The code generator reports an error because `p`, which is outside the loop, has a property that refers to a `mycls` object created inside the loop.

```
classdef mycls < handle
    properties
        prop
    end
end

function usehandle1
    p = mycls;
    for i = 1:10
        p.prop = mycls;
    end
end
```

### A Handle Object That a Persistent Variable Refers To Must Be a Singleton Object

If a persistent variable refers to a handle object, the code generator allows only one instance of the object during the program’s lifetime. The object must be a *singleton* object.



To create a singleton handle object, enclose statements that create the object in the `if isempty()` guard for the persistent variable.

For example, consider the class `mycls` and the function `usehandle2`. The code generator reports an error for `usehandle2` because `p.prop` refers to the `mycls` object that the statement `inner = mycls` creates. This statement creates a `mycls` object for each invocation of `usehandle2`.

```
classdef mycls < handle
    properties
        prop
    end
end

function usehandle2(x)
    assert(isa(x, 'double'));
    persistent p;
    inner = mycls;
    inner.prop = x;
    if isempty(p)
        p = mycls;
        p.prop = inner;
    end
end
```

If you move the statements `inner = mycls` and `inner.prop = x` inside the `if isempty()` guard, code generation succeeds. The statement `inner = mycls` executes only once during the program's lifetime.

```
function usehandle2(x)
    assert(isa(x, 'double'));
    persistent p;
    if isempty(p)
        inner = mycls;
        inner.prop = x;
        p = mycls;
        p.prop = inner;
    end
end
```

Consider the function `usehandle3`. The code generator reports an error for `usehandle3` because the persistent variable `p` refers to the `mycls` object that the statement `myobj = mycls` creates. This statement creates a `mycls` object for each invocation of `usehandle3`.

```
function usehandle3(x)
```

```
assert(isa(x, 'double'));
myobj = mycls;
myobj.prop = x;
doinit(myobj);
disp(myobj.prop);
function doinit(obj)
persistent p;
if isempty(p)
    p = obj;
end
```

If you make `myobj` persistent and enclose the statement `myobj = mycls` inside an `if isempty()` guard, code generation succeeds. The statement `myobj = mycls` executes only once during the program's lifetime.

```
function usehandle3(x)
assert(isa(x, 'double'));
persistent myobj;
if isempty(myobj)
    myobj = mycls;
end

doinit(myobj);

function doinit(obj)
persistent p;
if isempty(p)
    p = obj;
end
```

# System Objects in MATLAB Code Generation

## In this section...

“Usage Rules and Limitations for System Objects for Generating Code” on page 51-25

“System Objects in codegen” on page 51-28

“System Objects in the MATLAB Function Block” on page 51-28

“System Objects in the MATLAB System Block” on page 51-28

“System Objects and MATLAB Compiler Software” on page 51-28

You can generate C/C++ code in MATLAB from your system that contains System objects by using MATLAB Coder. You can generate efficient and compact code for deployment in desktop and embedded systems and accelerate fixed-point algorithms.

## Usage Rules and Limitations for System Objects for Generating Code

The following usage rules and limitations apply to using System objects in code generated from MATLAB.

### Object Construction and Initialization

- If objects are stored in persistent variables, initialize System objects once by embedding the object handles in an `if` statement with a call to `isempty()`.
- Set arguments to System object constructors as compile-time constants.
- You cannot initialize System objects properties with other MATLAB class objects as default values in code generation. You must initialize these properties in the constructor.

### Inputs and Outputs

- System objects accept a maximum of 1024 inputs. A maximum of eight dimensions per input is supported.
- The data type of the inputs should not change.
- If you want the size of inputs to change, verify that support for variable-size is enabled. Code generation support for variable-size data also requires that variable-

size support is enabled. By default in MATLAB, support for variable-size data is enabled.

- System objects predefined in the software do not support variable-size if their data exceeds the `DynamicMemoryAllocationThreshold` value.
- Do not set System objects to become outputs from the MATLAB Function block.
- Do not use the Save and Restore Simulation State as `SimState` option for any System object in a MATLAB Function block.
- Do not pass a System object as an example input argument to a function being compiled with `codegen`.
- Do not pass a System object to functions declared as extrinsic (functions called in interpreted mode) using the `coder.extrinsic` function. System objects returned from extrinsic functions and scope System objects that automatically become extrinsic can be used as inputs to another extrinsic function. But, these functions do not generate code.

### Properties

- In MATLAB System blocks, you cannot use variable-size for discrete state properties of System objects. Private properties can be variable-size.
- Objects cannot be used as default values for properties.
- You can only assign values to nontunable properties once, including the assignment in the constructor.
- Nontunable property values must be constant.
- If a tunable property has dependant data type properties, you can set tunable properties only at construction time or after the object is locked.
- For `getNumInputsImpl` and `getNumOutputsImpl` methods, if you set the return argument from an object property, that object property must have the `Nontunable` attribute.

### Global Variables

- Global variables are allowed in a System object, unless you are using that System object in Simulink via the MATLAB System block. To avoid syncing global variables between a MEX file and the workspace, use a `coder` configuration object. For example:

```
f = coder.MEXConfig;  
f.GlobalSyncMethod = 'NoSync'
```

Then, include `'-config f'` in your `codegen` command.

## Methods

- Code generation support is available only for these System object methods:
  - `get`
  - `getNumInputs`
  - `getNumOutputs`
  - `isDone` (for sources only)
  - `isLocked`
  - `release`
  - `reset`
  - `set` (for tunable properties)
  - `step`
- For System objects that you define, code generation support is available only for these methods:
  - `getDiscreteStateImpl`
  - `getNumInputsImpl`
  - `getNumOutputsImpl`
  - `infoImpl`
  - `isDoneImpl`
  - `isInputDirectFeedthroughImpl`
  - `outputImpl`
  - `processTunedPropertiesImpl`
  - `releaseImpl` — Code is not generated automatically for this method. To release an object, you must explicitly call the `release` method in your code.
  - `resetImpl`
  - `setupImpl`
  - `stepImpl`
  - `updateImpl`
  - `validateInputsImpl`

- `validatePropertiesImpl`

## System Objects in codegen

You can include System objects in MATLAB code in the same way you include any other elements. You can then compile a MEX file from your MATLAB code by using the `codegen` command, which is available if you have a MATLAB Coder license. This compilation process, which involves a number of optimizations, is useful for accelerating simulations. See “Getting Started with MATLAB Coder” (MATLAB Coder) and “MATLAB Classes” (MATLAB Coder) for more information.

---

**Note:** Most, but not all, System objects support code generation. Refer to the particular object’s reference page for information.

---

## System Objects in the MATLAB Function Block

Using the MATLAB Function block, you can include any System object and any MATLAB language function in a Simulink model. This model can then generate embeddable code. System objects provide higher-level algorithms for code generation than do most associated blocks. For more information, see “What Is a MATLAB Function Block?” on page 40-5.

## System Objects in the MATLAB System Block

Using the MATLAB System block, you can include in a Simulink model individual System objects that you create with a class definition file. The model can then generate embeddable code. For more information, see “MATLAB System Block” on page 42-2.

## System Objects and MATLAB Compiler Software

MATLAB Compiler software supports System objects for use inside MATLAB functions. The compiler product does not support System objects for use in MATLAB scripts.

# Code Generation for Function Handles

## Function Handle Limitations for Code Generation

When you use function handles in MATLAB code intended for code generation, adhere to the following restrictions:

### **Do not use the same bound variable to reference different function handles**

In some cases, using the same bound variable to reference different function handles causes a compile-time error. For example, this code does not compile:

```
function y = foo(p)
x = @plus;
if p
    x = @minus;
end
y = x(1, 2);
```

### **Do not pass function handles to or from `coder.ceval`**

You cannot pass function handles as inputs to or outputs from `coder.ceval`. For example, suppose that `f` and `str.f` are function handles:

```
f = @sin;
str.x = pi;
str.f = f;
```

The following statements result in compilation errors:

```
coder.ceval('foo', @sin);
coder.ceval('foo', f);
coder.ceval('foo', str);
```

### **Do not associate a function handle with an extrinsic function**

You cannot create a function handle that references an extrinsic MATLAB function.

### **Do not pass function handles to or from extrinsic functions**

You cannot pass function handles to or from `feval` and other extrinsic MATLAB functions.

### **Do not pass function handles to or from entry-point functions**

You cannot pass function handles as inputs to or outputs from entry-point functions. For example, consider this function:



```
function x = plotFcn(fhandle, data)

assert(isa(fhandle, 'function_handle') && isa(data, 'double'));

plot(data, fhandle(data));
x = fhandle(data);
```

In this example, the function `plotFcn` receives a function handle and its data as inputs. `plotFcn` attempts to call the function referenced by the `fhandle` with the input `data` and plot the results. However, this code generates a compilation error. The error indicates that the function `isa` does not recognize `'function_handle'` as a class name when called inside a MATLAB function to specify properties of inputs.

### **Do not try to view function handles from the debugger**

You cannot display or watch function handles from the debugger. The function handles appear as empty matrices.

### **Do not use function handles for Simulink signals, parameters, or data store memory**

You can use function handles in a MATLAB Function block. You cannot use function handles for Simulink signals, parameters, or data store memory.

## **More About**

- “Declaring MATLAB Functions as Extrinsic Functions” on page 54-10



# Defining Functions for Code Generation

---

- “Code Generation for Variable Length Argument Lists” on page 53-2
- “Specify Number of Entry-Point Function Input or Output Arguments to Generate” on page 53-3
- “Code Generation for Anonymous Functions” on page 53-5
- “Code Generation for Nested Functions” on page 53-6

## Code Generation for Variable Length Argument Lists

When you use `varargin` and `varargout` for code generation, there are these restrictions:

- You cannot use `varargin` or `varargout` in the function definition for a top-level function in a MATLAB Function block or in a Stateflow chart that uses MATLAB as the action language.
- If you use `varargin` to define an argument to an entry-point function, the code generator produces the function with a fixed number of arguments. This fixed number of arguments is based on the number of arguments that you specify when you generate code.
- You cannot write to `varargin`. If you want to write to input arguments, copy the values into a local variable.
- To index into `varargin` and `varargout`, use curly braces `{}`, not parentheses `()`.
- The code generator must be able to determine the value of the index into `varargin` or `varargout`.

### More About

- “Nonconstant Index into `varargin` or `varargout` in a for-Loop” on page 56-14
- “Specify Number of Entry-Point Function Input or Output Arguments to Generate” on page 53-3

## Specify Number of Entry-Point Function Input or Output Arguments to Generate

You can control the number of input or output arguments in a generated entry-point function. From one MATLAB function, you can generate entry-point functions that have different signatures.

### Control Number of Input Arguments

If your entry-point function uses `varargin`, specify the properties for the arguments that you want in the generated function.

Consider this function:

```
function [x, y] = myops(varargin)
%#codegen
if (nargin > 1)
    x = varargin{1} + varargin{2};
    y = varargin{1} * varargin{2};
else
    x = varargin{1};
    y = -varargin{1};
end
```

To generate a function that takes only one argument, provide one argument with `-args`.

Consider this function:

```
function [x, y] = myops(a,b)
%#codegen
if (nargin > 1)
    x = a + b;
    y = a * b;
else
    x = a;
    y = -a;
end
```

To generate a function that takes only one argument, provide one argument with `-args`.

### Control the Number of Output Arguments

, you can specify the number of output arguments by using the `-nargout` option.

Consider this function:

```
function [x, y] = myops(a,b)
%#codegen
if (nargin > 1)
    x = a + b;
    y = a * b;
else
    x = a;
    y = -a;
end
```

Generate a function that has one output argument.

You can also use `-nargout` to specify the number of arguments for an entry-point function that uses `varargout`.

Rewrite `myops` to use `varargout`.

```
function varargout = myops(a,b)
%#codegen
if (nargin > 1)
    varargout{1} = a + b;
    varargout{2} = a * b;
else
    varargout{1} = a;
    varargout{2} = -a;
end
```

Generate code for one output argument.

## More About

- “Code Generation for Variable Length Argument Lists” on page 53-2

## Code Generation for Anonymous Functions

You can use anonymous functions in MATLAB code intended for code generation. For example, you can generate code for the following MATLAB code that defines an anonymous function that finds the square of a number.

```
sqr = @(x) x.^2;  
a = sqr(5);
```

Anonymous functions are useful for creating a function handle to pass to a MATLAB function that evaluates an expression over a range of values. For example, this MATLAB code uses an anonymous function to create the input to the `fzero` function:

```
b = 2;  
c = 3.5;  
x = fzero(@(x) x^3 + b*x + c,0);
```

### Anonymous Function Limitations for Code Generation

Anonymous functions have the code generation limitations of value classes and cell arrays.

You can use anonymous functions in a MATLAB Function block. You cannot use anonymous functions for Simulink signals, parameters, or data store memory.

### More About

- “MATLAB Classes Definition for Code Generation” on page 51-2
- “Cell Array Limitations for Code Generation” on page 50-8
- “Parameterizing Functions” (MATLAB)

## Code Generation for Nested Functions

You can generate code for MATLAB functions that contain nested functions. For example, you can generate code for the function `parent_fun`, which contains the nested function `child_fun`.

```
function parent_fun
x = 5;
child_fun

    function child_fun
        x = x + 1;
    end

end
```

### Nested Function Limitations for Code Generation

When you generate code for nested functions, you must adhere to the code generation restrictions for value classes, cell arrays, and handle classes. You must also adhere to these restrictions:

- If the parent function declares a persistent variable, it must assign the persistent variable before it calls a nested function that uses the persistent variable.
- A nested recursive function cannot refer to a variable that the parent function uses.
- If a nested function refers to a structure variable, you must define the structure by using `struct`.
- If a nested function uses a variable defined by the parent function, you cannot use `coder.ysize` with the variable in either the parent or the nested function.

### More About

- “MATLAB Classes Definition for Code Generation” on page 51-2
- “Handle Object Limitations for Code Generation” on page 51-22
- “Cell Array Limitations for Code Generation” on page 50-8
- “Code Generation for Recursive Functions” on page 54-18



# Calling Functions for Code Generation

---

- “Resolution of Function Calls for Code Generation” on page 54-2
- “Resolution of File Types on Code Generation Path” on page 54-6
- “Compilation Directive `%#codegen`” on page 54-8
- “Extrinsic Functions” on page 54-9
- “Code Generation for Recursive Functions” on page 54-18
- “Force Code Generator to Use Run-Time Recursion” on page 54-21

## Resolution of Function Calls for Code Generation

From a MATLAB function, you can call local functions, supported toolbox functions, and other MATLAB functions. MATLAB resolves function names for code generation as follows:

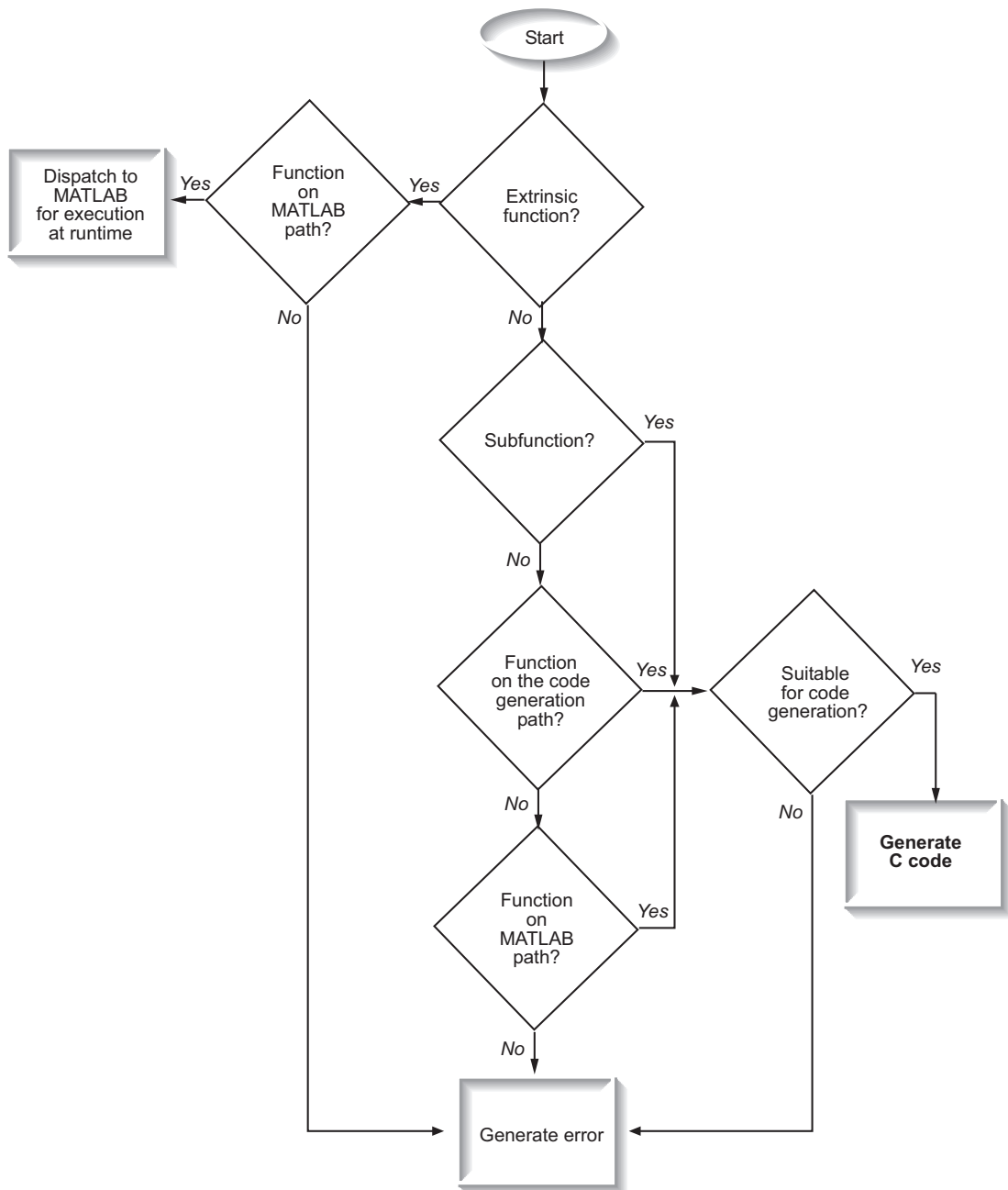

## Key Points About Resolving Function Calls

The diagram illustrates key points about how MATLAB resolves function calls for code generation:

- Searches two paths, the code generation path and the MATLAB path

See “Compile Path Search Order” on page 54-4.

- Attempts to compile functions unless the code generator determines that it should not compile them or you explicitly declare them to be extrinsic.

If a MATLAB function is not supported for code generation, you can declare it to be extrinsic by using the construct `coder.extrinsic`, as described in “Declaring MATLAB Functions as Extrinsic Functions” on page 54-10. During simulation, the code generator produces code for the call to an extrinsic function, but does not generate the internal code for the function. Therefore, simulation can run only on platforms where MATLAB software is installed. During standalone code generation, the code generator attempts to determine whether the extrinsic function affects the output of the function in which it is called — for example by returning `mxArrays` to an output variable. Provided that the output does not change, code generation proceeds, but the extrinsic function is excluded from the generated code. Otherwise, compilation errors occur.

The code generator detects calls to many common visualization functions, such as `plot`, `disp`, and `figure`. The software treats these functions like extrinsic functions but you do not have to declare them extrinsic using the `coder.extrinsic` function.

- Resolves file type based on precedence rules described in “Resolution of File Types on Code Generation Path” on page 54-6

## Compile Path Search Order

During code generation, function calls are resolved on two paths:

- 1 Code generation path

MATLAB searches this path first during code generation. The code generation path contains the toolbox functions supported for code generation.

- 2 MATLAB path

If the function is not on the code generation path, MATLAB searches this path.

MATLAB applies the same dispatcher rules when searching each path (see “Function Precedence Order” (MATLAB)).

## **When to Use the Code Generation Path**

Use the code generation path to override a MATLAB function with a customized version. A file on the code generation path shadows a file of the same name on the MATLAB path.

## **Resolution of File Types on Code Generation Path**

MATLAB uses the following precedence rules for code generation:

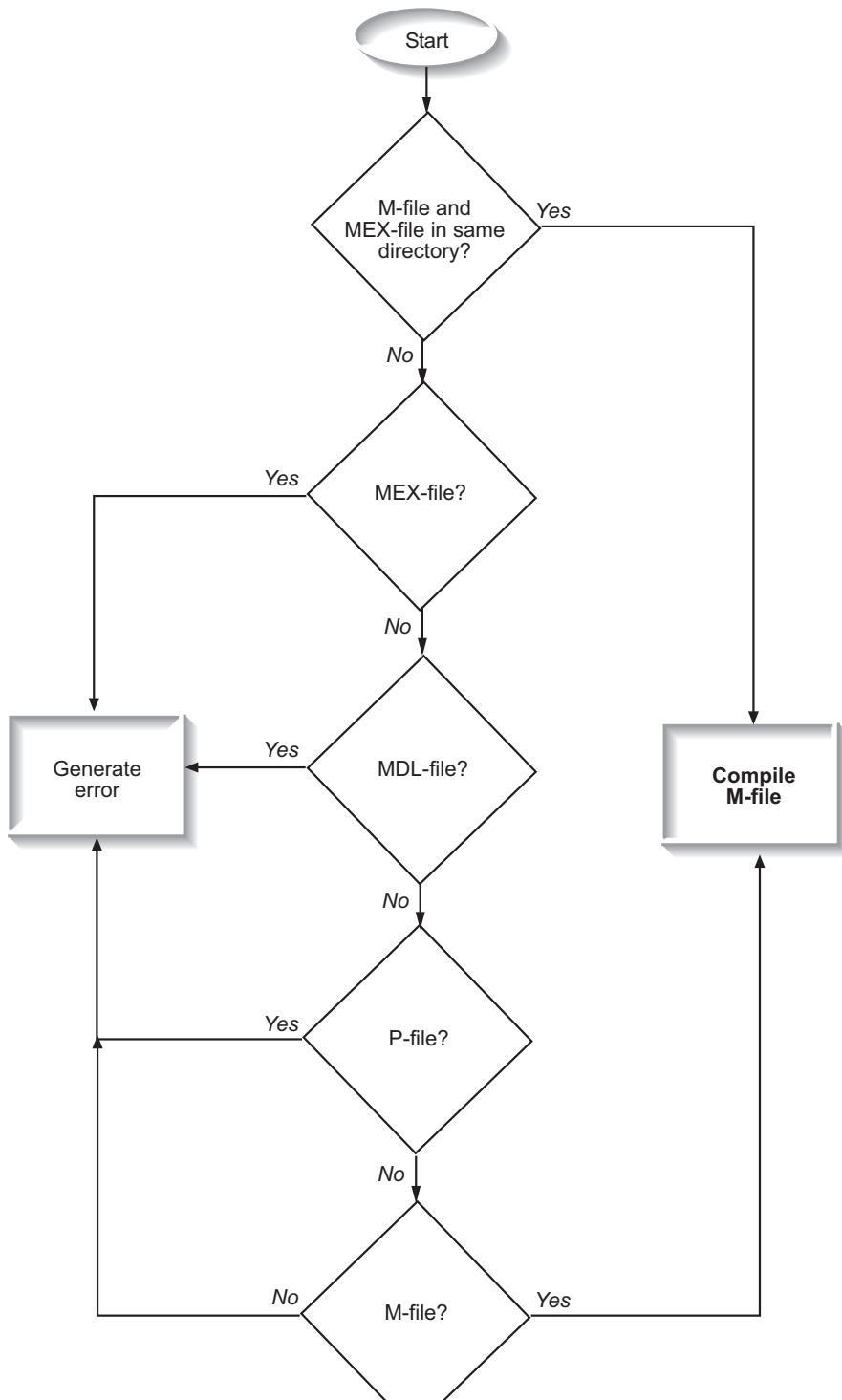

## Compilation Directive `%#codegen`

Add the  `%#codegen` directive (or pragma) to your function after the function signature to indicate that you intend to generate code for the MATLAB algorithm. Adding this directive instructs the MATLAB Code Analyzer to help you diagnose and fix violations that would result in errors during code generation.

```
function y = my_fcn(x) %#codegen  
  
.....
```

---

**Note:** The  `%#codegen` directive is not necessary for MATLAB Function blocks. Code inside a MATLAB Function block is always intended for code generation. The  `%#codegen` directive, or the absence of it, does not change the error checking behavior.

---



## Extrinsic Functions

The code generator attempts to generate code for functions, even if they are not supported for C code generation. The software detects calls to many common visualization functions, such as `plot`, `disp`, and `figure`. The software treats these functions like extrinsic functions but you do not have to declare them extrinsic using `coder.extrinsic`. During simulation, the code generator produces code for these functions, but does not generate their internal code. During standalone code generation, the code generator attempts to determine whether the visualization function affects the output of the function in which it is called. Provided that the output does not change, the code generator proceeds with code generation, but excludes the visualization function from the generated code. Otherwise, compilation errors occur.

For example, you might want to call `plot` to visualize your results in the MATLAB environment. If you generate a MEX function from a function that calls `plot` and then run the generated MEX function, the code generator dispatches calls to the `plot` function to MATLAB. If you generate a library or executable, the generated code does not contain calls to the `plot` function. The code generation report highlights calls from your MATLAB code to extrinsic functions so that it is easy to determine which functions are supported only in the MATLAB environment.

The screenshot shows the MATLAB code editor interface. On the left, there is a 'Filter' pane with 'Functions' expanded, showing 'stats' and 'stats > avg'. The main editor displays the following code:

```

1 function [mean, stdev] = stats(vals)
2 %#codegen
3
4 % Calculates a statistical mean and a standard
5 % deviation for the values in vals.
6
7 len = length(vals);
8 mean = avg(vals, len);
9 stdev = sqrt(sum((vals-avg(vals,len)).^2)/len);
10 plot(vals, '-+');
11

```

A tooltip points to the `plot` function call on line 10, stating: "Only supported within the MATLAB environment."

For unsupported functions other than common visualization functions, you must declare the functions to be extrinsic (see “Resolution of Function Calls for Code Generation” on page 54-2). Extrinsic functions are not compiled, but instead executed in MATLAB during simulation (see “Resolution of Extrinsic Functions During Simulation” on page 54-14).

There are two ways to declare a function to be extrinsic:

- Use the `coder.extrinsic` construct in main functions or local functions (see “Declaring MATLAB Functions as Extrinsic Functions” on page 54-10).
- Call the function indirectly using `feval` (see “Calling MATLAB Functions Using `feval`” on page 54-14).

## Declaring MATLAB Functions as Extrinsic Functions

To declare a MATLAB function to be extrinsic, add the `coder.extrinsic` construct at the top of the main function or a local function:

```
coder.extrinsic('function_name_1', ... , 'function_name_n');
```

### Declaring Extrinsic Functions

The following code declares the MATLAB `patch` function extrinsic in the local function `create_plot`. You do not have to declare `axis` as extrinsic because `axis` is one of the common visualization functions that the code generator automatically treats as extrinsic.

```
function c = pythagoras(a,b,color) %#codegen
% Calculates the hypotenuse of a right triangle
% and displays the triangle.
```

```
c = sqrt(a^2 + b^2);
create_plot(a, b, color);
```

```
function create_plot(a, b, color)
%Declare patch as extrinsic
```

```
coder.extrinsic('patch');
```

```
x = [0;a;a];
y = [0;0;b];
patch(x, y, color);
axis('equal');
```

The code generator does not produce code for `patch` and `axis`, but instead dispatches them to MATLAB for execution.

To test the function, follow these steps:

- 1 Convert `pythagoras` to a MEX function by executing this command at the MATLAB prompt:

```
codegen -report pythagoras -args {1, 1, [.3 .3 .3]}
```

- Click the link to the code generation report and then, in the report, view the MATLAB code for `create_plot`.

The report highlights the `patch` and `axis` functions to indicate that they are supported only within the MATLAB environment.

The screenshot shows the MATLAB code generation report for the function `pythagoras > create_plot`. The code is as follows:

```

7
8
9 function create_plot(a, b, color)
10 %Declare patch and axis as extrinsic
11
12 coder.extrinsic('patch'); %,'axis');
13
14 x = [0;a;a];
15 y = [0;0;b];
16 patch(x, y, color);
17 axis('equal');

```

The `patch` and `axis` functions are highlighted in red in the original image. A tooltip points to the `axis` function with the text "Only supported within the MATLAB environment."

- Run the MEX function by executing this command:

```
pythagoras_mex(3, 4, [1.0 0.0 0.0]);
```

MATLAB displays a plot of the right triangle as a red patch object:

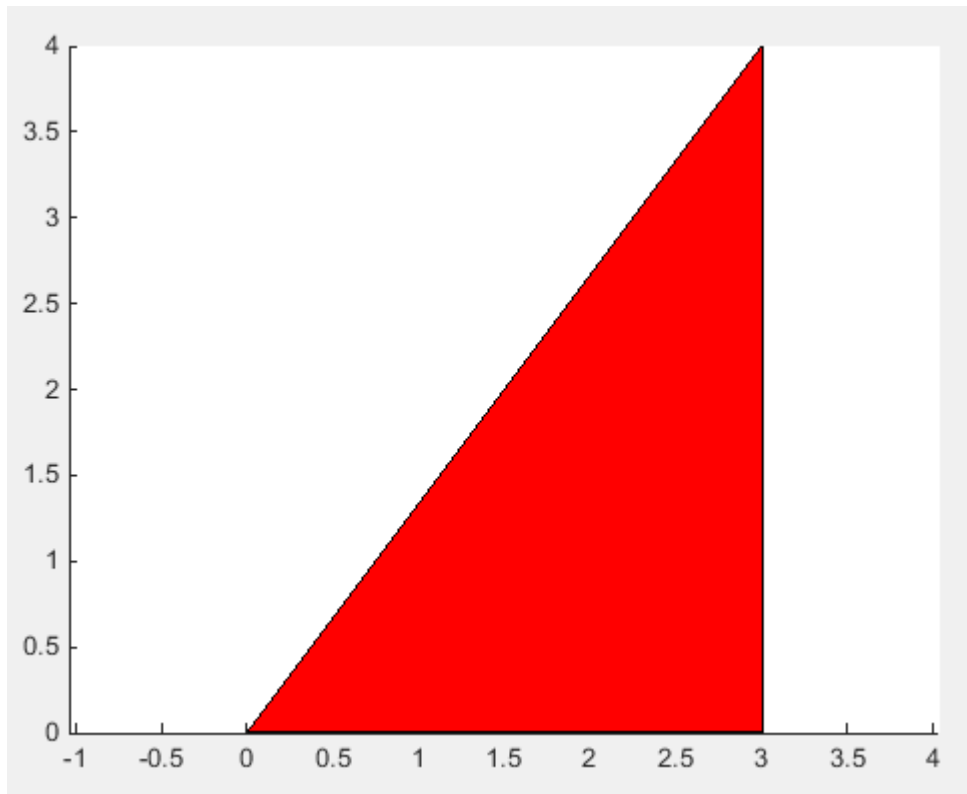

### When to Use the `coder.extrinsic` Construct

Use the `coder.extrinsic` construct to:

- Call MATLAB functions that do not produce output during simulation, without generating unnecessary code (see “Resolution of Extrinsic Functions During Simulation” on page 54-14).
- Make your code self-documenting and easier to debug. You can scan the source code for `coder.extrinsic` statements to isolate calls to MATLAB functions, which can potentially create and propagate `mxArrays` (see “Working with `mxArrays`” on page 54-15).

- Save typing. With one `coder.extrinsic` statement, each subsequent function call is extrinsic, as long as the call and the statement are in the same scope (see “Scope of Extrinsic Function Declarations” on page 54-13).
- Declare the MATLAB function(s) extrinsic throughout the calling function scope (see “Scope of Extrinsic Function Declarations” on page 54-13). To narrow the scope, use `feval` (see “Calling MATLAB Functions Using `feval`” on page 54-14).

### Rules for Extrinsic Function Declarations

Observe the following rules when declaring functions extrinsic for code generation:

- Declare the function extrinsic before you call it.
- Do not use the extrinsic declaration in conditional statements.

### Scope of Extrinsic Function Declarations

The `coder.extrinsic` construct has function scope. For example, consider the following code:

```
function y = foo %#codegen
coder.extrinsic('rat','min');
[N D] = rat(pi);
y = 0;
y = min(N, D);
```

In this example, `rat` and `min` are treated as extrinsic every time they are called in the main function `foo`. There are two ways to narrow the scope of an extrinsic declaration inside the main function:

- Declare the MATLAB function extrinsic in a local function, as in this example:

```
function y = foo %#codegen
coder.extrinsic('rat');
[N D] = rat(pi);
y = 0;
y = mymin(N, D);

function y = mymin(a,b)
coder.extrinsic('min');
y = min(a,b);
```

Here, the function `rat` is extrinsic every time it is called inside the main function `foo`, but the function `min` is extrinsic only when called inside the local function `mymin`.

- Call the MATLAB function using `feval`, as described in “Calling MATLAB Functions Using `feval`” on page 54-14.

## Calling MATLAB Functions Using `feval`

The function `feval` is automatically interpreted as an extrinsic function during code generation. Therefore, you can use `feval` to conveniently call functions that you want to execute in the MATLAB environment, rather than compiled to generated code.

Consider the following example:

```
function y = foo
coder.extrinsic('rat');
[N D] = rat(pi);
y = 0;
y = feval('min', N, D);
```

Because `feval` is extrinsic, the statement `feval('min', N, D)` is evaluated by MATLAB — not compiled — which has the same result as declaring the function `min` extrinsic for just this one call. By contrast, the function `rat` is extrinsic throughout the function `foo`.

## Resolution of Extrinsic Functions During Simulation

The code generator resolves calls to extrinsic functions — functions that do not support code generation — as follows:

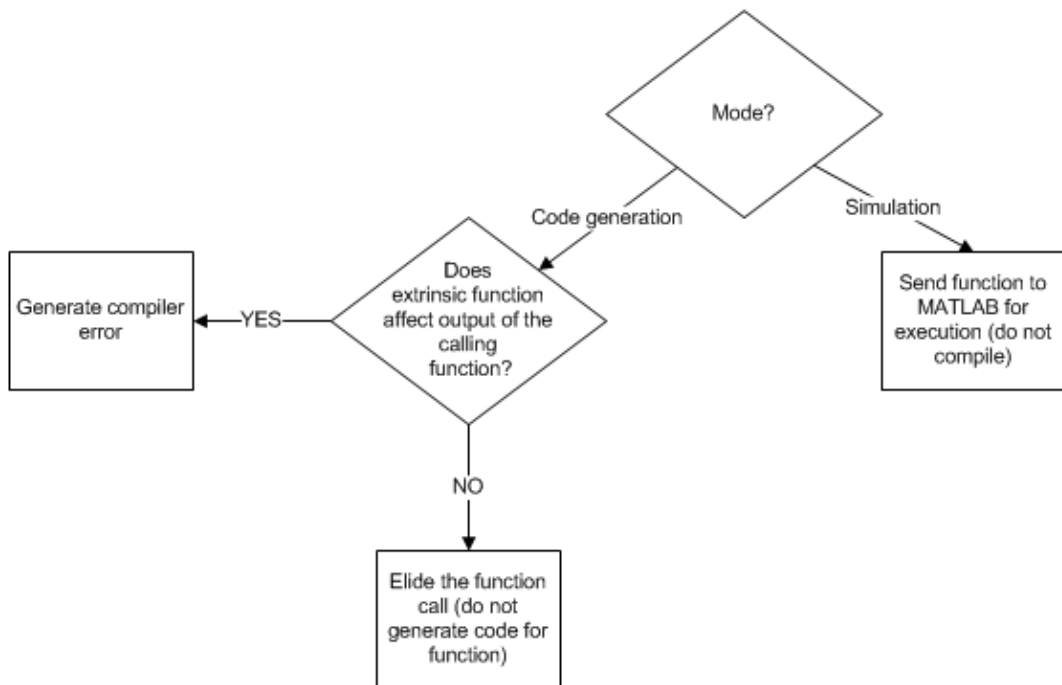

During simulation, the code generator produces code for the call to an extrinsic function, but does not generate the internal code for the function. Therefore, you can run the simulation only on platforms where you install MATLAB software.

During code generation, the code generator attempts to determine whether the extrinsic function affects the output of the function in which it is called — for example by returning `mxArrays` to an output variable (see “Working with `mxArrays`” on page 54-15). Provided that the output does not change, code generation proceeds, but the extrinsic function is excluded from the generated code. Otherwise, the code generator issues a compiler error.

## Working with `mxArrays`

The output of an extrinsic function is an `mxArray` — also called a MATLAB array. The only valid operations for `mxArrays` are:

- Storing `mxArrays` in variables

- Passing `mxArrays` to functions and returning them from functions
- Converting `mxArrays` to known types at run time

To use `mxArrays` returned by extrinsic functions in other operations, you must first convert them to known types, as described in “Converting `mxArrays` to Known Types” on page 54-16.

### Converting `mxArrays` to Known Types

To convert an `mxArray` to a known type, assign the `mxArray` to a variable whose type is defined. At run time, the `mxArray` is converted to the type of the variable assigned to it. However, if the data in the `mxArray` is not consistent with the type of the variable, you get a run-time error.

For example, consider this code:

```
function y = foo %#codegen
coder.extrinsic('rat');
[N D] = rat(pi);
y = min(N, D);
```

Here, the top-level function `foo` calls the extrinsic MATLAB function `rat`, which returns two `mxArrays` representing the numerator `N` and denominator `D` of the rational fraction approximation of `pi`. Although you can pass these `mxArrays` to another MATLAB function — in this case, `min` — you cannot assign the `mxArray` returned by `min` to the output `y`.

If you run this function `foo` in a MATLAB Function block in a Simulink model, the code generates the following error during simulation:

```
Function output 'y' cannot be of MATLAB type.
```

To fix this problem, define `y` to be the type and size of the value that you expect `min` to return — in this case, a scalar double — as follows:

```
function y = foo %#codegen
coder.extrinsic('rat');
[N D] = rat(pi);
y = 0; % Define y as a scalar of type double
y = min(N,D);
```



## Restrictions on Extrinsic Functions for Code Generation

The full MATLAB run-time environment is not supported during code generation. Therefore, the following restrictions apply when calling MATLAB functions extrinsically:

- MATLAB functions that inspect the caller, or read or write to the caller workspace do not work during code generation. Such functions include:
  - `dbstack`
  - `evalin`
  - `assignin`
  - `save`
- The MATLAB debugger cannot inspect variables defined in extrinsic functions.
- Functions in generated code can produce unpredictable results if your extrinsic function performs the following actions at run time:
  - Change folders
  - Change the MATLAB path
  - Delete or add MATLAB files
  - Change warning states
  - Change MATLAB preferences
  - Change Simulink parameters

## Limit on Function Arguments

You can call functions with up to 64 inputs and 64 outputs.

## Code Generation for Recursive Functions

To generate code for recursive MATLAB functions, the code generator uses compile-time recursion or run-time recursion. You can influence whether the code generator uses compile-time or run-time recursion by modifying your MATLAB code. See “Force Code Generator to Use Run-Time Recursion” on page 54-21.

You can disallow recursion or disable run-time recursion by modifying configuration parameters.

When you use recursive functions in MATLAB code that is intended for code generation, you must adhere to certain restrictions. See “Recursive Function Limitations for Code Generation” on page 54-20.

### Compile-Time Recursion

With compile-time recursion, the code generator creates multiple versions of a recursive function in the generated code. The inputs to each version have values or sizes that are customized for that version. These versions are known as *function specializations*. You can tell that the code generator used compile-time recursion by looking at the MATLAB Function report or the generated C code. Here is an example of compile-time recursion in the report.

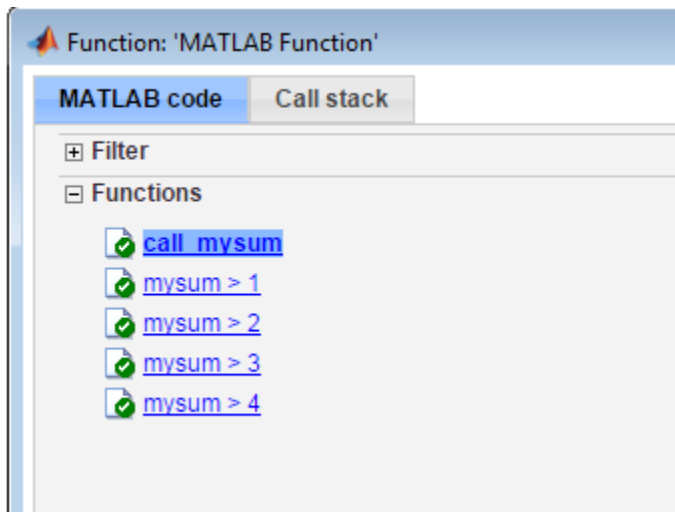

## Run-Time Recursion

With run-time recursion, the code generator produces a recursive function in the generated code. You can tell that the code generator used run-time recursion by looking at the MATLAB Function report or the generated C code. Here is an example of run-time recursion in the report.

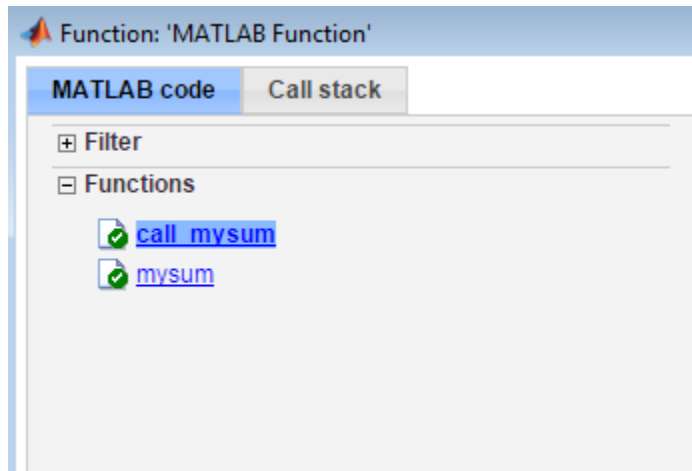

## Disallow Recursion

In the model configuration parameters, on the **All Parameters** tab, in the **Simulation Target** category, set the **Compile-time recursion limit for MATLAB functions** configuration parameter to 0.

## Disable Run-Time Recursion

Some coding standards, such as MISRA<sup>®</sup>, do not allow recursion. To increase the likelihood of generating code that is compliant with MISRA C<sup>®</sup>, disable run-time recursion.

In the model configuration parameters, on the **All Parameters** tab, in the **Simulation Target** category, clear the **Enable run-time recursion for MATLAB functions** check box.

If your code requires run-time recursion and run-time recursion is disabled, you must rewrite your code so that it uses compile-time recursion or does not use recursion.

## Recursive Function Limitations for Code Generation

When you use recursion in MATLAB code that is intended for code generation, follow these restrictions:

- The top-level function in a MATLAB Function block cannot be a recursive function, but it can call a recursive function.
- Assign all outputs of a run-time recursive function before the first recursive call in the function.
- Assign all elements of cell array outputs of a run-time recursive function.
- Inputs and outputs of run-time recursive functions cannot be classes.
- The **Maximum stack size** parameter is ignored for run-time recursion.

## More About

- “Force Code Generator to Use Run-Time Recursion” on page 54-21
- “Output Variable Must Be Assigned Before Run-Time Recursive Call” on page 56-7
- “Compile-Time Recursion Limit Reached” on page 56-2
- “Compile-time recursion limit for MATLAB functions”
- “MATLAB Function Reports” on page 40-48

## Force Code Generator to Use Run-Time Recursion

When your MATLAB code includes recursive function calls, the code generator uses compile-time or run-time recursion. With compile-time recursion, the code generator creates multiple versions of the recursive function in the generated code. These versions are known as function specializations. With run-time recursion, the code generator produces a recursive function. If compile-time recursion results in too many function specializations or if you prefer run-time recursion, you can try to force the code generator to use run-time recursion. Try one of these approaches:

- “Treat the Input to the Recursive Function as a Nonconstant” on page 54-21
- “Make the Input to the Recursive Function Variable-Size” on page 54-22
- “Assign Output Variable Before the Recursive Call” on page 54-23

### Treat the Input to the Recursive Function as a Nonconstant

Consider this function:

```
function y = call_recfcn(n)
A = ones(1,n);
x = 5;
y = recfcn(A,x);
end

function y = recfcn(A,x)
if size(A,2) == 1 || x == 1
    y = A(1);
else
    y = A(1)+recfcn(A(2:end),x-1);
end
end
```

`call_recfcn` calls `recfcn` with the value 5 for the second argument. `recfcn` calls itself recursively until `x` is 1. For each `recfcn` call, the input argument `x` has a different value. The code generator produces five specializations of `recfcn`, one for each call. You can see the specializations in the MATLAB Function report.

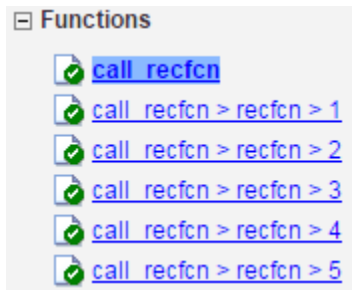

To force run-time recursion, in `call_recfcn`, in the call to `recfcn`, instruct the code generator to treat the value of the input argument `x` as a nonconstant value by using `coder.ignoreConst`.

```
function y = call_recfcn(n)
A = ones(1,n);
x = coder.ignoreConst(5);
y = recfcn(A,x);
end

function y = recfcn(A,x)
if size(A,2) == 1 || x == 1
    y = A(1);
else
    y = A(1)+recfcn(A(2:end),x-1);
end
end
```

In the MATLAB Function report, you see only one specialization.

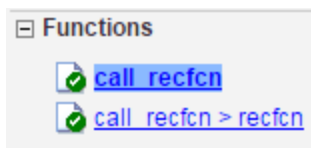

## Make the Input to the Recursive Function Variable-Size

Consider this code:

```
function z = call_mysum(A)
%#codegen
```

```

z = mysum(A);
end

function y = mysum(A)
coder.inline('never');
if size(A,2) == 1
    y = A(1);
else
    y = A(1)+ mysum(A(2:end));
end
end

```

If the input to `mysum` is fixed-size, the code generator uses compile-time recursion. To force the code generator to use run-time conversion, make the input to `mysum` variable-size by using `coder.varsize`.

```

function z = call_mysum(A)
%#codegen
B = A;
coder.varsize('B');
z = mysum(B);
end

function y = mysum(A)
coder.inline('never');
if size(A,2) == 1
    y = A(1);
else
    y = A(1)+ mysum(A(2:end));
end
end

```

## Assign Output Variable Before the Recursive Call

The code generator uses compile-time recursion for this code:

```

function y = callrecursive(n)
x = 10;
y = myrecursive(x,n);
end

function y = myrecursive(x,n)
coder.inline('never')
if x > 1

```

```
        y = n + myrecursive(x-1,n-1);  
  
else  
    y = n;  
end  
end
```

To force the code generator to use run-time recursion, modify `myrecursive` so that the output `y` is assigned before the recursive call. Place the assignment `y = n` in the `if` block and the recursive call in the `else` block.

```
function y = callrecursive(n)  
x = 10;  
y = myrecursive(x,n);  
end  
  
function y = myrecursive(x,n)  
coder.inline('never')  
if x == 1  
    y = n;  
else  
    y = n + myrecursive(x-1,n-1);  
end  
end
```

## More About

- “Code Generation for Recursive Functions” on page 54-18
- “Output Variable Must Be Assigned Before Run-Time Recursive Call” on page 56-7
- “Compile-Time Recursion Limit Reached” on page 56-2



# Generate Efficient and Reusable Code

---

- “Modularize MATLAB Code” on page 55-2
- “Eliminate Redundant Copies of Function Inputs” on page 55-3
- “Inline Code” on page 55-6
- “Control Inlining” on page 55-8
- “Fold Function Calls into Constants” on page 55-11
- “Control Stack Space Usage” on page 55-13
- “Stack Allocation and Performance” on page 55-14
- “Dynamic Memory Allocation and Performance” on page 55-15
- “Minimize Dynamic Memory Allocation” on page 55-16
- “Provide Maximum Size for Variable-Size Arrays” on page 55-17
- “Disable Dynamic Memory Allocation During Code Generation” on page 55-23
- “Set Dynamic Memory Allocation Threshold” on page 55-24
- “Excluding Unused Paths from Generated Code” on page 55-26
- “Prevent Code Generation for Unused Execution Paths” on page 55-27
- “Generate Code with Parallel for-Loops (parfor)” on page 55-29
- “Minimize Redundant Operations in Loops” on page 55-31
- “Unroll for-Loops” on page 55-33
- “Disable Support for Integer Overflow or Non-Finites” on page 55-35
- “Integrate External/Custom Code” on page 55-37
- “Generate Reusable Code” on page 55-43
- “LAPACK Calls for Linear Algebra in a MATLAB Function Block” on page 55-44

## Modularize MATLAB Code

For large MATLAB code, streamline code generation by modularizing the code:

- 1** Break up your MATLAB code into smaller, self-contained sections.
- 2** Save each section in a MATLAB function.
- 3** Generate C/C++ code for each function.
- 4** Call the generated C/C++ functions in sequence from a wrapper MATLAB function using `coder.ceval`.
- 5** Generate C/C++ code for the wrapper function.

Besides streamlining code generation for the original MATLAB code, this approach also supplies you with C/C++ code for the individual sections. You can reuse the code for the individual sections later by integrating them with other generated C/C++ code using `coder.ceval`.

## Eliminate Redundant Copies of Function Inputs

You can reduce the number of copies in your generated code by writing functions that use the same variable as both an input and an output. For example:

```
function A = foo( A, B ) %#codegen
A = A * B;
end
```

This coding practice uses a reference parameter optimization. When a variable acts as both input and output, the generated code passes the variable by reference instead of redundantly copying the input to a temporary variable. In the preceding example, input `A` is passed by reference in the generated code because it also acts as an output for function `foo`:

```
...
/* Function Definitions */
void foo(double *A, double B)
{
    *A *= B;
}
...
```

The reference parameter optimization reduces memory usage and execution time, especially when the variable passed by reference is a large data structure. To achieve these benefits at the call site, call the function with the same variable as both input and output.

By contrast, suppose that you rewrite function `foo` without the optimization:

```
function y = foo2( A, B ) %#codegen
y = A * B;
end
```

The generated code passes the inputs by value and returns the value of the output:

```
...
/* Function Definitions */
double foo2(double A, double B)
{
    return A * B;
}
...
```

In some cases, the output of the function cannot be a modified version of its inputs. If you do not use the inputs later in the function, you can modify your code to operate on the inputs instead of on a copy of the inputs. One method is to create additional return values for the function. For example, consider the code:

```
function y1=foo(u1) %#codegen
    x1=u1+1;
    y1=bar(x1);
end

function y2=bar(u2)
    % Since foo does not use x1 later in the function,
    % it would be optimal to do this operation in place
    x2=u2.*2;
    % The change in dimensions in the following code
    % means that it cannot be done in place
    y2=[x2,x2];
end
```

You can modify this code to eliminate redundant copies.

```
function y1=foo(u1) %#codegen
    u1=u1+1;
    [y1, u1]=bar(u1);
end

function [y2, u2]=bar(u2)
    u2=u2.*2;
    % The change in dimensions in the following code
    % still means that it cannot be done in place
    y2=[u2,u2];
end
```

The reference parameter optimization does not apply to constant inputs. If the same variable is an input and an output, and the input is constant, the code generator treats the output as a separate variable. For example, consider the function `foo`:

```
function A = foo( A, B ) %#codegen
A = A * B;
end
```

Generate code in which `A` has a constant value 2.

```
codegen -config:lib foo -args {coder.Constant(2) 3} -report
```

The generated code defines the constant A and returns the value of the output.

```
...  
#define A                                (2.0)  
...  
double foo(double B)  
{  
    return A * B;  
}  
...
```

## Inline Code

Inlining is a technique that replaces a function call with the contents (body) of that function. Inlining eliminates the overhead of a function call, but can produce larger C/C++ code. Inlining can create opportunities for further optimization of the generated C/C++ code. The code generator uses internal heuristics to determine whether to inline functions in the generated code. You can use the `coder.inline` directive to fine-tune these heuristics for individual functions. For more information, see `coder.inline`.

### In this section...

“Prevent Function Inlining” on page 55-6

“Use Inlining in Control Flow Statements” on page 55-6

### Prevent Function Inlining

In this example, function `foo` is not inlined in the generated code:

```
function y = foo(x)
    coder.inline('never');
    y = x;
end
```

### Use Inlining in Control Flow Statements

You can use `coder.inline` in control flow code. If the software detects contradictory `coder.inline` directives, the generated code uses the default inlining heuristic and issues a warning.

Suppose you want to generate code for a division function that will be embedded in a system with limited memory. To optimize memory use in the generated code, the following function, `inline_division`, manually controls inlining based on whether it performs scalar division or vector division:

```
function y = inline_division(dividend, divisor)

% For scalar division, inlining produces smaller code
% than the function call itself.
if isscalar(dividend) && isscalar(divisor)
    coder.inline('always');
else
```

```
% Vector division produces a for-loop.  
% Prohibit inlining to reduce code size.  
    coder.inline('never');  
end  
  
if any(divisor == 0)  
    error('Can not divide by 0');  
end  
  
y = dividend / divisor;
```

## Related Examples

- “Control Inlining” (MATLAB Coder)

## Control Inlining

Restrict inlining when:

- The size of generated code exceeds desired limits due to excessive inlining of functions. Suppose that you include the statement, `coder.inline('always')`, inside a certain function. You then call that function at many different sites in your code. The generated code can be large due to the function being inlined every time it is called.

The call sites must be different. For instance, inlining does not lead to large code if the function to be inlined is called several times inside a loop.

- You have limited RAM or stack space.

In this section...
“Control Size of Functions Inlined” on page 55-8
“Control Size of Functions After Inlining” on page 55-9
“Control Stack Size Limit on Inlined Functions” on page 55-9

### Control Size of Functions Inlined

You can use the MATLAB Coder app or the command-line interface to control the maximum size of functions that can be inlined. The function size is measured in terms of an abstract number of instructions, not actual MATLAB instructions or instructions in the target processor. Experiment with this parameter to obtain the inlining behavior that you want.

- Using the app, in the project settings dialog box, on the **All Settings** tab, set the value of the field, **Inline threshold**, to the maximum size that you want.
- At the command line, create a `codegen` configuration object. Set the value of the property, `InlineThreshold`, to the maximum size that you want.

```
cfg = coder.config('lib');  
cfg.InlineThreshold = 100;
```

Generate code using this configuration object.



## Control Size of Functions After Inlining

You can use the MATLAB Coder app or the command-line interface to control the maximum size of functions after inlining. The function size is measured in terms of an abstract number of instructions, not actual MATLAB instructions or instructions in the target processor. Experiment with this parameter to obtain the inlining behavior that you want.

- Using the app, in the project settings dialog box, on the **All Settings** tab, set the value of the field, **Inline threshold max**, to the maximum size that you want.
- At the command line, create a `codegen` configuration object. Set the value of the property, `InlineThresholdMax`, to the maximum size that you want.

```
cfg = coder.config('lib');  
cfg.InlineThresholdMax = 100;
```

Generate code using this configuration object.

## Control Stack Size Limit on Inlined Functions

Specifying a limit on the stack space constrains the amount of inlining allowed. For out-of-line functions, stack space for variables local to the function is released when the function returns. However, for inlined functions, stack space remains occupied by the local variables even after the function is executed. The value of the property, `InlineStackLimit`, is measured in bytes. Based on information from the target hardware settings, the software estimates the number of stack variables that a certain value of `InlineStackLimit` can accommodate. This estimate excludes possible C compiler optimizations such as putting variables in registers.

You can use the MATLAB Coder app or the command-line interface to control the stack size limit on inlined functions.

- Using the app, in the project settings dialog box, on the **All Settings** tab, set the value of the field, **Inline stack limit**, to the maximum size that you want.
- At the command line, create a `codegen` configuration object. Set the value of the property, `InlineStackLimit`, to the maximum size that you want.

```
cfg = coder.config('lib');  
cfg.InlineStackLimit = 2000;
```

Generate code using this configuration object.

## **Related Examples**

- “Inline Code” (MATLAB Coder)

## Fold Function Calls into Constants

This example shows how to specify constants in generated code using `coder.const`. The code generator folds an expression or a function call in a `coder.const` statement into a constant in generated code. Because the generated code does not have to evaluate the expression or call the function every time, this optimization reduces the execution time of the generated code.

Write a function `AddShift` that takes an input `Shift` and adds it to the elements of a vector. The vector consists of the square of the first 10 natural numbers. `AddShift` generates this vector.

```
function y = AddShift(Shift) %#codegen
y = (1:10).^2+Shift;
```

Generate code for `AddShift` using the `codegen` command. Open the Code Generation Report.

```
codegen -config:lib -launchreport AddShift -args 0
```

The code generator produces code for creating the vector. It adds `Shift` to each element of the vector during vector creation. The definition of `AddShift` in generated code looks as follows:

```
void AddShift(double Shift, double y[10])
{
    int k;
    for (k = 0; k < 10; k++) {
        y[k] = (double)((1 + k) * (1 + k)) + Shift;
    }
}
```

Replace the statement

```
y = (1:10).^2+Shift;
```

with

```
y = coder.const((1:10).^2)+Shift;
```

Generate code for `AddShift` using the `codegen` command. Open the Code Generation Report.

```
codegen -config:lib -launchreport AddShift -args 0
```

The code generator creates the vector containing the squares of the first 10 natural numbers. In the generated code, it adds `Shift` to each element of this vector. The definition of `AddShift` in generated code looks as follows:

```
void AddShift(double Shift, double y[10])
{
    int i0;
    static const signed char iv0[10] = { 1, 4, 9, 16, 25, 36,
                                         49, 64, 81, 100 };

    for (i0 = 0; i0 < 10; i0++) {
        y[i0] = (double)iv0[i0] + Shift;
    }
}
```

### **See Also**

`coder.const`

## Control Stack Space Usage

This example shows how to set the maximum stack space that the generated code uses. Set the maximum stack usage when:

- You have limited stack space, for instance, in embedded targets.
- Your C compiler reports a run-time stack overflow.

The value of the property, `StackUsageMax`, is measured in bytes. Based on information from the target hardware settings, the software estimates the number of stack variables that a certain value of `StackUsageMax` can accommodate. This estimate excludes possible C compiler optimizations such as putting variables in registers.

### Control Stack Space Usage Using the MATLAB Coder App

- 1 To open the **Generate** dialog box, on the **Generate Code** page, click the **Generate** arrow .
- 2 Set **Build type** to `Source Code`, `Static Library`, `Dynamic Library`, or `Executable` (depending on your requirements).
- 3 Click **More Settings**.
- 4 On the **Memory** tab, set **Stack usage max** to the value that you want.

### Control Stack Space Usage at the Command Line

- 1 Create a configuration object for code generation.

Use `coder.config` with arguments `'lib'`, `'dll'`, or `'exe'` (depending on your requirements). For example:

```
cfg = coder.config('lib');
```

- 2 Set the property, `StackUsageMax`, to the value that you want.

```
cfg.StackUsageMax=400000;
```

### More About

- “Stack Allocation and Performance” (MATLAB Coder)

## Stack Allocation and Performance

By default, local variables are allocated on the stack. Large variables that do not fit on the stack are statically allocated in memory.

Stack allocation typically uses memory more efficiently than static allocation. However, stack space is sometimes limited, typically in embedded processors. MATLAB Coder allows you to manually set a limit on the stack space usage to make your generated code suitable for your target hardware. You can choose this limit based on the target hardware configurations. For more information, see “Control Stack Space Usage” (MATLAB Coder).

For limited stack space, you can choose to allocate large variables on the heap instead of using static allocation. Heap allocation is slower but more memory-efficient than static allocation. To allocate large variables on the heap, do one of the following:

### Allocate Heap Space from Command Line

- 1 Create a configuration object. Set the property, `MultiInstanceCode`, to `true`.

```
cfg = coder.config('exe');  
cfg.MultiInstanceCode = true;
```

- 2 Generate code using this configuration object.

### Allocate Heap Space Using the MATLAB Coder App

- 1 Using the MATLAB Coder app, in the project settings dialog box, on the **Memory** tab, select the **Generate re-entrant code** check box.
  - Generate code.

## Dynamic Memory Allocation and Performance

To achieve faster execution of generated code, minimize dynamic (or run-time) memory allocation of arrays.

MATLAB Coder does not provide a size for unbounded arrays in generated code. Instead, such arrays are referenced indirectly through pointers. For such arrays, memory cannot be allocated during compilation of generated code. Based on storage requirements for the arrays, memory is allocated and freed at run time as required. This run-time allocation and freeing of memory leads to slower execution of the generated code.

### When Dynamic Memory Allocation Occurs

Dynamic memory allocation occurs when the code generator cannot find upper bounds for variable-size arrays. The software cannot find upper bounds when you specify the size of an array using a variable that is not a compile-time constant. An example of such a variable is an input variable (or a variable computed from an input variable).

Instances in the MATLAB code that can lead to dynamic memory allocation are:

- Array initialization: You specify array size using a variable whose value is known only at run time.
- After initialization of an array:
  - You declare the array as variable-size using `coder.varsize` without explicit upper bounds. After this declaration, you expand the array by concatenation inside a loop. The number of loop runs is known only at run time.
  - You use a `reshape` function on the array. At least one of the size arguments to the `reshape` function is known only at run time.

If you know the maximum size of the array, you can avoid dynamic memory allocation. You can then provide an upper bound for the array and prevent dynamic memory allocation in generated code. For more information, see “Minimize Dynamic Memory Allocation” on page 55-16.

## Minimize Dynamic Memory Allocation

When possible, minimize dynamic memory allocation because it leads to slower execution of generated code. Dynamic memory allocation occurs when the code generator cannot find upper bounds for variable-size arrays.

If you know the maximum size of a variable-size array, you can avoid dynamic memory allocation. Follow these steps:

- 1 “Provide Maximum Size for Variable-Size Arrays” on page 55-17.
- 2 Depending on your requirements, do one of the following:
  - “Disable Dynamic Memory Allocation During Code Generation” on page 55-23.
  - “Set Dynamic Memory Allocation Threshold” (MATLAB Coder)

---

**Caution:** If a variable-size array in the MATLAB code does not have a maximum size, disabling dynamic memory allocation leads to a code generation error. Before disabling dynamic memory allocation, you must provide a maximum size for variable-size arrays in your MATLAB code.

---

### More About

- “Dynamic Memory Allocation and Performance” (MATLAB Coder)



## Provide Maximum Size for Variable-Size Arrays

To constrain array size for variable-size arrays, do one of the following:

- **Constrain Array Size Using `assert` Statements**

If the variable specifying array size is not a compile-time constant, use an `assert` statement with relational operators to constrain the variable. Doing so helps the code generator to determine a maximum size for the array.

The following examples constrain array size using `assert` statements:

- **When Array Size Is Specified by Input Variables**

Define a function `array_init` which initializes an array `y` with input variable `N`:

```
function y = array_init (N)
    assert(N <= 25); % Generates exception if N > 25
    y = zeros(1,N);
```

The `assert` statement constrains input `N` to a maximum size of 25. In the absence of the `assert` statement, `y` is assigned a pointer to an array in the generated code, thus allowing dynamic memory allocation.

- **When Array Size Is Obtained from Computation Using Input Variables**

Define a function, `array_init_from_prod`, which takes two input variables, `M` and `N`, and uses their product to specify the maximum size of an array, `y`.

```
function y = array_init_from_prod (M,N)
    size=M*N;
    assert(size <= 25); % Generates exception if size > 25
    y=zeros(1,size);
```

The `assert` statement constrains the product of `M` and `N` to a maximum of 25.

Alternatively, if you restrict `M` and `N` individually, it leads to dynamic memory allocation:

```
function y = array_init_from_prod (M,N)
    assert(M <= 5);
    assert(N <= 5);
    size=M*N;
    y=zeros(1,size);
```

This code causes dynamic memory allocation because  $M$  and  $N$  can both have unbounded negative values. Therefore, their product can be unbounded and positive even though, individually, their positive values are bounded.

---

**Tip:** Place the `assert` statement on a variable immediately before it is used to specify array size.

---

---

**Tip:** You can use `assert` statements to restrict array sizes in most cases. When expanding an array inside a loop, this strategy does not work if the number of loop runs is known only at run time.

---

- **Restrict Concatenations in a Loop Using `coder.ysize` with Upper Bounds**

You can expand arrays beyond their initial size by concatenation. When you concatenate additional elements inside a loop, there are two syntax rules for expanding arrays.

- 1 Array size during initialization is not a compile-time constant**

If the size of an array during initialization is not a compile-time constant, you can expand it by concatenating additional elements:

```
function out=ExpandArray(in) % Expand an array by five elements
    out = zeros(1,in);
    for i=1:5
        out = [out 0];
    end
```

- 2 Array size during initialization is a compile-time constant**

Before concatenating elements, you have to declare the array as variable-size using `coder.ysize`:

```
function out=ExpandArray() % Expand an array by five elements
    out = zeros(1,5);
    coder.ysize('out');
    for i=1:5
        out = [out 0];
    end
```

Either case leads to dynamic memory allocation. To prevent dynamic memory allocation in such cases, use `coder. varsize` with explicit upper bounds. This example shows how to use `coder. varsize` with explicit upper bounds:

### Restrict Concatenations Using `coder. varsize` with Upper Bounds

- 1 Define a function, `RunningAverage`, that calculates the running average of an `N`-element subset of an array:

```
function avg=RunningAverage(N)

% Array whose elements are to be averaged
NumArray=[1 6 8 2 5 3];

% Initialize average:
% These will also be the first two elements of the function output
avg=[0 0];

% Place a bound on the argument
coder. varsize('avg',[1 8]);

% Loop to calculate running average
for i=1:N
    s=0;
    s=s+sum(NumArray(1:i));
    avg=[avg s/i];
% Increase the size of avg as required by concatenation
end
```

The output, `avg`, is an array that you can expand as required to accommodate the running averages. As a new running average is calculated, it is added to the array `avg` through concatenation, thereby expanding the array.

Because the maximum number of running averages is equal to the number of elements in `NumArray`, you can supply an explicit upper bound for `avg` in the `coder. varsize` statement. In this example, the upper bound is 8 (the two initial elements plus the six elements of `NumArray`).

- 2 Generate code for `RunningAverage` with input argument of type `double`:

```
codegen -config:lib -report RunningAverage -args 2
```

In the generated code, `avg` is assigned an array of size 8 (static memory allocation). The function definition for `RunningAverage` appears as follows (using built-in C types):

```
void RunningAverage (double N, double avg_data[8], int avg_size[2])
```

- 3 By contrast, if you remove the explicit upper bound, the generated code dynamically allocates `avg`.

Replace the statement

```
coder.varsized('avg',[1 8]);
```

with:

```
coder.varsized('avg');
```

- 4 Generate code for `RunningAverage` with input argument of type `double`:

```
codegen -config:lib -report RunningAverage -args 2
```

In the generated code, `avg` is assigned a pointer to an array, thereby allowing dynamic memory allocation. The function definition for `RunningAverage` appears as follows (using built-in C types):

```
void Test(double N, mxArray_real_T *avg)
```

---

**Note:** Dynamic memory allocation also occurs if you precede `coder.varsized('avg')` with the following `assert` statement:

```
assert(N < 6);
```

The `assert` statement does not restrict the number of concatenations within the loop.

---

- **Constrain Array Size When Rearranging a Matrix**

The statement `out = reshape(in,m,n,...)` takes an array, `in`, as an argument and returns array, `out`, having the same elements as `in`, but reshaped as an `m`-by-`n`-by-`...` matrix. If one of the size variables `m`, `n`, `...` is not a compile-time constant, then dynamic memory allocation of `out` takes place.

To avoid dynamic memory allocation, use an `assert` statement before the `reshape` statement to restrict the size variables `m`, `n`, `...` to `numel(in)`. This example shows how to use an `assert` statement before a `reshape` statement:

### Rearrange a Matrix into Given Number of Rows

- 1 Define a function, `ReshapeMatrix`, which takes an input variable, `N`, and reshapes a matrix, `mat`, to have `N` rows:

```
function [out1,out2] = ReshapeMatrix(N)

    mat = [1 2 3 4 5; 4 5 6 7 8]
    % Since mat has 10 elements, N must be a factor of 10
    % to pass as argument to reshape

    out1 = reshape(mat,N,[]);
    % N is not restricted

    assert(N < numel(mat));
    % N is restricted to number of elements in mat
    out2 = reshape(mat,N,[]);
```

- 2 Generate code for `ReshapeArray` using the `codegen` command (the input argument does not have to be a factor of 10):

```
codegen -config:lib -report ReshapeArray -args 3
```

While `out1` is dynamically allocated, `out2` is assigned an array with size 100 (=10 X 10) in the generated code.

---

**Tip:** If your system has limited memory, do not use the `assert` statement in this way. For an `n`-element matrix, the `assert` statement creates an `n`-by-`n` matrix, which might be large.

---

### Related Examples

- “Minimize Dynamic Memory Allocation” (MATLAB Coder)
- “Disable Dynamic Memory Allocation During Code Generation” (MATLAB Coder)
- “Set Dynamic Memory Allocation Threshold” (MATLAB Coder)

## **More About**

- “Dynamic Memory Allocation and Performance” (MATLAB Coder)

## Disable Dynamic Memory Allocation During Code Generation

To disable dynamic memory allocation using the MATLAB Coder app:

- 1 To open the **Generate** dialog box, on the **Generate Code** page, click the **Generate** arrow .
- 2 Click **More Settings**.
- 3 On the **Memory** tab, under **Variable Sizing Support**, set **Dynamic memory allocation** to **Never**.

To disable dynamic memory allocation at the command line:

- 1 In the MATLAB workspace, define the configuration object:  

```
cfg=coder.config('lib');
```
- 2 Set the `DynamicMemoryAllocation` property of the configuration object to `Off`:  

```
cfg.DynamicMemoryAllocation = 'Off';
```

If a variable-size array in the MATLAB code does not have a maximum upper bound, disabling dynamic memory allocation leads to a code generation error. Therefore, you can identify variable-size arrays in your MATLAB code that do not have a maximum upper bound. These arrays are the arrays that are dynamically allocated in the generated code.

### Related Examples

- “Minimize Dynamic Memory Allocation” (MATLAB Coder)
- “Provide Maximum Size for Variable-Size Arrays” (MATLAB Coder)
- “Set Dynamic Memory Allocation Threshold” (MATLAB Coder)

### More About

- “Dynamic Memory Allocation and Performance” (MATLAB Coder)

## Set Dynamic Memory Allocation Threshold

This example shows how to specify a dynamic memory allocation threshold for variable-size arrays. Dynamic memory allocation optimizes storage requirements for variable-size arrays, but causes slower execution of generated code. Instead of disabling dynamic memory allocation for all variable-size arrays, you can disable dynamic memory allocation for arrays less than a certain size.

Specify this threshold when you want to:

- Disable dynamic memory allocation for smaller arrays. For smaller arrays, static memory allocation can speed up generated code. Static memory allocation can lead to unused storage space. However, you can decide that the unused storage space is not a significant consideration for smaller arrays.
- Enable dynamic memory allocation for larger arrays. For larger arrays, when you use dynamic memory allocation, you can significantly reduce storage requirements.

### Set Dynamic Memory Allocation Threshold Using the MATLAB Coder App

- 1 To open the **Generate** dialog box, on the **Generate Code** page, click the **Generate** arrow .
- 2 Click **More Settings**.
- 3 On the **Memory** tab, select the **Enable variable-sizing** check box.
- 4 Set **Dynamic memory allocation** to **For arrays with max size at or above threshold**.
- 5 Set **Dynamic memory allocation threshold** to the value that you want.

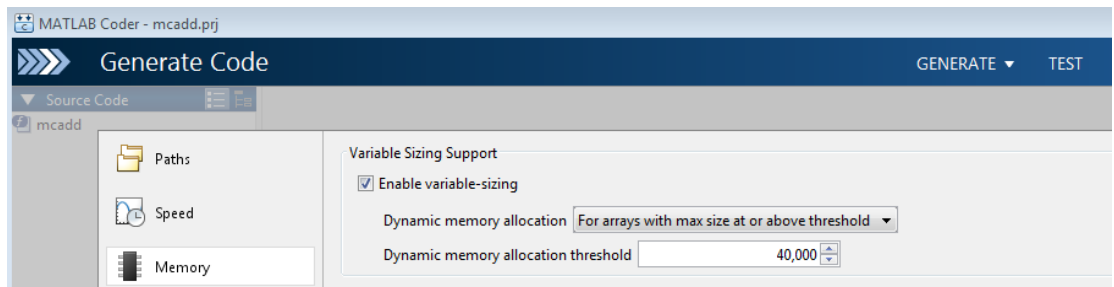



The **Dynamic memory allocation threshold** value is measured in bytes. Based on information from the target hardware settings, the software estimates the size of the array that a certain value of `DynamicMemoryAllocationThreshold` can accommodate. This estimate excludes possible C compiler optimizations such as putting variables in registers.

## Set Dynamic Memory Allocation Threshold at the Command Line

- 1 Create a configuration object for code generation. Use `coder.config` with arguments `'lib'`, `'dll'`, or `'exe'` (depending on your requirements). For example:

```
cfg = coder.config('lib');
```

- 2 Set `DynamicMemoryAllocation` to `'Threshold'`.

```
cfg.DynamicMemoryAllocation='Threshold';
```

- 3 Set the property, `DynamicMemoryAllocationThreshold`, to the value that you want.

```
cfg.DynamicMemoryAllocationThreshold = 40000;
```

The value stored in `DynamicMemoryAllocationThreshold` is measured in bytes. Based on information from the target hardware settings, the software estimates the size of the array that a certain value of `DynamicMemoryAllocationThreshold` can accommodate. This estimate excludes possible C compiler optimizations such as putting variables in registers.

## Related Examples

- “Minimize Dynamic Memory Allocation” (MATLAB Coder)
- “Provide Maximum Size for Variable-Size Arrays” (MATLAB Coder)
- “Disable Dynamic Memory Allocation During Code Generation” (MATLAB Coder)

## More About

- “Dynamic Memory Allocation and Performance” (MATLAB Coder)

## Excluding Unused Paths from Generated Code

In certain situations, you do not need some branches of an: `if`, `elseif`, `else` statement, or a `switch`, `case`, `otherwise` statement in your generated code. For instance:

- You have a MATLAB function that performs multiple tasks determined by a control-flow variable. You might not need some of the tasks in the code generated from this function.
- You have an `if/elseif/if` statement in a MATLAB function performing different tasks based on the nature (type/value) of the input. In some cases, you know the nature of the input beforehand. If so, you do not need some branches of the `if` statement.

You can prevent code generation for the unused branches of an `if/elseif/else` statement or a `switch/case/otherwise` statement. Declare the control-flow variable as a constant. The code generator produces code only for the branch that the control-flow variable chooses.

### Related Examples

- “Prevent Code Generation for Unused Execution Paths” (MATLAB Coder)

## Prevent Code Generation for Unused Execution Paths

### In this section...

“Prevent Code Generation When Local Variable Controls Flow” on page 55-27

“Prevent Code Generation When Input Variable Controls Flow” on page 55-28

If a variable controls the flow of an: `if`, `elseif`, `else` statement, or a `switch`, `case`, `otherwise` statement, declare it as constant so that code generation takes place for one branch of the statement only.

Depending on the nature of the control-flow variable, you can declare it as constant in two ways:

- If the variable is local to the MATLAB function, assign it to a constant value in the MATLAB code. For an example, see “Prevent Code Generation When Local Variable Controls Flow” on page 55-27.
- If the variable is an input to the MATLAB function, you can declare it as constant using `coder.Constant`. For an example, see “Prevent Code Generation When Input Variable Controls Flow” on page 55-28.

### Prevent Code Generation When Local Variable Controls Flow

- 1 Define a function `SquareOrCube` which takes an input variable, `in`, and squares or cubes its elements based on whether the choice variable, `ch`, is set to `s` or `c`:

```
function out = SquareOrCube(ch,in) %#codegen
    if ch=='s'
        out = in.^2;
    elseif ch=='c'
        out = in.^3;
    else
        out = 0;
    end
```

- 2 Generate code for `SquareOrCube` using the `codegen` command:

```
codegen -config:lib SquareOrCube -args {'s',zeros(2,2)}
```

The generated C code squares or cubes the elements of a 2-by-2 matrix based on the input for `ch`.

- 3 Add the following line to the definition of `SquareOrCube`:

```
ch = 's';
```

The generated C code squares the elements of a 2-by-2 matrix. The choice variable, `ch`, and the other branches of the `if/elseif/if` statement do not appear in the generated code.

## Prevent Code Generation When Input Variable Controls Flow

- 1 Define a function `MathFunc`, which performs different mathematical operations on an input, `in`, depending on the value of the input, `flag`:

```
function out = MathFunc(flag,in) %#codegen
    %# codegen
    switch flag
        case 1
            out=sin(in);
        case 2
            out=cos(in);
        otherwise
            out=sqrt(in);
    end
```

- 2 Generate code for `MathFunc` using the `codegen` command:

```
codegen -config:lib MathFunc -args {1,zeros(2,2)}
```

The generated C code performs different math operations on the elements of a 2-by-2 matrix based on the input for `flag`.

- 3 Generate code for `MathFunc`, declaring the argument, `flag`, as a constant using `coder.Constant`:

```
codegen -config:lib MathFunc -args {coder.Constant(1),zeros(2,2)}
```

The generated C code finds the sine of the elements of a 2-by-2 matrix. The variable, `flag`, and the `switch/case/otherwise` statement do not appear in the generated code.

## More About

- “Excluding Unused Paths from Generated Code” (MATLAB Coder)

## Generate Code with Parallel for-Loops (parfor)

This example shows how to generate C code for a MATLAB algorithm that contains a `parfor`-loop.

- 1 Write a MATLAB function that contains a `parfor`-loop. For example:

```
function a = test_parfor %#codegen
a=ones(10,256);
r=rand(10,256);
parfor i=1:10
    a(i,:)=real(fft(r(i,:)));
end
```

- 2 Generate C code for `test_parfor`. At the MATLAB command line, enter:

```
codegen -config:lib test_parfor
```

Because you did not specify the maximum number of threads to use, the generated C code executes the loop iterations in parallel on the available number of cores.

- 3 To specify a maximum number of threads, rewrite the function `test_parfor` as follows:

```
function a = test_parfor(u) %#codegen
a=ones(10,256);
r=rand(10,256);
parfor (i=1:10,u)
    a(i,:)=real(fft(r(i,:)));
end
```

- 4 Generate C code for `test_parfor`. Use `-args 0` to specify that the input, `u`, is a scalar double. At the MATLAB command line, enter:

```
codegen -config:lib test_parfor -args 0
```

In the generated code, the iterations of the `parfor`-loop run on at most the number of cores specified by the input, `u`. If less than `u` cores are available, the iterations run on the cores available at the time of the call.

### More About

- “Algorithm Acceleration Using Parallel for-Loops (`parfor`)” (MATLAB Coder)
- “Classification of Variables in `parfor`-Loops” (MATLAB Coder)

- “Reduction Assignments in parfor-Loops” (MATLAB Coder)

## Minimize Redundant Operations in Loops

This example shows how to minimize redundant operations in loops. When a loop operation does not depend on the loop index, performing it inside a loop is redundant. This redundancy often goes unnoticed when you are performing multiple operations in a single MATLAB statement inside a loop. For example, in the following code, the inverse of the matrix **B** is being calculated 100 times inside the loop although it does not depend on the loop index:

```
for i=1:100
    C=C + inv(B)*A^i*B;
end
```

Performing such redundant loop operations can lead to unnecessary processing. To avoid unnecessary processing, move operations outside loops as long as they do not depend on the loop index.

- 1 Define a function, `SeriesFunc(A,B,n)`, that calculates the sum of  $n$  terms in the following power series expansion:

$$C = 1 + B^{-1}AB + B^{-1}A^2B + \dots$$

```
function C=SeriesFunc(A,B,n)

% Initialize C with a matrix having same dimensions as A
C=zeros(size(A));

% Perform the series sum
for i=1:n
    C=C+inv(B)*A^i*B;
end
```

- 2 Generate code for `SeriesFunc` with 4-by-4 matrices passed as input arguments for **A** and **B**:

```
X = coder.typeof(zeros(4));
codegen -config:lib -launchreport SeriesFunc -args {X,X,10}
```

In the generated code, the inversion of **B** is performed  $n$  times inside the loop. It is more economical to perform the inversion operation once outside the loop because it does not depend on the loop index.

- 3 Modify `SeriesFunc` as follows:

```
function C=SeriesFunc(A,B,n)

% Initialize C with a matrix having same dimensions as A
C=zeros(size(A));

% Perform the inversion outside the loop
inv_B=inv(B);

% Perform the series sum
for i=1:n
    C=C+inv_B*A^i*B;
end
```

This procedure performs the inversion of **B** only once, leading to faster execution of the generated code.



## Unroll for-Loops

When the code generator unrolls a `for`-loop, instead of producing a `for`-loop in the generated code, it produces a copy of the loop body for each iteration. For small, tight loops, unrolling can improve performance. However, for large loops, unrolling can significantly increase code generation time and generate inefficient code.

The code generator uses heuristics to determine when to unroll a `for`-loop. To force loop unrolling, use `coder.unroll`. For example:

```
function z = call_myloop()
    %#codegen
    z = myloop(5);
end

function b = myloop(n)
    b = zeros(1,n);
    coder.unroll();
    for i = 1:n
        b(i)=i+n;
    end
end
```

Here is the generated code for the `for`-loop:

```
z[0] = 6.0;
z[1] = 7.0;
z[2] = 8.0;
z[3] = 9.0;
z[4] = 10.0;
```

To control when a `for`-loop is unrolled, use the `coder.unroll flag` argument. For example, unroll the loop only when the number of iterations is less than 10.

```
function z = call_myloop()
    %#codegen
    z = myloop(5);
end

function b = myloop(n)
    unroll_flag = n < 10;
    b = zeros(1,n);
    coder.unroll(unroll_flag);
    for i = 1:n
```

```
        b(i)=i+n;
end
end
```

To unroll a `for`-loop, the code generator must be able to determine the bounds of the `for`-loop. For example, code generation fails for the following code because the value of `n` is not known at code generation time.

```
function b = myloop(n)
b = zeros(1,n);
coder.unroll();
for i = 1:n
    b(i)=i+n;
end
end
```

## See Also

`coder.unroll`

## More About

- “Nonconstant Index into `vargin` or `vargout` in a `for`-Loop” on page 56-14

## Disable Support for Integer Overflow or Non-Finites

The code generator produces supporting code for the following situations:

- The result of an integer operation falls outside the range that a data type can represent. This situation is known as integer overflow.
- An operation generates non-finite values (`inf` and `NaN`). The supporting code is contained in the files `rt_nonfinite.c`, `rtGetInf.c`, and `rtGetNaN.c` (with corresponding header files).

If you know that these situations do not occur, you can suppress generation of the supporting code. You therefore reduce the size of the generated code and increase its speed. However, if one of these situations occurs, it is possible that the generated code does not match the behavior of the original MATLAB code.

### Disable Support for Integer Overflow

You can use the MATLAB Coder app or the command-line interface to disable support for integer overflow. When you disable this support, the overflow behavior of your generated code depends on your target C compiler. Most C compilers wrap on overflow.

- Using the app:
  - 1 To open the **Generate** dialog box, on the **Generate Code** page, click the **Generate** arrow .
  - 2 Click **More Settings**.
  - 3 On the **Speed** tab, clear **Saturate** on integer overflow.
- At the command line:
  - 1 Create a configuration object for code generation. Use `coder.config` with arguments `'lib'`, `'dll'`, or `'exe'` (depending on your requirements). For example:

```
cfg = coder.config('lib');
```
  - 2 Set the `SaturateOnIntegerOverflow` property to `false`.

```
cfg.SaturateOnIntegerOverflow = false;
```

## Disable Support for Non-Finite Numbers

You can use the MATLAB Coder app or the command-line interface to disable support for non-finite numbers(`inf` and `NaN`).

- Using the app:
  - 1 To open the **Generate** dialog box, on the **Generate Code** page, click the **Generate** arrow .
  - 2 Set **Build type** to `Source Code`, `Static Library`, `Dynamic Library`, or `Executable` (depending on your requirements).
  - 3 Click **More Settings**.
  - 4 On the **Speed** tab, clear the **Support non-finite numbers** check box.
- At the command line:
  - 1 Create a configuration object for code generation. Use `coder.config` with arguments `'lib'`, `'dll'`, or `'exe'` (depending on your requirements). For example:

```
cfg = coder.config('lib');
```
  - 2 Set the `SupportNonFinite` property to `false`.

```
cfg.SupportNonFinite = false;
```

## Integrate External/Custom Code

This example shows how to integrate external or custom code to enhance performance of generated code. Although MATLAB Coder generates optimized code for most applications, you might have custom code optimized for your specific requirements. For example:

- You have custom libraries optimized for your target environment.
- You have custom libraries for functions not supported by MATLAB Coder.
- You have custom libraries that meet standards set by your company.

In such cases, you can integrate your custom code with the code generated by MATLAB Coder.

This example illustrates how to integrate the function `cublasSgemm` from the NVIDIA® CUDA® Basic Linear Algebra Subroutines (CUBLAS) library in generated code. This function performs matrix multiplication on a Graphics Processing Unit (GPU).

- 1 Define a class `ExternalLib_API` that derives from the class `coder.ExternalDependency`. `ExternalLib_API` defines an interface to the CUBLAS library through the following methods:
  - `getDescriptiveName`: Returns a descriptive name for `ExternalLib_API` to be used for error messages.
  - `isSupportedContext`: Determines if the build context supports the CUBLAS library.
  - `updateBuildInfo`: Adds header file paths and link files to the build information.
  - `GPU_MatrixMultiply`: Defines the interface to the CUBLAS library function `cublasSgemm`.

### ExternalLib\_API.m

```
classdef ExternalLib_API < coder.ExternalDependency
    %#codegen

    methods (Static)

        function bName = getDescriptiveName(-)
            bName = 'ExternalLib_API';
```

```
end

function tf = isSupportedContext(ctx)
    if ctx.isMatlabHostTarget()
        tf = true;
    else
        error('CUBLAS library not available for this target');
    end
end

function updateBuildInfo(buildInfo, ctx)
    [~, linkLibExt, ~, ~] = ctx.getStdLibInfo();

    % Include header file path
    % Include header files later using coder.cinclude
    hdrFilePath = 'C:\My_Includes';
    buildInfo.addIncludePaths(hdrFilePath);

    % Include link files
    linkFiles = strcat('libcublas', linkLibExt);
    linkPath = 'C:\My_Libs';
    linkPriority = '';
    linkPrecompiled = true;
    linkLinkOnly = true;
    group = '';
    buildInfo.addLinkObjects(linkFiles, linkPath, ...
        linkPriority, linkPrecompiled, linkLinkOnly, group);

    linkFiles = strcat('libcudart', linkLibExt);
    buildInfo.addLinkObjects(linkFiles, linkPath, ...
        linkPriority, linkPrecompiled, linkLinkOnly, group);

end

%API for library function 'cuda_MatrixMultiply'
function C = GPU_MatrixMultiply(A, B)
    assert(isa(A, 'single'), 'A must be single. ');
    assert(isa(B, 'single'), 'B must be single. ');

    if(coder.target('MATLAB'))
        C=A*B;
    else

        % Include header files
```

```
% for external functions and typedefs
% Header path included earlier using updateBuildInfo
coder.cinclude('"cuda_runtime.h"');
coder.cinclude('"cublas_v2.h"');

% Compute dimensions of input matrices
m = int32(size(A, 1));
k = int32(size(A, 2));
n = int32(size(B, 2));

% Declare pointers to matrices on destination GPU
d_A = coder.opaque('float*');
d_B = coder.opaque('float*');
d_C = coder.opaque('float*');

% Compute memory to be allocated for matrices
% Single = 4 bytes
size_A = m*k*4;
size_B = k*n*4;
size_C = m*n*4;

% Define error variables
error = coder.opaque('cudaError_t');
cudaSuccessV = coder.opaque('cudaError_t', ...
    'cudaSuccess');

% Assign memory on destination GPU
error = coder.ceval('cudaMalloc', ...
    coder.wref(d_A), size_A);
assert(error == cudaSuccessV, ...
    'cudaMalloc(A) failed');
error = coder.ceval('cudaMalloc', ...
    coder.wref(d_B), size_B);
assert(error == cudaSuccessV, ...
    'cudaMalloc(B) failed');
error = coder.ceval('cudaMalloc', ...
    coder.wref(d_C), size_C);
assert(error == cudaSuccessV, ...
    'cudaMalloc(C) failed');

% Define direction of copying
hostToDevice = coder.opaque('cudaMemcpyKind', ...
    'cudaMemcpyHostToDevice');
```

```
% Copy matrices to destination GPU
error = coder.ceval('cudaMemcpy', ...
    d_A, coder.rref(A), size_A, hostToDevice);
assert(error == cudaSuccessV, 'cudaMemcpy(A) failed');

error = coder.ceval('cudaMemcpy', ...
    d_B, coder.rref(B), size_B, hostToDevice);
assert(error == cudaSuccessV, 'cudaMemcpy(B) failed');

% Define type and size for result
C = zeros(m, n, 'single');

error = coder.ceval('cudaMemcpy', ...
    d_C, coder.rref(C), size_C, hostToDevice);
assert(error == cudaSuccessV, 'cudaMemcpy(C) failed');

% Define handle variables for external library
handle = coder.opaque('cublasHandle_t');
blasSuccess = coder.opaque('cublasStatus_t', ...
    'CUBLAS_STATUS_SUCCESS');

% Initialize external library
ret = coder.opaque('cublasStatus_t');
ret = coder.ceval('cublasCreate', coder.wref(handle));
assert(ret == blasSuccess, 'cublasCreate failed');

TRANSA = coder.opaque('cublasOperation_t', ...
    'CUBLAS_OP_N');
alpha = single(1);
beta = single(0);

% Multiply matrices on GPU
ret = coder.ceval('cublasSgemm', handle, ...
    TRANSA, TRANSA, m, n, k, ...
    coder.rref(alpha), d_A, m, ...
    d_B, k, ...
    coder.rref(beta), d_C, k);

assert(ret == blasSuccess, 'cublasSgemm failed');

% Copy result back to local host
deviceToHost = coder.opaque('cudaMemcpyKind', ...
    'cudaMemcpyDeviceToHost');
```



```

        error = coder.ceval('cudaMemcpy', coder.wref(C), ...
            d_C, size_C, deviceToHost);
        assert(error == cudaSuccessV, 'cudaMemcpy(C) failed');
    end
end
end
end
end

```

- 2 To perform the matrix multiplication using the interface defined in method `GPU_MatrixMultiply` and the build information in `ExternalLib_API`, include the following line in your MATLAB code:

```
C= ExternalLib_API.GPU_MatrixMultiply(A,B);
```

For instance, you can define a MATLAB function `Matrix_Multiply` that solely performs this matrix multiplication.

```
function C = Matrix_Multiply(A, B) %#codegen
    C= ExternalLib_API.GPU_MatrixMultiply(A,B);
```

- 3 Define a MEX configuration object using `coder.config`. For using the CUBLAS libraries, set the target language for code generation to C++.

```
cfg=coder.config('mex');
cfg.TargetLang='C++';
```

- 4 Generate code for `Matrix_Multiply` using `cfg` as the configuration object and two 2 X 2 matrices of type `single` as arguments. Since `cublasSgemv` supports matrix multiplication for data type `float`, the corresponding MATLAB matrices must have type `single`.

```
codegen -config cfg Matrix_Multiply ...
        -args {ones(2,'single'),ones(2,'single')}
```

- 5 Test the generated MEX function `Matrix_Multiply_mex` using two 2 X 2 identity matrices of type `single`.

```
Matrix_Multiply_mex(eye(2,'single'),eye(2,'single'))
```

The output is also a 2 X 2 identity matrix.

## See Also

`coder.BuildConfig` | `assert` | `coder.ceval` | `coder.ExternalDependency` | `coder.opaque` | `coder.rref` | `coder.wref`

### **Related Examples**

- “Encapsulate Interface to an External C Library” (MATLAB Coder)

### **More About**

- “Encapsulating the Interface to External Code” (MATLAB Coder)

## Generate Reusable Code

With MATLAB, you can generate reusable code in the following ways:

- Write reusable functions using standard MATLAB function file names which you can call from different locations, for example, in a Simulink model or MATLAB function library.
- Compile external functions on the MATLAB path and integrate them into generated C code for embedded targets.

See “Resolution of Function Calls for Code Generation” (MATLAB Coder).

Common applications include:

- Overriding generated library function with a custom implementation.
- Implementing a reusable library on top of standard library functions that can be used with Simulink.
- Swapping between different implementations of the same function.

## LAPACK Calls for Linear Algebra in a MATLAB Function Block

To improve the simulation speed of MATLAB Function block algorithms that call certain linear algebra functions, Simulink can call LAPACK functions. LAPACK is a software library for numerical linear algebra. If the input arrays for the linear algebra functions meet certain criteria, the simulation calls LAPACK functions in the LAPACK library that is included with MATLAB. MATLAB uses LAPACK in some linear algebra functions such as `eig` and `svd`.

If you use Simulink Coder to generate code for these algorithms, you can specify that the code generator produce LAPACK function calls. The code generator uses the LAPACKE C interface to LAPACK. If you specify that you want to generate LAPACK calls, and the input arrays for the linear algebra functions meet the criteria, the code generator produces LAPACK calls. The build process links to the LAPACK library that you specify. See “Speed Up Linear Algebra in Code Generated from a MATLAB Function Block” (Simulink Coder).

### Related Examples

- “Create Model That Uses MATLAB Function Block” on page 40-9

### More About

- “What Is a MATLAB Function Block?” on page 40-5

### External Websites

- [www.netlib.org/lapack](http://www.netlib.org/lapack)

# Troubleshooting MATLAB Code in MATLAB Function Blocks

---

- “Compile-Time Recursion Limit Reached” on page 56-2
- “Output Variable Must Be Assigned Before Run-Time Recursive Call” on page 56-7
- “Unable to Determine That Every Element of Cell Array Is Assigned” on page 56-10
- “Nonconstant Index into varargin or varargin in a for-Loop” on page 56-14

## Compile-Time Recursion Limit Reached

### Issue

You see a message such as:

```
Compile-time recursion limit reached. Size or type of input #1 of function 'foo' may change at every call.
```

```
Compile-time recursion limit reached. Size of input #1 of function 'foo' may change at every call.
```

```
Compile-time recursion limit reached. Value of input #1 of function 'foo' may change at every call.
```

### Cause

With compile-time recursion, the code generator produces multiple versions of the recursive function instead of producing a recursive function in the generated code. These versions are known as function specializations. The code generator is unable to use compile-time recursion for a recursive function in your MATLAB code because the number of function specializations exceeds the limit.

### Solutions

To address the issue, try one of these solutions:

- “Force Run-Time Recursion” on page 56-2
- “Increase the Compile-Time Recursion Limit” on page 56-5

### Force Run-Time Recursion

- For this message:

```
Compile-time recursion limit reached. Value of input #1 of function 'foo' may change at every call.
```

Use this solution:

“Force Run-Time Recursion by Treating the Input Value as Nonconstant” on page 56-3.

- For this message:

```
Compile-time recursion limit reached. Size of input #1 of function 'foo' may
change at every call.
```

Use this solution:

“Force Run-Time Recursion by Making the Input Variable-Size” on page 56-4.

- For this message:

```
Compile-time recursion limit reached. Size or type of input #1 of function 'foo'
may change at every call.
```

In the In the MATLAB Function report, look at the function specializations. If you can see that the size of an argument is changing for each function specialization, then try this solution:

“Force Run-Time Recursion by Making the Input Variable-Size” on page 56-4.

### Force Run-Time Recursion by Treating the Input Value as Nonconstant

Consider this function:

```
function y = call_recfcn(n)
A = ones(1,n);
x = 100;
y = recfcn(A,x);
end

function y = recfcn(A,x)
if size(A,2) == 1 || x == 1
    y = A(1);
else
    y = A(1)+recfcn(A(2:end),x-1);
end
end
```

The second input to `recfcn` has the constant value 100. The code generator determines that the number of recursive calls is finite and tries to produce 100 copies of `recfcn`. This number of specializations exceeds the compile-time recursion limit. To force run-

time recursion, instruct the code generator to treat the second input as a nonconstant value by using `coder.ignoreConst`.

```
function y = call_recfcn(n)
A = ones(1,n);
x = coder.ignoreConst(100);
y = recfcn(A,x);
end

function y = recfcn(A,x)
if size(A,2) == 1 || x == 1
    y = A(1);
else
    y = A(1)+recfcn(A(2:end),x-1);
end
end
```

If the code generator cannot determine that the number of recursive calls is finite, it produces a run-time recursive function.

### Force Run-Time Recursion by Making the Input Variable-Size

Consider this function:

```
function z = call_mysum(A)
%#codegen
z = mysum(A);
end

function y = mysum(A)
coder.inline('never');
if size(A,2) == 1
    y = A(1);
else
    y = A(1)+mysum(A(2:end));
end
end
```

If the input to `mysum` is fixed-size, the code generator uses compile-time recursion. If `A` is large enough, the number of function specializations exceeds the compile-time limit. To cause the code generator to use run-time conversion, make the input to `mysum` variable-size by using `coder. varsizes`.

```
function z = call_mysum(A)
%#codegen
```



```

B = A;
coder.varsize('B');
z = mysum(B);
end

function y = mysum(A)
coder.inline('never');
if size(A,2) == 1
    y = A(1);
else
    y = A(1) + mysum(A(2:end));
end
end

```

## Increase the Compile-Time Recursion Limit

The default compile-time recursion limit of 50 is large enough for most recursive functions that require compile-time recursion. Usually, increasing the limit does not fix the issue. However, if you can determine the number of recursive calls and you want compile-time recursion, increase the limit. For example, consider this function:

```

function z = call_mysum()
%#codegen
B = 1:125;
z = mysum(B);
end

function y = mysum(A)
coder.inline('never');
if size(A,2) == 1
    y = A(1);
else
    y = A(1) + mysum(A(2:end));
end
end

```

You can determine that the code generator produces 125 copies of the `mysum` function. In this case, if you want compile-time recursion, increase the compile-time recursion limit to 125.

To increase the limit, in the model configuration parameters, on the **All Parameters** tab, in the **Simulation Target** category, increase the value of **Compile-time recursion limit for MATLAB functions**.

### **More About**

- “Code Generation for Recursive Functions” on page 54-18
- “Compile-time recursion limit for MATLAB functions”

# Output Variable Must Be Assigned Before Run-Time Recursive Call

## Issue

You see one of these messages:

```
All outputs must be assigned before any run-time recursive call. Output 'y' is not assigned here.
```

Simulink does not have enough information to determine output sizes for this block.

## Cause

Run-time recursion produces a recursive function in the generated code. The code generator is unable to use run-time recursion for a recursive function in your MATLAB code because an output is not assigned before the first recursive call.

## Solution

Rewrite the code so that it assigns the output before the recursive call.

### Direct Recursion Example

In the following code, the statement `y = A(1)` assigns a value to the output `y`. This statement occurs after the recursive call `y = A(1)+ mysum(A(2:end))`.

```
function z = call_mysum(A)
B = A;
coder.varsize('B');
z = mysum(B);
end

function y = mysum(A)
coder.inline('never');
if size(A,2) > 1
    y = A(1)+ mysum(A(2:end));
else
    y = A(1);
end
```

```
end
```

Rewrite the code so that assignment  $y = A(1)$  occurs in the `if` block and the recursive call occurs in the `else` block.

```
function z = call_mysum(A)
B = A;
coder.varsize('B');
z = mysum(B);
end

function y = mysum(A)
coder.inline('never');

if size(A,2) == 1
    y = A(1);
else
    y = A(1)+ mysum(A(2:end));
end
end
```

Alternatively, before the `if` block, add an assignment, for example,  $y = 0$ .

```
function z = call_mysum(A)
B = A;
coder.varsize('B');
z = mysum(B);
end

function y = mysum(A)
coder.inline('never');
y = 0;
if size(A,2) > 1
    y = A(1)+ mysum(A(2:end));
else
    y = A(1);
end
end
```

### Indirect Recursion Example

In the following code, `rec1` calls `rec2` before the assignment  $y = 0$ .

```
function z = callrec(n)
```

```
z = rec1(n);
end

function y = rec1(x)
%#codegen

if x >= 0
    y = rec2(x-1)+1;
else
    y = 0;
end
end

function y = rec2(x)
y = rec1(x-1)+2;
end
```

Rewrite this code so that in `rec1`, the assignment `y = 0` occurs in the `if` block and the recursive call occurs in the `else` block.

```
function z = callrec(n)
z = rec1(n);
end

function y = rec1(x)
%#codegen

if x < 0
    y = 0;
else
    y = rec2(x-1)+1;
end
end

function y = rec2(x)
y = rec1(x-1)+2;
end
```

## More About

- “Code Generation for Recursive Functions” on page 54-18

## Unable to Determine That Every Element of Cell Array Is Assigned

### Issue

You see one of these messages:

```
Unable to determine that every element of 'y' is assigned before this line.
```

```
Unable to determine that every element of 'y' is assigned before exiting the function.
```

```
Unable to determine that every element of 'y' is assigned before exiting the recursively called function.
```

### Cause

For code generation, before you use a cell array element, you must assign a value to it. When you use `cell` to create a variable-size cell array, for example, `cell(1,n)`, MATLAB assigns an empty matrix to each element. However, for code generation, the elements are unassigned. For code generation, after you use `cell` to create a variable-size cell array, you must assign all elements of the cell array before any use of the cell array.

The code generator analyzes your code to determine whether all elements are assigned before the first use of the cell array. The code generator detects that all elements are assigned when the code follows this pattern:

```
function z = mycell(n, j)
%#codegen
assert(n < 100);
x = cell(1,n);
for i = 1:n
    x{i} = i;
end
z = x{j};
end
```

Here is the pattern for a multidimensional cell array:

```
function z = mycell(m,n,p)
%#codegen
assert(m < 100);
```

```

assert(n < 100);
assert(p < 100);
x = cell(m,n,p);
for i = 1:m
    for j = 1:n
        for k = 1:p
            x{i,j,k} = i+j+k;
        end
    end
end
z = x{m,n,p};
end

```

If the code generator detects that some elements are not assigned, code generation fails. Sometimes, even though your code assigns all elements of the cell array, code generation fails because the analysis does not detect that all elements are assigned.

Here are examples where the code generator is unable to detect that elements are assigned:

- Elements are assigned in different loops

```

...
x = cell(1,n)
for i = 1:5
    x{i} = 5;
end
for i = 6:n
    x{i} = 7;
end
...

```

- The variable that defines the loop end value is not the same as the variable that defines the cell dimension.

```

...
x = cell(1,n);
m = n;
for i = 1:m
    x{i} = 2;
end
...

```

For more information, see “Definition of Variable-Size Cell Array by Using cell” on page 50-9.

## Solution

Try one of these solutions:

- “Use recognized pattern for assigning elements” on page 56-12
- “Use repmat” on page 56-12
- “Use coder.nullcopy” on page 56-13

### Use recognized pattern for assigning elements

If possible, rewrite your code to follow this pattern:

```
...  
x = cell(1,n);  
for i = 1:n  
    x{i} = i;  
end  
z = x{j};  
...
```

### Use repmat

Sometimes, you can use `repmat` to define the variable-size cell array.

Consider this code that defines a variable-size cell array. It assigns the value 1 to odd elements and the value 2 to even elements.

```
function z = mycell2(n, j)  
%#codegen  
assert(n < 100);  
c = cell(1,n);  
for i = 1:2:n-1  
    c{i} = 1;  
end  
for i = 2:2:n  
    c{i} = 2;  
end  
z = c{j};
```

Code generation does not allow this code because:

- More than one loop assigns the elements.
- The loop counter does not increment by 1.



Rewrite the code to first use `cell` to create a 1-by-2 cell array whose first element is 1 and whose second element is 2. Then, use `repmat` to create a variable-size cell array whose element values alternate between 1 and 2.

```
function z = mycell12(n, j)
%#codegen
assert(n < 100);
c = cell(1,2);
c{1} = 1;
c{2} = 2;
c1= repmat(c,1,n);
z = c1{j};
end
```

### Use `coder.nullcopy`

As a last resort, you can use `coder.nullcopy` to indicate that the code generator can allocate the memory for your cell array without initializing the memory. For example:

```
function z = mycell13(n, j)
%#codegen
assert(n < 100);
c =cell(1,n);
c1 = coder.nullcopy(c);
for i = 1:4
    c1{i} = 1;
end
for i = 5:n
    c1{i} = 2;
end
z = c1{j};
end
```

Use `coder.nullcopy` with caution. If you access uninitialized memory, results are unpredictable.

### See Also

`cell` | `coder.nullcopy` | `repmat`

### More About

- “Cell Array Limitations for Code Generation” on page 50-8

## Nonconstant Index into varargin or varargout in a for-Loop

### Issue

Your MATLAB code contains a `for`-loop that indexes into `varargin` or `varargout`. When you generate code, you see this error message:

```
Non-constant expression or empty matrix. This expression must be constant because its value determines the size or class of some expression.
```

### Cause

At code generation time, the code generator must be able to determine the value of an index into `varargin` or `varargout`. When `varargin` or `varargout` are indexed in a `for`-loop, the code generator determines the index value for each loop iteration by unrolling the loop. Loop unrolling makes a copy of the loop body for each loop iteration. In each iteration, the code generator determines the value of the index from the loop counter.

The code generator is unable to determine the value of an index into `varargin` or `varargout` when:

- The number of copies of the loop body exceeds the limit for loop unrolling.
- Heuristics fail to identify that loop unrolling is warranted for a particular `for`-loop. For example, consider the following function:

```
function [x,y,z] = fcn(a,b,c)
    %#codegen

    [x,y,z] = subfcn(a,b,c);

    function varargout = subfcn(varargin)
        j = 0;
        for i = 1:nargin
            j = j+1;
            varargout{j} = varargin{j};
        end
```

The heuristics do not detect the relationship between the index `j` and the loop counter `i`. Therefore, the code generator does not unroll the `for`-loop.

## Solution

Use one of these solutions:

- “Force Loop Unrolling” on page 56-15
- “Rewrite the Code” on page 56-15

### Force Loop Unrolling

Force loop unrolling by using `coder.unroll`. For example:

```
function [x,y,z] = fcn(a,b,c)
%#codegen
[x,y,z] = subfcn(a,b,c);

function varargout = subfcn(varargin)
j = 0;

coder.unroll();
for i = 1:nargin
    j = j + 1;
    varargout{j} = varargin{j};
end
```

### Rewrite the Code

Rewrite the code so that the code generator can detect the relationship between the index and the loop counter. For example:

```
function [x,y,z] = fcn(a,b,c)
%#codegen
[x,y,z] = subfcn(a,b,c);

function varargout = subfcn(varargin)
for i = 1:nargin
    varargout{i} = varargin{i};
end
```

## See Also

`coder.unroll`

## More About

- “Code Generation for Variable Length Argument Lists” on page 53-2

- “Unroll for-Loops” on page 55-33

# Managing Data



# Working with Data

---

- “About Data Types in Simulink” on page 57-3
- “Data Types Supported by Simulink” on page 57-6
- “Control Signal Data Types” on page 57-8
- “Validate a Floating-Point Embedded Model” on page 57-20
- “Fixed-Point Numbers” on page 57-25
- “Benefits of Using Fixed-Point Hardware” on page 57-28
- “Scaling, Precision, and Range” on page 57-30
- “Fixed-Point Data in MATLAB and Simulink” on page 57-33
- “Share Fixed-Point Models” on page 57-37
- “Control Fixed-Point Instrumentation and Data Type Override” on page 57-39
- “Specify Fixed-Point Data Types” on page 57-42
- “Specify Data Types Using Data Type Assistant” on page 57-45
- “Data Types for Bus Signals” on page 57-58
- “Data Objects” on page 57-59
- “Define Data Classes” on page 57-80
- “Determine Where to Store Variables and Objects for Simulink Models” on page 57-85
- “Edit and Manage Workspace Variables Used by Models” on page 57-92
- “Model Workspaces” on page 57-106
- “Specify Source for Data in Model Workspace” on page 57-109
- “Change Model Workspace Data” on page 57-114
- “Symbol Resolution” on page 57-118
- “Configure Data Properties by Using a Table” on page 57-123
- “Upgrade Level-1 Data Classes” on page 57-130
- “Associating User Data with Blocks” on page 57-132

- “Support Limitations for Simulink Software Features” on page 57-133
- “Supported and Unsupported Simulink Blocks” on page 57-136
- “Support Limitations for Stateflow Software Features” on page 57-148



## About Data Types in Simulink

### In this section...

“About Data Types” on page 57-3

“Data Typing Guidelines” on page 57-4

“Data Type Propagation” on page 57-4

### About Data Types

The term *data type* refers to the way in which a computer represents numbers in memory. A data type determines the amount of storage allocated to a number, the method used to encode the number's value as a pattern of binary digits, and the operations available for manipulating the type. Most computers provide a choice of data types for representing numbers, each with specific advantages in the areas of precision, dynamic range, performance, and memory usage. To optimize performance, you can specify the data types of variables used in the MATLAB technical computing environment. Simulink builds on this capability by allowing you to specify the data types of Simulink signals and block parameters.

The ability to specify the data types of a model's signals and block parameters is particularly useful in real-time control applications. For example, it allows a Simulink model to specify the optimal data types to use to represent signals and block parameters in code generated from a model by automatic code-generation tools, such as the Simulink Coder product. By choosing the most appropriate data types for your model's signals and parameters, you can dramatically increase performance and decrease the size of the code generated from the model.

Simulink performs extensive checking before and during a simulation to ensure that your model is *typesafe*, that is, that code generated from the model will not overflow or underflow and thus produce incorrect results. Simulink models that use the default data type (**double**) are inherently typesafe. Thus, if you never plan to generate code from your model or use a nondefault data type in your models, you can skip the remainder of this section.

On the other hand, if you plan to generate code from your models and use nondefault data types, read the remainder of this section carefully, especially the section on data type rules (see “Data Typing Guidelines” on page 57-4). In that way, you can avoid introducing data type errors that prevent your model from running to completion or simulating at all.

## Data Typing Guidelines

Observing the following rules can help you to create models that are typesafe and, therefore, execute without error:

- Signal data types generally do not affect parameter data types, and vice versa.

A significant exception to this rule is the Constant block, whose output data type is determined by the data type of its parameter.

- If the output of a block is a function of an input and a parameter, and the input and parameter differ in type, Simulink converts the parameter to the input type before computing the output.
- In general, a block outputs the data type that appears at its inputs.

Significant exceptions include Constant blocks and Data Type Conversion blocks, whose output data types are determined by block parameters.

- Virtual blocks accept signals of any type on their inputs.

Examples of virtual blocks include Mux and Demux blocks and unconditionally executed subsystems.

- The elements of a signal array connected to a port of a nonvirtual block must be of the same data type.
- The signals connected to the input data ports of a nonvirtual block cannot differ in type.
- Control ports (for example, Enable and Trigger ports) accept any data type.
- Solver blocks accept only `double` signals.
- Connecting a non-`double` signal to a block disables zero-crossing detection for that block.

## Data Type Propagation

Whenever you start a simulation, enable display of port data types, or refresh the port data type display, Simulink performs a processing step called data type propagation. This step involves determining the types of signals whose type is not otherwise specified and checking the types of signals and input ports to ensure that they do not conflict. If type conflicts arise, an error dialog is displayed that specifies the signal and port whose data types conflict. The signal path that creates the type conflict is also highlighted.

---

**Note** You can insert typecasting (data type conversion) blocks in your model to resolve type conflicts. For more information, see [Data Type Conversion](#).

---

## See Also

`Simulink.AliasType` | `Simulink.NumericType`

## Related Examples

- “Control Signal Data Types” on page 57-8
- “Control Block Parameter Data Types” on page 35-57
- “Validate a Floating-Point Embedded Model” on page 57-20
- “Specify Fixed-Point Data Types” on page 57-42
- “Data Types Supported by Simulink” on page 57-6

## Data Types Supported by Simulink

Simulink supports all built-in numeric MATLAB data types except `int64` and `uint64`. The term *built-in data type* refers to data types defined by MATLAB itself as opposed to data types defined by MATLAB users. Unless otherwise specified, the term data type in the Simulink documentation refers to built-in data types.

The following table lists the built-in MATLAB data types supported by Simulink.

Name	Description
<code>double</code>	Double-precision floating point
<code>single</code>	Single-precision floating point
<code>int8</code>	Signed 8-bit integer
<code>uint8</code>	Unsigned 8-bit integer
<code>int16</code>	Signed 16-bit integer
<code>uint16</code>	Unsigned 16-bit integer
<code>int32</code>	Signed 32-bit integer
<code>uint32</code>	Unsigned 32-bit integer

Besides these built-in types, Simulink defines a `boolean` (`true` or `false`) type. The values `1` and `0` represent `true` and `false` respectively. For this data type, Simulink represents real, nonzero numeric values (including `Inf`) as `true` (`1`).

### Block Support for Data and Signal Types

All Simulink blocks accept signals of type `double` by default. Some blocks prefer `boolean` input and others support multiple data types on their inputs. For more information on the data types supported by a specific block for parameter and input and output values, in the Simulink documentation see the Data Type Support section of the reference page for that block. If the documentation for a block does not specify a data type, the block inputs or outputs only data of type `double`.

Several blocks support bus objects (`Simulink.Bus`) as data types. See “Data Types for Bus Signals” on page 57-58.

Many Simulink blocks also support fixed-point data types. For more information about fixed-point data, see “Specify Fixed-Point Data Types” on page 57-42. For more

information on the data types supported by a specific block for parameter and input and output values, in the Simulink documentation see the Data Type Support section of the reference page for that block. If the documentation for a block does not specify a data type, the block inputs or outputs only data of type **double**.

To view a table that summarizes the data types supported by the blocks in the Simulink block libraries, execute the following command at the MATLAB command line:

```
showblockdatatypetable
```

## See Also

`Simulink.AliasType` | `Simulink.NumericType`

## Related Examples

- “Data Typing in Simulink”
- “Control Signal Data Types” on page 57-8
- “Specify Fixed-Point Data Types” on page 57-42
- “Define Simulink Enumerations” on page 58-7
- “Specify Data Types Using Data Type Assistant” on page 57-45
- “About Data Types in Simulink” on page 57-3

## Control Signal Data Types

To control the data type of a signal in a Simulink model, you specify a data type for the corresponding block output.

You can also introduce a new signal of a specific data type into a model in any of the following ways:

- Load signal data of the desired type from the MATLAB workspace into your model via a root-level Inport block or a From Workspace block.
- Create a Constant block in your model and set its parameter to the desired type.
- Use a Data Type Conversion block to convert a signal to the desired data type.

Simulink blocks determine the data type of their outputs by default. Many blocks allow you to override the default type and explicitly specify an output data type, using a block parameter that is typically named **Output data type**. For example, the **Output data type** parameter appears on the **Signal Attributes** pane of the Constant block dialog box.

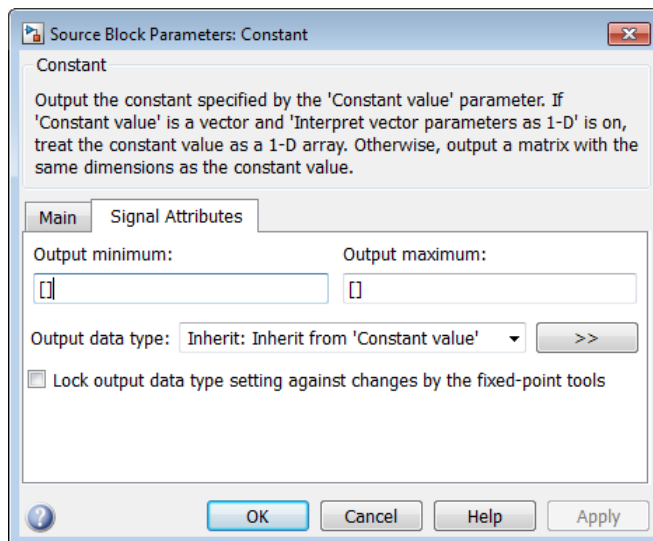

See the following topics for more information:

For Information About...	See...
Valid data type values that you can specify	“Entering Valid Data Type Values” on page 57-9
An assistant that helps you specify valid data type values	“Specify Data Types Using Data Type Assistant” on page 57-45
Specifying valid data type values for multiple blocks simultaneously	“Using the Model Explorer for Batch Editing” on page 57-12

## Entering Valid Data Type Values

In general, you can specify the output data type as any of the following:

- A rule that inherits a data type (see “Data Type Inheritance Rules” on page 57-10)
- The name of a built-in data type (see “Built-In Data Types” on page 57-11)
- An expression that evaluates to a data type (see “Data Type Expressions” on page 57-11)

Valid data type values vary among blocks. You can use the pull-down menu associated with a block data type parameter to view the data types that a particular block supports. For example, the **Data type** pull-down menu on the Data Store Memory block dialog box lists the data types that it supports, as shown here.

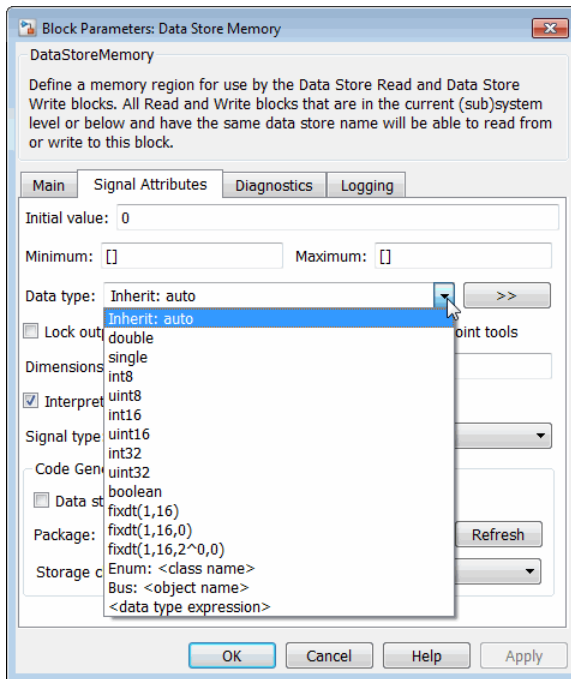

For more information about the data types that a specific block supports, see the documentation for the block in the Simulink documentation.

### Data Type Inheritance Rules

Blocks can inherit data types from a variety of sources, including signals to which they are connected and particular block parameters. You can specify the value of a data type parameter as a rule that determines how the output signal inherits its data type. To view the inheritance rules that a block supports, use the data type pull-down menu on the block dialog box. The following table lists typical rules that you can select.

Inheritance Rule	Description
Inherit: Inherit via back propagation	Simulink automatically determines the output data type of the block during data type propagation (see “Data Type Propagation” on page 57-4). In this case, the block uses the data type of a downstream block or signal object.



Inheritance Rule	Description
Inherit: Same as input	The block uses the data type of its sole input signal for its output signal.
Inherit: Same as first input	The block uses the data type of its first input signal for its output signal.
Inherit: Same as second input	The block uses the data type of its second input signal for its output signal.
Inherit: Inherit via internal rule	The block uses an internal rule to determine its output data type. The internal rule chooses a data type that optimizes numerical accuracy, performance, and generated code size, while taking into account the properties of the embedded target hardware. It is not always possible for the software to optimize efficiency and numerical accuracy at the same time.

When you apply inherited data types to a signal, Simulink determines the specific data type of the signal only after you update the block diagram. To display this specific data type on the block diagram, see “Port Data Types” on page 62-60.

### Built-In Data Types

You can specify the value of a data type parameter as the name of a built-in data type, for example, `single` or `boolean`. To view the built-in data types that a block supports, use the data type pull-down menu on the block dialog box. See “Data Types Supported by Simulink” on page 57-6 for a list of all built-in data types that are supported.

### Data Type Expressions

You can specify the value of a data type parameter as an expression that evaluates to a numeric data type object. Simply enter the expression in the data type field on the block dialog box. In general, enter one of the following expressions:

- **fixdt Command**

Specify the value of a data type parameter as a command that invokes the `fixdt` function. This function allows you to create a `Simulink.NumericType` object that

describes a fixed-point or floating-point data type. See the documentation for the `fixdt` function for more information.

- **Data Type Object Name**

Specify the value of a data type parameter as the name of a data object that represents a data type. Simulink data objects that you instantiate from classes, such as `Simulink.NumericType` and `Simulink.AliasType`, simplify the task of making model-wide changes to output data types and allow you to use custom aliases for data types. See “Data Objects” on page 57-59 for more information about Simulink data objects.

## Using the Model Explorer for Batch Editing

Using the Model Explorer (see “Search and Edit Using Model Explorer” on page 12-2), you can assign the same output data type to multiple blocks simultaneously. For example, the `slexAircraftExample` model that comes with the Simulink product contains numerous Gain blocks. Suppose you want to specify the **Output data type** parameter of all the Gain blocks in the model as `single`. You can achieve this task as follows:

- 1 Use the Model Explorer search bar (see “Search Using Model Explorer” on page 12-52) to identify all blocks in the `slexAircraftExample` model of type `Gain`.

The Model Explorer **Contents** pane lists all Gain blocks in the model.

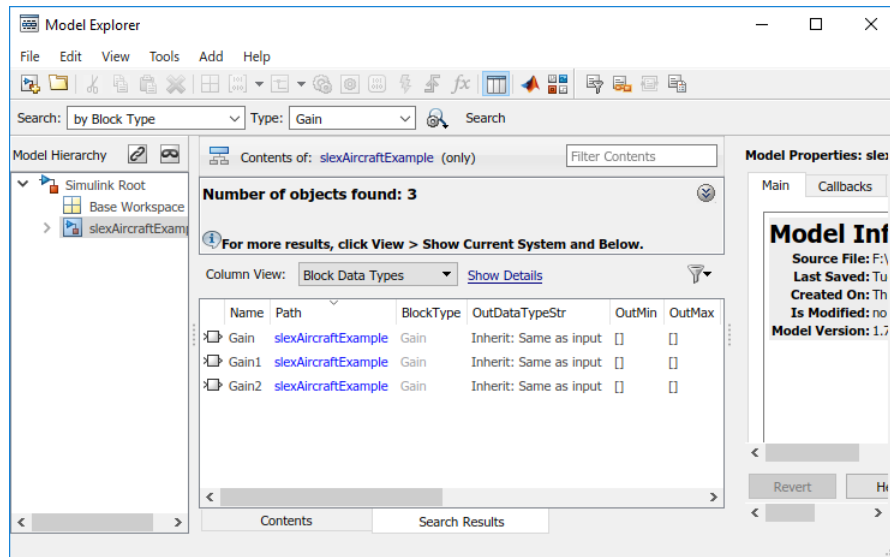

- 2 In the Model Explorer **Contents** pane, select all the Gain blocks whose **Output data type** parameter you want to specify.

Model Explorer highlights the rows corresponding to your selections.

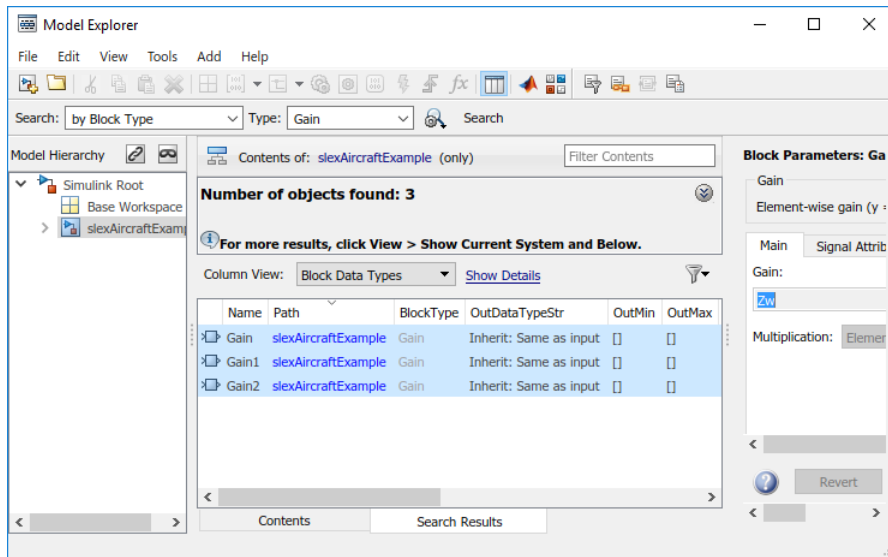

- 3 In the Model Explorer **Contents** pane, click the data type associated with one of the selected Gain blocks.

Model Explorer displays a pull-down menu with valid data type options.

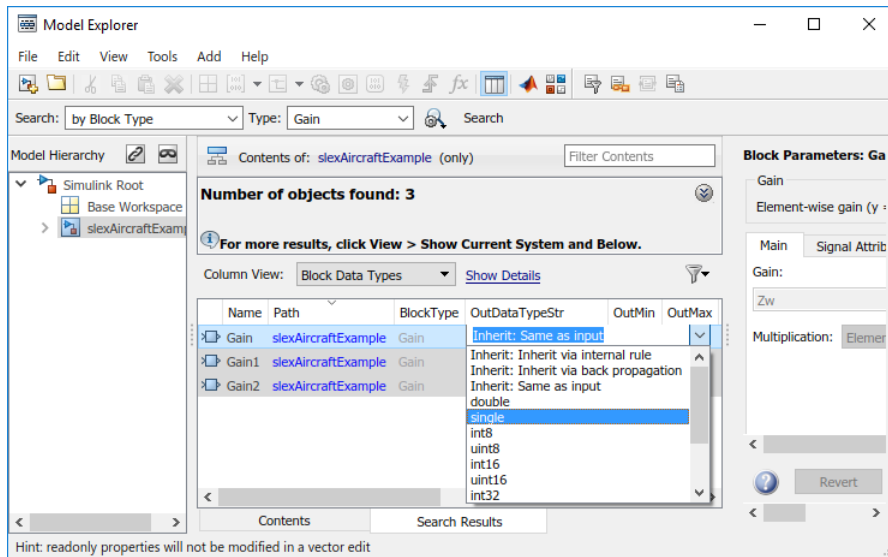

- 4 In the pull-down menu, enter or select the desired data type, for example, `single`.  
Model Explorer specifies the data type of all selected items as `single`.

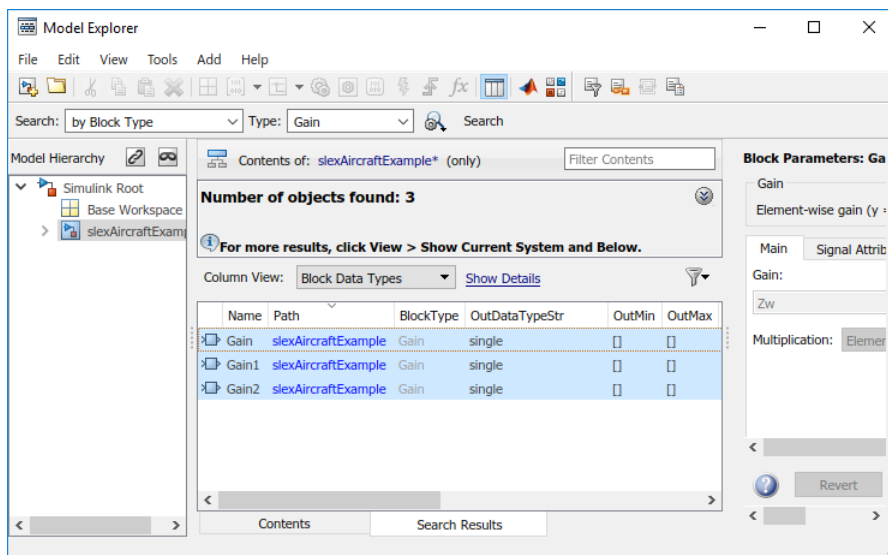

To convert a model to a strict single precision design, see “Validate a Floating-Point Embedded Model” on page 57-20.

## Use the Model Data Editor for Batch Editing of Inport and Outport Blocks

Use the Model Data Editor to design the interface of your model by configuring data types and other attributes of multiple Inport and Outport blocks at once. See “Configure Data Interface for Component” on page 21-15 and “Configure Data Properties by Using a Table” on page 57-123.

## Share a Data Type Between Separate Algorithms, Data Paths, Models, and Bus Elements

In some cases, you cannot rely on data type inheritance (see “Data Type Inheritance Rules” on page 57-10) to establish equivalence between the data types of different data items (such as signal lines or bus elements in a `Simulink.Bus` object). Instead, you can create a `Simulink.NumericType` or `Simulink.AliasType` object in a workspace or data dictionary.

Create a `Simulink.NumericType` object if you do not want to rename the shared data type by creating an alias. Set the `IsAlias` property to `false` (the default).

This example shows how to use a `Simulink.NumericType` object to share an output data type between two lookup table blocks in the same model.

- 1 Open the example model `sldemo_fuelsys`.

```
sldemo_fuelsys
```

The model creates `Simulink.NumericType` objects in the base workspace. One of the objects is named `s16En15`.

- 2 At the command prompt, inspect the properties of `s16En15`.

```
s16En15
```

```
s16En15 =
```

```
    NumericType with properties:
```

```
        DataTypeMode: 'Single'  
        IsAlias: 0
```

```
DataScope: 'Auto'
HeaderFile: ''
Description: ''
```

This object represents the built-in Simulink data type `single`.

- 3 In the model, navigate into the `fuel_rate_control/airflow_calc` subsystem.
- 4 In the Pumping Constant block dialog box, inspect the **Data Types** tab. **Output** is set to `s16En15`.
- 5 In the Ramp Rate Ki block dialog box, inspect the **Data Types** tab. For this block, **Output** is also set to `s16En15`.
- 6 In the model, select **Display > Signals and Ports > Port Data Types**.

The output signals of the two lookup table blocks use the data type `single`.

- 7 At the command prompt, configure `s16En15` to represent the data type `double`.

```
s16En15.DataTypeMode = 'Double';
```

- 8 Update the block diagram.

The output signals of the two lookup table blocks now use the data type `double`. Due to data type inheritance, other signals, such as `e0` and `e1`, acquire the same data type.

Alternatively, to establish data type equivalence between algorithms or data paths in the same model, you can use blocks such as Data Type Propagation and Data Type Conversion Inherited. When you use these blocks, you do not need to create and permanently store a data type object. However, you cannot use the blocks to share a data type between signals in different models unless the models are in the same model reference hierarchy.

## Reuse Custom C Data Types for Signal Data

In a model, you can create signals that conform to custom C data types, such as structures, that your existing C code defines. Use these signals to:

- Replace existing C code with a Simulink model.
- Integrate C code for simulation in Simulink (for example, by using the Legacy Code Tool).
- Prepare to generate code (Simulink Coder) that you can integrate with existing code.

Use these techniques to match your custom data types:

- For a structure type, create a `Simulink.Bus` object. Use the object as the data type for bus signals. See “Data Types for Bus Signals” on page 57-58.
- For an enumeration, create an enumeration class and use it as the data type for signals. See “Use Enumerated Data in Simulink Models” on page 58-7.
- To match a `typedef` statement that represents an alias of a primitive, numeric data type, use a `Simulink.AliasType` object as the data type for signals. See `Simulink.AliasType`.

To create these classes and objects, you can use the function `Simulink.importExternalCTypes`.

## Display Signal Data Types on Block Diagram

To inspect the data types that signals in your model use, in the Simulink Editor, select **Display > Signals & Ports > Port Data Types**. The port data type display is not automatically updated when you change the data type of a diagram element. To refresh the display, press **Ctrl+D**.

Use this technique to:

- Design the data type strategy for a model on a high level.
- Debug numerical issues due to quantization and overflows.
- Make a model more easily understood when sharing it.

For more information, see “Port Data Types” on page 62-60.

## Data Types Remain `double` Despite Changing Settings

If many of the data items (signals, parameters, and states) in your model continue to use the data type `double` after you configure block parameters such as **Output data type**, confirm that the model is not configured to override data types. See “Control Data Type Override” on page 57-40.

### See Also

`Simulink.AliasType` | `Simulink.Bus` | `Simulink.NumericType`



## Related Examples

- “Data Typing Filter”
- “Validate a Floating-Point Embedded Model” on page 57-20
- “Specify Fixed-Point Data Types” on page 57-42
- “Specify Data Types Using Data Type Assistant” on page 57-45
- “About Data Types in Simulink” on page 57-3
- “Data Types Supported by Simulink” on page 57-6
- “Data Types for Bus Signals” on page 57-58

## Validate a Floating-Point Embedded Model

You can use data type override mode to temporarily switch the data types in your model. This capability allows you to maintain one model but simulate your model using multiple data types, and validate the numerical behavior for each type. For example, if you implement an algorithm using double-precision data types and want to check whether the algorithm is also suitable for single-precision use, you can apply a data type override to floating-point data types to replace all doubles with singles without permanently affecting any other data types in your model.

### Apply a Data Type Override to Floating-Point Data Types

To apply data type override, you must specify the data type that you want to apply and the data type that you want to replace.

You can set data type override using one of the following methods. In these examples, both methods change all floating-point data types to single.

#### From the Command Line

For example:

```
set_param(gcs, 'DataTypeOverride', 'Single', 'DataTypeOverrideAppliesTo', 'Floating-point')
```

#### Using the Fixed-Point Tool

For example:

- 1 In the Simulink Editor, select **Analysis > Data Type Design > Fixed-Point Tool**.

The Fixed-Point Tool opens.

- 2 On the **Workflow** tab, under **Configure model settings**, click **Advanced settings**. This opens the Advanced settings dialog.
- 3 In the Advanced settings dialog, under **Subsystem settings**:
  - a Set **Data type override** to **Single**.
  - b Set **Data type override applies to** to **Floating-point**.

For more information on data type override settings, see “Control Data Type Override” on page 57-40.

## Validate a Single-Precision Model

This example uses the `ex_single_validation` model to show how you can use data type override. It proves that an algorithm, which implements double-precision data types, is also suitable for single-precision embedded use.

### About the Model

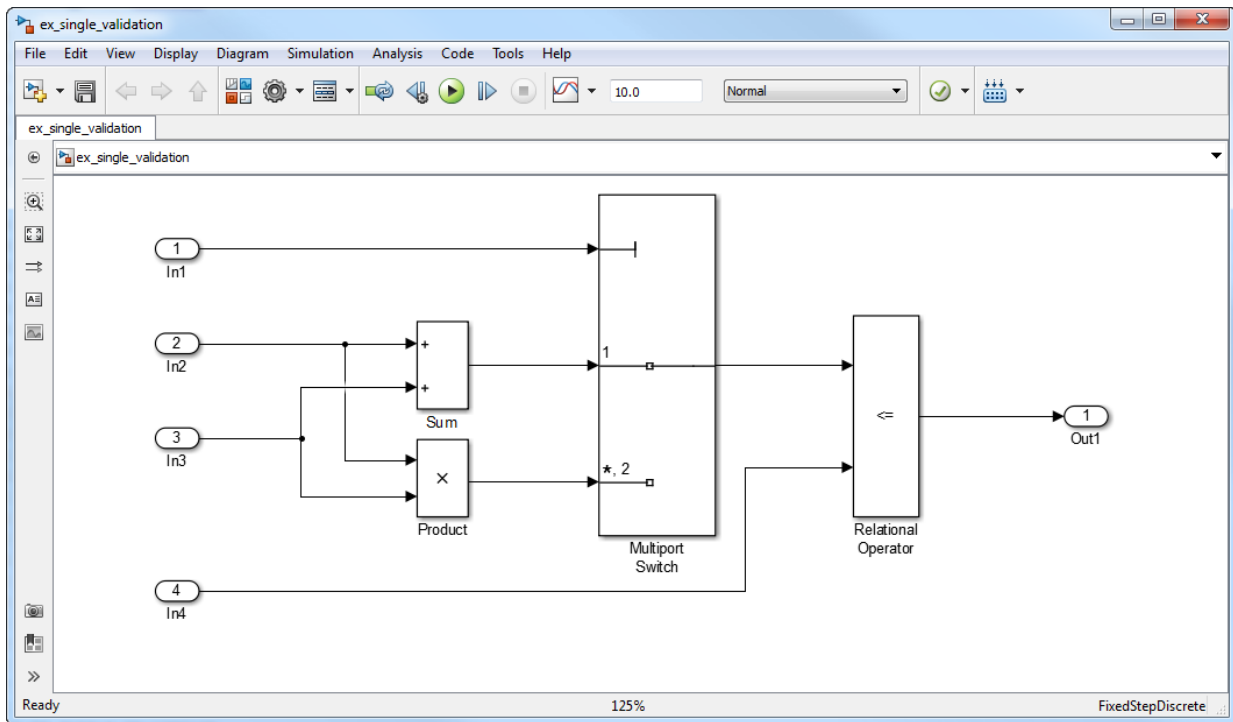

- The inputs `In2` and `In3` are double-precision inputs to the `Sum` and `Product` blocks.
- The outputs of the `Sum` and `Product` blocks are data inputs to the `Multiport Switch` block.
- The input `In1` is the control input to the `Multiport Switch` block. The value of this control input determines which of its other inputs, the sum of `In2` and `In3` or the product of `In2` and `In3`, passes to the output port. Because `In1` is a control input, its data type is `int8`.

- The Relational Operator block compares the output of the Multiport Switch block to In4, and outputs a Boolean signal.

### Run the Example

#### Open the Model

- 1 Open the `ex_single_validation` model. At the MATLAB command line, enter:

```
addpath(fullfile(docroot, 'toolbox', 'simulink', 'examples'))
ex_single_validation
```

#### Override Floating-Point Data Types With Singles

- 1 In the Simulink Editor, select **Analysis > Data Type Design > Fixed-Point Tool**.

The Fixed-Point Tool opens.

- 2 In the Fixed-Point Tool right pane, under **Settings for selected system**, click **Advanced settings**.

- a Set **Data type override** to Single.
- b Set **Data type override applies to Floating-point**.
- c Click **Apply**.

- 3 In the model menu, select **Simulation > Update Diagram**.

The data type override replaces all the floating-point (`double`) data types in the model with `single` data types, but does not affect the integer or Boolean data types.

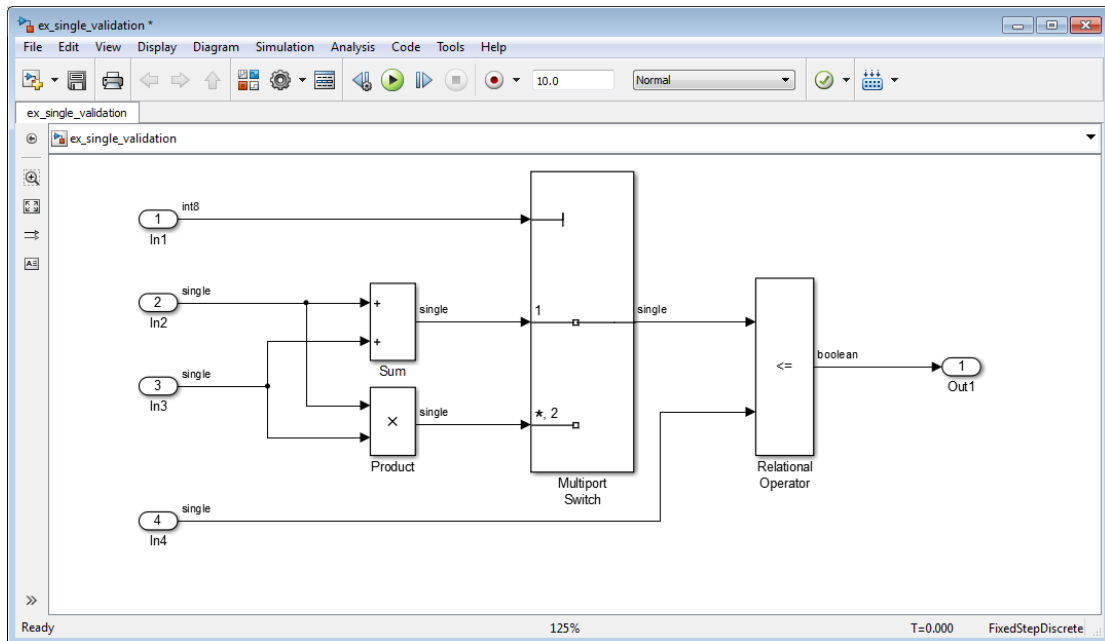

### Run Model Advisor Check

- 1 From the model menu, select **Analysis > Model Advisor > Model Advisor**.
- 2 In the System Selector dialog box, click **OK**.

The Model Advisor opens.

- 3 In the Model Advisor, expand the **By Task** node and, under **Modeling Single-Precision Systems**, select the **Identify questionable operations for strict single-precision design** check.
- 4 In the right pane, click **Run This Check**.

The check passes indicating that this algorithm is suitable for single-precision use. To ensure that no double-precision data types remain in the generated code, use the Single-Precision Converter before generating code for single-precision embedded use. For more information, see “Getting Started with Single Precision Converter” (Fixed-Point Designer).

## Blocks That Support Single Precision

To identify Simulink blocks that support single precision, at the command prompt, enter `showblockdatatypetable`. In a model, to find blocks that do not support single precision, use the Model Advisor check “Identify questionable operations for strict single-precision design”.

### See Also

`Simulink.AliasType` | `Simulink.NumericType`

### Related Examples

- “Single-Precision Design for Simulink” (Fixed-Point Designer)
- “Specify Single-Precision Data Type for Embedded Application” (Simulink Coder)
- “Control Signal Data Types” on page 57-8
- “Default for underspecified data type”
- “Identify questionable operations for strict single-precision design”
- “Inf or NaN block output”
- “About Data Types in Simulink” on page 57-3

## Fixed-Point Numbers

### In this section...

“Binary Point Interpretation” on page 57-26

“Signed Fixed-Point Numbers” on page 57-27

In digital hardware, numbers are stored in binary words. A binary word is a fixed-length sequence of binary digits (1's and 0's). The way in which hardware components or software functions interpret this sequence of 1's and 0's is described by a data type. There are several distinct differences between fixed-point data types and the built-in integer types in MATLAB®. The most notable difference, is that the built-in integer data types can only represent whole numbers, while the fixed-point data types also contain information on the position of the binary point, or the scaling of the number.

Binary numbers are represented as either fixed-point or floating-point data types. A fixed-point data type is characterized by the word size in bits, the binary point, and whether it is signed or unsigned. The position of the binary point is the means by which fixed-point values are scaled and interpreted. With Fixed-Point Designer, fixed-point data types can be integers, fractionals, or generalized fixed-point numbers. The main difference between these data types is their default binary point. For example, a binary representation of a generalized fixed-point number (either signed or unsigned) is shown below:

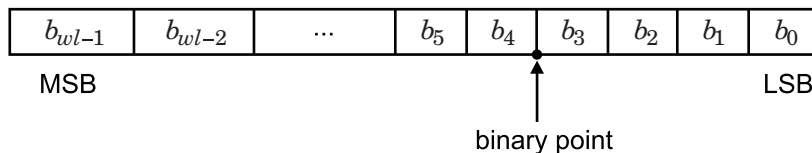

where

- $b_i$  is the  $i^{\text{th}}$  binary digit.
- $wl$  is the word length in bits.
- $b_{wl-1}$  is the location of the most significant, or highest, bit (MSB).
- $b_0$  is the location of the least significant, or lowest, bit (LSB).
- The binary point is shown four places to the left of the LSB. In this example, therefore, the number is said to have four fractional bits, or a fraction length of four.

## Binary Point Interpretation

The binary point is the means by which fixed-point numbers are scaled. It is usually the software that determines the binary point. When performing basic math functions such as addition or subtraction, the hardware uses the same logic circuits regardless of the value of the scale factor. In essence, the logic circuits have no knowledge of a scale factor. They are performing signed or unsigned fixed-point binary algebra as if the binary point is to the right of  $b_0$ .

Fixed-Point Designer supports the general binary point scaling  $V=Q*2^E$ .  $V$  is the real-world value,  $Q$  is the stored integer value, and  $E$  is equal to `-FractionLength`. In other words, `RealWorldValue = StoredInteger * 2 ^ -FractionLength`.

`FractionLength` defines the scaling of the stored integer value. The word length limits the values that the stored integer can take, but it does not limit the values `FractionLength` can take. The software does not restrict the value of exponent  $E$  based on the word length of the stored integer  $Q$ . Because  $E$  is equal to `-FractionLength`, restricting the binary point to being contiguous with the fraction is unnecessary; the fraction length can be negative or greater than the word length.

For example, a word consisting of three unsigned bits is usually represented in scientific notation in one of the following ways.

$$bbb. = bbb. \times 2^0$$

$$bb.b = bbb. \times 2^{-1}$$

$$b.bb = bbb. \times 2^{-2}$$

$$.bbb = bbb. \times 2^{-3}$$

If the exponent were greater than 0 or less than -3, then the representation would involve lots of zeros.

$$bbb00000. = bbb. \times 2^5$$

$$.bb00. = bbb. \times 2^2$$

$$.00bbb = bbb. \times 2^{-5}$$

$$.00000bbb = bbb. \times 2^{-8}$$



These extra zeros never change to ones, however, so they don't show up in the hardware. Furthermore, unlike floating-point exponents, a fixed-point exponent never shows up in the hardware, so fixed-point exponents are not limited by a finite number of bits.

Consider a signed value with a word length of 8, a fraction length of 10, and a stored integer value of 5 (binary value 00000101). The real-world value is calculated using the formula

$\text{RealWorldValue} = \text{StoredInteger} * 2^{-\text{FractionLength}}$ . In this case,  $\text{RealWorldValue} = 5 * 2^{-10} = 0.0048828125$ . Because the fraction length is 2 bits longer than the word length, the binary value of the stored integer is  $x.xx00000101$ , where  $x$  is a placeholder for implicit zeros.  $0.0000000101$  (binary) is equivalent to  $0.0048828125$  (decimal). For an example using a `fi` object, see “Create a `fi` Object With Fraction Length Greater Than Word Length” (Fixed-Point Designer).

## Signed Fixed-Point Numbers

Computer hardware typically represents the negation of a binary fixed-point number in three different ways: sign/magnitude, one's complement, and two's complement. Two's complement is the preferred representation of signed fixed-point numbers and is the only representation used by Fixed-Point Designer.

Negation using two's complement consists of a bit inversion (translation into one's complement) followed by the addition of a one. For example, the two's complement of 000101 is 111011.

Whether a fixed-point value is signed or unsigned is usually not encoded explicitly within the binary word; that is, there is no sign bit. Instead, the sign information is implicitly defined within the computer architecture.

## More About

- “Scaling, Precision, and Range” on page 57-30

## Benefits of Using Fixed-Point Hardware

Digital hardware is becoming the primary means by which control systems and signal processing filters are implemented. Digital hardware can be classified as either off-the-shelf hardware (for example, microcontrollers, microprocessors, general-purpose processors, and digital signal processors) or custom hardware. Within these two types of hardware, there are many architecture designs. These designs range from systems with a single instruction, single data stream processing unit to systems with multiple instruction, multiple data stream processing units.

Within digital hardware, numbers are represented as either fixed-point or floating-point data types. For both of these data types, word sizes are fixed at a set number of bits. However, the dynamic range of fixed-point values is much less than floating-point values with equivalent word sizes. Therefore, in order to avoid overflow or unreasonable quantization errors, fixed-point values must be scaled. Since floating-point processors can greatly simplify the real-time implementation of a control law or digital filter, and floating-point numbers can effectively approximate real-world numbers, then why use a microcontroller or processor with fixed-point hardware support?

- **Size and Power Consumption** — The logic circuits of fixed-point hardware are much less complicated than those of floating-point hardware. This means that the fixed-point chip size is smaller with less power consumption when compared with floating-point hardware. For example, consider a portable telephone where one of the product design goals is to make it as portable (small and light) as possible. If one of today's high-end floating-point, general-purpose processors is used, a large heat sink and battery would also be needed, resulting in a costly, large, and heavy portable phone.
- **Memory Usage and Speed** — In general fixed-point calculations require less memory and less processor time to perform.
- **Cost** — Fixed-point hardware is more cost effective where price/cost is an important consideration. When digital hardware is used in a product, especially mass-produced products, fixed-point hardware costs much less than floating-point hardware and can result in significant savings.

After making the decision to use fixed-point hardware, the next step is to choose a method for implementing the dynamic system (for example, control system or digital filter). Floating-point software emulation libraries are generally ruled out because of timing or memory size constraints. Therefore, you are left with fixed-point math where binary integer values are scaled.

## **More About**

- “Fixed-Point Numbers” on page 57-25

## Scaling, Precision, and Range

**In this section...**

“Scaling” on page 57-30

“Precision” on page 57-31

“Range” on page 57-31

The dynamic range of fixed-point values is less than floating-point values with equivalent word sizes. To avoid overflow and minimize quantization errors, fixed-point numbers must be scaled.

### Scaling

With Fixed-Point Designer, you can select a fixed-point data type whose scaling is defined by its binary point, or you can select an arbitrary linear scaling that suits your needs.

#### Slope and Bias Scaling

You can represent a fixed-point number by a general slope and bias encoding scheme. The real world value of a slope bias scaled number can be represented by:

$$\text{real-world value} = (\text{slope} \times \text{integer}) + \text{bias}$$

$$\text{slope} = \text{slope adjustment factor} \times 2^{\text{fixed exponent}}$$

The slope and bias together represent the scaling of the fixed-point number. In a number with zero bias, only the slope affects the scaling. A fixed-point number that is only scaled by binary point position is equivalent to a number in slope bias representation that has a bias equal to zero and a slope adjustment factor equal to one. This is referred to as binary point-only scaling or power-of-two scaling.

#### Binary-Point-Only Scaling

Binary-point-only or power-of-two scaling involves moving the binary point within the fixed-point word. The advantage of this scaling mode is to minimize the number of processor arithmetic operations. The real world value of a binary-point only scaled number can be represented by:

$$\text{real world value} = 2^{-\text{fraction length}} \times \text{integer}$$

## Precision

The precision of a fixed-point number is the difference between successive values representable by its data type and scaling, which is equal to the value of its least significant bit. The value of the least significant bit, and therefore the precision of the number, is determined by the number of fractional bits. A fixed-point value can be represented to within half of the precision of its data type and scaling.

For example, a fixed-point representation with four bits to the right of the binary point has a precision of  $2^{-4}$  or 0.0625, which is the value of its least significant bit. Any number within the range of this data type and scaling can be represented to within  $(2^{-4})/2$  or 0.03125, which is half the precision.

## Rounding Methods

When you represent numbers with finite precision, not every number in the available range can be represented exactly. If a number cannot be represented exactly by the specified data type and scaling, a rounding method is used to cast the value to a representable number. Although precision is always lost in the rounding operation, the cost of the operation and the amount of bias that is introduced depends on the rounding method itself. For more information on the rounding methods available with Fixed-Point Designer, see “Rounding Methods” (Fixed-Point Designer)

## Range

Range is the span of numbers that a fixed-point data type and scaling can represent. The range of representable numbers for an unsigned two’s complement fixed-point number of word length  $ws$ , scaling  $S$ , and bias  $B$  is illustrated below:

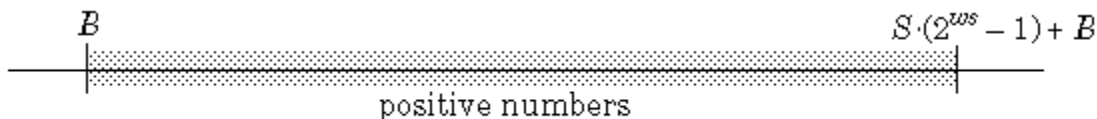

The following figure illustrates the range of representable numbers for a two’s complement signed fixed-point number:



For both signed and unsigned fixed-point numbers of any data type, the number of different bit patterns is  $2^{wl}$ .

For example, in two's complement, negative numbers must be represented as well as zero, so the maximum value is  $2^{wl-1}-1$ . Because there is only one representation for zero, there are an unequal number of positive and negative numbers. This means there is a representation for  $-2^{wl-1}$ , but not for  $2^{wl-1}$ .

### More About

- “Fixed-Point Numbers” on page 57-25
- “Benefits of Using Fixed-Point Hardware” on page 57-28

## Fixed-Point Data in MATLAB and Simulink

### In this section...

“Fixed-Point Data in Simulink” on page 57-33

“Fixed-Point Data in MATLAB” on page 57-35

“Scaled Doubles” on page 57-36

### Fixed-Point Data in Simulink

You can use the `fixdt` function in Simulink to specify a fixed-point data type. The `fixdt` function creates a `Simulink.NumericType` object.

#### Fixed-Point Data Type and Scaling Notation

Simulink data type names must be valid MATLAB identifiers with less than 128 characters. The data type name provides information about container type, number encoding, and scaling.

The following table provides a key for various symbols that appear in Simulink products to indicate the data type and scaling of a fixed-point value.

Symbol	Description	Example
<b>Container Type</b>		
<code>ufix</code>	Unsigned fixed-point data type	<code>ufix8</code> is an 8-bit unsigned fixed-point data type
<code>sfix</code>	Signed fixed-point data type	<code>sfix128</code> is a 128-bit signed fixed-point data type
<code>fltu</code>	Scaled double override of an unsigned fixed-point data type ( <code>ufix</code> )	<code>fltu32</code> is a scaled doubles override of <code>ufix32</code>
<code>flts</code>	Scaled double override of a signed fixed-point data type ( <code>sfix</code> )	<code>flts64</code> is a scaled doubles override of <code>sfix64</code>
<b>Number Encoding</b>		
<code>e</code>	$10^{\wedge}$	<code>125e8</code> equals $125 * (10^{\wedge}(8))$
<code>n</code>	Negative	<code>n31</code> equals -31

Symbol	Description	Example
p	Decimal point	1p5 equals 1.5 p2 equals 0.2
<b>Scaling Encoding</b>		
S	Slope	ufix16_S5_B7 is a 16-bit unsigned fixed-point data type with Slope of 5 and Bias of 7
B	Bias	ufix16_S5_B7 is a 16-bit unsigned fixed-point data type with Slope of 5 and Bias of 7
E	Fixed exponent (2^) A negative fixed exponent describes the fraction length	sfix32_En31 is a 32-bit signed fixed-point data type with a fraction length of 31
F	Slope adjustment factor	ufix16_F1p5_En50 is a 16-bit unsigned fixed-point data type with a SlopeAdjustmentFactor of 1.5 and a FixedExponent of -50
C,c,D, or d	Compressed encoding for Bias  <b>Note:</b> If you pass this character vector to the <code>slDataTypeAndScale</code> function, it returns a valid <code>fixdt</code> data type.	No example available. For backwards compatibility only.  To identify and replace calls to <code>slDataTypeAndScale</code> , use the “Check for calls to <code>slDataTypeAndScale</code> ” Model Advisor check.



Symbol	Description	Example
T or t	Compressed encoding for Slope	No example available. For backwards compatibility only.
	<b>Note:</b> If you pass this character vector to the <code>slDataTypeAndScale</code> , it returns a valid <code>fixdt</code> data type.	To identify and replace calls to <code>slDataTypeAndScale</code> , use the “Check for calls to <code>slDataTypeAndScale</code> ” Model Advisor check.

## Fixed-Point Data in MATLAB

To assign a fixed-point data type to a number or variable in MATLAB, use the `fi` constructor. The resulting fixed-point value is called a `fi` object. For example, the following creates `fi` objects `a` and `b` with attributes shown in the display, all of which we can specify when the variables are constructed. Note that when the `FractionLength` property is not specified, it is set automatically to "best precision" for the given word length, keeping the most-significant bits of the value. When the `WordLength` property is not specified it defaults to 16 bits.

```
a = fi(pi)
```

```
a =
```

```
3.1416015625
```

```
DataTypeMode: Fixed-point: binary point scaling
Signedness: Signed
WordLength: 16
FractionLength: 13
```

```
b = fi(0.1)
```

```
b =
```

```
0.0999984741210938
```

```
DataTypeMode: Fixed-point: binary point scaling
Signedness: Signed
WordLength: 16
FractionLength: 18
```

### Read Fixed-Point Data from the Workspace

Use the From Workspace block to read fixed-point data from the MATLAB workspace into a Simulink model. To do this, the data must be in structure format with a `fi` object in the `values` field. In array format, the From Workspace block only accepts real, double-precision data.

### Write Fixed-Point Data to the Workspace

You can write fixed-point output from a model to the MATLAB workspace via the To Workspace block in either array or structure format. Fixed-point data written by a To Workspace block to the workspace in structure format can be read back into a Simulink model in structure format by a From Workspace block.

## Scaled Doubles

Scaled doubles are a hybrid between floating-point and fixed-point numbers. Fixed-Point Designer stores them as doubles with the scaling, sign, and word length information retained. For example, the storage container for a fixed-point data type `sfixed16_E14` is `int16`. The storage container of the equivalent scaled doubles data type, `flts16_E14` is floating-point `double`. Fixed-Point Designer applies the scaling information to the stored floating-point double to obtain the real-world value. Storing the value in a double almost always eliminates overflow and precision issues.

## See Also

### Functions

`fi` | `fimath` | `fixdt` | `Simulink.NumericType`

## Share Fixed-Point Models

You can edit a model containing fixed-point blocks without having Fixed-Point Designer. However, you must have Fixed-Point Designer to:

- Update a Simulink diagram (**Ctrl+D**) containing fixed-point data types
- Run a model containing fixed-point data types
- Generate code from a model containing fixed-point data types
- Log the minimum and maximum values produced by a simulation
- Automatically scale the output of a model

If you do not have Fixed-Point Designer, you can work with a model containing Simulink blocks with fixed-point settings as follows:

- 1 In the Simulink Editor, select **Analysis > Fixed-Point Tool**.

The Fixed-Point Tool opens.

- 2 Under **System under design**, click **Continue**.
- 3 In the Model Hierarchy pane, right-click the system.
  - Set **Fixed-point instrumentation mode** to **Force off**.
  - Set **Data type override** to **Double** or **Single**.
  - Set **Data type override applies to** **All numeric types**.
- 4 If you use **fi** objects or embedded numeric data types in your model, set the **fipref DataTypeOverride** property to **TrueDoubles** or **TrueSingles** (to be consistent with the model-wide data type override setting) and the **DataTypeOverrideAppliesTo** property to **All numeric types**.

For example, at the MATLAB command line, enter:

```
p = fipref('DataTypeOverride', 'TrueDoubles', ...  
         'DataTypeOverrideAppliesTo', 'AllNumericTypes');
```

---

**Note:** If you use **fi** objects or embedded numeric data types in your model or workspace, you might introduce fixed-point data types into your model. You can set **fipref** to prevent the checkout of a Fixed-Point Designer license.

---

## **More About**

- “Control Fixed-Point Instrumentation and Data Type Override” on page 57-39
- “Fixed-Point Data in MATLAB and Simulink” on page 57-33

# Control Fixed-Point Instrumentation and Data Type Override

## In this section...

“Control Instrumentation Settings” on page 57-39

“Control Data Type Override” on page 57-40

The conversion of a model from floating point to fixed point requires configuring fixed-point instrumentation and data type overrides. However, leaving these settings on after the conversion can lead to unexpected results. If you do not have Fixed-Point Designer, you can work with a model containing Simulink blocks with fixed-point settings by turning off fixed-point instrumentation and setting data type override to scaled doubles.

## Control Instrumentation Settings

The fixed-point instrumentation mode controls which objects log minimum, maximum, and overflow data during simulation. Instrumentation is required to collect simulation ranges using the fixed-point tool. These ranges are used to propose data types for the model. When you are not actively converting your model to fixed point, disable the fixed-point instrumentation to restore the maximum simulation speed to your model.

- 1 From the model **Analysis** menu, select **Fixed-Point Tool**.
- 2 Under **System under design**, click **Continue**.
- 3 In the Model Hierarchy pane, the Fixed-Point Tool denotes systems that currently have instrumentation turned on with (mm0), or (o). Right-click the system in the model hierarchy and, under **Fixed-point instrumentation mode**, select the mode you want your model to use.

If you do not have Fixed-Point Designer, select **Force off**.

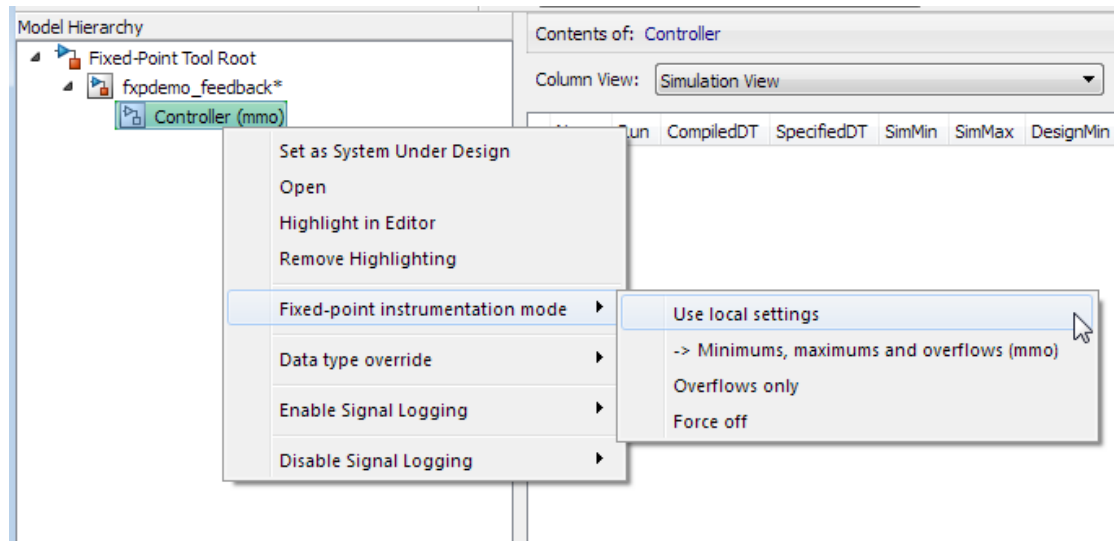

## Control Data Type Override

Use data type override to simulate your model using double, single, or scaled double data types. If you do not have Fixed-Point Designer, you can still configure data type override settings to simulate a model that specifies fixed-point data types. Using this setting, the software temporarily overrides fixed-point data types with floating-point data types during simulation. Turn off data type override to observe the true behavior of your model.

- 1 From the model **Analysis** menu, select **Fixed-Point Tool**.
- 2 Under **System under design**, click **Continue**.
- 3 In the Model Hierarchy pane, the Fixed-Point Tool denotes systems that currently have data type override turned on with (dbl), (sgl), or (sc1). Right-click the system in the Model Hierarchy pane and under **Data type override**, select the mode you want your model to use.

To observe the true behavior of your model, set data type override to **Use local settings** or **Force off**. If you do not have Fixed-Point Designer, and would like to simulate a model that uses fixed-point data types, select **Double** or **Single**.

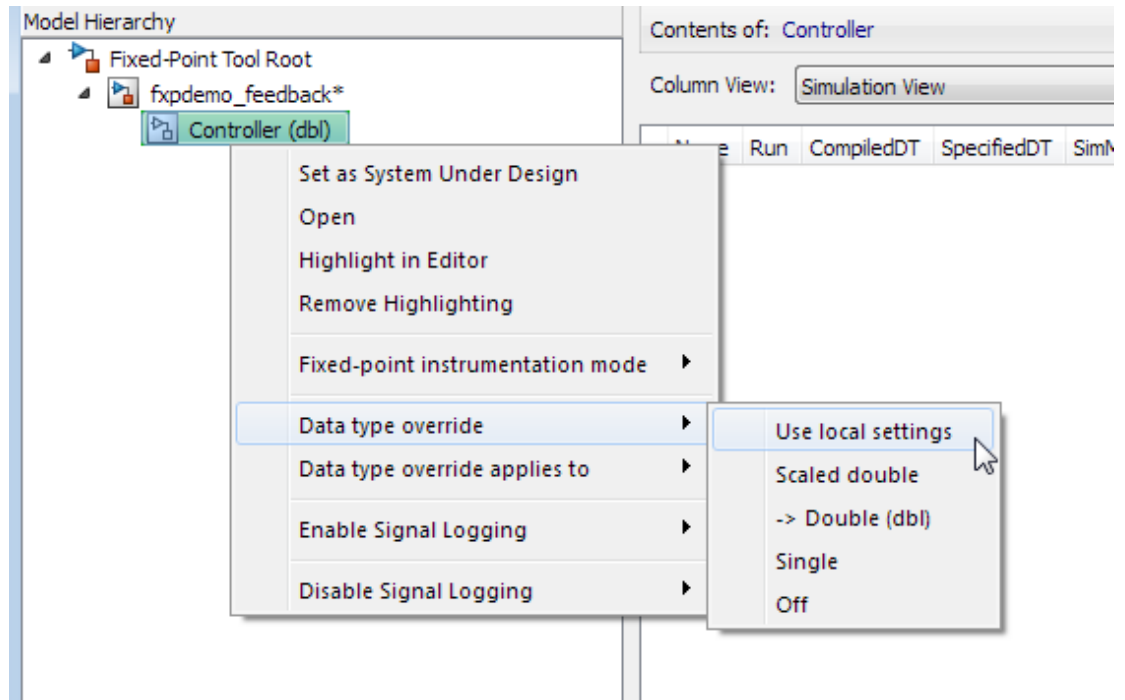

## More About

- “Share Fixed-Point Models” on page 57-37

## Specify Fixed-Point Data Types

Simulink allows you to create models that use fixed-point numbers to represent signals and parameter values. Use of fixed-point data can reduce the memory requirements and increase the speed of code generated from a model.

To execute a model that uses fixed-point numbers, you must have the Fixed-Point Designer product installed on your system. Specifically, you must have the product to:

- Update a Simulink diagram (**Ctrl+D**) containing fixed-point data types
- Run a model containing fixed-point data types
- Generate code from a model containing fixed-point data types
- Log the minimum and maximum values produced by a simulation
- Automatically scale the output of a model using the autoscaling tool

If the Fixed-Point Designer product is not installed on your system, you can execute a fixed-point model as a floating-point model by enabling automatic conversion of fixed-point data to floating-point data during simulation. See “Overriding Fixed-Point Specifications” on page 57-42 for details.

If you do not have the Fixed-Point Designer product installed and do not enable automatic conversion of fixed-point to floating-point data, an error occurs if you try to execute a fixed-point model.

---

**Note:** You do not need the Fixed-Point Designer product to edit a model containing fixed-point blocks, or to use the Data Type Assistant to specify fixed-point data types, as described in “Specifying a Fixed-Point Data Type” on page 57-48.

Fixed-point data types that resolve to a base integer type do not require a Fixed-Point Designer license. For example, a block or signal that specifies a data type of `fixdt(1,8,0)`, which is equivalent to the `int8` built-in type will not check out a Fixed-Point Designer license.

---

## Overriding Fixed-Point Specifications

Most of the functionality in the Fixed-Point Tool is for use with Fixed-Point Designer. However, even if you do not have Fixed-Point Designer, you can configure data type override settings to simulate a model that specifies fixed-point data types. In this mode,



Simulink temporarily overrides fixed-point data types with floating-point data types when simulating the model.

---

**Note:** If you use `fi` (Fixed-Point Designer) objects or embedded numeric data types in your model or workspace, you might introduce fixed-point data types into your model. You can set `fipref` (Fixed-Point Designer) to prevent the checkout of a Fixed-Point Designer license.

---

To simulate a model without using Fixed-Point Designer:

- 1 In the Simulink Editor, select **Analysis > Fixed-Point Tool**.

The Fixed-Point Tool opens.

- 2 Under **System under design**, click **Continue**.
- 3 In the Model Hierarchy pane, right-click the system.
  - Set `Fixed-point instrumentation mode` to `Force off`.
  - Set `Data type override` to `Double` or `Single`.
  - Set `Data type override applies to` to `All numeric types`.
- 4 If you use `fi` objects or embedded numeric data types in your model, set the `fipref` `DataTypeOverride` property to `TrueDoubles` or `TrueSingles` (to be consistent with the model-wide data type override setting) and the `DataTypeOverrideAppliesTo` property to `All numeric types`.

For example, at the MATLAB command line, enter:

```
p = fipref('DataTypeOverride', 'TrueDoubles', ...  
         'DataTypeOverrideAppliesTo', 'AllNumericTypes');
```

## See Also

`fixdt` | `Simulink.NumericType`

## Related Examples

- “Control Signal Data Types” on page 57-8
- “Specify Data Types Using Data Type Assistant” on page 57-45
- “About Data Types in Simulink” on page 57-3



- “Data Types Supported by Simulink” on page 57-6

## Specify Data Types Using Data Type Assistant

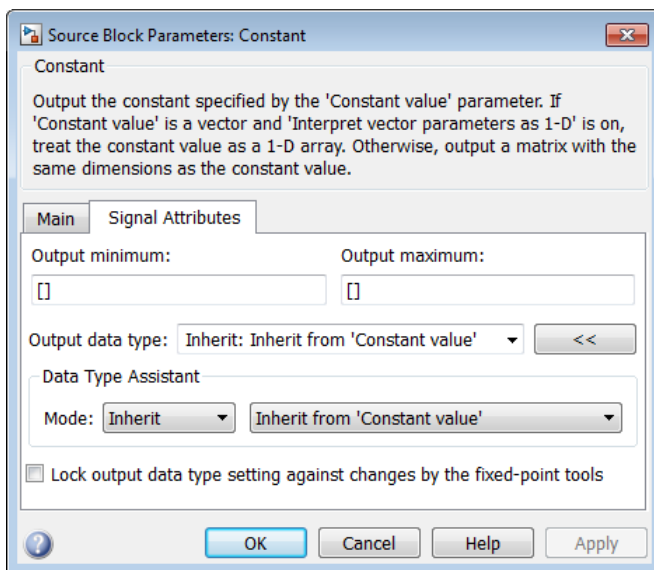
The **Data Type Assistant** is an interactive graphical tool that simplifies the task of specifying data types for blocks and data objects. The assistant appears on block and object dialog boxes, adjacent to parameters that provide data type control, such as the **Output data type** parameter. For example, it appears on the **Signal Attributes** pane of the Constant block dialog box shown here.



You can selectively show or hide the **Data Type Assistant** by clicking the applicable button:

- Click the **Show data type assistant** button  to display the assistant.
- Click the **Hide data type assistant** button  to hide a visible assistant.

Use the **Data Type Assistant** to specify a data type as follows:

- 1 In the **Mode** field, select the category of data type that you want to specify. In general, the options include the following:

Mode	Description
Inherit	Inheritance rules for data types
Built in	Built-in data types
Fixed point	Fixed-point data types
Enumerated	Enumerated data types
Bus object	Bus object data types
Expression	Expressions that evaluate to data types

The assistant changes dynamically to display different options that correspond to the selected mode. For example, setting **Mode** to **Expression** causes the Constant block dialog box to appear as follows.

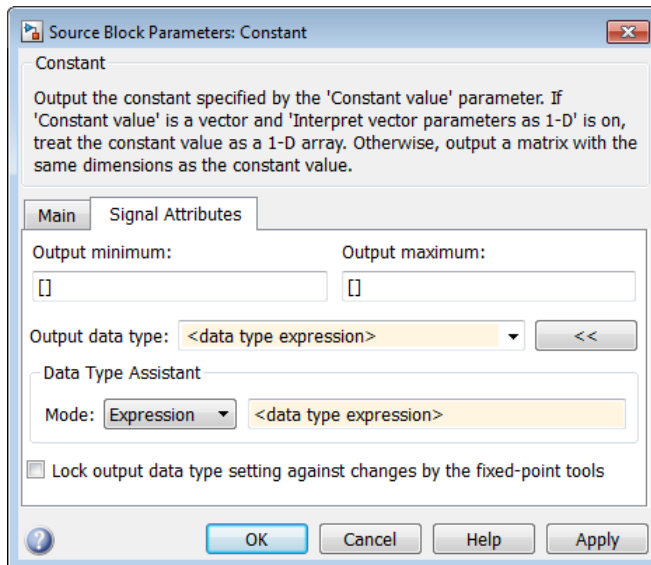

- 2 In the field that is to the right of the **Mode** field, select or enter a data type.

For example, suppose that you designate the variable `myDataType` as an alias for a single data type. You create an instance of the `Simulink.AliasType` class and set its `BaseType` property by entering the following commands:

```
myDataType = Simulink.AliasType
```

```
myDataType.BaseType = 'single'
```

You can use this data type object to specify the output data type of a Constant block. Enter the data type alias name, `myDataType`, as the value of the expression in the assistant.

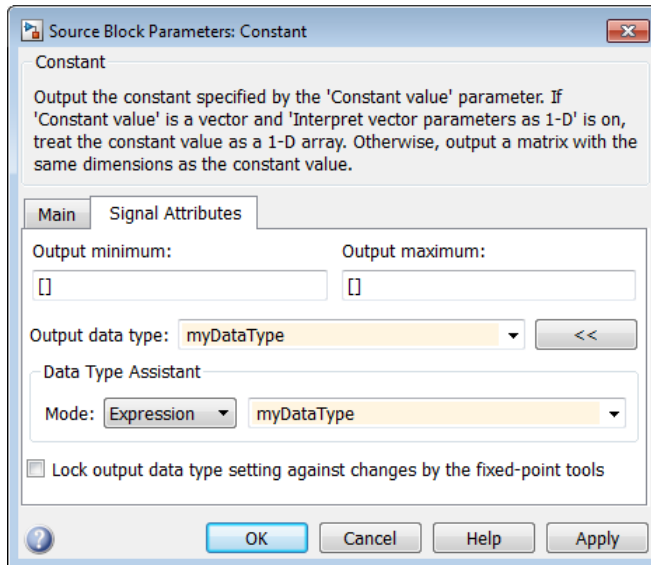

- 3 Click the **OK** or **Apply** button to apply your changes.

The assistant uses the data type that you specified to populate the associated data type parameter in the block or object dialog box. In the following example, the **Output data type** parameter of the Constant block specifies the same expression that you entered using the assistant.

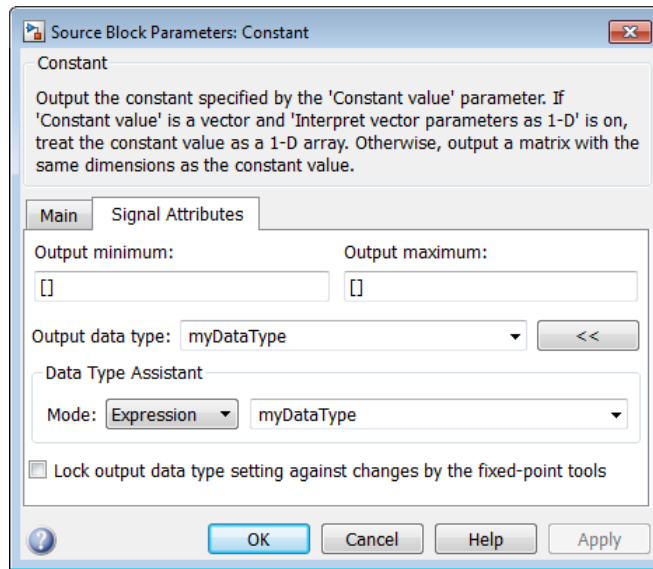

For more information about the data types that you can specify using the **Data Type Assistant**, see “Entering Valid Data Type Values” on page 57-9. For details about specifying fixed-point data types, see “Specify Fixed-Point Data Types with the Data Type Assistant” (Fixed-Point Designer).

## Specifying a Fixed-Point Data Type

When the Data Type Assistant **Mode** is **Fixed point**, the Data Type Assistant displays fields for specifying information about your fixed-point data type. For a detailed discussion about fixed-point data, see “Fixed-Point Basics in MATLAB” (Fixed-Point Designer). For example, the next figure shows the Block Parameters dialog box for a Gain block, with the **Signal Attributes** tab selected and a fixed-point data type specified.

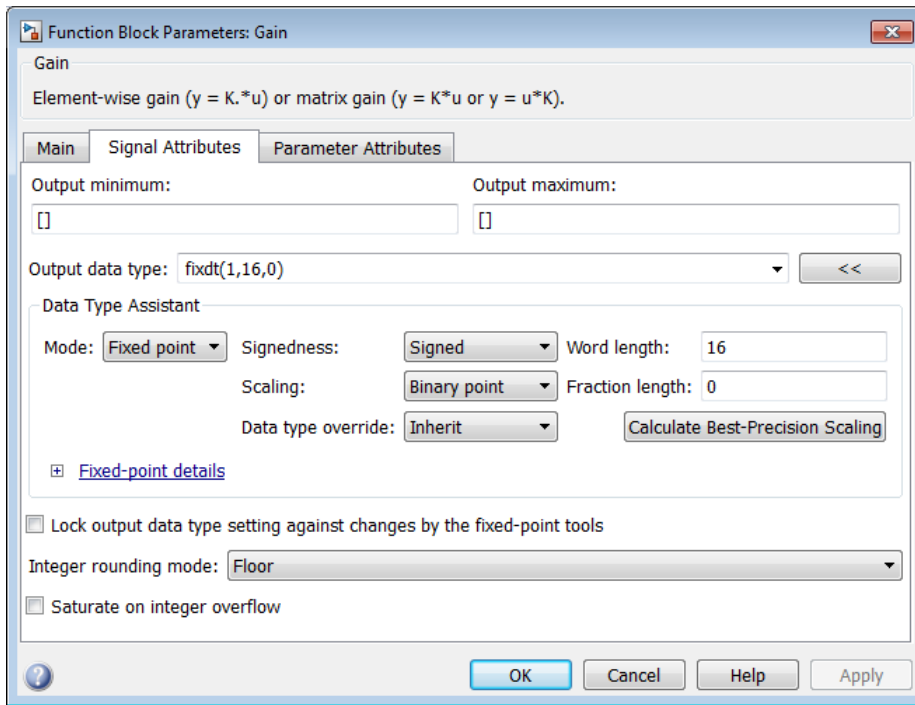

If the **Scaling** is **Slope** and **bias** rather than **Binary point**, the **Data Type Assistant** displays a **Slope** field and a **Bias** field rather than a **Fraction length** field:

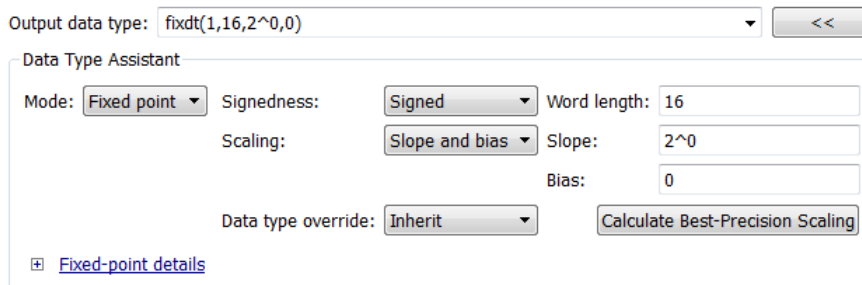

You can use the **Data Type Assistant** to set these fixed-point properties:

### Signedness

Specify whether you want the fixed-point data to be **Signed** or **Unsigned**. Signed data can represent positive and negative values, but unsigned data represents positive values only. The default setting is **Signed**.

### Word length

Specify the bit size of the word that will hold the quantized integer. Large word sizes represent large values with greater precision than small word sizes. Word length can be any integer between 0 and 32. The default bit size is 16.

### Scaling

Specify the method for scaling your fixed-point data to avoid overflow conditions and minimize quantization errors. The default method is **Binary point** scaling. You can select one of two scaling modes:

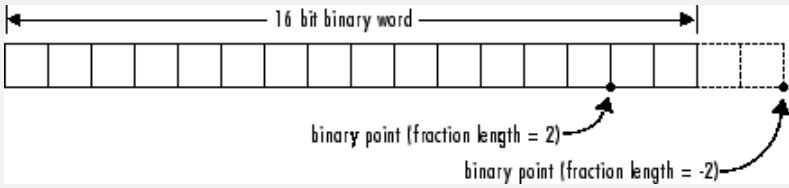
Scaling Mode	Description
<b>Binary point</b>	<p>If you select this mode, the Data Type Assistant displays the <b>Fraction Length</b> field, which specifies the binary point location.</p> <p>Binary points can be positive or negative integers. A positive integer moves the binary point left of the rightmost bit by that amount. For example, an entry of 2 sets the binary point in front of the second bit from the right. A negative integer moves the binary point further right of the rightmost bit by that amount, as in this example:</p>  <p>The default binary point is 0.</p>
<b>Slope and bias</b>	<p>If you select this mode, the Data Type Assistant displays fields for entering the <b>Slope</b> and <b>Bias</b>.</p> <p>Slope can be any positive real number, and the default slope is 1.0. Bias can be any real number, and the default bias is 0.0. You can enter</p>



Scaling Mode	Description
	slope and bias as expressions that contain parameters you define in the MATLAB workspace.

**Note** Use binary-point scaling whenever possible to simplify the implementation of fixed-point data in generated code. Operations with fixed-point data using binary-point scaling are performed with simple bit shifts and eliminate expensive code implementations, which are required for separate slope and bias values.

For more information about fixed-point scaling, see “Scaling” (Fixed-Point Designer).

### Data type override

When the **Mode** is **Built in** or **Fixed point**, you can use the **Data type override** option to specify whether you want this data type to inherit or ignore the data type override setting specified for its context, that is, for the block, `Simulink.Signal` object or Stateflow chart in Simulink that is using the signal. The default behavior is **Inherit**.

Data Type Override Mode	Description
Inherit (default)	Inherits the data type override setting from its context, that is, from the block, <code>Simulink.Signal</code> object or Stateflow chart in Simulink that is using the signal.
Off	Ignores the data type override setting of its context and uses the fixed-point data type specified for the signal.

The ability to turn off data type override for an individual data type provides greater control over the data types in your model when you apply data type override. For example, you can use this option to ensure that data types meet the requirements of downstream blocks regardless of the data type override setting.

### Calculate Best-Precision Scaling

Click this button to calculate best-precision values for both **Binary point** and **Slope and bias** scaling, based on the specified minimum and maximum values. Simulink displays the scaling values in the **Fraction Length** field or the **Slope** and **Bias** fields. For more information, see “Constant Scaling for Best Precision” (Fixed-Point Designer).

## Showing Fixed-Point Details

When you specify a fixed-point data type, you can use the **Fixed-point details** subpane to see information about the fixed-point data type that is currently displayed in the Data Type Assistant. To see the subpane, click the expander next to **Fixed-point details** in the Data Type Assistant. The **Fixed-point details** subpane appears at the bottom of the Data Type Assistant:

Output minimum:  Output maximum:

Output data type:  <<

Data Type Assistant

Mode:  Signedness:  Word length:

Scaling:  Slope:

Bias:

Data type override:

[Fixed-point details](#)

Representable maximum:	32767
Output maximum:	<input type="text" value="[]"/>
Constant value:	90
Output minimum:	<input type="text" value="[]"/>
Representable minimum:	-32768

Precision:

The rows labeled **Output minimum** and **Output maximum** show the same values that appear in the corresponding **Output minimum** and **Output maximum** fields above the Data Type Assistant. The names of these fields may differ from those shown. For example, a fixed-point block parameter would show **Parameter minimum** and **Parameter maximum**, and the corresponding **Fixed-point details** rows would be labeled accordingly. See “Signal Ranges” on page 62-41 and “Specify Minimum and Maximum Values for Block Parameters” on page 35-66 for more information.

The rows labeled **Representable minimum**, **Representable maximum**, and **Precision** always appear. These rows show the minimum value, maximum value, and precision that can be represented by the fixed-point data type currently displayed in the Data Type Assistant. For information about these three quantities, see “Fixed-Point Basics in MATLAB” (Fixed-Point Designer).

The values displayed by the **Fixed-point details** subpane *do not* automatically update if you click **Calculate Best-Precision Scaling**, or change the range limits, the values that define the fixed-point data type, or anything elsewhere in the model. To update the values shown in the **Fixed-point details** subpane, click **Refresh Details**. The Data Type Assistant then updates or recalculates all values and displays the results.

Clicking **Refresh Details** does not change anything in the model, it only changes the display. Click **OK** or **Apply** to put the displayed values into effect. If the value of a field cannot be known without first compiling the model, the **Fixed-point details** subpane shows the value as **Unknown**.

If any errors occur when you click **Refresh Details**, the **Fixed-point details** subpane shows an error flag on the left of the applicable row, and a description of the error on the right. For example, the next figure shows two errors:

Output minimum:  Output maximum:

Output data type:  <<

Data Type Assistant

Mode:  Signedness:  Word length:

Scaling:  Fraction length:

Data type override:

[Fixed-point details](#)

Representable maximum:	32767	
Output maximum:	50000	Outside representable range by 17233 (17233 x precision)
Output minimum:	MySymbol	Cannot evaluate
Representable minimum:	-32768	

Precision:

The row labeled **Output minimum** shows the error **Cannot evaluate** because evaluating the expression **MySymbol**, specified in the **Output minimum** field, did not return an appropriate numeric value. When an expression does not evaluate successfully, the **Fixed-point details** subpane displays the unevaluated expression (truncating to 10 characters if necessary to save space) in place of the unavailable value.

To correct the error in this case, you would need to define **MySymbol** in an accessible workspace to provide an appropriate numeric value. After you clicked **Refresh Details**,

the value of `MySymbol` would appear in place of its unevaluated text, and the error indicator and error description would disappear.

To correct the error shown for **Output maximum**, you would need to decrease **Output maximum**, increase **Word length**, or decrease **Fraction length** (or some combination of these changes) sufficiently to allow the fixed-point data type to represent the maximum value that it could have.

Other values relevant to a particular block can also appear in the **Fixed-point details** subpane. For example, on a Discrete-Time Integrator block **Signal Attributes** tab, the subpane can look like this:

<input type="checkbox"/> <a href="#">Fixed-point details</a>	
Representable maximum:	32767
Output maximum:	<input type="checkbox"/>
Upper saturation limit:	inf
Initial condition:	1 .. 4
Lower saturation limit:	-inf
Output minimum:	<input type="checkbox"/>
Representable minimum:	-32768
Precision:	1

The values displayed for **Upper saturation limit** and **Lower saturation limit** are greyed out. This appearance indicates that the corresponding parameters are not currently used by the block. The greyed-out values can be ignored.

To conserve space, **Initial condition** displays the smallest value and the largest value in the vector or matrix, using ellipsis to represent the other values. The underlying definition of the vector or matrix is unaffected.

### Lock output data type setting against changes by the fixed-point tools

Select this check box to prevent replacement of the current data type with a type that the Fixed-Point Tool or Fixed-Point Advisor chooses. For instructions on autoscaling fixed-point data, see “Scaling” (Fixed-Point Designer).

## Specify an Enumerated Data Type

You can specify an enumerated data type by selecting the **Enum:** `<class name>` option and specify an enumerated object.

In the **Data Type Assistant**, you can use the **Mode** parameter to specify a bus as a data object for a block. Select the **Enumerated** option and specify an enumerated object.

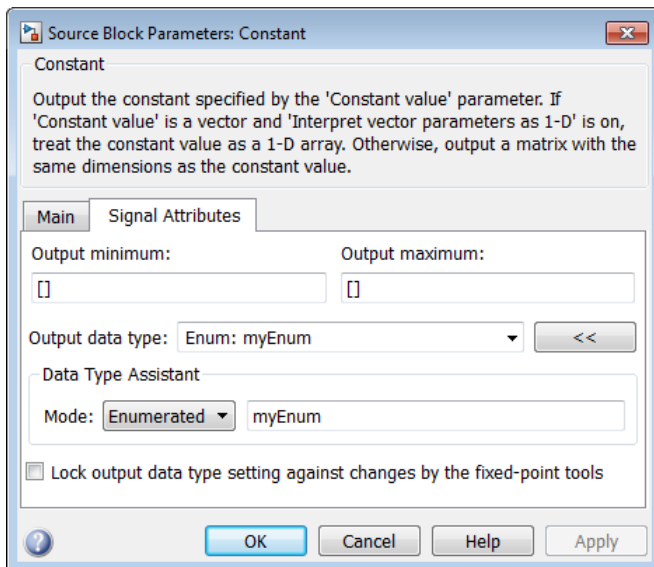

For details about enumerated data types, see “Data Types”.

## Specify a Bus Object Data Type

The blocks listed in the section called “Data Types for Bus Signals” on page 57-58 support your specifying a bus object as a data type. For those blocks, in the **Data type** parameter, select the **Bus:** `<object name>` option and specify a bus object. You cannot use the **Expression** option to specify a bus object as a data type for a block.

In the **Data Type Assistant**, you can use the **Mode** parameter to specify a bus as a data object for a block. Select the **Bus** option and specify a bus object.

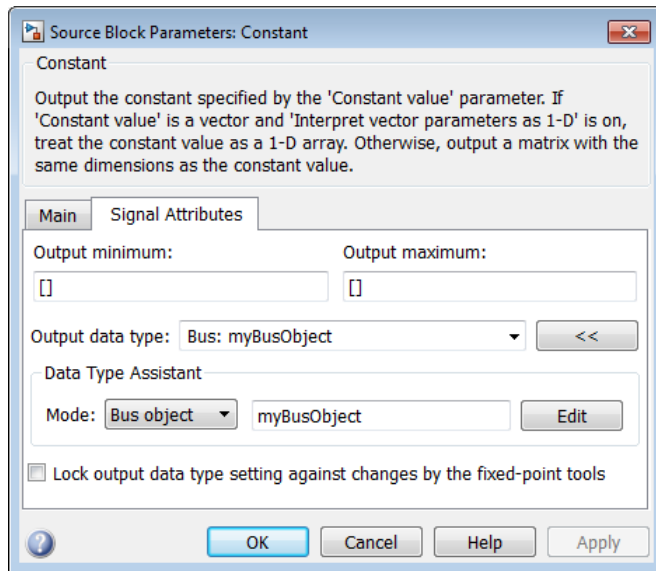

You can specify a bus object as the data type for data objects such as `Simulink.Signal`, `Simulink.Parameter`, and `Simulink.BusElement`. In the Model Explorer, in Properties dialog box for a data object, in the **Data type** parameter, select the **Bus: <object name>** option and specify a bus object. You can also use the **Expression** option to specify a bus object.

For more information on specifying a bus object data type, see “When to Use Bus Objects” on page 63-59.

## See Also

`fixdt` | `Simulink.NumericType`

## Related Examples

- “Control Signal Data Types” on page 57-8
- “Specify Fixed-Point Data Types” on page 57-42
- “Define Simulink Enumerations” on page 58-7
- “About Data Types in Simulink” on page 57-3
- “Data Types Supported by Simulink” on page 57-6

- “Data Types for Bus Signals” on page 57-58

## Data Types for Bus Signals

A bus object (`Simulink.Bus`) specifies the architectural properties of a bus, as distinct from the values of the signals it contains. For example, a bus object can specify the number of elements in a bus, the order of those elements, whether and how elements are nested, and the data types of constituent signals; but not the signal values.

You can specify a bus object as a data type for the following blocks:

- Bus Creator
- Constant
- Data Store Memory
- Inport
- Outport
- Signal Specification

You can specify a bus object as a data type for the following classes:

- `Simulink.BusElement`
- `Simulink.Parameter`
- `Simulink.Signal`

See “Specify a Bus Object Data Type” on page 57-55 for information about how to specify a bus object as a data type for blocks and classes.

### See Also

`Simulink.Bus`

### Related Examples

- “Control Signal Data Types” on page 57-8
- “Specify Data Types Using Data Type Assistant” on page 57-45
- “About Data Types in Simulink” on page 57-3
- “Data Types Supported by Simulink” on page 57-6



## Data Objects

### In this section...

“Data Class Naming Conventions” on page 57-60

“Use Data Objects in Simulink Models” on page 57-60

“Data Object Properties” on page 57-63

“Create Data Objects from Built-In Data Class Package Simulink” on page 57-65

“Create Data Objects from Another Data Class Package” on page 57-66

“Create Data Objects Directly from Dialog Boxes” on page 57-67

“Create Data Objects for a Model Using Data Object Wizard” on page 57-68

“Create Data Objects from External Data Source Programmatically” on page 57-73

“Data Object Methods” on page 57-74

“Handle Versus Value Classes” on page 57-75

“Compare Data Objects” on page 57-77

“Create Persistent Data Objects” on page 57-78

You can create *data objects* to specify values, value ranges, data types, tunability, and other characteristics of signals, states, and block parameters. You use the object names in Simulink dialog boxes to specify signal, state, and parameter characteristics. The objects exist in a workspace such as the base workspace, a model workspace, or a Simulink data dictionary. Data objects allow you to make model-wide changes to signal, state, and parameter characteristics by changing only the values of workspace objects.

You create data objects as instances of data classes. Memory structures called *data class packages* contain the data class definitions. The built-in package `Simulink` defines two data classes, `Simulink.Signal` and `Simulink.Parameter`, that you can use to create data objects. To store lookup table data for sharing between lookup table blocks (such as n-D Lookup Table), you can use the `Simulink.LookupTable` and `Simulink.Breakpoint` classes.

To decide whether to use data objects to configure signals, including Inport and Outport blocks, see “Store Design Attributes of Signals and States” on page 62-6.

You can customize data object properties and methods by defining subclasses of the built-in data classes. For more information about creating a data class package, see “Define Data Classes” on page 57-80.

## Data Class Naming Conventions

Simulink uses dot notation to name data classes:

*package.class*

- *package* is the name of the package that contains the class definition.
- *class* is the name of the class.

This notation allows you to create and reference identically named classes that belong to different packages. In this notation, the name of the package *qualifies* the name of the class.

Class and package names are case sensitive. For example, you cannot use `MYPACKAGE.MYCLASS` and `mypackage.myclass` interchangeably to refer to the same class.

## Use Data Objects in Simulink Models

To specify simulation and code generation options for signals, block parameters, and states by modifying variables in a workspace or data dictionary, use data objects. Associate the objects with signals, parameters, and states in a model diagram.

### Use Parameter Objects

You can use parameter objects, instead of numeric MATLAB variables, to specify values for block parameters. For example, to create and use a `Simulink.Parameter` object to specify the **Gain** parameter of a Gain block:

- 1 Create a parameter object. For example, create an object using the built-in package `Simulink`.

```
myParam = Simulink.Parameter;
```

- 2 Assign a numeric value to the `Value` property.

```
myParam.Value = 15.23;
```

- 3 Specify other characteristics for the block parameter by adjusting the object properties. For example, to specify the minimum and maximum values the parameter can take, use the `Min` and `Max` properties.

```
myParam.Min = 10.11;
myParam.Max = 25.27;
```

- 4 In a block dialog box, specify the value of a parameter as `myParam`. For example, in a Gain block dialog box, specify **Gain** as `myParam`.

During simulation, the **Gain** parameter uses the value `15.23`.

To share lookup table data by using `Simulink.LookupTable` and `Simulink.Breakpoint` objects, see “Package Shared Breakpoint and Table Data for Lookup Tables” on page 35-36.

### Use Signal Objects

You can associate a signal line or block state, such as the state of a Unit Delay block, with a signal object.

#### For Signals

To use a signal object to control the characteristics of a signal in a model, create the object in a workspace by using the same name as the signal.

- 1 Create a `Simulink.Signal` object. For example, create an object using the built-in package `Simulink`.

```
mySig = Simulink.Signal;
```

- 2 Specify the signal characteristics by adjusting the object properties. For example, to specify the signal data type as `boolean`, use the `DataType` object property.

```
mySig.DataType = 'boolean';
```

- 3 In the Signal Properties dialog box for the signal in the model, specify **Signal name** as `mySig`. Click **Apply**.
- 4 Select the check box next to **Signal name must resolve to Simulink signal object**.

This option forces the model signal to use the properties that the signal object `mySig` defines. To learn how to control the way that signal names resolve to signal objects, see “Symbol Resolution” on page 57-118.

If you do not see the option in the Signal Properties dialog box, set the model configuration parameter **Configuration Parameters > Diagnostics > Data Validity > Signal resolution** to a value other than `None`.

To configure the signal programmatically:

```
% Create the signal object.
mySig = Simulink.Signal;
mySig.DataType = 'boolean';

% Get a handle to the block port that creates the
% target signal.
portHandles = get_param('myModel/myBlock','portHandles');
outportHandle = portHandles.Outport;

% Specify the programmatic port parameter 'Name'.
set_param(outportHandle,'Name','mySig')

% Set the port parameter 'MustResolveToSignalObject'.
set_param(outportHandle,'MustResolveToSignalObject','on')
```

You can also use a signal object to control the characteristics of a root-level Outport block. To interactively associate the block with a signal object, you must use the Model Data Editor (see “Configure Data Properties by Using a Table” on page 57-123):

- 1 Set the **Change View** drop-down list to **Code**.
- 2 Apply a name to the Outport block by using the **Signal Name** column.
- 3 Select the box in the **Resolve** column.

To configure the block programmatically:

```
% Create the signal object.
mySig = Simulink.Signal;
mySig.DataType = 'boolean';

% Specify the programmatic block parameter 'SignalName'.
set_param('myModel/myOutport','SignalName','mySig')

% Set the block parameter 'MustResolveToSignalObject'.
set_param('myModel/myOutport','MustResolveToSignalObject','on')
```

#### **For States**

You can use a signal object to control the characteristics of a block state, such as that of the Discrete-Time Integrator block.

- 1 Create a `Simulink.Signal` object. For example, create an object using the built-in package `Simulink`.

```
myState = Simulink.Signal;
```

- 2 Specify the state characteristics by adjusting the object properties. For example, to specify the state data type as `int16`, use the `DataType` object property.

```
myState.DataType = 'int16';
```

- 3 In a block dialog box, on the **State Attributes** tab, specify **State name** as `myState`. Click **Apply**.
- 4 Select the check box next to **State name must resolve to Simulink signal object**.

If you do not see this option on the **State Attributes** tab, set the model configuration parameter **Configuration Parameters > Diagnostics > Data Validity > Signal resolution** to a value other than `None`.

To configure the state programmatically:

```
% Create the signal object.
myState = Simulink.Signal;
myState.DataType = 'int16';

% Set the state name in the block.
set_param('myModel/myBlock', 'StateName', 'myState')

% Set the port parameter 'StateMustResolveToSignalObject'.
set_param('myModel/myBlock', 'StateMustResolveToSignalObject', 'on')
```

## Data Object Properties

To control parameter and signal characteristics using data objects, you specify values for the data object properties. For example, parameter and signal data objects have a `DataType` property that determines the data type of the target block parameter or signal. Data class definitions determine the names, value types, default values, and valid value ranges of data object properties.

You can use either the Model Explorer or MATLAB commands to change a data object's properties.

For a list of signal object properties, see `Simulink.Signal`. For a list of parameter object properties, see `Simulink.Parameter`.

## Use the Model Explorer to Change an Object's Properties

To use the Model Explorer to change an object's properties, select the workspace that contains the object in the Model Explorer's **Model Hierarchy** pane. Then select the object in the Model Explorer's **Contents** pane.

The Model Explorer displays the object's property dialog box in its **Dialog** pane (if the pane is visible).

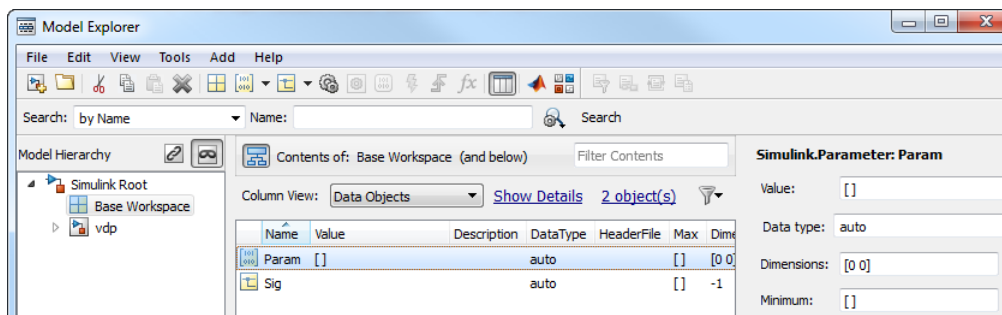

You can configure the Model Explorer to display some or all of the properties of an object in the **Contents** pane (see “Model Explorer: Contents Pane” on page 12-18). To edit a property, click its value in the **Contents** or **Dialog** pane. The value is replaced by a control that allows you to change the value.

## Use MATLAB Commands to Change an Object's Properties

You can also use MATLAB commands to get and set data object properties. Use the following dot notation in MATLAB commands and programs to get and set a data object's properties:

```
value = obj.property;
obj.property = value;
```

where *obj* is a variable that references either the object if it is an instance of a value class or a handle to the object if the object is an instance of a handle class (see “Handle Versus Value Classes” on page 57-75), **PROPERTY** is the property's name, and **VALUE** is the property's value. For example, the following MATLAB code creates a data type alias object (i.e., an instance of `Simulink.AliasType`) and sets its base type to `uint8`:

```
gain = Simulink.AliasType;
```

```
gain.BaseType = 'uint8';
```



You can use dot notation recursively to get and set the properties of objects that are values of other object's properties, e.g.,

```
gain.CoderInfo.StorageClass = 'ExportedGlobal';
```

## Create Data Objects from Built-In Data Class Package Simulink

The built-in package `Simulink` defines two data object classes `Simulink.Parameter` and `Simulink.Signal`. You can create these data objects using the user interface or programmatically.

### Create Data Objects

- 1 In the Model Explorer **Model Hierarchy** pane, select a workspace to contain the data objects. For example, click `Base Workspace`.
- 2 On the toolbar, click the arrow next to Add Parameter  or Add Signal . From the drop-down list, select **Simulink Parameter** or **Simulink Signal**.

A parameter or signal object appears in the base workspace. The default name for new parameter objects is `Param`. The default name for new signal objects is `Sig`.

- 3 To create more objects, click Add Parameter or Add Signal.

To create `Simulink.LookupTable` and `Simulink.Breakpoint` objects, on the Model Explorer toolbar, select **Add > Add Custom**.

### Programmatically Create Data Objects

```
% Create a Simulink.Parameter object named myParam whose value is 15.23.
myParam = Simulink.Parameter(15.23);
```

```
% Create a Simulink.Signal object named mySig.
mySig = Simulink.Signal;
```

### Convert Numeric Variable into Parameter Object

You can convert a numeric variable into a `Simulink.Parameter` object as follows.

```
/* Define numeric variable in base workspace
myVar = 5;
```



```
/* Create data object and assign variable value  
myObject = Simulink.Parameter(myVar);
```

## Create Data Objects from Another Data Class Package

You can create your own package to define custom data object classes that subclass `Simulink.Parameter` and `Simulink.Signal`. You can use this technique to add your own properties and methods to data objects. If you have an Embedded Coder license, you can define custom storage classes and memory sections in the package. For more information about creating a data class package, see “Define Data Classes” on page 57-80.

### Create Data Objects from Another Package

Suppose that you define a data class package called `myPackage`. Before you can create data objects from the package, you must include the package folder on your MATLAB path.

- 1 In the Model Explorer **Model Hierarchy** pane, select a workspace to contain the data objects. For example, click **Base Workspace**.
- 2 Click the arrow next to Add Parameter  or Add Signal  and select **Customize class lists**.
- 3 In the dialog box, select the check box next to the class that you want. For example, select the check boxes next to `myPackage.Parameter` and `myPackage.Signal`. Click **OK**.
- 4 Click the arrow next to Add Parameter or Add Signal. Select the class for the data object that you want to create. For example, select **myPackage Parameter** or **myPackage Signal**.

A parameter or signal object appears in the base workspace. The default name for new parameter objects is `Param`. The default name for new signal objects is `Sig`.

- 5 To create more data objects from the package `myPackage`, click Add Parameter or Add Signal again.

### Programmatically Create Data Objects from Another Package

Suppose that you define a data class package called `myPackage`. Before you can create data objects from the package, you must include the package folder on your MATLAB path.



```
% Create a myPackage.Parameter object named  
% myParam whose value is 15.23.  
myParam = myPackage.Parameter(15.23);  
  
% Create a myPackage.Signal object named mySig.  
mySig = myPackage.Signal;
```

## Create Data Objects Directly from Dialog Boxes

When you open a Signal Properties dialog box or a block dialog box, you can efficiently create a signal or parameter data object in a workspace or data dictionary.

### Create Parameter Object from Block Dialog Box

- 1 In a numeric block parameter in the dialog box, specify the name that you want for the data object. For example, specify the name `myParam`.
- 2 Click the button  next to the value of the block parameter. Select **Create Variable**.
- 3 In the **Create New Data** dialog box, specify **Value** as `Simulink.Parameter`.

Alternatively, you can specify the name of a data class that you created, such as `myPackage.Parameter`. You can also use the drop-down list to select from a list of available data object classes.

- 4 Specify **Location** as **Base Workspace** and click **Create**.

You can use the **Location** option to select a workspace to contain the new data object. If a model is linked to a data dictionary, you can choose to create a data object in the dictionary.

- 5 In the dialog box that opens, configure the data object properties. Specify a numeric value for the parameter in the **Value** box. Click **OK**.

The parameter object `myParam` appears in the base workspace.

- 6 In the block parameter dialog box, click **OK**.

### Create Signal Object from Signal Properties Dialog Box

- 1 In the **Signal name** box, specify a signal name such as `mySig`. Click **Apply**.
- 2 Click the button  next to the value of **Signal name**. Select **Create Variable**.

- 3 In the **Create New Data** dialog box, specify **Value** as `Simulink.Signal`.

Alternatively, you can specify the name of a data class that you created, such as `myPackage.Signal`. Also, from the drop-down list, you can select a data object class that exists on the MATLAB path.

- 4 Specify **Location** as **Base Workspace** and click **Create**.

You can use the **Location** option to select a workspace to contain the new data object. If a model is linked to a data dictionary, you can choose to create a data object in the dictionary.

- 5 In the dialog box that opens, configure the data object properties and click **OK**.

The signal object `mySig` appears in the base workspace.

- 6 In the Signal Properties dialog box, select the check box next to **Signal name must resolve to Simulink signal object** and click **OK**.

## Create Data Objects for a Model Using Data Object Wizard

To create data objects that represent signals, parameters, and states in a model, you can use the Data Object Wizard. The wizard finds data in the model that do not have corresponding data objects.

Based on specifications in the model, the wizard creates the objects and assigns these characteristics:

- Signal, parameter, or state name.
- Numeric value for parameter objects.
- Data type. For signal objects, includes alias types such as `Sumlink.AliasType` and `Simulink.NumericType`.

- 1 In the Simulink Editor, select **Code > Data Objects > Data Object Wizard**.

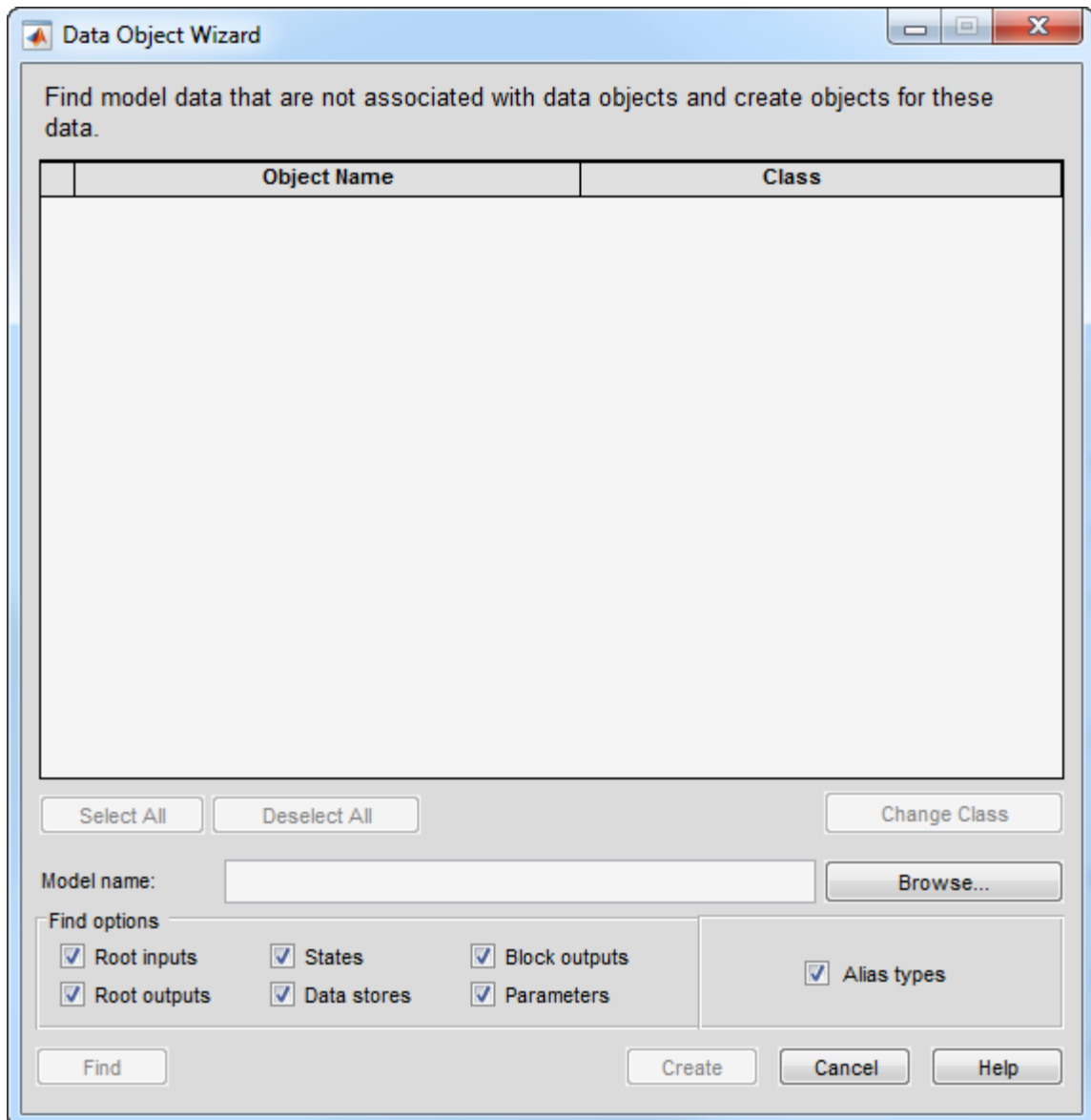

- 2 In the **Model name** box, enter the name of the model that you want to search.

By default, the box contains the name of the model from which you opened the wizard.

- 3 Under **Find options**, select the check boxes next to the data object types that you want to create. The table describes the options.

Option	Description
<b>Root inputs</b>	Named signals from root-level Inport blocks.
<b>Root outputs</b>	Named signals from root-level Outport blocks.
<b>States</b>	States associated with these discrete blocks: Discrete Filter Discrete State-Space Discrete-Time Integrator Discrete Transfer Fcn Discrete Zero-Pole Memory PID Controller PID Controller (2DOF) Unit Delay
<b>Data stores</b>	Data stores. For more information about data stores, see “Local and Global Data Stores” on page 60-3 .
<b>Block outputs</b>	Named signals whose sources are non-root-level blocks.
<b>Parameters</b>	<ul style="list-style-type: none"> <li>• Numeric parameters, for example the parameters in these blocks: Constant Gain Relay</li> <li>• Stateflow data with <b>Scope</b> set to <b>Parameter</b>.</li> </ul> <p>For more information, see “Share Simulink Parameters with Charts” (Stateflow) in the Stateflow documentation.</p>
<b>Alias types</b>	Data type replacement names that you specify in <b>Configuration Parameters &gt; Code Generation &gt; Data Type Replacement</b> . If you have an Embedded Coder license, the Data Object Wizard creates <code>Simulink.AliasType</code> objects for these data type replacement names. For more information about data type

Option	Description
	replacement, see “Data Type Replacement” (Embedded Coder) in the Embedded Coder documentation.

4 Click **Find**.

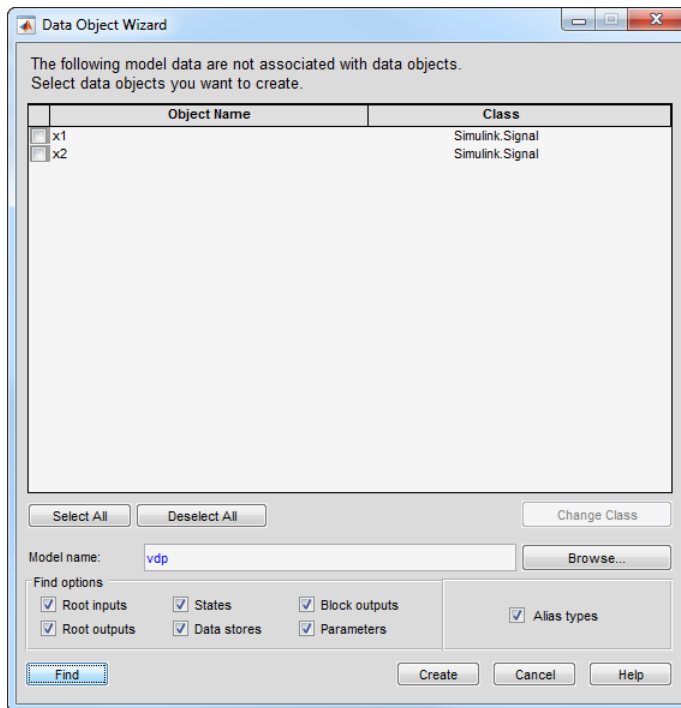

The data object table displays the proposed objects.



5 (Optional) To create objects from a data class other than the default classes, select the check box next to the objects whose class you want to change. To select all of the objects, click **Select All**. Click **Change Class**. In the dialog box that opens, select classes by using the drop-down lists next to **Parameter** and **Signal**.

If the classes that you want do not appear in the drop-down list, select **Customize class lists**. In the dialog box that opens, select the check box next to the classes that you want, and click **OK**.

To change the default parameter and signal classes that the wizard uses to propose objects:

- On the Model Explorer **Model Hierarchy** pane, select a workspace. For example, select **Base Workspace**.
- On the toolbar, click the arrow next to Add Parameter  or Add Signal .
- From the drop-down list, select the class that you want the wizard to use. For example, select **myPackage Parameter** or **myPackage Signal**.

A parameter or signal object appears in the selected workspace. The default name for new parameter objects is **Param**. The default name for new signal objects is **Sig**.

The next time that you use the Data Object Wizard, the wizard proposes objects using the parameter or signal class that you selected in Model Explorer.

- 6 Select the check box next to the proposed objects that you want to create. To select all of the proposed objects, click **Select All**.
- 7 Click **Create**.

The data objects appear in the base workspace. If the target model is linked to a data dictionary, the objects appear in the dictionary.

The wizard changes settings in your model depending on the configuration parameter **Configuration Parameters > Diagnostics > Data Validity > Signal resolution**.

- If you set the parameter to **Explicit only**, the wizard forces the corresponding signals and states in your model to resolve to the new signal objects. The wizard selects the option **Signal name must resolve to Simulink signal object** in each Signal Properties dialog box and **State name must resolve to Simulink signal object** in each block dialog box.
- If you set the parameter to **Explicit and implicit** or **Explicit and warn implicit**, the wizard does not change the setting of **Signal name must resolve to Simulink signal object** or **State name must resolve to Simulink signal object** for any signals or states.

Consider turning off implicit signal object resolution for your model by using the function `disableimplicitsignalresolution`. For more information, see “Explicit and Implicit Symbol Resolution” on page 57-121.

### Data Object Wizard Troubleshooting

The Data Object Wizard does not propose creation of data objects for these entities in a model:

- Multiple separate signals that have the same name.
- A signal with the same name as a variable used in a block parameter.
- A signal that lacks a single contiguous source block.
- A signal whose source block is commented out or commented through.
- Data items that are rendered inactive by Variant Source and Variant Sink blocks. The wizard proposes objects only for data items that are associated with active blocks.
- Signals and states when you set the model configuration parameter **Signal resolution** to None.

### Create Data Objects from External Data Source Programmatically

This example shows how to create data objects based on an external data source (such as a Microsoft Excel file) by using a script.

- 1 Create a new MATLAB script file.
- 2 Place information in the file that describes the data in the external file that you want to convert to data objects. For example, the following information creates two Simulink data objects with the indicated properties. The first is for a parameter and the second is for a signal:

```
% Parameters
ParCon = Simulink.Parameter;
ParCon.CoderInfo.StorageClass = 'Custom'
ParCon.CoderInfo.CustomStorageClass = 'Const';
ParCon.Value = 3;
% Signals
SigGlb = Simulink.Signal;
SigGlb.DataType = 'int8';
```

- 3 Run the script file. The data objects appear in the MATLAB workspace.

If you want to import the target data from the external source, you can write MATLAB functions and scripts that read the information, convert the information to data objects, and load the objects into the base workspace.

You can use these functions to interact with files that are external to MATLAB:

- `xmlread`
- `xmlwrite`
- `xlsread`
- `xlswrite`
- `csvread`
- `csvwrite`
- `dlmread`
- `dlmwrite`

## Data Object Methods

Data classes define functions, called methods, for creating and manipulating the objects that they define. A class may define any of the following kinds of methods.

### Dynamic Methods

A dynamic method is a method whose identity depends on its name and the class of an object specified implicitly or explicitly as its first argument. You can use either function or dot notation to specify this object, which must be an instance of the class that defines the method or an instance of a subclass of the class that defines the method. For example, suppose class `A` defines a method called `setName` that assigns a name to an instance of `A`. Further, suppose the MATLAB workspace contains an instance of `A` assigned to the variable `obj`. Then, you can use either of the following statements to assign the name `'foo'` to `obj`:

```
obj.setName('foo');  
setName(obj, 'foo');
```

A class may define a set of methods having the same name as a method defined by one of its super classes. In this case, the method defined by the subclass overrides the behavior of the method defined by the parent class. Simulink determines which method to invoke at runtime from the class of the object that you specify as its first or implicit argument. Hence, the term dynamic method.



---

**Note:** Most Simulink data object methods are dynamic methods. Unless the documentation for a method specifies otherwise, you can assume that a method is a dynamic method.

---

## Static Methods

A static method is a method whose identity depends only on its name and hence cannot change at runtime. To invoke a static method, use its fully qualified name, which includes the name of the class that defines it followed by the name of the method itself. For example, `Simulink.ModelAdvisor` class defines a static method named `getModelAdvisor`. The fully qualified name of this static method is `Simulink.ModelAdvisor.getModelAdvisor`. The following example illustrates invocation of a static method.

```
ma = Simulink.ModelAdvisor.getModelAdvisor('vdp');
```

## Constructors

Every data class defines a method for creating instances of that class. The name of the method is the same as the name of the class. For example, the name of the `Simulink.Parameter` class's constructor is `Simulink.Parameter`. The constructors defined by Simulink data classes take no arguments.

The value returned by a constructor depends on whether its class is a handle class or a value class. The constructor for a handle class returns a handle to the instance that it creates if the class of the instance is a handle class; otherwise, it returns the instance itself (see “Handle Versus Value Classes” on page 57-75).

## Handle Versus Value Classes

Simulink classes, including data object classes, fall into two categories: value classes and handle classes.

### About Value Classes

The constructor for a *value* class (see “Constructors” on page 57-75) returns an instance of the class and the instance is permanently associated with the MATLAB variable to which it is initially assigned. Reassigning or passing the variable to a function causes MATLAB to create and assign or pass a copy of the original object.

For example, `Simulink.NumericType` is a value class. Executing the following statements

```
x = Simulink.NumericType;  
y = x;
```

creates two instances of class `Simulink.NumericType` in the workspace, one assigned to the variable `x` and the other to `y`.

### About Handle Classes

The constructor for a *handle* class returns a handle object. The handle can be assigned to multiple variables or passed to functions without causing a copy of the original object to be created. For example, `Simulink.Parameter` class is a handle class. Executing

```
x = Simulink.Parameter;  
y = x;
```

creates only one instance of `Simulink.Parameter` class in the MATLAB workspace. Variables `x` and `y` both refer to the instance via its handle.

A program can modify an instance of a handle class by modifying any variable that references it, e.g., continuing the previous example,

```
x.Description = 'input gain';  
y.Description
```

```
ans =  
input gain
```

Most Simulink data object classes are value classes. Exceptions include `Simulink.Signal` and `Simulink.Parameter` class.

You can determine whether a variable is assigned to an instance of a class or to a handle to that class by displaying the variable at the MATLAB command line. MATLAB appends the text (**handle**) to the name of the object class in the value display, e.g.,

```
>> gain = Simulink.Parameter  
  
gain =  
  
Simulink.Parameter (handle)  
    Value: []  
    CoderInfo: [1x1 Simulink.CoderInfo]
```

```

Description: ''
  DataType: 'auto'
    Min: []
    Max: []
  Unit: ''
Complexity: 'real'
Dimensions: [0 0]

```

## Copy Handle Classes

Use the copy method of a handle class to create copies of instances of that class. For example, `Simulink.ConfigSet` is a handle class that represents model configuration sets. The following code creates a copy of the current model's active configuration set and attaches it to the model as an alternate configuration geared to model development.

```

activeConfig = getActiveConfigSet(gcs);
develConfig = copy(activeConfig);
develConfig.Name = 'develConfig';
attachConfigSet(gcs, develConfig);

```

## Compare Data Objects

Simulink data objects provide a method, named `isequal`, that determines whether object property values are equal. This method compares the property values of one object with those belonging to another object and returns true (1) if all of the values are the same or false (0) otherwise. For example, the following code instantiates two signal objects (A and B) and specifies values for particular properties.

```

A = Simulink.Signal;
B = Simulink.Signal;
A.DataType = 'int8';
B.DataType = 'int8';
A.InitialValue = '1.5';
B.InitialValue = '1.5';

```

Afterward, use the `isequal` method to verify that the object properties of A and B are equal.

```

result = isequal(A,B)

```

```

result =

```

```

1

```

## Create Persistent Data Objects

To preserve data objects so that they persist when you close MATLAB, you can:

- Store the objects in a data dictionary or model workspace. To decide where to permanently store model data, see “Determine Where to Store Variables and Objects for Simulink Models” on page 57-85.
- Use the `save` command to save data objects in a MAT-file and the `load` command to restore them to the MATLAB base workspace in the same or a later session. Configure the model to load the objects from the MAT-file or a script file when the model loads.

To load data objects from a file when you load a model, write a script that creates the objects and configures their properties. Alternatively, save the objects in a MAT-file. Then use either the script or a load command as the `PreLoadFcn` callback routine for the model that uses the objects. Suppose that you save the data objects in a file named `data_objects.mat`, and the model to which they apply is open and active. At the command prompt, entering:

```
set_param(gcs, 'PreLoadFcn', 'load data_objects');
```

sets `load data_objects` as the model's preload function. Whenever you open the model, the data objects appear in the base workspace.

Definitions of the classes of saved objects must exist on the MATLAB path for them to be restored. If the class of a saved object acquires new properties after the object is saved, Simulink adds the new properties to the restored version of the object. If the class loses properties after the object is saved, only the properties that remain are restored.

## See Also

`Simulink.Parameter` | `Simulink.LookupTable` | `Simulink.Breakpoint` | `disableimplicitsignalresolution` | `Simulink.Signal`

## Related Examples

- “Determine Where to Store Variables and Objects for Simulink Models” on page 57-85
- “Define Data Classes” on page 57-80
- Block Parameters

- “What Is a Data Dictionary?” on page 61-2
- “Configure Generated Code According to Interface Control Document” (Embedded Coder)
- “Symbol Resolution” on page 57-118

## Define Data Classes

This example shows how to subclass Simulink data classes.

Use MATLAB class syntax to create a data class in a package. Optionally, assign properties to the data class and define custom storage classes.

### Use an example to define data classes

- 1 View the `+SimulinkDemos` data class package in the folder `matlabroot/toolbox/simulink/simdemos/dataclasses` (open).

This package contains predefined data classes.

- 2 Copy the folder to the location where you want to define your data classes.
- 3 Rename the folder `+mypkg` and add its parent folder to the MATLAB path.
- 4 Modify the data class definitions.

### Manually define data class

- 1 Create a package folder `+mypkg` and add its parent folder to the MATLAB path.
- 2 Create class folders `@Parameter` and `@Signal` inside `+mypkg`.

---

**Note:** Simulink requires data classes to be defined inside `+Package/@Class` folders.

---

- 3 In the `@Parameter` folder, create a MATLAB file `Parameter.m` and open it for editing.
- 4 Define a data class that is a subclass of `Simulink.Parameter` using MATLAB class syntax.

```
classdef Parameter < Simulink.Parameter
end % classdef
```

To use a custom class name other than `Parameter` or `Signal`, name the class folders using the custom name. For example, to define a class `myParameter`:

- Define the data class as a subclass of `Simulink.Parameter` or `Simulink.Signal`.

```
classdef myParameter < Simulink.Parameter
end % classdef
```

- In the class definition, name the constructor method as `myParameter` or `mySignal`.
- Name the class folder, which contains the class definition, as `@myParameter` or `@mySignal`.

### Optional: Add properties to data class

The `properties` and `end` keywords enclose a property definition block.

```
classdef Parameter < Simulink.Parameter
    properties % Unconstrained property type
        Prop1 = [];
    end

    properties(PropertyType = 'logical scalar')
        Prop2 = false;
    end

    properties(PropertyType = 'char')
        Prop3 = '';
    end

    properties(PropertyType = 'char',...
        AllowedValues = {'red'; 'green'; 'blue'})
        Prop4 = 'red';
    end
end % classdef
```

If you add properties to a subclass of `Simulink.Parameter`, `Simulink.Signal`, or `Simulink.CustomStorageClassAttributes`, you can specify the following property types.

Property Type	Syntax
Double number	<code>properties(PropertyType = 'double scalar')</code>
int32 number	<code>properties(PropertyType = 'int32 scalar')</code>
Logical number	<code>properties(PropertyType = 'logical scalar')</code>
Character vector (char)	<code>properties(PropertyType = 'char')</code>
Character vector with limited set of allowed values	<code>properties(PropertyType = 'char', AllowedValues = {'a', 'b', 'c'})</code>

If you use MATLAB property validation (see “Validate Property Values” (MATLAB)) instead of `PropertyType` and `AllowedValues`, the property validation does not affect the appearance in the property dialog box of the class. For example, a Boolean (`boolean`) property does not appear in the property dialog box as a check box. It is a best practice to use `PropertyType` and `AllowedValues` instead of MATLAB property validation.

### Optional: Add initialization code to data class

You can add a constructor within your data class to perform initialization activities when the class is instantiated.

In this example, the constructor initializes the value of object `obj` based on an optional input argument.

```
classdef Parameter < Simulink.Parameter
    methods
        function obj = Parameter(optionalValue)
            if (nargin == 1)
                obj.Value = optionalValue;
            end
        end
    end % methods
end % classdef
```

### Optional: Define custom storage classes

Use the `setupCoderInfo` method to configure the `CoderInfo` object of your class. Then, create a call to the `useLocalCustomStorageClasses` method and open the Custom Storage Class Designer.

- 1 In the constructor within your data class, call the `useLocalCustomStorageClasses` method.

```
classdef Parameter < Simulink.Parameter
    methods
        function setupCoderInfo(obj)
            useLocalCustomStorageClasses(obj, 'mypkg');

            obj.CoderInfo.StorageClass = 'Custom';
        end
    end % methods
end % classdef
```

- 2 Open the Custom Storage Class Designer for your package.



```
cscdesigner('mypkg')
```

- 3 Define custom storage classes.

### Optional: Define custom attributes for custom storage classes

- 1 Create a MATLAB file `myCustomAttribs.m` and open it for editing. Save this file in the `+mypkg/@myCustomAttribs` folder, where `+mypkg` is the folder containing the `@Parameter` and `@Signal` folders.
- 2 Define a subclass of `Simulink.CustomStorageClassAttributes` using MATLAB class syntax. For example, consider a custom storage class that defines data using the original identifier but also provides an alternate name for the data in generated code.

```
classdef myCustomAttribs < Simulink.CustomStorageClassAttributes
    properties(PropertyType = 'char')
        AlternateName = '';
    end
end % classdef
```

- 3 Override the default implementation of the `isAddressable` method to determine whether the custom storage class is writable.

```
classdef myCustomAttribs < Simulink.CustomStorageClassAttributes
    properties(PropertyType = 'logical scalar')
        IsAlternateNameInstanceSpecific = true;
    end

    methods
        function retVal = isAddressable(hObj, hCSCDefn, hData)
            retVal = false;
        end
    end % methods
end % classdef
```

- 4 Override the default implementation of the `getInstanceSpecificProps` method.

For examples, see `CSCTypeAttributes_FlatStructure.m` in the folder `matlabroot\toolbox\simulink\simulink\dataclasses\+Simulink\@CSCTypeAttributes_FlatStructure` (open) and `CSCTypeAttributes_Unstructured.m` in the folder `matlabroot\toolbox\simulink\simulink\dataclasses\+mpt\@CSCTypeAttributes_Unstructured` (open).

**Note:** This is an optional step. By default, all custom attributes are instance-specific and are modifiable for each data object. However, you can limit which properties are allowed to be instance-specific.

- 5 Override the default implementation of the `getIdentifiersForInstance` method to define identifiers for objects of the data class.

**Note:** In its default implementation, this method queries the name or identifier of the data object and uses that identifier in generated code. By overriding this method, you can control the identifier of your data objects in generated code.

```
classdef myCustomAttribs < Simulink.CustomStorageClassAttributes
    properties(PropertyType = 'char')
        GetFunction = '';
        SetFunction = '';
    end

    methods
        function retVal = getIdentifiersForInstance(hCSCAttrib,...
            hCSCDefn, hData, identifier)
            retVal = struct('GetFunction',...
                hData.CoderInfo.CustomAttributes.GetFunction, ...
                'SetFunction', hData.CoderInfo.CustomAttributes.SetFunction);
        end%
    end % methods
end % classdef
```

- 6 If you are using grouped custom storage classes, override the default implementation of the `getIdentifiersForGroup` method to specify the identifier for the group in generated code.

For an example, see `CSCTypeAttributes_FlatStructure.m` in the folder `matlabroot\toolbox\simulink\simulink\dataclasses\+Simulink\@CSCTypeAttributes_FlatStructure` (open).

## Related Examples

- “Data Objects” on page 57-59

## Determine Where to Store Variables and Objects for Simulink Models

*Model data* are objects and variables that you create in workspaces such as the base workspace or a data dictionary. Model data include:

- Numeric values for block parameters, such as `Simulink.Parameter` objects and MATLAB variables
- Signals, such as `Simulink.Signal` objects
- Data types
- Model configuration sets
- Simulation input and output data

You can store, partition, and share model data in a location that is appropriate for your design. The storage locations that you choose can depend on:

- Your modeling goals.
- The model architecture (referenced models, subsystems, and other partitioning strategies) and component structure.
- The types of data that you use.

### Types of Data

- *Simulation data* is the set of input data that you use to drive a simulation and the set of output data that a simulation generates. For example, you can use variables to store input data that a simulation acquires through Inport blocks. A simulation can export output data through, for example, Outport blocks, To Workspace blocks, and logged signals.

You can store simulation data for your current MATLAB session in the base workspace. To permanently store this simulation data, save it in a MAT-file or script file. For more information about loading, generating, and storing simulation data, see “Comparison of Signal Loading Techniques” on page 59-124 and “Export Simulation Data” on page 59-4.

- *Design data* is the set of variables that you use to specify block parameters and signal characteristics in a model. For example, design data includes numeric MATLAB variables, parameter and signal data objects, data type objects, and bus objects.

You can store design data in the base workspace, model workspaces, or the Design Data section of a data dictionary. To permanently store local design data with a model, use model workspaces. To share design data between models, use data dictionaries or the base workspace. Data dictionaries permanently store the data, and you can control the data scope to establish ownership, partition the data to ease readability and maintenance, and track changes. If you use the base workspace, to permanently store the data, you must save it in a MAT-file or script file.

- *Configuration sets* are sets of model configuration parameters. By default, configuration sets reside in the model file, so you do not need to store the sets separately from the model. However, you cannot share these sets with other models.

To share configuration sets between models, you must create `Simulink.ConfigSet` objects. Each object represents a standalone configuration set. You can store these objects in the base workspace or in the Configurations section of a data dictionary. If you use data dictionaries, you can define the scope of each configuration set, compare different configuration sets, and track changes. A data dictionary inherently partitions configuration sets from other kinds of data.

## Store Data for Your Design

The table shows the techniques you can use to store, partition, and manage design data and configuration sets.

Modeling Scenario	Scenario Description	Storage Locations and Techniques
Rapid prototyping and model experimentation	<p>You want to create temporary data, such as variables to specify numeric block parameters, while you learn to use Simulink.</p> <p>You want to experiment with modeling techniques. You do not need to</p>	Store data in the base workspace so you can quickly create and change the data.

Modeling Scenario	Scenario Description	Storage Locations and Techniques
	permanently store the data that you create.	
Standalone model	You have a single model that does not depend on other systems for data. The model stands alone because it is not a piece of a larger system.	<p>Store data in the model workspace to improve model portability. Use a data dictionary to store data that you cannot store in the model workspace.</p> <p>Alternatively, store all of the model data in a data dictionary. If you use a dictionary, you can partition the data by using referenced dictionaries.</p>
Standalone hierarchy of referenced models	You have a hierarchy of referenced models that does not depend on other systems for data. The hierarchy stands alone because it is not a piece of a larger system.	<p>Store local model data in each model workspace.</p> <p>Store data that the models share, such as bus objects and configuration sets, in a data dictionary. Link all of the models in the hierarchy to the dictionary.</p> <p>For examples, see “Migrate Model Reference Hierarchy to Use Dictionary” on page 61-8 and Using a Data Dictionary to Manage the Data for a Fuel Control System.</p>

Modeling Scenario	Scenario Description	Storage Locations and Techniques
System of components	One or more teams maintain the components of a system of models. A <i>component</i> is a single model or a hierarchy of referenced models that represents a piece of a larger system.	<p>Store local model data in model workspaces.</p> <p>Store data that the models in a component share, such as bus objects and configuration sets, in a data dictionary. Link all of the models in the component to the dictionary.</p> <p>Use additional referenced dictionaries to store data that the components share.</p> <p>For an example, see “Partition Data for Model Reference Hierarchy Using Data Dictionaries” on page 61-37.</p>

## Storage Locations

Choose any of these locations to store data:

- The MATLAB base workspace. Use the base workspace to store variables while you experiment with temporary models.
- A model workspace. Use a model workspace to permanently store data that is local to a model.
- A data dictionary. Use data dictionaries to permanently store global data, share data between models, and track changes made to data.

The chart shows the capabilities and advantages of each storage location.

Capability	Base Workspace	Model Workspace	Data Dictionary
Data-model linkage	implicit	implicit	✓
Unified interface for defining data	✓	✓	✓
Model-data dependency	✓	✓	✓

Capability	Base Workspace	Model Workspace	Data Dictionary
Data entry comparison	✓	✓	✓
Data entry persistence		✓	✓
Shared data	✓		✓
Data grouping			✓
Change tracking for data entries			✓
Change tracking for configuration sets			✓
Data entry merging and reconciliation			✓
Storage and partitioning of auxiliary data			✓
Requirements linking			✓

For information about the way that models interact with workspaces and workspace variables, see “Symbol Resolution” on page 57-118.

### Temporary Data: Base Workspace

Use the base workspace to temporarily store data:

- While you learn to use Simulink
- When you need to quickly create variables while experimenting with modeling techniques
- When you do not need to store the data permanently

To create variables in the base workspace, you can use the MATLAB command prompt or the Model Explorer. All open models can use the data that you create in the base workspace.

If you use variables to specify numeric block parameters in the model, you can programmatically change the parameter values during simulation by using commands at the command prompt. To programmatically change the values of parameters that you store in the model workspace or data dictionaries, you must use the function interfaces for those storage locations.

To permanently store base workspace data before you end a MATLAB session, you can save the data in a MAT-file or a script file. During a later session, you can load the data from the file. However, if you make changes to the data in the base workspace, you

must save the data to the file again. Consider instead using a model workspace or data dictionary to permanently store data.

### **Local Data: Model Workspace**

Use a model workspace to store data that you use only in the associated model. This data can include:

- Constant parameters, for example, numeric variables that you use to specify block parameter values.
- Data objects, such as `Simulink.Signal` and `Simulink.Parameter` objects, that you use to control signal and parameter characteristics. However, the objects can use only the `Auto` storage class.
- `Simulink.NumericType` objects that you use to specify data types. However, you cannot use the object as a data type alias. You must set the `ISAlias` property to `false`.
- Model arguments.

You can improve model portability and establish data ownership by storing the data in the model workspace. In this case, the model file permanently stores the data.

In a model reference hierarchy, each model workspace acts as a unique namespace. Therefore, you can use the same variable name in multiple model workspaces. You can then assign a unique variable value for each model.

You can use the Model Explorer to manipulate model workspace data. Alternatively, you can use the command prompt or scripts in conjunction with the model workspace programmatic interface.

For more information about using model workspaces to store local data, see “Model Workspaces” on page 57-106.

### **Global and Shared Data: Data Dictionary**

A data dictionary is a standalone file that permanently stores data. Use data dictionaries instead of the base workspace to partition data, track changes, control access, and share data. If you link a model to a data dictionary, the model does not use variables in the base workspace anymore.

As you can with model workspaces, you can use data dictionaries to directly associate data with a model. You can use this association to scope the data and to establish ownership.



When you use dictionaries, you can partition the data by storing it in additional referenced dictionaries. However, each entry in a dictionary must use a unique name. You must manage each dictionary as a separate file.

Use a data dictionary to store data that multiple models or system components share. This data can include:

- Numeric variables that multiple models use to specify block parameter values.
- `Simulink.AliasType` and `Simulink.NumericType` objects that you use to specify data types in multiple models at once.
- Data objects that use a storage class other than `Auto`. If you have a Simulink Coder license, these objects can represent signals and tunable parameters that appear as global variables in the generated code.
- `Simulink.Bus` objects that you use to define signal interfaces between referenced models.
- `Simulink.ConfigSet` objects that you use to maintain configuration parameter uniformity across multiple models.
- Enumerated type definitions, which you store using `Simulink.data.dictionary.EnumTypeDefinition` objects.

You can use the Model Explorer to manipulate dictionary data. Alternatively, you can use the command prompt or scripts in conjunction with the data dictionary programmatic interface.

For basic information about data dictionaries, see “What Is a Data Dictionary?” on page 61-2.

## Related Examples

- “Introduction to Managing Data with Model Reference”
- “Edit and Manage Workspace Variables Used by Models” on page 57-92
- “What Are Model Dependencies?” on page 18-25
- “Componentization Guidelines” on page 15-29
- “Model Workspaces” on page 57-106
- “Data Objects” on page 57-59
- “Symbol Resolution” on page 57-118

## Edit and Manage Workspace Variables Used by Models

### In this section...

“Finding Variables That Are Used by a Model or Block” on page 57-92

“Finding Blocks That Use a Specific Variable” on page 57-95

“Finding Unused Workspace Variables” on page 57-96

“Editing Workspace Variables” on page 57-98

“Rename Variables” on page 57-99

“Compare Duplicate Workspace Variables” on page 57-100

“Export Workspace Variables” on page 57-102

“Importing Workspace Variables” on page 57-104

### Finding Variables That Are Used by a Model or Block

In the Model Explorer, you can get a list of variables that a model or block uses. The following approach is one way to get that list of variables:

- 1 In the **Contents** pane, right-click the block for which you want to find the variables that it uses.
- 2 Select the **Find Referenced Variables** menu item.

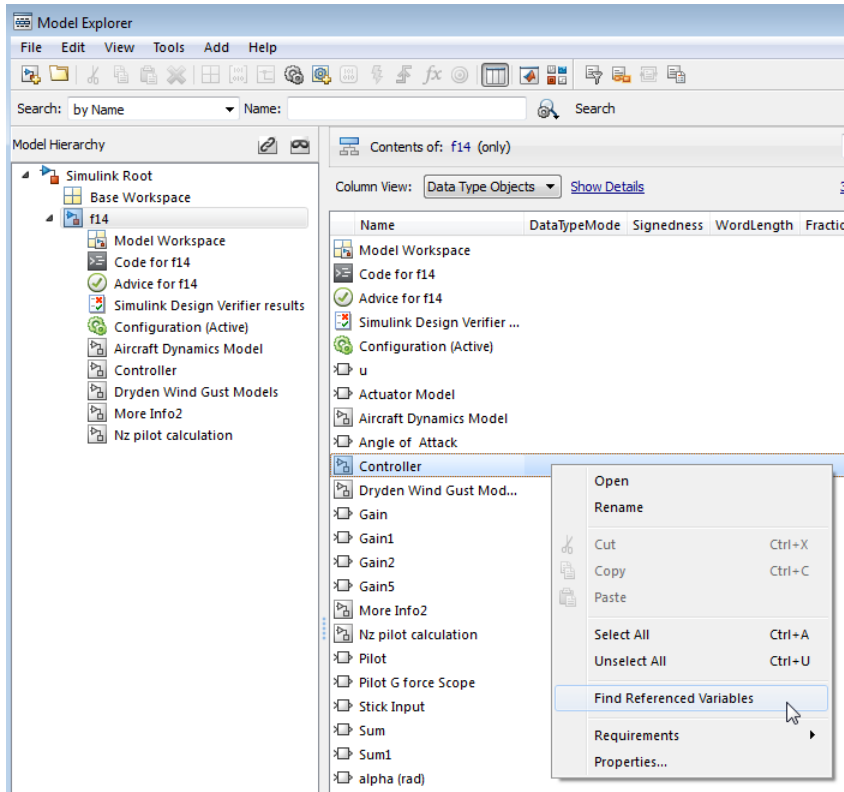

Model Explorer returns results similar to these:

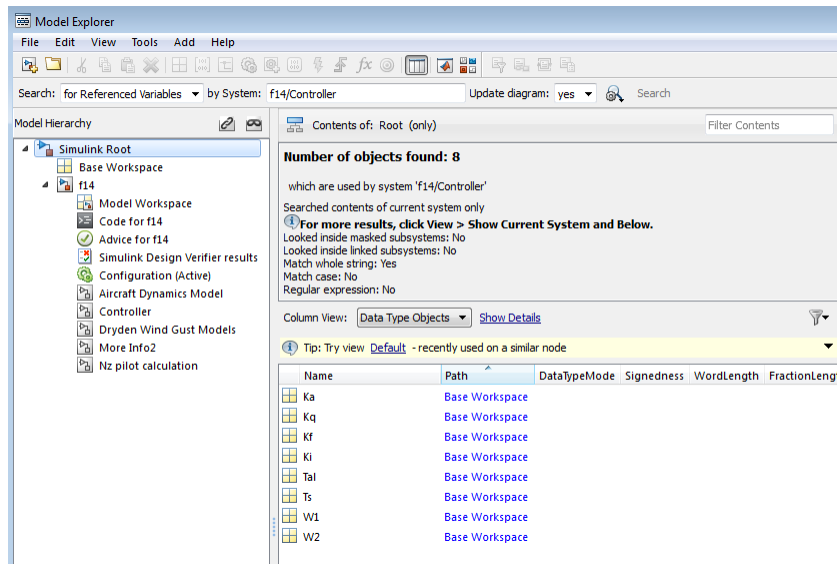

For performance, Model Explorer uses cached information from the last compiled version of the model. If you want to recompile the model, either do so manually or, in the Model Explorer, set the **Update diagram** field to **yes** and repeat the search.

You can also use the following approaches to find variables that a model or block uses:

- In the Model Explorer, in the **Model Hierarchy** pane, right-click a block or model node and select the **Find Referenced Variables** menu item.
- In the Model Explorer, in the search bar, use the **for Referenced Variables** search type option.
- In the Simulink Editor, right-click a block, subsystem, or in the canvas and select the **Find Referenced Variables** menu item. Clicking the canvas returns results for the whole model.

The `Simulink.findVars` function provides additional options for returning information about workspace variables that is not available from the Model Explorer or Simulink Editor.

For information about limitations when finding referenced variables, see the `Simulink.findVars` documentation.

## Using the Set of Returned Variables

For a variable in the set of returned variables, you can find the blocks that use that variable (for details, see “Finding Blocks That Use a Specific Variable” on page 57-95). Also, you can export variables from the returned set of variables. For details, see “Export Workspace Variables” on page 57-102.

## Finding Blocks That Use a Specific Variable

This example shows how to use Model Explorer to get a list of blocks that use a specific workspace variable.

- 1 Open the model f14.
- 2 Open Model Explorer.
- 3 In the **Model Hierarchy** pane, select the **Base Workspace** node.
- 4 In the **Contents** pane, right-click the variable Mq and select **Find Where Used**.
- 5 In the **Select a system** dialog box, select f14.
- 6 Clear the **Search in referenced models** check box, since f14 does not reference any models, and click **OK**.

With **Search in referenced models** selected, you can find the target variable everywhere it is used in a model reference hierarchy. However, finding the target variable in an entire hierarchy can take more time.

The **Update diagram to include recent changes** check box is cleared by default to save time by avoiding unnecessary model diagram updates. Select the check box to incorporate recent changes you made to the model by forcing a diagram update.

- 7 Click **OK** in response to the message to update the model diagram.

Since you just opened the model, you must update the model diagram at least once before finding a variable. You could have selected **Update diagram to include recent changes** in the **Select a system** dialog box to force an initial diagram update, though you typically use that option when you make changes to the model while performing multiple searches with **Find Where Used**.

- 8 Model Explorer displays the search results:

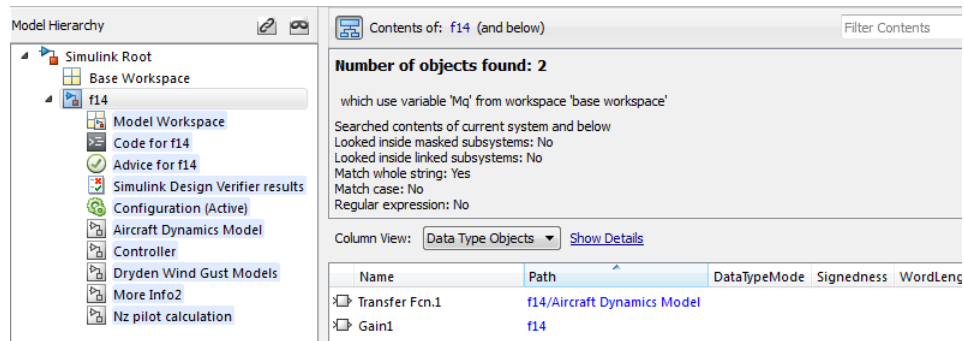

The property columns whose values include  $Mq$  represent the block parameters that use the  $Mq$  variable. If those property columns are not already in the view, then the Model Explorer adds them to the end of the search results display.

You can also find blocks that use a specific variable by using one of these approaches:

- In the search bar, select the **for Variable Usage** search type option.
- In the **Search Results** pane, right-click a variable and select the **Find Where Used** menu item.

## Finding Unused Workspace Variables

You can use the Model Explorer to get a list of variables that are defined in a workspace but not used by a model or block. One way to get that list of variables is to right-click a workspace name in the **Model Hierarchy** pane and select the **Find Unused Variables** menu item. For example:

- 1 Open the f14 model.
- 2 Open the Model Explorer.
- 3 In the search toolbar, set the **Update diagram** field to **yes**.
- 4 In the **Model Hierarchy** pane, right-click the **Base Workspace** node and select the **Find Unused Variables** menu item.

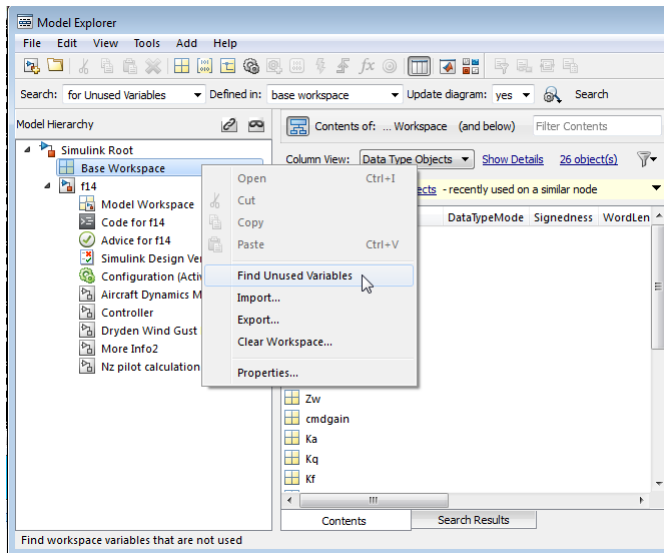

5 The Model Explorer displays output similar to this:

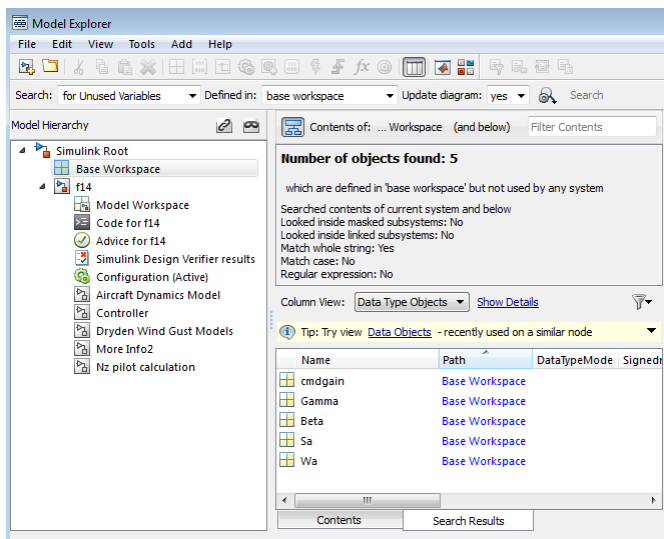

The `Simulink.findVars` function provides additional options for returning information about unused workspace variables that is not available from the Model Explorer or Simulink Editor.

## Editing Workspace Variables

In the Model Explorer **Contents** pane, you can use the Variable Editor to edit variables from the MATLAB base workspace or model workspace. The Variable Editor is available for editing large arrays and structures.

To open the Variable Editor for a variable that is an array or structure:

- 1 Click the Value cell for the variable.
- 2 Click the button  at the right of the value box and select **Open Variable Editor**.

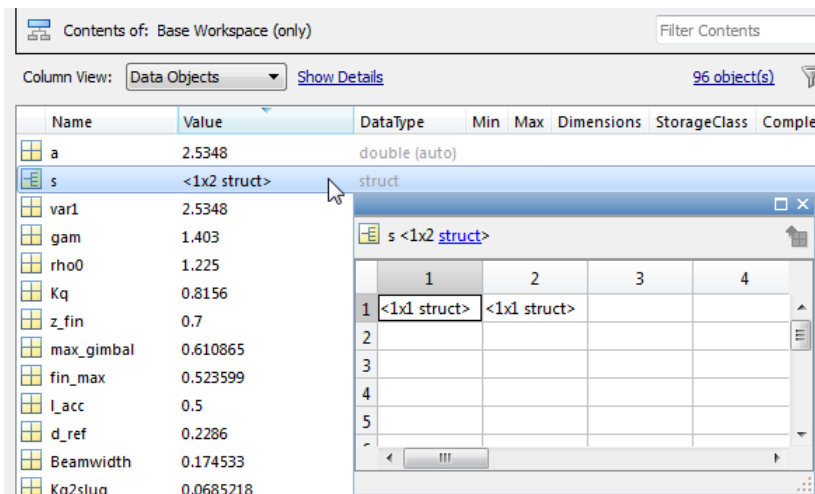

- 3 Update the cells in the Variable Editor. Alternatively, you can right-click in the cell and a context menu of additional editing options appears.
- 4 When you finish editing, click the **Close** button in the upper right corner to close the Variable Editor. The **Contents** pane reflects the edits you make in the Variable Editor.



## Representation of Arrays with Three or More Dimensions

When the value of a variable or `Simulink.Parameter` object is an array with three or more dimensions, the **Value** column displays the array as an expression that contains a call to the `reshape` function.

To edit the values in the array, modify the first argument of the `reshape` call, which contains all of the array values in a serialized vector. When you add or remove elements along a dimension, you must also correct the argument that represents the length of the modified dimension.

## Rename Variables

This example shows how to use Model Explorer to rename a variable everywhere it is used by blocks in Simulink models.

- 1 Open the model `sldemo_absbrake`. The model loads data to the MATLAB base workspace.
- 2 Open Model Explorer.
- 3 In the **Model Hierarchy** pane, select the base workspace.
- 4 In the **Contents** pane, right-click the base workspace variable `m` and select **Rename All**.
- 5 In the **Select a system** dialog box, click the name of the model `sldemo_absbrake` to select it as the context for renaming the variable `m`.
- 6 Clear the **Search in referenced models** check box and click **OK**. The model `sldemo_absbrake` references the model `sldemo_wheelspeed_absbrake`, but only `sldemo_absbrake` uses the variable `m`.

With **Search in referenced models** selected, you can rename the target variable everywhere it is used in a model reference hierarchy. However, renaming the target variable in an entire hierarchy can take more time.

The **Update diagram to include recent changes** check box is cleared by default to save time by avoiding unnecessary model diagram updates. Select the check box to incorporate recent changes you made to the model by forcing a diagram update.

- 7 Click **OK** in response to the message to update the model diagram.

Since you just opened the model, you must update the model diagram at least once before renaming a variable. You could have selected **Update diagram to include**

**recent changes** in the **Select a system** dialog box to force an initial diagram update, though you typically use that option when you make changes to the model while performing multiple variable renaming operations.

- 8** In the **Rename All** dialog box, type a new name for the variable in the **New name** box and click **OK**.

You can use the hyperlinks in the **Corresponding blocks** section of the **Rename All** dialog box to view the target blocks.

---

**Note:** You can rename only variables that the function `Simulink.findVars` supports.

---

For help with renaming files, use a project. See “Automatic Updates When Renaming, Deleting, or Removing Files” on page 17-12.

## Compare Duplicate Workspace Variables

You can compare duplicate variables that are stored in the same workspace or in different workspaces. For example, you can compare a variable stored in the base workspace with its duplicate, which is stored in the model workspace.

- 1** Open a model and the Model Explorer.
- 2** In the search toolbar, search for the variable that is duplicated. Select the rows with the duplicate entries. Then, right-click and select **Compare Selected**.

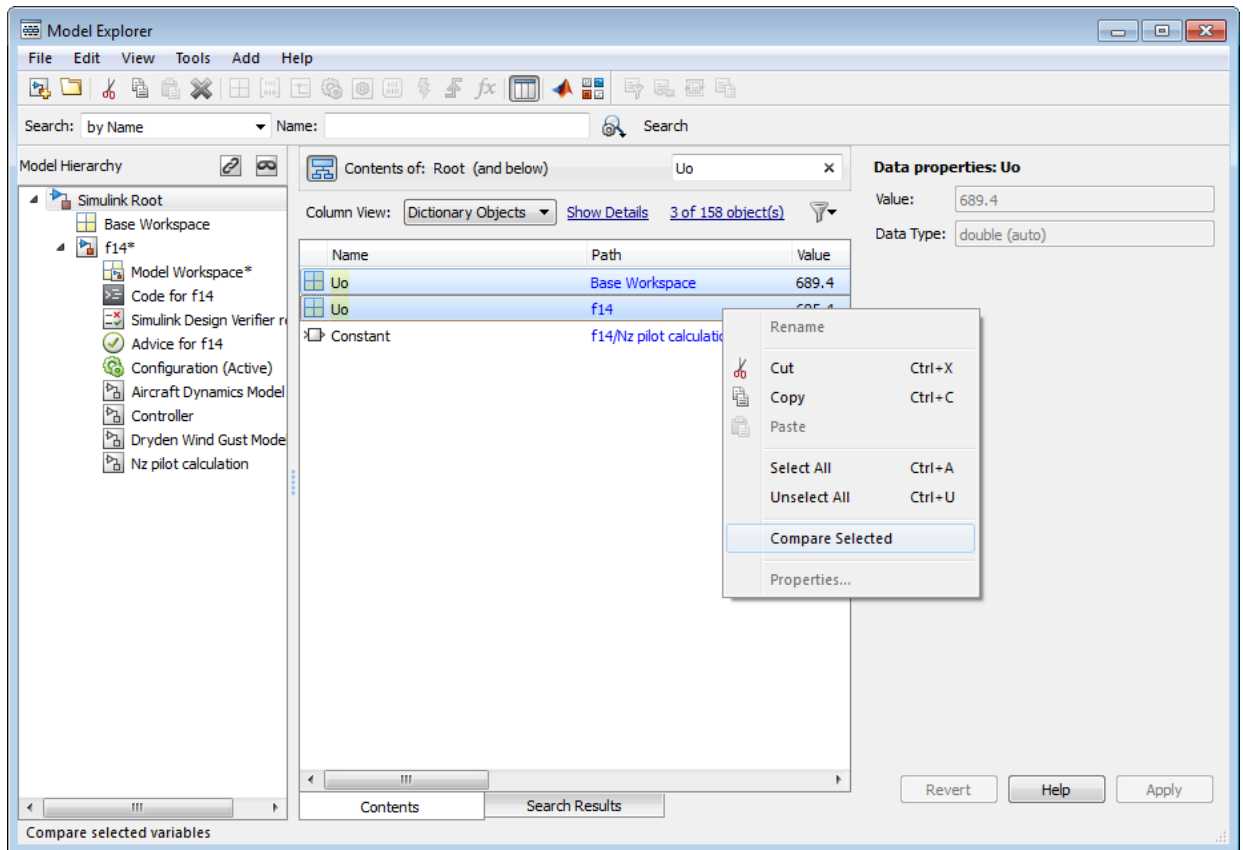

3 Review the differences in the **Comparison Viewer**.

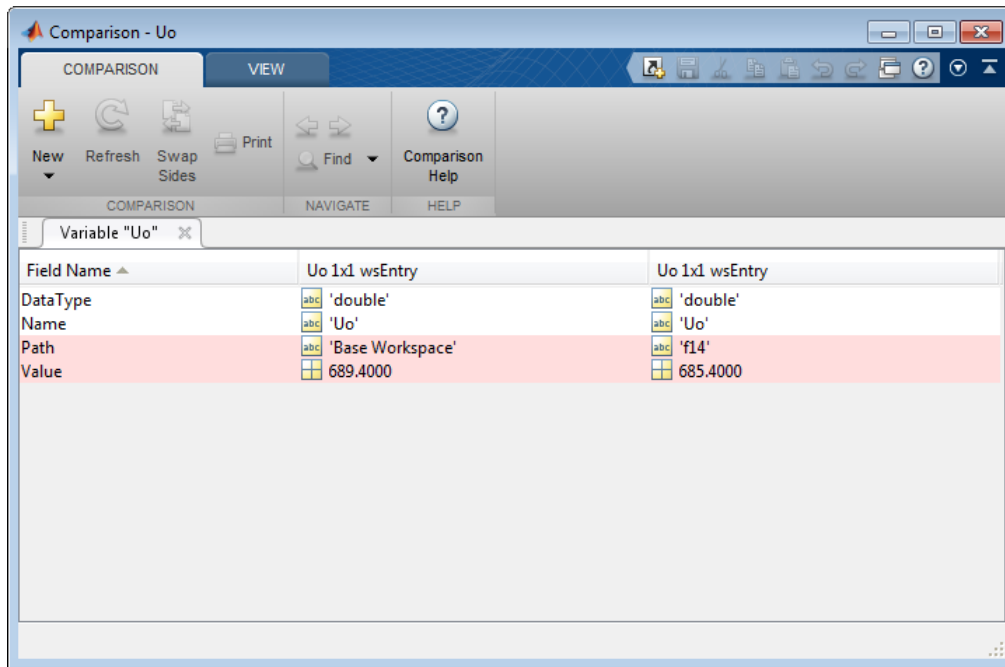

## Export Workspace Variables

You can export (save) a set of variables listed in the Model Explorer, exporting either individual variables or all the variables in the base or model workspace.

One possible workflow is to export the set of variables returned with the **Find Referenced Variables** option or the `Simulink.findVars` function. For details, see “Finding Variables That Are Used by a Model or Block” on page 57-92.

---

**Note:** All the variables that you export must be from the same workspace.

---

To export all the variables in a workspace in the Model Explorer to a MATLAB code file or MAT-file:

- 1 Select the variables that you want to export.

- a To select all the variables in a workspace, right-click the workspace node (for example, **Base Workspace**) and select the **Export** menu item. For example:

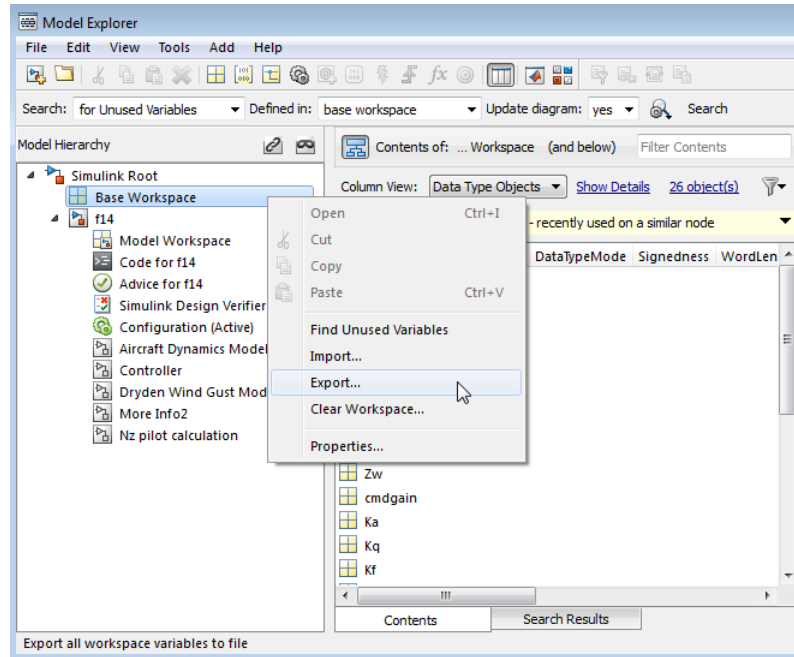

- b To select individual variables, in the **Contents** pane, select the variables that you want to export. Right-click one of the highlighted variables and select the **Export Selected** menu item.

If the **Contents** pane has data grouped by a property, selecting the top line in a group does not select all the variables in that group. For details about grouped data, see “Group by a Property” on page 12-24.

- 2 Specify whether to save the variables in a MATLAB code file or a MAT-file.

The MATLAB code file format is easier to read, is editable, and supports version control. The MAT-file format is binary, which has performance advantages.

If you specify a MATLAB code file format, the Model Explorer may create an associated MAT-file, reflecting the name of the MATLAB code file, but with an extension of `.mat` instead of `.m`.

- 3 Specify a name and location for the file.
- 4 If the file already exists, Model Explorer displays a dialog box asking you to choose one of these options:
  - **Overwrite entire file**
    - Replaces all variables in the target file with the selected variables, which are stored in alphabetical order.
  - **Update variables that exist in file and append new variables to file**
    - Updates existing variables in place and appends new variables.
  - **Only update variables that exist in file**
    - Updates existing variables, but does not add any new variables, which eliminates potentially extraneous variables.

To permanently store workspace variables for a model, instead of using the base workspace, create a data dictionary. See “What Is a Data Dictionary?” on page 61-2.

## Importing Workspace Variables

You can import (load) a set of variables from a file into the base workspace or into a model workspace using the Model Explorer. When you import variables into a workspace, the Model Explorer overwrites existing variables and adds any new variables.

To import variables into a workspace:

- 1 In the **Model Hierarchy** pane, right-click the workspace into which you want to import variables.
- 2 Select the **Import** menu item.
- 3 In the Import from File dialog box, select a MATLAB code file or MAT-file for the variables that you want to import.

---

**Note:** If you import a MATLAB code file, then Simulink also imports the associated MAT-file.

---

## See Also

`Simulink.findVars`

## **Related Examples**

- “Determine Where to Store Variables and Objects for Simulink Models” on page 57-85
- “Search Using Model Explorer” on page 12-52

## **More About**

- “Search and Edit Using Model Explorer” on page 12-2
- “Model Explorer: Property Dialog Pane” on page 12-36

## Model Workspaces

### In this section...

“Model Workspace Differences from MATLAB Workspace” on page 57-106

“Troubleshooting Memory Issues” on page 57-107

“Manipulate Model Workspace Programmatically” on page 57-107

### Model Workspace Differences from MATLAB Workspace

Each model is provided with its own workspace for storing variable values.

The model workspace is similar to the base MATLAB workspace except that:

- Variables in a model workspace are visible only in the scope of the model.

If both the MATLAB workspace and a model workspace define a variable of the same name, and the variable does not appear in any intervening masked subsystem or model workspaces, the Simulink software uses the value of the variable in the model workspace. A model's workspace effectively provides it with its own name space, allowing you to create variables for the model without risk of conflict with other models.

- When the model is loaded, the workspace is initialized from a data source.

The data source can be a Model file, a MAT-file, a MATLAB file, or MATLAB code stored in the model file. For more information, see “Data source” on page 57-110.

- You can interactively reload and save MAT-file, MATLAB file, and MATLAB code data sources.
- To store a data object in a model workspace, set the storage class of the object to **Auto**. Data objects are objects of these classes:
  - `Simulink.Parameter` and subclasses
  - `Simulink.Signal` and subclasses

If you specify a storage class other than **Auto**, you must store data objects in the base workspace or a data dictionary to ensure the objects are unique within the global Simulink context and accessible to all models.

- In general, parameter variables in a model workspace are not tunable in the code generated from a model.



However, you can tune model workspace variables declared as model arguments for referenced models. For more information, see “Specify Different Value for Each Instance of Reusable Model” on page 8-65.

---

**Note:** When resolving references to variables used in a referenced model, the variables of the referenced model are resolved as if the parent model did not exist. For example, suppose a referenced model references a variable that is defined in both the parent model's workspace and in the MATLAB workspace but not in the referenced model's workspace. In this case, the MATLAB workspace is used.

---

## Troubleshooting Memory Issues

When you use a workspace variable as a block parameter, Simulink creates a copy of the variable during the compilation phase of the simulation and stores the variable in memory. This can cause your system to run out of memory during simulation, or in the process of generating code. Your system might run out of memory if you have:

- Large models with many parameters
- Models with parameters that have a large number of elements

This issue does not affect the amount of memory that is used to represent parameters in generated code.

## Manipulate Model Workspace Programmatically

An object of the `Simulink.ModelWorkspace` class describes a model workspace. Simulink creates an instance of this class for each model that you open during a Simulink session. The methods associated with this class can be used to accomplish a variety of tasks related to the model workspace, including:

- Listing the variables in the model workspace
- Assigning values to variables
- Evaluating expressions
- Clearing the model workspace
- Reloading the model workspace from the data source
- Saving the model workspace to a specified MAT-file or MATLAB file

- Saving the workspace to the MAT-file or MATLAB file that the workspace designates as its data source

## **See Also**

`Simulink.ModelWorkspace`

## **Related Examples**

- “Specify Source for Data in Model Workspace” on page 57-109
- “Change Model Workspace Data” on page 57-114
- “Determine Where to Store Variables and Objects for Simulink Models” on page 57-85
- “Parameterize Instances of a Reusable Referenced Model” on page 8-65
- “Introduction to Managing Data with Model Reference”

## Specify Source for Data in Model Workspace

When you use a model workspace to contain the variables that a model uses, you can choose to store the variables in one of these sources:

- The model file, which can store static variable definitions.
- A separate MAT-file or MATLAB file. You can reload the variables from the external file into the model workspace at any time.
- Your own custom MATLAB code that creates variables. You can save the code as part of the model file, and reload the code at any time.

To specify a data source for a model workspace, in the Model Explorer, use the Model Workspace dialog box. To display the dialog box for a model workspace:

- 1** Open the Model Explorer by selecting **View > Model Explorer**.
- 2** In the **Model Hierarchy** pane, right-click the model workspace.

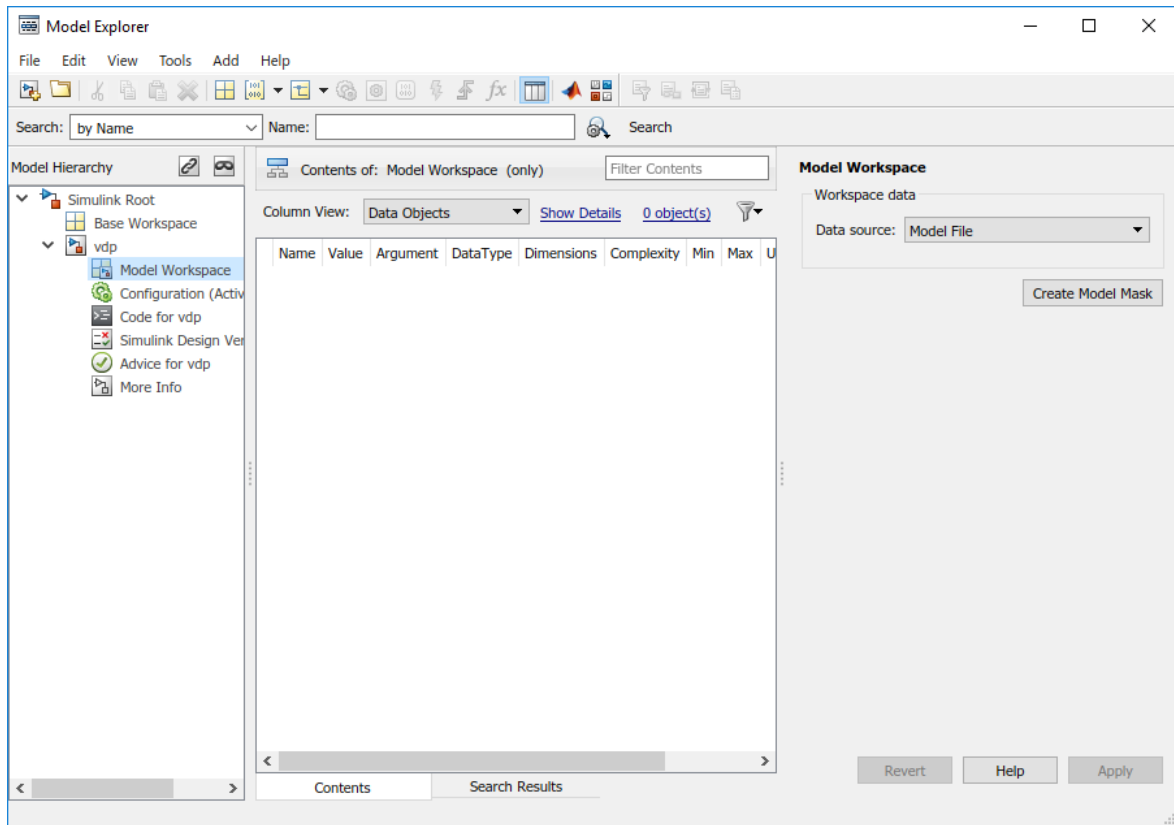

3 Select the **Properties** menu item, which opens the Model Workspace dialog box.

To use MATLAB commands to change data in a model workspace, see “Use MATLAB Commands to Change Workspace Data” on page 57-116.

## Data source

The **Data source** field in the Model Workspace dialog box includes the following data source options for a workspace:

- Model File

Specifies that the data source is the model itself.

- **MAT-File**

Specifies that the data source is a MAT file. Selecting this option causes additional controls to appear (see “MAT-File and MATLAB File Source Controls” on page 57-111).

- **MATLAB File**

Specifies that the data source is a MATLAB file. Selecting this option causes additional controls to appear (see “MAT-File and MATLAB File Source Controls” on page 57-111).

- **MATLAB Code**

Specifies that the data source is MATLAB code stored in the model file. Selecting this option causes additional controls to appear (see “MATLAB Code Source Controls” on page 57-112).

## MAT-File and MATLAB File Source Controls

Selecting **MAT-File** or **MATLAB File** as the **Data source** for a workspace causes the Model Workspace dialog box to display additional controls.

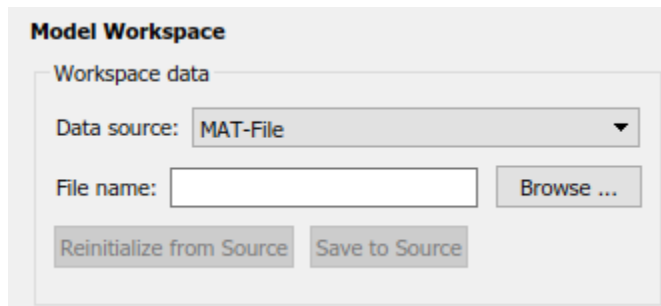

The screenshot shows the 'Model Workspace' dialog box. Under the 'Workspace data' section, the 'Data source' dropdown menu is set to 'MAT-File'. Below this, there is a 'File name' text input field and a 'Browse ...' button. At the bottom of the dialog, there are two buttons: 'Reinitialize from Source' and 'Save to Source'.

### File name

Specifies the file name or path name of the MAT-file or MATLAB file that is the data source for the selected workspace. If you specify a file name, the name must reside on the MATLAB path.

### Reinitialize From Source

Clears the workspace and reloads the data from the MAT-file or MATLAB file specified by the **File name** field.

### Save To Source

Saves the workspace in the MAT-file or MATLAB file specified by the **File name** field.

## MATLAB Code Source Controls

Selecting MATLAB Code as the **Data source** for a workspace causes the Model Workspace dialog box to display additional controls.

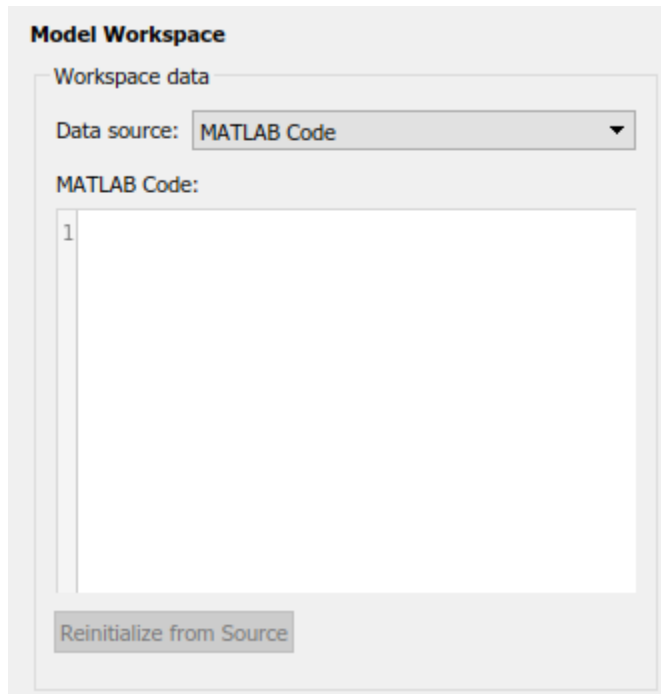

### MATLAB Code

Specifies MATLAB code that initializes the selected workspace. To change the initialization code, edit this field, then select the **Reinitialize from source** button on the dialog box to clear the workspace and execute the modified code.

### Reinitialize from Source

Clears the workspace and executes the contents of the **MATLAB Code** field.

## **Create Model Mask**

Mask the model, which enables you to control how users of the model interact with model arguments. For more information, see “Introduction to Model Mask” on page 37-63.

## **Related Examples**

- “Determine Where to Store Variables and Objects for Simulink Models” on page 57-85
- “Model Workspaces” on page 57-106
- “Change Model Workspace Data” on page 57-114

## Change Model Workspace Data

When you use a model workspace to contain the variables that a model uses, you choose a source to store the variables, such as the model file or an external MAT-file. To modify the variables at the source, you use a different procedure depending on the type of source that you selected.

### Change Workspace Data Whose Source Is the Model File

If the data source of a model workspace is the model file, you can use Model Explorer or MATLAB commands to modify the stored variables (see “Use MATLAB Commands to Change Workspace Data” on page 57-116).

For example, to create a variable in a model workspace:

- 1 Open the Model Explorer by selecting **View > Model Explorer** or by pressing **Ctrl +H**.
- 2 In the Model Explorer **Model Hierarchy** pane, expand the node for your model, and select the model workspace.

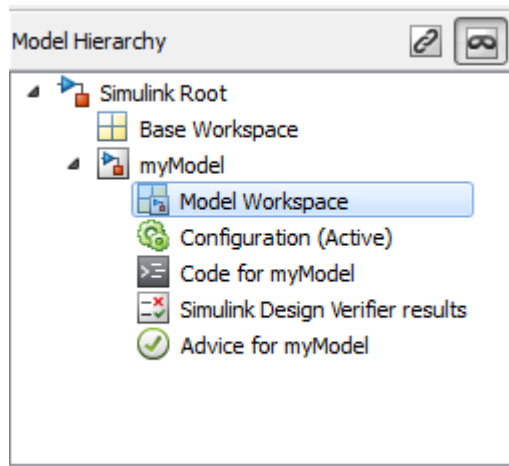

- 3 Select **Add > MATLAB Variable**.

You can similarly use the **Add** menu or toolbar to add a `Simulink.Parameter` object to a model workspace.



To change the value of a model workspace variable:

- 1 Open the Model Explorer by selecting **View > Model Explorer**.
- 2 In the Model Explorer **Model Hierarchy** pane, select the model workspace.
- 3 In the **Contents** pane, select the variable.
- 4 In the **Contents** pane or in **Dialog** pane, edit the value displayed.

To delete a model workspace variable:

- 1 Open the Model Explorer by selecting **View > Model Explorer**.
- 2 In the Model Explorer **Model Hierarchy** pane, select the model workspace.
- 3 In **Contents** pane, select the variable.
- 4 Select **Edit > Delete**.

## Change Workspace Data Whose Source Is a MAT-File or MATLAB File

You can use Model Explorer or MATLAB commands to modify workspace data whose source is a MAT-file or MATLAB file.

To make the changes permanent, in the Model Workspace dialog box, use the **Save To Source** button to save the changes to the MAT-file or MATLAB file.

- 1 Open the Model Explorer by selecting **View > Model Explorer**.
- 2 In the Model Explorer **Model Hierarchy** pane, right-click the workspace.
- 3 Select the **Properties** menu item.
- 4 In the Model Workspace dialog box, use the **Save To Source** button to save the changes to the MAT-file or MATLAB file.

To discard changes to the workspace, in the Model Workspace dialog box, use the **Reinitialize From Source** button.

## Changing Workspace Data Whose Source Is MATLAB Code

The safest way to change data whose source is MATLAB code is to edit and reload the source. Edit the MATLAB code and then in the Model Workspace dialog box, use **Reinitialize From Source** button to clear the workspace and re-execute the code.

To save and reload alternative versions of the workspace that result from editing the MATLAB code source or the workspace variables themselves, see “Export Workspace Variables” on page 57-102 and “Importing Workspace Variables” on page 57-104.

## Use MATLAB Commands to Change Workspace Data

To use MATLAB commands to change data in a model workspace, first get the workspace for the currently selected model:

```
hws = get_param(bdroot, 'modelworkspace');
```

This command returns a handle to a `Simulink.ModelWorkspace` object whose properties specify the source of the data used to initialize the model workspace. Edit the properties to change the data source.

Use the workspace methods to:

- List, set, and clear variables
- Evaluate expressions in the workspace
- Save and reload the workspace

For example, the following MATLAB code creates variables specifying model parameters in the model workspace, saves the parameters, modifies one of them, and then reloads the workspace to restore it to its previous state.

```
hws = get_param(bdroot, 'modelworkspace');  
hws.DataSource = 'MAT-File';  
hws.FileName = 'params';  
hws.assignin('pitch', -10);  
hws.assignin('roll', 30);  
hws.assignin('yaw', -2);  
hws.saveToSource;  
hws.assignin('roll', 35);  
hws.reload;
```

To programmatically access variables for the purpose of sweeping block parameter values, consider using `Simulink.SimulationInput` objects instead of modifying the variables through the programmatic interface of the model workspace. See “Optimize, Estimate, and Sweep Block Parameter Values” on page 35-50.

## Create Model Mask

Mask the model, which enables you to control how users of the model interact with model arguments. For more information, see “Introduction to Model Mask” on page 37-63.

## **Related Examples**

- “Determine Where to Store Variables and Objects for Simulink Models” on page 57-85
- “Model Workspaces” on page 57-106
- “Specify Source for Data in Model Workspace” on page 57-109

## Symbol Resolution

### In this section...

“Symbols” on page 57-118

“Symbol Resolution Process” on page 57-118

“Numeric Values with Symbols” on page 57-120

“Other Values with Symbols” on page 57-120

“Limit Signal Resolution” on page 57-121

“Explicit and Implicit Symbol Resolution” on page 57-121

## Symbols

When you create a Simulink model, you can use symbols to provide values and definitions for many types of entities in the model. Model entities that you can define with symbols include block parameters, configuration set parameters, data types, signals, signal properties, and bus architecture.

A symbol that provides a value or definition must be a legal MATLAB identifier. Such an identifier starts with an alphabetic character, followed by alphanumeric or underscore characters up to the length given by the function `namelengthmax`. You can use the function `isvarname` to determine whether a symbol is a legal MATLAB identifier.

A symbol provides a value or definition in a Simulink model by corresponding to some item that:

- Exists in an accessible workspace
- Has a name that matches the symbol
- Provides the required information

## Symbol Resolution Process

The process of finding an item that corresponds to a symbol is called *symbol resolution* or *resolving the symbol*. The matching item can provide the needed information directly, or it can itself be a symbol. A symbol must resolve to some other item that provides the information.

When the Simulink software compiles a model, it tries to resolve every symbol in the model, except symbols in MATLAB code that runs in a callback or as part of mask initialization. Depending on the particular case, the item to which a symbol resolves can be a variable, object, or function.

Simulink attempts to resolve a symbol by searching through the accessible workspaces in hierarchical order for a MATLAB variable or Simulink object whose name is the same as the symbol.

The search path is identical for every symbol. The search begins with the block that uses the symbol, or is the source of a signal that is named by the symbol, and proceeds upward. Except when simulation occurs via the `sim` command, the search order is:

- 1 Any mask workspaces, in order from the block upwards (see “Masking Fundamentals” on page 37-2).
- 2 The model workspace of the model that contains the block (see “Model Workspaces” on page 57-106).
- 3 The MATLAB base workspace (see “Create and Edit Variables” (MATLAB)). If the model is linked to a data dictionary, Simulink searches in the dictionary instead of the base workspace. For more information about data dictionaries, see “What Is a Data Dictionary?” on page 61-2.

If Simulink finds a matching item in the course of this search, the search terminates successfully at that point, and the symbol resolves to the matching item. The result is the same as if the value of that item had appeared literally instead of the symbol that resolved to the item. An object defined at a lower level shadows any object defined at a higher level.

If no matching item exists on the search path, Simulink attempts to evaluate the symbol as a function. If the function is defined and returns an appropriate value, the symbol resolves to whatever the function returned. Otherwise, the symbol remains unresolved, and an error occurs. Evaluation as a function occurs as the final step whenever a hierarchical search terminates without having found a matching workspace variable.

If the model that contains the symbol is a referenced model, and the search reaches the model workspace but does not succeed there, the search jumps directly to the base workspace or data dictionary *without* trying to resolve the symbol in the workspace of any parent model. Thus a given symbol resolves to the same item, irrespective of whether the model that contains the symbol is a referenced model. For information about model referencing, see “Model Referencing”.

## Numeric Values with Symbols

You can specify any block parameter that requires a numeric value by providing a literal value, a symbol, or an expression, which can contain symbols and literal values. Each symbol is resolved separately, as if none of the others existed. Different symbols in an expression can thus resolve to items on different workspaces, and to different types of item.

When a single symbol appears and resolves successfully, its value provides the value of the parameter. When an expression appears, and all symbols resolve successfully, the value of the expression provides the value of the parameter. If any symbol cannot be resolved, or resolves to a value of inappropriate type, an error occurs.

For example, suppose that the **Gain** parameter of a Gain block is given as `cos(a*(b+2))`. The symbol `cos` will resolve to the MATLAB cosine function, and `a` and `b` must resolve to numeric values, which can be obtained from the same or different types of items in the same or different workspaces. If the symbols resolve to numeric values, the value returned by the cosine function becomes the value of the **Gain** parameter.

## Other Values with Symbols

Most symbols and expressions that use them provide numeric values, but the same techniques that provide numeric values can provide any type of value that is appropriate for its context.

Another common use of symbols is to name objects that provide definitions of some kind. For example, a signal name can resolve to a signal object (`Simulink.Signal`) that defines the properties of the signal, and a Bus Creator block **Data type** parameter can name a bus object (`Simulink.Bus`) that defines the properties of the bus. You can use symbols for many purposes, including:

- Define data types
- Specify input data sources
- Specify logged data destinations

For hierarchical symbol resolution, all of these different uses of symbols, whether singly or in expressions, are the same. Each symbol is resolved, if possible, independently of any others, and the result becomes available where the symbol appeared. The only difference between one symbol and another is the specific item to which the symbol resolves and

the use made of that item. The only requirement is that every symbol must resolve to something that can legally appear at the location of the symbol.

## Limit Signal Resolution

Hierarchical symbol resolution traverses the complete search path by default. You can truncate the search path by using the **Permit Hierarchical Resolution** option of any subsystem. This option controls what happens if the search reaches that subsystem without resolving to a workspace variable. The **Permit Hierarchical Resolution** values are:

- All

Continue searching up the workspace hierarchy trying to resolve the symbol. This is the default value.

- None

Do not continue searching up the hierarchy.

- ExplicitOnly

Continue searching up the hierarchy only if the symbol specifies a block parameter value, data store memory (where no block exists), or a signal or state that explicitly requires resolution. Do not continue searching for an implicit resolution. See “Explicit and Implicit Symbol Resolution” on page 57-121 for more information.

If the search does not find a match in the workspace, and terminates because the value is `ExplicitOnly` or `None`, Simulink evaluates the symbol as a function. The search succeeds or fails depending on the result of the evaluation, as previously described.

## Explicit and Implicit Symbol Resolution

Models and some types of model entities have associated parameters that can affect symbol resolution. For example, suppose that a model includes a signal named `Amplitude`, and that a `Simulink.Signal` object named `Amplitude` exists in an accessible workspace. If the `Amplitude` signal's **Signal name must resolve to Simulink signal object** option is checked, the signal will resolve to the object. See “Signal Properties Controls” for more information.

If the option is not checked, the signal may or may not resolve to the object, depending on the value of **Configuration Parameters > Data Validity > Signal resolution**.

This parameter can suppress resolution to the object even though the object exists, or it can specify that resolution occurs on the basis of the name match alone. For more information, see “Model Configuration Parameters: Data Validity Diagnostics” > “Signal resolution”.

Resolution that occurs because an option such as **Signal name must resolve to Simulink signal object** requires it is called *explicit symbol resolution*. Resolution that occurs on the basis of name match alone, without an explicit specification, is called *implicit symbol resolution*.

---

**Tip:** Implicit symbol resolution can be useful for fast prototyping. However, when you are done prototyping, consider using explicit symbol resolution, because implicit resolution slows performance, complicates model validation, and can have nondeterministic effects.

---

## See Also

isvarname

## Related Examples

- “Explicit and Implicit Symbol Resolution” on page 57-121
- “Create and Edit Variables” (MATLAB)
- “Model Workspaces” on page 57-106



## Configure Data Properties by Using a Table

Models contain data items such as signals, block parameters (for example, the **Gain** parameter of a Gain block), and data stores. The Model Data Editor enables you to inspect and edit data items in a list that you can sort, group, and filter. You can then configure properties and parameters without having to locate the items in the block diagram.

While creating and debugging a model, you can configure multiple data items at once by selecting the corresponding signals and blocks in the block diagram. Work with the selected items in the Model Data Editor instead of opening individual dialog boxes. Use this technique to more quickly view and compare properties of multiple signals that are close to each other, for example, in a subsystem.

Use the Model Data Editor to configure:

- Instrumentation for signals and data stores, which means you want to view and collect the simulation values. For example, you can log signals to compare data in the Simulation Data Inspector.
- Design attributes such as data type, minimum and maximum value, and physical units. You specify these attributes to control:
  - The values of numeric block parameters.
  - The interaction (interface) between components through Inport and Outport blocks and data stores.
- Storage classes, which control the representation of the data in the code that you generate from the model.

To use the Model Data Editor in a model, select **View > Model Data**.

### Configure Distant Data Items

The example model `sldemo_fuelsys_dd` represents the fueling system of a vehicle engine. The referenced model `sldemo_fuelsys_dd_controller` controls the rate of fuel flow to the engine. In this example, use the Model Data Editor to log signals in different subsystems and referenced models so you can inspect their data using the Simulation Data Inspector.

### Explore Example Models

- 1 Open `sldemo_fuelsys_dd` and the referenced model `sldemo_fuelsys_dd_controller`.
- 2 Navigate to the `airflow_calc` subsystem.

The Pumping Constant block contains a lookup table that describes the performance of a fuel pump. You can stream the output of this block to the Simulation Data Inspector.

- 3 Navigate to the root of the model and into the `fuel_calc` subsystem.
- 4 Navigate into the `feedforward_fuel_rate` subsystem.

The Outport block named `ff_fuel_rate` passes feedforward information to the fuel rate control algorithm.

- 5 Navigate back to the `fuel_calc` subsystem and into the `switchable_compensation` subsystem.

The Inport block named `ff_fuel_rate` carries the feedforward information. You can stream the output of this Inport block.

### Log Signals for Data Inspection

- 1 Open the root of the `sldemo_fuelsys_dd_controller` model.
- 2 In the Model Data Editor, set the **Change View** drop-down to **Instrumentation**.
- 3 Click the **Change Scope** button  to display the contents of the subsystems.

The **Path** column appears.

- 4 Select the **Signals** tab.

The Model Data Editor identifies all the signals in the model.

- 5 In the Filter Contents box, type `ff_fuel_rate`.

The Model Data Editor updates the list of signals to include only those named `ff_fuel_rate`. You can click the link in the **Path** column to view where the signal resides within the model.

- 6 Select the **Log Data** check box for the signal whose path is `sldemo_fuelsys_dd_controller/fuel_calc/switchable_compensation`.

This instructs Simulink to send the data for the logged signals to the Simulation Data Inspector.

- 7 Filter the signals again using the text `Pumping Constant`.

The table contains one row that corresponds to the output of the `Pumping Constant` block.

- 8 Select the **Log Data** check box for the `Pumping Constant` signal.
- 9 Simulate the system model, `sldemo_fuelsys_dd`. During the simulation, double-click a Manual Switch block, such as `Engine Speed Selector`, to disturb the fuel control system.
- 10 When the simulation finishes, notice the **Simulation Data Inspector** button



is highlighted. This indicates that there is data to inspect and compare. Click the **Simulation Data Inspector** button.

- 11 In the left pane, expand the **Run** node that corresponds to the simulation run and select the check boxes for the signals whose data you want to inspect and compare.

The Simulation Data Inspector presents the values for the selected signals on the same graph.

## Select Data Items in a Block Diagram

In the example model `sldemo_househeat`, use the Simulink Editor to log the signals in the `Heater` subsystem for inspection using the Simulation Data Inspector. You will review these logged signals using the Data Model Editor

- 1 In the example model `sldemo_househeat`, open the `Heater` subsystem.
- 2 Open the Model Data Editor and select the **Signals** tab.

The Model Data Editor identifies all the signals in the subsystem.

- 3 Using the Simulink Editor, select all the signals in the subsystem. Optionally, do not select the output of the Constant block because the signal value does not change during the simulation.

In response, the Model Data Editor highlights the rows that correspond to the signals you selected.

- 4 In the Simulink Editor, right-click one of the selected signals, such as the **Thermostat Command (On/Off)** signal, and select **Log Selected Signals**.

The **Log Data** box for the selected signals is checked in the Model Data Editor, instructing Simulink to send data for these logged signals to the Simulation Data Inspector.

If you later choose not to log the data for the **Thermostat Command (On/Off)** signal, clear the **Log Data** check box in the Model Data Editor. Alternatively, in the Simulink Editor, right-click the **Thermostat Command (On/Off)** signal and select **Stop Logging Selected Signals**.

- 5 Simulate the model.
- 6 Open the Simulation Data Inspector and, in the leftmost pane, expand the **Run** node that corresponds to the simulation run. Select the check boxes for the signals whose values you want to inspect and compare.

## Refine List by Filtering, Sorting, and Grouping

Use the Model Data Editor to identify block parameters whose values are defined using a variable.

- 1 In the example model **f14**, open the Model Data Editor and select the **Parameters** tab.
- 2 Click the **Change Scope** button to display the contents of the subsystems.
- 3 Hold **Ctrl** and click the **Block** column header.

The Model Data Editor groups the list by block. Notice that some blocks have multiple rows. Each row represents a different block parameter.

- 4 Filter the list by using the text **Mq**.

The Model Data Editor updates the list to include only those blocks that have a value defined by the **Mq** variable. You can click the link in the **Path** column to view where the signal resides within the model.

- 5 In the **Value** column for the **Gain1** block, click the button  at the right of the value box. Use **Open Variable** to modify the block parameter value or **Explore Variable** to view the variable in the Model Explorer.

The **Open Variable** and **Explore Variable** labels defines the workspace where the variable is stored.

## Navigate to Blocks That Own Data

To navigate from a data item in the Model Data Editor to the block in the diagram that owns the data item, double-click the block icon in the left-most column. The Simulink Editor then focuses on the block. Use this technique to navigate to blocks when you select **Change Scope** to view the contents of subsystems below the current system.

## Configure Data Interface for Component

Whether you use referenced models or subsystems to break a large system into components, the components can exchange signal data through Inport and Outport blocks. You can explicitly configure design attributes (such as data type and numeric complexity) of the interface to prevent modeling errors and make integrating the components easier.

After you create the Inport and Outport blocks, you can use the Model Data Editor and the interface display to configure the design attributes (such as data type and numeric complexity) of the blocks. Use this technique to view the entirety of the component interface at once and to trace the pieces of the interface to usage points in the internal block algorithm. You can also use this technique to configure the interface of a component before you develop the internal algorithm, in which case the component contains only Inport and Outport blocks.

For an example, see “Configure Data Interface for Component” on page 21-15.

## Purpose of Columns

Use this table to find more information about the purpose of the columns in the Model Data Editor.

Column Name	Purpose and More Information
Signal Name	“Signal Names and Labels” on page 62-4
Test Point	“Test Points” on page 62-56
Log Data	“Log Signals to the Simulation Data Inspector” on page 27-6
Data Type	“Control Signal Data Types” on page 57-8
Dimensions	“Signal Dimensions” on page 62-30

Column Name	Purpose and More Information
<b>Min and Max</b>	“Signal Ranges” on page 62-41
<b>Unit</b>	“Unit Specification in Simulink Models” on page 9-2
<b>Initial Value</b>	“Specify Initial Value for Data Store” on page 60-11
<b>Resolve</b>	Corresponds to the <b>Signal name must resolve to Simulink signal object</b> check box in the Signal Properties dialog box. See “Use Signal Objects” on page 57-61.
<b>Storage Class</b>	“Control Signals and States in Code by Applying Storage Classes” (Simulink Coder)
<b>Header File</b> <b>Definition File</b> <b>Get Function</b> <b>Set Function</b> <b>Struct Name</b>	Custom attributes for custom storage classes, which you select with <b>Storage Class</b> . See “Control Data Representation by Applying Custom Storage Classes” (Embedded Coder).
<b>Value</b>	“Set Block Parameter Values” on page 35-2
<b>Path</b>	Visible when you click the <b>Change Scope</b> button. Defines the location of the block in the model and provides a link to the block in the Simulink Editor.

## Model Data Editor Limitations

You cannot specify these attributes by using the Model Data Editor:

- Design attributes for signals other than Outport blocks and the output signals of Inport blocks.
- Any settings for block parameters other than the parameter value. However, you can create and navigate to variables and `Simulink.Parameter` objects that you use to set block parameter values.

- Any settings for nontunable mask parameters. Some built-in blocks are masked and have nontunable mask parameters.
- Any settings for parameters of Simscape blocks.
- Any settings for block states.
- Any settings for data stores that you define by using `Simulink.Signal` objects instead of Data Store Memory blocks.
- Any settings for data items in referenced models. Instead, open the Model Data Editor in the referenced models.

The Model Data Editor does not show Stateflow data. However, the Model Data Editor shows the data for Simulink Functions that you define inside Stateflow charts.

To manage Stateflow data, events, and messages in a chart, see “Manage Stateflow Data, Events, and Messages in the Symbols Window” (Stateflow).

## Related Examples

- “Configure Data Interface for Component” on page 21-15
- “Design Data Interface by Configuring Inport and Outport Blocks” (Simulink Coder)
- “Decide How to Visualize Simulation Data” on page 28-2
- “Configure Generated Code According to Interface Control Document” (Embedded Coder)

## Upgrade Level-1 Data Classes

Simulink no longer supports level-1 data classes. You must upgrade data classes that you created using the level-1 data class infrastructure, which was removed in a previous release.

Run the following utility function while specifying the destination folder for the upgraded classes.

---

**Note:** Property types defined in level-1 data classes that are not subclasses of `Simulink.Parameter`, `Simulink.Signal`, or `Simulink.CustomStorageClassAttributes` are not preserved during an upgrade. Only subclasses of these three classes will preserve attributes `PropertyType` and `AllowedValues`.

---

- 1 This command upgrades all your level-1 data class packages. You cannot upgrade selected data packages.

```
Simulink.data.upgradeClasses('C:\MyDataClasses')
```

Here, `C:\MyDataClasses` is the destination folder for your level-2 data classes.

---

**Note:** Do not place your upgraded level-2 classes and their equivalent level-1 classes in the same folder.

---

`Simulink.data.upgradeClasses` uses the `packagedefn.mat` file in your level-1 class packages for the upgrade and creates level-2 classes in the specified destination folder. Then, `Simulink.data.upgradeClasses` adds the folder to top of the MATLAB path and saves the path.

---

**Note:** If `Simulink.data.upgradeClasses` cannot save the MATLAB path because of restricted access, a warning appears. In this case, manually add the folder to the top of the MATLAB path and save the path using `savepath`.

---

- 2 You can change the location of the level-2 package folders after they have been generated. However, you will need to update your MATLAB path so that MATLAB can find these package folders.



- 3 Resave MAT-files and models that contain level-1 data objects.
- 4 Retain your level-1 classes on the MATLAB path until you have resaved all of your models and MAT-files that contain level-1 data objects. Any models or MAT-files that contain level-1 data objects will continue to load successfully while your level-1 data classes are on the MATLAB path.

---

**Note:** You cannot use both level-1 and level-2 data classes at the same time. Level-2 classes need to be above the level-1 classes on the MATLAB path so that they are found by MATLAB.

---

## See Also

`Simulink.Parameter` | `Simulink.Signal`

## Related Examples

- “Define Data Classes” on page 57-80
- “Data Objects” on page 57-59

## Associating User Data with Blocks

You can use the `set_param` command to associate your own data with a block. For example, the following command associates the value of the variable `mydata` with the currently selected block.

```
set_param(gcb, 'UserData', mydata)
```

The value of `mydata` can be any MATLAB data type, including arrays, structures, objects, and Simulink data objects.

Use `get_param` to retrieve the user data associated with a block.

```
get_param(gcb, 'UserData')
```

The following command saves the user data associated with a block in the model file of the model containing the block.

```
set_param(gcb, 'UserDataPersistent', 'on');
```

---

**Note** If persistent `UserData` for a block contains any Simulink data objects, the directories containing the definitions for the classes of those objects must be on the MATLAB path when you open the model containing the block.

---

### Related Examples

- “Specify Block Properties” on page 34-4

## Support Limitations for Simulink Software Features

Simulink Design Verifier does not support the following Simulink software features. Avoid using these unsupported features.

Not Supported	Description
Variable-step solvers	<p>The software supports only fixed-step solvers.</p> <p>For more information, see “Choose a Fixed-Step Solver” on page 23-15.</p>
Callback functions	<p>The software does not execute model callback functions during the analysis. The results that the analysis generates, such as the harness model, may behave inconsistently with the expected behavior.</p> <ul style="list-style-type: none"> <li>• If a model or any referenced model calls a callback function that changes any block parameters, model parameters, or workspace variables, the analysis does not reflect those changes.</li> <li>• Changing the storage class of base workspace variables on model callback functions or mask initializations is not supported.</li> <li>• Callback functions called prior to analysis, such as the <code>PreLoadFcn</code> or <code>PostLoadFcn</code> model callbacks, are fully supported.</li> </ul>
Model callback functions	<p>The software only supports model callback functions if the <code>InitFcn</code> callback of the model is empty.</p>
Algebraic loops	<p>The software does not support models that contain algebraic loops.</p> <p>For more information, see “Algebraic Loops” on page 3-38.</p>
Masked subsystem initialization functions	<p>The software does not support models whose masked subsystem initialization modifies any attribute of any workspace parameter.</p>
Complex signals	<p>The software supports only real signals.</p>

Not Supported	Description
	For more information, see “Complex Signals” on page 62-15.
Variable-size signals	<p>The software does not support variable-size signals. A variable-size signal is a signal whose size (number of elements in a dimension), in addition to its values, can change during model execution.</p> <p>For more information, see “Variable-Size Signal Basics” on page 64-2.</p>
Multiword fixed-point data types	The software does not support multiword fixed-point data types.
Nonzero start times	<p>Although Simulink allows you to specify a nonzero simulation start time, the analysis generates signal data that begins only at zero. If your model specifies a nonzero start time:</p> <ul style="list-style-type: none"> <li>• If you do not select the <b>Reference input model in generated harness</b> parameter (the default), the harness model is a subsystem. The analysis sets the start time of the harness model to 1 and continues the analysis.</li> <li>• If you select the <b>Reference input model in generated harness</b> parameter, a Model block references the harness model. The software cannot change the start time of the harness model, so the analysis stops and you see a recommendation to set the <b>Start time</b> parameter to 0.</li> </ul>

Not Supported	Description
Nonfinite data	<p>The software does not support nonfinite data (for example, NaN and Inf) and related operations.</p> <p>In the Relational Operator block, the software assigns the output as follows:</p> <ul style="list-style-type: none"> <li>• If the <b>Relational operator</b> parameter is <code>isFinite</code>, the output is always 1.</li> <li>• If the <b>Relational operator</b> parameter is <code>isNan</code> or <code>isInf</code>, the output is always 0.</li> </ul> <p>In the MATLAB Function block, the software assigns the return value as follows:</p> <ul style="list-style-type: none"> <li>• For the <code>isFinite</code> function, the output is always 1.</li> <li>• For the <code>isNan</code> and <code>isInf</code> functions, the output is always 0.</li> </ul>
Concurrent execution	The software does not support models that are configured for concurrent execution.
Signals with nonzero sample time offset	The software does not support models with signals that have nonzero sample time offsets.
Models with no output ports	The software only supports models that have one or more output ports.
Large floating-point constants outside the range $[-\text{realmax}/2, \text{realmax}/2]$	The use of large floating-point constants can cause out of memory errors or substantial loss of precision. Avoid using such constants if possible.
Symbolic Dimensions	The software does not support symbolic dimensions for test generation, property proving, or design error detection.

## More About

- “Supported and Unsupported Simulink Blocks” on page 57-136
- “Support Limitations for Stateflow Software Features” on page 57-148

## Supported and Unsupported Simulink Blocks

The software provides various levels of support for Simulink blocks:

- Fully supported
- Partially supported
- Not supported

If your model contains unsupported blocks, you can enable automatic stubbing. Automatic stubbing considers the interface of the unsupported blocks, but not their behavior. If any of the unsupported blocks affect the simulation outcome, however, the analysis may achieve only partial results. For details about automatic stubbing, see “Handle Incompatibilities with Automatic Stubbing” (Simulink Design Verifier).

To achieve 100% coverage, avoid using unsupported blocks in models that you analyze. Similarly, for partially supported blocks, specify only the block parameters that the software recognizes.

The following tables summarize the analysis support for Simulink blocks. Each table lists the blocks in a Simulink library and describes support information for that particular block.

### Additional Math and Discrete Library

The software supports all blocks in the Additional Math and Discrete library.

### Commonly Used Blocks Library

The Commonly Used Blocks library includes blocks from other libraries. Those blocks are listed under their respective libraries.

### Continuous Library

Block	Support Notes
Derivative	Not supported
Integrator	Not supported and not stubbable
Integrator Limited	Not supported and not stubbable
PID Controller	Not supported

Block	Support Notes
PID Controller (2 DOF)	Not supported
Second Order Integrator	Not supported and not stubbable
Second Order Integrator Limited	Not supported and not stubbable
State-Space	Not supported and not stubbable
Transfer Fcn	Not supported and not stubbable
Transport Delay	Not supported
Variable Time Delay	Not supported
Variable Transport Delay	Not supported
Zero-Pole	Not supported and not stubbable

### Discontinuities Library

The software supports all blocks in the Discontinuities library.

### Discrete Library

Block	Support Notes
Delay	Supported
Difference	Supported
Discrete Derivative	Supported
Discrete Filter	Supported
Discrete FIR Filter	Supported
Discrete PID Controller	Supported
Discrete PID Controller (2 DOF)	Supported
Discrete State-Space	Not supported
Discrete Transfer Fcn	Supported
Discrete Zero-Pole	Not supported
Discrete-Time Integrator	Supported
First-Order Hold	Supported
Memory	Supported
Tapped Delay	Supported

Block	Support Notes
Transfer Fcn First Order	Supported
Transfer Fcn Lead or Lag	Supported
Transfer Fcn Real Zero	Supported
Unit Delay	Supported
Zero-Order Hold	Supported

### Logic and Bit Operations Library

The software supports all blocks in the Logic and Bit Operations library.

### Lookup Tables Library

Block	Support Notes
Cosine	Supported
Direct Lookup Table (n-D)	Supported
Interpolation Using Prelookup	Not supported when: <ul style="list-style-type: none"> <li>The <b>Interpolation method</b> parameter is <b>Linear</b> and the <b>Number of table dimensions</b> parameter is greater than 4.</li> </ul> or <ul style="list-style-type: none"> <li>The <b>Interpolation method</b> parameter is <b>Linear</b> and the <b>Number of sub-table selection dimensions</b> parameter is not 0.</li> </ul>
1-D Lookup Table	Not supported when the <b>Interpolation method</b> or the <b>Extrapolation method</b> parameter is <b>Cubic Spline</b> .
2-D Lookup Table	Not supported when the <b>Interpolation method</b> or the <b>Extrapolation method</b> parameter is <b>Cubic Spline</b> .
n-D Lookup Table	Not supported when: <ul style="list-style-type: none"> <li>The <b>Interpolation method</b> or the <b>Extrapolation method</b> parameter is <b>Cubic Spline</b>.</li> </ul> or



Block	Support Notes
	<ul style="list-style-type: none"> <li>The <b>Interpolation method</b> parameter is <b>Linear</b> and the <b>Number of table dimensions</b> parameter is greater than 5.</li> </ul>
Lookup Table Dynamic	Supported
Prelookup	Supported
Sine	Supported

### Math Operations Library

Block	Support Notes											
Abs	Supported											
Add	Supported											
Algebraic Constraint	Supported											
Assignment	Supported											
Bias	Supported											
Complex to Magnitude-Angle	Not supported											
Complex to Real-Imag	Supported											
Divide	Supported											
Dot Product	Supported											
Find Nonzero Elements	Supported											
Gain	Supported											
Magnitude-Angle to Complex	Supported											
Math Function	<p>All signal types support the following <b>Function</b> parameter settings.</p> <table border="1"> <tbody> <tr> <td>conj</td> <td>hermitian</td> <td>magnitude^2</td> <td>mod</td> </tr> <tr> <td>rem</td> <td>reciprocal</td> <td>square</td> <td>transpose</td> </tr> </tbody> </table> <p>The software does not support the following <b>Function</b> parameter settings.</p> <table border="1"> <tbody> <tr> <td>10^u</td> <td>exp</td> <td>hypot</td> </tr> </tbody> </table>	conj	hermitian	magnitude^2	mod	rem	reciprocal	square	transpose	10^u	exp	hypot
conj	hermitian	magnitude^2	mod									
rem	reciprocal	square	transpose									
10^u	exp	hypot										

Block	Support Notes		
	log	log10	pow
Matrix Concatenate	Supported		
MinMax	Supported		
MinMax Running Resettable	Supported		
Permute Dimensions	Supported		
Polynomial	Supported		
Product	Supported		
Product of Elements	Supported		
Real-Imag to Complex	Supported		
Reciprocal Sqrt	Not supported		
Reshape	Supported		
Rounding Function	Supported		
Sign	Supported		
Signed Sqrt	Not supported		
Sine Wave Function	Not supported		
Slider Gain	Supported		
Sqrt	Supported		
Squeeze	Supported		
Subtract	Supported		
Sum	Supported		
Sum of Elements	Supported		
Trigonometric Function	Supported if <b>Function</b> is sin, cos, or sincos, and <b>Approximation method</b> is CORDIC.		
Unary Minus	Supported		
Vector Concatenate	Supported		
Weighted Sample Time Math	Supported		

### Model Verification Library

The software supports all blocks in the Model Verification library.

### Model-Wide Utilities Library

Block	Support Notes
Block Support Table	Supported
DocBlock	Supported
Model Info	Supported
Timed-Based Linearization	Not supported
Trigger-Based Linearization	Not supported

### Ports & Subsystems Library

Block	Support Notes
Atomic Subsystem	Supported
Code Reuse Subsystem	Supported
Configurable Subsystem	Supported
Enable	Supported
Enabled Subsystem	<p>Design range checks do not consider specified minimum and maximum values for blocks connected to the output of the subsystem. For more information on design range checks, see “Check for Specified Intermediate Minimum and Maximum Signal Values” (Simulink Design Verifier).</p> <p>Simulink Design Verifier treats Enabled Subsystems as short-circuited during test generation.</p>
Enabled and Triggered Subsystem	<p>Not supported when the trigger control signal specifies a fixed-point data type.</p> <p>Design range checks do not consider specified minimum and maximum values for blocks connected to the output of the subsystem. For more information on design range checks, see “Check for Specified Intermediate Minimum and Maximum Signal Values” (Simulink Design Verifier).</p>

Block	Support Notes
	Simulink Design Verifier treats Enabled and Triggered Subsystems as short-circuited during test generation.
For Each	<p>Supported with the following limitations:</p> <ul style="list-style-type: none"> <li>• When For Each Subsystem contains one or more Simulink Design Verifier Test Condition, Test Objective, Proof Assumption, or Proof Objective blocks, not supported.</li> <li>• When the mask parameters of the For Each Subsystem are partitioned, not supported.</li> </ul>
For Each Subsystem	<p>Supported with the following limitations:</p> <ul style="list-style-type: none"> <li>• When For Each Subsystem contains one or more Simulink Design Verifier Test Condition, Test Objective, Proof Assumption, or Proof Objective blocks, not supported.</li> <li>• When the mask parameters of the For Each Subsystem are partitioned, not supported.</li> </ul>
For Iterator Subsystem	Supported
Function-Call Feedback Latch	Supported
Function-Call Generator	Supported
Function-Call Split	Supported
Function-Call Subsystem	<p>Design range checks do not consider specified minimum and maximum values for blocks connected to the output of the subsystem. For more information on design range checks, see “Check for Specified Intermediate Minimum and Maximum Signal Values” (Simulink Design Verifier).</p> <p>Not supported when the Function-Call Subsystem is invoked using function-call triggers passed via root-level Inport blocks. For more information see, “Export-Function Models” on page 10-52.</p>
If	Parameter configurations are not supported. The analysis ignores parameter configurations that you specify for an If block.

Block	Support Notes
If Action Subsystem	Supported
In Bus Element	Supported
Inport	Supported
Model	Supported except for the limitations described in “Support Limitations for Model Blocks” (Simulink Design Verifier).
Model Variants	Supported except for the limitations described in “Support Limitations for Model Blocks” (Simulink Design Verifier).
Out Bus Element	Supported
Outport	Supported
Resettable Subsystem	Supported
Subsystem	Supported
Switch Case	Supported
Switch Case Action Subsystem	Supported
Trigger	Supported
Triggered Subsystem	<p>Not supported when the trigger control signal specifies a fixed-point data type.</p> <p>Design range checks do not consider specified minimum and maximum values for blocks connected to the output of the subsystem. For more information on design range checks, see “Check for Specified Intermediate Minimum and Maximum Signal Values” (Simulink Design Verifier).</p> <p>Simulink Design Verifier treats Enabled Subsystems as short-circuited during test generation.</p>
Variant Subsystem	<p>Not supported when the <b>Generate preprocessor conditionals</b> parameter is enabled.</p> <p>Only the active variant is analyzed.</p>
While Iterator Subsystem	Supported

### Signal Attributes Library

The software supports all blocks in the Signal Attributes library.

### Signal Routing Library

Block	Support Notes
Bus Assignment	Supported
Bus Creator	Supported
Bus Selector	Supported
Data Store Memory	Supported
Data Store Read	Supported
Data Store Write	Supported
Demux	Supported
Environment Controller	Supported
From	Supported
Goto	Supported
Goto Tag Visibility	Supported
Index Vector	Supported
Manual Switch	<p>The Manual Switch block is compatible with the software, but the analysis ignores this block in a model. The analysis does not flag the coverage objectives for this block as satisfiable or unsatisfiable.</p> <p>Model coverage data is collected for the Manual Switch block.</p>
Merge	Supported
Multiport Switch	Supported
Mux	Supported
Selector	Supported
Switch	Supported
Vector Concatenate	Supported

### Sinks Library

Block	Support Notes
Display	Supported

Block	Support Notes
Floating Scope	Supported
Output (Out1)	Supported
Scope	Supported
Stop Simulation	Not supported and not stunnable
Terminator	Supported
To File	Supported
To Workspace	Supported
XY Graph	Supported

### Sources Library

Block	Support Notes
Band-Limited White Noise	Not supported
Chirp Signal	Not supported
Clock	Supported
Constant	Supported unless <b>Constant value</b> is <code>inf</code> .
Counter Free-Running	Supported
Counter Limited	Supported
Digital Clock	Supported
Enumerated Constant	Supported
From File	Not supported. When MAT-file data is stored in MATLAB <code>timeseries</code> format, not stunnable.
From Workspace	Not supported
Ground	Supported
Inport (In1)	Supported
Pulse Generator	Supported
Ramp	Supported
Random Number	Not supported and not stunnable
Repeating Sequence	Not supported

Block	Support Notes
Repeating Sequence Interpolated	Not supported
Repeating Sequence Stair	Supported
Signal Builder	Not supported
Signal Generator	Not supported
Sine Wave	Not supported
Step	Supported
Uniform Random Number	Not supported and not stubbable

### User-Defined Functions Library

Block	Support Notes
Fcn	Supports all operators except $\wedge$ , and supports only the mathematical functions <code>abs</code> , <code>ceil</code> , <code>fabs</code> , <code>floor</code> , <code>rem</code> , and <code>sgn</code> .  Parameter configurations are not supported. The analysis ignores parameter configurations that you specify for these blocks.
Interpreted MATLAB Function	Not supported
Level-2 MATLAB S-Function	For limitations, see “Support Limitations for S-Functions” (Simulink Design Verifier).
MATLAB Function	For limitations, see “Support Limitations for MATLAB for Code Generation” (Simulink Design Verifier).
S-Function	For limitations, see “Support Limitations for S-Functions” (Simulink Design Verifier).
S-Function Builder	For limitations, see “Support Limitations for S-Functions” (Simulink Design Verifier).
Simulink Function	Simulink Function blocks with output arguments that are of bus data-type are not supported.  Calls to Simulink Functions across model boundaries are not supported.



## **More About**

- “Support Limitations for Simulink Software Features” on page 57-133
- “Support Limitations for Stateflow Software Features” on page 57-148

## Support Limitations for Stateflow Software Features

Simulink Design Verifier does not support the following Stateflow software features. Avoid using these unsupported features in models that you analyze.

In this section...
“ml Namespace Operator, ml Function, ml Expressions” on page 57-148
“C Math Functions” on page 57-148
“Atomic Subcharts That Call Exported Graphical Functions Outside a Subchart” on page 57-149
“Atomic Subchart Input and Output Mapping” on page 57-149
“Recursion and Cyclic Behavior” on page 57-149
“Custom C or C++ Code” on page 57-151
“Machine-Parented Data” on page 57-151
“Textual Functions with Literal String Arguments” on page 57-151

### ml Namespace Operator, ml Function, ml Expressions

The software does not support calls to MATLAB functions or access to MATLAB workspace variables, which the Stateflow software allows. (See “Access Built-In MATLAB Functions and Workspace Data” (Stateflow) in the Stateflow documentation.)

### C Math Functions

The software supports calls to the following C math functions:

- abs
- ceil
- fabs
- floor
- fmod
- labs
- ldexp
- pow (only for integer exponents)

The software does not support calls to other C math functions, which the Stateflow software allows. If automatic stubbing is enabled, which it is by default, the software eliminates these unsupported functions during the analysis.

For information about C math functions in Stateflow, see “Call C Functions in C Charts” (Stateflow) in the Stateflow documentation.

---

**Note:** For details about automatic stubbing, see “Handle Incompatibilities with Automatic Stubbing” (Simulink Design Verifier).

---

## Atomic Subcharts That Call Exported Graphical Functions Outside a Subchart

The software does not support atomic subcharts that call exported graphical functions, which the Stateflow software allows.

---

**Note:** For information about exported functions, see “Export Stateflow Functions for Reuse” (Stateflow) in the Stateflow documentation.

---

## Atomic Subchart Input and Output Mapping

If an input or output in an atomic subchart maps to chart-level data of a different scope, the software does not support the chart that contains that atomic subchart.

For an atomic subchart input, this incompatibility applies when the input maps to chart-level data of output, local, or parameter scope. For an atomic subchart output, this incompatibility applies when the output maps to chart-level data of local scope.

## Recursion and Cyclic Behavior

The software does not support recursive functions, which occur when a function calls itself directly or indirectly through another function call. Stateflow software allows you to implement recursion using graphical functions.

In addition, the software does not support recursion that the Stateflow software allows you to implement using a combination of event broadcasts and function calls.

---

**Note:** For information about avoiding recursion in Stateflow charts, see “Guidelines for Avoiding Unwanted Recursion in a Chart” (Stateflow) in the Stateflow documentation.

---

Stateflow software also allows you to create *cyclic behavior*, where a sequence of steps is repeated indefinitely. If your model has a chart with cyclic behavior, the software cannot analyze it.

---

**Note:** For information about cyclic behavior in Stateflow charts, see “Cyclic Behavior in a Chart” (Stateflow) in the Stateflow documentation.

---

However, you can modify a chart with cyclic behavior so that it is compatible, as in the following example.

The following chart creates cyclic behavior. State A calls state A1, which broadcasts a **Clear** event to state B, which calls state B2, which broadcasts a **Set** event back to state A, causing the cyclic behavior.

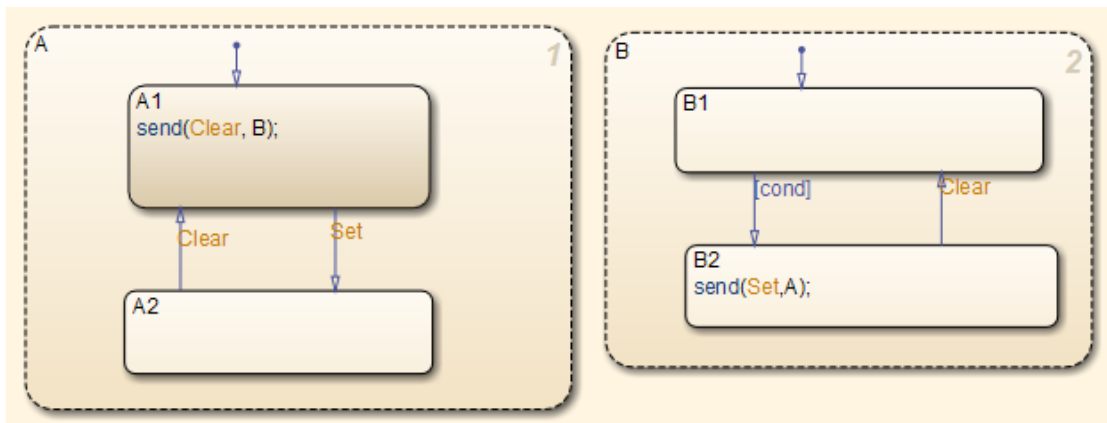

If you change the `send` function calls to use directed event broadcasts so that the **Set** and **Clear** events are broadcast directly to the states B1 and A1, respectively, the cyclic behavior disappears and the software can analyze the model.

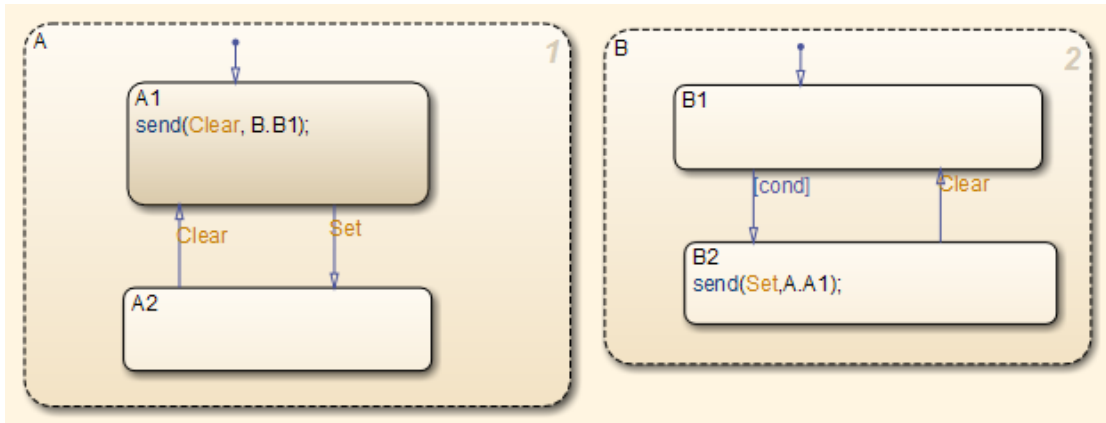

---

**Note:** For information about the benefits of directed event broadcasts, see “Broadcast Events to Synchronize States” (Stateflow) in the Stateflow documentation.

---

## Custom C or C++ Code

The software does not support custom C or C++ code, which the Stateflow software allows.

## Machine-Parented Data

The software does not support machine-parented data (i.e., defined at the level of the Stateflow machine), which the Stateflow software allows.

For more information, see “Best Practices for Using Data in Charts” (Stateflow) in the Stateflow documentation.

## Textual Functions with Literal String Arguments

The software does not support literal string arguments to textual functions in a Stateflow chart.



# Enumerations and Modeling

---

- “Simulink Enumerations” on page 58-2
- “Use Enumerated Data in Simulink Models” on page 58-7

## Simulink Enumerations

*Enumerated data* is data that is restricted to a finite set of values. An *enumerated data type* is a MATLAB class that defines a set of *enumerated values*. Each enumerated value consists of an *enumerated name* and an *underlying integer* which the software uses internally and in generated code.

Before you begin to use enumerations in a modeling context, you should understand information provided in “Enumerations” (MATLAB).

To define an enumeration for use in Simulink models, choose one of these techniques:

- Use the function `Simulink.defineIntEnumType`. The enumeration exists for the duration of your MATLAB session.
- Create a permanent enumeration class by subclassing one of these built-in classes:
  - Many of the built-in integer data types such as `int8` and `uint16`
  - `Simulink.IntEnumType`
- Use the function `Simulink.importExternalCTypes` to create a Simulink representation of an enumerated data type (`enum`) that your external C code defines.

Use this technique to help you:

- Replace existing C code with a Simulink model.
- Integrate existing C code for simulation in Simulink (for example, by using the Legacy Code Tool).
- Generate C code (Simulink Coder) that you can compile with existing C code into a single application.

For more information, see “Define Simulink Enumerations” on page 58-7.

The following examples show how to use enumerations in Simulink and Stateflow.

Example	Shows How To Use...
Data Typing in Simulink	Data types in Simulink, including enumerated data types
Modeling a CD Player/Radio Using Enumerated Data Types	Enumerated data types in a Simulink model that contains a Stateflow chart



For information on using enumerations in Stateflow, see “Enumerated Data” (Stateflow).

## Simulink Constructs that Support Enumerations

- “Overview” on page 58-3
- “Block Support” on page 58-3
- “Class Support” on page 58-5
- “Logging Enumerated Data” on page 58-5
- “Importing Enumerated Data” on page 58-5

### Overview

In general, all Simulink tools and constructs support enumerated types for which the support makes sense given the purpose of enumerated types: to represent program states and to control program logic. The Simulink Editor, Simulink Debugger, Port Value Displays, referenced models, subsystems, masks, buses, data logging, and most other Simulink capabilities support enumerated types without imposing any special requirements.

Enumerated types are not intended for mathematical computation, so no block that computes a numeric output (as distinct from passing a numeric input through to the output) supports enumerated types. Thus an enumerated type is not considered to be a numeric type, even though an enumerated value has an underlying integer. See “Enumerated Values in Computation” on page 58-22 for more information.

Most capabilities that do not support enumerated types obviously could not support them. Therefore, the Simulink documentation usually mentions enumerated type nonsupport only where necessary to prevent a misconception or describe an exception. See “Simulink Enumeration Limitations” on page 58-5 for information about certain constructs that could support enumerated types but do not.

### Block Support

The following Simulink blocks support enumerated types:

- Constant (but Enumerated Constant is preferable)
- Data Type Conversion
- Data Type Conversion Inherited
- Data Type Duplicate

- Display
- MATLAB Function
- Enumerated Constant
- Floating Scope
- From File
- From Workspace
- Inport
- Interval Test
- Interval Test Dynamic
- Multiport Switch
- Outport
- Probe (input only)
- Relational Operator
- Relay (output only)
- Repeating Sequence Stair
- Scope
- Signal Specification
- Switch
- Switch Case
- To File
- To Workspace

All members of the following categories of Simulink blocks support enumerated types:

- Bus-capable blocks (see “Bus-Capable Blocks” on page 63-43)
- Pass-through blocks:
  - With state, like the Data Store Memory and Unit Delay blocks.
  - Without state, like the Mux block.

Many Simulink blocks in addition to those named above support enumerated types, but they either belong to one of the categories listed above, or are rarely used with enumerated types. The Data Type Support section of each block reference page describes all data types that the block supports.

## Class Support

The following Simulink classes support enumerated types:

- `Simulink.Signal`
- `Simulink.Parameter`
- `Simulink.AliasType`
- `Simulink.BusElement`

## Logging Enumerated Data

Root-level outports, To Workspace blocks, and Scope blocks can all export enumerated values. Signal and State logging work with enumerated data in the same way as with any other data. All logging formats are supported. The From File block does not support enumerated data. Use the From Workspace block instead, combined with some technique for transferring data between a file and a workspace. See “Save Runtime Data from Simulation” for more information.

## Importing Enumerated Data

Root-level inports and From Workspace blocks can output enumerated signals during simulation. Data must be provided in a `Structure`, `Structure with Time`, or `TimeSeries` object. No interpolation occurs for enumerated values between the specified simulation times. From File blocks produce only data of type `double`, so they do not support enumerated types. See “Load Signal Data for Simulation” for more information.

## Simulink Enumeration Limitations

- “Enumerations and Scopes” on page 58-5
- “Enumerated Types for Switch Blocks” on page 58-6
- “Nonsupport of Enumerations” on page 58-6

## Enumerations and Scopes

When a Scope block displays an enumerated signal, the vertical axis displays the names of the enumerated values only if the scope was open during simulation. If you open the Scope block for the first time before any simulation has occurred, or between simulations, the block displays only numeric values. When simulation begins, enumerated names replace the numeric values, and thereafter appear whenever the Scope block is opened.

When a Floating Scope block displays multiple signals, the names of enumerated values appear on the Y axis only if all signals are of the same enumerated type. If the Floating Scope block displays more than one type of enumerated signal, or any numeric signal, no names appear, and any enumerated values are represented by their underlying integers.

### Enumerated Types for Switch Blocks

The control input of a Switch block can be of any data type supported by Simulink. However, the `u2 ~= 0` mode is not supported for enumerations. If the control input has an enumeration, choose one of the following methods to specify the criteria for passing the first input:

- Select `u2 >= Threshold` or `u2 > Threshold` and specify a threshold value of the same enumerated type as the control input.
- Use a Relational Operator block to do the comparison and then feed the Boolean result of this comparison into the control port of the Switch block.

### Nonsupport of Enumerations

The following limitations exist when using enumerated data types with Simulink:

- Packages cannot contain enumeration class definitions.
- The If Action block might support enumerations, but currently does not do so.
- Generated code does not support logging enumerated data.
- Custom Stateflow targets do not support enumerated types.

### See Also

`enumeration` | `Simulink.data.getEnumTypeInfo` |  
`Simulink.defineIntEnumType`

### Related Examples

- “Use Enumerated Data in Simulink Models” on page 58-7
- “Define Enumerations for MATLAB Function Blocks” on page 40-108
- “Use Enumerated Data in Generated Code” (Simulink Coder)
- “Manipulate Enumerations in Data Dictionary” on page 61-18

## Use Enumerated Data in Simulink Models

### In this section...

“Define Simulink Enumerations” on page 58-7

“Simulate with Enumerations” on page 58-14

“Specify Enumerations as Data Types” on page 58-16

“Get Information About Enumerated Data Types” on page 58-17

“Enumeration Value Display” on page 58-18

“Instantiate Enumerations” on page 58-19

“Enumerated Values in Computation” on page 58-22

*Enumerated data* is data that is restricted to a finite set of values. An *enumerated data type* is a MATLAB class that defines a set of *enumerated values*. Each enumerated value consists of an *enumerated name* and an *underlying integer* which the software uses internally and in generated code.

For basic conceptual information about enumerations in Simulink, see “Simulink Enumerations” on page 58-2.

For information about generating code with enumerations, see “Use Enumerated Data in Generated Code” (Simulink Coder).

### Define Simulink Enumerations

To define an enumerated data type that you can use in Simulink models, use one of these methods:

- Define an enumeration class using a `classdef` block in a MATLAB file.
- Use the function `Simulink.defineIntEnumType`. You do not need a script file to define the type. For more information, see the function reference page.
- Use the function `Simulink.importExternalCTypes` to create a Simulink representation of an enumerated data type (`enum`) that your external C code defines.

#### Workflow to Define a Simulink Enumeration Class

- 1 Create a class definition.
- 2 Optionally, customize the enumeration.

- 3 Optionally, save the enumeration in a MATLAB file.
- 4 Optionally, permanently store the enumeration definition in a Simulink data dictionary. See “Permanently Store Enumerated Type Definition” on page 58-14.

### Create Simulink Enumeration Class

To create a Simulink enumeration class, in the class definition:

- Define the class as a subclass of `Simulink.IntEnumType`. You can also base an enumerated type on one of these built-in integer data types: `int8`, `uint8`, `int16`, `uint16`, and `int32`.
- Add an `enumeration` block that specifies enumeration values with underlying integer values.

Consider the following example:

```
classdef BasicColors < Simulink.IntEnumType
    enumeration
        Red(0)
        Yellow(1)
        Blue(2)
    end
end
```

The first line defines an integer-based enumeration that is derived from built-in class `Simulink.IntEnumType`. The enumeration is integer-based because `IntEnumType` is derived from `int32`.

The `enumeration` section specifies three enumerated values.

Enumerated Value	Enumerated Name	Underlying Integer
Red(0)	Red	0
Yellow(1)	Yellow	1
Blue(2)	Blue	2

When defining an enumeration class for use in the Simulink environment, consider the following:

- The name of the enumeration class must be unique among data type names and base workspace variable names, and is case-sensitive.

- Underlying integer values in the `enumeration` section need not be unique within the class and across types.
- Often, the underlying integers of a set of enumerated values are consecutive and monotonically increasing, but they need not be either consecutive or ordered.
- For simulation, an underlying integer can be any `int32` value. Use the MATLAB functions `intmin` and `intmax` to get the limits.
- For code generation, every underlying integer value must be representable as an integer on the target hardware, which may impose different limits. See “Select a System Target File” (Simulink Coder) and “Hardware Implementation Pane” for more information.

For more information on superclasses, see “Convert to Superclass Value” (MATLAB). For information on how enumeration classes are handled when there is more than one name for an underlying value, see “How to Alias Enumeration Names” (MATLAB).

## Customize Simulink Enumeration

### About Simulink Enumeration Customizations

You can customize a Simulink enumeration by implementing specific static methods in the class definition. If you define these methods using the appropriate syntax, you can change the behavior of the class during simulation and in generated code.

The table shows the methods you can implement to customize an enumeration.

Static Method	Purpose	Default Value Without Implementing Method	Custom Return Value	Usage Context
<code>getDefaultValue</code>	Specifies the default enumeration member for the class.	First member specified in the enumeration definition	A character vector containing the name of an enumeration member in the class (see “Instantiate Enumerations” on page 58-19)	Simulation and code generation
<code>getDescription</code>	Specifies a description of the enumeration class.	' '	A character vector containing the description of the type	Code generation

Static Method	Purpose	Default Value Without Implementing Method	Custom Return Value	Usage Context
<code>getHeaderFile</code>	Specifies the name of a header file. The method <code>getDataScope</code> determines the significance of the file.	' '	A character vector containing the name of the header file that defines the enumerated type	Code generation
<code>getDataScope</code>	Specifies whether generated code exports or imports the definition of the enumerated data type. Use the method <code>getHeaderFile</code> to specify the generated or included header file that defines the type.	'Auto'	One of: 'Auto', 'Exported', or 'Imported'	Code generation
<code>addClassNameToEnum</code>	Specifies whether to prefix the class name in generated code.	false	true or false	Code generation

For more examples of these methods as they apply to code generation, see “Customize Enumerated Data Type” (Simulink Coder).

### Specify a Default Enumerated Value

Simulink and related generated code use an enumeration's default value for ground-value initialization of enumerated data when you provide no other initial value. For example, an enumerated signal inside a conditionally executed subsystem that has not yet executed has the enumeration's default value. Generated code uses an enumeration's default value if a safe cast fails, as described in “Type Casting for Enumerations” (Simulink Coder).

Unless you specify otherwise, the default value for an enumeration is the first value in the enumeration class definition. To specify a different default value, add your own `getDefaultValue` method to the `methods` section. The following code shows a shell for the `getDefaultValue` method:



```

function retVal = getDefaultValue()
    % GETDEFAULTVALUE Specifies the default enumeration member.
    % Return a valid member of this enumeration class to specify the default.
    % If you do not define this method, Simulink uses the first member.
    retVal = ThisClass.EnumName;
end

```

To customize this method, provide a value for *ThisClass.EnumName* that specifies the desired default.

- *ThisClass* must be the name of the class within which the method exists.
- *EnumName* must be the name of an enumerated value defined in that class.

For example:

```

classdef BasicColors < Simulink.IntEnumType
    enumeration
        Red(0)
        Yellow(1)
        Blue(2)
    end
    methods (Static)
        function retVal = getDefaultValue()
            retVal = BasicColors.Blue;
        end
    end
end

```

This example defines the default as `BasicColors.Blue`. If this method does not appear, the default value would be `BasicColors.Red`, because that is the first value listed in the enumerated class definition.

The seemingly redundant specification of *ThisClass* inside the definition of that same class is necessary because `getDefaultValue` returns an instance of the default enumerated value, not just the name of the value. The method, therefore, needs a complete specification of what to instantiate. See “Instantiate Enumerations” on page 58-19 for more information.

### Save Enumeration in a MATLAB File

You can define an enumeration within a MATLAB file.

- The name of the definition file must match the name of the enumeration exactly, including case. For example, the definition of enumeration `BasicColors` must reside in a file named `BasicColors.m`. Otherwise, MATLAB will not find the definition.

- You must define each class definition in a separate file.
- Save each definition file on the MATLAB search path. MATLAB searches the path to find a definition when necessary.

To add a file or folder to the MATLAB search path, type `addpath pathname` at the MATLAB command prompt. For more information, see “What Is the MATLAB Search Path?” (MATLAB), `addpath`, and `savepath`.

- You do not need to execute an enumeration class definition to use the enumeration. The only requirement, as indicated in the preceding bullet, is that the definition file be on the MATLAB search path.

### Change and Reload Enumeration Classes

You can change the definition of an enumeration by editing and saving the file that contains the definition. You do not need to inform MATLAB that a class definition has changed. MATLAB automatically reads the modified definition when you save the file. However, the class definition changes do not take full effect if any class instances (enumerated values) exist that reflect the previous class definition. Such instances might exist in the base workspace or might be cached.

The following table explains options for removing instances of an enumeration from the base workspace and cache.

If In Base Workspace...	If In Cache...
Do one of the following: <ul style="list-style-type: none"> <li>• Locate and delete specific obsolete instances.</li> <li>• Delete everything from the workspace by using the <code>clear</code> command.</li> </ul>	<ul style="list-style-type: none"> <li>• Delete obsolete instances by closing all models that you updated or simulated while the previous class definition was in effect.</li> <li>• Clear functions and close models that are caching instances of the class.</li> </ul>

For more information about applying enumeration changes, see “Automatic Updates for Modified Classes” (MATLAB).

### Import Enumerations Defined Externally to MATLAB

If you have enumerations defined externally to MATLAB that you want to import for use within the Simulink environment, you can do so programmatically with calls to one of these functions:

- `Simulink.defineIntEnumType` — Defines an enumeration that you can use in MATLAB as if it is defined by a class definition file. In addition to specifying the enumeration class name and values, each function call can specify:
  - Character vector that describes the enumeration class.
  - Which of the enumeration values is the default.

For code generation, you can specify:

- Header file in which the enumeration is defined for generated code.
- Whether the code generator applies the class name as a prefix to enumeration members — for example, `BasicColors_Red` or `Red`.

As an example, consider the following class definition:

```
classdef BasicColors < Simulink.IntEnumType
    enumeration
        Red(0)
        Yellow(1)
        Blue(2)
    end
    methods (Static = true)
        function retVal = getDescription()
            retVal = 'Basic colors...';
        end
        function retVal = getDefaultValue()
            retVal = BasicColors.Blue;
        end
        function retVal = getHeaderFile()
            retVal = 'mybasiccolors.h';
        end
        function retVal = addClassNameToEnumNames()
            retVal = true;
        end
    end
end
```

The following function call defines the same class for use in MATLAB:

```
Simulink.defineIntEnumType('BasicColors', ...
    {'Red', 'Yellow', 'Blue'}, [0;1;2],...
    'Description', 'Basic colors', ...
    'DefaultValue', 'Blue', ...)
```

```
'HeaderFile', 'mybasiccolors.h', ...  
'DataScope', 'Imported', ...  
'AddClassNameToEnumNames', true);
```

- `Simulink.importExternalCTypes` — Creates Simulink representations of enumerated data types (enum) that your existing C code defines.

### Permanently Store Enumerated Type Definition

Whether you define an enumeration by using a class file or by using the function `Simulink.defineIntEnumType`, you can permanently store the enumeration definition in a Simulink data dictionary. Models that are linked to the dictionary can use the enumeration. For more information, see “Enumerations in Data Dictionary” on page 61-14.

### Simulate with Enumerations

Consider the following enumeration class definition — `BasicColors` with enumerated values `Red`, `Yellow`, and `Blue`, with `Blue` as the default value:

```
classdef BasicColors < Simulink.IntEnumType  
    enumeration  
        Red(0)  
        Yellow(1)  
        Blue(2)  
    end  
    methods (Static)  
        function retVal = getDefaultValue()  
            retVal = BasicColors.Blue;  
        end  
    end  
end
```

Once this class definition is known to MATLAB, you can use the enumeration in Simulink and Stateflow models. Information specific to enumerations in Stateflow appears in “Enumerated Data” (Stateflow). The following Simulink model uses the enumeration defined above:

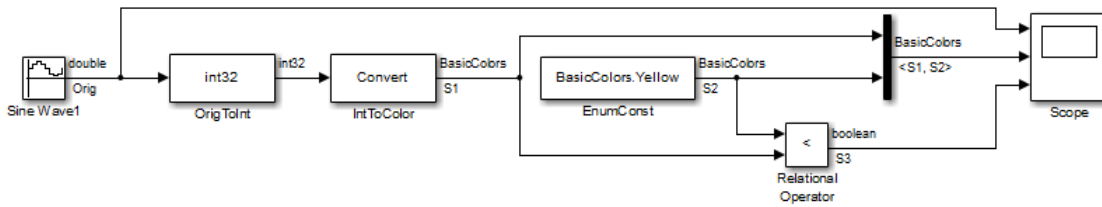

The output of the model looks like this:

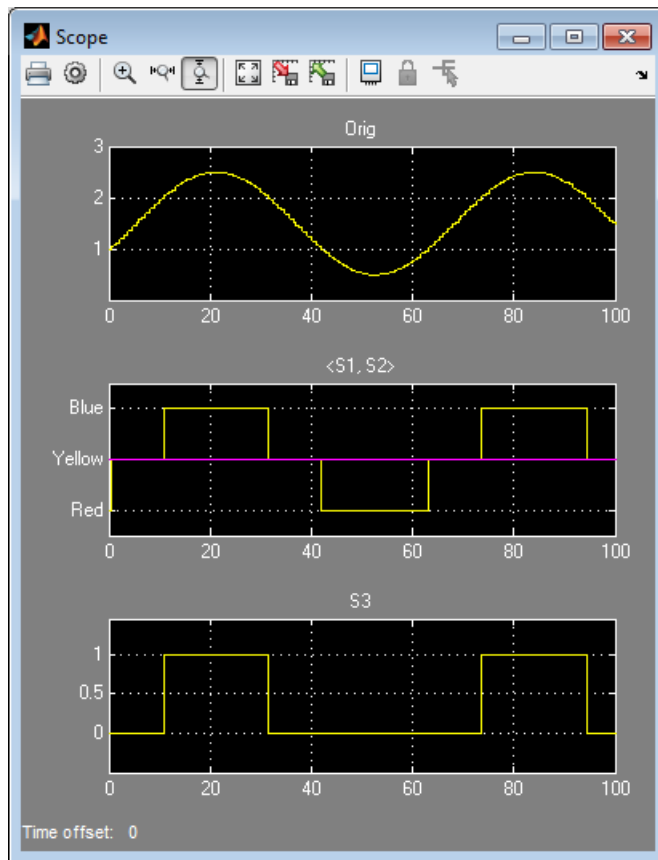

The Data Type Conversion block **OrigToInt** specifies an **Output data type** of **int32** and **Integer rounding mode: Floor**, so the block converts the Sine Wave block output,

which appears in the top graph of the Scope display, to a cycle of integers: 1, 2, 1, 0, 1, 2, 1. The Data Type Conversion block **IntToColor** uses these values to select colors from the enumerated type **BasicColors** by referencing their underlying integers.

The result is a cycle of colors: **Yellow**, **Blue**, **Yellow**, **Red**, **Yellow**, **Blue**, **Yellow**, as shown in the middle graph. The Enumerated Constant block **EnumConst** outputs **Yellow**, which appears in the second graph as a straight line. The Relational Operator block compares the constant **Yellow** to each value in the cycle of colors. It outputs 1 (**true**) when **Yellow** is less than the current color, and 0 (**false**) otherwise, as shown in the third graph.

The sort order used by the comparison is the numeric order of the underlying integers of the compared values, *not* the lexical order in which the enumerated values appear in the enumerated class definition. In this example the two orders are the same, but they need not be. See “Specify Enumerations as Data Types” on page 58-16 and “Enumerated Values in Computation” on page 58-22 for more information.

## Specify Enumerations as Data Types

Once you define an enumeration, you can use it much like any other data type. Because an enumeration is a class rather than an instance, you must use the prefix **?** or **Enum:** when specifying the enumeration as a data type. You must use the prefix **?** in the MATLAB Command Window. However, you can use either prefix in a Simulink model. **Enum:** has the same effect as the **?** prefix, but **Enum:** is preferred because it is more self-explanatory in the context of a graphical user interface.

Depending on the context, type **Enum:** followed by the name of an enumeration, or select **Enum: <class name>** from a menu (for example, for the **Output data type** block parameter), and replace **<class name>**.

To use the Data Type Assistant, set the **Mode** to **Enumerated**, then enter the name of the enumeration. For example, in the previous model, the Data Type Conversion block **IntToColor**, which outputs a signal of type **BasicColors**, has the following output signal specification:

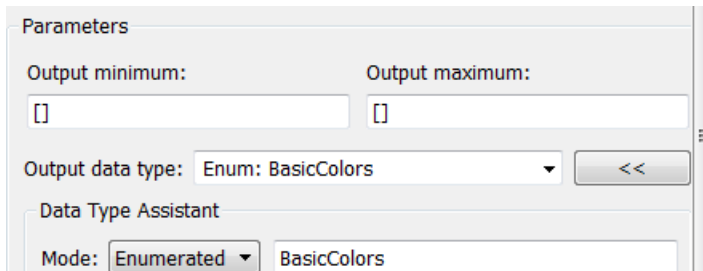

You cannot set a minimum or maximum value for a signal defined as an enumeration, because the concepts of minimum and maximum are not relevant to the purpose of enumerations. If you change the minimum or maximum for a signal of an enumeration from the default value of [ ], an error occurs when you update the model. See “Enumerated Values in Computation” on page 58-22 for more information.

## Get Information About Enumerated Data Types

The functions `enumeration` and `Simulink.data.getEnumTypeInfo` return information about enumerated data types.

### Get Information About Enumeration Members

Use the function `enumeration` to:

- Return an array that contains all enumeration values for an enumeration class in the MATLAB Command Window
- Get the enumeration values programmatically
- Provide the values to a Simulink block parameter that accepts an array or vector of enumerated values, such as the **Case conditions** parameter of the Switch Case block

### Get Information About Enumerated Class

Use the function `Simulink.data.getEnumTypeInfo` to return information about an enumeration class, such as:

- The default enumeration member
- The name of the header file that defines the type in generated code
- The data type used in generated code to store the integer values underlying the enumeration members

## Enumeration Value Display

Wherever possible, Simulink displays enumeration values by name, not by the underlying integer value. However, the underlying integers can affect value display in Scope and Floating Scope blocks.

Block...	Affect on Value Display...
Scope	When displaying an enumerated signal, the names of the enumerated values appear as labels on the Y axis. The names appear in the order given by their underlying integers, with the lowest value at the bottom.
Floating Scope	When displaying signals that are of the same enumeration, names appear on the Y axis as they would for a Scope block. If the Floating Scope block displays mixed data types, no names appear, and any enumerated values are represented by their underlying integers.

### Enumerated Values with Non-Unique Integers

More than one value in an enumeration can have the same underlying integer value, as described in “Specify Enumerations as Data Types” on page 58-16. When this occurs, the value on an axis of Scope block output or in Display block output always is the first value listed in the enumerated class definition that has the shared underlying integer. For example:



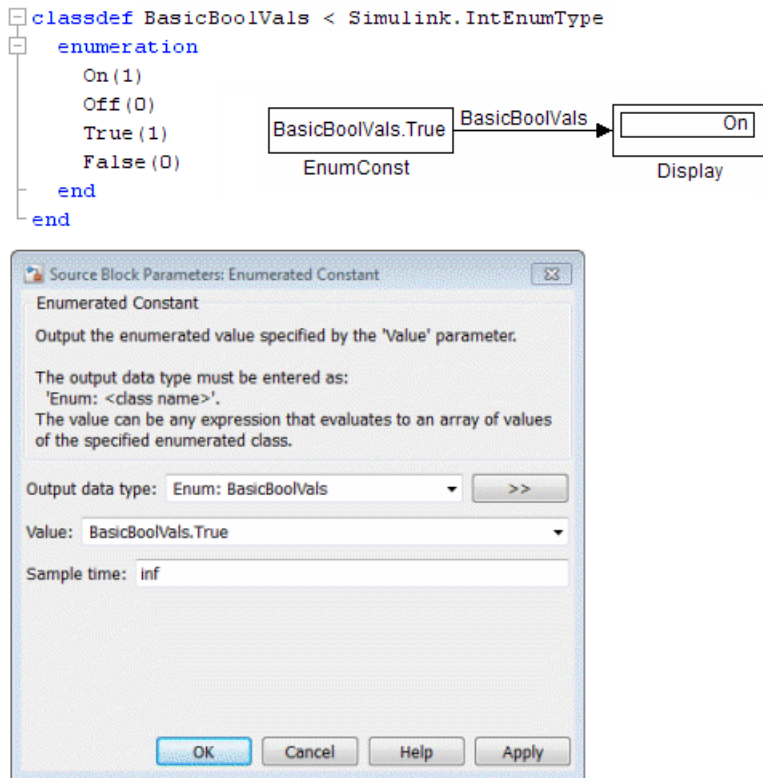

Although the Enumerated Constant block outputs `True`, both `On` and `True` have the same underlying integer, and `On` is defined first in the class definition `enumeration` section. Therefore, the `Display` block shows `On`. Similarly, a `Scope` axis would show only `On`, never `True`, no matter which of the two values is input to the `Scope` block.

## Instantiate Enumerations

Before you can use an enumeration, you must instantiate it. You can instantiate an enumeration in MATLAB, in a Simulink model, or in a Stateflow chart. The syntax is the same in all contexts.

### Instantiating Enumerations in MATLAB

To instantiate an enumeration in MATLAB, enter `ClassName.EnumName` in the MATLAB Command Window. The instance is created in the base workspace. For

example, if `BasicColors` is defined as in “Create Simulink Enumeration Class” on page 58-8, you can type:

```
bcy = BasicColors.Yellow  
  
bcy =  
    Yellow
```

Tab completion works for enumerations. For example, if you enter:

```
bcy = BasicColors.<tab>
```

MATLAB displays the elements and methods of `BasicColors` in alphabetical order:

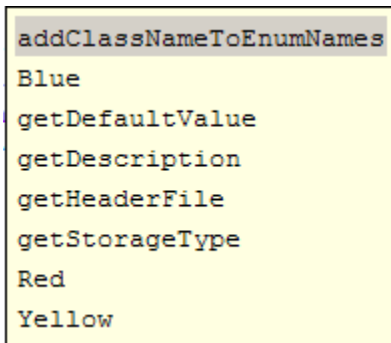
A screenshot of a MATLAB tab completion menu. The menu is a vertical list of items, with the first item, 'addClassNameToEnumNames', highlighted in a grey background. The other items are 'Blue', 'getDefaultValue', 'getDescription', 'getHeaderFile', 'getStorageType', 'Red', and 'Yellow'. The menu is enclosed in a thin black border.

```
addClassNameToEnumNames  
Blue  
getDefaultValue  
getDescription  
getHeaderFile  
getStorageType  
Red  
Yellow
```

Double-click an element or method to insert it at the position where you pressed `<tab>`. See “Tab Completion” (MATLAB) for more information.

### **Casting Enumerations in MATLAB**

In MATLAB, you can cast directly from an integer to an enumerated value:

```
bcb = BasicColors(2)  
  
bcb =  
    Blue
```

You can also cast from an enumerated value to its underlying integer:

```
>> bci = int32(bcb)
```

```
bci =
     2
```

In either case, MATLAB returns the result of the cast in a 1x1 array of the relevant data type.

Although casting is possible, use of enumeration values is not robust in cases where enumeration values and the integer equivalents defined for an enumeration class might change.

### Instantiating Enumerations in Simulink (or Stateflow)

To instantiate an enumeration in a Simulink model, you can enter *ClassName.EnumName* as a value in a dialog box. For example, consider the following model:

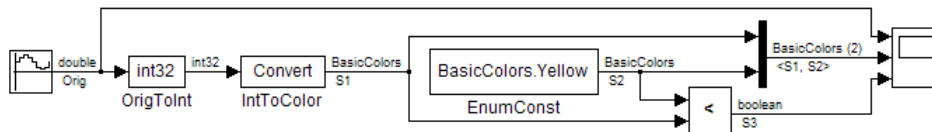

The Enumerated Constant block **EnumConst**, which outputs the enumerated value **Yellow**, defines that value as follows:

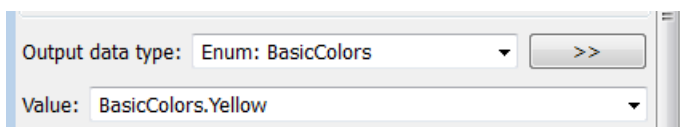

You can enter any valid MATLAB expression that evaluates to an enumerated value, including arrays and workspace variables. For example, you could enter `BasicColors(1)`, or if you had previously executed `bcy = BasicColors.Yellow` in the MATLAB Command Window, you could enter `bcy`. As another example, you could enter an array, such as `[BasicColors.Red, BasicColors.Yellow, BasicColors.Blue]`.

You can use a Constant block to output enumerated values. However, that block displays parameters that do not apply to enumerated types, such as **Output Minimum** and **Output Maximum**.

If you create a `Simulink.Parameter` object as an enumeration, you must specify the **Value** parameter as an enumeration member and the **Data type** with the `Enum:` or ? prefix, as explained in “Specify Enumerations as Data Types” on page 58-16.

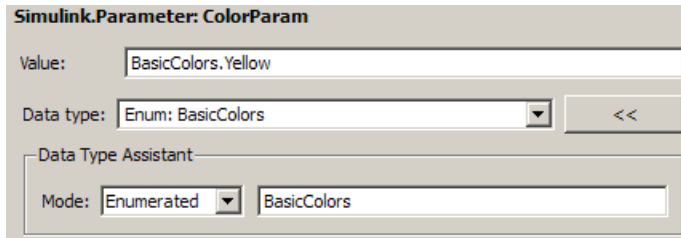

You *cannot* specify the integer value of an enumeration member for the **Value** parameter. See “Enumerated Values in Computation” on page 58-22 for more information. Thus, the following fails even though the integer value for `BasicColors.Yellow` is 1.

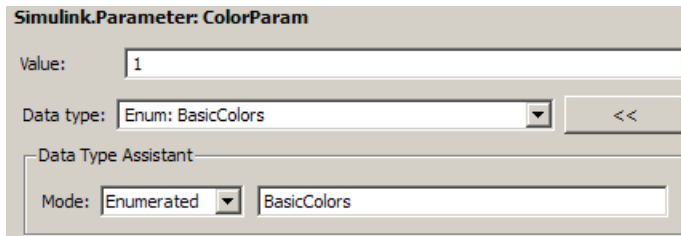

The same syntax and considerations apply in Stateflow. See “Enumerated Data” (Stateflow) for more information.

## Enumerated Values in Computation

By design, Simulink prevents enumerated values from being used as numeric values in mathematical computation, even though an enumerated class is a subclass of the MATLAB `int32` class. Thus, an enumerated type does not function as a numeric type despite the existence of its underlying integers. For example, you cannot input an enumerated signal directly to a Gain block.

You can use a Data Type Conversion block to convert in either direction between an integer type and an enumerated type, or between two enumerated types. That is, you

can use a Data Type Conversion block to convert an enumerated signal to an integer signal (consisting of the underlying integers of the enumerated signal values) and input the resulting integer signal to a Gain block. See “Casting Enumerated Signals” on page 58-23 for more information.

Enumerated types in Simulink are intended to represent program states and control program logic in blocks like the Relational Operator block and the Switch block. When a Simulink block compares enumerated values, the values compared must be of the same enumerated type. The block compares enumerated values based on their underlying integers, not their order in the enumerated class definition.

When a block like the Switch block or Multiport Switch block selects among multiple data signals, and any data signal is of an enumerated type, all the data signals must be of that same enumerated type. When a block inputs both control and data signals, as Switch and Multiport Switch do, the control signal type need not match the data signal type.

### Casting Enumerated Signals

You can use a Data Type Conversion block to cast an enumerated signal to a signal of any numeric type, provided that the underlying integers of all enumerated values input to the block are within the range of the numeric type. Otherwise, an error occurs during simulation.

Similarly, you can use a Data Type Conversion block to cast a signal of any integer type to an enumerated signal, provided that every value input to the Data Type Conversion block is the underlying integer of some value in the enumerated type. Otherwise, an error occurs during simulation.

You cannot use a Data Type Conversion block to cast a numeric signal of any non-integer data type to an enumerated type. For example, the model used in “Simulate with Enumerations” on page 58-14 needed two Data Conversion blocks to convert a sine wave to enumerated values.

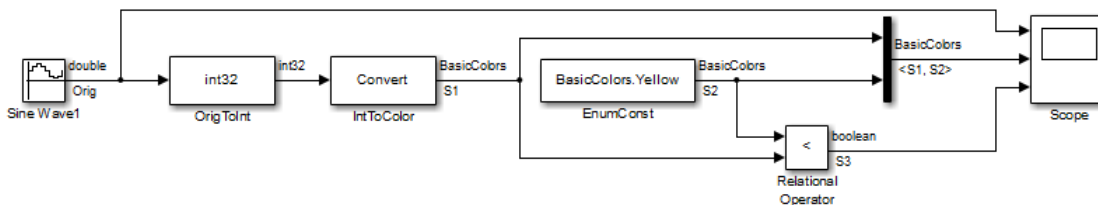

The first block casts `double` to `int32`, and the second block casts `int32` to `BasicColors`. You cannot cast a complex signal to an enumerated type regardless of the data types of its real and imaginary parts.

### Casting Enumerated Block Parameters

You cannot cast a block parameter of any numeric data type to an enumerated data type. For example, suppose that an Enumerated Constant block specifies a **Value** of 2 and an **Output data type** of Enum: `BasicColors`:

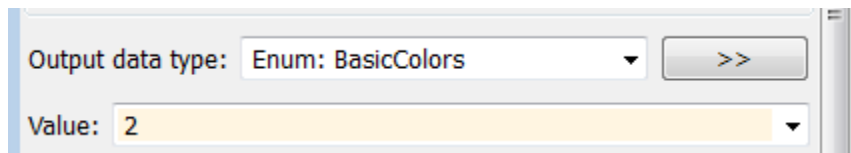

An error occurs because the specifications implicitly cast a `double` value to an enumerated type. The error occurs even though the numeric value corresponds arithmetically to one of the enumerated values in the enumerated type.

You cannot cast a block parameter of an enumeration to any other data type. For example, suppose that a Constant block specifies a **Constant value** of `BasicColors.Blue` and an **Output data type** of `int32`.

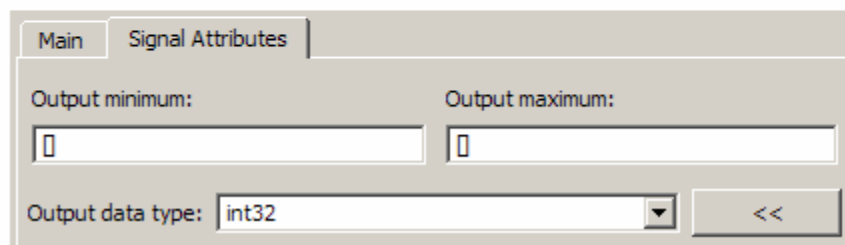

An error occurs because the specifications implicitly cast an enumerated value to a numeric type. The error occurs even though the enumerated value's underlying integer is a valid `int32`.

## See Also

`enumeration` | `Simulink.data.getEnumTypeInfo` |  
`Simulink.defineIntEnumType`

## Related Examples

- “Define Enumerations for MATLAB Function Blocks” on page 40-108
- “Define Enumerated Data in a Chart” (Stateflow)
- “Use Enumerated Data in Generated Code” (Simulink Coder)
- “Simulink Enumerations” on page 58-2
- “Manipulate Enumerations in Data Dictionary” on page 61-18





# Importing and Exporting Simulation Data

---

- “Export Simulation Data” on page 59-4
- “Provide Signal Data for Simulation” on page 59-10
- “Signal Data Storage for Loading” on page 59-13
- “Data Format for Logged Simulation Data” on page 59-18
- “Dataset Conversion for Logged Data” on page 59-24
- “Convert Logged Data to Dataset Format” on page 59-28
- “Log Signal Data That Uses Units” on page 59-40
- “Limit Amount of Exported Data” on page 59-43
- “Working with Big Data for Simulations” on page 59-46
- “Log Data to Persistent Storage” on page 59-49
- “Load Big Data for Simulations” on page 59-54
- “Analyze Big Data from a Simulation” on page 59-62
- “Samples to Export for Variable-Step Solvers” on page 59-66
- “Export Signal Data Using Signal Logging” on page 59-70
- “Configure a Signal for Logging” on page 59-73
- “View the Signal Logging Configuration” on page 59-81
- “Enable Signal Logging for a Model” on page 59-88
- “Override Signal Logging Settings” on page 59-92
- “Access Signal Logging Data” on page 59-106
- “Log Signals in For Each Subsystems” on page 59-111
- “Overview of Signal Loading Techniques” on page 59-116
- “Comparison of Signal Loading Techniques” on page 59-124
- “Map Data Using Root Inport Mapper Tool” on page 59-132

- “Log Simulation Data for Roundtrip Data Loading” on page 59-138
- “Import Data to Model a Continuous Plant” on page 59-140
- “Import Data to Test a Discrete Algorithm” on page 59-143
- “Import Data for an Input Test Case” on page 59-145
- “Specify Data for Root-Level Input Ports” on page 59-149
- “Create Data for a From File Block” on page 59-153
- “Create Data for a From Workspace Block” on page 59-157
- “Load Signal Logging Data” on page 59-162
- “Load Data to Root-Level Input Ports” on page 59-164
- “Import Bus Data to Top-Level Input Ports” on page 59-166
- “Map Root Inport Signal Data” on page 59-178
- “Create Signal Data for Root Inport Mapping” on page 59-181
- “Import Signal Data for Root Inport Mapping” on page 59-187
- “View and Inspect Signal Data” on page 59-191
- “Create and Edit Signal Data” on page 59-194
- “Map Signal Data to Root Inports” on page 59-210
- “Preview Signal Data” on page 59-226
- “Generate MATLAB Scripts for Simulation with Scenarios” on page 59-229
- “Create and Use Custom Map Modes” on page 59-230
- “Root Inport Mapping Scenarios” on page 59-233
- “Load Signal Data That Uses Units” on page 59-237
- “Load Data Using the From File Block” on page 59-239
- “Load Data Using the From Workspace Block” on page 59-242
- “Create Dataset Data for Root Inport Ports” on page 59-245
- “Create MATLAB Timeseries Data for Root Inports” on page 59-248
- “Create Data Arrays for Root-Level Inports” on page 59-250
- “Create MATLAB Time Expressions for Root Inports” on page 59-254
- “Create Data Structures for Root Inports” on page 59-255
- “State Information” on page 59-261
- “Save State Information” on page 59-267

- “Load State Information” on page 59-271

## Export Simulation Data

**In this section...**

“Simulation Data” on page 59-4

“Approaches for Exporting Signal Data” on page 59-5

“Enable Simulation Data Export” on page 59-7

“View Logged Data Using Simulation Data Inspector” on page 59-8

“Memory Performance” on page 59-8

Exporting (logging) simulation data provides a baseline for analyzing and debugging a model. Use standard or custom MATLAB functions to generate simulated system input signals and to graph, analyze, or otherwise postprocess the system outputs.

### Simulation Data

Simulation data can include any combination of signal, time, output, state, and data store logging data.

Exporting simulation data involves saving signal values to the MATLAB workspace or to a MAT-file during simulation for later retrieval and postprocessing. Exporting data is also known as “data logging” or “saving simulation data.”

You can have data logged in different formats:

- Array
- Structure
- Structure with time
- MATLAB timeseries
- `ModelDataLogs`

---

**Note:** The `ModelDataLogs` class is supported for backwards compatibility. Starting in R2016a, you cannot log data in the `ModelDataLogs` format. Signal logging uses the `Dataset` format. In R2016a or later, when you open a model from an earlier release that had used `ModelDataLogs` format, the model simulated in use `Dataset` format.

---

Consider converting this data to the **Dataset** format, which can simplify the post-processing of data. For more information, see “Dataset Conversion for Logged Data” on page 59-24.

You can also import the exported data to use as input for simulating a model.

## Approaches for Exporting Signal Data

Exporting simulation data often involves exporting signal data. You can use various approaches for exporting signal data.

Export Approach	Usage	Documentation
Connect a Scope block or viewer to a signal.	<p>If you use a Scope block for viewing results during simulation, consider also using the Scope block to export data.</p> <p>Save output at a sample rate other than the base sample rate.</p> <p>Scopes store data and can be memory intensive.</p>	Scope
Connect a signal to a To File block.	<p>Consider using a To File block for exporting large amounts of data.</p> <p>Save output at a sample rate other than the base sample rate.</p> <p>Use the MAT-file only after the simulation has completed.</p>	To File
Connect a signal to a To Workspace block.	<p>Document in the diagram the workspace variables used to store signal data.</p> <p>Save output at a sample rate other than the base sample rate.</p>	To Workspace

Export Approach	Usage	Documentation
Connect a signal to a root-level Output block.	Consider using this approach for logging data in a top-level model, if the model already includes an Output block.	Output
Set the signal logging properties for a signal.	<p>Use signal logging to avoid adding blocks.</p> <p>Log signals based on individual signal rates.</p> <p>Data is available only when simulation is paused or completed.</p> <p>Use signal logging to log array of buses signals.</p>	“Export Signal Data Using Signal Logging” on page 59-70
Configure Simulink to export time, state, and output data.	<p>To capture complete information about the simulation as a whole, consider exporting this data.</p> <p>Outputs and states are logged at the base sample rate of the model.</p>	<p>“Data Format for Logged Simulation Data” on page 59-18</p> <p>“Limit Amount of Exported Data” on page 59-43</p> <p>“Samples to Export for Variable-Step Solvers” on page 59-66</p>
Log a data store.	Log a data store to share data throughout a model hierarchy, capturing the order of all data store writes.	“Log Data Stores” on page 60-39

Export Approach	Usage	Documentation
Use the <code>sim</code> command to log simulation data programmatically.	Use <code>sim</code> to export to one data object the time, states, and signal simulation data.  Select the <b>Return as single object</b> parameter when simulating the model using the <code>sim</code> command inside a function or a <code>parfor</code> loop.	<code>sim</code>

## Enable Simulation Data Export

To export the states and root-level output ports of a model to the MATLAB base workspace during simulation of the model, use one of these interfaces:

- **Configuration Parameters > Data Import/Export** pane (for details, see “Model Configuration Parameters: Data Import/Export”)
- `sim` command

In both approaches, specify:

- The kinds of simulation data that you want to export:
  - Signal logging
  - Time
  - Output
  - State or final state
  - Data store

Each kind of simulation data export has an associated default variable. You can specify your own variables for the exported data.

- The characteristics of the logged data, including:
  - “Data Format for Logged Simulation Data” on page 59-18
  - “Limit Data Logged” on page 59-77
  - “Samples to Export for Variable-Step Solvers” on page 59-66

## View Logged Data Using Simulation Data Inspector

To inspect exported simulation data interactively, consider using the Simulation Data Inspector on page 27-41.

The Simulation Data Inspector has some limitations on the kinds of logged data that it displays. See “Limitations of the Simulation Data Inspector” on page 27-57.

## Memory Performance

### Optimization for Logged Data

When exporting simulation data in a simulation mode other than Rapid Accelerator, Simulink optimizes memory usage in the following situations.

- When time steps happen at regular intervals, Simulink uses compressed time representation. Simulink stores the value for the first timestamp, the length of the interval (time step), and the total number of timestamps.
- When multiple signals use identical sequences of timestamps, the signals share a single stored timestamp sequence. Sharing a single stored timestamp can reduce memory use for logged data by as much as a factor of two. An example when this memory performance can be a critical performance factor is when logging bus signals that have thousands of bus elements.

### Logging to Persistent Storage

You can encounter memory issues when you log a large number of signals in a long simulation that has many time steps. Logging to persistent storage can address this kind of memory issue.

To log to persistent storage, in the **Configuration Parameters > Data Import/Export** pane, select **Log Dataset data to file** option. Specify the kinds of logging (for example, signal logging and states logging).

- For logging output and states data, set the **Format** parameter to **Dataset**.
- If you select the **Final states** parameter, clear the **Save complete SimState in final state** parameter.

Using a `Simulink.SimulationData.DatasetRef` object to access signal logging and states logging data loads data into the model workspace incrementally. Accessing data for other kinds of logging loads all of the data at once.



For details, see “Log Data to Persistent Storage” on page 59-49.

## See Also

### Blocks

Outport | Scope | To File | To Workspace

### Functions

sim

## Related Examples

- “Log Simulation Data for Roundtrip Data Loading” on page 59-138
- “Data Format for Logged Simulation Data” on page 59-18
- “Limit Amount of Exported Data” on page 59-43
- “Log Data to Persistent Storage” on page 59-49

## More About

- “Overview of Signal Loading Techniques” on page 59-116
- “Comparison of Signal Loading Techniques” on page 59-124
- “Data Format for Logged Simulation Data” on page 59-18
- “Signal Data Storage for Loading” on page 59-13
- Simulation Data Inspector on page 27-41

## Provide Signal Data for Simulation

### In this section...

“Identify Model Signal Data Requirements” on page 59-10

“Load Input Signal Data” on page 59-11

“Log Output Signal Data” on page 59-11

A Simulink model performs algorithms on input signal data and produces output signals. The model defines what input data to use at the start of simulation and what output to capture at the end of simulation. As you create and simulate your model, you:

- 1 “Identify Model Signal Data Requirements” on page 59-10
- 2 “Load Input Signal Data” on page 59-11
- 3 “Log Output Signal Data” on page 59-11

As you create, debug, and test a model, you can use different sets of input signal data for simulation. You can use logged simulation data as input to another simulation.

### Identify Model Signal Data Requirements

To use system-generated signal data, use source blocks such as a Sine Wave block. Source blocks do not require the use of a variable or external data source. If you cannot configure source blocks to meet your modeling requirements, then you need to supply the signal data.

As you determine your signal data requirements, identify the:

- Blocks (including subsystems and Model blocks) you need to provide data for — Design interfaces for blocks and for model components, including data types of signals.
- Range characteristics of signals, such as sample time, dimensions, and data type.
- Storage location for data for each input signal — Determine where to store signal data: in workspace variables, a MAT-file, or an external data file such as an Microsoft Excel spreadsheet.

Create a list of equation variables and constant coefficients, and then determine the coefficient values from published sources or by performing experiments on the system.

For an example of identifying model signal data requirements, see “Model a Dynamic System” Model a Dynamic System. For information about storage locations for signal data, see “Signal Data Storage for Loading” on page 59-13.

## Load Input Signal Data

You can use a variety of sources for input signal data for simulating a model. You can:

- Use existing data from a file, such as a spreadsheet.
- Write a MATLAB script to define variables for the signal data. For example, you can create **Dataset** format data that you can use with all the signal loading techniques.
- Use data logged from a previous simulation.

You can use several different approaches to load data into a model, including:

- Root-level input ports — Import signal data from a workspace, using the **Input** configuration parameter to import it to a root-level input port of a **Inport**, **Enable**, or **Trigger** block. To import multiple signals to root-level input ports, consider using the **Root Inport Mapping** tool on page 59-132, which updates the **Input** parameter based on the signal data that you import and map to root-level input ports.
- Source blocks — Add a source block, such as **Sine Wave** block, to generate signals to input to another block.
- From File block — Read data from a MAT-file, outputting the data as a signal.
- From Spreadsheet block — Read data from Microsoft Excel spreadsheets or CSV spreadsheets, outputting the data as one or more signals.
- Signal Builder block — Create interchangeable groups of piecewise linear signal sources to use in a model.

To determine the approach to meet the input signal data requirements of your model, see “Comparison of Signal Loading Techniques” on page 59-124.

## Log Output Signal Data

You can save signal values to the MATLAB workspace or to a MAT-file during simulation for later retrieval and postprocessing. Saving simulation data is also known as logging or exporting simulation data

To determine which approach to use for logging signal data, see “Export Simulation Data” on page 59-4.

Saving simulation data in **Dataset** format simplifies postprocessing by providing a common format for the results of a variety of logging techniques. Using **Dataset** format stores the data as MATLAB **timeseries** objects, which you can process with MATLAB. Simulink provides tools for converting data logged in other formats to **Dataset** format.

For more information about logging output signal data, see “Save Runtime Data from Simulation”.

## See Also

### Blocks

From File | From Spreadsheet | From Workspace | Signal Builder | To File | To Workspace

## Related Examples

- “Model a Dynamic System”
- “Signal Data Storage for Loading” on page 59-13
- “Comparison of Signal Loading Techniques” on page 59-124
- “Map Data Using Root Inport Mapper Tool” on page 59-132
- “Export Simulation Data” on page 59-4

## Signal Data Storage for Loading

### In this section...

“MATLAB Workspace for Signal Data” on page 59-13

“Source and Signal Builder Blocks for Signal Data” on page 59-14

“MAT-Files for Signal Data” on page 59-15

“Spreadsheets for Signal Data” on page 59-15

Store signal data for loading into a model in these locations:

- MATLAB (base) workspace, or function workspace
- Model workspace
- Function workspace
- Masking workspace
- Blocks
- MAT-files
- Spreadsheets

The MATLAB (base) workspace is the most common workspace to use for loading signal data.

### MATLAB Workspace for Signal Data

Consider using the MATLAB (base) workspace when you want to:

- Use a small amount of signal data for iterative simulations.
- Use signal data logged during one simulation as input for another simulation.
- Have multiple models use the same signal data.

### Create Signal Data in the MATLAB Workspace

- At the MATLAB command line or editor, create the signal data.
- Use the `xlsread` function to read data from an Excel spreadsheet into the MATLAB workspace.
- Use the `csvread` function to read data from a CSV spreadsheet into the MATLAB workspace.

- Use a model callback to load signal data.
- Use one of these Simulink logging techniques:
  - Signal logging
  - To Workspace block
  - Scope block
  - The **Configuration Parameters > Data Import/Export** pane, the **Output**, **States**, or **Final states** parameters.
  - Data store
  - The `sim` command configured to log simulation data

### Load Signal Data from the MATLAB Workspace

To load signal data from a workspace, use one of these techniques:

- Add a From Workspace block.
- Use a root-level input port.
  - Specify workspace variables in the **Configuration Parameters > Data Import/Export > Input** parameter.
  - Use the Root Import Mapper tool to specify the data for the **Input** parameter.

### Source and Signal Builder Blocks for Signal Data

Source blocks, such as the Sine Wave block, generate signals that you can use as inputs to other blocks. Source blocks do not store signal data. Source blocks can be useful for initial prototyping of a model when the generated signal data serves your modeling requirements.

To define signal groups to use as inputs to a model, you can use the Signal Builder block. The Signal Builder block stores the signal group definitions.

Consider using a source block to:

- Avoid having to create the data manually.
- Reduce memory consumption — source blocks do not store signal data.
- Graphically represent in the model the kind of signal data.

Consider using a Signal Builder block to:

- Create and import signal groups for use in testing.

You can use signal groups with Simulink and with these products:

- Simulink Test
- Simulink Verification and Validation
- Switch between signal groups quickly.

## **MAT-Files for Signal Data**

Consider storing signal data in a MAT-file to:

- Load a large amount of signal data efficiently.
- Reuse the same signal data in different models.
- Reduce memory requirements for the model.
- Use different sets of signal data with the same model, with minimal model updates.

### **Store Signal Data in a MAT-File**

To create a MAT-file to store signal data to import, you can use:

- A To File block
- The Root Inport Mapper tool. Export to a MAT-file the signal data that you work on with the tool.
- MATLAB to create signal data that you store in a MAT-file
- `Simulink.saveVars` function to save to a MAT-file the simulation signal data that Simulink stores as workspace variables

### **Load Signal Data from a MAT-File**

To load signal data from a MAT-file into a model, you can use a From File block.

## **Spreadsheets for Signal Data**

Consider using an Excel or CSV spreadsheet to:

- Use an existing spreadsheet that already has the necessary signal data or that you can update easily to contain the signal data.

- Load a large amount of signal data efficiently.
- Reduce memory requirements for the model.
- Use different sets of signal data with the same model, with minimal model updates.
- Share the signal data with other people who do not have Simulink installed.

### **Store Signal Data in a Spreadsheet**

Use one of these approaches:

- Create the signal data directly in the spreadsheet. For spreadsheet requirements, see “Storage Formats” on page 59-154.
- Export MATLAB signal data to an Excel or CSV spreadsheet using the `xlswrite` or `csvwrite` function.

### **Load Signal Data from a Spreadsheet**

Use one of these blocks:

- From Spreadsheet block
- Signal Builder block

The From Spreadsheet and Signal Builder blocks load Microsoft Excel on all platforms. These blocks load CSV spreadsheets only on Microsoft Windows platforms.

The From Spreadsheet incrementally loads the data directly from the spreadsheet, to minimize memory consumption. The Signal Builder block imports all the spreadsheet data into MATLAB memory at one time and saves the data in the block.

## **See Also**

### **Blocks**

From Spreadsheet | Signal Builder | To File | To Workspace

### **Functions**

`csvwrite` | `Simulink.saveVars` | `xlswrite`

## **More About**

- “Comparison of Signal Loading Techniques” on page 59-124
- “Overview of Signal Loading Techniques” on page 59-116



- “Map Root Inport Signal Data” on page 59-178

## Data Format for Logged Simulation Data

### In this section...

“Data Format for Block-Based Logged Data” on page 59-18

“Data Format for Model-Based Logged Data” on page 59-18

“Logged Data Store Format” on page 59-18

“Time, State, and Output Data Format” on page 59-18

### Data Format for Block-Based Logged Data

You can use the Scope, To File, or To Workspace blocks to export simulation data. Each of these blocks has a data format parameter.

### Data Format for Model-Based Logged Data

The data format for model-based exporting of simulation data specifies how Simulink stores the exported data.

Simulink uses different data formats, depending on the kind of data that you export. For details, see:

- “Logged Data Store Format” on page 59-18
- “Time, State, and Output Data Format” on page 59-18

### Logged Data Store Format

When you log data store data, Simulink uses a `Simulink.SimulationData.Dataset` object.

For details, see “Accessing Data Store Logging Data” on page 60-41.

### Time, State, and Output Data Format

For exported time, states, and output data, use one of the following formats:

- “Dataset” on page 59-19 (default)
- “Array” on page 59-19

- “Structure with Time” on page 59-20
- “Structure” on page 59-22

If you select the **Configuration Parameters > Data Import/Export > Output** check box, Simulink logs fixed-point data as double. To log fixed-point data, consider using one of these approaches:

- Signal logging — For details, see “Export Signal Data Using Signal Logging” on page 59-70.
  - 1 In the Simulink Editor, select one or more signals.
  - 2 Click the **Simulation Data Inspector** button arrow  and click **Log Selected Signals to Workspace**.
- To File block
- To Workspace block — In the To Workspace Block Parameters dialog box, enable the **Log fixed-point data as a fi object** parameter.

For information about the format for logged final state data, see “State Information” on page 59-261.

## Dataset

Dataset format:

- Uses MATLAB timeseries objects to store logged data. MATLAB `timeseries` objects allow you to work with logged data in MATLAB without a Simulink license.
- Supports logging multiple data values for a given time step, which can be important for Iterator subsystem and Stateflow signal logging.
- Supports inclusion of units information in logged data for output data
- Does not support logging nonvirtual bus data for code generation or in rapid accelerator mode.

## Array

If you select this **Array** option, Simulink saves the states and outputs of a model in a state and output array, respectively.

The state matrix has the name specified in the **Configuration Parameters > Data Import/Export** pane (for example, `xout`). Each row of the state matrix corresponds to a

time sample of the states of a model. Each column corresponds to an element of a state. For example, suppose that your model has two continuous states, each of which is a two-element vector. Then the first two elements of each row of the state matrix contain a time sample of the first state vector. The last two elements of each row contain a time sample of the second state vector.

The model output matrix has the name specified in the **Configuration Parameters > Data Import/Export** pane (for example, `yout`). Each column corresponds to a model output port, and each row to the outputs at a specific time.

---

**Note:** Use array format to save your model outputs and states only if the logged data meets *all* these conditions:

- Data is all scalars or all vectors (or all matrices for states)
- Data is all real or all complex
- Data all has the same data type

If your model outputs and states do not meet these conditions, use the **Structure or Structure with time** output formats (see “Structure with Time” on page 59-20).

---

### Structure with Time

If you select this format, Simulink saves the model states and outputs in structures that have their names specified in the **Configuration Parameters > Data Import/Export** pane. By default, the structures are `xout` for states and `yout` for output.

The structure used to save outputs has two top-level fields:

- `time`  
Contains a vector of the simulation times.
- `signals`  
Contains an array of substructures, each of which corresponds to a model output port.

Each substructure has four fields:

- `values`  
Contains the outputs for the corresponding output port.

- If outputs are scalars or vectors — **values** field is a matrix each of whose rows represent an output at the time specified by the corresponding time vector element.
- If the outputs are matrix (2-D) values — **values** field is a 3-D array of dimensions M-by-N-by-T. M-by-N is the dimensions of the output signal and T is the number of output samples.
- If T = 1 — MATLAB drops the last dimension. Therefore, the **values** field is an M-by-N matrix.
- **dimensions**

Specifies the dimensions of the output signal.

- **label**

Specifies the label of the signal connected to the output port, S-Function block, or the type of state (continuous or discrete). The label is **DSTATE** or **CSTATE**, except for S-Function block state labels. For S-Function block state labels for discrete states, the label is the name of the state (instead of **DSTATE**).

- **blockName**

Specifies the name of the corresponding output port or block with states.

- **inReferencedModel**

If the **signals** field records the final state of a block that resides in the reference model, contains a value of 1. Otherwise, the value is false (0).

The following example shows the structure-with-time format for a nonreferenced model.

```
xout.signals(1)
```

```
ans =
```

```

        values: [296206x1 double]
  dimensions: 1
         label: 'CSTATE'
    blockName: 'vdp/x1'
inReferencedModel: 0
```

The structure used to save states has a similar organization. The states structure has two top-level fields:

- `time`

The `time` field contains a vector of the simulation times.

- `signals`

The field contains an array of substructures, each of which corresponds to one of the states of the model.

Each `signals` structure has four fields: `values`, `dimensions`, `label`, and `blockName`. The `values` field contains time samples of a state of the block specified by the `blockName` field. The `label` field for built-in blocks indicates the type of state: either `CSTATE` (continuous state) or `DSTATE` (discrete state). For S-Function blocks, the label contains whatever name is assigned to the state by the S-Function block.

The time samples of a state are stored in the `values` field as a matrix of values. Each row corresponds to a time sample. Each element of a row corresponds to an element of the state. If the state is a matrix, the matrix is stored in the `values` array in column-major order. For example, suppose that the model includes a 2-by-2 matrix state and that 51 samples of the state are logged during a simulation run.

The `values` field for this state would contain a 51-by-4 matrix. Each row corresponds to a time sample of the state, and the first two elements of each row correspond to the first column of the sample. The last two elements correspond to the second column of the sample.

---

**Note:** Simulink can read back simulation data saved to the MATLAB workspace in the `Structure with time` output format. See “Examples of Specifying Signal and Time Data” on page 59-258 for more information.

---

### Structure

This format is the same as for `Structure with time` output format, except that Simulink does not store simulation times in the `time` field of the saved structure.

### See Also

`Simulink.SimulationData.Dataset` |  
`Simulink.SimulationData.forEachTimeseries`

## **Related Examples**

- “Export Simulation Data” on page 59-4
- “Log Signal Data That Uses Units” on page 59-40
- “Load Data to Root-Level Input Ports” on page 59-164
- “Load Signal Logging Data” on page 59-162

## **More About**

- “Comparison of Signal Loading Techniques” on page 59-124
- “Dataset Conversion for Logged Data” on page 59-24
- “Map Root Inport Signal Data” on page 59-178
- “State Information” on page 59-261

## Dataset Conversion for Logged Data

### In this section...

“Why Convert to Dataset Format?” on page 59-24

“Results of Conversion” on page 59-25

“Dataset Conversion Limitations” on page 59-27

### Why Convert to Dataset Format?

You can use the `Simulink.SimulationData.Dataset` constructor to convert a MATLAB workspace variable that contains data that was logged in one of these formats to `Dataset` format:

- Array
- Structure
- Structure with time
- MATLAB timeseries
- `ModelDataLogs`

Converting data from other Simulink logging formats to `Dataset` format simplifies writing scripts to post-process data logged. For example, a model with multiple To Workspace blocks can use different data formats. Converting the logged data to `Dataset` format avoids the need to write special code to handle different formats.

Different simulation modes have different levels of support for data logging formats. Switching between normal and accelerator modes can require changes to the logging formats used.

The conversion to `Dataset` format also makes it easier to take advantage of features that require `Dataset` format. You can easily convert data logged in earlier releases that used a format other than `Dataset` to work well with `Dataset` data in a more recent release.

The `Dataset` format:

- Uses MATLAB timeseries objects to store logged data, which allows you to work with logging data in MATLAB without a Simulink license. For example, to manipulate the logged data, you can use MATLAB time-series methods such as `filter`, `detrend`, and `resample`.



- Supports logging multiple data values for a given time step, which is important for Iterator subsystem and Stateflow signal logging.

By default, the resulting `Dataset` object uses the variable name as its name. You can use a Name-Value pair to specify a `Dataset` name.

You can use the `Simulink.SimulationData.Dataset.concat` method to combine `Dataset` objects into one concatenated `Dataset` object.

## Results of Conversion

`Dataset` objects hold data as elements. To display the elements of a `Dataset` variable, enter the variable name at the MATLAB command prompt. The elements of `Dataset` objects are different types, depending on the data they store. For example, signal logging stores data as `Simulink.SimulationData.Signal` elements and state logging in `Dataset` format stores data as `Simulink.SimulationData.State` elements. Each element holds data as a MATLAB time-series object. At conversion, the elements and time-series field populate as much as possible from the converted object.

Format	Conversion Result Notes
MATLAB time series	<p>If you log nonbus data, during conversion, the software first adds the data as a <code>Simulink.SimulationData.Signal</code> object. It then adds that object as an element of the newly created <code>Dataset</code>.</p> <p>If you log bus data in time-series format, one time series corresponds to each element of a bus. Converting arranges the logged data as a structure with time-series objects as leaf nodes. This structure hierarchy matches the bus hierarchy. Conversion of this type of structure of time-series objects adds the whole structure to a <code>Simulink.SimulationData.Signal</code> object. It then adds that object as an element of the data set.</p> <p>Time-series objects hold relevant information such as block path and timestamps. The conversion tries to preserve this information.</p>

Format	Conversion Result Notes
Structure and structure with time	<p>Structure and structure with time formats do not always contain as much information as if you log in <b>Dataset</b> format. However, before converting structure and structure with time formats, the data structure must have <b>time</b> and <b>signals</b> fields.</p> <p>Conversion populates a <b>Simulink.SimulationData.Signal</b> object with the structure and adds it as an element of the data set. If other information is available, converting also adds it to the element or time-series values. For example, if the structure has a field called <b>blockName</b>, converting adds it to the block path. Otherwise, the block path is empty.</p> <p>When scope data is logged in structure format, the logged structure has a <b>PlotStyle</b> field. The software uses this field to set the interpolation in the <b>Dataset</b> object.</p>
Array	<p>Arrays contain little information. For example, there is no block path information.</p> <p>Conversion adds the array to a <b>Simulink.SimulationData.Signal</b> object and adds it as an element of the <b>Dataset</b> object. The conversion leaves unavailable information such as block path and timestamp fields as either empty or with default values.</p>
ModelDataLogs	<p>Converts data from <b>ModelDataLogs</b> format to <b>Dataset</b> format.</p> <hr/> <p><b>Note:</b> The <b>ModelDataLogs</b> format is no longer used for signal logging.</p>

## Dataset Conversion Limitations

- Converting logged data to `Dataset` format results in a `Dataset` object that contains all the information that the original logged data included. However, if there is no corresponding information for the other `Dataset` properties, the conversion uses default values for that information.
- To log variable-size signals, use the To Workspace block. If you convert data logged with To Workspace to be `Dataset` format, you lose the information about the variable-size signals.
- When you log a bus signal in array, structure, or structure with time formats, the logged data is organized with:
  - The first column containing the data for the first signal in the bus
  - The second column containing data for the second bus signal, and so on

When you convert that data to `Dataset`, the `Dataset` preserves that organization. But if you log the bus signal in `Dataset` format without conversion, the conversion captures the bus data as a structure of time-series objects.

- If the logged data does not include a time vector, when you convert that data to `Dataset`, the conversion inserts a time vector. There is one time step for each data value. However, the simulation time steps and the `Dataset` time steps can vary.
- `Dataset` format ignores the specification of frame signals. Conversion of structure or structure with time data to `Dataset` reshapes the data for logged frame signals.

## See Also

`Simulink.SimulationData.Dataset`

## Related Examples

- “Convert Logged Data to Dataset Format” on page 59-28
- “Migrate Scripts That Use `ModelDataLogs` API” on page 59-89

## Convert Logged Data to Dataset Format

### In this section...

“Convert Workspace Data to Dataset” on page 59-28

“Convert Structure Without Time to Dataset” on page 59-30

“Programmatically Access Logged Dataset Format Data” on page 59-34

### Convert Workspace Data to Dataset

This example shows how to convert MATLAB time-series data to **Dataset** format. `myvdp_timeseries` is the `vdp` model with two **To Workspace** blocks configured for `simout` and `simout1` logging data in MATLAB time-series format. Consider using a procedure like this one if you have models that use **To Workspace** blocks to log data to MATLAB time-series format.

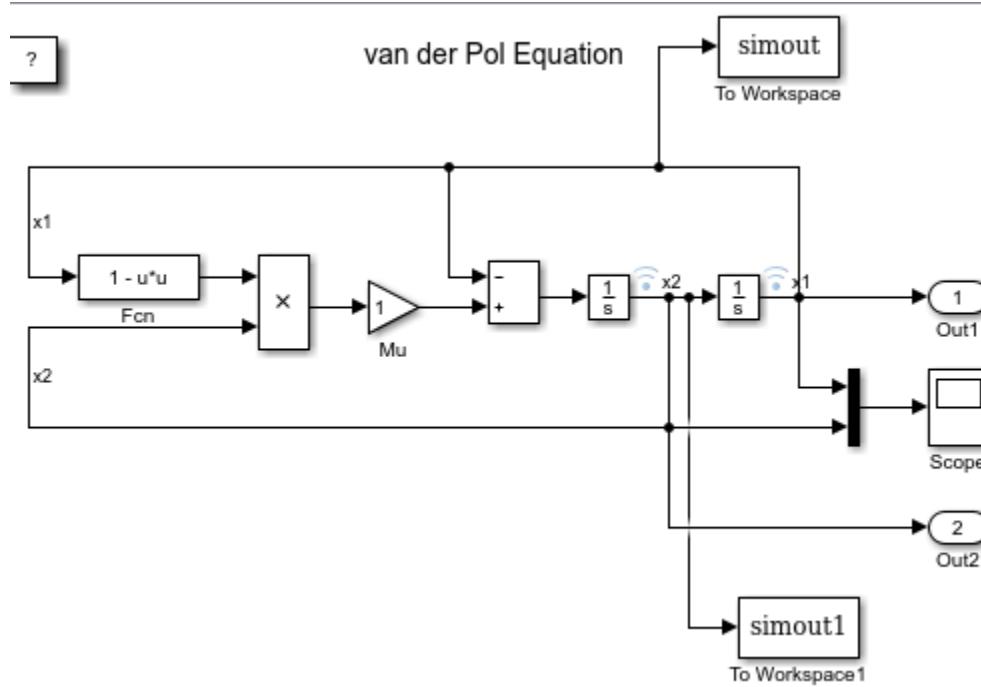

Use the `Simulink.SimulationData.Dataset` constructor to convert the MATLAB time-series data to `Dataset` format and then concatenate the two data sets.

- 1 Starting with the `vdp` model, add two To Workspace blocks to the model as shown.
- 2 Set the **Save format** parameter of both blocks. Set `Timeseries`.
- 3 Save the model as `myvdp_timeseries`.
- 4 Simulate the model.

The simulation logs data using the To Workspace blocks.

- 5 Access the signal logging format, `logouts`.

```
logouts
```

```
logouts =
```

```
Simulink.SimulationData.Dataset
Package: Simulink.SimulationData
```

```
Characteristics:
      Name: 'logouts'
  Total Elements: 2
```

```
Elements:
  1: 'x1'
  2: 'x2'
```

```
-Use get or getElement to access elements by index or name.
-Use addElement or setElement to add or modify elements.
```

```
Methods, Superclasses
```

- 6 Convert the MATLAB time-series data from both To Workspace blocks to `Dataset`.

```
ds = Simulink.SimulationData.Dataset(simout);
ds1 = Simulink.SimulationData.Dataset(simout1);
```

`ds` is the variable name of the first To Workspace block data. `ds1` is the variable name of the second To Workspace block data.

- 7 Concatenate both datasets into `dsfinal`. Observe that the format of `dsfinal` matches that of `logouts`.

```
dsfinal = ds.concat(ds1)
```

```
dsfinal =  
  
    Simulink.SimulationData.Dataset  
    Package: Simulink.SimulationData  
  
    Characteristics:  
        Name: 'simout'  
        Total Elements: 2  
  
    Elements:  
        1: 'x1'  
        2: 'x2'  
  
    -Use get or getElement to access elements by index or name.  
    -Use addElement or setElement to add or modify elements.  
  
    Methods, Superclasses
```

## Convert Structure Without Time to Dataset

This example shows how to convert structure without time data to **Dataset** format. `myvdp_structure` is the vdp model with two To Workspace blocks configured for `simout` and `simout1` logging data in structure format, as shown.

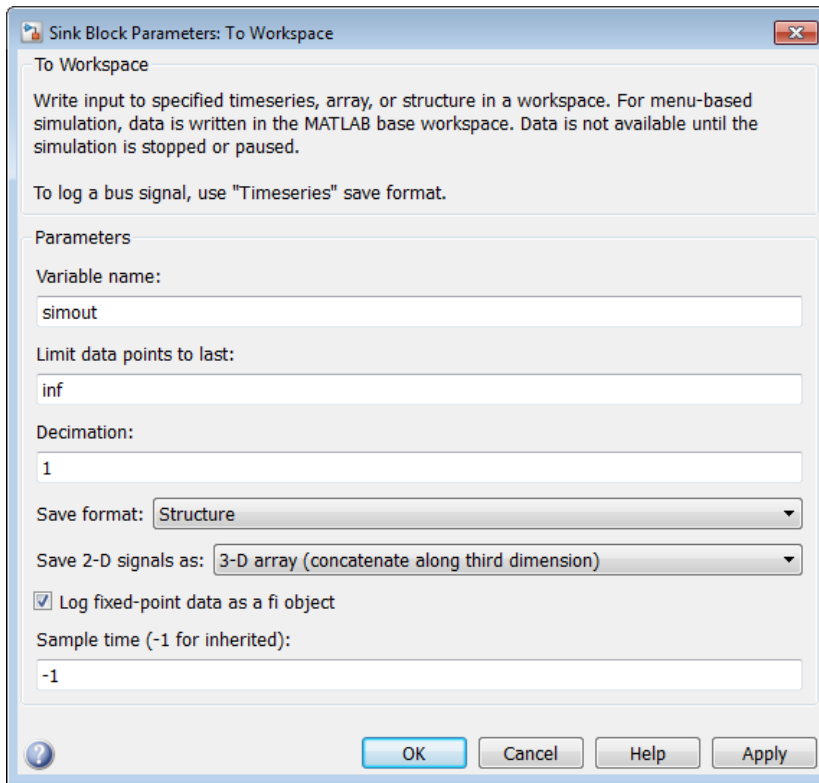

If you have models that use To Workspace blocks to log data to structure format, consider using a procedure like this one to convert them to **Dataset** format.

- 1 Starting with the vdp model, add two To Workspace blocks to the model as shown.

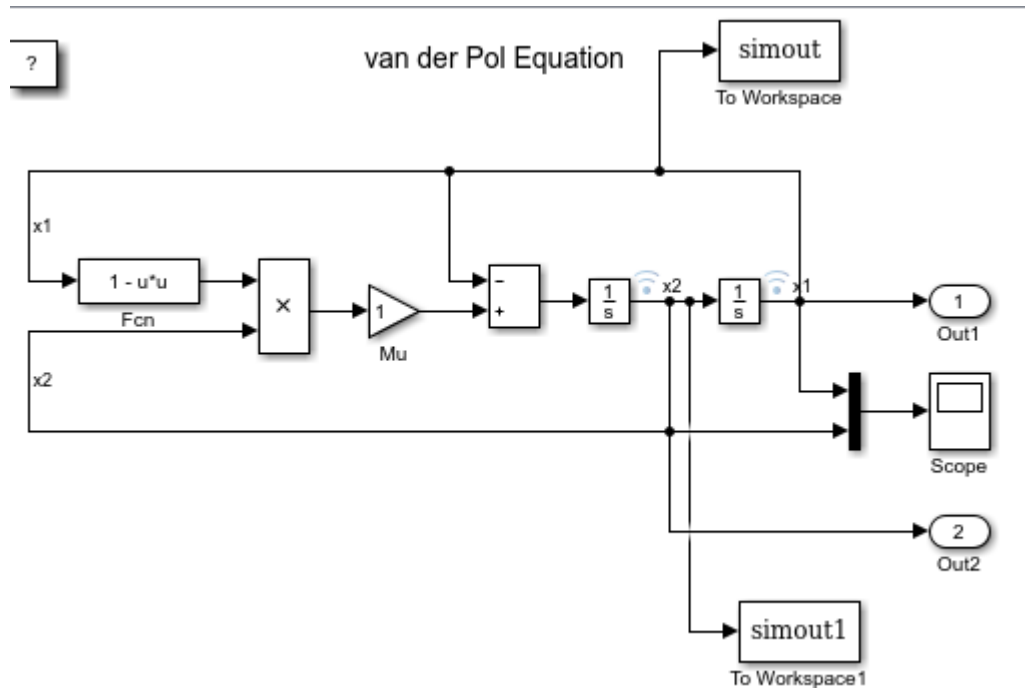

- 2 In the **Save format** parameter of both blocks, select **Structure**.
- 3 Enable signal logging for the two signals going to the two To Workspace blocks to log in DS format.
- 4 Save the model as `myvdp_structure`.
- 5 Simulate the model.

The simulation logs data using the To Workspace blocks.

- 6 Convert the structure data from both To Workspace blocks to **Dataset**.

```
ds = Simulink.SimulationData.Dataset(simout);
ds1 = Simulink.SimulationData.Dataset(simout1);
```

*simout* is the variable name of the first To Workspace block data. *simout1* is the variable name of the second To Workspace block data.



With the conversion of structure without time or an array, time starts at  $t=0$  and increments by 1.

- 7 Get the values of the first element in *ds*.

```
ds.get(1).Values.Time
```

```
ans =
```

```
0
1
2
3
.
.
.
61
62
63
```

- 8 Get the time values of the first element from signal logging.

```
logcout.get(1).Values.Time
```

```
ans =
```

```
0
0.0001
0.0006
0.0031
.
.
.
19.2802
19.6802
20.0000
```

- 9 Observe the discrepancy in timestamps between
- Data logged in structure without time that you convert to **Dataset** format
  - Data logged in **Dataset** format

## Programmatically Access Logged Dataset Format Data

When you use the default `Dataset` signal logging format, Simulink saves the logging data in a `Simulink.SimulationData.Dataset` object. For information about extracting signal data from that object, see the `Simulink.SimulationData.Dataset` reference page.

The `Simulink.SimulationData.Dataset` object contains a `Simulink.SimulationData.Signal` object for each logged signal.

For bus signals, the `Simulink.SimulationData.Signal` object contains a structure of MATLAB `timeseries` objects.

The `Simulink.SimulationData.Dataset` class provides two methods for accessing the signal logging data and its associated information.

Name	Description
<code>Simulink.SimulationData.DataSet.get</code> You can also use the <code>getElement</code> method, which shares syntax and behavior as the <code>get</code> method.	Get element or collection of elements from the dataset, based on index, name, or block path.
<code>Simulink.SimulationData.DataSet.numElements</code>	Get number of elements in the dataset.

For example of accessing signal logging data that uses the `Dataset` format, see `Simulink.SimulationData.Dataset`.

### Access Array of Buses Signal Logging Data

Signal logging data for an array of buses uses `Dataset` signal logging format.

The general approach to access data for a specific signal in an array of buses is:

- 1 Use a `Simulink.SimulationData.Dataset.get` (or `getElement`) method to access a specific signal in the logged data (by default, the `logouts` variable).
- 2 To get the values, index within the array of buses.
- 3 Index again to get data for a specific bus.

For example, to obtain the signal logging data for the `Constant6` block in the `ex_log_nested_aob` model, for the `topBus` signal that feeds the `Terminator` block:

```
logouts.getElement('topBus').Values.a(2,2).firstConst.data
```

Here are additional examples of accessing array of buses signal logging data. For another example that shows how to log array of buses data, see `sldemo_md1ref_bus`.

### Simple Array of Buses

The `ex_log_simple_aob` model includes an array of buses signal `AoBSig` that combines two bus signals (`busSig1` and `busSig2`).

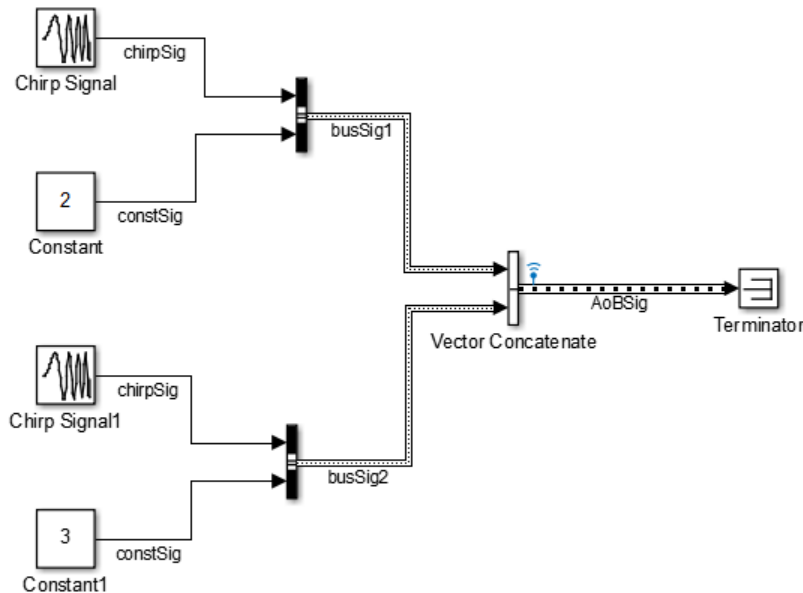

To access the signal logging data for the array of buses signal, navigate through the structure hierarchy and use an index to access a specific node. This example shows navigation to the `chirpSig` signal value in `busSig2`.

```
logout.getElement('AoBSig').Values(2).chirpSig.Data
```

```
ans=
```

```
0
0.9585
```

### Array of Buses in a Bus

The `ex_log_aob_in_bus` model has an array of buses (`s2`) that feeds into bus `s1`.

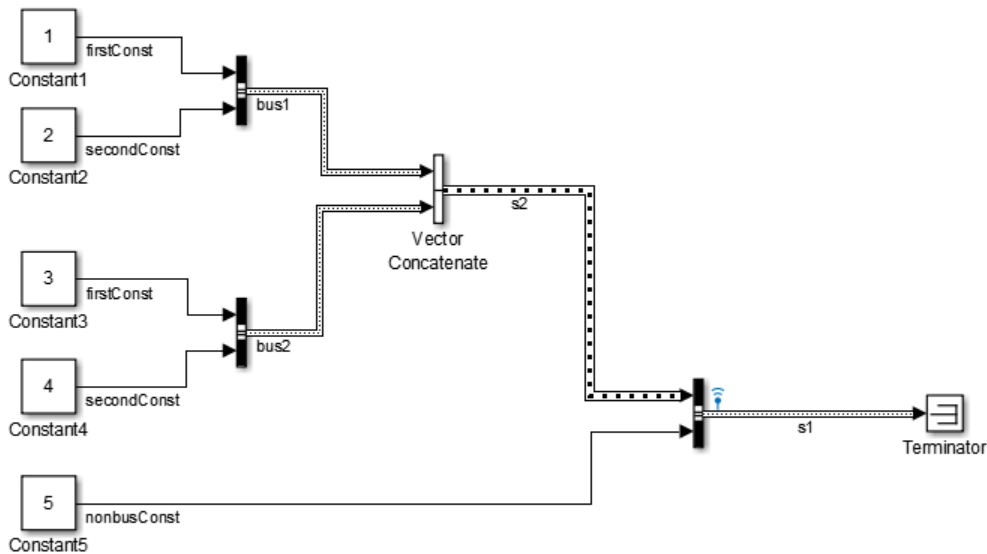

This example shows navigation to the Constant3 block, which is a signal in bus2.

```
logout.getElement('s1').Values.s2(2).firstConst.Data
```

```
ans=
```

```
3
3
3
3
3
3
```

### Nested Arrays of Buses

The `ex_log_nested_aob` model has an array of buses (a) that is made up of three arrays of buses: b, c, and d. The Matrix Concatenate block combines the nested arrays of buses into array of buses a.

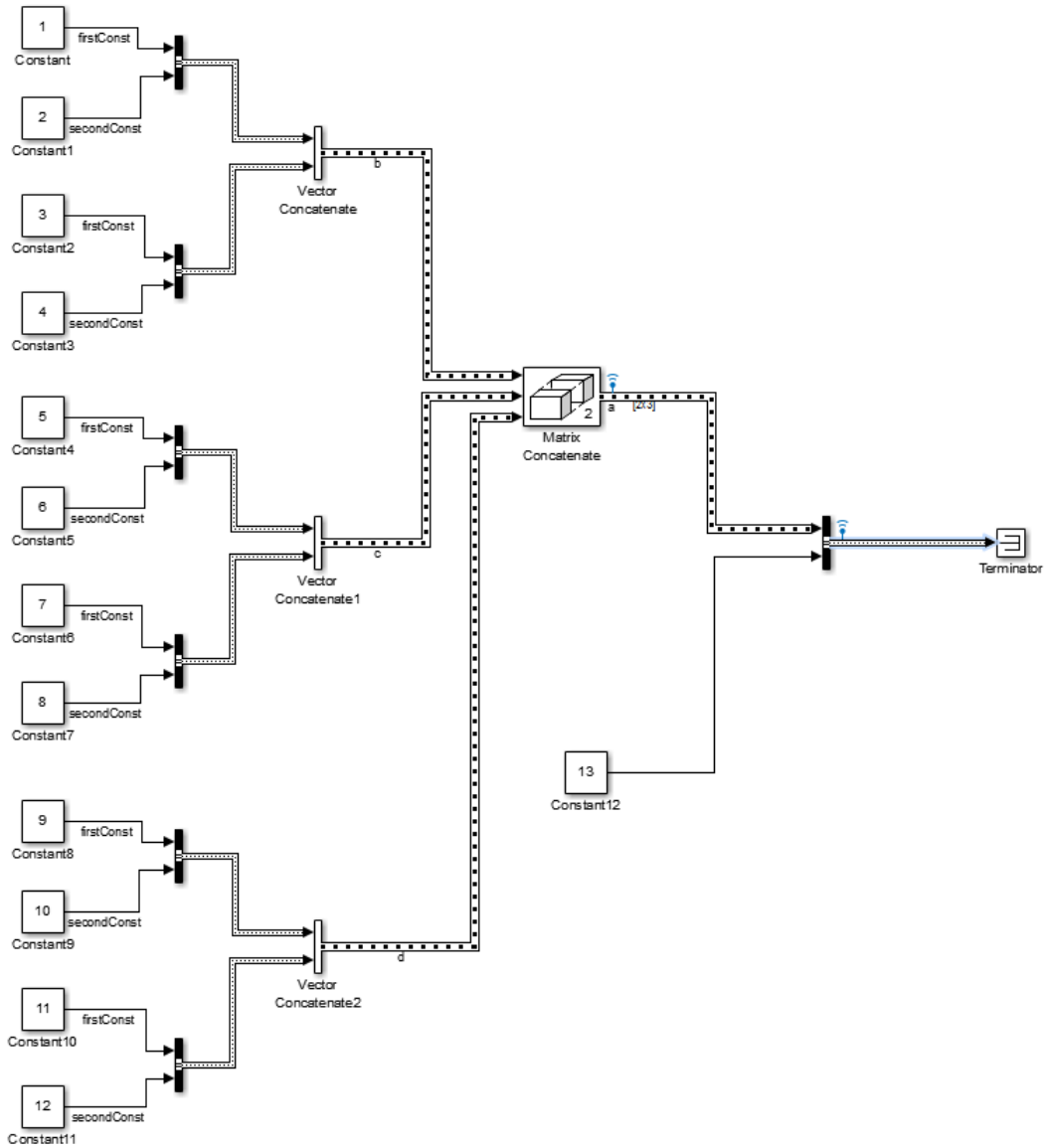

This example shows navigation to the Constant6 block.

```
logout.getElement('topBus').Values.a(2,2).firstConst.Data
```

```
ans=
```

```
7  
7  
7  
7  
7  
7  
7  
7  
7  
7  
7
```

### Accessing Data for Signals with a Duplicate Name

For a model with multiple signals that have the same signal name, signal logging data includes a `Simulink.SimulationData.Signal` object for each signal that has a duplicate name.

To access a specific signal that has a duplicate name, use *one* of these approaches:

- To find the data for the specific signal, visually inspect the displayed output of `Simulink.SimulationData.Signal` objects.
- Use the `Simulink.SimulationData.Dataset.getElement` method, specifying the blockpath for the source block of the signal.
- To iterate through the signals with a duplicate signal name, create a script using the `Simulink.SimulationData.Dataset.getElement` method with an index argument.
- Use the Signal Properties dialog box to specify a different name. Consider using this approach when the signals with a duplicate name do not appear in multiple instances of a referenced model in normal mode.
  - 1 In the model, right-click the signal.
  - 2 In the context menu, select **Properties**.
  - 3 In the Signal Properties dialog box, set **Logging name** to **Custom** and specify a different name than the signal name.

- 4 Simulate the model and use the `Simulink.SimulationData.Dataset.getElement` method with a name argument.

---

**Tip:** Alternatively, you can use the Signal Logging Selector to access a specific signal. For details, see “Override Signal Logging Settings with the Signal Logging Selector” on page 59-93.

---

### Handling Newline Characters in Signal Logging Data

To handle newline characters in logging names in signal logging data that uses `Dataset` format, use a `sprintf` command within a `getElement` call. For example:

```
topOut.getElement(sprintf('INCREMENT\nBUS'))
```

### See Also

`Simulink.SimulationData.Dataset`

### Related Examples

- “Migrate Scripts That Use `ModelDataLogs` API” on page 59-89

### More About

- “Dataset Conversion for Logged Data” on page 59-24

## Log Signal Data That Uses Units

To have logged data include the units specified for signals, use the **Dataset** or **Timeseries** logging format, which stores logging information in MATLAB **timeseries** objects.

Signal logging uses **Dataset** format. Output logging (**Configuration Parameters > Data Import/Export > Output**) uses **Dataset** as the default format. The default save format for the To File and To Workspace blocks is **Timeseries**.

If you use **Dataset** or **Timeseries** format for signal logging or for To File block or To Workspace block logging, the logged data includes units information.

To capture units information for output logging:

- 1 Set the **Configuration Parameters > All Parameters > Format** parameter to **Dataset**.
- 2 In the Block Parameters dialog box for Output blocks for which you want to capture units information, set the **Unit** parameter to match the units of the input signal.

For example, in this model the In1 block has its **Unit** parameter set to **newton** and In2 block uses **m** (meters). Open the model. After you simulate the model, you can see the units for the logged data.

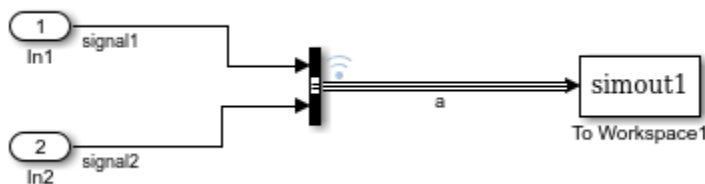

- You can view the units in the signal logging data for **signal1** of the bus signal **b**.

```
logout.get('a').Values.signal1.DataInfo
```

```
tsdata.datametadate
Package: tsdata
```

```
Common Properties:
```

```
Units: newton (Simulink.SimulationData.Unit)
```



```
Interpolation: linear (tsdata.interpolation)
```

- You can view the units in the data logged in the To Workspace block.

```
simout1.signal2.DataInfo.Units
```

```
ans =
```

```
Units with properties:
```

```
Name: 'm'
```

This example model shows how to view the data logged in a Time Scope block. Open the model.

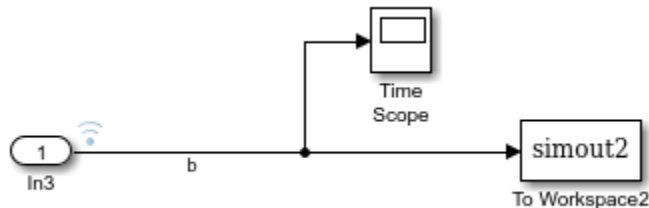

To use the Time Scope block to log data, in the scope select **Configuration Properties** > **Logging** > **Log data to workspace** and specify a variable (ScopeData in this example). The In3 block uses m (meters). Simulate the model and then at the MATLAB command line, enter:

```
ScopeData.get(1).Values.DataInfo.Units
```

```
ans =
```

```
Units with properties:
```

```
Name: 'm'
```

## Related Examples

- “Load Signal Data That Uses Units” on page 59-237

## More About

- “Units in Simulink”

- “Unit Consistency Checking and Propagation” on page 9-11

## Limit Amount of Exported Data

In this section...
“Decimation” on page 59-43
“Limit Data Points” on page 59-44
“Logging Intervals” on page 59-44

You can use several options to reduce the amount of data logged during a simulation. Limiting the amount of exported simulation data reduces memory usage and speeds up simulation. However, if you limit the amount of simulation data, the logged data can skip some time steps that are critical for testing and analyzing the model.

You can use multiple techniques for the same simulation.

Technique	Description
Specify a decimation factor	Skip samples when exporting data.
Limit data points	Limit the number of samples saved to be only the most recent samples
Specify an interval for logging	Specify ranges of time steps for logging

Alternatively, for logging large amounts of data that can cause memory issues, consider logging to persistent storage. This approach preserves all of the logging data, minimizing MATLAB workspace memory usage. For details, see “Log Data to Persistent Storage” on page 59-49.

### Decimation

To skip samples when exporting data, apply a decimation factor. For example, a decimation factor of 2 saves every other sample. By default, decimation is set to 1, which does not skip any samples.

The approach you use to specify a decimation factor depends on the kind of logging data.

Data	How to Specify
Signal logging	Right-click the signal. In the Signal Properties dialog box, select the <b>Decimation</b> parameter.

Data	How to Specify
Data store logging	From the Block Parameters dialog box for that block, open the <b>Logging</b> tab. Apply a decimation factor using the <b>Decimation</b> parameter.
State and output	Enter a value in the field to the right of the <b>Decimation</b> label.

## Limit Data Points

To limit the number of samples saved to be only the most recent samples, set the **Limit Data Points** parameter.

The approach you use depends on the kind of logging data.

Data	How to Specify
Signal logging	Right-click the signal. In the Signal Properties dialog box, select the <b>Limit Data Points to Last</b> parameter.
Data store logging	From the Block Parameters dialog box for that block, open the <b>Logging</b> tab. Select the <b>Limit Data Points to Last</b> parameter.
Time, state, and output logging	Select the <b>Configuration Parameters &gt; All Parameters &gt; Limit data points</b> parameter and for the <b>Configuration Parameters &gt; All Parameters &gt; Maximum number of data points</b> parameter, specify the limit.

## Logging Intervals

To specify an interval for logging, use the **Configuration Parameters > Data Import/Export > Logging intervals** parameter. Limiting logging to a specified interval allows you to examine specific logged data without changing the model or adding complexity to a model.

The logging intervals apply to data logged for:

- Time
- States
- Output
- Signal logging
- The To Workspace block
- The To File block

The logging intervals do not apply to final state logged data, scopes, or streaming data to the Simulation Data Inspector.

The intervals specified with **Logging intervals** establish the set of times to which the **Decimation** and **Limit data points to last** parameters apply. For example, suppose that you set the logging interval [2, 4; 7, 9] with a fixed-step solver with a fixed-step size of 1. The logged times are 2, 3, 4, 7, 8, and 9.

## Related Examples

- “Export Signal Data Using Signal Logging” on page 59-70
- “Load Data Using the From File Block” on page 59-239
- “Load Data Using the From Workspace Block” on page 59-242

## More About

- “Decimation”
- “Limit data points”
- “Logging intervals”

## Working with Big Data for Simulations

Simulation of models that have many time steps and signals can involve big data that is too large to fit into the RAM of your computer. Situations in which models with many time steps and signals can require the use of big data include:

- Logging simulation data (signal logging, output logging, and state logging)
- Loading input signal data for simulating a model
- Running parallel simulations

To work with simulation big data, store simulation big data to persistent storage in a MAT-file. Using big data techniques for simulations requires additional steps not needed for signal data that workspace memory and blocks such as From File and From Spreadsheet can handle. As you develop a model, consider logging and loading simulation data without using persistent storage until you discover that your model has big data requirements that overload memory.

### Big Data Workflow

This example shows a high-level workflow for handling big data that a simulation produces and that another simulation uses as input. For more detailed information about the major workflow tasks, see:

- “Log Data to Persistent Storage” on page 59-49
- “Load Big Data for Simulations” on page 59-54
- “Analyze Big Data from a Simulation” on page 59-62

- 1 Configure two models to log several signals.
- 2 Simulate the models, logging the data to persistent storage for each model.

```
sim(md11, 'LoggingToFile', 'on', 'LoggingFileName', 'data1.mat');  
sim(md12, 'LoggingToFile', 'on', 'LoggingFileName', 'data2.mat');
```

Logging that involves big data requires saving the data to persistent storage as a v7.3 MAT-file. Only data logged in `Dataset` format is saved to the file. Data logged in other formats, such as `Structure with time`, is saved in memory, in the base workspace.

The data that you log to persistent storage is streamed during the simulation in small chunks, to minimize memory requirements. The data is stored in a file that

contains `Dataset` objects for each set of logged data (for example, `logsout` and `xout`).

- 3 Create `DatasetRef` objects (`dsr1` and `dsr2`) for specific sets of logged signals. Then create `SimulationDatastore` objects (`dst1` and `dst2`) for values of elements of the `DatasetRef` objects. This example code creates a `SimulationDatastore` for the 12th element of `logsout` for the first simulation and a signal with values being a `SimulationDatastore` object for the seventh element of `logsout` for the second simulation.

```
dsr1 = Simulink.SimulationData.DatasetRef('data1.mat', 'logsout');
dsr2 = Simulink.SimulationData.DatasetRef('data2.mat', 'logsout');
dst1 = dsr1{12};
dst2 = dsr2{7};
```

- 4 Use `SimulationDatastore` objects as an external input for another simulation. To load the `SimulationDatastore` data, include it in a `Dataset` object. The datastore input is incrementally loaded from the MAT-file. The third input is a `timeseries` object, which is loaded into memory as a whole, not incrementally.

```
input = Simulink.SimulationData.Dataset;
input{1} = dst1;
input{2} = dst2;
ts = timeseries(rand(5,1),1, 'Name', 'RandomSignals');
input{3} = ts;
sim(md13, 'ExternalInput', 'input');
```

- 5 Use MATLAB big data analysis and manipulation to work with the `SimulationDatastore` objects. Create a `timetable` object by reading the values of a `SimulationDatastore` object.

```
tt = dst1.Values.read;
```

- 6 Set the MATLAB session as the global execution environment for working with the tall `timetable`. Create a tall `timetable` from a `SimulationDatastore` object and read a `timetable` object with in-memory data.

```
mapreducer(0);
ttt = tall(dst1.Values);
```

## See Also

### Functions

`Simulink.SimulationData.Dataset` | `timeseries` | `Simulink.SimulationData.DatasetRef` | `matlab.io.datastore.SimulationDatastore`

## **Related Examples**

- “Log Data to Persistent Storage” on page 59-49
- “Load Big Data for Simulations” on page 59-54
- “Analyze Big Data from a Simulation” on page 59-62
- “Run Multiple Simulations” on page 25-2



## Log Data to Persistent Storage

### In this section...

“When to Log to Persistent Storage” on page 59-49

“Log to Persistent Storage” on page 59-51

“Enable Logging to Persistent Storage Programmatically” on page 59-51

“How Simulation Data Is Stored” on page 59-52

“Save Logged Data from Successive Simulations” on page 59-52

### When to Log to Persistent Storage

Logging many signals in a long simulation that has many time steps can produce big data. The big data can overload computer memory. Using persistent storage can help to address big data memory issues. Also, persistent storage is useful for logging when you run simulations in parallel.

You can store logged simulation data to persistent storage in a MAT-file. Using persistent storage minimizes the amount of logged data stored in memory during simulation. You control logging to persistent storage at the model level. You can enable and disable the feature by changing one model configuration parameter without changing the model layout.

If you use `Dataset` format for logging, you can log each of these kinds of data to persistent storage:

- Signal logging — Uses `Dataset` format only.
- States — Default is `Dataset` format.
- Final states — Also clear the **Save complete Sim State in final state** parameter
- Output — Default is `Dataset` format.
- Data stores — Uses `Dataset` format only.

By default, logging to persistent storage is disabled, so that logged data is stored in the MATLAB workspace. For many models, logging to the workspace is simpler because it avoids loading and saving logging files. Accessing data logged to persistent storage requires some additional steps, compared to accessing data logged to memory. For short simulations, logging to the MATLAB workspace can be faster and possibly use less memory than logging to persistent storage.

### Limitations for Logging to Persistent Storage

- Only data logged in Dataset format is stored in the MAT-file. Data logged in other formats is stored in the MATLAB workspace.
- To use persistent storage for logging final states data, you cannot enable the **Configuration Parameters > Data Import/Export > Save complete SimState in final state**.
- The Simulation Stepper and fast restart do not support logging to persistent storage.
- During simulation, you cannot load data from the persistent storage file directly into the model.

### Alternative Approaches for Reducing Logging Memory Usage

If simulating a model that uses logging does cause memory issues, consider using alternatives instead of logging to persistent storage.

- Limit the amount of simulation data stored in the workspace.

You can limit the amount of simulation data stored in the workspace by using one or more of these techniques. For details, see “Limit Amount of Exported Data” on page 59-43.

Technique	Description
Specify a decimation factor.	Skip samples when exporting data.
Limit data points.	Limit the number of samples saved to be only the most recent samples.
Specify intervals for logging.	Specify ranges of time steps for logging.

However, if you limit the amount of simulation data, the logged data can skip some time steps that are critical for testing and analyzing the model.

- Use a To File block for each signal that you want to log.

Connecting a To File block to signals that you want to log stores the logged data in a MAT-file, rather than in the MATLAB workspace. However, this approach:

- Is a per-signal approach that can clutter a model with multiple To File blocks attached to individual signals.
- Creates a separate MAT-file for each To File block, compared to the one MAT-file used by logging to persistent storage.

## Log to Persistent Storage

- 1 Specify the kinds of logging to perform and the variable names for the logging data.
- 2 In the model diagram, mark selected signals for signal logging.
- 3 Use **Dataset** format for logging the data. Data that is logged in any other format is stored in the workspace.
  - Signal logging and data store logging use **Dataset** format only. The default format for logged output, states, and final states is **Dataset**.
  - For final states logging, also clear the **Save complete SimState in final state** parameter.
- 4 Enable logging to persistent storage and specify an output MAT-file name.
  - Select the **Log Dataset data to file** configuration parameter.
  - Specify the MAT-file to use. Do not use a file name from one locale in a different locale.
- 5 Set the **DatasetSignalFormat** configuration parameter to save the logged **Dataset** data using **timeseries** or in-memory **timetable** elements. The default is **timeseries**. The **timetable** format is helpful for MATLAB combining logged data from multiple simulations. For details about the **timetable** format, see “DatasetSignalFormat”.
- 6 Simulate the model.

## Enable Logging to Persistent Storage Programmatically

You can programmatically log to persistent storage. To enable logging to persistent storage, use the `LoggingToFile` and `LoggingFileName` name-value pairs with either the `sim` command or `set_param` command.

To enable the logging approaches that you want to use, set these parameters to 'on':

- `SignalLogging`
- `SaveState`
- `SaveFinalState`
- `SaveOutput`
- `DSMLogging`

- To log output, states, and final states data to persistent storage, set the `SaveFormat` parameter to `'Dataset'`.
- To log final states data to persistent storage, set the `SaveCompleteFinalSimState` to `'off'`.

## How Simulation Data Is Stored

Logging to persistent storage saves logged simulation data in the specified MAT-file. The data is stored as `Simulink.SimulationData.Dataset` objects for each type of logging that uses `Dataset` format. The `Dataset` elements are stored as either `timeseries` or `timetable` objects, depending on how you set the `DatasetSignalFormat` parameter. For details about the `timetable` format, see “`DatasetSignalFormat`”.

The `Dataset` object name in the file is the name of the variable that you used for logging. For example, if you use the default signal logging variable `logstdout`, the `Dataset` object in the MAT-file is `logstdout`.

## Save Logged Data from Successive Simulations

### Without Using Parallel Simulations

Each time you simulate a model without using parallel simulation, Simulink overwrites the contents of the MAT-file unless you change the name of the file between simulations. When you use a `Simulink.SimulationData.DatasetRef` object that references data in the MAT-file to retrieve data in the file, it retrieves the most recent version of the data. To preserve data from an earlier simulation, use one of these approaches:

- Between simulations, use the **Configuration Parameters > Data Import/Export** pane to specify a different name for MAT-file for logging.
- Between simulations, save a copy of the MAT-file. Use a different file name than the name that you specify as the MAT-file for persistent storage, or move the MAT-file.
- Programmatically specify a new file name for each simulation run.

If you change the file name used for logging to persistent storage, then to access the logged data, use one of these approaches:

- Create a `Simulink.SimulationData.DatasetRef` object.
- Change the `Location` property of the `DatasetRef` objects to match the new file name.

For details about using `DatasetRef` objects to access logged data, see “Create References to Persistent Storage Dataset Objects” on page 59-54.

### **With Parallel Simulations**

For parallel simulations, for which you specify an array of input objects, if you log to file, Simulink:

- Creates a MAT-file for each simulation
- Creates `Simulink.SimulationData.DatasetRef` objects to access output data in the MAT-file and includes those objects in the `SimulationOutput` object data
- Enables the `CaptureErrors` argument for simulation

For more information about parallel simulations, see “Run Multiple Simulations” on page 25-2

### **See Also**

#### **Functions**

`Simulink.SimulationData.Dataset` | `timeseries` | “`DatasetSignalFormat`” | `Simulink.SimulationData.DatasetRef` | `timetable`

### **Related Examples**

- “Working with Big Data for Simulations” on page 59-46
- “Load Big Data for Simulations” on page 59-54
- “Analyze Big Data from a Simulation” on page 59-62
- “Run Multiple Simulations” on page 25-2

## Load Big Data for Simulations

### In this section...

“Create References to Persistent Storage Dataset Objects” on page 59-54

“Get List of Dataset Variables” on page 59-56

“Create a SimulationDatastore for a Logged Signal” on page 59-57

“Create a Dataset Object for Root-Level Inports” on page 59-58

“Specify Data for an Input Dataset” on page 59-58

“Stream Data into a Model” on page 59-60

You can use data logged to persistent storage in one simulation as input for another simulation. You can use a `matlab.io.datastore.SimulationDatastore` object in a `Simulink.SimulationData.Dataset` object to stream data into a root Inport block. Create the `SimulationDatastore` object for a leaf signal in a `Simulink.SimulationData.DatasetRef` object, by using an index into the `DatasetRef` object.

`SimulationDatastore` input data streams in small chunks (100 samples at a time, by default). The data is loaded as the simulation needs it. The entire data for a signal is never fully loaded into memory.

### Create References to Persistent Storage Dataset Objects

You can use the `load` command to load a `Dataset` object from a persistent storage MAT-file into a model. The entire dataset is loaded into memory.

For big data, use `Simulink.SimulationData.DatasetRef` objects to access a specific type of logged data in a dataset. You can access elements of the `DatasetRef` object to access data for a specific signal.

When you access signal logging, output, or states logging data from a MAT-file created by logging to persistent storage, Simulink reads the data to the MATLAB workspace incrementally (signal by signal).

When you use a `DatasetRef` object that references data in a MAT-file to retrieve data in the file, it retrieves the most recent version of the data.

This example shows how to construct and use `DatasetRef` objects to access data for a model that logs to persistent storage. This simple example shows the basic steps for

logging to persistent storage. This example does not represent a realistic situation for logging to persistent storage, because it shows a short simulation with small memory requirements. However, you can use the same workflow for big data.

- 1 Open the vdp model.
- 2 In the **Configuration Parameters > Data Import/Export** pane, select these parameters:
  - **States**
  - **Log Dataset data to file.**

Set the **Format** parameter to **Dataset**.

Leave the other parameter settings as they are and click **Apply**.

- 3 In the model, click a signal and in action bar, select **Enable Data Logging**.
- 4 Simulate the model.
- 5 Get a list of **Dataset** variable names in the `out.mat` file.

```
varNames = Simulink.SimulationData.DatasetRef.getDatasetVariableNames('out.mat')
```

```
varNames =
```

```
    'xout'    'logout'
```

- 6 Create a reference to the logged states data that is stored in `out.mat`. The variable for the logged states data is `xout`.

```
statesLogRef = Simulink.SimulationData.DatasetRef('out.mat', 'xout')
```

```
statesLogRef =
```

```
Simulink.SimulationData.DatasetRef
```

```
Characteristics:
```

```
    Location: out.mat (/myDir/out.mat)
```

```
    Identifier: xout
```

```
Resolved Dataset: 'xout' with 2 elements
```

	Name	BlockPath
1	' '	vdp/x1
2	' '	vdp/x2

- 7 Create a reference to the signal logging data that is stored in `out.mat`. The variable for the signal logging data is `log sout`.

```
sigLogRef = Simulink.SimulationData.DatasetRef('out.mat','log sout')
```

```
sigLogRef =
```

```
Simulink.SimulationData.DatasetRef
Characteristics:
    Location: out.mat (/myDir/out.mat)
    Identifier: log sout

Resolved Dataset: 'log sout' with 1 element
```

	Name	BlockPath
1	x1	vdp/x1

- 8 Use the `DatasetRef` to access the first element of the signal logging Dataset.

```
sigLogRef{1}
```

```
ans =
```

```
Simulink.SimulationData.Signal
Package: Simulink.SimulationData

Properties:
    Name: 'x1'
    PropagatedName: ''
    BlockPath: [1x1 Simulink.SimulationData.BlockPath]
    PortType: 'outport'
    PortIndex: 1
    Values: [1x1 matlab.io.datastore.SimulationDatastore]
```

## Get List of Dataset Variables

To create a reference to persistent storage `Dataset` objects in the MAT-file that stores the logged data, you use the name of a `Dataset` variable in the file. You can use the `Simulink.SimulationData.DatasetRef.getDatasetVariableNames` function to get a list of the `Dataset` variables in a MAT-file.



---

**Tip:** To get the names of Dataset variables in the MAT-file, using the `Simulink.SimulationData.DatasetRef.getDatasetVariableNames` function processes faster than using the `who` or `whos` functions.

---

## Create a SimulationDatastore for a Logged Signal

You can create `matlab.io.datastore.SimulationDatastore` for a signal logged to persistent storage. You can use a `SimulationDatastore` object as an element of a `Dataset` object that you load into a model; you cannot load a `Datastore` object directly into a model. Also, you can use a `SimulationDatastore` object to create a MATLAB tall timetable object. When you use a `SimulationDatastore` object to access data from a MAT-file created by logging to persistent storage, Simulink reads the data for a signal to the MATLAB workspace incrementally (sample by sample).

For example, suppose that you use the `out.mat` file created in the example in “Create References to Persistent Storage Dataset Objects” on page 59-54. To create a `SimulationDatastore` object for the first signal in a `logout` dataset:

```
sigLogRef = Simulink.SimulationData.DatasetRef('out.mat','logout');
loggedSig1 = sigLogRef{1};
loggedSig1.Values
```

```
ans =
```

```
SimulationDatastore with properties:
```

```
ReadSize: 100
FileName: 'out.mat'
```

Alternatively, you can use the `Simulink.SimulationData.DatasetRef.getAsDatastore` function to create a `SimulationDatastore` from a `DatasetRef` object. For example:

```
sigLogRef = Simulink.SimulationData.DatasetRef('out.mat','logout');
loggedSig1 = sigLogRef.getAsDatastore(1);
```

If you use index syntax or the `Simulink.SimulationData.DatasetRef.getAsDatastore` method to access a `DatasetRef` object element, the returned value is a `timeseries` object. For example:

```
sigLogRef = Simulink.SimulationData.DatasetRef('out.mat','logout');
```

```
loggedSig1 = sigLogRef.getAsDatastore(1);  
loggedSig1.Values
```

---

**Note:** A `SimulationDatastore` streams data from memory, not from the MAT-file, when the `Dataset` object that the `SimulationDatastore` object was built from meets either of these conditions:

- The `Dataset` object was saved to a MAT-file before R2017a.
  - The MAT-file used was other than a v7.3 MAT-file.
- 

## Create a Dataset Object for Root-Level Imports

To load big data into the root-level Inport blocks in a model, create a `Dataset` object that has the same number of elements as there are Inport blocks. The order of the elements must correspond to the order of the Inport blocks in the model. You can use an empty array (`[]`) to use ground values for an Inport block.

You can use the `createInputDataset` function to create a `Dataset` object that contains elements that correspond to the Inport blocks in a model. Signals in the generated dataset have the properties of the root inports and the corresponding ground values at model start and stop times.

## Specify Data for an Input Dataset

To load signal data into root-level Inport blocks, you can create data for elements of a `Dataset` object that you create using the `createInputDataset` function.

Simulink uses ground values for any Inport blocks for which you do not specify data in the corresponding `Dataset` element.

For individual non-bus signal data, you can specify these types of data for `Dataset` elements:

- `timeseries` or structure of `timeseries` objects
- `matlab.io.datastore.SimulationDatastore`
- `double` vectors or structure of `double` data

- `timeseries`
- An object such as a `Simulink.SimulationData.Signal` or `Simulink.SimulationData.State` object

For bus signals, use a structure with a data for each leaf signal, using one of these formats:

- A MATLAB `timeseries` object
- A structure, if each leaf node is:
  - empty
  - a MATLAB `timeseries` object
  - a `matlab.io.datastore.SimulationDatastore` object
- An array that meets one of these requirements:
  - An array with time in the first column and the remaining columns each corresponding to an input port. See “Create Data Arrays for Root-Level Inports” on page 59-250.
  - An `n x 1` array for a root inport that drives a function-call subsystem.
- A `Simulink.SimulationData.Signal` object
- A `matlab.io.datastore.SimulationDatastore` object
- An empty matrix

This example shows how to create a `Dataset` object to contain a mixture of `timeseries` and `SimulationDatastore` data types. For this example, suppose that you have two datasets:

- `ds3` — Stored in `dataFileName.mat`
- `in_mem_ds` — Saved in memory as `dataFileName2`

- 1 Create a `DatasetRef` for `ds3` and load `in_mem_ds` into memory.

```
dsr = Simulink.SimulationData.DatasetRef(dataFileName, 'ds3');
in_mem_ds = load(dataFileName2);
```

- 2 Aggregate the elements for the next simulation. Use one in-memory signal, one signal whose values are a `SimulationDatastore` that references data in the MAT-file, and one raw `SimulationDatastore` without the `Simulink.SimulationData.Signal` object wrapper.

```
e11 = in_mem_ds.get(1);
e12 = dsr{2};
e12 = dsr{3}.Values;
whos e11 e12 e13
```

Name	Size	Bytes	Class
e11	1x1	664	Simulink.SimulationData.Signal
e12	1x1	222	Simulink.SimulationData.Signal
e13	1x1	8	matlab.io.datastore.SimulationDatastore

- 3 Create a `Dataset` object and populate it with elements for the signals of interest.

```
input_ds = Simulink.SimulationData.Dataset;
input_ds = input_ds.add(e11, 'in memory values');
input_ds = input_ds.add(e12, 'datastore values');
input_ds = input_ds.add(e13, 'raw datastore')
```

```
input_ds =

    Simulink.SimulationData.Dataset
    Package: Simulink.SimulationData

    Characteristics:
        Name: ''
        Total Elements: 3

    Elements:
        1 : 'in memory values'
        2 : 'datastore values'
        3 : 'raw datastore'
```

- 4 Simulate the model with the `input_ds` dataset as the external input.

```
out = sim('mdl' 'LoadExternalInput', 'on', 'ExternalInput', 'input_ds');
```

The simulation streams in values specified by the datastores.

## Stream Data into a Model

To load a `Simulink.SimulationData.Dataset` object as simulation input for root-level Inport blocks, specify the `Dataset` object in the **Input** configuration parameter.

Data that has an associated `SimulationDatastore` object is streamed into the model, minimizing the amount of memory used.

## See Also

### Functions

`Simulink.SimulationData.Dataset` | `timeseries` | `Simulink.SimulationData.DatasetRef` | `createInputDataset` | `matlab.io.datastore.SimulationDatastore` | `timetable`

## Related Examples

- “Working with Big Data for Simulations” on page 59-46
- “Log Data to Persistent Storage” on page 59-49
- “Analyze Big Data from a Simulation” on page 59-62

## Analyze Big Data from a Simulation

### In this section...

“Create DatasetRef Objects to Access Logged Datasets” on page 59-62

“Use SimulationDatastore Objects to Access Signal Data” on page 59-62

“Create Timetables for MATLAB Analysis” on page 59-63

“Create Tall Timetables” on page 59-63

“Access Persistent Storage Metadata and Error Information” on page 59-63

“Access Data Store Memory Data” on page 59-64

To access data logged to a persistent storage (a MAT-file) for analysis in MATLAB, use references to the data in the MAT-file. You can work directly with data logged in a format other than `Dataset` format, because that data is stored in the MATLAB workspace.

### Create DatasetRef Objects to Access Logged Datasets

When you log to a MAT-file, Simulink stores in the specified MAT-file a `Simulink.SimulationData.Simulink.Dataset` object whose elements are `Dataset` objects. There is one `Dataset` object for each set of logged simulation data (for example, `Dataset` objects for `logouts` and `xouts`, for signal logging and state logging).

To access simulation `Dataset` format data for a set of logged simulation data, create `Simulink.SimulationData.DatasetRef` objects. You can access individual elements of the dataset using `DatasetRef` objects. For details, see:

- “Get List of Dataset Variables” on page 59-56
- “Create References to Persistent Storage Dataset Objects” on page 59-54

### Use SimulationDatastore Objects to Access Signal Data

To access leaf signals in a logged `Dataset`, create a `matlab.io.datastore.SimulationDatastore` object for the signal, based on the `DatasetRef` object for the `Dataset` that contains the signal. For details, see

“Create a SimulationDatastore for a Logged Signal” on page 59-57.

You can operate on data referenced by a `SimulationDatastore` object. For example, you can get the data in a chunk to be read into memory from the MAT-file. For an example, see `matlab.io.datastore.SimulationDatastore`.

## Create Timetables for MATLAB Analysis

When you read a `SimulationDatastore` object, using the `read` or `readall` method, the output is in MATLAB `timetable` format. For details about the `timetable` format, see “`DatasetSignalFormat`”.

You can use a `SimulationDatastore` object to create a `timetable` for the signal values and read a `timetable` object with in-memory data. For example, for `SimulationDatastore` object `dst1`:

```
tt = dst1.Values.read;  
ttt = tall(dst1.Values);
```

## Create Tall Timetables

You can create a tall `timetable` :

```
mapreducer(0);  
ttt = tall(dst1.Values);
```

You cannot load a tall `timetable` as simulation input, and you cannot use a tall `timetable` as a `Datasetelement`.

## Access Persistent Storage Metadata and Error Information

If you use persistent storage for several simulations, you can have multiple MAT-files. When you run multiple simulations using batch processing, you get multiple MAT-files if you specify a different persistent storage MAT-file for each simulation. For parallel simulations, Simulink produces a separate MAT-file for each simulation run. To help you identify and understand the context of the simulation data included in a MAT-file, Simulink stores metadata about logging to persistent storage.

A `Simulink.SimulationMetadata` object includes in its `ModelInfo` structure a `LoggingInfo` structure with two fields:

- `LoggingToFile` — Indicates whether logging to persistent storage is enabled ('on' or 'off')

- **LoggingFileName** — Specifies the resolved file name for the persistent storage MAT-file (if **LoggingToFile** is 'on').

The MAT-file used for persistent storage contains a **SimulationMetadata** variable that stores the same simulation metadata as the **Simulink.SimulationMetadata** object. The **SimulationMetadata** is a system-generated name, not a variable name that you specify.

To access the persistent logging storage metadata, use one of these alternatives:

- View simulation metadata by using the **SimulationOutput** object **SimulationMetadata** property.
- Use tab completion to access **SimulationMetadata** object properties such as **ModelInfo** and to access field names.
- Display simulation metadata in the Variable Editor using one of these approaches:
  - Select the **Show Simulation Metadata** check box (which displays the data in a tree structure).
  - Double-click the **SimulationMetadata** row.
  - View the **SimulationMetadata** object.

You can view error message and information about the stack and causes for simulation data by using the **SimulationOutput** object **ErrorMessage** property. For parallel simulations, if you are logging to file, Simulink enables the **CaptureErrors** argument for simulation.

## Access Data Store Memory Data

Data for Data Store Memory blocks data stores created with **Simulink.Signal** objects) is stored in the MAT-file used for logging to persistent storage. To access logged data store data, use the same approach as for accessing signal logging, output, and states logging data (see “Create References to Persistent Storage Dataset Objects” on page 59-54).

However, when you access output or data store logging information from a MAT-file, Simulink loads all of that data into the MATLAB workspace.



## See Also

### Functions

`Simulink.SimulationData.Dataset` | `timeseries` | “`DatasetSignalFormat`”  
| `Simulink.SimulationData.DatasetRef` | `createInputDataset` |  
`matlab.io.datastore.SimulationDatastore` | `timetable`

## Related Examples

- “Working with Big Data for Simulations” on page 59-46
- “Log Data to Persistent Storage” on page 59-49
- “Load Big Data for Simulations” on page 59-54

## Samples to Export for Variable-Step Solvers

In this section...
“Output Options” on page 59-66
“Refine Output” on page 59-66
“Produce Additional Output” on page 59-67
“Produce Specified Output Only” on page 59-68

### Output Options

Use the **Output options** list under **Configuration Parameters > Data Import/Export > Additional parameters** to control how much output the simulation generates when your model uses a variable-step solver.

- Refine factor (default)
- Produce additional output
- Produce specified output only

### Refine Output

The **Refine output** option provides additional output points when the simulation output does not include as many points as you would like. This parameter provides an integer number of output points between time steps. For example, a refine factor of 2 provides output midway between the time steps and at the steps. The default refine factor is 1.

Suppose that a sample simulation generates output at these times:

0, 2.5, 5, 8.5, 10

Choosing **Refine output** and specifying a refine factor of 2 generates output at these times:

0, 1.25, 2.5, 3.75, 5, 6.75, 8.5, 9.25, 10

To get smoother output more efficiently, change the refine factor instead of reducing the step size. When you change the refine factor, the solver generates additional points by evaluating a continuous extension formula at sample points. This option changes

the simulation step size so that time steps coincide with the times that you specify for additional output.

The refine factor applies to variable-step solvers and is most useful when you are using `ode45`. The `ode45` solver can take large steps. However, when you graph simulation output, the output from this solver sometimes is not sufficiently smooth. In such cases, run the simulation again with a larger refine factor. A value of such as 4 for `ode45` can provide much smoother results.

---

**Note** This option helps the solver locate zero crossings, although it does not ensure that Simulink detects all zero crossings (see “Zero-Crossing Detection” on page 3-24).

---

## Produce Additional Output

Use the `Produce additional output` option to specify directly those additional times at which the solver generates output. When you select this option, the **Data Import/Export** pane displays an **Output times** parameter. In this parameter, enter a MATLAB expression that evaluates to an additional time or a vector of additional times. The solver produces hit times at the output times that you specify, in addition to the times it requires for accurate simulation.

Suppose that a sample simulation generates output at these times:

0, 2.5, 5, 8.5, 10

Choosing the `Produce additional output` option and specifying `[0:10]` generates output at these times:

0, 1, 2, 3, 4, 5, 6, 7, 8, 9, 10

and perhaps at additional times, depending on the step size chosen by the variable-step solver.

### Tips

- This option helps the solver locate zero crossings, although it does not ensure that Simulink detects all zero crossings (see “Zero-Crossing Detection” on page 3-24).
- Set the **Output times** parameter to a value other than the default empty matrix (`[]`).
- For triggered subsystems and function-call subsystems, the calling function must inherit the sampling rate.

## Produce Specified Output Only

Simulink generates output at the start and stop times, in addition to the times that you specify.

Suppose that a sample simulation generates output at these times:

0, 2.5, 5, 8.5, 10

Choosing the **Produce specified output only** option and specifying [1:9] generates output at these times:

0, 1, 2, 3, 4, 5, 6, 7, 8, 9, 10

This option changes the simulation step size so that time steps coincide with the times that you specify for producing output. The solver can hit other time steps to accurately simulate the model. However, the output does not include these points. This option is useful when you are comparing different simulations to check that the simulations produce output at the same times.

### Tips

- This option helps the solver locate zero crossings, although it does not ensure that Simulink detects all zero crossings (see “Zero-Crossing Detection” on page 3-24).
- Set the **Output times** parameter to a value other than the default empty matrix ([ ]).
- In normal, accelerator, and rapid accelerator modes, Simulink generates output at the start and stop times, as well as at the times that you specify.
- When you simulate a model in normal mode, triggered subsystems and function-call subsystems use:
  - The times that you specify
  - All the time steps in between the values that you specify
  - The simulation start and stop times
- For triggered subsystems and function-call subsystems, the calling function must inherit the sampling rate.

### Related Examples

- “Limit Amount of Exported Data” on page 59-43

## **More About**

- “Zero-Crossing Detection” on page 3-24
- “Output options”

## Export Signal Data Using Signal Logging

### In this section...

“Signal Logging” on page 59-70

“Signal Logging Workflow” on page 59-70

“Signal Logging in Rapid Accelerator Mode” on page 59-71

“Signal Logging Limitations” on page 59-71

### Signal Logging

To capture signal data from a simulation, usually you can use signal logging. Mark the signals that you want to log and enable signal logging for the model. For details, see “Configure a Signal for Logging” on page 59-73 and “Enable Signal Logging for a Model” on page 59-88.

For a summary of other approaches to capture signal data, see “Export Simulation Data” on page 59-4.

### Signal Logging Workflow

To collect and use signal logging data, perform these tasks.

- 1 Mark individual signals for signal logging. See “Configure a Signal for Logging” on page 59-73.
- 2 Enable signal logging for a model. See “Enable Signal Logging for a Model” on page 59-88.
- 3 Simulate the model.
- 4 Access the signal logging data. See “Access Signal Logging Data” on page 59-106.

### Log Subsets of Signals

One approach for testing parts of a model as you develop it is to mark a superset of signals for logging. Then overriding signal logging settings to select different subsets of signals for logging. You can use the Signal Logging Selector or a programmatic interface. See “Override Signal Logging Settings” on page 59-92.

Use this approach to log signals in models that use model referencing. See “Models with Model Referencing: Overriding Signal Logging Settings” on page 59-96.

## Additional Signal Logging Options

With the basic signal logging workflow, you can specify additional options related to the data that signal logging collects and to how that data is displayed. You can:

- Specify a name for the signal logging data for a signal. See “Specify Signal-Level Logging Name” on page 59-75.
- Control how much data the simulation generates for a signal. See “Limit Data Logged” on page 59-77.
- Review the signal logging configuration for a model. See “View the Signal Logging Configuration” on page 59-81.
- Specify the samples for export for models with variable-step solvers. See “Samples to Export for Variable-Step Solvers” on page 59-66.
- Configure the model to display signal logging data in the Simulation Data Inspector. See “View Data in Simulation Data Inspector” on page 59-106.

## Signal Logging in Rapid Accelerator Mode

Signal logging in rapid accelerator mode does not log the following kinds of signals. When you update or simulate a model that contains these signals, Simulink displays a warning that those signals are not logged.

- Signals inside Stateflow charts
- Signals that use a custom data type

If you set the **Configuration Parameters > Solver > Periodic sample time constraint** parameter to **Ensure sample time independent**, you cannot use signal logging in rapid accelerator mode.

## Signal Logging Limitations

- Rapid accelerator mode supports signal logging, with the requirements and limitations described in “Signal Logging in Rapid Accelerator Mode” on page 59-71.
- Top-model and Model block software-in-the-loop (SIL) and processor-in-the-loop (PIL) simulation modes support signal logging. For a description of limitations, see “Top-Model SIL/PIL Limitations” (Embedded Coder) and “Model Block SIL/PIL Limitations” (Embedded Coder).

- Array of buses signals support signal logging, with the requirements described in “Import Array of Buses Data” on page 59-171.
- You cannot log signals in For Each subsystems.
- If you configure a bus signal or bus element for signal logging that is an input to a subsystem, you cannot automatically refactor the subsystem interface to use In Bus Element and Out Bus Element blocks. For details about that refactoring, see “Convert Models to Use Bus Element Ports” on page 63-30.
- You cannot log local data in Stateflow Truth Table blocks.

### **Related Examples**

- “Configure a Signal for Logging” on page 59-73
- “Enable Signal Logging for a Model” on page 59-88
- “Access Signal Logging Data” on page 59-106
- “Specify Signal-Level Logging Name” on page 59-75
- “Limit Data Logged” on page 59-77
- “View the Signal Logging Configuration” on page 59-81
- “View Data in Simulation Data Inspector” on page 59-106
- “Log Signals in For Each Subsystems” on page 59-111

### **More About**

- “Export Simulation Data” on page 59-4



## Configure a Signal for Logging

### In this section...

- “Mark a Signal for Logging” on page 59-73
- “Specify Signal-Level Logging Name” on page 59-75
- “Limit Data Logged” on page 59-77
- “Set Sample Time for a Logged Signal” on page 59-78

### Mark a Signal for Logging

Enable logging by marking a signal, using one of the following techniques:

- “Enable Logging Using Simulink Editor Menu Options” on page 59-73
- “Enable Logging Using Signal Properties” on page 59-74
- “Enable Logging Using the Model Data Editor” on page 59-74
- “Programmatic Interface” on page 59-75

The Simulink Editor menu options are generally the simplest way to mark signals for logging.

A signal for which you enable logging is a *logged signal*. By default, Simulink displays a logged signal indicator  for each logged signal.

#### Enable Logging Using Simulink Editor Menu Options

1 In the Simulink Editor, select one or more signals.

2

Click the **Simulation Data Inspector** button arrow  and select **Log Selected Signals**.

Alternatively, you can select one or more signals and check **Simulation > Output > Log Selected Signals**.

If you select multiple signals, the signal logging configuration that Simulink sets depends on whether any of the selected signals are marked for logging.

Signal Logging for Selected Signals	Result of Enabling the Log/Unlog Selected Signals Option
At least one of the selected signals does not have logging enabled.	Enables logging for all the selected signals
All selected signals have logging enabled.	Disables logging for all the selected signals

### Enable Logging Using Signal Properties

- 1 In the Simulink Editor, right-click the signal.
- 2 From the context menu, select **Properties**.
- 3 In the Signal Properties dialog box, in the **Logging and accessibility** tab, select **Log signal data**.
- 4 Click **OK**.

Alternatively, you can select the **Log Selected Signals** from the context menu that appears when you right-click the selected signal.

### Enable Logging Using the Model Data Editor

The Model Data Editor enables you to view a flat list of signals in your model. You can sort, group, and filter the list. Use this technique to enable logging for:

- Working with many signals at once, especially when the signals are not close to each other in the block diagram.
- Signals that are difficult to locate in a large model or hierarchy of subsystems.

To select signals to log using the Model Data Editor:

- 1 In the top menu of the model, select **View > Model Data**.
- 2 Click the **Signals** tab at the top of the Model Data Editor.
- 3 Ensure the **Instrumentation** option is selected on the **Change View** drop-down.
- 4 Check the boxes in the **Log Data** column for signals you would like to log.
- 5 Close the Model Data Editor when you have finished selecting signals to log.

See “Configure Data Properties by Using a Table” on page 57-123 for more information about the Model Data Editor.

## Programmatic Interface

To enable signal logging programmatically for selected blocks, use the output `DataLogging` property. Set this property using the `set_param` command. For example:

- 1 At the MATLAB Command Window, open a model. Type

```
vdp
```

- 2 Get the port handles of the signal that you want to log. For example, for the Mu block output signal.

```
ph = get_param('vdp/Mu', 'PortHandles')
```

- 3 Enable signal logging for the desired output signal.

```
set_param(ph.Output(1), 'DataLogging', 'on')
```

The logged signal indicator appears.

## Logging Referenced Model Signals

You can log any logged signal in a referenced model. Use the Signal Logging Selector to configure signal logging for a model reference hierarchy. For details, see “Models with Model Referencing: Overriding Signal Logging Settings” on page 59-96.

## Specify Signal-Level Logging Name

You can specify a signal-level logging name to the object that Simulink uses to store logging data for a signal. Specifying a signal-level logging name can be useful for signals that are unnamed or that share a duplicate name with another signal in the model hierarchy. Specifying signal-level logging names, rather than using the names that Simulink generates, can make the logged data easier to analyze.

To specify a signal-level logging name, use *one* of the following approaches:

- “Signal-Level Logging Name in the Editor” on page 59-76
- “Signal-Level Logging Name in Model Explorer” on page 59-76
- “Signal-Specific Logging Name Specified Programmatically” on page 59-76

If you do not specify a custom signal-level logging name, Simulink uses the signal name. If the signal does not have a name, the action Simulink uses a blank name.

---

**Note:** The signal-level logging name is distinct from the model-level signal logging name. The model-level signal logging name is the name for the object containing all the logged signal data for the whole model. The default model-level signal logging name is `logsout`. For details about the model-level signal logging name, see “Specify a Name for Signal Logging Data” on page 59-91.

---

### Signal-Level Logging Name in the Editor

- 1 In the Simulink Editor, right-click the signal.
- 2 From the context menu, select **Signal Properties**.
- 3 Specify the logging name:
  - a In the Signal Properties dialog box, select the **Logging and accessibility** tab.
  - b From the **Logging name** list, select **Custom**.
  - c Enter the logging name in the adjacent text field.

### Signal-Level Logging Name in Model Explorer

- 1 In the Model Explorer **Model Hierarchy** pane, select the node that contains the signal for which you want to specify a logging name.
- 2 If the **Contents** pane does not display the `LoggingName` property, add the `LoggingName` property to the current view. For details about column views, see “Customize Model Explorer Views” on page 12-39.
- 3 Enter a logging name for one or more signals using the `LoggingName` column.

### Signal-Specific Logging Name Specified Programmatically

Enable signal logging programmatically for selected blocks with the output `DataLogging` property. Set this property using the `set_param` command.

- 1 At the MATLAB Command Window, open a model. For example, type:  
`vdp`
- 2 Get the port handles of the signal that you want to log. For example, for the `Mu` block output signal:  
`ph = get_param('vdp/Mu', 'PortHandles');`
- 3 Enable signal logging for the desired output signal:  
`set_param(ph.Output(1), 'DataLogging', 'on');`

The logged signal indicator appears.

- 4 Issue commands that use the `DataLoggingNameMode` and `DataLoggingName` parameters. For example:

```
set_param(ph.Outputport(1), 'DataLoggingNameMode', 'Custom');
set_param(ph.Outputport(1), 'DataLoggingName', 'x2_log');
```

## Limit Data Logged

You can limit the amount of data logged for a signal by:

- Specifying a decimation factor
- Limiting the number of samples saved to be only the most recent samples

You can limit data logged for a signal by using the Signal Properties dialog box, the Model Explorer, the Signal Logging Selector, or programmatically. The following sections describe the first two approaches.

### Use Signal Properties to Limit Logged Data

- 1 In the Simulink Editor, right-click the signal.
- 2 From the context menu, select **Signal Properties**.
- 3 In the Signal Properties dialog box, click the **Logging and accessibility** tab. Then select one or both of these options:
  - **Limit data points to last**
  - **Decimation**

### Use Model Explorer to Limit Data Logged

- 1 In the Model Explorer **Model Hierarchy** pane, select the node that contains the signal for which you want to limit the amount of data logged.
- 2 If the **Contents** pane does not display the `DataLoggingDecimation` property or the `DataLoggingLimitDataPoints` property, add one or both of those properties to the current view. For details about column views, see “Customize Model Explorer Views” on page 12-39.
- 3 To specify a decimation factor, edit the `Decimation` and `DecimateData` properties. To limit the number of samples logged, edit the `LimitDataPoints` property.

## Set Sample Time for a Logged Signal

To set the sample time for a logged signal, in the Signal Properties dialog box, use the **Sample Time** option. This option:

- Separates design and testing, because you do not need to insert a Rate Transition block to have a consistent sample time for logged signals
- Reduces the amount of logged data for a continuous time signal, for which setting decimation is not relevant
- Eliminates the need to postprocess logged signal data for signals with different sample times

### Usage Notes

Do not specify a sample time for:

- Frame-based signals
- Conditional subsystems (for example, function-call or triggered subsystems) and conditional referenced models, which require an inherited sample time

If you simulate in SIL mode, signal logging ignores the sample times you specify for logged signals.

When you mark a signal for signal logging, Simulink inserts a hidden To Workspace block. When you specify a sample time for a logged signal, Simulink inserts a hidden Rate Transition block and a hidden To Workspace block.

Specifying a sample time for signal logging does not affect the simulation result. However, it is possible that the signal logging output for a logged signal varies depending on whether you specify a sample rate. For example, the interpolation method can differ depending on whether you specify a sample time for signal logging. Suppose that a model includes a continuous signal and the sample time is inherited (-1). The logged output for that signal shows that the interpolation method is **linear**.

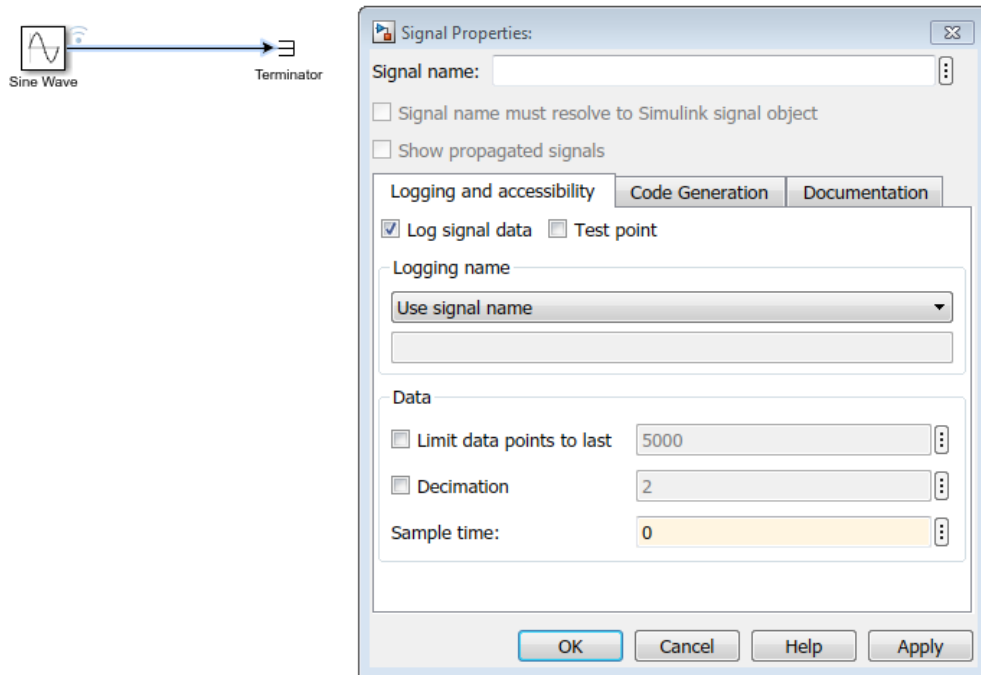

```
logout.get(1).Values.DataInfo
```

```
tdata.datametadate
Package: tdata
```

```
Common Properties:
    Units: ''
    Interpolation: linear (tdata.interpolation)
```

If you change the sample time to be continuous (0), the logged output for that signal shows that the interpolation method is ZOH (zero-order hold).

## Related Examples

- “Export Signal Data Using Signal Logging” on page 59-70
- “View the Signal Logging Configuration” on page 59-81
- “Enable Signal Logging for a Model” on page 59-88

- “Override Signal Logging Settings” on page 59-92
- “Log Signal Data That Uses Units” on page 59-40



## View the Signal Logging Configuration

### In this section...

- “Approaches for Viewing the Signal Logging Configuration” on page 59-81
- “Use Simulink Editor to View Signal Logging Configuration” on page 59-82
- “View Logging Configuration with Signal Logging Selector” on page 59-84
- “Use Model Explorer to View Signal Logging Configuration” on page 59-86
- “Programmatically Find Signals Configured for Logging” on page 59-87

### Approaches for Viewing the Signal Logging Configuration

Signal Logging Configuration Viewing Approach	Usage	Documentation
In the Simulink Editor, view signal logging indicators.	<p>Consider using this approach for models that have few signals marked for signal logging and have a shallow model hierarchy.</p> <p>This approach avoids leaving the Simulink Editor.</p> <p>Open the Signal Properties dialog box for each signal.</p>	“Use Simulink Editor to View Signal Logging Configuration” on page 59-82
Use the Signal Logging Selector.	<p>Consider using this approach for models with deep hierarchies.</p> <p>View a model that has signal logging override settings for some signals.</p> <p>View the configuration as part of specifying a subset of signals for logging from all signals marked for signal logging.</p>	“View Logging Configuration with Signal Logging Selector” on page 59-84

Signal Logging Configuration Viewing Approach	Usage	Documentation
	<p>View signal logging configuration without displaying the signal logging indicators in the model.</p> <p>View signal logging configuration information such as decimation and output options in one window.</p>	
Use the Model Explorer.	<p>View signal logging configuration in the context of other model component properties.</p> <p>Adjust the column view to display signal logging properties, if necessary.</p>	“Use Model Explorer to View Signal Logging Configuration” on page 59-86
Use MATLAB commands	Get the handles of the signals in the model and find the ones that have data logging enabled.	“Programmatically Find Signals Configured for Logging” on page 59-87

## Use Simulink Editor to View Signal Logging Configuration

By default, Simulink Editor displays an indicator on each signal that is marked for signal logging. To view the signal logging setting for a signal:

- 1 Right-click the signal. From the context menu, select **Signal Properties**.
- 2 Select the **Logging and accessibility** tab.

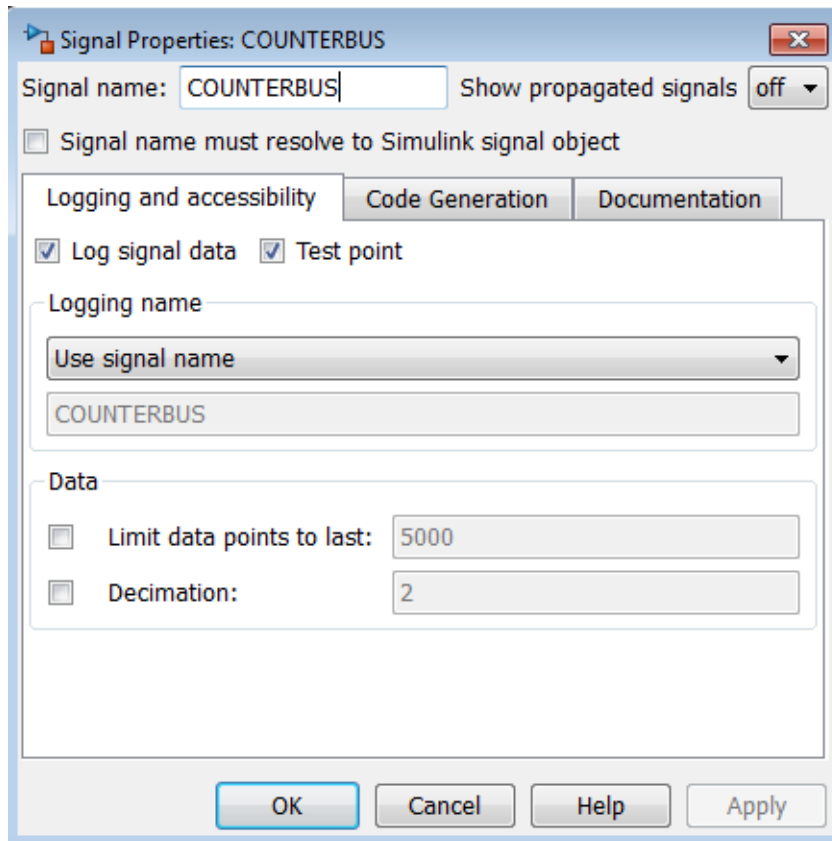

For example, in the following model the output of the Sine Wave block is logged:



If you use the command-line interface to override logging for a signal, the Simulink Editor continues to display the signal logging indicator for that signal. When you simulate the model, Simulink displays a red signal logging indicator for all signals marked to be logged, reflecting any overrides. For details about configuring a signal for logging, see “Configure a Signal for Logging” on page 59-73.

A logged signal can also be a test point. See “Test Points” on page 62-56 for information about test points.

To hide the logging indicators, clear **Display > Signals & Ports > Testpoint & Logging Indicators**.

## View Logging Configuration with Signal Logging Selector

- 1 Open the model for which you want to view the signal logging configuration.
- 2 Open the Signal Logging Selector, using one of the following approaches:
  - In the **Configuration Parameters > Data Import/Export** pane, in the **Signals** area, select the **Configure Signals to Log** button.

If necessary, select **Signal logging** to enable the **Configure Signals to Log** button.

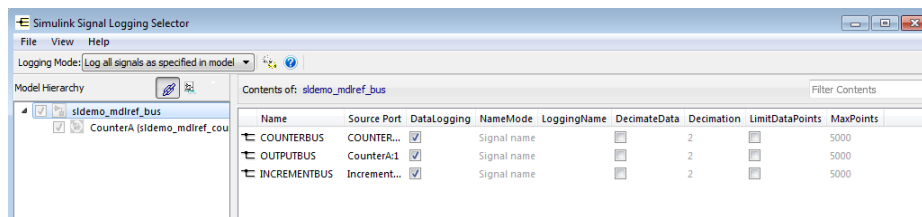

  - For a model that includes a Model block, you can also use the following approach:
    - a In the Simulink Editor, right-click a Model block.
    - b In the context-menu, select **Log Referenced Signals**.
- 3 In the **Model Hierarchy** pane, select the model node for which you want to view the signal logging configuration. For example:



To expand a node in the **Model Hierarchy** pane, right-click the arrow to the left of the node.

If no signals for a node are marked for signal logging, the **Contents** pane is empty.

For a model that references a model, the **Model Hierarchy** pane check box to the left of a model node indicates the override configuration of the node.

Check Box	Signal Logging Configuration
	<p>For the top-level model node, logs all logged signals in the top model.</p> <p>For a Model block node, logs all logged signals in the model reference hierarchy for that block.</p>
	<p>For the top-level model node, disables logging for all logged signals in the top model.</p> <p>For a Model block node, disables logging for all signals in the model reference hierarchy for that block.</p>
	<p>For the top-level model node, logs all logged signals that have the DataLogging setting enabled.</p> <p>For a Model block node, logs all logged signals in the model reference hierarchy for that block that have the DataLogging setting enabled.</p>

### View Configuration of Subsystems and Linked Libraries



The following table describes default **Model Hierarchy** pane display of subsystems, masked subsystems, and linked library nodes.

Node	Display Default
Subsystem	Displays subsystems all that include logged signals
Masked subsystem	Does not display masked subsystems
Linked library	Displays all subsystems that include logged signals

You can control how the **Model Hierarchy** pane displays subsystems, masked subsystems, and linked libraries. Use icons at the top of the **Model Hierarchy** pane or use the **View** menu, using the same approach as you use in the Model Explorer. For details, see “Display Linked Library Subsystems and Masked Subsystems” on page 12-14 and “Manage Existing Masks” on page 37-16.

- To display all subsystems, including subsystems that do not include signals marked for logging, select the  icon or **View > Show All Subsystems**. This

subsystem setting also applies to masked subsystems, if you specify to display masked subsystems.

- To display masked subsystems with logged signals, use the  icon or **View > Show Masked Subsystems**
- To display linked libraries, use the  icon or **View > Show Library Links**

### Filtering Signal Logging Selector Contents

To find a specific signal or property value for a signal, use the **Filter Contents** edit box. Use the same approach as you use in the Model Explorer; for details, see “Filtering Contents” on page 12-34.

### Highlighting a Block in a Model

To use the Model Hierarchy pane to highlight a block in model, right-click the block or signal and select **Highlight block in model**.

## Use Model Explorer to View Signal Logging Configuration

- 1 To access the logging configuration information for referenced models, open the model for which you want to view the signal logging configuration. Select the top-level model in a model reference hierarchy.
- 2 In the **Contents** pane, set **Column View** to the Signals view.

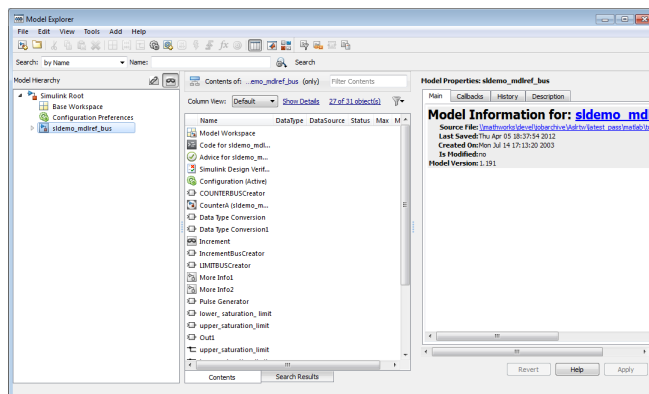

For further information, see “Model Explorer: Model Hierarchy Pane” on page 12-10 and “Model Explorer: Contents Pane” on page 12-18.

## Programmatically Find Signals Configured for Logging

Use MATLAB commands to get the handles of the signals in the model and find the ones that have data logging enabled. For example:

```
mdlsignals = find_system(gcs, 'FindAll', 'on', 'LookUnderMasks', 'all', ...  
    'FollowLinks', 'on', 'type', 'line', 'SegmentType', 'trunk');  
ph = get_param(mdlsignals, 'SrcPortHandle')  
for i=1: length(ph)  
    get_param(ph{i}, 'datalogging')  
end
```

## Related Examples

- “Configure a Signal for Logging” on page 59-73
- “View Logging Configuration with Signal Logging Selector” on page 59-84

## Enable Signal Logging for a Model

### In this section...

“Enable and Disable Logging at the Model Level” on page 59-88

“Migrate Scripts That Use ModelDataLogs API” on page 59-89

“Specify a Name for Signal Logging Data” on page 59-91

### Enable and Disable Logging at the Model Level

To log a signal, mark it for logging. For details, see “Configure a Signal for Logging” on page 59-73.

Enable or disable logging globally for all signals that you mark for logging in a model. By default, signal logging is enabled. Simulink logs signals only if the **Configuration Parameters > Data Import/Export > Signal logging** parameter is checked. If the option is not checked, Simulink ignores the signal logging settings for individual signals.

When signals are marked for logging, the signal data is logged to the workspace and also sent directly to the Simulation Data Inspector, by default. You can disable logging signals to the workspace through the Configuration Parameters dialog box or programmatically.

- In the Configuration Parameters dialog box, clear the **Configuration Parameters > Data Import/Export > Signal logging** parameter check box.
- From the command line, use the `SignalLogging` parameter.

```
set_param(bdroot, 'SignalLogging', 'off')
```

Data for signals marked for logging is always sent to the Simulation Data Inspector.

### Selecting a Subset of Signals to Log

You can select a subset of signals to log for a model that has:

- Signal logging enabled
- Logged signals

For details, see “Override Signal Logging Settings” on page 59-92.



## Migrate Scripts That Use ModelDataLogs API

For scripts that simulate a model created in a release earlier than R2016a that uses `ModelDataLogs` format for logging, update the code to log in `Dataset` format.

If you have already logged signal data in the `ModelDataLogs` format, you can use the `Simulink.ModelDataLogs.convertToDataset` function to update the `ModelDataLogs` signal logging data to use `Dataset` format. For example, to update the `older_model_dataset` from `ModelDataLogs` format to `Dataset` format:

```
new_dataset = logouts.convertToDataset('older_model_data')
```

Converting a model from using `ModelDataLogs` format to using `Dataset` format can require that you modify your existing models and to code in callbacks, functions, scripts, or tests. The following table identifies possible issues to address after converting to `Dataset` format. The table provides solutions for each issue.

Possible Issue After Conversion to Dataset Format	Solution
Code in existing callbacks, functions, scripts, or tests that used the <code>ModelDataLogs</code> programmatic interface to access data can result in an error.	<p>Check for code that uses <code>ModelDataLogs</code> format access methods. Update that code to use <code>Dataset</code> format access methods.</p> <p>For example, suppose that existing code includes the following line:</p> <pre>logouts.('Subsystem Name').X.data</pre> <p>Replace that code with a <code>Dataset</code> access method:</p> <pre>logouts.getElement('x').Values.data</pre>
Mux block signal names are lost.	The <code>Dataset</code> format treats Mux block signals as a vector. To identify signals by signal names, replace Mux blocks with Bus Creator blocks.
Signal Viewer cannot be used for signal logging.	<p>Simulink does not log signal logging data in the Signal Viewer.</p> <p>Use the signal logging output variable to view the logged data.</p>

Possible Issue After Conversion to Dataset Format	Solution
<p>The <code>unpack</code> method generates an error.</p>	<p>The <code>unpack</code> method, which is supported for <code>Simulink.ModelDataLogs</code> and <code>Simulink.SubsysDataLogs</code> objects, is <i>not</i> supported for <code>Simulink.SimulationData.Dataset</code> objects.</p> <p>For example, if the data in <code>mlog</code> has three fields: <code>x</code>, <code>y</code>, and <code>z</code>, then:</p> <p>For <code>ModelDataLogs</code> format data, the <code>mlog.unpack</code> method creates three variables in the base workspace.</p> <p>For <code>Dataset</code> format data, access methods by names. For example:</p> <pre>x = logout.getElement('x').Values</pre>
<p>The <code>ModelDataLogs</code> and <code>Dataset</code> formats have different naming rules for unnamed signals.</p>	<p>If necessary, add signal names.</p> <p>In <code>ModelDataLogs</code> format, for an unnamed signal coming from a block, Simulink assigns a name in this form:</p> <pre>SL_BlockName+&lt;portIndex&gt;</pre> <p>For example, <code>SL_Gain1</code>.</p> <p>In <code>Dataset</code> format, elements do not need a name, so Simulink leaves the signal name empty.</p> <p>For both <code>ModelDataLogs</code> and <code>Dataset</code> formats, Simulink assigns the same name to unnamed signals that come from Bus Selector blocks.</p>
<p>Test points in referenced models are not logged.</p>	<p>Consider enabling signal logging for test points in a referenced model.</p>

Possible Issue After Conversion to Dataset Format	Solution
Script uses <code>who</code> or <code>whos</code> functions.	Consider using <code>Simulink.SimulationData.Dataset.find</code> instead.

## Specify a Name for Signal Logging Data

You use the model-level signal logging name to access the signal logging data for a model. The default name for the signal logging data is `logouts`. Specifying a model-level signal logging name can make it easier to identify the source of the logged data. For example, you could specify the signal logging name `car_logouts` to identify the data as being the signal logging data for the `car` model.

To specify a different model-level signal logging name, use either of these approaches:

- In the edit box next to the **Configuration Parameters > Data Import/Export > Signal logging** parameter, enter the signal logging name.
- Use the `SignalLoggingName` parameter, specifying a signal logging name. For example:

```
set_param(bdroot, 'SignalLoggingName', 'heater_model_signals')
```

## Related Examples

- “Configure a Signal for Logging” on page 59-73
- “Export Signal Data Using Signal Logging” on page 59-70

## Override Signal Logging Settings

### In this section...

“Benefits of Overriding Signal Logging Settings” on page 59-92

“Two Interfaces for Overriding Signal Logging Settings” on page 59-92

“Scope of Signal Logging Setting Overrides” on page 59-93

“Override Signal Logging Settings with the Signal Logging Selector” on page 59-93

“Override Signal Logging Settings from MATLAB” on page 59-99

### Benefits of Overriding Signal Logging Settings

As you develop a model, you may want to override the signal logging settings for a specific simulation run. You can override signal logging properties without changing the model in the Simulink Editor.

Override signal logging properties to reduce memory overhead and to facilitate the analysis of simulation logging results. By overriding signal logging settings, you can avoid recompiling a model.

Overriding signal logging properties is useful when you want to:

- Focus on only a few signals by disabling logging for most of the signals marked for logging. You can mark a superset of signals for logging, and then select different subsets of them for logging.
- Exclude a few signals from the signal logging output.
- Override specific signal logging properties, such as decimation, for a signal.
- Collect only what you need when running multiple test vectors.

### Two Interfaces for Overriding Signal Logging Settings

Use either of two interfaces to override signal logging settings:

- “Override Signal Logging Settings with the Signal Logging Selector” on page 59-93
- “Override Signal Logging Settings from MATLAB” on page 59-99

You can use a combination of the two interfaces. The Signal Logging Selector creates `Simulink.SimulationData.ModelLoggingInfo` objects when

saving the override settings. The command-line interface has properties whose names correspond to the Signal Logging Selector interface. For example, the `Simulink.SimulationData.ModelLoggingInfo` class has a `LoggingMode` property, which corresponds to the **Logging Mode** parameter in the Signal Logging Selector.

## Scope of Signal Logging Setting Overrides

When you override signal logging settings, Simulink uses those override settings when you simulate the model.

Simulink saves in the model the signal logging override configuration that you specify. However, Simulink does not change the signal logging settings in the Signal Properties dialog box for each signal in the model.

In the Signal Logging Selector, if you override some signal logging settings, and then set the **Logging Mode** to **Log all signals as specified in model**, the logging settings defined in the model appear in the Signal Logging Selector. The override settings are greyed out, indicating that you cannot override these settings. To reactivate the override settings, set **Logging Mode** to **Override signals**. Using the Signal Logging Selector to override logging for a specific signal does not affect the signal logging indicator for that signal.

If you close and then reopen the model, the logging setting overrides that you made are in effect, if logging mode is set to override signals for that model. When the model displays the signal logging indicators, it displays the indicators for all logged signals, including logged signals that you have overridden.

---

**Note:** Simulink rebuilds a model in the following situation:

- 1 The model contains one or more signals marked for signal logging.
  - 2 You simulate the model in Rapid Accelerator mode.
  - 3 You use the Signal Logging Selector or MATLAB command line to modify the signal logging configuration.
  - 4 You simulate the model in Rapid Accelerator mode again.
- 

## Override Signal Logging Settings with the Signal Logging Selector

- 1 Open the Signal Logging Selector, using one of the following approaches:

- In the **Configuration Parameters > Data Import/Export** pane, in the **Signals** area, select the **Configure Signals to Log** button.

If necessary, select **Signal logging** to enable the **Configure Signals to Log** button.

- For a model that includes a Model block, you can also use the following approach:
  - a In the Simulink Editor, right-click a Model block.
  - b In the context-menu, select **Log Referenced Signals**.

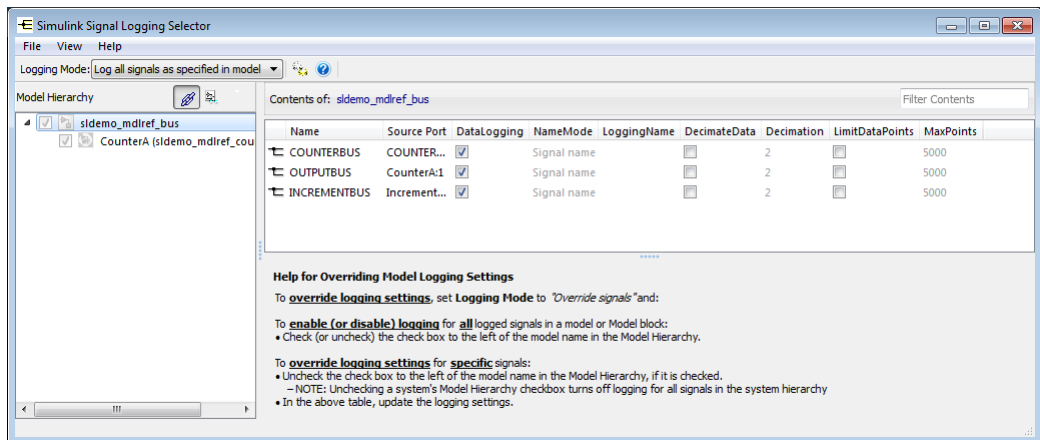

## 2 Set **Logging Mode** to **Override signals**.

**Note:** The **Override signals** setting affects all levels of the model hierarchy. This setting can result in turning off logging for any signal throughout the hierarchy, based on existing settings. To review settings, select the appropriate node in the **Model Hierarchy** pane.

- 3 View the node containing the logged signals that you want to override. If necessary, expand nodes or configure the Model Hierarchy pane to display masked subsystems. See "View Logging Configuration with Signal Logging Selector" on page 59-84.
- 4 Override signal logging settings. Use one of the following approaches, depending on whether or not your model uses model referencing:

- “Models Without Model Referencing: Overriding Signal Logging Settings” on page 59-95
- “Models with Model Referencing: Overriding Signal Logging Settings” on page 59-96

---

**Tip:** To open the **Configuration Parameters > Data Import/Export** pane from the Signal Logging Selector, use the  button.

---

### Models Without Model Referencing: Overriding Signal Logging Settings

If your model does not use model referencing (that is, the model does not include any Model blocks), override signal logging settings using the following procedure.

- 1 Open the Signal Logging Selector. In the **Configuration Parameters > Data Import/Export** pane, in the **Signals** area, select the **Configure Signals to Log** button.
  - If necessary, select **Signal logging** to enable the **Configure Signals to Log** button.

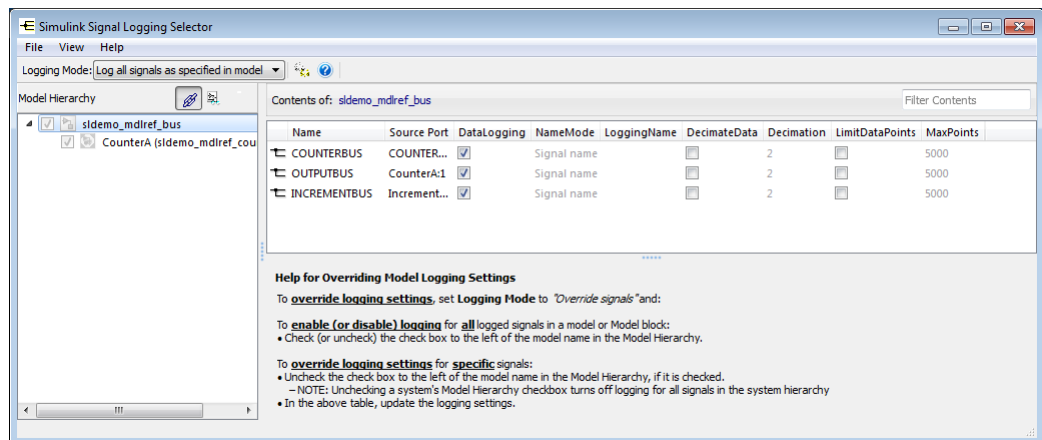

- 2 Set **Logging Mode** to **Override signals**.

- 3 View the node containing the logged signals that you want to override. If necessary, expand nodes or configure the Model Hierarchy pane to display masked subsystems. See “View Logging Configuration with Signal Logging Selector” on page 59-84.
- 4 In the **Contents** pane table, select the signal whose logging settings you want to override.
- 5 Override logging settings:
  - To disable logging for a signal, clear the **DataLogging** check box for that signal.
  - To override other signal logging settings (for example, decimation), ensure that the **DataLogging** check box is selected. Then, edit values in the appropriate columns.



### Models with Model Referencing: Overriding Signal Logging Settings

If your model uses model referencing (that is, the model includes at least one Model block), override signal logging settings using the one or more of the following procedures:

- “Enable Logging for All Logged Signals” on page 59-96
- “Disable Logging for All Logged Signals in a Model Node” on page 59-97
- “Override Signal Logging for a Subset of Signals” on page 59-97
- “Override Other Signal Logging Properties” on page 59-98

#### Enable Logging for All Logged Signals

By default, Simulink logs all the logged signals in a model, including the logged signals throughout model reference hierarchies.

If logging is disabled for any logged signals in the top-level model or in the top-level Model block in a model reference hierarchy, then in the **Model Hierarchy** pane, the check box to the left of that node is either solid () , if logging is disabled for some of signals, or empty () , if logging is disabled for all of the signals.

To enable logging of all logged signals for a node:

- 1 Open the Signal Logging Selector. In the **Configuration Parameters > Data Import/Export** pane, in the **Signals** area, select the **Configure Signals to Log** button.
- 2 Set **Logging Mode** to **Override** signals.



- 3 View the node containing the logged signals that you want to override. If necessary, expand nodes or configure the Model Hierarchy pane to display masked subsystems. See “View Logging Configuration with Signal Logging Selector” on page 59-84.
- 4 In the **Model Hierarchy** pane, select the check box to the left of the node, so that the check box has a check mark ().
  - For the top-level model, logging is enabled for all logged signals in the top-level model, but not for logged signals in model reference hierarchies.
  - For a Model block at the top of a model referencing hierarchy, logging is enabled for the whole model reference hierarchy for the selected referenced model.

#### Disable Logging for All Logged Signals in a Model Node



If signal logging is enabled for any signals in a model node, then in the **Model Hierarchy** pane, the check box to the left of the node is either solid () , if logging is enabled for some signals, or checked () , if logging is enabled for all signals.

To disable logging for all logged signals in a node of a model:

- 1 Open the Signal Logging Selector. In the **Configuration Parameters > Data Import/Export** pane, in the **Signals** area, select the **Configure Signals to Log** button.
- 2 Set **Logging Mode** to **Override** signals.
- 3 View the node containing the logged signals that you want to override. If necessary, expand nodes or configure the Model Hierarchy pane to display masked subsystems. See “View Logging Configuration with Signal Logging Selector” on page 59-84.
- 4 In the **Model Hierarchy** pane, clear the check box to the left of the node, so that the check box is empty ().
  - For the top-level model, logging is disabled for all logged signals in the top-level model, but not for logged signals in model reference hierarchies.
  - For a Model block at the top of a model referencing hierarchy, logging is disabled for the whole model reference hierarchy for the selected reference model.

#### Override Signal Logging for a Subset of Signals

To log some, but not all, logged signals in a model node:

- 1 Open the Signal Logging Selector. In the **Configuration Parameters > Data Import/Export** pane, in the **Signals** area, select the **Configure Signals to Log** button.
- 2 Set **Logging Mode** to **Override signals**.
- 3 View the node containing the logged signals that you want to override. If necessary, expand nodes or configure the Model Hierarchy pane to display masked subsystems. See “View Logging Configuration with Signal Logging Selector” on page 59-84.
- 4 In the **Model Hierarchy** pane, ensure that the check box for the top-level model or Model block is either solid () , if logging is disabled for some of the signals, or empty () , if logging is disabled for all the signals. Click the check box to cycle through different states.
- 5 In the **Contents** pane table, for the signals that you want to log, select the check box in the **DataLogging** column.

To enable logging for multiple signals, hold the **Shift** or **Ctrl** key and select a range of signals or individual signals. Select the check box in the **DataLogging** column of one of the highlighted signals.

---

**Note:** You cannot use the Signal Logging Selector to override a subset of signals for model reference variant systems, including:

- Model reference variants
- Model blocks that contain a Subsystem Variant or model reference variant



You can override programmatically a subset of signals in those configurations. For details, see “Override Signal Logging Settings from MATLAB” on page 59-99.

---

### Override Other Signal Logging Properties

In addition to overriding the setting for the **DataLogging** property for a signal, you can override other signal logging properties, such as decimation.

- 1 Open the Signal Logging Selector. In the **Configuration Parameters > Data Import/Export** pane, in the **Signals** area, select the **Configure Signals to Log** button.
- 2 Set **Logging Mode** to **Override signals**.

- 3 View the node containing the logged signals that you want to override. If necessary, expand nodes or configure the Model Hierarchy pane to display masked subsystems. See “View Logging Configuration with Signal Logging Selector” on page 59-84.
- 4 In the **Model Hierarchy** pane, ensure that the check box for the top-level model or Model block is solid () if logging is disabled for some signals, or empty () if logging is disabled for all signals. Click the check box to cycle through different states.
- 5 In the **Contents** pane table, for the signals for which you want to override logging properties, enable logging by selecting the check box in the **DataLogging** column.

To enable logging for multiple signals, hold the **Shift** or **Ctrl** key and select a range of signals or individual signals. Select the check box in the **DataLogging** column of one of the highlighted signals.

- 6 In the **Contents** pane table, modify the settings for properties, such as **DecimateData** and **Decimation**.

## Override Signal Logging Settings from MATLAB

The MATLAB command-line interface for overriding signal logging settings includes:

- The `DataLoggingOverride` model parameter — Use to view or set signal logging override values for a model
- The following classes:
  - `Simulink.SimulationData.ModelLoggingInfo` — Specify signal logging override settings for a model. This class corresponds to the overall Signal Logging Selector interface.
  - `Simulink.SimulationData.SignalLoggingInfo` — Override settings for a specific signal. This class corresponds to a row in the logging property table in the Signal Logging Selector:

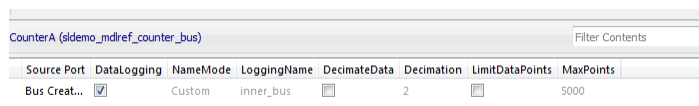

Source Port	DataLogging	NameMode	LoggingName	DecimateData	Decimation	LimitDataPoints	MaxPoints
Bus Creat...	<input checked="" type="checkbox"/>	Custom	inner_bus	<input type="checkbox"/>	2	<input type="checkbox"/>	5000

- `Simulink.SimulationData.LoggingInfo` — Overrides for signal logging settings such as decimation. This class corresponds to the editable columns in a row in the logging property table in the Signal Logging Selector.

To query a model for its signal logging override status, use the `DataLoggingOverride` parameter.

To configure signal logging from the command line, use methods and properties of the three classes listed above. To apply the configuration, use `set_param` with the `DataLoggingOverride` model parameter.

The following sections describe how to use the command-line interface to perform some common signal logging configuration tasks.

- “Create a Model Logging Information Object” on page 59-100
- “Specify Which Models to Log” on page 59-101
- “Log a Subset of Signals” on page 59-102
- “Override Other Signal Logging Properties” on page 59-104

### Create a Model Logging Information Object

To use the command-line interface for overriding signal logging settings, first create a `Simulink.SimulationData.ModelLoggingInfo` object. For example, use the following commands to create the model logging override object for the `ex_bus_logging` model and automatically add each logged signal in the model to that object:

```
open_system(docpath(fullfile(docroot, 'toolbox', 'simulink', ...
'examples', 'ex_bus_logging')));
open_system(docpath(fullfile(docroot, 'toolbox', 'simulink', ...
'examples', 'ex_mdhref_counter_bus')));
mi = Simulink.SimulationData.ModelLoggingInfo.createFromModel(...
'ex_bus_logging')

mi =

    ModelLoggingInfo with properties:

        Model: 'ex_bus_logging'
        LoggingMode: 'OverrideSignals'
        LogAsSpecifiedByModels: {}
        Signals: [1x4 Simulink.SimulationData.SignalLoggingInfo]
```

The `LoggingMode` property is set to `OverrideSignals`, which configures the model logging override object to log only the signals specified in the `Signals` property.

To apply the model override object settings, use:

```
set_param(ex_bus_logging, 'DataLoggingOverride', mi);
```

Simulink saves the settings when you save the model.

You can control the kinds of systems from which to include logged signals. By default, the `Simulink.SimulationData.ModelLoggingInfo` object includes logged signals from:

- Libraries
- Masked subsystems
- Referenced models
- Active variants

As an alternative, you can use the `Simulink.SimulationData.ModelLoggingInfo` constructor and specify a `Simulink.SimulationData.SignalLoggingInfo` object for each signal. To ensure that you specified valid signal logging settings for a model, use the `verifySignalAndModelPaths` method with the `Simulink.SimulationData.ModelLoggingInfo` object for the model.

### Specify Which Models to Log

Use the `LoggingMode` property of a `Simulink.SimulationData.ModelLoggingInfo` object to specify whether to use the signal logging settings as specified in the model and all referenced models, or to override those settings.

You can control whether a top-level model and referenced models use override signal logging settings or use the signal logging settings specified by the model, as described in the `Simulink.SimulationData.ModelLoggingInfo` documentation.

The following example shows how to log all signals as specified in the top model and all referenced models. The signal logging output is stored in `topOut`.

```
open_system(docpath(fullfile(docroot, 'toolbox', 'simulink', ...
'examples', 'ex_bus_logging')));
open_system(docpath(fullfile(docroot, 'toolbox', 'simulink', ...
'examples', 'ex mdlref_counter_bus')));
mi = Simulink.SimulationData.ModelLoggingInfo...
    ('ex_bus_logging');
mi.LoggingMode = 'LogAllAsSpecifiedInModel'

mi =
```

ModelLoggingInfo with properties:

```
Model: 'ex_bus_logging'
```

```
        LoggingMode: 'LogAllAsSpecifiedInModel'  
LogAsSpecifiedByModels: {}  
        Signals: []
```

To apply the model override object settings, use:

```
set_param(ex_bus_logging, 'DataLoggingOverride', mi);
```

The following example shows how to log only signals in the top model:

```
open_system(docpath(fullfile(docroot, 'toolbox', 'simulink', ...  
    'examples', 'ex_bus_logging')));  
open_system(docpath(fullfile(docroot, 'toolbox', 'simulink', ...  
    'examples', 'ex_mdhref_counter_bus')));  
mi = Simulink.SimulationData.ModelLoggingInfo...  
    ('ex_bus_logging');  
mi.LoggingMode = 'OverrideSignals';  
mi = mi.setLogAsSpecifiedInModel('ex_bus_logging', true);
```

To apply the model override object settings, use:

```
set_param(ex_bus_logging, 'DataLoggingOverride', mi);
```

Simulink saves the settings when you save the model.

### Log a Subset of Signals

For a simple model with a limited number of logged signals, you could create an empty `Simulink.SimulationData.ModelDataLogInfo` object. Then create `Simulink.SimulationData.SignalLoggingInfo` objects for each of the signals that you want to log, and assign those objects to the model logging information object.

```
open_system(docpath(fullfile(docroot, 'toolbox', 'simulink', ...  
    'examples', 'ex_bus_logging')));  
open_system(docpath(fullfile(docroot, 'toolbox', 'simulink', ...  
    'examples', 'ex_mdhref_counter_bus')));  
mdl = 'ex_bus_logging';  
blk = 'ex_bus_logging/IncrementBusCreator';  
blkPort = 1;  
  
load_system(mdl);  
  
ov = Simulink.SimulationData.ModelLoggingInfo(mdl);
```

```

so = Simulink.SimulationData.SignalLoggingInfo(blk,blkPort);

ov.Signals(1) = so;

% apply this object so the model
set_param mdl, 'DataLoggingOverride', ov);

% Simulate
sim(mdl);

% observe that only the signal
topOut

```

To apply the model override object settings, use:

```
set_param(mdl, 'DataLoggingOverride', ov);
```

Simulink saves the settings when you save the model.

For a model that uses model referencing, or that is complex, to specify a subset of logged signals to log, consider using the `findSignal` method with a `Simulink.SimulationData.ModelLoggingInfo` object. For example, to log only one signal from the referenced model instance referenced by :

```

open_system(docpath(fullfile(docroot, 'toolbox', 'simulink', ...
'examples', 'ex_bus_logging')));
open_system(docpath(fullfile(docroot, 'toolbox', 'simulink', ...
'examples', 'ex_mdhref_counter_bus')));

mi = Simulink.SimulationData.ModelLoggingInfo.createFromModel(...
    'ex_bus_logging');
pos = mi.findSignal({'ex_bus_logging/CounterA' ...
    'ex_mdhref_counter_bus/Bus Creator'}, 1)

pos =

    4

for idx=1:length(mi.Signals)
    mi.Signals(idx).LoggingInfo.DataLogging = (idx == pos);
end

```

To apply the model override object settings, use:

```
set_param(ex_bus_logging, 'DataLoggingOverride', mi);
```

Simulink saves the settings when you save the model.

---

**Note:** You can override programmatically a subset of signals for model reference variant systems, including:

- Model reference variants
- Model blocks that contain a Subsystem Variant or model reference variant

To log a subset of signals for these model reference variant systems, set the `SignalLoggingSaveFormat` parameter to `Dataset`.

---

### Override Other Signal Logging Properties

In addition to overriding the setting for the `DataLogging` property for a signal, you can override other signal logging properties, such as decimation.

Use `Simulink.SimulationData.LoggingInfo` properties to override signal logging properties. The following example shows how to set the decimation override settings.

```
open_system(docpath(fullfile(docroot, 'toolbox', 'simulink', ...
    'examples', 'ex_bus_logging')));
open_system(docpath(fullfile(docroot, 'toolbox', 'simulink', ...
    'examples', 'ex_mdhref_counter_bus')));
mi = Simulink.SimulationData.ModelLoggingInfo.createFromModel...
    ('ex_bus_logging');
pos = mi.findSignal({'ex_bus_logging/CounterA' ...
    'ex_mdhref_counter_bus/Bus Creator'}, 1);
mi.Signals(pos).LoggingInfo.DecimateData = true;
mi.Signals(pos).LoggingInfo.Decimation = 2;
```

To apply the model override object settings, use:

```
set_param(ex_bus_logging, 'DataLoggingOverride', mi);
```

Simulink saves the settings when you save the model.

### Related Examples

- “Configure a Signal for Logging” on page 59-73



- “Export Signal Data Using Signal Logging” on page 59-70

## **More About**

- “Override Signal Logging Settings with the Signal Logging Selector” on page 59-93

## Access Signal Logging Data

### In this section...

“View Signal Logging Data” on page 59-106

“View Data in Simulation Data Inspector” on page 59-106

“Signal Logging Object” on page 59-107

“Access Data Programmatically” on page 59-107

“Handling Spaces and Newlines in Logged Names” on page 59-108

“Access Logged Signal Data in ModelDataLogs Format” on page 59-110

### View Signal Logging Data

You can view the signal logging data for a paused or completed simulation, using one of these interfaces:

- The Simulation Data Inspector
- Programmatically, using MATLAB commands

---

**Tip:** If you do not see logging data for a signal that you marked in the model for signal logging, check the logging configuration. Use the Signal Logging Selector to enable logging for a signal whose logging is overridden. For details, see “View the Signal Logging Configuration” on page 59-81 and “Override Signal Logging Settings” on page 59-92.

---

### View Data in Simulation Data Inspector

You can use the Simulation Data Inspector to view data for signals marked for logging.

- 1 Open the model.
- 2 Select **Simulation > Output > Send Logged Workspace Data to Data Inspector**.
- 3 Select **Simulation > Output > Simulation Data Inspector**.
- 4 Simulate the model.

For additional information about using the Simulation Data Inspector, see “Simulation Data Inspector in Your Workflow” on page 27-2.

## Signal Logging Object

Simulink saves signal logging data in a `Simulink.SimulationData.Dataset` object, which is a MATLAB workspace variable. The default name of the signal logging variable is `logouts`. You can change the variable name. For details, see “Specify a Name for Signal Logging Data” on page 59-91.

Releases earlier than R2016a also supported a `ModelDataLogs` format. For details, see “Migrate Scripts That Use ModelDataLogs API” on page 59-89.

## Access Data Programmatically

You can use the `Simulink.SimulationData.Dataset` API to access signal logging data programmatically. To access `Dataset` object elements, use indexing with curly braces. For example, you can access the first element of the `topOut` signal logging `Dataset` object using an index.

```
open_system(docpath(fullfile(docroot, 'toolbox', 'simulink', ...
    'examples', 'ex_bus_logging')));
open_system(docpath(fullfile(docroot, 'toolbox', 'simulink', ...
    'examples', 'ex_mdref_counter_bus')));
sim('ex_bus_logging')
topOut
```

```
Simulink.SimulationData.Dataset 'topOut' with 4 elements
```

	Name	BlockPath
1 [1x1 Signal]	COUNTERBUS	ex_bus_logging/COUNTERBUSCreator
2 [1x1 Signal]	OUTPUTBUS	ex_bus_logging/CounterA
3 [1x1 Signal]	INCREMENTBUS	ex_bus_logging/IncrementBusCreator
4 [1x1 Signal]	inner_bus	...erA ex_mdref_counter_bus/Bus Creator

- Use braces { } to access, modify, or add elements using index.

```
element1 = topOut{1}
```

```
element1 =
```

```
Simulink.SimulationData.Signal
```

```
Package: Simulink.SimulationData

Properties:
    Name: 'COUNTERBUS'
    PropagatedName: ''
    BlockPath: [1x1 Simulink.SimulationData.BlockPath]
    PortType: 'output'
    PortIndex: 1
    Values: [1x1 struct]
```

Methods, Superclasses

`element1.Values`

`ans =`

```
    data: [1x1 timeseries]
    limits: [1x1 struct]
```

To search for specific elements in a `Dataset` object, use the `find` method. To return the names of the `Dataset` object elements, use the `getNames` method.

---

**Tip:** To call a function on each specified MATLAB `timeseries` object, you can use the `Simulink.SimulationData.forEachTimeseries` function. For example, you can use this function to easily resample every element of a structure of `timeseries` objects obtained by logging a bus signal.

---

## Handling Spaces and Newlines in Logged Names

Signal names in data logs can have spaces or newlines in their names when:

- The signal is named and the name includes a space or newline character.
- The signal is unnamed and originates in a block whose name includes a space or newline character.
- The signal exists in a subsystem or referenced model (or any parent block) whose name includes a space or newline character.

The following three examples show signals whose names contain:

- A space

- A signal whose name contains a newline
- An unnamed signal that originates in a block whose name contains a newline

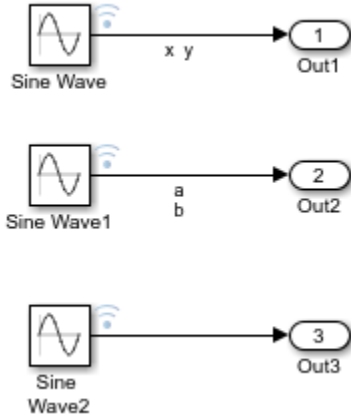

The following example shows how to handle spaces or new lines in logged names when a model uses the default of `logouts` for the signal logging data.

`logouts`

Simulink.SimulationData.Dataset 'logouts' with 3 elements

	Name	BlockPath
1 [1x1 Signal]	' '	untitled/Sine Wave2
2 [1x1 Signal]	x y	untitled/Sine Wave
3 [1x1 Signal]	x y	untitled/Sine Wave1

- Use braces `{ }` to access, modify, or add elements using index.

To access a signal with a space or newline, use the index. For example, to access the `x y` signal:

```
>> logouts.getElement(2)
```

```
ans =
```

```
Simulink.SimulationData.Signal
Package: Simulink.SimulationData
```

```
Properties:
    Name: 'x y'
    PropagatedName: ''
    BlockPath: [1x1 Simulink.SimulationData.BlockPath]
    PortType: 'outport'
    PortIndex: 1
    Values: [1x1 timeseries]
```

## Access Logged Signal Data in ModelDataLogs Format

Before R2016a, you could log signals in ModelDataLogs format. Starting in R2016a, you cannot log data in the ModelDataLogs format. Signal logging uses the Dataset format.

However, you can use data that was logged in a previous release using ModelDataLogs format.

For more information, see `Simulink.ModelDataLogs`.

## See Also

`Simulink.SimulationData.Dataset.get` | `Simulink.SimulationData.Dataset.find`  
| `Simulink.SimulationData.Dataset.getElementNames`  
| `Simulink.SimulationData.Dataset.numElements`  
| `Simulink.SimulationData.Dataset.setElement` |  
`Simulink.SimulationData.Dataset` | `Simulink.SimulationData.BlockPath`  
| `Simulink.SimulationData.forEachTimeseries` |  
`Simulink.SimulationData.Signal`

## Related Examples

- “Save Runtime Data from Simulation”
- “Export Signal Data Using Signal Logging” on page 59-70
- “Migrate Scripts That Use ModelDataLogs API” on page 59-89
- “Log Signals in For Each Subsystems” on page 59-111

## Log Signals in For Each Subsystems

### In this section...

“Log Signal in Nested For Each Subsystem” on page 59-111

“Log Bus Signals in For Each Subsystem” on page 59-113

The approach you use to log data for a signal in a For Each subsystem depends on whether the signal is a:

- Nonbus signal — Log directly in a For Each subsystem
- A bus or array of buses signal — Use one of these approaches:
  - Use a Bus Selector block to select the signals you want to log and mark those signals for signal logging. This approach works well for many models.
  - Attach the signal to an Outport block and log the signal outside of the For Each subsystem. Use this approach when you want to log a whole bus signal, and that bus signal includes many bus element signals.

---

**Note:** You can not log a signal inside a referenced model that is inside a For Each subsystem if either of these conditions exists:

- The For Each subsystem is in a model simulating in rapid accelerator mode.
  - The For Each subsystem itself is in a model referenced by a Model block in accelerator mode.
- 

The data for each logged signal in a For Each subsystem is saved in a separate **Dataset** element as a `Simulink.SimulationData.Signal` object. Each signal object contains an array of MATLAB `timeseries` objects as values.

### Log Signal in Nested For Each Subsystem

This example logs a signal in a nested For Each subsystem.

Open the `ex_loginsideforeach_nested` model.

```
open_system(docpath(fullfile(docroot, 'toolbox', 'simulink', ...
'examples', 'ex_loginsideforeach_nested.slx')))
```

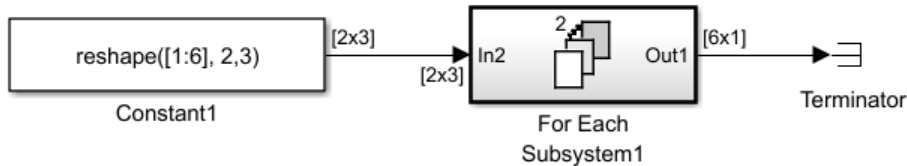

In the Simulink Editor, open the For Each Subsystem1 block, and inside that subsystem, open the For Each Subsystem2 block.

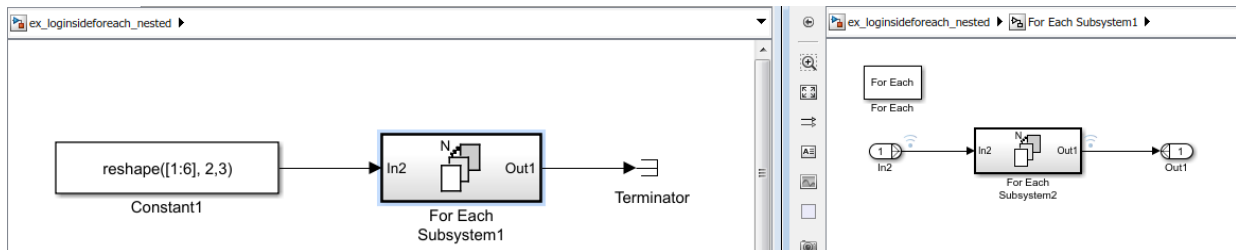

Simulate the model and examine the signal logging data for the first iteration of the top subsystem and the third iteration of the bottom subsystem.

```
sim('ex_loginsideforeach_nested');
logout.get('nestedDelay')
```

ans =

```
Simulink.SimulationData.Signal
Package: Simulink.SimulationData
```

Properties:

struct with fields:

```
        Name: 'nestedDelay'
PropagatedName: ''
        BlockPath: [1x1 Simulink.SimulationData.BlockPath]
        PortType: 'outport'
        PortIndex: 1
        Values: [2x3 timeseries]
```



```
logout.get('nestedDelay').Values(1,3)

timeseries

Common Properties:
    Name: 'nestedDelay'
    Time: [5x1 double]
    TimeInfo: [1x1 tsdata.timemetadata]
    Data: [1x1x5 double]
    DataInfo: [1x1 tsdata.datametadata]
```

## Log Bus Signals in For Each Subsystem

This example logs a two bus signal in a For Each subsystem. For one bus signal, you use a Bus Selector block and then log each selected signal. For the other bus signal, you use Outport blocks and log outside of the For Each subsystem.

Open the `ex_for_each_log_bus` model.

```
open_system(docpath(fullfile(docroot,'toolbox','simulink',...
'examples','ex_for_each_log_bus.slx')))
```

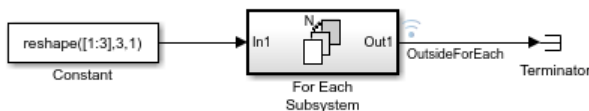

In the Simulink Editor, open the For Each Subsystem block.

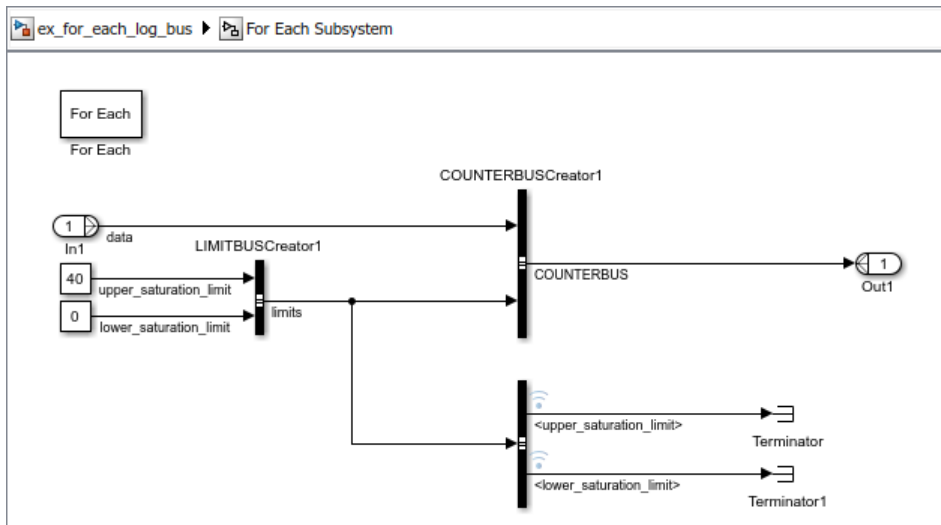

To log the signals in the `limits` bus signal, the signal is branched to a Bus Selector block, and each of the bus element signals is marked for signal logging.

To log the whole `COUNTERBUS` signal, the bus signal is connected to an Outport block. The output signal from the For Each subsystem is marked for signal logging. To have the bus signal cross the subsystem boundary, the Bus Creator block that creates the `COUNTERBUS` signal has the **Output data type** parameter set to `Bus: COUNTERBUS` and **Output as nonvirtual bus** check box selected.

Simulate the model and examine the signal logging output, focusing on one of the bus element signals logged inside the For Each subsystem and on the bus signal logged outside of the For Each subsystem.

```
sim('ex_for_each_log_bus');
logout
```

```
Simulink.SimulationData.Dataset 'logout' with 3 elements
```

	Name	BlockPath
1	[1x1 Signal] OutsideForEach	ex_for_each_log_bus/For Each Subsystem
2	[1x1 Signal] <lower_saturation_limit>	...g_bus/For Each Subsystem/Bus Selector
3	[1x1 Signal] <upper_saturation_limit>	...g_bus/For Each Subsystem/Bus Selector

- Use braces { } to access, modify, or add elements using index.

```
logout{2}.Values
```

```
3×1 timeseries array with properties:
```

```
Events
Name
UserData
Data
DataInfo
Time
TimeInfo
Quality
QualityInfo
IsTimeFirst
TreatNaNasMissing
Length
```

```
logout{1}.Values
```

```
ans =
```

```
3×1 struct array with fields:
```

```
data
limits
```

## See Also

### Blocks

For Each Subsystem

### Functions

Simulink.SimulationData.Dataset | Simulink.SimulationData.Signal

## Related Examples

- “Export Signal Data Using Signal Logging” on page 59-70

## Overview of Signal Loading Techniques

### In this section...

“Source Blocks” on page 59-116

“Root-Level Input Ports” on page 59-117

“From File Block” on page 59-119

“From Spreadsheet Block” on page 59-120

“From Workspace Block” on page 59-121

“Signal Builder Block” on page 59-122

Simulink provides several techniques for importing signal data into a model. Each of the signal data loading techniques uses blocks to represent signal data sources visually.

For additional details about which technique to use to meet specific modeling requirements, see “Comparison of Techniques” on page 59-126.

### Source Blocks

You can add a source block, such as a Sine Wave block, to generate signals to input to another block. To specify how to generate the signal, use the Block Parameters dialog box. For example, in the Sine Wave Block Parameters dialog box, you can specify the `sim` function to use and time-based or sample-based data.

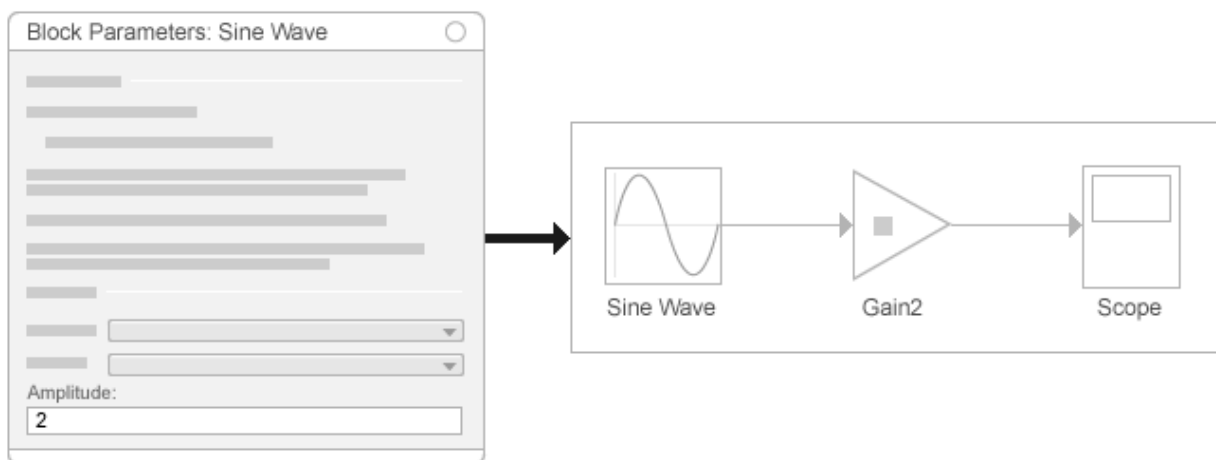

The output data types of source blocks vary. For example, a Sine Wave block outputs a vector of real doubles.

For an example of using a source block, see “Build and Edit a Model in the Simulink Editor” on page 1-24.

### Recommended Uses

- Do initial prototyping in a model, when the generated signal data serves your modeling requirements
- Avoid creating the data manually.
- Reduce memory consumption. Source blocks do not store signal data.
- Make the kind of signal data visually clear in the model.

### Limitations

Source blocks generate signals based on a predefined algorithm. To use actual data from an external source or to test a model without having to modify the model, use a different signal loading technique.

## Root-Level Input Ports

You can import signal data from a workspace and apply it to a root-level input port using one of these blocks:

- Enable
- Inport
- Trigger block that has an edge-based (rising, falling, or either) trigger type

The root-level input ports load external inputs from the MATLAB (base), model, or mask workspace. These blocks import data from the workspace based on the value of the **Configuration Parameters > Data Import/Export > Input** parameter or a **sim** command argument. For an example, see “Import Data to Model a Continuous Plant” on page 59-140.

To import many signals to root-level input ports, consider using the Root Inport Mapper tool. This tool updates the **Input** configuration parameter based on the signal data that you import and map to root-level input ports. For an example, see “Map Data Using Root Inport Mapper Tool” on page 59-132.

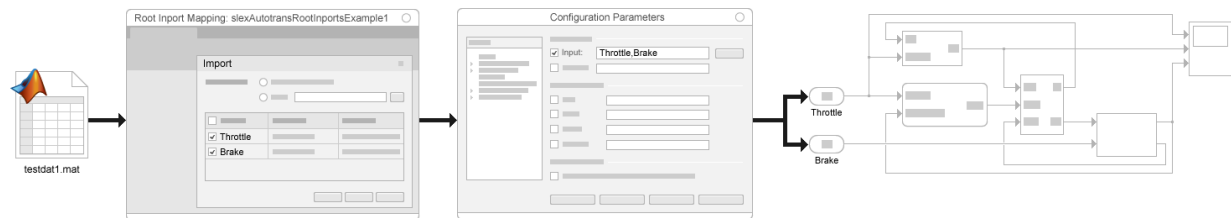

## Recommended Uses

Use root input ports to:

- Import many signals to many blocks
- Test your model as a referenced model in a wider context with signals from the workspace, without modifying your model

For importing signal data to meet most modeling requirements and to maintain model flexibility, root-level inport mapping is a convenient technique. Root-level inport mapping:

- Displays signal data for you to inspect without loading all the signal data into MATLAB memory
- Provides memory-efficient signal viewing

## Requirements

To ensure that the Simulink variable solver executes at the times that you specify in the imported data, set the **Configuration Parameters > Data Import/Export > Additional parameters > Output options** parameter to Produce additional output.

## Limitations

- You cannot use input ports to import buses in external modes. To import bus data in rapid accelerator mode, use **Dataset** format.
- The Root Inport Mapper tool supported map modes depend on the data type of a signal. For details, see “Choose a Base Workspace and MAT-File Format” on page 59-182.

## From File Block

A From File block reads data from a MAT-file and outputs the data as a signal.



For an example, see “From File Block Loading Timeseries Data”.

### Recommended Uses

Consider using a From File block for loading:

- Large amounts of data. For a Version 7.3 MAT-file, the From File block loads data incrementally from the MAT-file during simulation.

---

**Tip:** To convert a Version 7.0 file to Version 7.3 (for example, `my_data_file.mat` that contains the variable `var`), at the MATLAB command line, enter:

```
load('my_data_file.mat')
save('my_data_file.mat', 'var', '-v7.3')
```

---

- Data that was exported to a To File block. The From File block reads data written by a To File block without any you modifying the data or making other special provisions.
- Data stored in a MAT-file that is separate from the model file.

### Limitations

- For *Version 7.0* or earlier MAT-file, the From File block reads only array-format data.

- Version 7.3 and Version 7.0 or earlier MAT-files handle multiple variables differently. See “MAT-File Variable” on page 59-155.
- The From File block supports reading nonvirtual bus signals in MATLAB `timeseries` format.
- For array data, the From File block reads only double signal data.
- Code generation that involves building ERT or GRT targets, or using SIL or PIL simulation modes, has some special considerations. See “Code Generation Requirements”.

## From Spreadsheet Block

The From Spreadsheet block reads data from Microsoft Excel spreadsheets (all platforms) or CSV spreadsheets (Microsoft Windows platform with Microsoft Office only) and outputs the data as one or more signals.

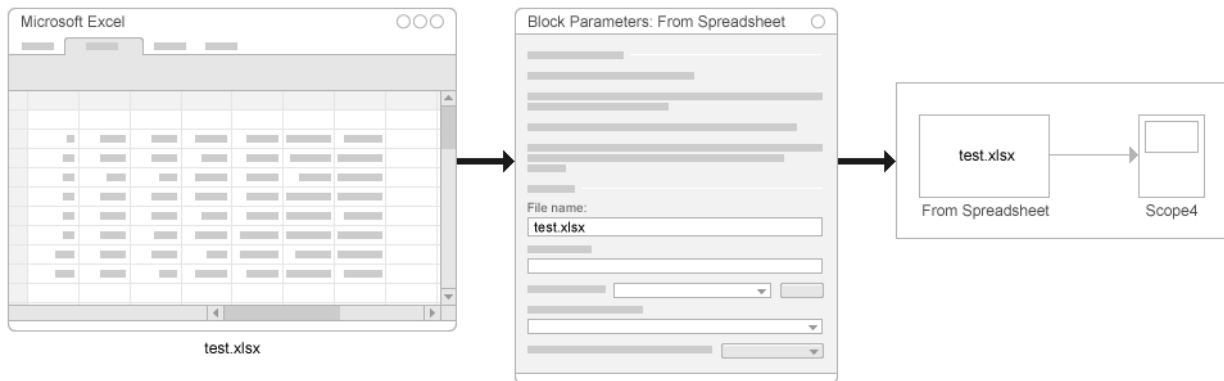

### Recommended Uses

Use the From Spreadsheet block for loading:

- Large Microsoft Excel or CSV spreadsheets. The From Spreadsheet block incrementally reads data from the spreadsheet during simulation, rather than loading the data into Simulink memory.
- Spreadsheets that you expect to modify. The From Spreadsheet block handles changes to worksheet values automatically, because it loads data directly from the spreadsheet.



## Limitations

- You cannot import bus data.
- The From Spreadsheet file has requirements for the spreadsheet data. Organize Excel spreadsheet data using the format described in “Supported Microsoft Excel File Formats” on page 59-185.
- Linux and Mac platforms do not support using a From Spreadsheet block to import data from a CSV spreadsheet.

## From Workspace Block

The From Workspace block reads signal data from a workspace and outputs the data as a signal. In the Block Parameters dialog box, in the **Data** parameter, enter a MATLAB expression that specifies the workspace data.



For an example of how to use a From Workspace block, see “Use From Workspace Block for Test Case” on page 59-146.

## Recommended Uses

Use the From Workspace block for loading:

- A small set of signal data to perform local, temporary testing
- Data from the MATLAB (base), model, mask, or function workspace
- Variable-size signals

- Data that you saved using a To Workspace block in MATLAB `timeseries` format, without manual changes to the data
- Data saved in a previous simulation by a To Workspace block in either `Timeseries` or `Structure with Time` format for use in a later simulation

### Limitations

- The data expressions that you specify must evaluate to one of these types of data:
  - A MATLAB `timeseries` object
  - A structure of MATLAB `timeseries` objects
  - An array or structure containing an array of simulation times and corresponding signal values

## Signal Builder Block

Using a Signal Builder block, you can create interchangeable groups of piecewise linear signal sources to use in a model.

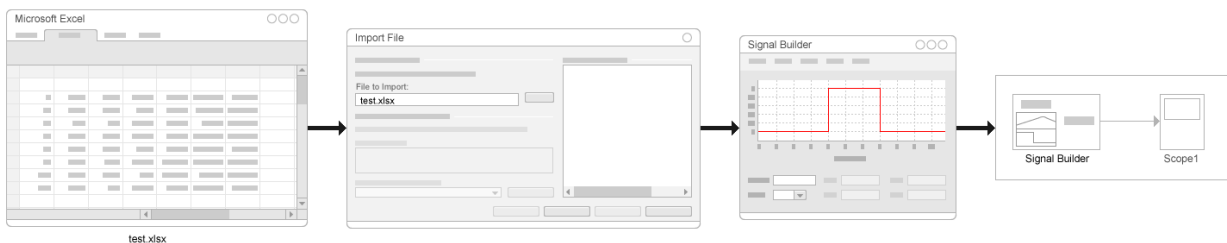

For examples of how to use a Signal Builder block, see:

- “Import Data for an Input Test Case” on page 59-145
- `sldemo_pid2dof`
- `sf_test_vectors`

### Recommended Uses

Use the Signal Builder block to create and load signal groups to use in testing.

These products integrate the Signal Builder block into their workflows:

- Simulink Test
- Simulink Verification and Validation

### **Limitations**

- The Signal Builder block has requirements for the spreadsheet data. Organize Excel spreadsheet data using the format described in “Importing Signal Group Sets” on page 62-81.
- Data stores are not supported.
- The data type for signals must be **double**.

### **Related Examples**

- “Load Data to Root-Level Input Ports” on page 59-164
- “Map Data Using Root Inport Mapper Tool” on page 59-132
- “Load Data Using the From File Block” on page 59-239
- “Load Data Using the From Workspace Block” on page 59-242
- “Load Signal Data That Uses Units” on page 59-237

### **More About**

- “Comparison of Signal Loading Techniques” on page 59-124

## Comparison of Signal Loading Techniques

### In this section...

“Techniques” on page 59-124

“Impact of Loading Techniques on Block Diagrams” on page 59-125

“Comparison of Techniques” on page 59-126

### Techniques

Simulink provides several techniques for importing signal data into a model. Each signal data loading technique uses a block to represent signal data sources visually. You can use a:

- Source block, such as the Sine Wave block, to generate signal data as input to another block
- Root-level input port (Inport, Enable, or Trigger block). Loading signal data to root-level input ports, either manually or by using the Root Inport Mapper tool. This section uses “Root-level input ports” to address both approaches and “Root Inport Mapper tool” to refer specifically to that approach.
- From File block
- From Spreadsheet block
- From Workspace block
- Signal Builder block

### Suggested Signal Loading Techniques

Modeling Requirement	Suggested Signal Loading Technique
Signal values that Source blocks generate meet your requirements	Source block
Initial prototyping	From File, From Spreadsheet, or From Workspace block
System testing, sharing, and code generation	Root-level input port

Modeling Requirement	Suggested Signal Loading Technique
	You can use the Root Inport Mapper tool to create and map

For many models, loading signal data to a root inport block is an effective approach. The Root Inport Mapping tool on page 59-132 provides a convenient way to load data for several signals to root inports.

To identify signal data loading techniques to meet specific modeling requirements, see “Comparison of Techniques” on page 59-126.

## Impact of Loading Techniques on Block Diagrams

To test reusable systems, it is helpful to separate signal data loading from the block diagram. Loading root-level input ports provides a good framework for testing complex systems on an ongoing basis. Using the Root Inport Mapper tool allows you to visualize the signal data that is loaded.

To perform temporary testing on standalone models, adding data loading blocks can be simpler and make the source of the signal data visible from within the block diagram.

To avoid adding data loading blocks to a model, load the signal data to root-level input ports. You can change the data to use by changing the **Configuration Parameters > Data Import/Export > Input** parameter. You do not need to add or change blocks, or reset block parameters. You can use the Root Inport Mapper tool to update the **Input** parameter so that it reflects the mapping of signal data to the appropriate ports.

### Test Harness Models

You can use a test harness models with different test cases to load:

- Different signal data to a port
- Signal data to different ports

The Signal Builder block is useful in test harness models to simplify loading data to multiple input ports.

Alternatively, you can use the Root Inport Mapper tool to create scenarios that you can use instead of creating separate test harness models. Creating separate test harness

models can be simpler to create than setting up root inport mapping. However, you then need to manage the separate test harness models. For an example of using root inport mapping instead of a test harness, see “Converting Harness-Driven Models to Use Harness-Free External Inputs” on page 59-216

## Comparison of Techniques

Each technique addresses many of these modeling considerations:

- “Purpose of Importing Signal Data” on page 59-126
- “Signal Data” on page 59-127
- “Data Format or Type” on page 59-127
- “Bus Support” on page 59-128
- “Time Points” on page 59-129
- “Location for Data Storage” on page 59-129
- “Signal Data Inspection” on page 59-130
- “Handling of Loaded Data” on page 59-130
- “Simulation Mode” on page 59-130

### Purpose of Importing Signal Data

The model development phase you are in and your goals for loading signal data can influence the signal loading technique that you choose.

Modeling Goal	Supported Techniques
Perform local, temporary testing by importing a small set of signal data	All From File, From Spreadsheet, and From Workspace blocks work well for this goal. Root-level input ports for reusable systems.
Test a model that you want to use as a referenced model	Root-level input ports
Verify a model by using multiple test cases	Root Inport Mapper tool, using exported signal data.

Modeling Goal	Supported Techniques
Represent a continuous plant	All Root-level input ports work well for this goal.
Test a discrete algorithm	All Root-level input ports work well for this goal.

### Signal Data

The amount, source, and kind of the signal data can influence the signal loading technique that you choose.

Signal Data	Supported Techniques
Large data set	From File or From Spreadsheet work well for large data sets, because they incrementally load the data.
Data exported by using a To File block	From File.
Data exported by using a To Workspace block	From Workspace.
Excel or CSV spreadsheet	From Spreadsheet or Signal Builder, which can import Microsoft Excel (all platforms) or CSV (Microsoft Windows platform with Microsoft Office only) spreadsheet data directly into Simulink.
Variable-size signals	From Workspace.

### Data Format or Type

Each of the signal loading techniques supports a wide range of data formats for signal data (such as array or **Dataset**). A few signal loading techniques have some limitations for specific formats.

---

**Note:** Some of the Root Inport Mapper tool map modes do not support all the data types that you can use with the tool. For details, see “Choose a Base Workspace and MAT-File Format” on page 59-182.

---

Data Format or Type	Supported Techniques
Array	All.  For array data in a Version 7.0 MAT-file, the From File block loads only double signal values. Use Version 7.3 MAT-files for other types of signal data.
Structure with time	All.
Structure without time	All.
MATLAB timeseries	All.
Simulink.SimulationData.Dataset	All.
Enumeration	All except that Signal Builder can load, but not output enumerations.
Fixed-point	Signal Builder can load, but not output fixed-point data.  From File has a word length limit of less than 33 bits.
Function-call	Root-level input ports (select the <b>Output function call</b> parameter).

### Bus Support

You can use any of the signal loading techniques to load bus data. However, you need to use a specific technique for some kinds of bus data.

For the Signal Builder block,

Type of Bus or Bus Element	Supported Techniques
Virtual and nonvirtual buses	All techniques support both types of buses.  The Root Inport Mapper tool does not support loading bus data in rapid accelerator mode.
Partial bus specification	For the Signal Builder block, the outputs for loaded bus data are either scalar double signals or a flat virtual bus.



Type of Bus or Bus Element	Supported Techniques
	From File uses ground values for unspecified bus elements.
Array of buses signals	Root-level input ports.

### Time Points

The kind of time points in signal data impacts the signal loading technique that you choose.

Time Points for Signal Data	Supported Techniques
Single time point	All.
Continuous	All.
Discrete	All.
Repeated sequence without time	Structure data by using root-level input ports and From Workspace

### Location for Data Storage

Whether you want to store the signal data with the model or separate from the model impacts the signal loading technique that you choose.

Location	Supported Techniques
In a block	Signal Builder block
In the base or model workspace	From Workspace block Root-level input ports or a Trigger, Enable, or Function-Call Subsystem block
In a MAT-file separate from the model file	From File block
In an Excel or CSV spreadsheet	From Spreadsheet block.  <b>Tip:</b> For Excel and CSV spreadsheet requirements, see “Storage Formats” on page 59-154.  Loading CSV data is supported only for Microsoft Windows platforms.

Location	Supported Techniques
	You can use a Signal Builder block to import data from a spreadsheet. However, that block loads all the spreadsheet data into MATLAB memory and stores the data in the model. The From Spreadsheet incrementally loads the data directly from the spreadsheet.

### Signal Data Inspection

The Root Inport Mapper tool, From File block, and Signal Builder block each provide an interface for plotting and inspecting the signal data to load.

### Handling of Loaded Data

How Simulink processes the signal data as it loads it into a model impacts the signal logging technique that you choose.

Data Loading Handling	Supported Techniques
Incremental data loading	From File and From Spreadsheet.
Interpolation	All.
Extrapolation	From File, From Spreadsheet, and From Workspace. For information about From Workspace extrapolation, see “Form output after final data value by”.
Zero-crossing detection	All except root-level input ports.
Fast restart	All techniques.

### Simulation Mode

All signal loading techniques support all simulation modes except for SIL or PIL. Some techniques have limitations for specific simulation modes.

Simulation Modes	Supported Techniques
Normal and accelerator	All.

Simulation Modes	Supported Techniques
Rapid accelerator	All, with these rapid accelerator exceptions:  Root —level input ports support only array and structure data.  From Workspace does not support <code>timeseries</code> format.
ERT/GRT	All.  From Workspace and From File blocks are not tunable.
SIL or PIL	From Workspace block.
External mode	All.  Root-level input ports do not load bus data in external mode.

## Related Examples

- “Load Data to Root-Level Input Ports” on page 59-164
- “Map Data Using Root Inport Mapper Tool” on page 59-132
- “Load Data Using the From File Block” on page 59-239
- “Load Data Using the From Workspace Block” on page 59-242
- “Load Signal Data That Uses Units” on page 59-237

## More About

- “Overview of Signal Loading Techniques” on page 59-116

## Map Data Using Root Inport Mapper Tool

### In this section...

- “The Model” on page 59-132
- “Create Signal Data” on page 59-133
- “Import and Visualize Workspace Signal Data” on page 59-134
- “Map the Data to Inports” on page 59-135
- “Save the Mapping and Data” on page 59-136
- “Simulate the Model” on page 59-136

Use the Root Inport Mapper tool to import, visualize, and map signal and bus data to root-level inports.

Root-level inport mapping imports signal data meets most modeling requirements and maintains model flexibility.

- Test your model with signals from the workspace and use your model as a referenced model in a larger context without any modification. Test signals in your model without disconnecting the inports and connecting sources to them.
- Use the Root Inport Mapper tool to update the **Input** parameter based on the signal data that you import and map to root-level inports.
- Visually inspect signal data without loading all the signal data into MATLAB memory.

To use the Root Inport Mapper tool:

- 1 Create signal data in the MATLAB workspace.
- 2 For a Simulink model, import the data from the workspace. You can visualize the data you import.
- 3 Map the data to root-level inports.
- 4 Simulate the model.
- 5 Save the Root Inport Mapper scenario.

### The Model

This model has three root-level Inport blocks. Two of the Inport blocks output scalar signals and the other Inport block outputs bus data. Open the model.

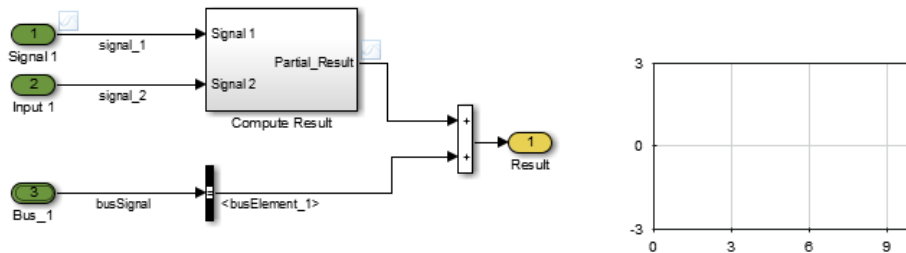

This example shows how you can use the Root Inport Mapper tool to test the model with data. This approach can be useful for performing standalone testing of a model that another model references.

## Create Signal Data

You can define the signal data as MATLAB `timeseries` objects.

- 1 Define the time values for the signal data.

```
sampleTime = 0.01;
endTime = 10;
numberOfSamples = endTime * 1/sampleTime + 1;
timeVector = (0:numberOfSamples) * sampleTime;
```

- 2 Create the data for the two scalar signals. Naming the data variable to match the name of the corresponding signal makes it easier to map data to signals.

```
signal_1 = timeseries(sin(timeVector)*10,timeVector);
signal_2 = timeseries(rand(size(timeVector)),timeVector);
```

- 3 Create the signals for the bus.

```
busSignal.busElement_1 = timeseries(cos(timeVector)*2,timeVector);
busSignal.busElement_2 = timeseries(randn(size(timeVector)),timeVector);
```

- 4 Create the bus object for the output data type of the `Bus_1` Inport block. You can create the bus object from the bus signal that you defined. Use a bus object for bus signals that cross model reference boundaries.

```
busInfo = Simulink.Bus.createObject(busSignal);
```

## Import and Visualize Workspace Signal Data

Import the signal data that you created from the workspace into the Root Inport Mapper tool. Then you can use the tool to visualize the imported data.

- 1 Open the Root Inport Mapper tool. Open the Block Parameters dialog box for one of the Inport blocks in the model and click **Connect Input**.
- 2 In the Root Inport Mapper tool, select the **From Workspace** button.

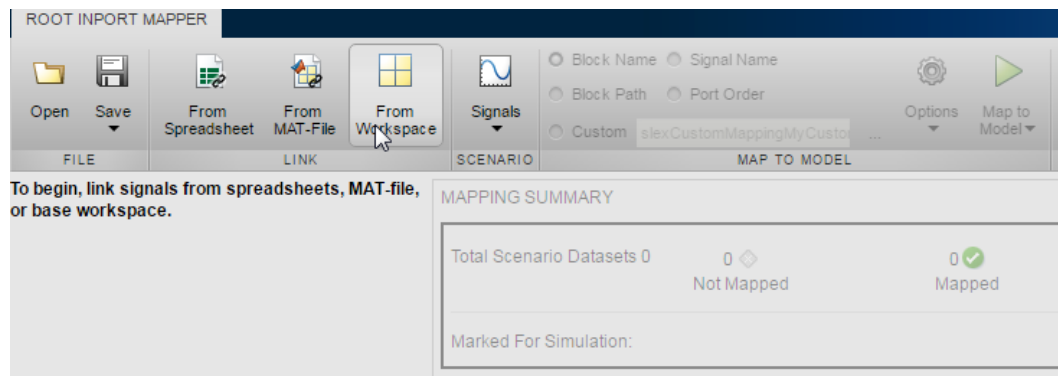

- 3 In the Import dialog box, specify a MAT-file to save signals to. For this example, use the default.
- 4 Click the **Name** check box to clear the data variables. Then click the check boxes for the `busSignal`, `signal_1`, and `signal_2` signals.

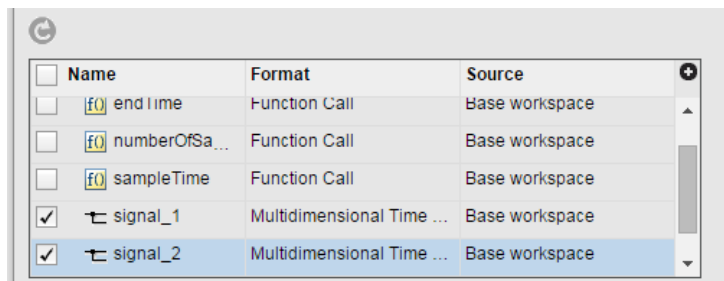

Although in this example you select all the signals, you can select a subset of signals.

- 5 Leave the **Convert signals into a scenario dataset and save to MAT-file** check box enabled and click **OK**.

- 6 You can visualize signals. In the Root Inport Mapper dialog box toolbar, click **Signals > Preview Signals**.

The **Preview** tab appears. You can select signals to plot. For example, to see a plot of `signal_1`, in the Navigation pane, expand the scenario data set (in this example, the top node, `untitled`) and then expand the `signal_1` entry. Select the check box for `signal_1(1,1,:)` to plot the data.

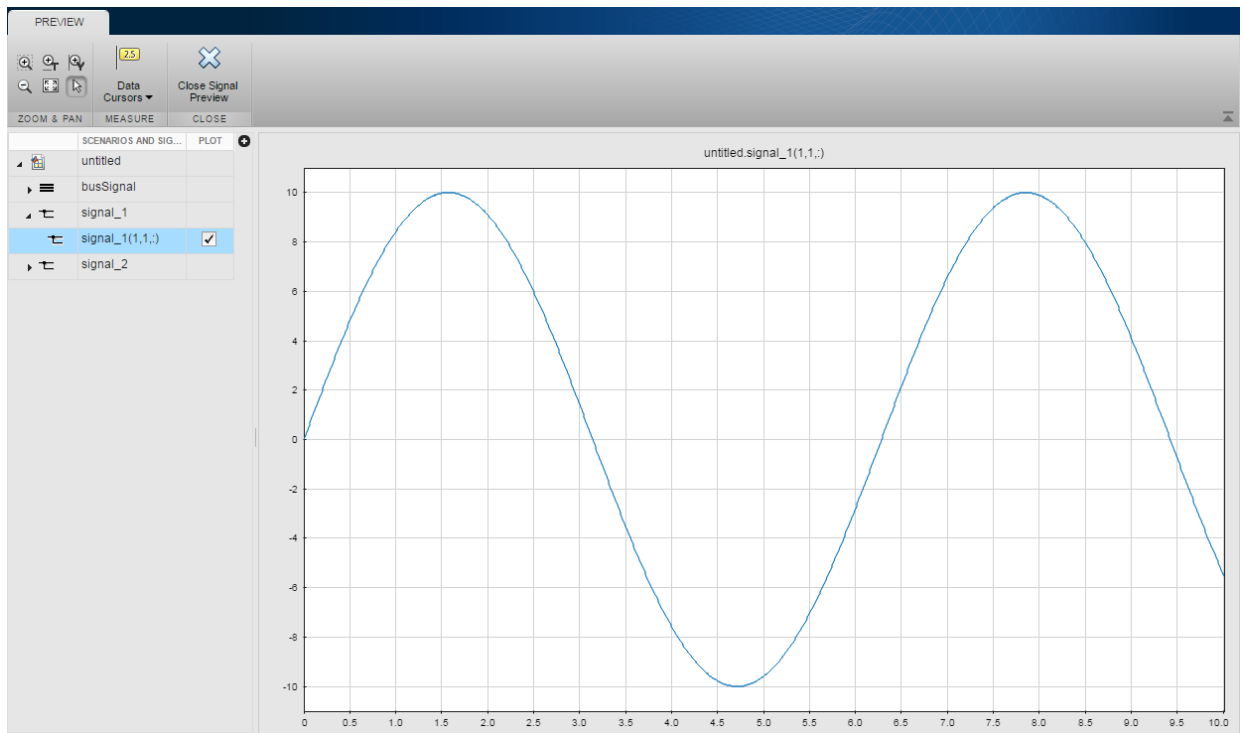

- 7 Close the **Preview** tab by clicking the **Close Signal Preview** button.

## Map the Data to Inports

After you import the data, you map which data to use for specific Inport blocks.

- 1 Select the map mode, which specifies the criteria the mapping uses. In the toolbar, select the **Signal Name** radio button.

The signals in this model have names, so mapping based on signal names makes it very clear which data is going to an Inport block.

- 2 You can specify options for the mapping. In the toolbar, select **Options**. Select **Update Model**, which updates the model after you do the mapping. Compiling the model verifies that signal dimensions and data types match between the data and the Inport blocks.
- 3 Map the data. In the Navigation pane, select the scenario data set. In the toolbar, click **Map to Model**. The dialog box shows the mapped data.

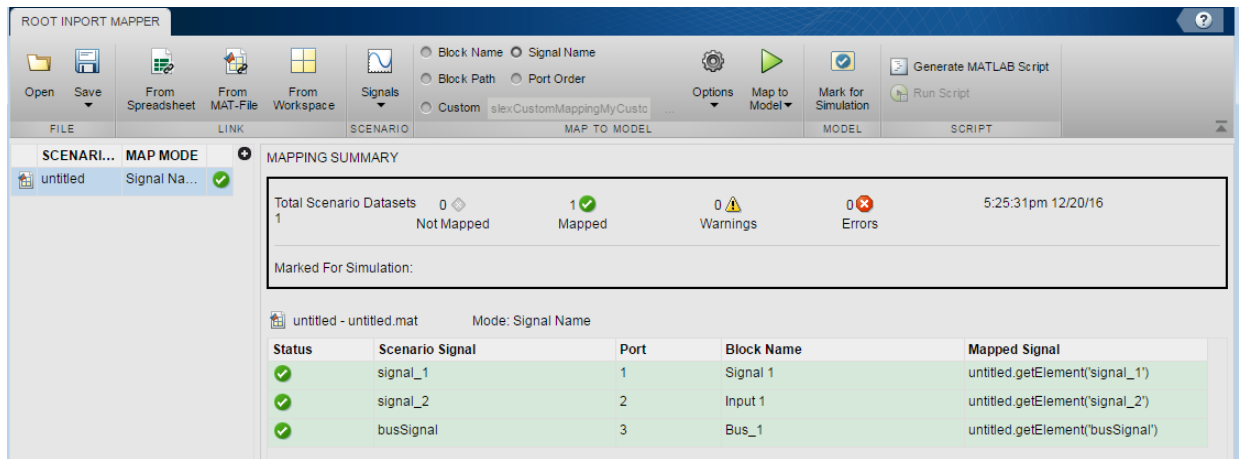

## Save the Mapping and Data

If you want to reuse the mapping and data that you have set up, you can save it as a scenario. In the Root Inport Mapper tool, click **Save > Save As** and save the scenario as an `.mldatx` file.

## Simulate the Model

- 1 In the Navigation pane, select the scenario data set.
- 2 In the toolbar, click **Mark for Simulation**.

The model is now set up to simulate using the workspace signal data that you mapped to root-level Inport blocks.



### 3 Simulate the model.

This model includes a Dashboard block that shows the data used during simulation for `signal_1`. The plot matches the plot you did when you visualized the data as part of the data import process.

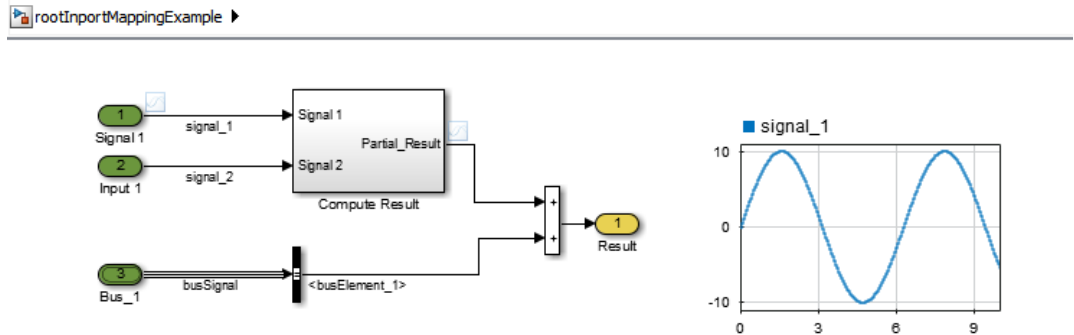

## Related Examples

- “Map Data Using Root Inport Mapper Tool” on page 59-132
- “Create Signal Data for Root Inport Mapping” on page 59-181
- “Import Signal Data for Root Inport Mapping” on page 59-187
- “View and Inspect Signal Data” on page 59-191
- “Map Signal Data to Root Inports” on page 59-210
- “Create and Use Custom Map Modes” on page 59-230
- “Root Inport Mapping Scenarios” on page 59-233

## More About

- “Map Root Inport Signal Data” on page 59-178

## Log Simulation Data for Roundtrip Data Loading

### In this section...

“Use Dataset Format for Consistent Logged Data” on page 59-138

“Limit the Scope of Logged Data” on page 59-139

A common source of signal data to load into a model is data that you log from a simulation. You can use the signal data captured from a simulation as roundtrip input to:

- Simulate the same model again from a known starting point.
- Test simulation results.
- Simulate another model starting with the captured signal values from a model. For example, you can log signal data when you simulate a model. Then load the signal data from that simulation as inputs to a second model that you want to reference from the first model.

You can capture the signal data from a simulation in a workspace or in a file. Use one of these techniques to capture signal data from a simulation:

- Signal logging
- To Workspace block
- To File block
- Scope block
- In the **Configuration Parameters** > **Data Import/Export** pane, the **Output**, **States**, or **Final states** parameters
- Data store
- The `sim` command configured to log simulation data

For an example of using simulation data for roundtrip signal data loading, see “Import Data to Model a Continuous Plant” on page 59-140.

### Use Dataset Format for Consistent Logged Data

Different logging techniques support different data formats. Most logging techniques support the `Dataset` format, which provides a consistent data format for logged signal data. You can use the `Simulink.SimulationData.Dataset` constructor to convert other data formats to `Dataset` format.

## Limit the Scope of Logged Data

To log only the data that you require, use the **Configuration Parameters > Data Import/Export > Logging intervals** parameter to specify start and stop time intervals.

## Related Examples

- “Import Data to Model a Continuous Plant” on page 59-140
- “Save Runtime Data from Simulation”
- “Export Signal Data Using Signal Logging” on page 59-70

## Import Data to Model a Continuous Plant

A continuous plant model uses signal data that is smooth and uninterrupted in time. There is signal data for each time value. A continuous plant model uses a continuous solver (any solver other than an explicit discrete solver). The solver can be fixed-step or variable. The model includes blocks from the Continuous library in Simulink, such as an Integrator block.

To load data to represent a continuous plant, consider using either a root-level input port or a From Workspace block. Using a From Workspace block can be useful when loading data to a port buried deep within a model.

For the signal data:

- Specify a time vector and signal values extracted from a continuous plant. For example, extract from data that you acquire experimentally or from the results of a previous simulation.
- Use any of the data formats listed in “Loading the Data” on page 59-164. Here are recommended formats for the following imported data sources:
  - Another simulation — `Dataset`
  - An equation — MATLAB time expression
  - Experimental data — MATLAB `timeseries`, structure with time, a structure without time, or a data array

For structure data, see “Specify Time Data” on page 59-257.

## Use Simulation Data to Model a Continuous Plant

This example illustrates how to reuse signal logging data from the simulation of one model in the simulation of a second model. For more information, see “Load Signal Logging Data” on page 59-162.

When reusing data from a variable step size simulation for simulation in another model, the second simulation must read the data at the same time steps as the first simulation.

- 1 Open the `ex_data_import_continuous` model.

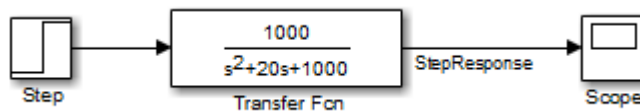

This model uses the `ode15s` solver and produces continuous signals.

- 2 To use the output of this model as input to the simulation of another model, log the signal that you want to reuse. In the Simulink Editor, select that signal, click the



**Simulation Data Inspector** button arrow and click **Log Selected Signals to Workspace**.

---

**Note:** To enable signal logging, select the **Configuration Parameters > Data Import/Export > Signal logging** parameter. This model has **Signal logging** enabled.

---

- 3 Simulate the model.

Simulating the model saves a variable-step signal to the workspace, using the `logout` variable. The signal logging output is a `Simulink.SimulationData.Dataset` object.

Use the `Simulink.SimulationData.Dataset.getElement` method to access the logged data. The logged data for individual signals is stored in `Simulink.SimulationData.Signal` objects. For this model, there is one logged signal: `StepResponse`.

- 4 Open a second model, named `ex_data_import_continuous_second`.

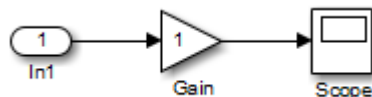

You can configure this second model to simulate using the logged data from the first model. In this example, the second model uses a root-level Inport block to import the logged data. The Inport block has the **Interpolate data** option selected.

- 5 In the second model, select the **Configuration Parameters > Data Import/Export > Input** parameter.

Use the `Simulink.SimulationData.Signal.getElement` method to specify the `StepResponse` signal element:

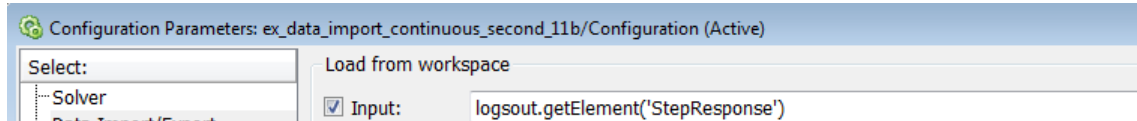

- 6 Specify that for the second model, the Simulink solver runs at the time steps specified in the saved data (u). In the Data Import/Export pane, set the **Output options** parameter to `Produce additional output` and the **Output times** parameter to:

```
logout.getElement('StepResponse').Values.Time
```

- 7 Simulate the second model.

---

**Note:** Simulink does not feed minor time-step data through root input ports. For details about minor time steps, see “Minor Time Steps” on page 3-22.

---

## Related Examples

- “Specify Signal Data” on page 59-256
- “Import Data to Test a Discrete Algorithm” on page 59-143
- “Import Data for an Input Test Case” on page 59-145

## More About

- “Overview of Signal Loading Techniques” on page 59-116

## Import Data to Test a Discrete Algorithm

Discrete signals are signals that you define using evenly-spaced time values. One signal value is read at each time step, using the sample time of the source block.

Use a structure that has an empty time vector, which results in the model using the sample time of the source block. Using this approach avoids possible mismatches between the vector and the Simulink time steps. The double-precision rounding used by computers and the values expected by Simulink can differ.

Suppose you want to import signal data for this very simple model.

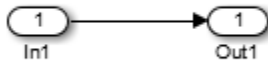

- 1 In the Block Parameters dialog box for the Inport block:
  - Set the sample time.
  - Clear the **Interpolate data** parameter.
- 2 For the data that you want to import, specify a structure variable that does *not* include a time vector. For example, for the variable called `import_var`:

```
import_var.time = [];
import_var.signals.values = [0; 1; 5; 8; 10];
import_var.signals.dimension = 1;
```

The input for the first time step is read from the first element of an input port value array. The value is 0. The value for the second time step is read from the second element of the value array (1), and so on.

For details about how to specify the signal value and dimension data, see “Specify Signal Data” on page 59-256.

- 3 Select the **Configuration Parameters > Data Import/Export > Input** parameter and specify `import_var` for the data to import.

If you are using a From Workspace block to import data, use a similar approach. In addition, set the **Form output after final data value by** parameter to a value other than Extrapolation.

### **Related Examples**

- “Specify Signal Data” on page 59-256
- “Import Data to Model a Continuous Plant” on page 59-140
- “Import Data for an Input Test Case” on page 59-145

### **More About**

- “Overview of Signal Loading Techniques” on page 59-116



## Import Data for an Input Test Case

### In this section...

“Guidelines for Importing a Test Case” on page 59-145

“Example of Test Case Data” on page 59-146

“Use From Workspace Block for Test Case” on page 59-146

“Use Signal Builder Block for Test Case” on page 59-147

For most input test cases, you try to minimize the number of time points. The signal data you load includes samples with ramps and discontinuities.

### Guidelines for Importing a Test Case

Typically when importing a test case data, you want to minimize the number of time points. The test data focuses on discontinuities in the signal data.

- Create a signal that has ramps and steps. In other words, the signal has one or more discontinuities.
- Create the signal using the fewest points possible.
- Have the Simulink solver execute at the specified discontinuities.

To import this signal in Simulink, use a From Workspace, From File, or Signal Builder block, all of which support zero-crossing detection.

You can load data of these types:

- `A Simulink.SimulationData.Dataset`
- Array
- `Simulink.SimulationData.Signal`
- Structure
- A structure array containing data for all input ports.
- Empty matrix — Use an empty matrix for ports for which you want to use ground values, without having to create data values.
- Time expression

Specify a time vector and signal values, but specify only the time steps at points where the shape of the output jumps. For details about specifying a time vector, see “Specify Time Data” on page 59-257.

Use any of the input data formats described in “Loading the Data” on page 59-164, except for MATLAB time expressions.

## Example of Test Case Data

The following is an example of test case data:

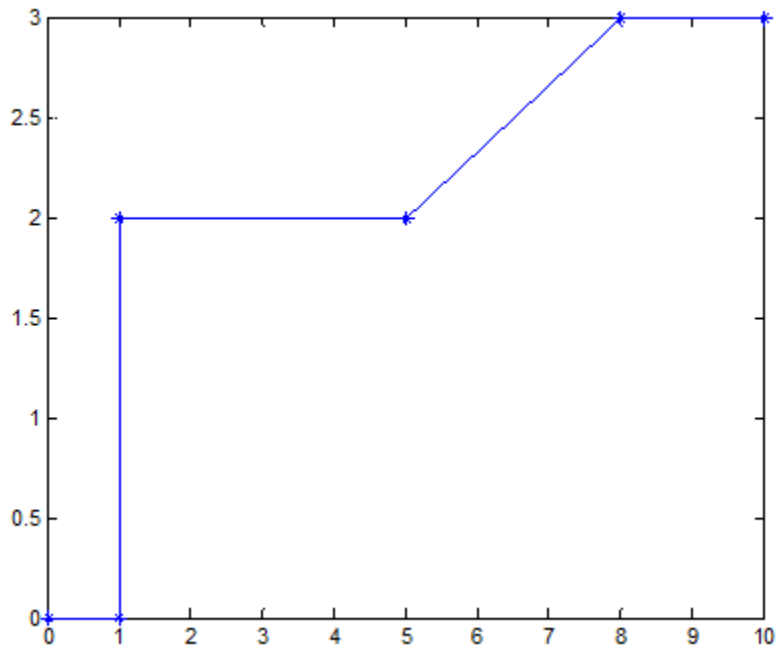

The following two examples use this test case data.

## Use From Workspace Block for Test Case

- 1 Open the model `ex_data_import_test_case_from_workspace`.

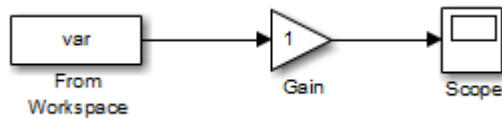

- 2 Enable zero-crossing detection. In the From Workspace block dialog, select **Enable zero-crossing detection**. Zero-crossing detection allows you to capture discontinuities accurately.
- 3 Create a signal structure for the test case. At each discontinuity, enter a duplicate entry in the time vector, which generates a zero crossing and forces the variable-step solver to take a time step at this exact time. For details, see “Load Data Using the From Workspace Block” on page 59-242.

Define the `var` structure representing the test case:

```
var.time = [0 1 1 5 5 8 8 10];
var.signals.values = [0 0 2 2 2 3 3 3]';
var.signals.dimensions = 1;
```

- 4 To import the test case structure, in the From Workspace block dialog box, in the **Data** parameter, specify `var`.
- 5 Simulate the model. The Scope block reflects the test case data.

## Use Signal Builder Block for Test Case

Instead of using a From Workspace block, you can use a Signal Builder block to either:

- Create a signal interactively
  - Import a signal from a MAT-file
- 1 Open the `ex_data_import_signal_builder` model.

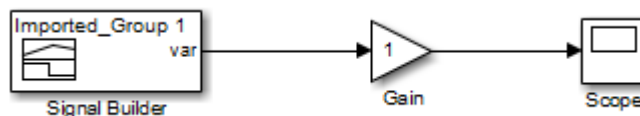

- 2 Create a structure and save it in a MAT-file:

```
var.time = [0 1 1 5 5 8 8 10];
```

```
var.signals.values = [0 0 2 2 2 3 3 3]';  
var.signals.dimensions = 1;  
var.signals.label = 'var';  
save var.mat var
```

- 3** Open the Signal Builder dialog box by double-clicking the Signal Builder block.
- 4** Select **File > Import From File** menu item, and select the `var.mat` file.
- 5** In the **Select** parameter, select **Replace existing dataset**. In the **Data to Import** section, select the **Select All** check box. Confirm the selection and click **OK**.

The Signal Builder block display reflects the test case data.

## Related Examples

- “Specify Signal Data” on page 59-256
- “Import Data to Model a Continuous Plant” on page 59-140
- “Import Data to Test a Discrete Algorithm” on page 59-143

## More About

- “Overview of Signal Loading Techniques” on page 59-116

## Specify Data for Root-Level Input Ports

### In this section...

“Root-Level Input Ports” on page 59-149

“Specify Input Data” on page 59-150

“Forms of Input Data” on page 59-151

“Time Data for the Input Parameter” on page 59-151

### Root-Level Input Ports

Using a root-level input port to load signal data meets many modeling requirements. This technique is useful for importing many signals to many blocks and testing your model as a referenced model in a wider context with signals from the workspace, without modifying your model.

You can import signal data from a workspace and apply it to these blocks:

- Inport block
- Enable block
- Trigger block that has an edge-based (rising, falling, or either) trigger type

These blocks import data from the workspace based on the value of the **Configuration Parameters > Data Import/Export > Input** parameter.

If you use a `Simulink.SimulationData.Dataset` object that includes a `matlab.io.datastore.SimulationDatastore` object as an element, then the data stored in persistent storage is streamed in from a file. For more information, see “Load Big Data for Simulations” on page 59-54.

---

**Tip:** To import many signals to root-level input ports, consider using the Root Inport Mapper tool. If you use that tool, you do not need to enter values in the **Input** parameter. The tool updates the **Input** parameter based on the signal data you import and the mapping you specify. For more information, see “Map Root Inport Signal Data” on page 59-178.

---

You can also import data from a workspace using a From Workspace block. For details, see the From Workspace documentation and “Import Data for an Input Test Case” on page 59-145.

## Specify Input Data

- 1 Select the **Configuration Parameters > Data Import/Export > Input** parameter.
- 2 Enter an external input specification in the adjacent edit box and click **Apply**. For a list of the forms of data you can specify, see “Forms of Input Data” on page 59-151.

In the **Input** box, specify the signal input using one of these approaches:

- Create data at runtime for each simulation time step using the input  $u = UT(t)$  for either a MATLAB function (expressed as a string) or MATLAB expression.
- Specify the data directly, using:
  - A `Simulink.SimulationData.Dataset` object. Specify only one `Dataset` object.
  - A 2D array of input values and time for all input ports, in the form  $UT = [T, U1, \dots, Un]$ , where  $T = [t1, \dots, tm]'$
  - A comma-separated list of variables or MATLAB expressions. Do not include a `Dataset` object in a comma-separated list.

### Comma-Separated List

If you specify `Dataset` data, specify only one `Dataset` object for the **Input** parameter. Do not include it in a comma-separated list.

Each variable or expression corresponds to a specific input port. Each variable or expression in the list must evaluate to the appropriate object that corresponds to one of the root-level input ports of the model. The first item corresponding to the first root-level input port, the second to the second root-level input port, and so on.

For an Enable or Trigger block, the signal driving the enable or trigger port must be the last item in the comma-separated list. If you have both an enable and a trigger port, then specify:

- The enable port as the next-to-last item in the list
- The trigger port as the last item

Use an empty matrix to specify ground values for a port. For example, to load data for input ports `in1` and `in3`, and to use ground values for port `in2`, enter the following in the **Input** parameter:

```
in1, [], in3
```

## Forms of Input Data

The input data can take these forms:

- `Simulink.SimulationData.Dataset` object — Collection of logged data in MATLAB timeseries format. For details, see “Create Dataset Data for Root Inport Ports” on page 59-245.
- MATLAB timeseries — For details, see these sections:
  - “Create MATLAB Timeseries Data for Root Inports” on page 59-248
  - “Import Bus Data to Top-Level Input Ports” on page 59-166
- Array — See “Create Data Arrays for Root-Level Inports” on page 59-250.
- `Simulink.SimulationData.Signal` — For details, see “Log Simulation Data for Roundtrip Data Loading” on page 59-138.
- Structure — To simplify the specification of external data to input, you can load data for a subset of root-level input port blocks. This avoids having to create data structures for the ports for which you want to use ground values. For information about ground values, see “Initialize Signals and Discrete States” on page 62-48. See “Create Data Structures for Root Inports” on page 59-255.
- Structure array containing data for all input ports.
- Empty matrix — Use an empty matrix for ports for which you want to use ground values, without having to create data values.
- Time expression — See “Create MATLAB Time Expressions for Root Inports” on page 59-254.

## Time Data for the Input Parameter

Time values that you specify in the **Input** parameter have no impact on the times the solver uses. The **Interpolate** parameter setting for the root-level input block (for example, the root-level Inport block) specifies how to handle output at time steps for which no corresponding workspace data exists.

## **See Also**

### **Blocks**

Enable | Inport | Trigger

## **Related Examples**

- “Load Data to Root-Level Input Ports” on page 59-164
- “Map Root Inport Signal Data” on page 59-178



## Create Data for a From File Block

### In this section...

“Data Saved by a To File Block” on page 59-153

“Supported MAT-File Versions” on page 59-153

“Storage Formats” on page 59-154

“Timestamps” on page 59-155

“Bus Data” on page 59-155

“MAT-File Variable” on page 59-155

### Data Saved by a To File Block

The From File block loads data that was written by a To File block without any modifications to the data or any other special provisions.

### Supported MAT-File Versions

The supported MAT-file versions are:

- Version 7.0 or earlier
- Version 7.3

For a Version 7.0 and earlier MAT-file, the From File block loads the complete, uncompressed data from the file into memory when the simulation begins. For a Version 7.3 MAT-file, the From File block incrementally loads data from the file during simulation.

For more information about MAT-files, see “MAT-File Versions” (MATLAB).

### Convert Version 7.0 and Earlier Version MAT-Files

If you have a Version 7.0 or earlier version MAT-file that you want to use with the From File block, consider converting the file to Version 7.3. Use a Version 7.3 MAT-file if you want the From File block to load data incrementally during simulation or you want to use MATLAB `timeseries` data. For example, to convert a Version 7.0 file named `my_data_file.mat` that contains the variable `var`, at the MATLAB command prompt, enter:

```
load('my_data_file.mat')  
save('my_data_file.mat', 'var', '-v7.3')
```

## Storage Formats

When the From File block loads data from a MAT-file, that data must be stored in array format or as a MATLAB `timeseries` object.

### Array Data

You can use the array format for only vector, double, noncomplex signal data.

For a Version 7.0 MAT-file, the From File block loads array data, but not MATLAB `timeseries` data.

The array format for stored data is a matrix containing two or more rows. The matrix in the MAT-file must have the following form:

$$\begin{bmatrix} t_1 & t_2 & \dots & t_{final} \\ u1_1 & u1_2 & \dots & u1_{final} \\ \dots & & & \\ un_1 & un_2 & \dots & un_{final} \end{bmatrix}$$

The first element of each column contains a timestamp. The remainder of each column contains data for the corresponding output values. Each element must be a double. Elements cannot include a NaN, Inf, or -Inf.

### MATLAB Timeseries Data

To use bus data with a From File block, use the MATLAB `timeseries` format.

MATLAB `timeseries` format data can have:

- Any dimensionality and complexity
- Any built-in data type, including **Boolean**
- A fixed-point data type with a word length of up to 32 bits
- An enumerated data type

For data stored using the array format, the width of the From File output depends on the number of rows in the matrix. For a matrix containing  $m$  rows, the block outputs a vector of length  $m-1$ .

The MATLAB `timeseries` format supports the following simulation and code generation modes:

- Normal
- Accelerator
- Rapid accelerator
- Model reference accelerator

See the From File block documentation for an example of creating a MAT-file with MATLAB `timeseries` data load with a From Workspace block.

## Timestamps

The timestamps in the file must be monotonically nondecreasing.

## Bus Data

The From File block supports loading nonvirtual bus signals.

The data must be in a MATLAB structure that matches the bus hierarchy. Each leaf of the structure must be a MATLAB `timeseries` object.

The structure can underspecify the bus signal, but must not overspecify the bus signal. The structure cannot have any elements that do not have corresponding signals in the bus.

The structure does not require a `timeseries` object for every element in the bus hierarchy. However, the structure must have a `timeseries` object for at least one of the signals in the bus. For signals that do not specify data, the From File block outputs the ground values.

## MAT-File Variable

If a MAT-file contains only one variable, then the From File block uses that variable. If the MAT-file contains more than one variable:

- For Version 7.3 MAT-files, the From File block uses the variable that is first alphabetically.
- For Version 7.0 or earlier MAT-files, the From File block uses the first variable. However, for these versions, the ordering algorithm for variables is complicated. Use a MAT-file that contains just the variable with the data that you want the From File block to load.

## See Also

### Blocks

From File | To File

### Related Examples

- “Load Data Using the From File Block” on page 59-239
- “Comparison of Signal Loading Techniques” on page 59-124

## Create Data for a From Workspace Block

### In this section...

“Use Data from a To Workspace Block” on page 59-157

“Specify Variable-Size Signals” on page 59-157

“Data for the From Workspace Block” on page 59-157

“Bus Data” on page 59-161

“Use Data from a To File Block” on page 59-161

“Store Data for Model Linked to Data Dictionary” on page 59-161

### Use Data from a To Workspace Block

You can use the From Workspace block to load data exported by a To Workspace block in a previous simulation for use in a later simulation. Save the To Workspace block data in either `Timeseries` or `Structure with Time` format.

### Specify Variable-Size Signals

You can use a To Workspace block (with `Structure` or `Structure With Time` format) or a root Output block to log variable-size signals. Then use the To Workspace variable with the From Workspace block.

Alternatively, create a MATLAB structure that contains variable-size signal data. For each `values` field in the structure, include a `valueDimensions` field that specifies the run-time dimensions for the signal. For details, see [Simulink Models Using Variable-Size Signals](#) on page 64-7.

### Data for the From Workspace Block

You can load these kinds of data using a From Workspace block:

- A MATLAB timeseries object
- A structure of MATLAB `timeseries` objects
- A structure, with or without time
- A two-dimensional matrix

To use workspace data that is in `Simulink.SimulationData.Dataset` format, extract a MATLAB `timeseries` object from the data set. For example, if you use signal logging with `Dataset` format and use the default output variable `logsout`, for a single logged signal enter:

```
logsout.get(1).values
```

### **MATLAB Timeseries Data**

You can use a MATLAB `timeseries` object for any data type, complexity, or fixed dimensions.

Real signals of type `double` can be in any format that the From Workspace block supports. For complex signals and real signals of a data type other than `double`, use any format except `Array`.

### **Structure of MATLAB timeseries Data**

Use a structure of MATLAB `timeseries` objects for bus data. Match the bus hierarchy and specify a `timeseries` object for each leaf signal in the bus.

### **Structures**

You can use a structure for one-dimensional or multidimensional signals, with or without time values. For the structure, use this format:

- A `signals.values` field, which contains a column vector of signal values.
- An optional `signals.dimensions` array, which contains the dimensions of the signal.
- An optional `time` vector of doubles, which is a column vector of timestamps.

The `n`th `time` element is the timestamp of the `n`th `signals.values` element.

The form of a structure that you use depends on whether you are importing data for:

- Discrete signals (the signal is defined at evenly spaced values of time) — Use a structure that has an empty time vector.
- Continuous signals (the signal is defined for all values of time) — The approach that you use depends on whether the data represents a smooth curve or a curve that has discontinuities (jumps) over its range.

For examples, see:

- “Import Data to Test a Discrete Algorithm” on page 59-143
- “Use From Workspace Block for Test Case” on page 59-146

For both discrete and continuous signals, specify a **signals** field, which contains an array of substructures, each of which corresponds to a model input port. For details, see “Specify Signal Data” on page 59-256.

Each **signals** substructure must contain two fields: **values** and **dimensions**.

- The **values** field must contain an array of inputs for the corresponding input port. If you specify a time vector, each input must correspond to a time value specified in the **time** field.

If the inputs for a port are scalar or vector values, the **values** field must be an M-by-N array. If you specify a time vector, M must be the number of time points specified by the **time** field and N is the length of each vector value.

If the inputs for a port are matrices (2-D arrays), the **values** field must be an M-by-N-by-T array. M and N are the dimensions of each matrix input and T is the number of time points. For example, suppose that you want to input 51 time samples of a 4-by-5 matrix signal into one of your model input ports. Then, the corresponding **dimensions** field of the workspace structure must equal [4 5] and the **values** array must have the dimensions 4-by-5-by-51.

- The **dimensions** field specifies the dimensions of the input. If each input is a scalar or vector (1-D array) value, the **dimensions** field must be a scalar value that specifies the length of the vector (1 for a scalar). If each input is a matrix (2-D array), the **dimensions** field must be a two-element vector whose first element specifies the number of rows in the matrix and whose second element specifies the number of columns.

For continuous signals, you can specify a **time** field, which contains a time vector. How you specify the time values depends on the kind of signal data that you want.

For information about defining MATLAB structures, see “Create Structure Array” (MATLAB).

Signal Data	Time Data Recommendation
Evenly spaced discrete signals	Use an expression in this form: <code>timeVector = timeStep * [startTime:numSteps-1]'</code>

Signal Data	Time Data Recommendation
	<p>The vector is transposed. Also, because the start time is a time step, you need specify the number of steps you want minus 1. For example, to specify 50 time values at 0.2 time steps:</p> <pre>T1 = 0.2 * [0:49]'</pre> <hr/> <p><b>Note:</b> Do <i>not</i> use an expression in this form:</p> <pre>timeVector = [startTime:timeStep:endTime]'</pre> <p>For example, do not use:</p> <pre>T2 = [0:0.2:10]'</pre> <p>This time vector form is not equivalent to the form that multiplies by time steps (T1), because of double-precision rounding used by computers. Simulink expects exact values, with no double-precision rounding. Using the T2 form can lead to unexpected simulation results.</p>
Unevenly spaced values	<p>Use any valid MATLAB array expression; for example, [1:5 5:10] or (1 6 10 15).</p> <p>The From Workspace, From File, and Signal Builder blocks support zero-crossing detection. If the root-level input port is connected to one of those blocks, you can specify a zero-crossing time by using a duplicate time entry.</p>

### Matrix

You can use a matrix to specify only one-dimensional signals.

The first element of each matrix row is a timestamp. The rest of each row is a scalar or vector of signal values.



## Bus Data

To create bus data to load with a From Workspace block, use a structure of MATLAB `timeseries` objects. Match the bus hierarchy and specify a `timeseries` object for each leaf signal in the bus. Set up the data the same way as you do for loading bus signals to a root-level input port. For details, see “Import Bus Data to Top-Level Input Ports” on page 59-166.

## Use Data from a To File Block

Loading data that was exported to a file by a To File block using MATLAB `timeseries` does not require that you change the data.

If you set the To File block **Save format** parameter to `Array`, transpose the exported array data. The data saved by the To File block contains columns with consecutive timestamps, followed by the corresponding data. The transposed data contains rows with consecutive timestamps, followed by the corresponding data. To provide the required format, use MATLAB `load` and `transpose` commands with the MAT-file (see “Reshaping a Matrix” (MATLAB)). To avoid transposing the data again later, resave the transposed data.

## Store Data for Model Linked to Data Dictionary

When you use a From Workspace block in a model that is linked to a data dictionary, you must choose the location to store the data that the block refers to. See “Use With Data Dictionary”.

## See Also

### Blocks

From Workspace | To Workspace

## Related Examples

- “Load Data Using the From Workspace Block” on page 59-242
- “Comparison of Signal Loading Techniques” on page 59-124

## Load Signal Logging Data

You can use signal logging to log data for specified signals during simulation. Then you can load that saved simulation data as input for another simulation of that model (or the simulation of a different model). For example, using this approach is useful to perform standalone simulation of a referenced model.

- 1 Use the default signal logging output variable, `logout`, or specify a variable using the **Configuration Parameters > Data Import/Export > Signal logging** edit box.
- 2 Simulate the parent model.

The signal logging output is a `Simulink.SimulationData.Dataset` object.

- 3 Use the `Simulink.SimulationData.Dataset.getElement` method to access the logged data. The logging data for individual signals is stored in `Simulink.SimulationData.Signal` objects.
- 4 For the referenced model that you want to simulate standalone, use the `Simulink.SimulationData.Signal.getElement` method to specify signal elements for the **Configuration Parameters > Data Import/Export > Input** parameter.

For example:

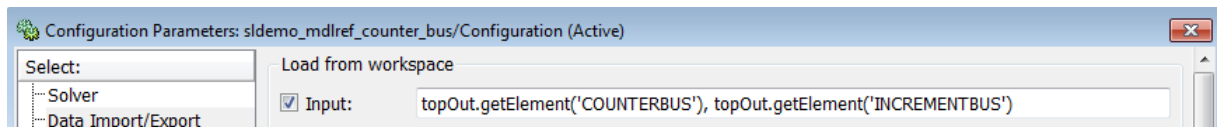

- 5 Simulate the referenced model.

For an example of loading signal logging data for a model that uses model referencing, see the `sldemo_mdref_bus` example. After you open the model, double-click the blue block labeled **Interface Specification** and see the sections called:

- Logging Model Reference Signals
- Loading Data

Open the `sldemo_mdref_bus` model.

Also, the “Import Data to Model a Continuous Plant” on page 59-140 example illustrates loading signal logging data.

To import signal logging data for array of buses signals, see “Import Array of Buses Data” on page 59-171.

## See Also

### Classes

`Simulink.SimulationData.Dataset` | `Simulink.SimulationData.Signal`

## Related Examples

- “Export Signal Data Using Signal Logging” on page 59-70
- “Import Data to Model a Continuous Plant” on page 59-140
- “Import Array of Buses Data” on page 59-171

## Load Data to Root-Level Input Ports

You can load data from a workspace to a root-level inport modeled using one of these blocks.

- Inport block
- Enable block
- Trigger block that has an edge-based (rising, falling, or either) trigger type

These blocks import data from the workspace based on the value of the **Configuration Parameters > Data Import/Export > Input** parameter.

If you use a `Simulink.SimulationData.Dataset` object that includes a `matlab.io.datastore.SimulationDatastore` object as an element, then the data stored in persistent storage is streamed in from a file. For more information, see “Load Big Data for Simulations” on page 59-54.

---

**Tip:** To import many signals to root-level input ports, consider using the Root Inport Mapper tool. For more information, see “Map Root Inport Signal Data” on page 59-178.

---

You can also import data from a workspace using a From Workspace block. For details, see the From Workspace documentation and “Import Data for an Input Test Case” on page 59-145.

### Loading the Data

Use the **Configuration Parameters > Data Import/Export > Input** parameter to load data from a workspace and apply it to the root-level input ports of a model during a simulation run.

---

**Note:** The use of the **Input** box is independent of the setting of the **Format** list on the **Data Import/Export** pane.

---

Simulink linearly interpolates or extrapolates input values as necessary if you select the **Interpolate data** option for the corresponding Inport, Enable, or Trigger block.

Simulink resolves symbols used in the external input specification as described in “Symbol Resolution” on page 57-118. See the documentation of the `sim` command for some data import capabilities that are available only for programmatic simulation.

## See Also

### Blocks

Enable | Inport | Trigger

### Classes

Simulink.SimulationData.Dataset

## Related Examples

- “Specify Data for Root-Level Input Ports” on page 59-149

## More About

- “Map Root Inport Signal Data” on page 59-178

## Import Bus Data to Top-Level Input Ports

### In this section...

“Imported Bus Data Requirements” on page 59-166

“Import Bus Data to a Top-Level Inport” on page 59-167

“Get Information about Bus Objects” on page 59-170

“Create Structures of Timeseries Objects from Buses” on page 59-170

“Import Array of Buses Data” on page 59-171

You can import bus data to top-level input ports by manually specifying the data in the **Inport** configuration parameter or by using the Root Inport Mapper tool. For information about importing bus data using the Root Inport Mapper tool, see “Import Bus Data” on page 59-189.

### Imported Bus Data Requirements

To import bus data to a top-level input port, use a structure of MATLAB `timeseries` objects. The `timeseries` objects represent the bus elements that you want to specify values for. Any bus elements for which you do not include a field in the structure use ground values. You can include a structure of `timeseries` objects as a `Dataset` object element.

In the top-level Inport block, set **Data type** to **BUS** and specify the name of a bus object.

A top-level input port defined by a bus object (see `Simulink.Bus`) can import data from a `Simulink.SimulationData.Dataset` object or from a structure of MATLAB `timeseries` objects. The `Dataset` object or structure represents the bus elements for which you want to specify values. Any bus elements for which you do not include a field in the structure use ground values.

The structure of MATLAB `timeseries` objects must match the bus elements in terms of:

- Hierarchy
- Name of the structure field, which must match the bus element name. (The `name` property of the `timeseries` object does not need to match the bus element name.)
- Data type (for tunable parameters)

- Dimensions
- Complexity

The order of the structure fields does not have to match the order of the bus elements.

You can specify an empty matrix in a comma-separated list. The empty matrix uses the ground values for the bus signal.

For example, to load data for input ports `in1` and `in3`, and to use ground values for port `in2`, enter the following in the **Input** parameter:

```
in1, [], in3
```

---

**Note:** If you use a structure of MATLAB `timeseries` objects for a root Inport block in a model with multiple root Inport blocks, all root Inport blocks must use MATLAB `timeseries` objects. Convert any root Inport block data that uses `Simulink.TsArray` or `Simulink.Timeseries` objects to MATLAB `timeseries` objects.

---

### Initialize Bus Signals

You can initialize bus signals, including using partial specification of initialization data. For details, see “Specify Initial Conditions for Bus Signals” on page 63-99.

For details about importing array of bus data to a root Inport block, see “Import Array of Buses Data” on page 59-171.

### Limitations for Importing Bus Data to Top-Level Inputs

The signal data that you can use the Root Inport Mapper tool to import and map to a top-level Inport block can include bus data. You cannot use that tool to map bus signals to a top-level Enable or Trigger block.

You cannot use input ports to import buses in external modes. To import bus data in rapid accelerator mode, use `Dataset` format.

### Import Bus Data to a Top-Level Inport

This model has two Inport blocks connected to Scope blocks. The data type of the `In1` block is inherited (nonbus data) and the data type of the `In2` block is defined by the

bus object `BusObject`. The model has a callback that loads `BusObject` and its sub-bus `BusObject1`.



The `BusObject` bus object has two elements:

- `c`
- `s1`, which is a subbus that has two elements:
  - `a`
  - `b`

- 1 Open the .
- 2 Create a MATLAB `timeseries` object for `In1`, for which you want to import nonbus data.

For example:

```
t1 = (1:10)';
d1 = sin(t1);
in1 = timeseries(d1,t1);
```

- 3 Create a structure of MATLAB `timeseries` objects, with one `timeseries` object for each leaf bus element for which you do not want to use ground values. This example uses ground values for the `b` bus element, so it does not need a `timeseries` object for that element.

```
t2 = (1:5)';
d2 = cos(t2);
in2.c = timeseries(d1,t1);
```



```
in2.s1.a = timeseries(d2,t2);
```

The MATLAB `timeseries` objects that you create must match the corresponding bus elements, as described in “Imported Bus Data Requirements” on page 59-166.

- 4 Create a `Dataset` object and add `in1` and `in2` to the data set.

```
ds = Simulink.SimulationData.Dataset;
ds = ds.addElement(in1,'in1_signal');
ds = ds.addElement(in2,'in2_signal');
```

- 5 In the **Configuration Parameters** > **Import/Export** > **Input** parameter edit box, enter the `Dataset` object `ds`.

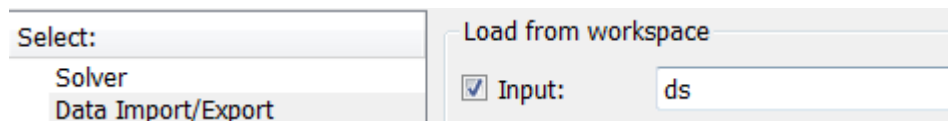

- 6 Simulate the model. The Scope block connected to `In2` shows the imported bus data.

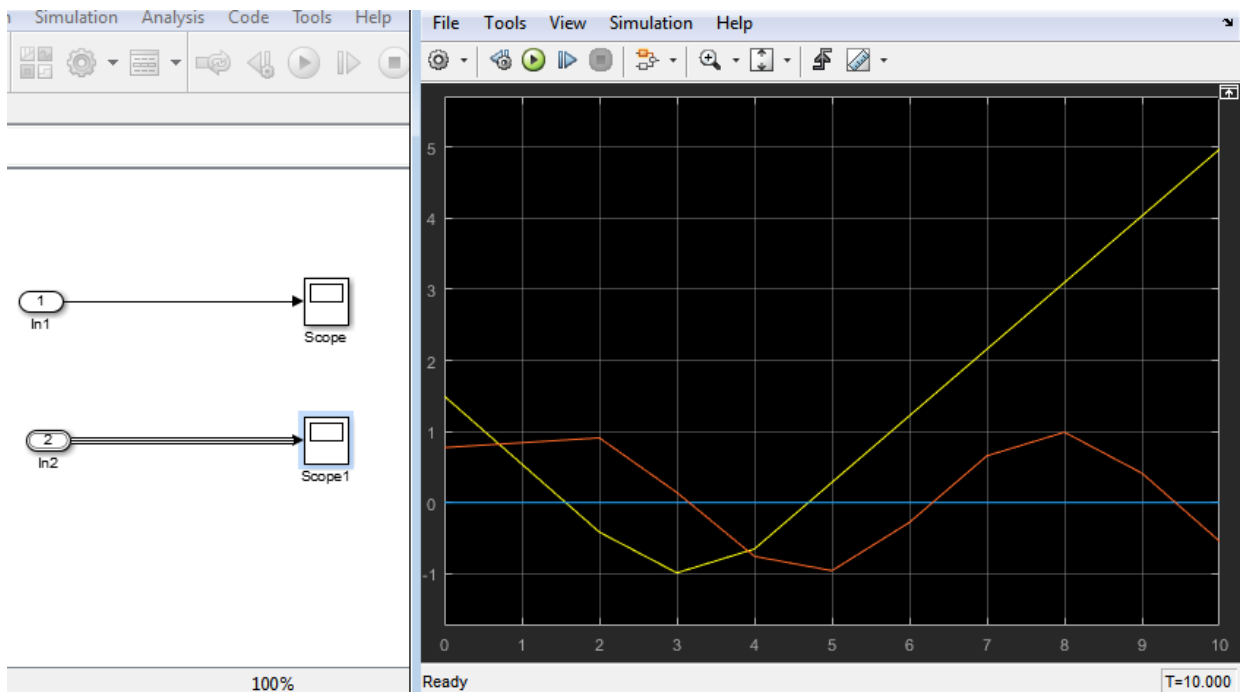

## Get Information about Bus Objects

To determine the number of MATLAB `timeseries` objects and data type, complexity, and dimensions needed for creating a structure of `timeseries` objects from a bus, use these methods:

- `Simulink.Bus.getNumLeafBusElements`
- `Simulink.Bus.getLeafBusElements`

For example, for the bus object `BusObject`:

```
num_el = BusObject.getNumLeafBusElements
```

```
num_el =
```

```
    3
```

```
el_list = BusObject.getLeafBusElements
```

```
el_list =
```

```
    3x1 BusElement array with properties:
```

```
    Min  
    Max  
    DimensionsMode  
    SampleTime  
    Description  
    Units  
    Name  
    DataType  
    Complexity  
    Dimensions
```

```
el_list(1).Dimensions
```

```
ans =
```

```
    1
```

## Create Structures of Timeseries Objects from Buses

If you have `timeseries` objects defined, you can use them to create a structure of `timeseries` objects based on a bus object. Use the

`Simulink.SimulationData.createStructOfTimeseries` function. For example, if you have defined `timeseries` objects `ts1`, `ts2`, and `ts3`, and you have a bus object `MyBusObject`, you can use this command to create a structure of `timeseries` objects:

```
input = Simulink.SimulationData.createStructOfTimeseries('MyBusObject', ...  
{ts1,ts2,ts3});
```

The number of `timeseries` objects in the cell array must match the number of leaf elements in the bus object. The data type, dimensions, and complexity of each `timeseries` object must match those attributes of the corresponding bus object leaf node.

## Import Array of Buses Data

To import (load) array of buses data using a root Inport block, use an array of structures of MATLAB `timeseries` objects.

---

**Note:** You cannot use an Enable, Trigger, From Workspace, or From File block to import data for an array of buses.

---

### Full Specification of Data

You can use logged data for an array of buses signal from a previous simulation as roundtrip input to a root-level Inport in a subsequent simulation run. The logged data is a full specification of data for the Inport block.

If you construct an array of structures of MATLAB `timeseries` objects to specify fully the data to import:

- Specify the structure fields in the same order as the signals in the bus signals.
- Do not include more fields in the structure than there are signals in the bus.

For leaf fields, match exactly the data type, dimensions, and complexity of the corresponding signal in the bus.

### Partial Specification of Data

To specify partial data for array of buses, create a MATLAB array of structures with MATLAB `timeseries` objects at the leaf nodes.

The structure that you create to specify partial data must be consistent with these rules:

- You can omit fields, including leaf nodes and subbranches. You can also omit dimensions. If you do not specify a field, Simulink uses the ground value for that field.
- For subbus nodes, make the dimension of each field equal to, or smaller than, the dimension for the corresponding node of the array of buses.

This example shows how you can specify partial data to be imported using a root Inport block whose data type is defined as bus object MyBus. You can open the model (`ex_partial_loading_aob_model`) and the MATLAB code that defines the data to import (`ex_partial_loading_aob_data.m`).

When you simulate `ex_partial_loading_aob_model`, you see:

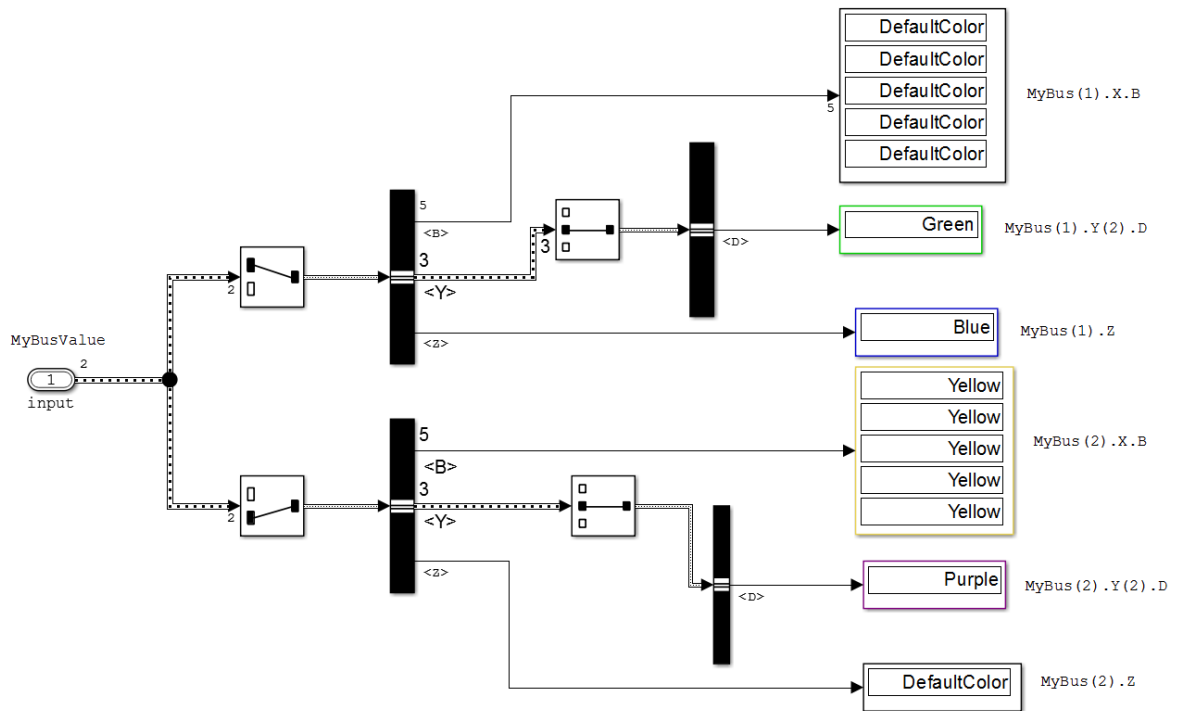

The input Inport block uses the MyBus bus object as its data type.

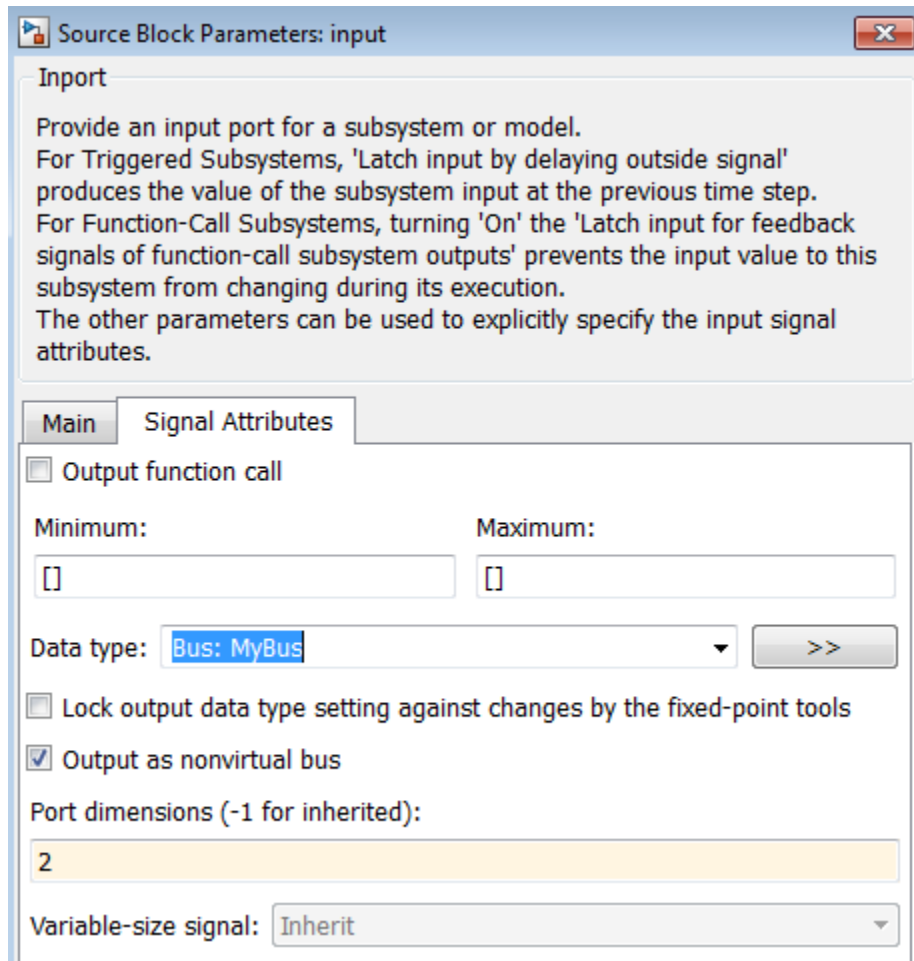

The MyBus array of buses includes MyBus (1) and MyBus (2). The port dimension is set to 2 to reflect the two buses in the array of buses, and **Output as nonvirtual bus** is enabled.

Here are the elements of the array of buses, which includes MyBus (1) and MyBus (2). The color highlighting shows the nodes of the array of buses for which data is being imported.

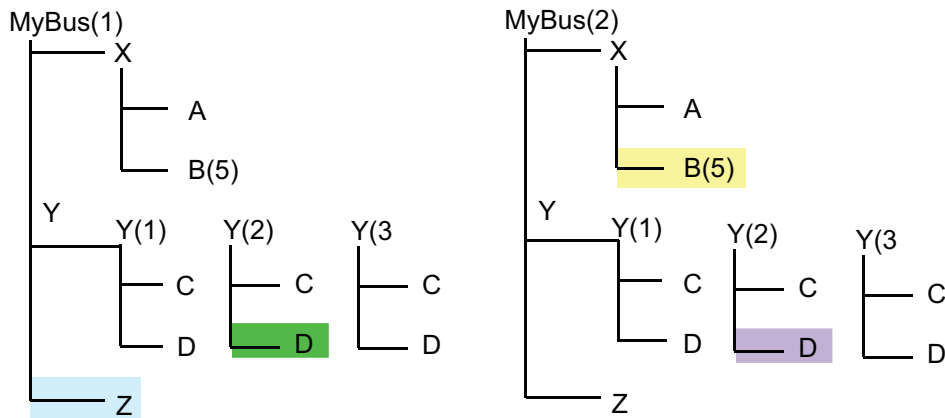

Here is MATLAB code that defines the data to import. The color that highlights the code matches the color of the corresponding node in the array of buses. To view the code used in this model, open the MATLAB code file `ex_partial_loading_aob_data.m`.

```

7      %% Create timeseries data for leaf signals
8 -   N = 10; Ts = 1;
9 -   Time = ((0:N)*Ts)';
10 -  [m, n] = size(Time);
11
12 -  ZData = repmat(ex_partial_loading_aob_basicColors.Blue,m,n);
13 -  BData = repmat(ex_partial_loading_aob_basicColors.Yellow,m,5);
14 -  D1Data = repmat(ex_partial_loading_aob_basicColors.Green,m,n);
15 -  D2Data = repmat(ex_partial_loading_aob_basicColors.Purple,m,n);
16
17      %% Create individual timeseries objects to represent Z, B, D1 and D2
18 -  ZT = timeseries(ZData, Time, 'Name', 'Z');
19 -  BT = timeseries(BData, Time, 'Name', 'B');
20 -  D1T = timeseries(D1Data, Time, 'Name', 'D1');
21 -  D2T = timeseries(D2Data, Time, 'Name', 'D2');
22
23      %% Construct MyBusValue(1)
24
25      % Y(2).D
26 -  Y(2) = struct('D',D1T);
27
28      % Set X.B to empty to allow the second element to support specification for
29      % this field
30 -  X = struct('B',[]);
31
32      % MyBusValue(1)
33 -  MyBusValue(1) = struct('Z',ZT,'Y',Y,'X',X);
34 -  clear X Y;
35
36      %% Construct MyBusValue(2)
37
38      % Specify timeseries for MyBusValue(2).X.B
39 -  MyBusValue(2).X.B = BT;
40
41      % Specify timeseries for MyBusValue(2).Y(2).D
42 -  MyBusValue(2).Y(2).D = D2T;
43

```

In the code that defines the import data:

- The `timeseries` object `MyBusValue` specifies the data for the highlighted nodes.
- The `timeseries` object `BT` for `MyBus(2)`, because `BT` is a leaf node, it must match exactly the dimensions, data type, and complexity of the corresponding bus element.
- The structure specifies data for `Y(2)`. You can skip the first and last subbuses of `Y` (that is, `Y(1)` and `Y(3)`).

This example specifies data for `Y(2)`; you can skip the first and last subbuses of `Y` (that is, `Y(1)` and `Y(3)`).

After you define the `MyBusValue` variable for the import data, set the **Configuration Parameters** > **Data Import/Export** > **Input** parameter to `MyBusValue`.

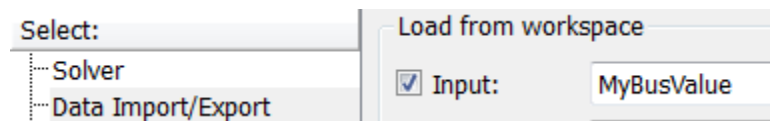

## See Also

Simulink.Bus

## Related Examples

- “Load Data to Root-Level Input Ports” on page 59-164
- “Import Bus Data” on page 59-189
- “Use Buses for Inports and Outports” on page 63-95
- “Specify Initial Conditions for Bus Signals” on page 63-99
- “Import Array of Buses Data” on page 59-171
- “Bus Data Crossing Model Reference Boundaries” on page 63-142

## More About

- “Imported Bus Data Requirements” on page 59-166
- “Load Data to Root-Level Input Ports” on page 59-164
- “Map Root Inport Signal Data” on page 59-178



- “Buses” on page 63-3
- “When to Use Bus Objects” on page 63-59

## Map Root Inport Signal Data

### In this section...

“Open the Root Inport Mapper Tool” on page 59-178

“Command-Line Interface” on page 59-179

“Import and Mapping Workflow” on page 59-179

“Choose a Map Mode” on page 59-179

To import, visualize, and map signal and bus data to root-level inports, use the Root Inport Mapper tool or the `getRootInportMap` function. At the top level of a model or referenced model, root-level inports are ports of one of these blocks:

- Inport block
- Enable block
- Trigger block

Root-level inport blocks import data from the MATLAB workspace based on the value of the **Configuration Parameters > Data Import/Export > Input** parameter.

Root-level inport mapping imports signal data in a way that meets most modeling requirements and maintains model flexibility. You can:

- Test your model with signals from the workspace and use your model as a referenced model in a larger context without any modification.
- Update the **Input** parameter based on the signal data that you import and map to root-level inports.
- Visually inspect signal data without loading all the signal data into MATLAB memory.

---

**Tip:** To determine whether another data import technique meets your specific modeling requirements (such as the amount of data or the storage location) better, see “Comparison of Signal Loading Techniques” on page 59-124.

---

### Open the Root Inport Mapper Tool

Use either of these approaches to open the Root Inport Mapper tool:

- In the **Configuration Parameters > Data Import/Export** pane, click **Connect Input**.
- In the block parameters dialog box for the Inport block, select **Connect Input**.

## Command-Line Interface

You can use the `getRootInportMap` to create a custom object to map signals to root-level inports and `getS1RootInportMap` to create a custom mapping mode. For more information, see “Create and Use Custom Map Modes” on page 59-230.

## Import and Mapping Workflow

- 1 Identify and possibly create signal data to import and map on page 59-181.
- 2 Import on page 59-187 and inspect signal data on page 59-191.
- 3 Map the imported signal data on page 59-178. For example, you can map the signal data by block path or signal name.
- 4 Simulate the model using the mapped data. After associating a scenario with the model, you can generate scripts for simulation with scenarios on page 59-229 to perform batch simulations.
- 5 Optionally, save the current Root Inport Mapper scenario on page 59-233 for future reference or to share with other people

---

**Tip:** To extend the Root Inport Mapper tool map modes, you can create a custom mapping file function to map data to root-level inports.

---

## Choose a Map Mode

To specify how you want the Root Inport Mapper tool to map the signal data to a model, select from these map modes in the **MAP TO MODEL** section of the toolbar:

- Block name — Connect signal data to ports based the name of a root-inport block.
- Block path — Connect signal data to ports based the path of a root-inport block.
- Signal name — Connect signal data to ports based on the name of the signal on a port.
- Port order — Connect sequential port numbers to the imported data.

- Custom — Connect signal data to ports based on the definitions in a custom mapping file.

Each supported input format supports one or more mapping modes. To import MATLAB `timeseries` data, for example, you use any mapping mode . To import data array signal data, use the port order mapping mode.

## See Also

### Functions

`getRootInportMap` | `getS1RootInportMap`

## Related Examples

- “Map Data Using Root Inport Mapper Tool” on page 59-132
- “Create Signal Data for Root Inport Mapping” on page 59-181
- “Import Signal Data for Root Inport Mapping” on page 59-187
- “View and Inspect Signal Data” on page 59-191
- “Map Signal Data to Root Inports” on page 59-210
- “Create and Use Custom Map Modes” on page 59-230
- “Root Inport Mapping Scenarios” on page 59-233

## More About

- “Create Signal Data for Root Inport Mapping” on page 59-181

## Create Signal Data for Root Inport Mapping

### In this section...

“Identify Signal Data to Import and Map” on page 59-181

“Choose a Naming Convention for Signal and Buses” on page 59-182

“Choose a Base Workspace and MAT-File Format” on page 59-182

“Bus Signal Data for Root Inport Mapping” on page 59-183

“Create Signal Data in a MAT-File for Root Inport Mapping” on page 59-184

“Supported Microsoft Excel File Formats” on page 59-185

The first step for using the Root Inport Mapper tool is to the source of signal data to import and map. You can use existing signal data (for example, in a Microsoft Excel spreadsheet) or create data in a MAT-file.

For a summary of the other steps involved in using the Root Inport Mapper tool, see “Import and Mapping Workflow” on page 59-179.

### Identify Signal Data to Import and Map

You can import data from these sources.

- Base workspace — You can selectively import signal data from the base workspace. For more information about supported data formats, see “Choose a Base Workspace and MAT-File Format” on page 59-182.
- Data files — You can selectively import signals contained in MAT-files and Microsoft Excel files. Each time that you import the contents of the file, the contents overwrite data already loaded for the file in the Root Inport Mapper tool.

For more information, see “Choose a Base Workspace and MAT-File Format” on page 59-182 and “Supported Microsoft Excel File Formats” on page 59-185.

---

**Tip:** To import signal data from an Microsoft Excel spreadsheet, consider using the From Spreadsheet block. The From Spreadsheet block incrementally loads data from the spreadsheet during simulation. If you use a From Spreadsheet block, you do not need to do anything to handle changes to sheet values.

---

## Choose a Naming Convention for Signal and Buses

When identifying signals to import, consider using a naming convention for signals and buses such that this grouping of data (signal group) is interchangeable. For example, you can have two MAT-files whose data has different values but the same variable names. Then you can switch the groups of input data into and out of a model quickly.

## Choose a Base Workspace and MAT-File Format

The Root Inport Mapper tool supports these MATLAB data types or formats for imported signal data. For each data type, you can use one or more mapping modes.

Data Formats	Block Name	Block Path	Signal Name	Port Order	Custom
<code>Simulink.SimulationData.Dataset</code>	✓	✓	✓	✓	✓
MATLAB timeseries	✓		✓	✓	✓
<code>Simulink.SimulationData.Signal</code>	✓	✓	✓	✓	✓
<code>Stateflow.SimulationData.State</code>	✓	✓	✓	✓	✓
Structure with time and structure without time				✓	
Data array				✓	
Array of buses	✓		✓	✓	✓
Asynchronous function-call signal on page 10-64	✓		✓	✓	✓

---

**Note:** If your MAT-file or base workspace contains data in a format that the Root Inport Mapper tool does not support, the tool ignores that data.

---

**Note:** Although the Root Inport Mapper tool accepts these formats, it can only link in a `Simulink.SimulationData.Dataset` object. To convert the data in your MAT-file to

a `Simulink.SimulationData.Dataset` object, in the Root Inport Mapper From dialog box, select the **Convert signals into a scenario dataset and save to MAT-file** check box. Alternatively, use the `convertToSlDataset` function to convert your data.

---

### Dataset Signal Data

If data sets have nonunique element names, use the **Port Order** map mode.

### MATLAB Timeseries Signal Data

If you have MATLAB timeseries data with enumeration, and the enumeration class is not on your MATLAB path, the tool ignores that timeseries data.

### Structure Signal Data

When converting structure signal data to datasets, the signals are named using the value contained in the label field of the signal field of the structure signal.

### Array Signal Data

The Root Inport Mapper tool tries to map the data array to a single inport. In this case, you can choose any of the map modes.

## Bus Signal Data for Root Inport Mapping

The signal data that you import and map to a root-level Inport block can include bus data. You cannot map bus signals to a root-level Enable or Trigger block.

- 1 In the MATLAB workspace, create or load a bus object on page 63-59 for the bus data that you want to import and map.
- 2 If you create a bus object in the base workspace, save the bus object definition to a MAT-file, such as `d_myBusObj.mat`.
- 3 Create a separate MAT-file that contains the bus data you want to import for the bus object. Use one of these approaches:
  - Use an existing MAT-file that already contains a MATLAB struct or `Simulink.SimulationData.Dataset` object.
  - Create the bus in the base workspace and then save it to a MAT-file.

- 4 Set up the model to load the bus object.
  - For root-level Inport blocks that you map signals to, set the **Data type** field to **Bus**. Specify the name of the variable for the bus object to be used for signal data mapping.
  - Load into the model the MAT-file that includes the bus objects used for mapping. For example, use a `PreLoadFcn` callback function. For details, see “Alternative Workflows to Load Data” on page 59-223.

## Create Signal Data in a MAT-File for Root Inport Mapping

You can create signal data in a MAT-file to use for root-inport mapping. For example, you can import three signals (`signal1`, `signal2`, and `signal3`), and save the signals in a MAT-file. The `Simulink.SimulationData.Signal` objects include signal names, block names, block paths, and port order index values.

You can use the `convertToSlDataset` function convert MAT-files to `Simulink.SimulationData.Dataset` objects.

- 1 In MATLAB, create three `Simulink.SimulationData.Signal` objects, specifying signal names, block paths, and port order index values.

```
signal1 = Simulink.SimulationData.Signal;  
signal1.Name = 'signal1';  
signal1.BlockPath = Simulink.SimulationData.BlockPath('Out1');  
signal1.PortType = 'inport';  
signal1.PortIndex = 1;
```

```
signal2 = Simulink.SimulationData.Signal;  
signal2.Name = 'signal2';  
signal2.BlockPath = Simulink.SimulationData.BlockPath('Out2');  
signal2.PortType = 'inport';  
signal2.PortIndex = 2;
```

```
signal3 = Simulink.SimulationData.Signal;  
signal3.Name = 'signal3';  
signal3.BlockPath = Simulink.SimulationData.BlockPath('Out3');  
signal1.PortType = 'inport';  
signal1.PortIndex = 3;
```

- 2 In the MATLAB workspace, select `signal1`, `signal2`, and `signal3`. Right-click and in the context menu, click **Save as**. Save the file as `mySigData.mat`.



### 3 Open the MAT-file.

```
open mySigData.mat

ans =

    signal1: [1x1 Simulink.SimulationData.Signal]
    signal2: [1x1 Simulink.SimulationData.Signal]
    signal3: [1x1 Simulink.SimulationData.Signal]
```

You can use the **Signal Name**, **Block Name**, **Block Path**, or **Port Order** map mode with this MAT-file. Based on your map mode, the Root Inport Mapper tool maps the signal data from the MAT-file to corresponding ports.

## Supported Microsoft Excel File Formats

You can use the Root Inport Mapper tool to import signal data into Excel spreadsheets. You can also use the Root Inport Mapper tool to import signal data in CSV files on a Windows system with Microsoft Office installed.

- Use sheet names that follow MATLAB variable name rules. If you import from a sheet whose name does not follow these rules, the Root Inport Mapper tool uses a modified sheet name. This modified sheet name follows the MATLAB variable name rules. For example, if you have a sheet name **Group Name**, the Root Inport Mapper uses the modified name **GroupName**.
- For signal names, use the first row of a sheet. Either specify a signal name for every signal or do not specify any signal names. If you do not specify any signal names, the tool assigns signal names by using the format **Signal#**.
- For time values, use the first column of the remaining rows. The time values must increase for each row.
- Put signal values in the remaining columns.

This example of an Microsoft Excel spreadsheet that is set up for root-inport mapping.

- The sheet name is **sigData**, which is a valid MATLAB variable name.
- The first row contains the signal names **signal1**, **signal2**, and **signal3**.
- The first column has six time values.
- In each row with a time value, columns to the right of the first column contain signal data values for each signal.

	A	B	C	D	E
1		signal1	signal2	signal3	
2	0	2	4	6	
3	1	3	5	7	
4	2	2	4	6	
5	3	4	6	8	
6	4	5	7	9	
7	5	6	8	10	
8					
9					
10					

Navigation: < > sigData Sheet2 Sheet3 +

## Related Examples

- “Map Data Using Root Inport Mapper Tool” on page 59-132
- “Create Signal Data for Root Inport Mapping” on page 59-181
- “Import Signal Data for Root Inport Mapping” on page 59-187
- “View and Inspect Signal Data” on page 59-191
- “Map Signal Data to Root Inports” on page 59-210
- “Root Inport Mapping Scenarios” on page 59-233

## More About

- “Map Root Inport Signal Data” on page 59-178

## Import Signal Data for Root Inport Mapping

### In this section...

“Import Signal Data” on page 59-187

“Import Bus Data” on page 59-189

“Import Signal Data from Other Sources” on page 59-189

“Import Test Vectors from Simulink Design Verifier Environment” on page 59-189

### Import Signal Data

Before you can import data, identify the signals that you want to import and set up the data to use with root-level inport mapping. See “Create Signal Data for Root Inport Mapping” on page 59-181. For a summary of the other steps involved in using the Root Inport Mapper tool, see “Import and Mapping Workflow” on page 59-179.

For data import purposes, the Root Inport Mapper From Workspace dialog box provides a **Convert signals into a scenario dataset and save to MAT-file** check box, selected by default. Select this check box to convert the data in your MAT-file to a `Simulink.SimulationData.Dataset` object. Alternatively, use the `convertToSldataset` function to convert your data.

---

**Note:** The Root Inport Mapper tool uses the term *link* to refer to the act of importing Simulink data. The sources from which you can link your data are in the LINK section of the tool.

---

To import signal data for root-inport mapping:

- 1 Open the Root Inport Mapper tool. In the **Configuration Parameters > Data Import/Export** pane, click **Connect Input**.
- 2 In the LINK section, select the data source.
  - To browse to the MAT-file or spreadsheet file that contains the signals you want to import, select **From Spreadsheet** or **From MAT-File**. Click **Open** to return to the LINK section. Then click **OK**.

**Note:** To import bus data for root inport mapping, see “Import Bus Data” on page 59-189.

- To display a list of base workspace variables that you can import, select **From Workspace**. Select the variables that you want to import and click **OK**.

The From MAT-File dialog box displays the contents of the spreadsheet, file, or base workspace.

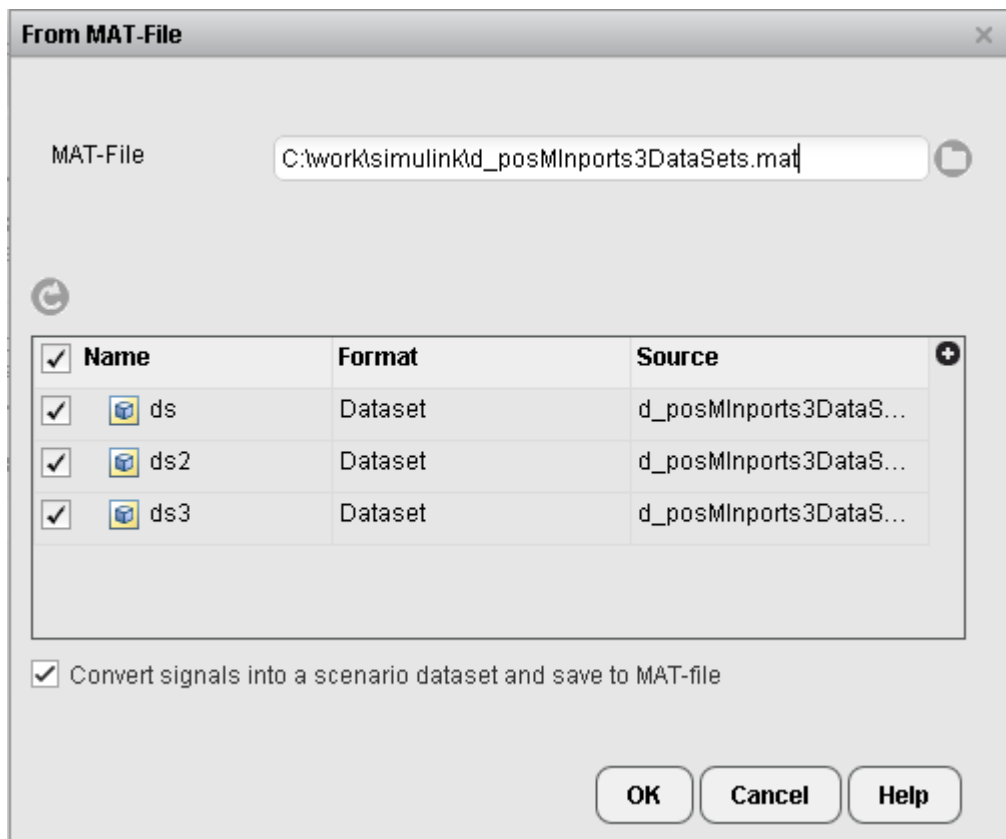

- 3 Select the data that you want to import, and then click **OK**.

The Root Inport Mapper tool displays the imported data.

## Import Bus Data

Use bus objects for bus data that you want to import and map to root inports.

Store the bus objects in a MAT-file. Use a different MAT-file that contains the bus data that you want to import for the bus object. This file can be an existing MAT-file that already contains a MATLAB `struct`, or you can create the bus in the base workspace and save it to a MAT-file. For more information, “Bus Signal Data for Root Inport Mapping” on page 59-183.

To import the bus data, in the LINK section of the Root Inport Mapper toolstrip, click **From MAT-File**. Select the MAT-file that contains the bus data and click **OK**.

## Import Signal Data from Other Sources

Use the Root Inport Mapper tool to import signals from other sources.

- You can import Excel spreadsheet data. The Root Inport Mapper tool imports a worksheet as a `Simulink.SimulationData.Dataset` object that contains timeseries elements.
- To convert and import test vectors from Simulink Design Verifier, see “Import Test Vectors from Simulink Design Verifier Environment” on page 59-189.
- To import signals from models that contain Signal Builder blocks, see “Converting Harness-Driven Models to Use Harness-Free External Inputs” on page 59-216.

## Import Test Vectors from Simulink Design Verifier Environment

You can import and map Simulink Design Verifier test vectors. This workflow requires a Simulink Design Verifier license.

Import a MAT-file that contains a Simulink Design Verifier test vector structure `sldvData`.

The test vectors are converted during the import to a `Simulink.SimulationData.Dataset` supported by the Root Inport Mapper tool.

Alternatively, you can use the Simulink Design Verifier `sldvsimdata` function to convert a Simulink Design Verifier test structure to a `Simulink.SimulationData.Dataset` object. Save the output to a MAT-file and then import that file into the Root Inport Mapper tool.

## **Related Examples**

- “Map Data Using Root Inport Mapper Tool” on page 59-132
- “Create Signal Data for Root Inport Mapping” on page 59-181
- “View and Inspect Signal Data” on page 59-191
- “Map Signal Data to Root Inports” on page 59-210
- “Root Inport Mapping Scenarios” on page 59-233

## **More About**

- “Map Root Inport Signal Data” on page 59-178

## View and Inspect Signal Data

After you import signal or bus data, you can view and inspect signal data.





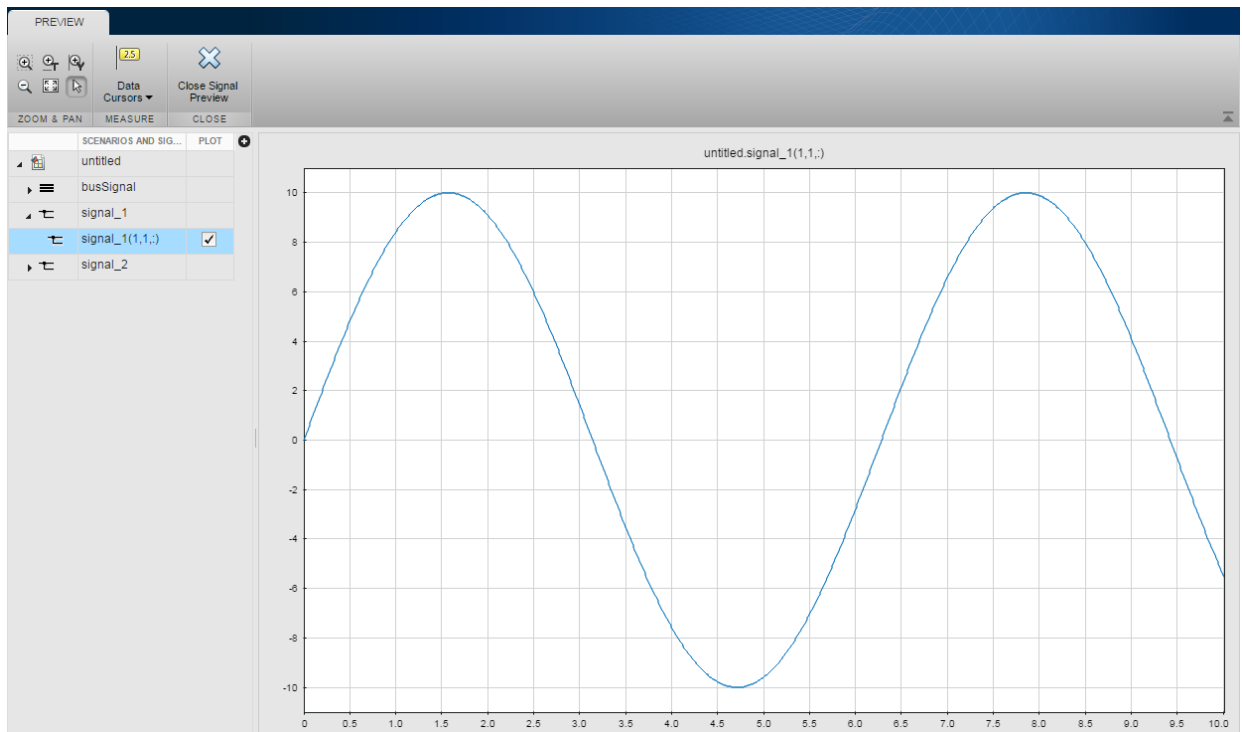

For a summary of the other steps involved in using the Root Inport Mapper tool, see “Import and Mapping Workflow” on page 59-179.

- 1 In the **SCENARIO** tab, click **Signals > Preview Signals**.
- 2 To plot the signal, in the **Plot** column, select the check box next to the signal. If the format is a bus, click the expander (▶) to see and select the elements of the bus.



- 3 Explore the plots using the **Measure** and **Zoom & Pan** sections on the toolbar.
  - In the **Measure** section, use the **Data Cursors** button to display one or two cursors for the plot. These cursors display the T and Y values of a data point in the plot. To view a data point, click a point on the plot line.

- In the **Zoom & Pan** section, select how you want to zoom and pan the signal plots. Zooming is only for the selected axis.

Type of Zoom or Pan	Button to Click
Zoom in along the T and Y axes.	
Zoom in along the time axis. After selecting the icon, on the graph, drag the mouse to select an area to enlarge.	
Zoom in along the data value axis. After selecting the icon, on the graph, drag the mouse to select an area to enlarge.	
Zoom out from the graph.	
Fit the plot to the graph. After selecting the icon, click the graph to enlarge the plot to fill the graph.	
Pan the graph up, down, left, or right. Select the icon. On the graph, hold the left mouse button and move the mouse to the area of the graph that you want to view.	

If you view and inspect signal using the `Simulink.SimulationData.Dataset` or `Simulink.SimulationData.DatasetRef` plot method, the Signal Preview window contains an **Open Simulation Data Inspector** button. Click this button to plot the data using the Simulation Data Inspector.

## See Also

`Simulink.SimulationData.Dataset` | `Simulink.SimulationData.DataSet.plot` | `Simulink.SimulationData.DatasetRef`

## Related Examples

- “Map Data Using Root Inport Mapper Tool” on page 59-132
- “Create Signal Data for Root Inport Mapping” on page 59-181



- “Load Data to Root-Level Input Ports” on page 59-164
- “Map Signal Data to Root Inports” on page 59-210
- “Root Inport Mapping Scenarios” on page 59-233

### **More About**

- “Map Root Inport Signal Data” on page 59-178

## Create and Edit Signal Data

### In this section...

“Signal Editor Table Editing Limitations” on page 59-194

“Create Signal Data” on page 59-195

“Work with Signal Data” on page 59-199

“Save and Send Changes to the Root Inport Mapper Tool” on page 59-202

“Create Signals with the Same Properties” on page 59-202

“Add Signals to Scenarios” on page 59-204

“Work with Data in Signals” on page 59-207

You can create and edit signal data using the Signal Editor, available from the SCENARIO section of the Root Inport Mapper tool. You can then import and map the signal data to root-level ports.

To create a new MAT-file for your new signal data, select **Signals > New MAT-File**. To link in an existing signal data file from an existing scenario and edit the signals in that file, use the **Signals > Edit MAT-File**. Signal Editor works only with MAT-files.

You can:

- Create and edit multiple signals in multiple data sets.
- Use existing scenarios to get existing data sets for which you can edit and signals.

While editing signal data:

- Use tabular editing to modify signal data.
- Modify signal properties such as name, interpolation, and unit properties.
- Drag and drop signals to change signal hierarchies for buses and data sets.

### Signal Editor Table Editing Limitations

These capabilities are currently not supported:

Limitation Description	Workaround
Multidimensional and fixed-point signal data is not editable	Edit the multidimensional and fixed-point signal data in the MATLAB base workspace, then import the data as a scenario to Signal Editor.

Limitation Description	Workaround
MATLAB expressions such as <code>sin</code> and <code>cos</code> are not supported.	Create function-generated signals in the MATLAB base workspace, then import the contents of the base workspace to the Signal Editor.

## Create Signal Data

Create signal data either from existing model data (scenarios), start with an empty scenario, or immediately start creating signals.

After inserting the signal, view and plot the data by clicking the **PLOT** check box.

### Use Scenarios

The Root Inport Mapper tool uses scenarios to save a snapshot of the current state of the imported and mapped signals in an MLDATX file. To create signal data using existing data sets from existing scenarios, or create an empty scenario into which to add signals, use the Signal Editor **Scenario** menu.

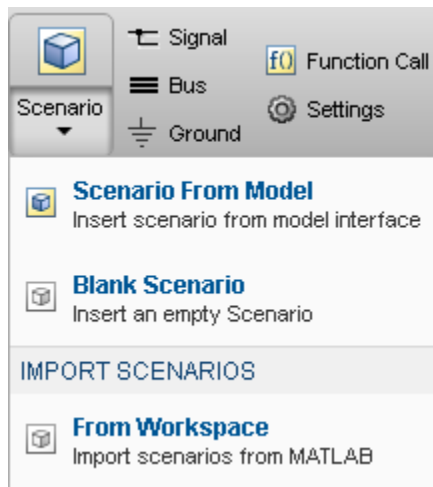

Action	Option
To create a scenario from the root inports of a model	Select <b>Scenario &gt; Scenario from Model</b> .

Action	Option
	<b>Note:</b> When using this option, the resulting scenario contains signals with the data types and dimensions of the inport ports.
To create an empty scenario and create signals from scratch	Select <b>Scenario &gt; Blank Scenario</b> .
To import scenarios from MATLAB workspace	Select <b>Scenario &gt; From Workspace</b> .

After you have your scenario:

- To begin inserting signals, use the other options in the INSERT section of the Root Inport Mapper tool. For more information, see “Insert Signals” on page 59-196.
- To change the signal hierarchy or change the name of a signal, see “Change Signal Names and Hierarchies” on page 59-197.

### Insert Signals

To insert signals into scenarios or just to a list of signals, click a signal type from the INSERT section.

- Signal
- Bus
- Ground
- Function Call

If you need a function-call signal for a root inport with explicit periodic sample time, insert a ground signal instead. Simulink then executes the function-call automatically.

The new signals appear in the SCENARIOS AND SIGNALS section.

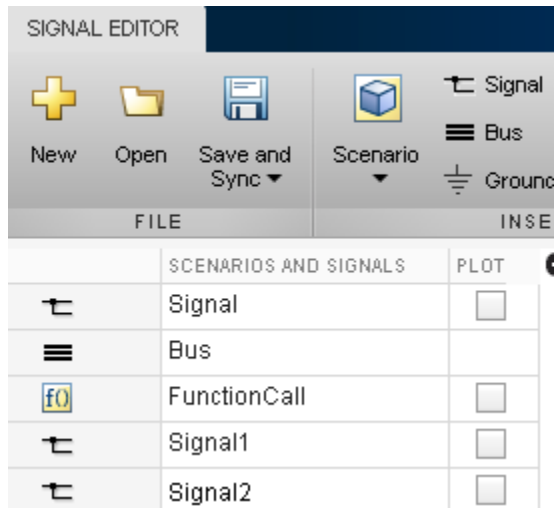

You can also insert multiple signals of the same type. For more information, see “Create Signals with the Same Properties” on page 59-202.

To change the signal hierarchy or change the name of a signal, see “Change Signal Names and Hierarchies” on page 59-197.

To edit the properties of a signal, see “Work with Signal Data” on page 59-199.

### Change Signal Names and Hierarchies

In the SCENARIOS AND SIGNALS section, you can change signal names hierarchies, create duplicates of signals, and delete signals. Simulink ignores leading and trailing spaces in signal names.

- To change a signal name, double-click the name and change it.

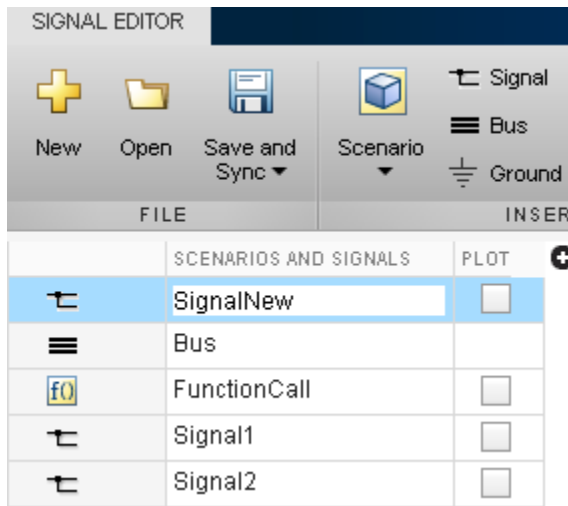

- To change the hierarchy of a signal, drag and drop it. For example, you can drag and drop signals into a bus.

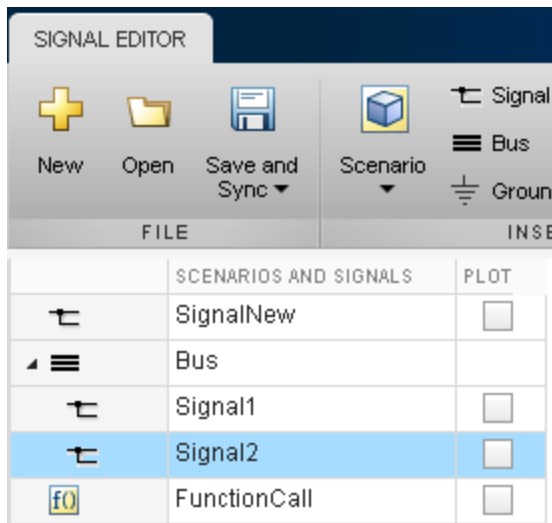

Alternatively, use the **Move Up** and **Move Down** buttons in the ADJUST section.

- To duplicate a signal, right-click a signal and select **Duplicate Signal**.

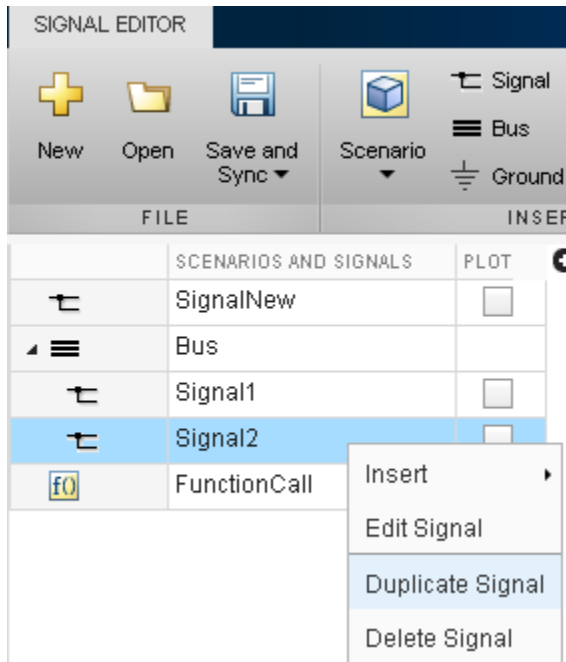



Alternatively, use the **Duplicate** button in the ADJUST section. You can also adjust the default properties of the signal you duplicate. For more information, see “Create Signals with the Same Properties” on page 59-202.

## Work with Signal Data

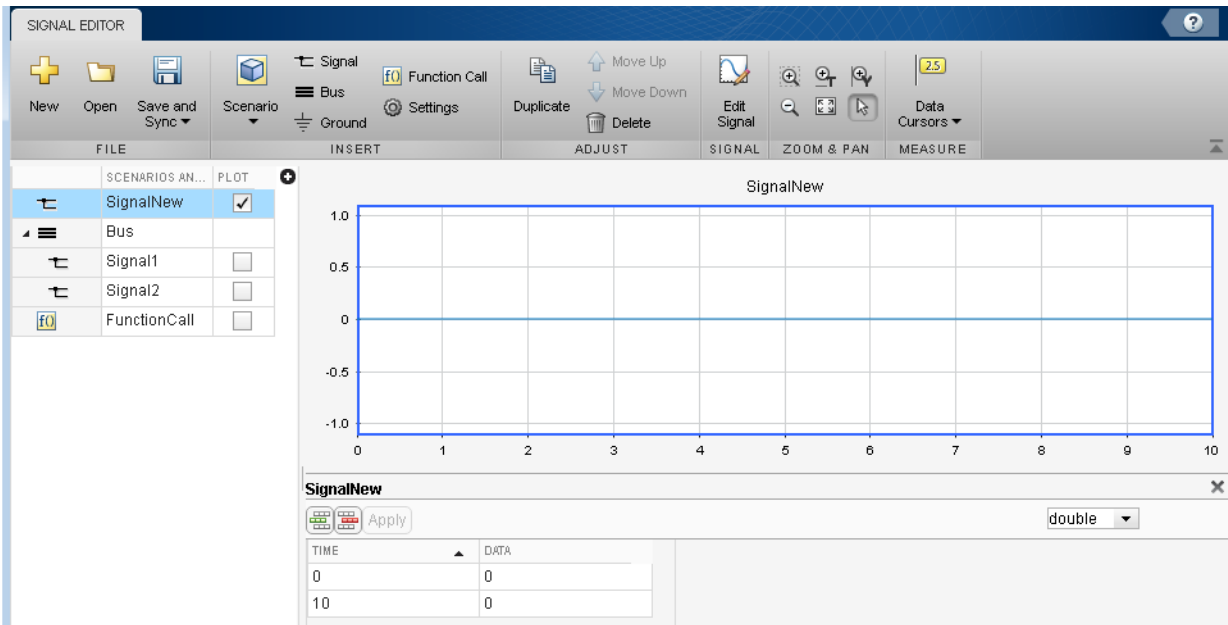
To edit signal data, select a signal and click **Edit Signal** in the Signal section. A plot of the signal displays. Under the signal plot is a tabular editor.



- To insert or delete a data row for a signal, use  or , respectively.
- To change the data type for signal data, select the type from the pull-down.



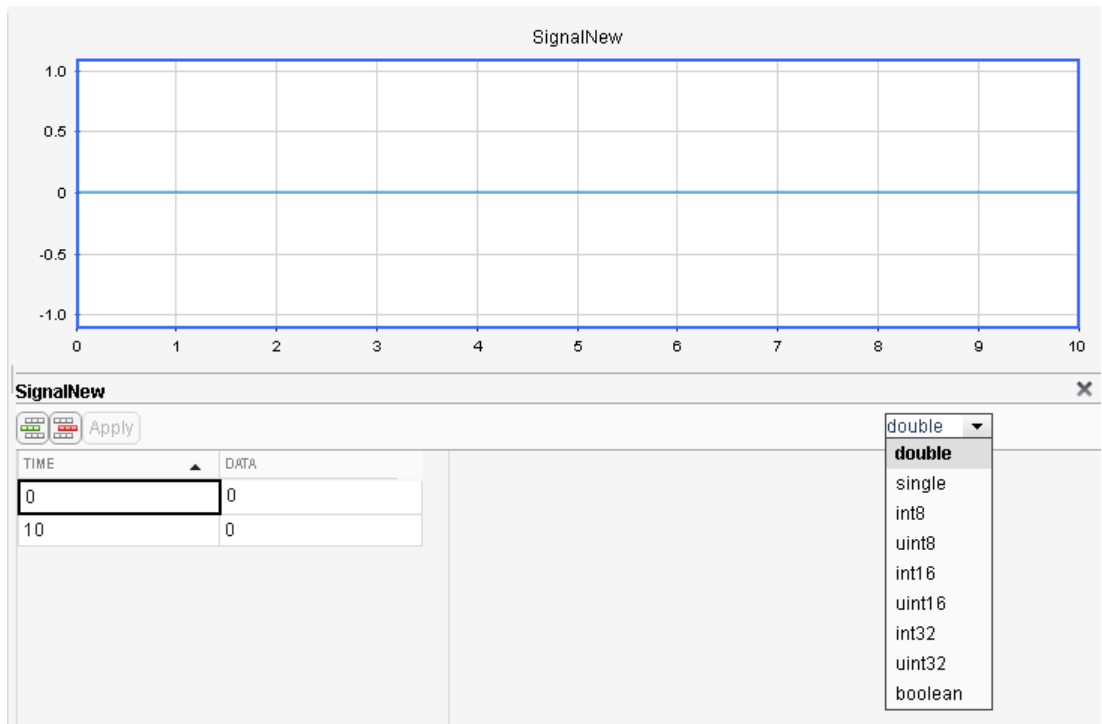

- To change the time or data for each signal, edit the associated column of the data row, then click **Apply** to update the plot of the signal.

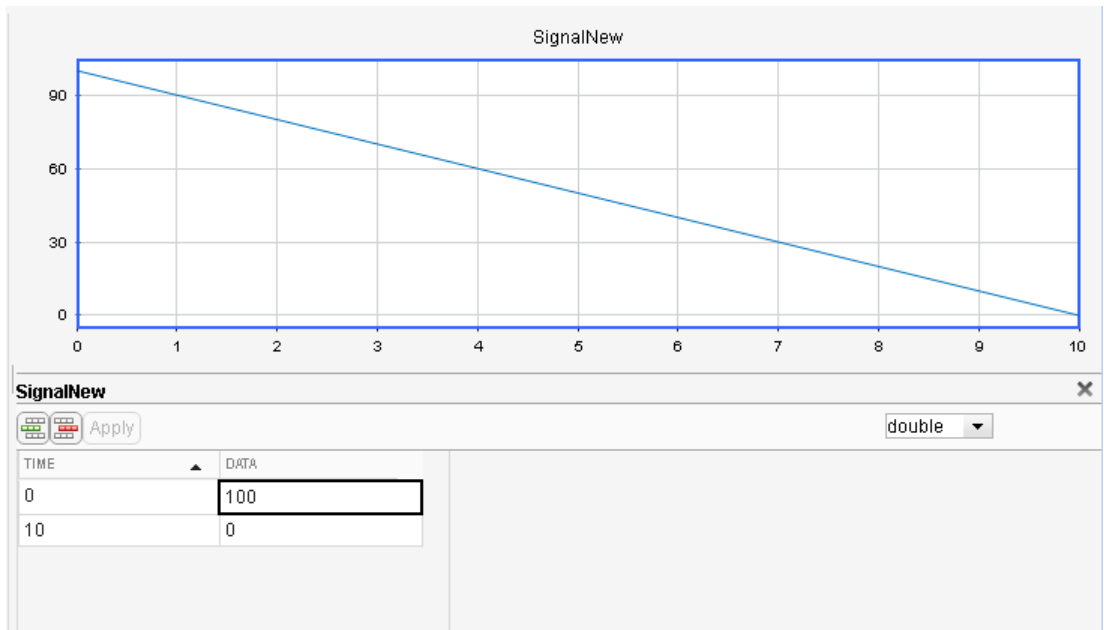

## Save and Send Changes to the Root Inport Mapper Tool

When you are done adding and modifying signals and scenarios, use the **Save and Sync** button to save the changes to a MAT-file. The Signal Editor also sends the data to the Root Inport Mapper Tool:

- If the Root Inport Mapper tool has the scenario loaded, the Root Inport Mapper tool updates with the new data.
- If the Root Inport Mapper tool has the scenarios mapped and your changes affect the mapping, the Root Inport Mapper tool unmaps the scenario.

## Create Signals with the Same Properties

To create signals of the same predefined type, see the **Duplicate** button in the Adjust section . To change the predefined signal type, click the **Settings** icon, . A **Default Properties for Insertion** dialog box displays.

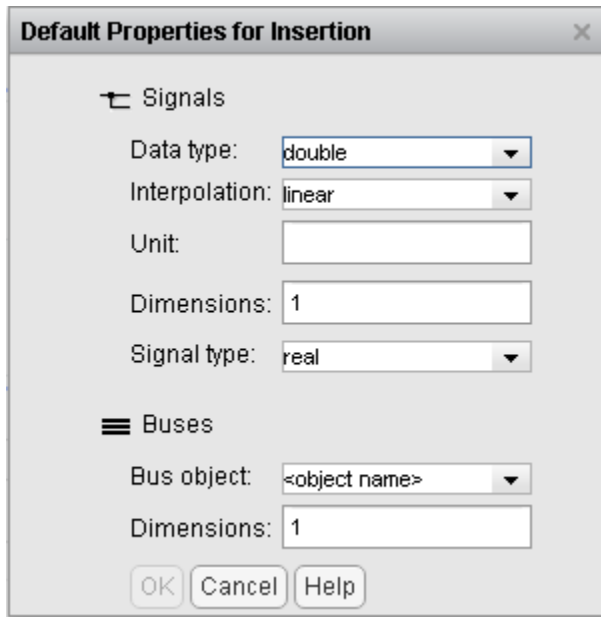

- **Data type** — From the dropdown list, select the signal data type.
- **Enumeration** — When you select the Enum data type, this parameter displays. Enter the class name of your enumeration.

If you define an enumeration class that contains the same integer value multiple times, for example:

```
classdef(Enumeration) hEnumColors_duplicateValues < Simulink.IntEnumType
    enumeration
        Red(118)
        Yellow(-14)
        Blue(90)
        Green(87)
        White(-14)
        Black(198)
        Brown(90)
        Pink(118)
        Purple(90)
    end
    methods (Static = true)
        function retVal = getDefaultValue()
```

```
        retVal = hEnumColors_duplicateValues.Blue;
    end
end
end
```

The Signal Editor treats the first enumeration value (**Red (118)**) as the canonical value and equates all subsequent instances of the same underlying integer 118 to the enumerated name **Red**. In other words, **Pink** equals **Red**.

- **Interpolation** — From the dropdown list, select **linear** or **zero order hold**.
- **Unit** — Enter an appropriate unit expression. For a suggested list of unit expressions, see allowed units.
- **Dimensions** — Enter the number of dimensions for the signal.
- **Signal type** — From the dropdown list, select **real** or **complex**.
- **Bus object** — From the dropdown list, select the bus object for which to define the dimensions. If you leave the **Bus object** parameter at the default `<object name>`, Signal Editor adds empty buses.
- **Dimensions** — Enter the number of dimensions for the bus object.

## Add Signals to Scenarios

This example describes how to create a scenario to be linked to from the Root Inport Mapper tool. You can then start the Signal Editor to manipulate and add signals to this scenario.

- 1 In the MATLAB Command Window, create some data by typing:

```
ts = timeseries([0;20],[0;10]);
```

- 2 In Simulink Editor, create a model that contains three Inport blocks, three Gain blocks, a Mux block, and a Scope block. Connect these block as shown:

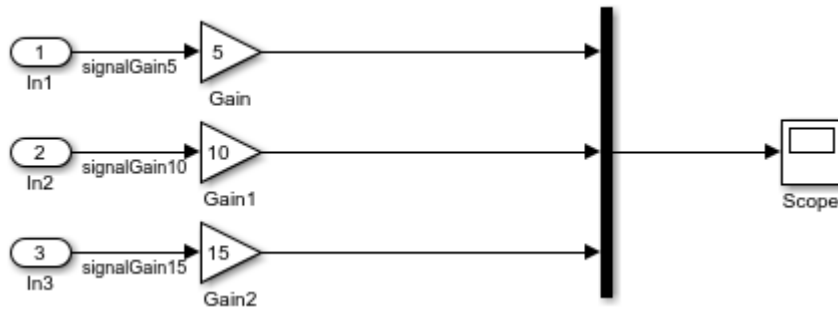

- 3 Set the gain for the Gain blocks to 5, 10, and 15, respectively.
- 4 Click one of the Inport blocks, then click the **Connect Input** button.

The Root Inport Mapper tool displays.

- 5 In Root Inport Mapper LINK section, select **From Workspace**.
- 6 In the From Workspace window, enter a name to store the MAT-file, clear the **ds** check box, then click **OK**.
- 7 In the SCENARIO section of the Signal Editor, click **Edit MAT-File**.
- 8 In the Edit Signal File window, select the new MAT-file and click **OK**.

The Signal Editor displays.

- 9 Add a new signal, *Signal*, to the scenario. Right-click SCENARIOS AND SIGNALS and select **Insert > Signal**.

This action adds *Signal* with these default properties.

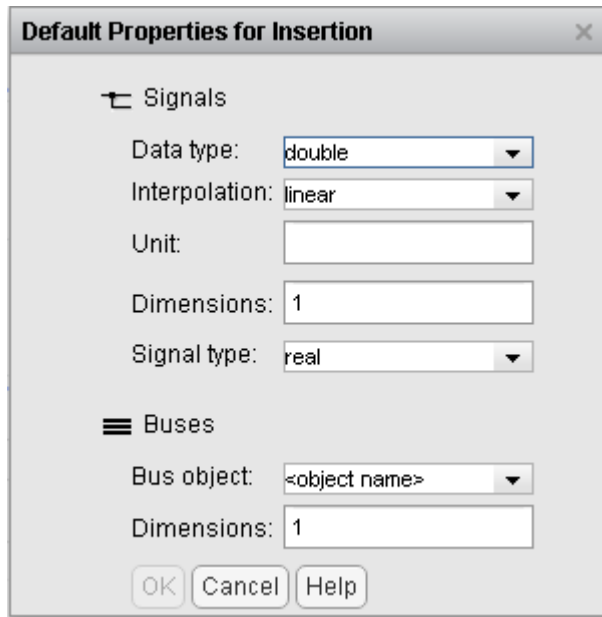

Alternatively, insert signals by clicking a signal type from the INSERT section.

- 10 Change the default properties of signals you want to add. In the INSERT section, select Defaults. In the Default Properties for Insertion dialog box, change the data type to boolean, then right-click SCENARIOS AND SIGNALS and select **Insert > Signal**.

This action adds *Signal1* with the data type boolean.

- 11 To check that the data type is boolean, click the plot check box for *Signal1*, then click **Edit Signal**.

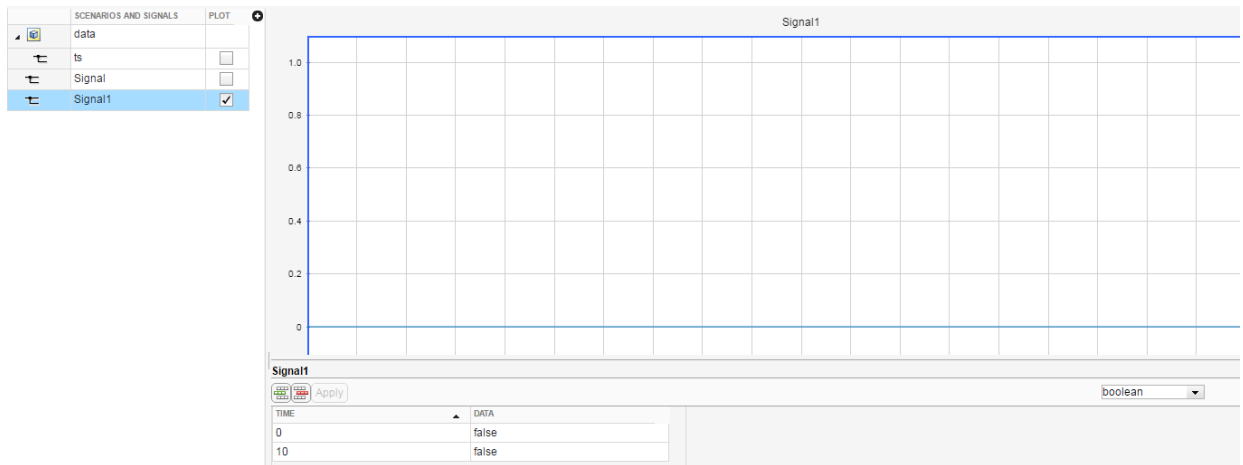

To add data for these signals, see “Work with Data in Signals” on page 59-207.

## Work with Data in Signals

This example describes how to add and delete data to the signals in the linked scenario. To create a model and data to work with, see “Add Signals to Scenarios” on page 59-204.

- 1 In the Signal Editor, in the SCENARIOS AND SIGNALS section, click the plot check box for the signal **ts**, then click the **Edit Signal** button.

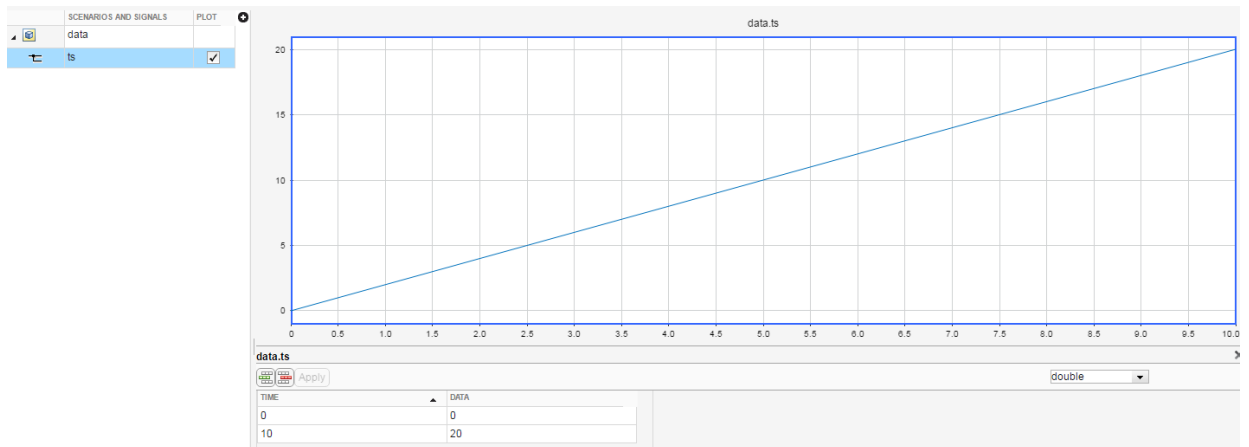

2 Add some data to the signal  $ts$ .

- a Click the add row icon  and some signals. To add a signal row between other signals, click the signal before and click the add row icon.
- b When done, click **Apply**. Clicking **Apply** updates the plot.

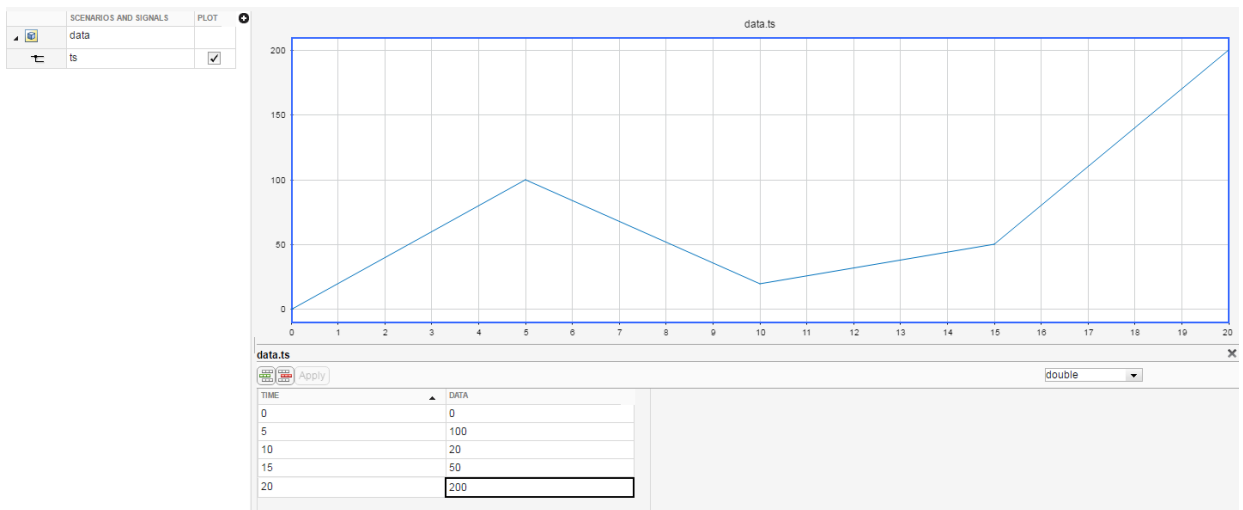



- 3** Remove the time 20 line from the signal. Select 20 and click .

### **Related Examples**

- “View and Inspect Signal Data” on page 59-191
- “Import Signal Data for Root Inport Mapping” on page 59-187
- “Map Signal Data to Root Inports” on page 59-210
- “Root Inport Mapping Scenarios” on page 59-233

### **More About**

- “Create Signal Data for Root Inport Mapping” on page 59-181
- “Map Root Inport Signal Data” on page 59-178

## Map Signal Data to Root Inports

### In this section...

“Select Map Mode” on page 59-210

“Set Options for Mapping” on page 59-211

“Select Data to Map” on page 59-212

“Map Data” on page 59-212

“Understand Mapping Results” on page 59-213

“Converting Harness-Driven Models to Use Harness-Free External Inputs” on page 59-216

“Alternative Workflows to Load Data” on page 59-223

After you import data, map signal data to root inports by selecting map modes and options and selecting data.

For a summary of the other steps involved in using the Root Inport Mapper tool, see “Import and Mapping Workflow” on page 59-179.

### Select Map Mode

To map signal data to root-level ports, use one of these map modes in the MAP TO MODEL section of the Root Inport Mapper toolstrip.

Goal	Map Mode
Assign signals to ports according to the name of the root-inport block. If the name of a signal or bus element matches the name of a root-inport block, the data is mapped to the corresponding port.	<b>Block Name</b>
Assign signals to ports according to the block path of the root-inport block. If the block path of a signal matches the block path of a root-inport block, the data is mapped to the corresponding port.	<b>Block Path</b>
Assign signals to ports according to the name of the signal on the port. If the signal name of a	<b>Signal Name</b>

Goal	Map Mode
data element matches the name of a signal at a port, the signal is mapped to the corresponding port.	
<p>Assign sequential port numbers to the imported data, starting at 1. Map signals to the corresponding inports.</p> <p>If there is more data than inports, the remaining data is mapped to enable and then trigger inports.</p> <p>If the data is not in the form of a dataset, it is processed in the order in which it appears in the data file.</p>	<b>Port Order</b>
Assign signals to ports according to the definitions in a custom file. To create a custom mapping mode, see “Create and Use Custom Map Modes” on page 59-230.	<b>Custom</b>

## Set Options for Mapping

If you want to set up mapping options, in the MAP TO MODEL section on the Root Inport Mapper toolstrip, click **Options**. To map the signals, see “Map Data” on page 59-212.

Goal	Option
Compile the model and review the data types of root-level inports and imported data.	<p><b>Update Model.</b> Compare the signal data and inport parameters to the root-level port and display the results. If you do not select this option, the tool maps the imported data to the root-level inport but does not compile the model.</p> <p>If your model uses configuration references to reference configuration sets, you cannot compile the model. To compile the model with the Root Inport Mapper tool, use the Model Explorer to activate a configuration set first.</p>

Goal	Option
	See “Understand Mapping Results” on page 59-213. If the data that is in the comparison window is inherited from the connected block, a warning appears.
Use strong data typing when mapping data from spreadsheets.	<b>Use Strong Data Typing with Spreadsheets.</b> Clear this check box to allow the Root Import Mapper tool to automatically convert spreadsheet input signals to the data types of the corresponding root inports. The Root Import Mapper tool can cast the spreadsheet data to only these data types: <code>double</code> , <code>single</code> , <code>int8</code> , <code>uint8</code> , <code>int16</code> , <code>uint16</code> , <code>int32</code> , <code>uint32</code> . If you select this check box or if the root inport is not one of these data types, you may receive a data type mismatch error.
Import bus data that is only partially defined.	<b>Allow partial.</b> Confirm that any partially specified bus data you import maps properly to root-level inports.

## Select Data to Map

To specify a subset of scenarios to map, click the down arrow on the **Map to Model** button. You can choose different mapping modes for different scenarios.

Goal	Option
Map all the scenario datasets (default).	<b>Map All</b>
Map the datasets of the scenarios currently selected in the SCENARIO DATASET section.	<b>Map Selected</b>
Map the disconnected datasets.	<b>Map Unconnected</b>
Map datasets that previously failed a mapping.	<b>Map Failed</b>
Map datasets that previously caused warnings.	<b>Map Warned</b>

## Map Data

After you import signals or buses, you can map data.

- 1 On the Root Inport Mapper toolbar, click **Map to Model**.
- The results of a signal mapping appear in the **SCENARIO DATASET** tab.
- 2 In the **FILE** section, click a data set to see the mapping results

The screenshot shows the Root Inport Mapper interface. On the left, the **SCENARIO DATASET** tab is active, showing a list of datasets: `ds`, `ds2`, and `ds3`, each with a green checkmark icon. On the right, the **MAPPING SUMMARY** tab is active, displaying a summary of the mapping results. The summary includes a table with the following data:

Total Scenario Datasets	0	3	0	0	8:55:52pm 12/18/15
	Not Mapped	Mapped	Warnings	Errors	
Marked For Simulation:					
ds - d_posMInports3DataSets.mat					
Status	Scenario Signal	Port	Block Name	Mapped Signal	
✓	In1	1	In1	ds.getElement(1)	
✓	In2	2	In2	ds.getElement(2)	
✓	In3	3	In3	ds.getElement(3)	

- The **MAPPING SUMMARY** tab lists the input data and the status of the mapping.

---

**Note:** See “Understand Mapping Results” on page 59-213.

---

- The mapping definition for the input data is applied to the model.



After you save and close the model, when you load input data of the same signal group to the workspace, the model uses the mapping defined for that signal group.

For an example of mapping signal data to root-level inputs, see “Converting Harness-Driven Models to Use Harness-Free External Inputs” on page 59-216.

After you save the mapping definition for a model, you can automate data loading. For more information, see “Alternative Workflows to Load Data” on page 59-223.

## Understand Mapping Results

When you complete the import and map process, the **MAPPING SUMMARY** tab displays the results in the status area. The results depend on whether you select the **Compile** option when you set up the mapping.

Status	Compile	Continue Without Compile
	The properties of the mapped data and the inport are appropriate for simulation.	The data type, dimension, and signal type properties of the data and inport are compatible.
	Not applicable	<p>Comparison of data and root-level port data type, dimension, and signal type properties cannot determine whether there is a match. If you do not compile before mapping, the tool cannot evaluate whether all the data types match unless you explicitly specify the inport data types. Confirm that you set these block parameters correctly:</p> <p>Inport block parameter <b>Data type</b> is not set to <code>Inherit:auto</code>.</p> <p>Inport block parameter <b>Dimension</b> is not set to <code>-1</code>.</p> <p>Inport block parameter <b>Signal type</b> cannot be <code>auto</code>.</p>
	The properties of the mapped data and the inport are not appropriate for simulation.	One or more of the data types, dimensions, or signal types of the signal data are not compatible with the root-level inport.

Root-level input ports that have not been mapped are displayed as empty ([]).

This figure shows mapping successes and failures.

The screenshot shows the 'MAPPING SUMMARY' tab in the Root Inport Mapper tool. It displays the following statistics:

- Total Scenario Datasets: 1
- Not Mapped: 0
- Mapped: 0
- Warnings: 0
- Errors: 1

Below the statistics is a table with the following data:

Status	Scenario Signal	Port	Block Name	Mapped Signal
✘	[]	1	In1	logout.getElement(1)
✔	[]	2	In2	logout.getElement(2)
✔	[]	3	In3	[]

In the Root Inport Mapper tool, clicking **Mark for Simulation** selects the **Input** check box in the **Data Import/Export** pane in the model Configuration Parameters dialog box. It also sets the value to the imported data variables. To apply the changes to the model configuration, in the **Data Import/Export** pane, click **OK**.

If your model uses configuration references to reference configuration sets, you cannot mark the model for simulation. To use this data to simulate the model with the Root Inport Mapper tool, use the Model Explorer to activate a configuration set first.

This graphic illustrates the application of the changes to the model configuration for the model in “Map Data” on page 59-212.

Input:

To inspect the imported data, you can:

- Connect the output to a scope, simulate the model, and observe the data.
- Log the signals and use the Simulation Data Inspector tool to observe the data.

To highlight the Inport block that is associated with the signal, select an item in the **MAPPING SUMMARY** tab. The selected Inport block is outlined with blue.

Use the Comparison Tool to evaluate your next action. The Comparison Tool shows the properties for the root-level inport and the signals that you are trying to map to the inport. You can tell from this table whether there is a mismatch that prevents the mapping. For example, if there is a mismatch, you can update the imported signals or edit the root-level inport. When you are done, reimport the data to map it.

To investigate warnings and failures, in the **MAPPING SUMMARY** tab, click the line item that you want to inspect. The Comparison Tool lists the selected variable, including the field name, input data, and root-level inport.

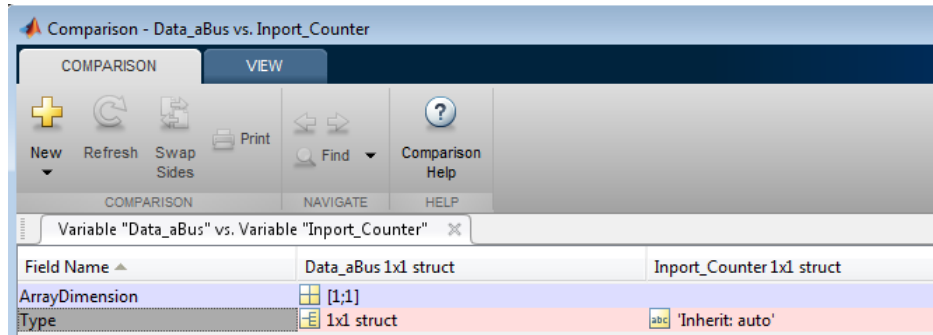

**Note:** When the input is a bus, click the levels of the bus object to see the individual elements in the bus.

Sometimes the Comparison Tool shows a warning or error, but your investigation of the elements indicates that there is no problem with mapping the data. In these cases, if you did not select the **Compile** check box from the **Options** menu, select it and click **Map** again.

**Tip:** Each time you click a nongreen status item, a new Comparison Tool instance appears. To dock all Comparison Tool instances in one window, click the **Dock** button .

For more information on the Comparison Tool, see “Comparing Files and Folders” (MATLAB).

## Converting Harness-Driven Models to Use Harness-Free External Inputs

This example shows how to convert a harness model that uses a Signal Builder block as an input to a harness-free model with root inports. The example collects data from the harness model and stores it in MAT-files, for use by the harness-free model. After storing the data, the example removes the Signal Builder block from the harness model and adds



root imports to create a harness-free model. Then, the data in the MAT-files is mapped to the root imports of the model.

### Save Harness Data to MAT-Files

Before converting the model to be harness-free, capture the test cases in the harness.

For this example, you will modify the model `sldemo_autotrans` from the **Modeling an Automatic Transmission Controller** example.

Open the example model. In the MATLAB Command Window type `sldemo_autotrans`.

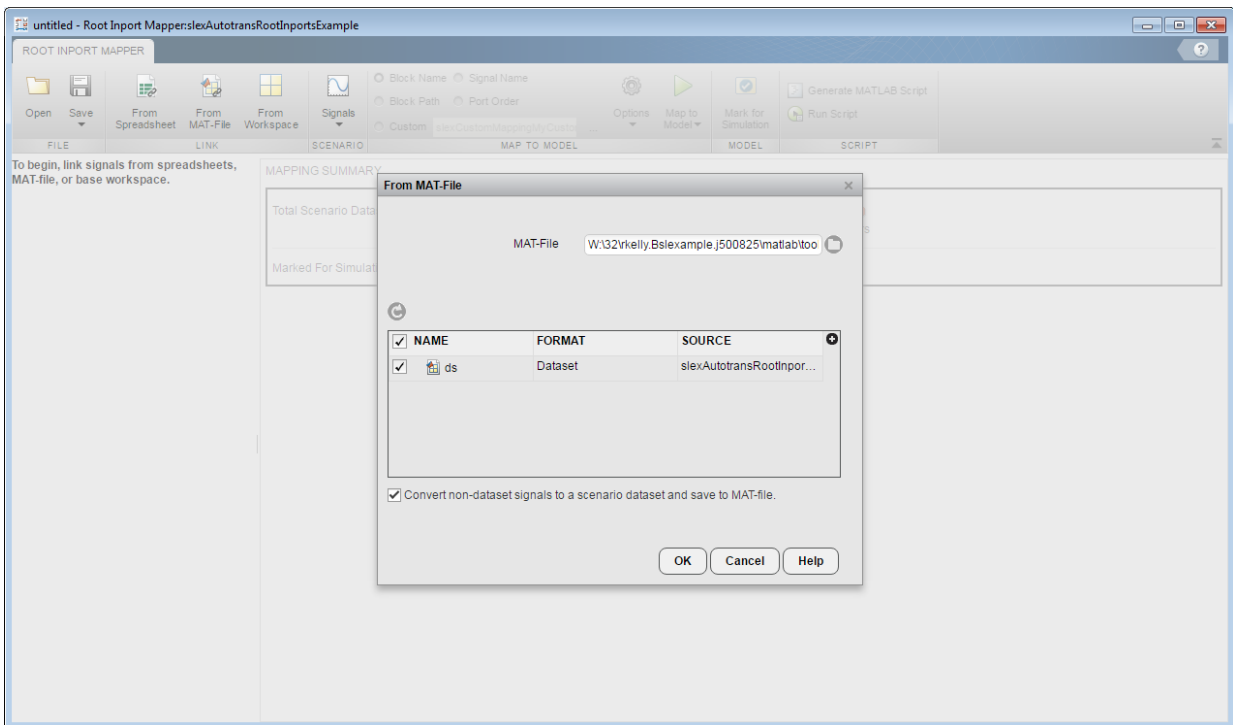

Use MATLAB function `slexAutotransRootImportsSaveActiveGroup` to save the Signal Builder block data of the active group into a MAT-file. At the command line type `slexAutotransRootImportsSaveActiveGroup('slexAutotransRootImport','ManeuversGU`. This function creates a MAT-file in the current directory with the same name as the active group. The function `slexAutotransRootImportsSaveActiveGroup` has been provided with this example.

### **Remove the Signal Builder Block**

Remove the Signal Builder block named ManeuversGUI and replace it with two inports.

- 1** Delete the Signal Builder block named ManeuversGUI.
- 2** Open the **Simulink Library Browser** and select **Commonly Used Blocks**.
- 3** Drag and drop two **input ports** from the **Library Browser** to the model.
- 4** Connect the input ports to the lines previously connected to the Signal Builder block.
- 5** Rename the inport ports. Name the input port connected to the Throttle line **Throttle**. Name the input port connected to the BrakeTorque line **Brake**.

Save the model as `slexAutotransRootInportsExample1.slx` or use the example `slexAutotransRootInportsExample.slx`.

The remaining steps of this example use the model `slexAutotransRootInportsExample.slx`. If you saved the model with a different name use your model name in the steps going forward.

?

## Modeling an Automatic Transmission Controller with Root Inports

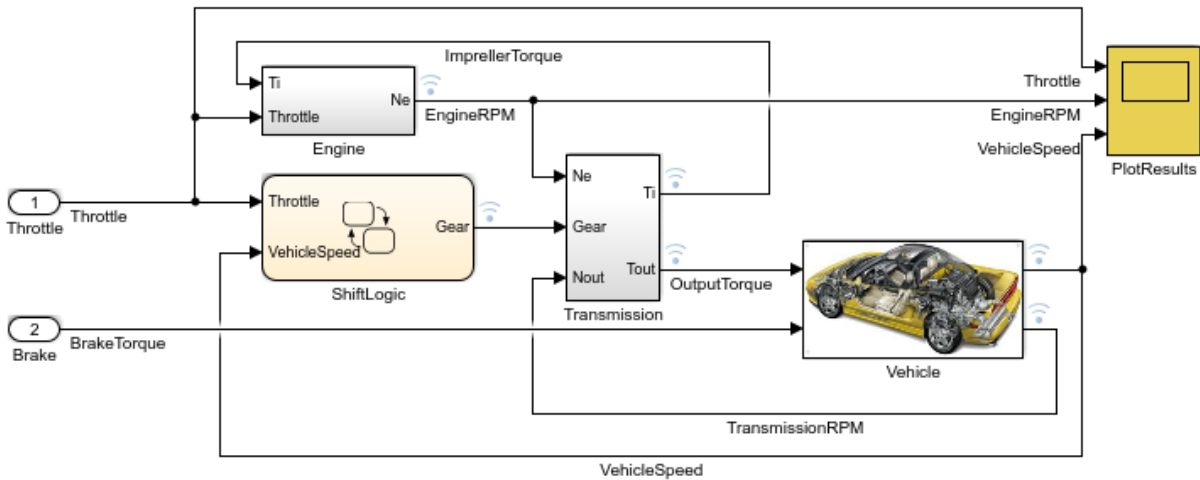

Copyright 2012 - 2014 The MathWorks, Inc.

### Set Up Harness-Free Inputs

Now that the model is harness-free, set up the inputs that you already saved (See "Save Harness Data to MAT-Files").

From the **Simulation->Model Configuration Parameters->Data Import/Export** pane, click the **Connect Input** button.

### Map Signals to Root Inport

The Root Inport Mapper tool opens.

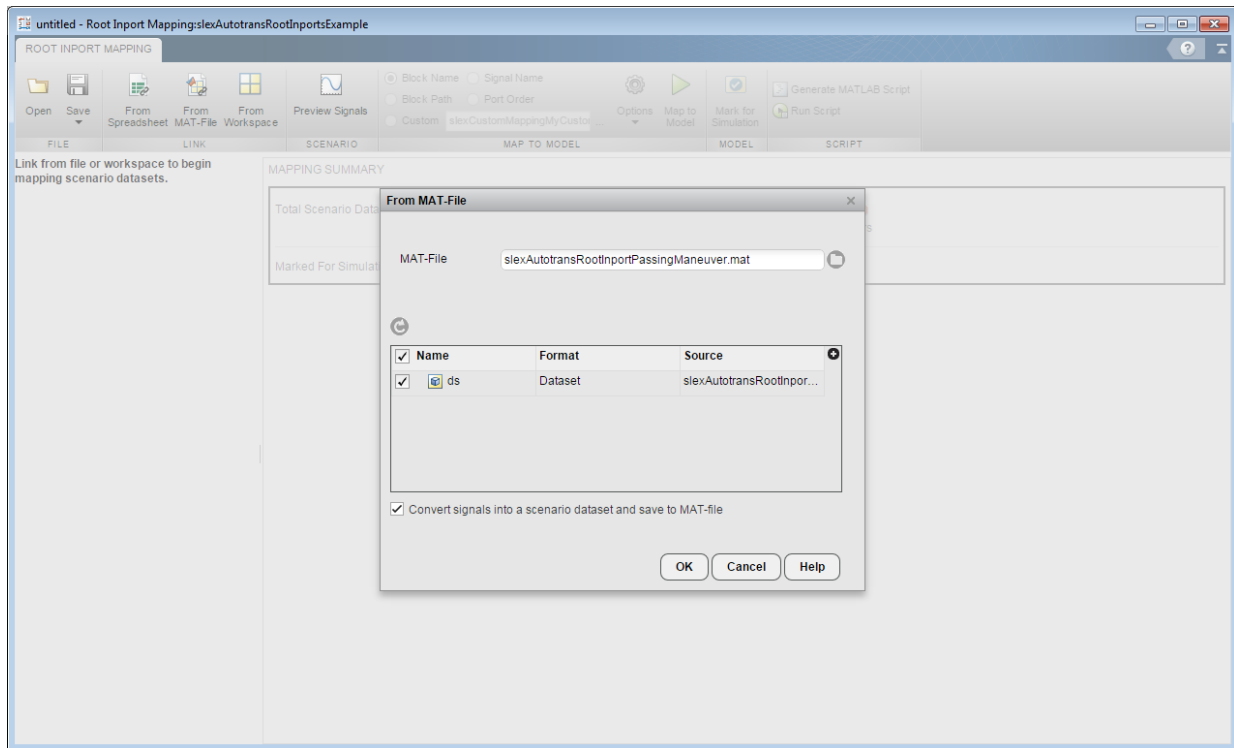

This example uses this tool to set up the model inputs from the MAT-file and map those inputs to an input port, based on a mapping algorithm. To select the MAT-file that contains the input data, click the **From MAT-File** button on the Root Inport Mapper toolbar. When the link dialog appears, click the Open Folder button. In the browser, select the MAT-file that you saved earlier.

### Select a Mapping Mode

Once you select the MAT-file `slxAutotransRootInportPassingManeuver.mat` that contains the input data, determine the root input port to which to send input data. Simulink matches input data with input ports based on one of five criteria:

- **Port Order** - Maps in the order it appears in the file to the corresponding port number.
- **Block Name** - Maps by variable name to the corresponding root inport with the matching block name.

- **Signal Name** - Maps by variable name to the corresponding root inport with the matching signal name.
- **Block Path** - Maps by the BlockPath parameter to the corresponding root inport with the matching block path.
- **Custom** - Maps using a MATLAB function.

Earlier in this example, you used the `slexAutotransRootInportsSaveActiveGroup` to save input data to variables of the same name as the harness signals `Throttle` and `Brake`, and you added input ports with names matching the variables. Given the set of conditions for the input data and the model input ports, the best choice for a mapping criteria is **Block Name**. Using this criteria, Simulink tries to match input data variable names to the names of the input ports. To select this option:

- 1 Click the **Block Name** radio button.
- 2 Click the **Options** button and select `Compile` from the dropdown. This will provide some verification on the mapping.
- 3 Click the **Map** button.

When compiling the data, Simulink evaluates inports against the following criteria to determine whether or not there is a compatibility issue. The status of this compatibility is reflected by the table colors green, orange, or red. Clicking a cell in the table which has orange or red color will open the Comparison Tool for further inspection.

- **Data Type** - Double, single, enum, ....
- **Complexity** - Real or complex
- **Dimensions** - Signal dimensions vs port dimensions

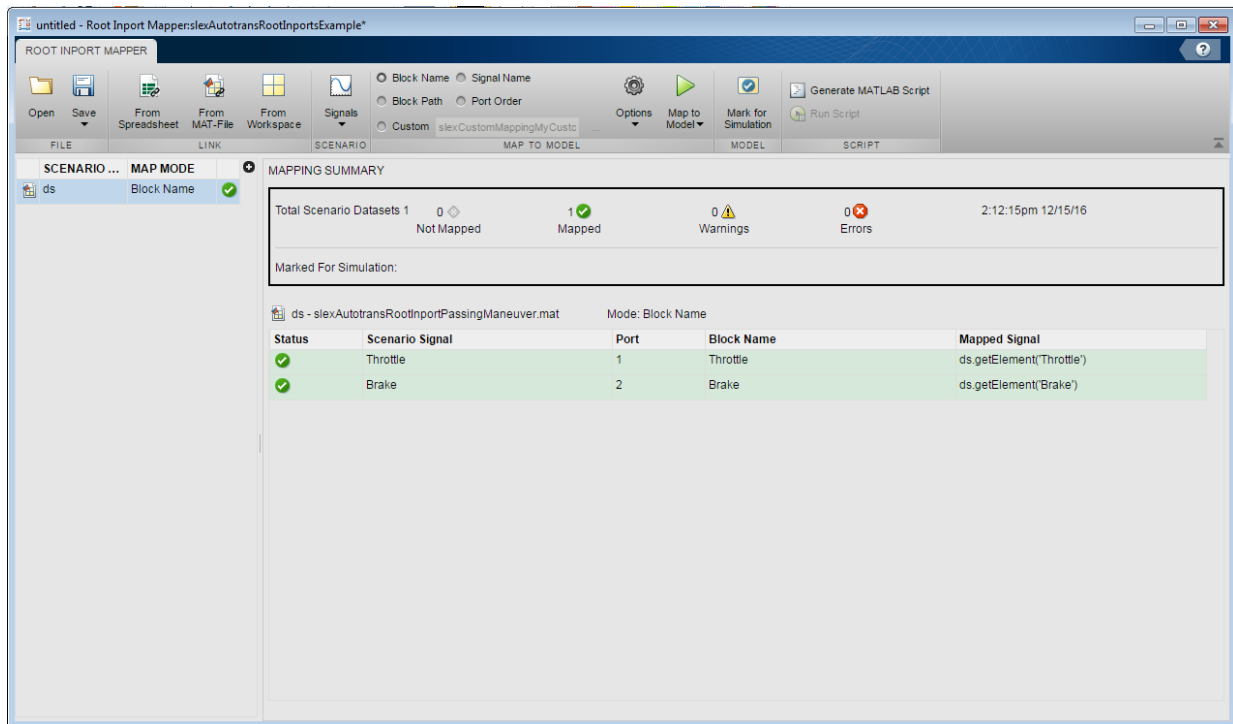

### Finalize the Inputs to the Model

Review the results of the mapping compatibility. Click the Scenario Dataset 'ds' in the scenario dataset list. To apply the results of the **Map** action and load the data that was mapped to the input ports from the MAT-file to the base workspace click the **Mark for Simulation** button. This action also sets the **Model Configuration Parameters->Data Import/Export->External Input** edit box with the proper comma-separated list of inputs.

### Simulating the Model

With the changes applied you can now simulate the model and view the results. Click the **Play** button on the model. To view the results of the simulation, double-click the Scope Block **PlotResults**.

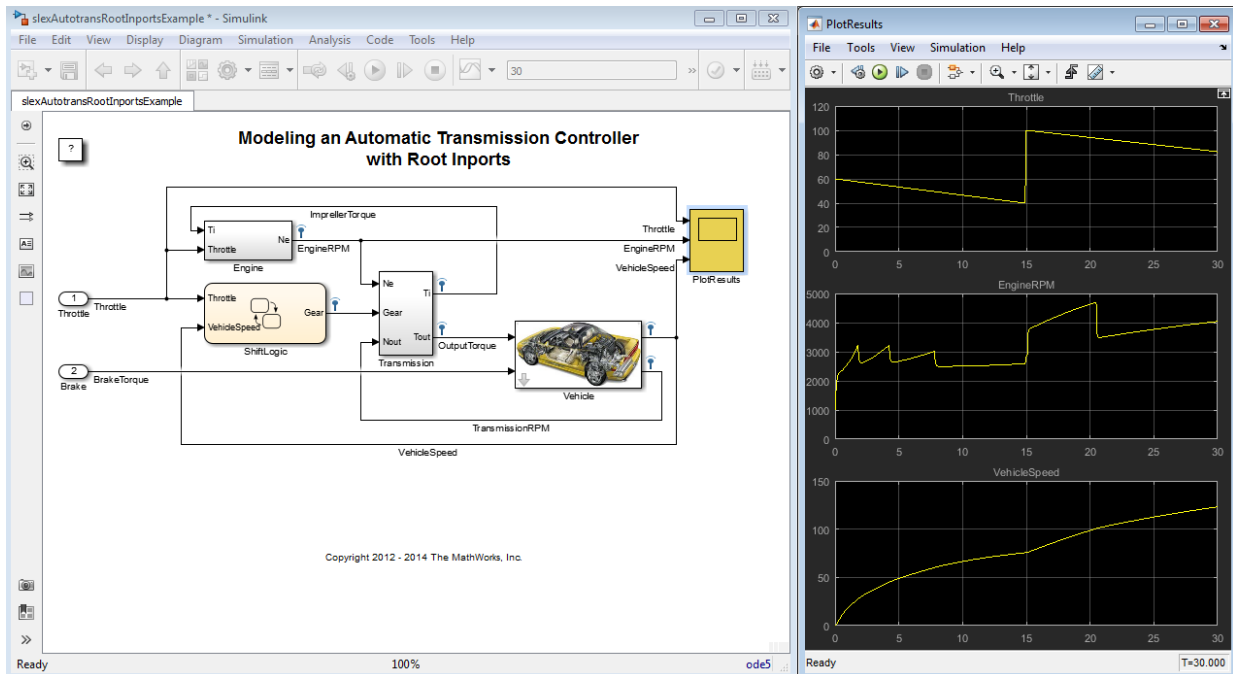

## Alternative Workflows to Load Data

After you save the mapping definition to a model, you can automate data loading and simulation. Consider one of the following methods.

### Command Line or Script

To load data and simulate the model from the MATLAB command line, use commands similar to:

```
load('signaldata.mat');
simout = sim('model_name');
```

To automate testing and load different signal groups, consider using a script.

The following example code creates timeseries data and simulates a model after loading each signal group. It:

- Creates signal groups with variable names *In1*, *In2*, and *In3*, and saves these variables to MAT-files.
- Simulates a model after loading each signal group.

---

**Note:** The variable names must match the import data variables in the **Configuration Parameters > Data Import/Export > Input** parameter.

---

```
% Create signal groups
fileName = 'testCase';
for k =1 :3

    % Create the timeseries data
    var1 = timeseries(rand(10,1));
    var2 = timeseries(rand(10,1));
    var3 = timeseries(rand(10,1));

    %create a dataset
    ds = Simulink.SimulationData.Dataset();
    ds = ds.addElement( var1, 'var1');
    ds = ds.addElement( var2, 'var2');
    ds = ds.addElement( var3, 'var3');

    % Save the data
    save([fileName '_' num2str(k) '.mat' ],'ds');
end
clear all

% After mapping and saving the model loop over signal groups and simulate
% Set the filename to append testcase # to
fileName = 'testCase';
% Loop backwards to preallocate
for k=3:-1:1
    % Load the MAT-file.
    load([fileName '_' num2str(k) '.mat']);

    % Simulate the model
    simOut{k} = sim('model_name');
end
```



### Use the PreLoadFcn Pane

When you are satisfied with the data and mapping, you can configure your model to load to the MATLAB workspace a MAT-file of the same signal group. Call the `load` function in a `PreLoadFcn` callback in the model properties node.

- 1 After saving the MAT-file, in the Simulink editor, select **File > Model Properties > Model Properties**.
- 2 In the Model Properties window, select the `PreLoadFcn` node.
- 3 Enter a load function that loads the signal data MAT-file. For example,  

```
load d_signal_data.mat;
```
- 4 Click **OK** and save the model.

### Related Examples

- “Create and Use Custom Map Modes” on page 59-230
- “Create Signal Data for Root Inport Mapping” on page 59-181
- “Import Signal Data for Root Inport Mapping” on page 59-187
- “View and Inspect Signal Data” on page 59-191
- “Root Inport Mapping Scenarios” on page 59-233

### More About

- “Map Root Inport Signal Data” on page 59-178

## Preview Signal Data

Preview input signal or bus data with the **Signal Preview** window. You can access this window from:

- From File block
- `Simulink.SimulationData.DatasetRef` and `Simulink.SimulationData.Dataset` plot methods

1 Preview input signal or bus data with the **Signal Preview** window.

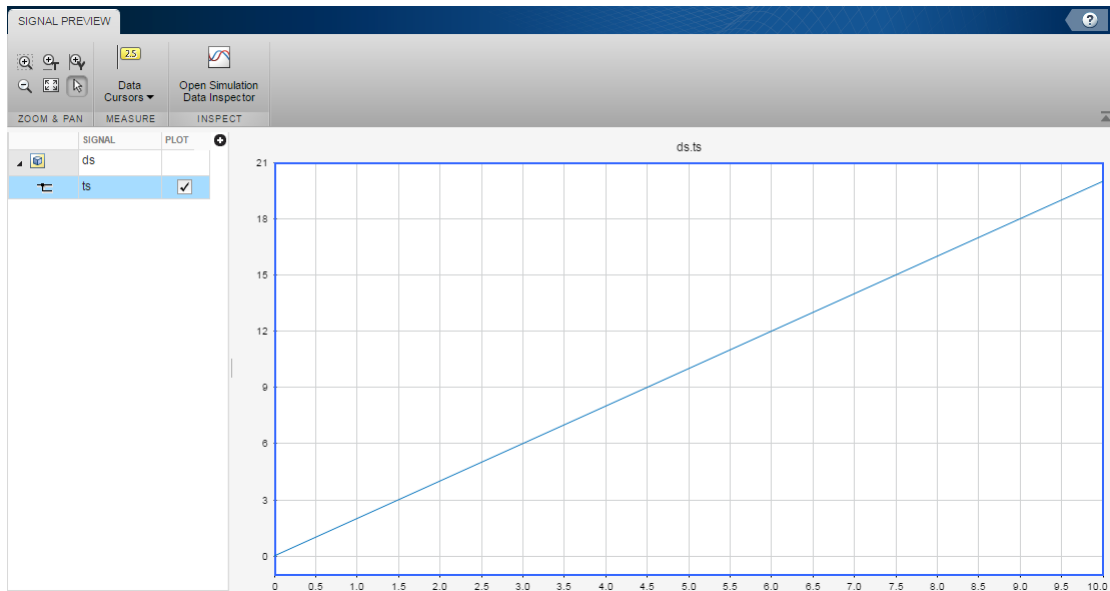

- For From File block, browse to a MAT-file that contains the data you want to preview, then plot the data by clicking .
- For `Simulink.SimulationData.Dataset` or `Simulink.SimulationData.DatasetRef` elements, use the `plot` method on the dataset.

If you view and inspect signal using the `Simulink.SimulationData.Dataset` or `Simulink.SimulationData.DatasetRef` plot method, the Signal Preview window contains an **Open Simulation Data Inspector** button. Click this button to plot the data using the Simulation Data Inspector.



- 2 Explore the plots using the **Measure** and **Zoom & Pan** sections on the toolbar.
  - In the **Measure** section, use the **Data Cursors** button to display one or two cursors for the plot. These cursors display the T and Y values of a data point in the plot. To view a data point, click a point on the plot line.
  - In the **Zoom & Pan** section, select how you want to zoom and pan the signal plots. Zooming is only for the selected axis.

Type of Zoom or Pan	Button to Click
Zoom in along the T and Y axes.	
Zoom in along the time axis. After selecting the icon, on the graph, drag the mouse to select an area to enlarge.	
Zoom in along the data value axis. After selecting the icon, on the graph, drag the mouse to select an area to enlarge.	

Type of Zoom or Pan	Button to Click
Zoom out from the graph.	
Fit the plot to the graph. After selecting the icon, click the graph to enlarge the plot to fill the graph.	
Pan the graph up, down, left, or right. Select the icon. On the graph, hold the left mouse button and move the mouse to the area of the graph that you want to view.	

**See Also**

Simulink.SimulationData.Dataset.plot | From File | Simulink.SimulationData.Dataset  
 | Simulink.SimulationData.DatasetRef

## Generate MATLAB Scripts for Simulation with Scenarios

After associating a scenario with the model, you can generate a MATLAB script to perform batch simulations. These scripts enable you to connect multiple sets of input signals to your Simulink model for interactive or batch simulation. You can run simulations multiple times and quickly generate data. This topic assumes that you have a scenario ready to run (see “Root Inport Mapping Scenarios” on page 59-233).

- 1 Associate your scenario with the model.
- 2 In the **SCRIPT** section, click **Generate MATLAB Script** and supply a script name when prompted.
- 3 To run the script, click **Run Script**.
- 4 To evaluate the results of the simulation, see the base workspace.

### More About

- “Root Inport Mapping Scenarios” on page 59-233

## Create and Use Custom Map Modes

You can create custom map modes to supplement the map modes that the Root Inport Mapper tool provides (see “Choose a Map Mode” on page 59-179).

For a summary of the other steps involved in using the Root Inport Mapper tool, see “Import and Mapping Workflow” on page 59-179.

### Create Custom Mapping File Function

If you do not want to use the map modes in the Root Inport Mapper tool, create a custom mapping file function. For example, consider creating a custom mapping file function if:

- Your signal data contains a common prefix that is not in your model.
- You want to map a signal explicitly.

When the data contains a signal name that does not match one of the block names, a custom mapping function is useful for block name mapping.

For examples, see these files in the folder *matlabroot/help/toolbox/simulink/examples* (open).

File	Description
BlockNameIgnorePrefixMap.m	Custom mapping file function that ignores the prefix of a signal name when importing signals
BlockNameIgnorePrefixData.mat	MAT-file of signal data to be imported
ex_BlockNameIgnorePrefixExample	Model file into which you can import and map data

In addition, see the example Using Mapping Modes with Custom-Mapped External Inputs.

To create a custom mapping file function:

- 1 Create a MATLAB function with these input parameters:
  - Model name

- Signal names specified as a cell array of character vectors
  - Signals specified as a cell array of signal data
- 2 In the function, call the `getRootImportMap` function to create a variable that contains the mapping object (for an example, see `BlockNameIgnorePrefixMap.m`).
  - 3 Save and close the MATLAB function file.
  - 4 Add the path for the new function to the MATLAB path.

To use the custom mapping file function:

- 1 Open the model that you want to import data to (for example, `ex_BlockNameIgnorePrefixExample`).
- 2 Open the Configuration Parameters dialog box for the model and select the **Data Import/Export** pane.
- 3 In the **Load from workspace** section, click **Connect Input**.
- 4 Import your signal (for example, `BlockNameIgnorePrefixData.mat`).
- 5 In the **MAP TO MODEL** section of the toolstrip, click **Custom**.
- 6 In the **Custom** text box, select the MATLAB function file (for example, `BlockNameIgnorePrefixMap.m`) using the browser.

By default, this text box contains `slexcustomMappingMyCustomMap`, which is the custom function for the Attaching Input Data to External Inputs via Custom Input Mappings example.

---

**Tip:** The Root Inport Mapper tool parses your custom code. Parsing reorders output alphabetically and verifies that data types are consistent.

---

- 7 Click **Options** and select the **Compile** check box.
- 8 Click **Map**.

The model is compiled and the Root Inport Mapper tool gets updated.

To understand the mapping results, see “Understand Mapping Results” on page 59-213.

- 9 Save and close the model.

After you save the mapping definition for a model, you can automate data loading. The next time that you load input data of the same signal group into the workspace,

the model uses the mapping definition during simulation. For more information, see “Alternative Workflows to Load Data” on page 59-223.

### **Custom Mapping Modes Similar to Simulink Modes**

If your custom mapping mode is similar to a Simulink mapping mode, use the `getSlRootInportMap` function in your custom mapping file function to perform the data mapping.

For an example of a custom mapping function that uses this function, see [Using Mapping Modes with Custom-Mapped External Inputs](#).

### **Command-Line Interface for Input Variables**

Use the `getInputString` function to supply a set of input variables to:

- The `sim` command
- A list of input variables that you can paste in the **Configuration Parameters > Data Import/Export > Input** parameter

### **Related Examples**

- “Map Signal Data to Root Inports” on page 59-210

### **More About**

- “Create Signal Data for Root Inport Mapping” on page 59-181



## Root Inport Mapping Scenarios

### In this section...

“Open Scenarios” on page 59-233

“Save Scenarios” on page 59-234

“Open Existing Scenarios” on page 59-234

“Work with Multiple Scenarios” on page 59-235

Use the Root Inport Mapper tool to create scenarios, save scenarios, and load previously saved scenarios. The Root Inport Mapper tool uses scenarios to save a snapshot of the current state of the imported and mapped signals in an MLDATX file. A scenario file contains information about the:

- Location of signal files (MAT-file or Microsoft Excel files)
- Location of the model
- Map mode
- Mapping options
- Mapped state

When sharing scenario files, include the scenario file and signal files (MAT-file or Microsoft Excel). Place the signal files in the last known location (where you used the Root Inport Mapper tool most recently) or the MATLAB path.

### Open Scenarios

To open an existing scenario, click **Open**. If you are working in another scenario, the Root Inport Mapper tool displays a message.

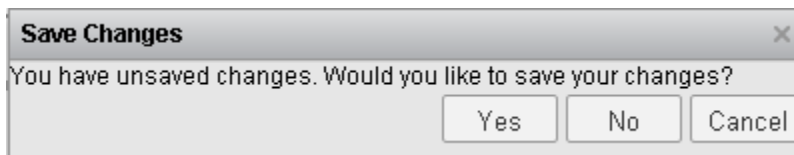

To...	Click...
Open a new scenario. Remove the existing scenario without saving it.	<b>No</b>

To...	Click...
Cancel opening a scenario.	<b>Cancel</b>
To save the existing scenario, click <b>Yes</b> . Then click the <b>Open</b> button again to open an existing scenario.	<b>Yes</b>

## Save Scenarios

When the **Save** icon turns blue or when the model name in the title bar is has an asterisk (\*), you can save a scenario.

- 1 On the Root Inport Mapper toolbar, select **Save > Save As**.
- 2 In the Save As dialog box, browse to a writable folder, specify a scenario file name, and then click **Save**.

- To save the signals and the scenario file, click **Yes**.

If a MAT-file is already associated with the scenario, the tool appends the base workspace variables to this file.

Save a scenario to an existing file (the file from which the scenario was last loaded):

- 1 On the Root Inport Mapper tool toolbar, click **Save**.
- 2 Browse to the `.mldatx` file in which to save the scenario, and then click **Save**.

If you have not saved the signals from the scenario, the tool prompts you to save the signals to a MAT-file.

Goal	Action
Overwrite the existing <code>.mldatx</code> file.	<b>Yes</b>
Exit the dialog box. The tool does not save the scenario.	<b>No</b>

## Open Existing Scenarios

You can open previously saved scenario files in one of the following ways:

- Double-click the previously saved scenario file (`*.mldatx`). The Root Inport Mapper tool opens and loads the model. Alternatively, right-click the file and select **Open**.

- When loading scenario files, the tool looks for the associated model and MAT-file or Microsoft Excel file in the last known location, and then looks on the MATLAB path. If the tool cannot find the model or signal files in these two locations, an error occurs.
- If the previously saved scenario has mapped signals, when you open the scenario, the tool applies the mapping. Also, the tool adds the signals to the base workspace so that you can simulate the model.
- Open the Root Inport Mapper tool for the model, click **Open**, and select the previously saved scenario file.

If the model is already open, the new scenario overwrites the existing scenario for the model. If there are unsaved changes in the open scenario, respond to the prompt.

Goal	Click
Save the existing scenario and associated data before loading the new scenario.	<b>Yes</b>
Open the new scenario without saving the existing scenario. This option also removes the data in the existing scenario.	<b>No</b>

## Work with Multiple Scenarios

You can open and work with multiple scenario files simultaneously. Working with multiple scenario files lets you view, edit, group, and nest multiple scenario files. Use multiple scenario files to test more complex systems with interrelated components.

As you open each multiple scenario, the Root Inport Mapper tool adds its data set to the SCENARIO DATASET section. If the scenario contains only signals, convert the signals to the `Simulink.SimulationData.Dataset` format:

- 1 To convert the signals to a `Simulink.SimulationData.Dataset` format, use the `convertToS1Dataset` function.
- 2 Link to the new data set. You do not need to reopen the scenario.

## Related Examples

- “Import Signal Data for Root Inport Mapping” on page 59-187

- “Map Signal Data to Root Inports” on page 59-210

### **More About**

- “Create Signal Data for Root Inport Mapping” on page 59-181
- “Map Root Inport Signal Data” on page 59-178

## Load Signal Data That Uses Units

Signal data logged in a previous simulation using signal logging or the To File or To Workspace block can include units information for `Dataset` or `Timeseries` logging formats.

Logging root-level Output data from a previous simulation contains units information if:

- These **Data Import/Export** configuration parameter settings:
  - **Output** is enabled.
  - **Format** is `Dataset`.
- For the Output blocks that you log, in the Block Parameters dialog box, you set the **Unit** parameter.

Otherwise, to include units in signal data that you load, for the `Units` property of the MATLAB `timeseries` objects that you want to load, specify a `Simulink.SimulationData.Unit` object.

### Loading Bus Signals That Have Units

When you input a bus signal to a root-level Inport or Output block, or you use a From File or From Workspace block, the output data type of the block must be a bus object. When you load the data from these blocks, the units in loaded data must match the units specified for the bus elements in the bus object. If the units for the loaded data do not match the units for a bus element in the bus object, Simulink uses the units specified in the bus object.

### See Also

#### Classes

`Simulink.SimulationData.Unit` | `Simulink.BusElement`

### Related Examples

- “Log Signal Data That Uses Units” on page 59-40

### More About

- “Units in Simulink”

- “Unit Consistency Checking and Propagation” on page 9-11

## Load Data Using the From File Block

### In this section...

“Data Loading” on page 59-239

“Sample Time” on page 59-240

“Simulation Time Hits Without Corresponding Time Data” on page 59-240

“Duplicate Timestamps” on page 59-240

“Detect Zero Crossings” on page 59-241

To load signal data with a From File block for use in a model:

- 1 Create a MAT-file with the signal data that you want to load.
- 2 Add a From File block to a model. Connect the From File block to the block that the From File provides input to.
- 3 In Block Parameters dialog box of the From File block, configure the block by specifying:
  - The path to the file that you want to load data from
  - The data format for the From File block output
  - How the data is loaded, including sample time, how to handle data for missing data points, and whether to use zero-crossing detection

### Data Loading

For a Version 7.0 and earlier MAT-file, the From File block loads the complete, uncompressed data from the file into memory at the start of simulation. For a Version 7.3 MAT-file, the From File block incrementally loads data from the file during simulation.

For each simulation time hit for which the MAT-file contains no matching timestamp, Simulink uses interpolation or extrapolation to obtain the needed data. You specify the interpolation and extrapolation methods. For details, see “Simulation Time Hits That Have No Corresponding MAT-File Timestamps.”

During simulation, the From File block cannot load data from a MAT-file that a To File block is exporting data to.

## Sample Time

The From File block **Sample time** parameter specifies the sample time to load data from a MAT-file. The timestamps in the file must be monotonically nondecreasing. For details, see the From File block documentation.

## Simulation Time Hits Without Corresponding Time Data

If a simulation time hit does not have a corresponding MAT-file timestamp, then the From File block output depends on:

- Whether the simulation time hit occurs before the first timestamp, within the range of timestamps, or after the last timestamp
- The interpolation or extrapolation methods that you select
- The data type of the MAT-file data

For details about interpolation and extrapolation options, see the descriptions of the following parameters in “Parameters and Dialog Box”:

- **Data extrapolation before first data point**
- **Data interpolation within time range**
- **Data extrapolation after last data point**

## Duplicate Timestamps

Sometimes the MAT-file includes duplicate timestamps (two or more data values that have the same timestamp). When that happens, the From File block action depends on when the simulation time hit occurs, relative to the duplicate timestamps in the MAT-file.

Suppose that the MAT-file contains the following data, with three data values having a timestamp value of 2:

```
time stamps:    0 1 2 2 2 3 4
data values:    2 3 6 4 9 1 5
```

The following table describes the From File block output.



Simulation Time, Relative to Duplicate timestamp Values in MAT-File	From File Block Action
Before the duplicate timestamps	Uses the first of the duplicate timestamp values as the basis for interpolation. (In this example, that timestamp value is 6.)
At or after the duplicate timestamps	Uses the last of the duplicate timestamp values as the basis for interpolation. (In this example, that timestamp value is 9.)

For more information, see the From File block documentation for these parameters:

- **Data extrapolation before first data point**
- **Data interpolation within time range**
- **Data extrapolation after last data point**

## Detect Zero Crossings

Zero-crossing detection locates a discontinuity in timestamps, without resorting to excessively small time steps. By default, the From File block does not enable zero-crossing detection.

For the From File block, zero-crossing detection occurs only at timestamps in the file. Simulink examines only the timestamps, not the data values.

For bus signals, Simulink detects zero-crossings across all leaf bus elements.

For more information, see the From File block documentation of the **Enable zero-crossing detection** parameter.

## See Also

### Blocks

From File | To File

## Related Examples

- “Create Data for a From File Block” on page 59-153
- “Comparison of Signal Loading Techniques” on page 59-124

## Load Data Using the From Workspace Block

### In this section...

“Specify the Workspace Data” on page 59-242

“Sample Time” on page 59-243

“Interpolate Missing Data Values” on page 59-243

“Specify Output After Final Data” on page 59-243

“Detect Zero Crossings” on page 59-244

To load signal data with a From Workspace block:

- 1 Create a workspace variable with the signal data that you want to load. See “Create Data for a From Workspace Block” on page 59-157.
- 2 Add a From Workspace block to a model. Connect the From Workspace block to the block that the From Workspace block provides input to.
- 3 In the Block Parameters dialog box of the From Workspace block, configure:
  - The workspace data to load
  - The data format for the From Workspace block output
  - How the data is loaded, including sample time, how to handle data for missing data points, and whether to use zero-crossing detection

An alternative to using a From Workspace block for loading workspace data is to load data to a root-level input port. For more information, see “Root-Level Input Ports” on page 59-117.

### Specify the Workspace Data

In the dialog box of the From Workspace block, in the **Data** parameter, specify the workspace data to load. Specify a MATLAB expression (for example, the name of a variable in the MATLAB workspace) that evaluates to one of the following:

- A MATLAB `timeseries` object
- A structure of MATLAB `timeseries` objects
- A structure, with or without time
- A two-dimensional matrix

For example, suppose that the workspace contains a column vector of times named **T** and a column vector of corresponding signal values named **U**. Entering the expression `[ T U ]` for **Data** parameter yields the required input array. If the required array or structure exists in the workspace, enter the name of the structure or matrix in the **Data** parameter.

If you load a structure that does not specify a time vector:

- 1 Set **Sample time (-1 for inherited)** to a value other than 0 (continuous).
- 2 Clear **Interpolate data**.
- 3 Set **Form output after final data value by** to a value other than **Extrapolation**.

If the model is linked to a data dictionary, you must set the value of the **Data** parameter based on the workspace or dictionary that contains the target data to load.

For more information, see “Create Data for a From Workspace Block” on page 59-157.

## Sample Time

The From Workspace block **Sample time** parameter specifies the sample time to load data from a workspace. The timestamps in the workspace data must be monotonically nondecreasing. For details, see “Specify Sample Time” on page 7-3.

## Interpolate Missing Data Values

To use linear Lagrangian interpolation to compute data values for time hits that occur between the time hits for which the workspace supplies the data, select **Interpolate data**.

For variable-size signals, clear **Interpolate data**.

## Specify Output After Final Data

To determine the block output after the last time hit for which workspace data is available, combine the settings of these parameters:

- **Interpolate data**
- **Form output after final data value by**

In the From Workspace block documentation, see the **Form output after final data value by** parameter.

## Detect Zero Crossings

By default, the From File block does not enable zero-crossing detection.

Zero-crossing detection locates discontinuities, without resorting to excessively small time steps.

The **Enable zero-crossing detection** parameter applies only if the sample time is continuous (0).

If you select the **Enable zero-crossing detection** parameter, and if an input array contains multiple entries for the same time hit, Simulink detects a zero crossing at that time hit.

For bus signals, Simulink detects zero crossings across all leaf bus elements.

## See Also

### Blocks

From Workspace | To Workspace

## Related Examples

- “Use From Workspace Block for Test Case” on page 59-146
- “Create Data for a From Workspace Block” on page 59-157
- “Comparison of Signal Loading Techniques” on page 59-124

## Create Dataset Data for Root Inport Ports

### In this section...

“Specify a Dataset Using the Input Parameter” on page 59-245

“Dataset Elements” on page 59-245

“Import Dataset Objects for Buses” on page 59-246

“Create Dataset Object for Inport Blocks” on page 59-246

### Specify a Dataset Using the Input Parameter

You can use a Dataset object as a value for the **Configuration Parameters > Data Import/Export > Input** parameter. Specify only one Dataset object and do not include it in a comma-separated list.

### Dataset Elements

A Dataset object can include elements with different data types. The elements can be:

For individual non-bus signal data, you can specify these types of data for dataset elements:

- `timeseries` or structure of `timeseries` objects
- `SimulationDatastore`
- `double` vectors or structure of `double` objects
- `timeseries`
- An object such as a `Simulink.SimulationData.Signal` or `Simulink.SimulationData.State` object

For bus signals, use a structure with a data for each leaf signal, using one of these formats:

- A MATLAB `timeseries` object
- A MATLAB `timetable` object
- A structure, if each leaf node is either empty or is a MATLAB `timeseries` object or `timetable` object
- An array that meets one of these requirements:

- An array with time in the first column and the remaining columns each corresponding to an input port. See “Create Data Arrays for Root-Level Inports” on page 59-250.
- An  $n \times 1$  array for a root inport that drives a function-call subsystem. See “Arrays for Input Ports Driving Function-Call Subsystems” on page 59-251.
- A `Simulink.SimulationData.Signal` object
- A `matlab.io.datastore.SimulationDatastore` object
- An empty matrix

An empty matrix

The number of elements in the data set must match the number of root-level input ports.

## Import Dataset Objects for Buses

You can use a `Dataset` object to import bus data for a root-level input port. For details, see “Import Bus Data to Top-Level Input Ports” on page 59-166.

## Create Dataset Object for Inport Blocks

To generate a `Simulink.SimulationData.Dataset` object from the root-level Inport blocks in a model, you can use the `createInputDataset` function. Signals in the generated dataset have the properties of the Inport blocks and the corresponding ground values at model start and stop times. You can create `timeseries` objects for the time and values for signals for which you want to load data for simulation. The other signals use ground values.

## See Also

### Classes

`Simulink.SimulationData.Dataset` | `timeseries`

## Related Examples

- “Load Data to Root-Level Input Ports” on page 59-164
- “Import Bus Data to Top-Level Input Ports” on page 59-166
- “Create MATLAB Timeseries Data for Root Inports” on page 59-248

- “Create Data Arrays for Root-Level Inports” on page 59-250
- “Create MATLAB Time Expressions for Root Inports” on page 59-254
- “Create Data Structures for Root Inports” on page 59-255

### **More About**

- “Create Data Arrays for Root-Level Inports” on page 59-250

## Create MATLAB Timeseries Data for Root Imports

### In this section...

“Specify Time Dimension” on page 59-248

“Models with Multiple Root Inport Blocks” on page 59-249

A root-level Inport, Enable, Trigger, and From Workspace block can import data specified by a MATLAB `timeseries` object residing in a workspace.

**Note:** This documentation about importing MATLAB timeseries data includes examples of root Inport blocks. Unless specifically noted otherwise, the examples are applicable to root-level Enable, Trigger, and From Workspace blocks.

### Specify Time Dimension

When you create a MATLAB `timeseries` object to import data to Simulink, the time dimension depends on the dimension and the type of signal data.

Signal Data Dimension or Type	Time Dimension Alignment	Example of timeseries Constructor
Scalar or a 1D vector	First	Constructor for a scalar signal. Time is aligned with the first dimension.  <pre>t = (0:10)'; ts = timeseries(sin(t), t);</pre>
2D (including row and column vectors) or greater	Last	Constructor for a matrix signal. Time is aligned with the last dimension.  <pre>t = 0; ts = timeseries([1 2; 3 4], t);</pre>
2D row vector, and there is only one time step	Last	'InterpretSingleRowDataAs3D', true For example:  <pre>t = 0; ts = timeseries([1 2], t, 'Interpret</pre>



## Models with Multiple Root Inport Blocks

To use a MATLAB `timeseries` object for a root Inport block in a model that has multiple root Inport blocks, convert all the other root Inport block data that uses `Simulink.TsArray` or `Simulink.Timeseries` objects to one of these formats:

- MATLAB `timeseries` objects
- A structure of MATLAB `timeseries` objects

You can use the `Simulink.Timeseries.convertToMATLABTimeseries` method to convert a `Simulink.Timeseries` object to a MATLAB `timeseries` object. For example, if `sim_ts` is a `Simulink.Timeseries` object, then the following line converts `sim_ts` to a MATLAB `timeseries` object:

```
ts = sim_ts.convertToMATLABTimeseries;
```

## See Also

### Classes

`Simulink.SimulationData.Dataset` | `timeseries`

## Related Examples

- “Load Data to Root-Level Input Ports” on page 59-164
- “Import Bus Data to Top-Level Input Ports” on page 59-166
- “Create MATLAB Timeseries Data for Root Inports” on page 59-248
- “Create Data Arrays for Root-Level Inports” on page 59-250
- “Create MATLAB Time Expressions for Root Inports” on page 59-254
- “Create Data Structures for Root Inports” on page 59-255

## More About

- “Create Data Arrays for Root-Level Inports” on page 59-250

## Create Data Arrays for Root-Level Inports

### In this section...

“Data Array Format” on page 59-250

“Specify the Input Expression” on page 59-250

“Arrays for Input Ports Driving Function-Call Subsystems” on page 59-251

### Data Array Format

This import format consists of a real (noncomplex) matrix of data type `double`. The first column of the matrix must be a vector of times in ascending order. The remaining columns specify input values.

- Each column represents the input for a different Inport or Trigger block signal (in sequential order).
- Each row is the input value for the corresponding time point.

For a Trigger block, the signal driving the trigger port must be the last data item.

The total number of columns of the input matrix must equal  $n + 1$ , where  $n$  is the total number of signals entering the model input ports.

### Specify the Input Expression

The default input expression for a model is `[t,u]` and the default input format is `Array`. So if you define `t` and `u` in the MATLAB workspace, simply select the **Configuration Parameters > Data Import/Export > Input** parameter to input data from the model workspace.

For example, suppose that you have a model with two Inport blocks:

- The In1 block accepts two signals (the block has the **Port dimensions** parameter set to 2).
- The In2 block accepts one signal (the block uses the default value for the **Port dimensions** parameter).

You define `t` and `u` in the MATLAB workspace:

```

numSteps = 9;
timeStep = 0.1;
t = (timeStep*(0:numSteps))';
u = [sin(t),cos(t),4*cos(t)];

```

When the simulation runs, the signal data  $\sin(t)$  and  $\cos(t)$  are assigned to In1 and the signal data  $4\cos(t)$  is assigned to In2. Signal data is input for 100 time points.

---

**Note** The array input format allows you to load only real (noncomplex) scalar or vector data of type `double`. Use the structure format to input complex data, matrix (2-D) data, and data types other than `double`.

---

## Arrays for Input Ports Driving Function-Call Subsystems

You can use an array to drive a Function-Call Subsystem through a root-level input port. You can use an array or an array that is an element of a `Dataset` object. The array must be an  $n \times 1$  array. For the root-level Inport block, select the **Output function call** parameter.

For example, this `Dataset` object has an array element `x`:

```

ds = Simulink.SimulationData.Dataset;
x = [1 3 7 8]';
ds = ds.addElement(x, 'theElementName');

```

This model uses the `ds` data set in the **Configuration Parameters > Data Import/Export > Input** parameter.

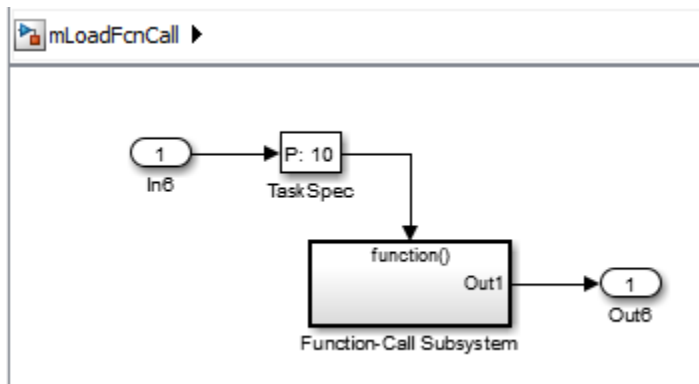

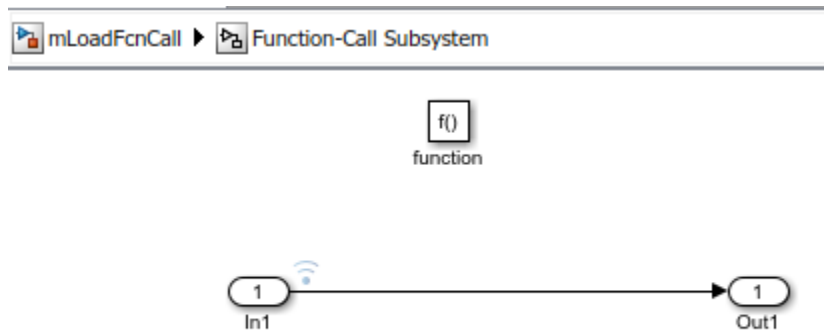

When you simulate the model, the time values of the logged signal data in the Function-Call Subsystem shows that the Function-Call Subsystem was triggered only for the times specified in array stored in `ds`.

```
>> logargout.get(1).Values.Time
```

```
ans =
```

```
1
3
7
8
```

## See Also

### Classes

[Simulink.SimulationData.Dataset](#) | [Simulink.SimulationData.Dataset.addElement](#) | [timeseries](#)

## Related Examples

- “Specify Data for Root-Level Input Ports” on page 59-149
- “Load Data to Root-Level Input Ports” on page 59-164
- “Import Bus Data to Top-Level Input Ports” on page 59-166
- “Create MATLAB Timeseries Data for Root Inports” on page 59-248
- “Create Dataset Data for Root Inport Ports” on page 59-245

- “Create MATLAB Time Expressions for Root Imports” on page 59-254
- “Create Data Structures for Root Imports” on page 59-255

### **More About**

- “Create Data Arrays for Root-Level Imports” on page 59-250

## Create MATLAB Time Expressions for Root Inports

### Specify the Input Expression

You can use a MATLAB time expression to import data from a workspace. To use a time expression, enter the expression as a string (enclosed in single quotes) in the **Input** field of the **Data Import/Export** pane. The time expression can be any MATLAB expression that evaluates to a row vector equal in length to the number of signals entering the input ports of the model. For example, suppose that a model has one vector Inport that accepts two signals. Furthermore, suppose that `timefcn` is a user-defined function that returns a row vector two elements long. The following are valid input time expressions for such a model:

```
'[3*sin(t), cos(2*t)]'
```

```
'4*timefcn(w*t)+7'
```

The expression is evaluated at each step of the simulation, applying the resulting values to the input ports of the model. Simulink defines the variable `t` when it runs the simulation. Also, you can omit the time variable in expressions for functions of one variable. For example, the expression `sin` is interpreted as `sin(t)`.

### See Also

#### Classes

[Simulink.SimulationData.Dataset](#) | [timeseries](#)

### Related Examples

- “Load Data to Root-Level Input Ports” on page 59-164
- “Import Bus Data to Top-Level Input Ports” on page 59-166
- “Create MATLAB Timeseries Data for Root Inports” on page 59-248
- “Create Dataset Data for Root Inport Ports” on page 59-245
- “Create Data Structures for Root Inports” on page 59-255

### More About

- “Create Data Arrays for Root-Level Inports” on page 59-250

## Create Data Structures for Root Imports

### In this section...

“Data Structures” on page 59-255

“Structures for All Ports or for Each Port” on page 59-256

“Specify Signal Data” on page 59-256

“Specify Time Data” on page 59-257

“Examples of Specifying Signal and Time Data” on page 59-258

### Data Structures

The Simulink software can load data from the workspace in the form of a structure, whose name you specify in the **Configuration Parameters > Data Import/Export > Input** parameter.

For information about defining MATLAB structures, see “Create Structure Array” (MATLAB).

The structure always includes a signals substructure, which contains a values field and a dimensions field. For details about the signal data, see “Specify Signal Data” on page 59-256. Depending on the modeling task that you want to perform, the structure can also include a time field.

You can specify structures for the model as a whole or on a per-port basis. For information about specifying per-port structures for the **Input** parameter, see “Structures for All Ports or for Each Port” on page 59-256.

The form of a structure that you use depends on whether you are importing data for:

- Discrete signals (the signal is defined at evenly spaced values of time) — Use a structure that has an empty time vector.
- Continuous signals (the signal is defined for all values of time) — The approach that you use depends on whether the data represents a smooth curve or a curve that has discontinuities (jumps) over its range.

For details, see:

- “Import Data to Test a Discrete Algorithm” on page 59-143
- “Import Data to Model a Continuous Plant” on page 59-140
- “Import Data for an Input Test Case” on page 59-145

For both discrete and continuous signals, specify a `signals` field, which contains an array of substructures, each of which corresponds to a model input port. For details, see “Specify Signal Data” on page 59-256.

For continuous signals, you can specify a `time` field, which contains a time vector. See “Specify Time Data” on page 59-257.

## Structures for All Ports or for Each Port

You can specify one structure to provide input to all root-level input ports in a model, or you can specify a separate structure for each port.

The per-port structure format consists of a separate structure-with-time or structure-without-time for each port. The input data structure for each has only one `signals` field. To specify this option, enter the names of the structures in the **Input** text field as a comma-separated list, `in1, in2, . . . , inN`. The value `in1` is the data for first input port in the model, `in2` for the second input port, and so on.

The rest of the section about importing structure data focuses on specifying one structure for all ports.

## Specify Signal Data

Each `signals` substructure must contain two fields: `values` and `dimensions`.

### The Values Field

The `values` field must contain an array of inputs for the corresponding input port. If you specify a time vector, each input must correspond to a time value specified in the `time` field.

If the inputs for a port are scalar or vector values, the `values` field must be an M-by-N array. If you specify a time vector, M must be the number of time points specified by the `time` field and N is the length of each vector value.



If the inputs for a port are matrices (2-D arrays), the **values** field must be an **M-by-N-by-T** array. **M** and **N** are the dimensions of each matrix input and **T** is the number of time points. For example, suppose that you want to input 51 time samples of a 4-by-5 matrix signal into one of the input ports in your model. Then, the corresponding **dimensions** field of the workspace structure must equal **[4 5]** and the **values** array must have the dimensions **4-by-5-by-51**.

### The Dimensions Field

The **dimensions** field specifies the dimensions of the input. If each input is a scalar or vector (1-D array) value, the **dimensions** field must be a scalar value specifying the length of the vector (1 for a scalar). If each input is a matrix (2-D array), the **dimensions** field must be a two-element vector whose:

- First element specifies the number of rows in the matrix
- Second element specifies the number of columns

---

**Note** Set the **Port dimensions** parameter of the Inport or the Trigger block to be the same value as the **dimensions** field of the corresponding input structure. If the values differ, an error message is displayed when you try to simulate the model.

---

### Specify Time Data

You can specify a time vector of doubles as part of the data structure to import. For example, specify a time vector when importing signal data to represent a continuous plant or to create a test case. To test a discrete algorithm, use a structure with an empty time vector. This table provides additional recommendations for specifying time values, based on the kind of signal data you want to load.

Signal Data	Time Data Recommendation
Inport or Trigger block with a discrete sample time	Do not specify a time vector. Simulink loads one signal value at each time step.
Evenly spaced discrete signals	Use an expression in this form:  <code>timeVector = timeStep * [startTime:numSteps-1]'</code>  The vector is transposed. Also, because the start time is a time step, you need specify the number of steps you

Signal Data	Time Data Recommendation
	<p>want minus 1. For example, to specify 50 time values at 0.2 time steps:</p> <pre>T1 = 0.2 * [0:49]'</pre> <hr/> <p><b>Note:</b> Do <i>not</i> use an expression in this form:</p> <pre>timeVector = [startTime:timeStep:endTime]'</pre> <p>For example, do not use:</p> <pre>T2 = [0:0.2:10]'</pre> <p>This time vector form is not equivalent to the form that multiplies by time steps (T1), because of double-precision rounding used by computers. Simulink expects exact values, with no double-precision rounding. Using the T2 form can lead to mismatches between the provided time vector and the time steps taken by Simulink, resulting in unexpected simulation results.</p>
Unevenly spaced values	<p>Use any valid MATLAB array expression; for example, [1:5 5:10] or (1 6 10 15).</p> <p>The From Workspace, From File, and Signal Builder blocks support zero-crossing detection. If the root-level input port is connected to one of those blocks, you can specify a zero-crossing time by using a duplicate time entry.</p>

## Examples of Specifying Signal and Time Data

In the first example, consider the following model that has a single input port:

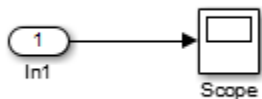

- 1 Create an input structure for loading 11 time samples of a two-element signal vector of type `int8` into the model:

```
N = 10
Ts = 0.1
a.time = Ts*[0:N]';
c1 = int8([0:1:10]');
c2 = int8([0:10:100]');
a.signals(1).values = [c1 c2];
a.signals(1).dimensions = 2;
```

- 2 In the **Configuration Parameters** > **Data Import/Export** > **Input** parameter edit box, specify the variable `a`.
- 3 In the Inport block dialog box, in the **Signal Attributes** tab, set **Port dimensions** to 2 and **Data type** to `int8`.

As another example, consider a model that has two inputs:

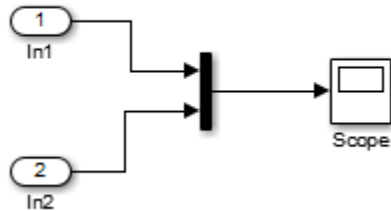

Suppose that you want to input a sine wave into the first port and a cosine wave into the second port. Define a structure, `a`, as follows, in the MATLAB workspace:

```
a.time = 0.1*[0:1]';
a.signals(1).values = sin(a.time);
a.signals(1).dimensions = 1;
a.signals(2).values = cos(a.time);
a.signals(2).dimensions = 1;
```

Enter the structure name (`a`) in the **Configuration Parameters** > **Data Import/Export** > **Input** parameter edit box.

---

**Note:** In this model you do not need to specify the dimension and data type, because the default values are 1 and `double`.

---

## See Also

### Classes

Simulink.SimulationData.Dataset | timeseries

## Related Examples

- “Import Bus Data to Top-Level Input Ports” on page 59-166
- “Create MATLAB Timeseries Data for Root Inports” on page 59-248
- “Create Dataset Data for Root Inport Ports” on page 59-245
- “Create MATLAB Time Expressions for Root Inports” on page 59-254
- “Create Data Arrays for Root-Level Inports” on page 59-250

## More About

- “Create Data Arrays for Root-Level Inports” on page 59-250

## State Information

### In this section...

“Simulation State Information” on page 59-261

“Types of State Information” on page 59-261

“Format for State Information Saved Without SimState” on page 59-264

“State Information for Referenced Models” on page 59-265

### Simulation State Information

Some blocks maintain state information that they use during simulation. For example, the state information for a Unit Delay block is the output signal value from the previous simulation step. The block uses the state information for calculating the output signal value for the current simulation step.

Some examples of uses of saved state information include:

- Stopping a simulation for a model and using the saved state information as input when you restart the simulation.
- Simulating one model and using the saved state information as input for the simulation of another model that builds on the results of the first model.
- Examining changes in state information throughout a simulation.

### Types of State Information

You can save these kinds of state information.

Type of State Information	Description	Configuration Parameters in Data Import/Export Pane
States for each simulation step	State information of blocks (referred to as partial state data) at each time step of a simulation	<b>States</b>
Final state	State information of blocks at the end of the simulation	<b>Final states</b>

Type of State Information	Description	Configuration Parameters in Data Import/Export Pane
Final state with SimState	Final state with a SimState object that captures additional internal information that Simulink uses during simulation	<b>Final States and Save complete SimState in final state</b>

SimState provides more complete final simulation state information than final states information by itself does. However, if the requirements and limitations of using SimState do not meet your modeling requirements, save final state information without SimState.

### Comparison of SimState and Final State Logging

Characteristic	Final State	Final State with SimState
Simulation mode	Supports all simulation modes	Normal or Accelerator.
Model reference	“State Information for Referenced Models” on page 59-265	See “Model Referencing” on page 23-43.
Resumed simulation	Not supported	Supported.
Saved state data	Only logged states — the continuous and discrete states of blocks — which are a subset of the complete simulation state of the model  User data, run-time parameters, or logs of the model not saved	Complete state information  Does not save user data, run-time parameters, or logs of the model.
Block output	User data, run-time parameters, or logs of the model not saved	Simulink tries to save the output of a block as part of a SimState even if S-functions declare that no SimState states exist in the block. If the block output is of custom type, Simulink displays an error.

Characteristic	Final State	Final State with SimState
Readability	Use structure with time format for best readability	To examine a simplified view of the data, consider using looking at the <code>loggedStates</code> property of the <code>Simulink.SimState.ModelSimState</code> class.
Restoring state data	Can save and restore in different simulation modes. If logged state information is not sufficient, you can obtain different results in the two simulation modes.	Cannot save in normal mode and restore in Accelerator, or conversely save in accelerator mode and restore in normal mode.
Restoring multiple states	You can initialize only one out of multiple logged states in the model.	You restore all states in the model. You cannot load a subset of states.
Structural changes	You can make structural changes between simulation and restoring the simulation.	You cannot make structural changes to the model between when you save the <code>SimState</code> and when you restore the simulation using the <code>SimState</code> . For example, you cannot add or remove a block after saving the <code>SimState</code> without repeating the simulation and saving the new <code>SimState</code> .
Input to model function	To input to model function, use <code>Array</code> format with non-complex data of type <code>double</code> .	You cannot input the <code>SimState</code> to model function.
Code generation	Supported	Not supported

For both `SimState` and final state logging, Simulink saves state information at one of these points:

- At the final time step

- At the execution time at which the simulation paused or stopped

For additional information about `SimState`, see “Limitations of `SimState`” on page 23-42.

## Format for State Information Saved Without `SimState`

If you do not use the `SimState` for saving state information, then use **Configuration Parameters > Data Import/Export > Format** to specify the data format for the saved state information.

You can set **Format** to:

- `Dataset` (default)
- `Array`
- `Structure`
- `Structure with time`

The `Array` option for the **Configuration Parameters > Data Import/Export > Format** option supports compatibility with models developed in earlier releases, when Simulink supported only the array format for saving state information.

The array format reflects the order of signals. The order of saved state information can change between simulations when you change any of the following:

- The model (even without changing the signal)
- The simulation mode
- The code generation mode

The `Structure` and `Structure with time` formats are easier to read and consistent across simulations. Also, these two formats are useful when using state information to initialize a model for simulation, allowing you to:

- Associate initial state values directly with the full path name to the states. This association eliminates errors that can occur if Simulink reorders the states, but the order of the initial state array does not change correspondingly.
- Assign a different data type to the initial value of each state.
- Initialize only a subset of the states.
- `Dataset` format:



- Uses MATLAB `timeseries` objects to store logged data. MATLAB `timeseries` objects allow you to work with logged data in MATLAB without a Simulink license.
- Supports logging multiple data values for a given time step, which can be important for Iterator subsystem and Stateflow signal logging
- Does not support logging nonvirtual bus data for code generation or rapid accelerator mode.

## State Information for Referenced Models

When Simulink saves states in the structure or structure-with-time format, it adds an `inReferencedModel` subfield to the `signals` field of the structure. The value of this additional subfield is true (1) if the `signals` field records the final state of a block that resides in the reference model. For example:

```
xout.signals(1)
ans =

        values: [101x1 double]
  dimensions: 1
         label: 'DSTATE'
    blockName: [1x66 char]
inReferencedModel: 1
```

If the `signals` field records a referenced model state, its `blockName` subfield contains a compound path of a top model path and a reference model path. The top model path is the path from the model root to the Model block that references the reference model. The reference model path is the path from the reference model root to the block whose state the `signals` field records. The compound path uses a `|` character to separate the top and reference model paths. For example:

```
>> xout.signals(1).blockName
ans =

sldemo_mdref_basic/CounterA|sldemo_mdref_counter/Previous Output
```

## See Also

### Classes

`Simulink.SimulationData.Dataset` | `Simulink.SimulationData.Signal`

## **Related Examples**

- “Save State Information” on page 59-267
- “Load State Information” on page 59-271

## Save State Information

### In this section...

“Save State Information for Each Simulation Step” on page 59-267

“Save Partial Final State Information” on page 59-267

“Examine State Information Saved Without the SimState” on page 59-268

“Save Final State Information with SimState” on page 59-270

### Save State Information for Each Simulation Step

You can save state information for logged states for each simulation step during a simulation. That level of state information can be helpful for debugging.

- 1 Select the **Configuration Parameters > Data Import/Export > States** check box.
- 2 In the **States** edit box, you can specify a different variable for the state information, if you do not want to use the default `xout` variable.
- 3 Also in the **Data Import/Export** pane, set the **Format** parameter to **Dataset**, **Structure**, or **Structure with time**, unless you use array format for compatibility with a legacy model.

`Dataset` format does not support:

- Logging states information inside a function-call subsystem
- Rapid accelerator simulation mode
- Code generation

- 4 Click **Apply**.
- 5 Simulate the model.

### Save Partial Final State Information

To save just the logged states (the continuous and discrete states of blocks):

- 1 Select the **Configuration Parameters > Data Import/Export > Final states** check box.

- 2 In the **Final states** edit box, you can specify a different variable for the state information, if you do not want to use the default `xFinal` variable.
- 3 Clear the **Save complete SimState in final state** parameter.
- 4 Set the **Format** parameter to `Dataset`, `Structure`, or `Structure with time`.
- 5 Click **Apply**.
- 6 Simulate the model.

## Examine State Information Saved Without the SimState

If you enable the **Configuration Parameters > Data Import/Export > Final states** or **States** parameters, Simulink saves the state information in the format that you specify with the **Format** parameter. The default variable for **Final state** information is `xFinal`, and the variable for state information for **States** information is `xout`.

If a model has no states saved, then `xFinal` and `xout` are empty variables. To determine whether a model has states saved, use the `isempty(xout)` command.

### Final State Information in Dataset Format

For example, suppose that you saved final state information in `Dataset` format, and use the default `xFinal` variable for the saved state information.

```
xFinal
```

```
xFinal =
```

```
Simulink.SimulationData.Dataset 'xFinal' with 2 elements
```

		Name	BlockPath
1	[1x1 State]	CSTATE	vdp/x1
2	[1x1 State]	DSTATE	vdp/x2

```
- Use braces { } to access, modify, or add elements using index.
```

Examine the first element of the state data set.

```
xFinal{1}
```

```
ans =
```

```

Simulink.SimulationData.State
Package: Simulink.SimulationData

Properties:
    Name: 'CSTATE'
    BlockPath: [1x1 Simulink.SimulationData.BlockPath]
    Label: CSTATE
    Values: [1x1 timeseries]

```

### Final State Information in Structure with Time Format

For example, suppose that you saved final state information in a structure with time format, and use the default `xFinal` variable for the saved state information.

To find the simulation time and number of states in the `vdp` model, enter the `xFinal` variable.

```

xFinal
xFinal =
    time: 20
    signals: [1x2 struct]

```

In this case, the simulation time is 20 and there are two states. To examine the first state, use this command.

```

xFinal.signals(1)
ans =
    values: 2.0108
    dimensions: 1
    label: 'CSTATE'
    blockName: 'vdp/x1'
    stateName: ''
    inReferencedModel: 0

```

The `values` and `blockName` fields of the first state structure show that the final value for the output signal of the `x1` block is 2.018.

---

**Note:** If you write a script to analyze state information, use a combination of `label` and `blockName` values to identify a specific state uniquely. Do not rely on the order of the states.

---

## Save Final State Information with SimState

To save complete state information, save the `SimState` for a simulation.

- 1 Select the **Configuration Parameters > Data Import/Export > Final states** check box.
- 2 Also in the Data Import/Export pane, select the **Save complete SimState in final state** parameter.
- 3 In the edit box next to the **Save complete SimState in final state** parameter, enter a variable name for the `SimState` and click **Apply**.
- 4 Simulate the model.

For more information about using the `SimState`, see “Save and Restore Simulation State as `SimState`” on page 23-37.

## Related Examples

- “Load State Information” on page 59-271

## More About

- “State Information” on page 59-261

## Load State Information

### In this section...

“Import Initial States” on page 59-271

“Initialize a State” on page 59-271

“Initialize States in Referenced Models” on page 59-273

### Import Initial States

To initialize a simulation, you can use:

- Final state information (with or without `SimState`) from a previous simulation
- State information that you create in MATLAB

Use **Configuration Parameters > Data Import/Export** parameters to import initial states.

- 1 Enable the **Initial state** parameter.
- 2 In the **Initial state** edit box, enter the name of the variable for the state information that you want to use for initialization.

The initial values that the variable specifies override the initial state values that the blocks in the model specify in initial condition parameters.

You can specify structure, structure with time data or `Dataset` format data.

### Initialize a State

You can initialize a specific state. This example creates an initial state structure for the `x2` state of the `vdp` model. The `x1` state is not initialized in the structure. Therefore, during simulation, Simulink uses the value in the Integrator block associated with the `x1` state.

- 1 Open the model.  

```
open_system('vdp');
```
- 2 Set the `SaveFormat` model argument to `'Structure'`.  

```
set_param('vdp', 'SaveFormat', 'Structure');
```

- 3 Obtain an initial state structure.

```
states = Simulink.BlockDiagram.getInitialState('vdp');
```

- 4 Set the initial value of the signals structure element associated with x2 to 2.

```
states.signals(2).values = 2;
```

- 5 Remove the signals structure element associated with x1.

```
states.signals(1) = [];
```

- 6 Use the `states` variable for the `vdp` model. Select the initial state configuration parameter.

```
set_param('vdp', 'LoadInitialState', 'on', 'InitialState', 'states');
```

- 7 Simulate the model and examine the initial values of x2 and x1.

```
sim('vdp');  
states
```

```
states =
```

```
struct with fields:  
  
    time: 0  
    signals: [1×1 struct]
```

```
states.signals
```

```
ans =
```

```
struct with fields:  
  
    values: 2  
    dimensions: 1  
    label: 'CSTATE'  
    blockName: 'vdp/x2'  
    stateName: ''  
    inReferencedModel: 0  
    sampleTime: [0 0]
```

When you simulate the model, both states have the initial value of 2. The initial value of the x2 state is assigned in the `states` structure, while the initial value of the x1 state is assigned in its Integrator block.



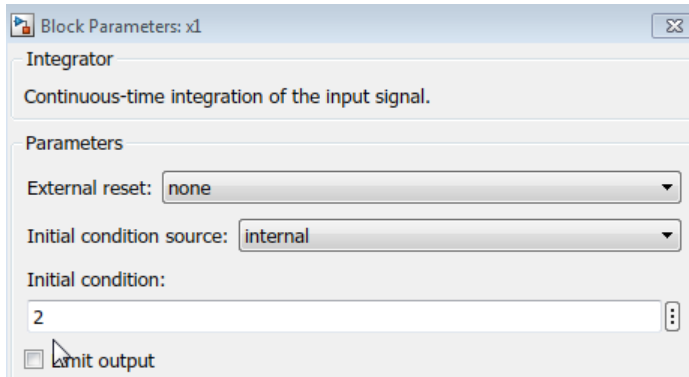
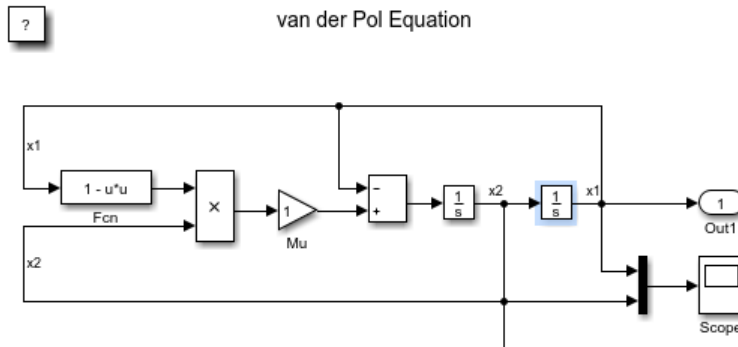

## Initialize States in Referenced Models

To initialize the states of a top model and the models that it references, use the structure or structure with time format or use `SimState`.

If the top model is in rapid accelerator mode, you cannot load discrete state data.

## Related Examples

- “Save State Information” on page 59-267

## More About

- “State Information” on page 59-261



# Working with Data Stores

---

- “Data Store Basics” on page 60-2
- “Model Global Data by Creating Data Stores” on page 60-13
- “Log Data Stores” on page 60-39

## Data Store Basics

A *data store* is a repository to which you can write data, and from which you can read data, without having to connect an input or output signal directly to the data store. Data stores are accessible across model levels, so subsystems and referenced models can use data stores to share data without using I/O ports.

In this section...
“When to Use a Data Store” on page 60-2
“Local and Global Data Stores” on page 60-3
“Data Store Diagnostics” on page 60-3
“Specify Initial Value for Data Store” on page 60-11

### When to Use a Data Store

Data stores can be useful when multiple signals at different levels of a model need the same global values, and connecting all the signals explicitly would clutter the model unacceptably or take too long to be feasible. Data stores are analogous to global variables in programs, and have similar advantages and disadvantages, such as making verification more difficult.

In some cases, you may be able to use a simpler technique, Goto blocks and From blocks, to obtain results similar to those provided by data stores. The principal disadvantage of data Goto/From links is that they generally are not accessible across nonvirtual subsystem boundaries, while an appropriately configured data store can be accessed anywhere. See the Goto and From block reference pages for more information about Goto/From links.

### Data Stores and Software Verification

Data stores can have significant effects on software verification, especially in the area of data coupling and control. Models and subsystems that use only inports and outports to pass data result in clean, well-specified, and easily verifiable interfaces in the generated code.

Data stores, like any type of global data, make verification more difficult. If your development process includes software verification, consider planning for the effect of data stores early in the design process.

For more information, see RTCA DO-331, “Model-Based Development and Verification Supplement to DO-178C and DO-278A,” Section MB.6.3.3.b.

## Local and Global Data Stores

You can define two types of data stores:

- A *local data store* is accessible from anywhere in the model hierarchy that is at or below the level at which you define the data store, except from referenced models. You can define a local data store graphically in a model or by creating a model workspace signal object (`Simulink.Signal`).
- A *global data store* is accessible from throughout the model hierarchy, including from referenced models. Define a global data stores only in the MATLAB base workspace, using a signal object. The only type of data store that a referenced model can access is a global data store.

In general, locate a data store at the lowest level in the model that allows access to the data store by all the parts of the model that need that access. Some examples of local and global data stores appear in “Data Store Examples” on page 60-13.

For information about using referenced models, see “Model Referencing”.

## Data Store Diagnostics

- “About Data Store Diagnostics” on page 60-3
- “Detecting Access Order Errors” on page 60-4
- “Detecting Multitasking Access Errors” on page 60-6
- “Detecting Duplicate Name Errors” on page 60-8
- “Data Store Diagnostics in the Model Advisor” on page 60-11

### About Data Store Diagnostics

Simulink provides various run-time and compile-time diagnostics that you can use to help avoid problems with data stores. Diagnostics are available in the Model Configuration Parameters dialog box and the Data Store Memory block's parameters dialog box. The Simulink Model Advisor provides support by listing cases where data store errors are more likely because diagnostics are disabled.

### Detecting Access Order Errors

- “Data Store Diagnostics and Models Referenced in Accelerator Mode” on page 60-5
- “Data Store Diagnostics and the MATLAB Function Block” on page 60-6

You can use data store run-time diagnostics to detect unintended sequences of data store reads and writes that occur during simulation. You can apply these diagnostics to all data stores, or allow each Data Store Memory block to set its own value. The diagnostics are:

- **Detect read before write:** Detect when a data store is read from before written.
- **Detect write after read:** Detect when a data store is written.
- **Detect write after write:** Detect when a data store is written.

These diagnostics appear in the **Model Configuration Parameters > Diagnostics > Data Validity > Data Store Memory block** pane, where each can have one of the following values:

- **Disable all** — Disables this diagnostic for all data stores accessed by the model.
- **Enable all as warnings** — Displays the diagnostic as a warning in the MATLAB Command Window.
- **Enable all as errors** — Halts the simulation and displays the diagnostic in an error dialog box.
- **Use local settings** — Allow each Data Store Memory block to set its own value for this diagnostic (default).

The same diagnostics also appear in each Data Store Memory block parameters dialog box **Diagnostics** tab. You can set each diagnostic to **none**, **warning**, or **error**. The value specified by an individual block takes effect only if the corresponding configuration parameter is **Use local settings**. See “Model Configuration Parameters: Data Validity Diagnostics” and the Data Store Memory documentation for more information.

The most conservative technique is to set all data store diagnostics to **Enable all as errors** in **Model Configuration Parameters > Diagnostics > Data Validity > Data Store Memory block**. However, this setting is not best in all cases, because it can flag intended behavior as erroneous. For example, the next figure shows a model that uses block priorities to force the Data Store Read block to execute before the Data Store Write block:

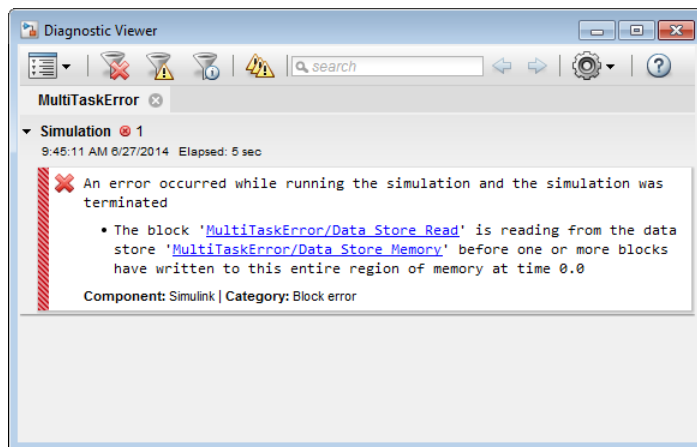
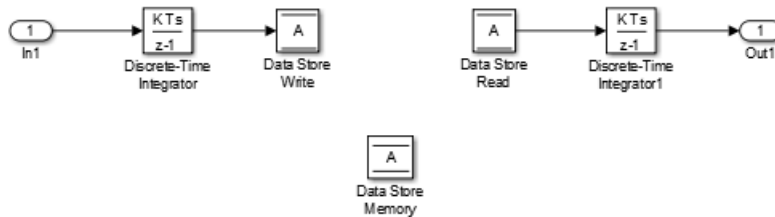

An error occurred during simulation because the data store A is read from the Data Store Read block before the Data Store Write block updates the store. If the associated delay is intended, you can suppress the error by setting the global parameter **Detect read before write** to **Use local settings**, then setting that parameter to **none** in the **Diagnostics** pane of the Data Store Memory block dialog box. If you use this technique, set the parameter to **error** in all other Data Store Memory blocks aside from those that are to be intentionally excluded from the diagnostic.

#### Data Store Diagnostics and Models Referenced in Accelerator Mode

For models referenced in Accelerator mode, Simulink ignores the following **Configuration Parameters > Diagnostics > Data Validity > Data Store Memory block** parameters if you set them to a value other than **Disable all**.

- **Detect read before write** (ReadBeforeWriteMsg)

- **Detect write after read** (WriteAfterReadMsg)
- **Detect write after write** (WriteAfterWriteMsg)

You can use the Model Advisor to identify models referenced in Accelerator mode for which Simulink ignores the configuration parameters listed above.

- 1 In the Simulink Editor, select **Analysis > Model Advisor**.
- 2 Select **By Task**.
- 3 Run the **Check diagnostic settings ignored during accelerated model reference simulation** check.

### Data Store Diagnostics and the MATLAB Function Block

Diagnostics might be more conservative for data store memory used by MATLAB Function blocks. For example, if you pass arrays of data store memory to MATLAB functions, optimizations such as `A=foo(A)` might result in MATLAB marking the entire contents of the array as read or written, even though only some elements were accessed.

### Detecting Multitasking Access Errors

Data integrity may be compromised if a data store is read from in one task and written to in another task. For example, suppose that:

- 1 A task is writing to a data store.
- 2 A second task interrupts the first task.
- 3 The second task reads from that data store.

If the first task had only partly updated the data store when the second task interrupted, the resulting data in the data store is inconsistent. For example, if the value is a vector, some of its elements may have been written in the current time step, while the rest were written in the previous step. If the value is a multi-word, it may be left in an inconsistent state that is not even partly correct.

Unless you are certain that task preemption cannot cause data integrity problems, set the compile-time diagnostic **Model Configuration Parameters > Diagnostics > Data Validity > Data Store Memory block > Multitask data store** to warning (the default) or error. This diagnostic flags any case of a data store that is read from and written to in different tasks. The next figure illustrates a problem detected by setting **Multitask data store** to error:



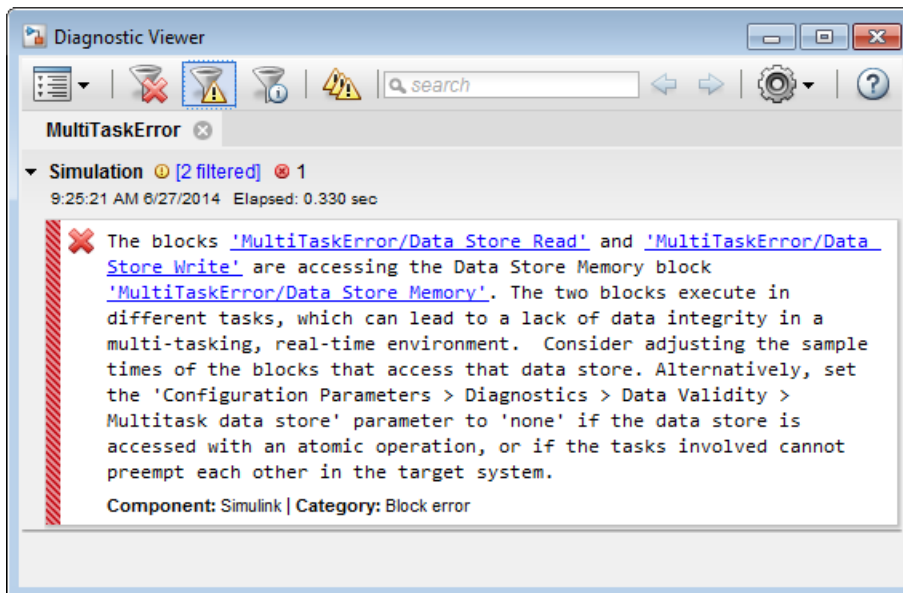
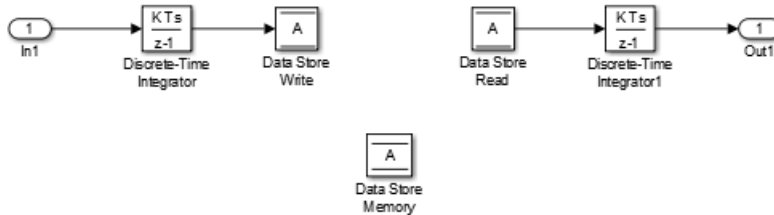

Since the data store A is written to in the fast task and read from in the slow task, an error is reported, with suggested remedy. This diagnostic is applicable even in the case that a data store read or write is inside of a conditional subsystem. Simulink correctly identifies the task that the block is executing within, and uses that task for the purpose of evaluating the diagnostic.

The next figure shows one solution to the problem shown above: place a rate transition block after the data store read, which previously accessed the data store at the slower rate.

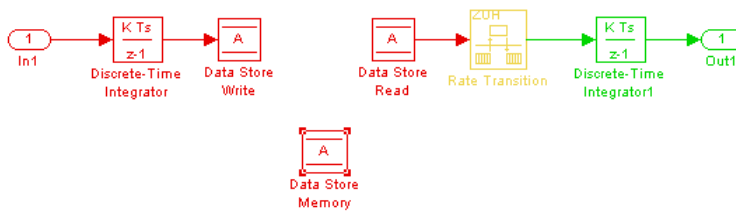

With this change, the data store write can continue to occur at the faster rate. This may be important if that data store must be read at that faster rate elsewhere in the model.

The **Multitask Data Store** diagnostic also applies to data store reads and writes in referenced models. If two different child models execute a data store's reads and writes in differing tasks, the error will be detected when Simulink compiles their common parent model.

### Detecting Duplicate Name Errors

Data store errors can occur due to duplicate uses of a data store name within a model. For instance, data store shadowing occurs when two or more data store memories in different nested scopes have the same data store name. In this situation, the data store memory referenced by a data store read or write block at a low level may not be the intended store.

To prevent errors caused by duplicate data store names, set the compile-time diagnostic **Model Configuration Parameters > Diagnostics > Data Validity > Data Store Memory block > Duplicate data store names** to warning or error. By default, the value of the diagnostic is **none**, suppressing duplicate name detection. The next figure shows a problem detected by setting **Duplicate data store names** to **error**:

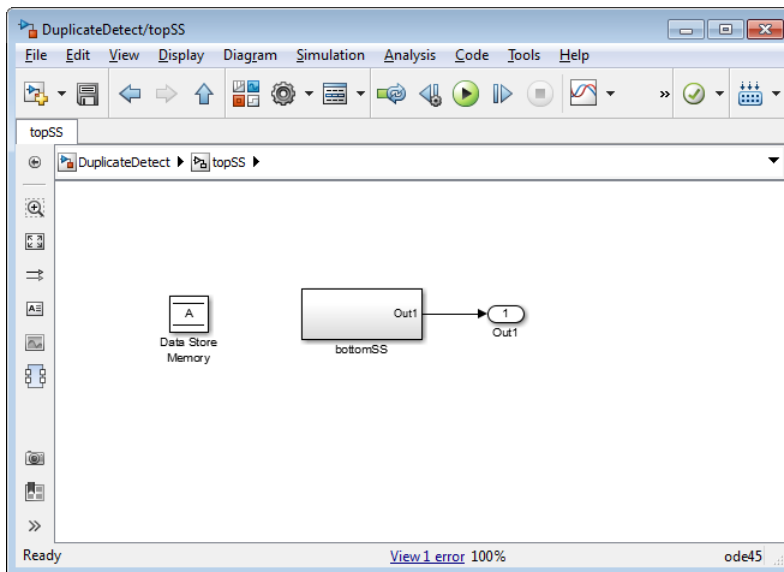
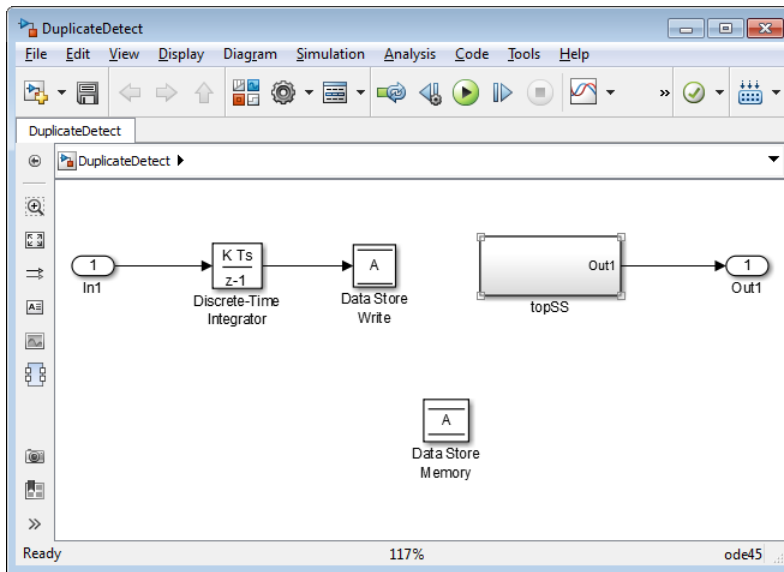

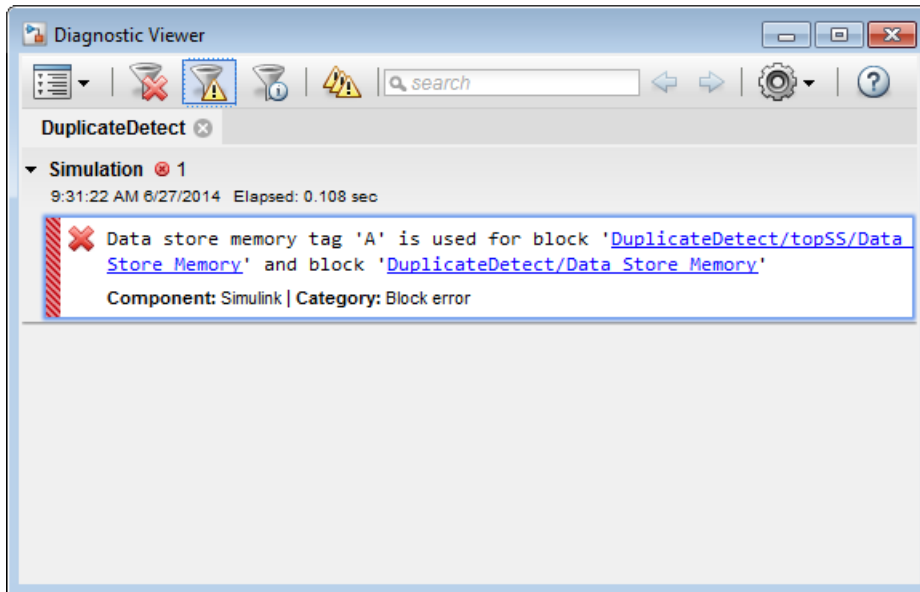
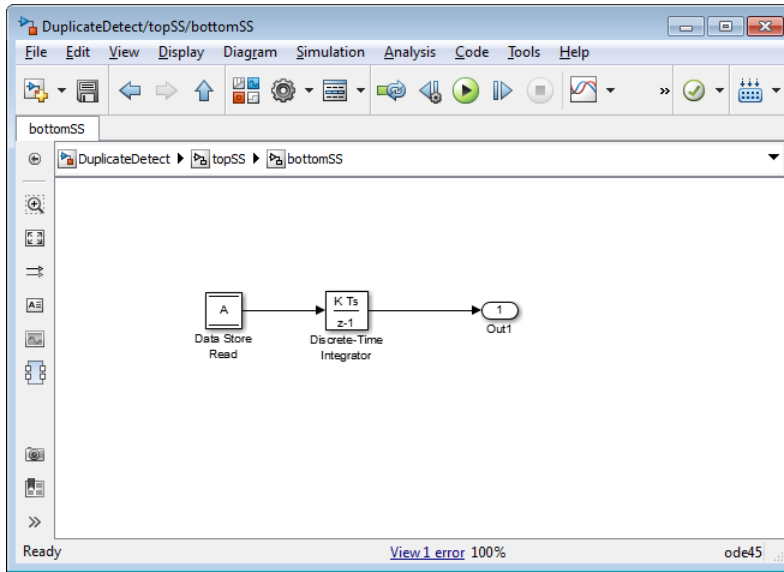

The data store read at the bottom level of a subsystem hierarchy refers to a data store named A, and two Data Store Memory blocks in the same model have that name, so an

error is reported. This diagnostic guards against assuming that the data store read refers to the Data Store Memory block in the top level of the model. The read actually refers to the Data Store Memory block at the intermediate level, which is closer in scope to the Data Store Read block.

### Data Store Diagnostics in the Model Advisor

The Model Advisor provides several diagnostics that you can use with data stores. See these sections for information about Model Advisor diagnostics for data stores:

“Check Data Store Memory blocks for multitasking, strong typing, and shadowing issues”

“Check data store block sample times for modeling errors”

“Check if read/write diagnostics are enabled for data store blocks”

### Specify Initial Value for Data Store

In general, to specify an initial value for a data store, you can use the same techniques that you use for other blocks. See “Initialize Signals and Discrete States” on page 62-48.

With most blocks, you can take advantage of scalar expansion to minimize the effort of specifying an initial value for a nonscalar signal. When you specify a scalar initial value, each element in the signal uses that scalar.

However, when you set the **Dimensions** parameter to -1 in a Data Store Memory block (the default), you cannot use scalar expansion. Instead, you must specify an initial value that has the same dimensions as the stored signal. To take advantage of scalar expansion of the initial value, set the **Dimensions** parameter to a specific value such as [1 2] or [1 myDim] (for symbolic dimensions).

### See Also

Data Store Write | Data Store Memory | Data Store Read | `Simulink.Signal`

### Related Examples

- “Data Stores in Generated Code” (Simulink Coder)
- “Model Global Data by Creating Data Stores” on page 60-13
- “Log Data Stores” on page 60-39

- “Data Objects” on page 57-59
- “Signal Basics” on page 62-2

## Model Global Data by Creating Data Stores

### In this section...

“Data Store Examples” on page 60-13

“Create and Apply Data Stores” on page 60-15

“Data Stores with Data Store Memory Blocks” on page 60-17

“Data Stores with Signal Objects” on page 60-20

“Access Data Stores with Simulink Blocks” on page 60-22

“Order Data Store Access” on page 60-24

“Data Stores with Buses and Arrays of Buses” on page 60-30

“Accessing Specific Bus and Matrix Elements” on page 60-31

“Rename Data Stores” on page 60-36

“Customized Data Store Access Functions in Generated Code” on page 60-38

A *data store* is a repository to which you can write data, and from which you can read data, without having to connect an input or output signal directly to the data store. Data stores are accessible across model levels, so subsystems and referenced models can use data stores to share data without using I/O ports. To decide whether to use data stores, see “Data Store Basics” on page 60-2.

## Data Store Examples

### Overview

The following examples illustrate techniques for defining and accessing data stores. See “Order Data Store Access” on page 60-24 for techniques that control data store access over time, such as ensuring that a given data store is always written before it is read. See “Data Store Diagnostics” on page 60-3 for techniques you can use to help detect and correct potential data store errors without needing to run any simulations.

---

**Note:** In addition to the following examples, see the `sldemo_mdref_dsm` model, which shows how to use global data stores to share data among referenced models.

---

### Local Data Store Example

The following model illustrates creation and access of a local data store, which is visible only in a model or particular subsystem.

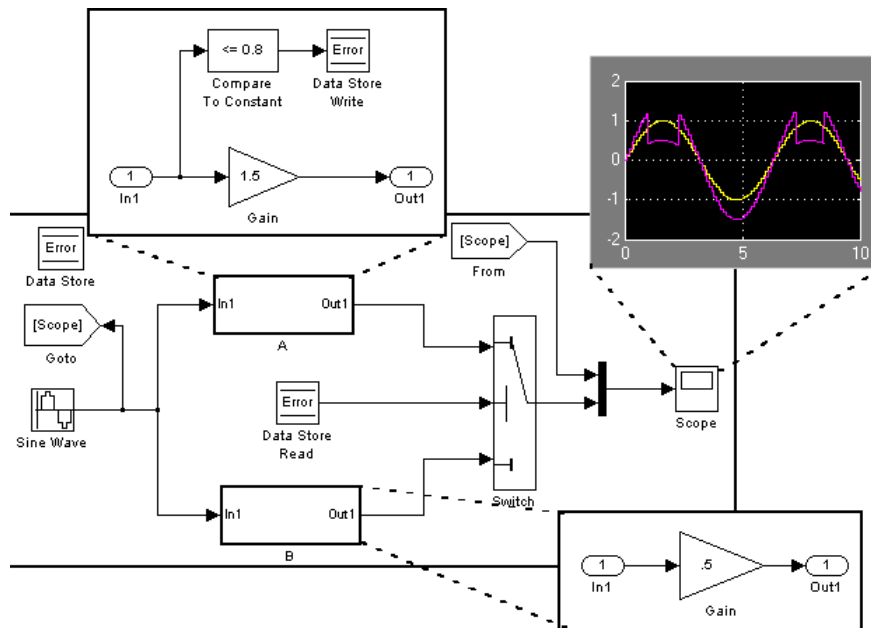

This model uses a data store to permit subsystem A to signal that its output is invalid. If subsystem A's output is invalid, the model uses the output of subsystem B.

### Global Data Store Example

The following model replaces the subsystems of the previous example with functionally identical referenced models to illustrate use of a global data store to share data in a model reference hierarchy.



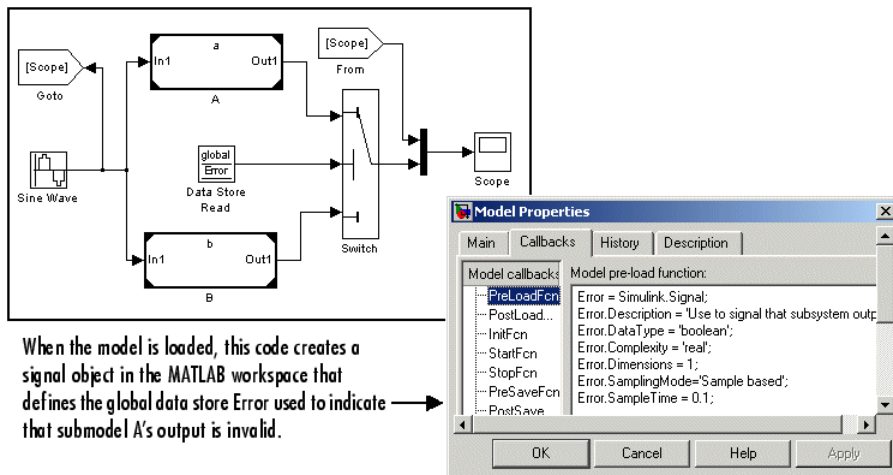

In this example, the top model uses a signal object in the MATLAB workspace to define the error data store. This is necessary because data stores are visible across model boundaries only if they are defined by signal objects in the MATLAB workspace.

## Create and Apply Data Stores

**Note:** To use buses and arrays of buses with data stores, perform *both* the following procedure and “Setting Up a Model to Use Data Stores with Buses and Arrays of Buses” on page 60-31.

The following is a general workflow for configuring data stores. You can perform the tasks in a different order, or separately from the rest, depending on how you use data stores.

- 1 Where applicable, plan your use of data stores to minimize their effect on software verification. For more information, see “Data Stores and Software Verification” on page 60-2.
- 2 Create data stores using the techniques described in “Data Stores with Data Store Memory Blocks” on page 60-17 or “Data Stores with Signal Objects” on page 60-20. For greater reliability, consider assigning rather than inheriting data store attributes, as described in “Specifying Data Store Memory Block Attributes” on page 60-17.

- 3 Add to the model Data Store Write and Data Store Read blocks to write to and read from the data stores, as described in “Access Data Stores with Simulink Blocks” on page 60-22.
- 4 Configure the model and the blocks that access each data store to avoid concurrency failures when reading and writing the data store, as described in “Order Data Store Access” on page 60-24.
- 5 Apply the techniques described in “Data Store Diagnostics” on page 60-3 as needed to prevent data store errors, or to diagnose them if they occur during simulation.
- 6 If you intend to generate code for your model, see “Data Stores in Generated Code” (Simulink Coder).

To create a data store, you create a Data Store Memory block or a `Simulink.Signal` object. The block or signal object represents the data store and specifies its properties. Every data store must have a unique name.

- A Data Store Memory block implements a local data store. See “Data Stores with Data Store Memory Blocks” on page 60-17.
- A `Simulink.Signal` object can act as a local or global data store. See “Data Stores with Signal Objects” on page 60-20.

Data stores implemented with Data Store Memory blocks:

- Support data store initialization
- Provide control of data store scope and options at specific levels in the model hierarchy
- Require a block to represent the data store
- Cannot be accessed within referenced models
- Cannot be in a subsystem that a For Each Subsystem block represents.

Data stores implemented with `Simulink.Signal` objects:

- Provide model-wide control of data store scope and options
- Do not require a block to represent the data store
- Can be accessed in referenced models, if the data store is global

Be careful not to equate local data stores with Data Store Memory blocks, and global data stores with `Simulink.Signal` objects. Either technique can define a local data store, and a signal object can define either a local or a global data store.

## Data Stores with Data Store Memory Blocks

- “Creating the Data Store” on page 60-17
- “Specifying Data Store Memory Block Attributes” on page 60-17

### Creating the Data Store

To use a Data Store Memory block to define a data store, drag an instance of the block into the model at the topmost level from which you want the data store to be visible. The result is a local data store, which is not accessible within referenced models.

- To define a data store that is visible at every level within a given model, except within Model blocks, drag the Data Store Memory block into the root level of the model.
- To define a data store that is visible only within a particular subsystem and the subsystems that it contains, but not within Model blocks, drag the Data Store Memory block into the subsystem.

Once you have added the Data Store Memory block, use its parameters dialog box to define the data store's properties. The **Data store name** property specifies the name of the data store that the Data Store Write and Data Store Read blocks access. See Data Store Memory documentation for details.

You can specify data store properties beyond those definable with Data Store Memory block parameters by selecting the **Data store name must resolve to Simulink signal object** option and using a signal object as the data store name. See “Specifying Attributes Using a Signal Object” on page 60-18 for details.

### Specifying Data Store Memory Block Attributes

A Data Store Memory block can inherit three data attributes from its corresponding Data Store Read and Data Store Write blocks. The inheritable attributes are:

- Data type
- Complexity
- Sample time

However, allowing these attributes to be inherited can cause unexpected results that can be difficult to debug. To prevent such errors, use the Data Store Memory block dialog or a `Simulink.Signal` object to specify the attributes explicitly.

### Specifying Attributes Using Block Parameters

You can use the Data Store Memory block dialog box to specify the data type and complexity of a data store. In the next figure, the dialog box sets the **Data type** to `uint16` and the **Signal type** to `real`.

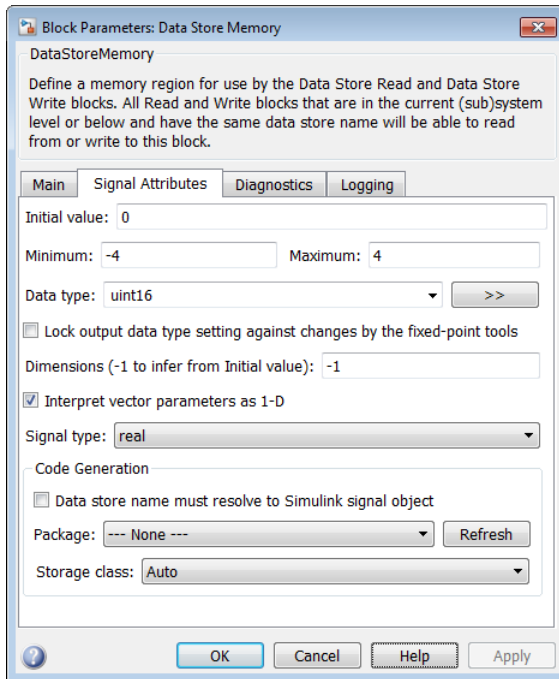

### Specifying Attributes Using a Signal Object

You can use a `Simulink.Signal` object to specify data store attributes for a Data Store Memory block.

---

**Tip:** To establish an implicit data store, as described in “Data Stores with Signal Objects” on page 60-20, use the same general approach as when you explicitly associate a signal object with a Data Store Memory block.

---

The next figure shows a Data Store Memory block that specifies resolution to a `Simulink.Signal` object, named `A`. To use a signal object for the data store, set **Data**

**store name** to the name of the signal object. For compile-time checking, open the **Signal Attributes** tab and select the **Data store name must resolve to Simulink signal object** parameter.



The signal object specifies values for all three data attributes that the data store would otherwise inherit. In this example, which defines a local data store, the `Simulink.Signal` object `A` has the following inherited properties: `DataType`, `Complexity`, and `SampleTime`.

`A =`

```
Simulink.Signal (handle)
  CoderInfo: [1x1 Simulink.CoderInfo]
  Description: ''
  DataType: 'auto'
  Min: []
  Max: []
  Unit: ''
  Dimensions: 1
```

```
DimensionsMode: 'auto'  
  Complexity: 'auto'  
  SampleTime: -1  
  InitialValue: 0
```

For more information about specifying signal object attributes for local and global data stores, see “Signal Object Attributes for Data Stores” on page 60-21.

### Use Model Data Editor to Configure Data Store Memory Blocks in a List

Use the **Data Stores** tab in the Model Data Editor to configure the parameters of a Data Store Memory block. Use this technique to configure the data store without locating it in the model and to configure the data store together with other interface elements such as Inport and Outport blocks.

To open the Model Data Editor, select **View > Model Data**. For information about using the Model Data Editor, see “Configure Data Properties by Using a Table” on page 57-123.

## Data Stores with Signal Objects

- “Creating the Data Store” on page 60-20
- “Local and Global Data Stores” on page 60-20
- “Signal Object Attributes for Data Stores” on page 60-21

### Creating the Data Store

To use a `Simulink.Signal` object to define a data store without using a Data Store Memory block, create the signal object in a workspace that is visible to every component that needs to access the data store. The name of the associated data store is the name of the signal object. You can use this name in Data Store Read and Data Store Write blocks, just as if it were the **Data store name** of a Data Store Memory block. Simulink creates an associated data store when you use the signal object for data storage.

### Local and Global Data Stores

You can use a `Simulink.Signal` object to define either a local or a global data store.

- If you define the object in the MATLAB base workspace, the result is a global data store, which is accessible in every model within Simulink, including all referenced models.
- If you create the object in a model workspace, the result is a local data store, which is accessible at every level in a model except any referenced models.

## Signal Object Attributes for Data Stores

Those data store attributes that a signal object does not define have the same default values that they do in a Data Store Memory block. The parameter values of a signal object used as a data store have different requirements, depending on whether the data store is local or global.

Once you have created the object, set the properties of the signal object to the values that you want the corresponding data store properties to have. For example, the following commands define a data store named `Error` in the MATLAB base workspace:

```
Error = Simulink.Signal;
Error.Description = 'Use to signal that subsystem output is invalid';
Error.DataType = 'boolean';
Error.Complexity = 'real';
Error.Dimensions = 1;
Error.SampleTime = 0.1;
```

### Attributes for Local Data Stores

For a local data store, for each parameter listed below, you can either set the value explicitly or you can have the data store inherit the value from the Data Store Write and Data Store Read blocks.

- `DataType`
- `Complexity`
- `SampleTime`

To define a local data store using a Data Store Memory block, you can use a signal object for the **Data store name** parameter. For compile-time checking, in the **Signal Attributes** tab, select the **Data store must resolve to Simulink signal object** parameter. The **Data store must resolve to Simulink signal object** parameter causes Simulink to display an error and stop compilation if Simulink cannot find the signal object or if the signal object properties are inconsistent with the signal object properties.

### Attributes for Global Data Stores

The following table describes the parameter requirements for global data stores.

Parameter	Global Data Store Value
<code>DataType</code>	Must be set explicitly

Parameter	Global Data Store Value
Complexity	Must be set explicitly
Dimensions	Can be set or inherited
SampleTime	Can be set or inherited

## Access Data Stores with Simulink Blocks

- “Writing to a Data Store” on page 60-22
- “Reading from a Data Store” on page 60-22
- “Accessing a Global Data Store” on page 60-23

### Writing to a Data Store

To set the value of a data store at each time step:

- 1 Create an instance of a Data Store Write block at the level of your model that computes the value.
- 2 Set the Data Store Write block **Data store name** parameter to the name of the data store to which you want it to write data.
- 3 Connect the output of the block that computes the value to the input of the Data Store Write block.

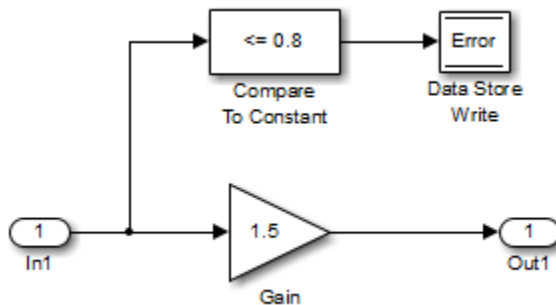

### Reading from a Data Store

To get the value of a data store at each time step:



- 1 Create an instance of a Data Store Read block at the level of your model that needs the value.
- 2 Set the Data Store Read block **Data store name** parameter to the name of the data store from which you want it to read.
- 3 Connect the output of the Data Store Read block to the input of the block that needs the data store value.

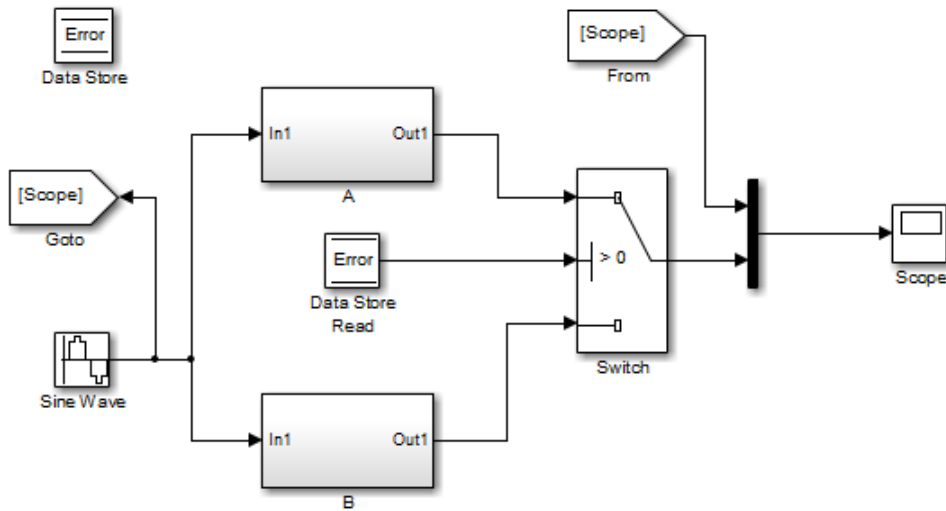

### Accessing a Global Data Store

When connected to a global data store (one that is defined by a signal object in the MATLAB workspace), a Data Store Read or Data Store Write block displays the word `global` above the data store name.

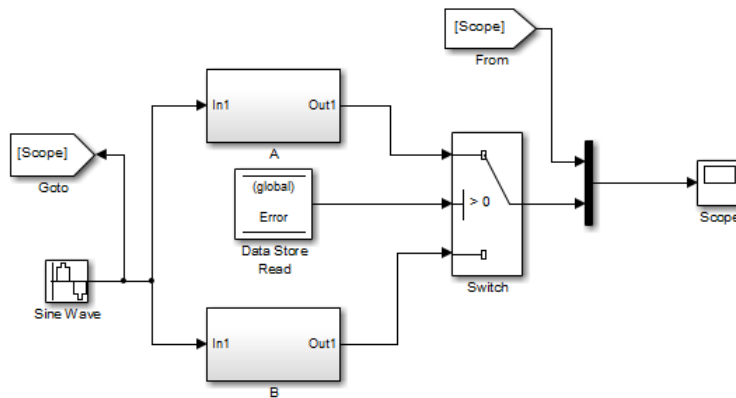

## Order Data Store Access

- “About Data Store Access Order” on page 60-24
- “Ordering Access Using Function Call Subsystems” on page 60-24
- “Ordering Access Using Block Priorities” on page 60-28

### About Data Store Access Order

To obtain correct results from data stores, you must control the order of execution of the data store’s reads and writes. If a data store’s read occurs before its write, latency is introduced into the algorithm: the read obtains the value that was computed and stored in the previous time step, rather than the value computed and stored in the current time step.

Such latency may cause the system to behave other than as designed, and in some cases may destabilize the system. Even if these problems do not occur, an uncontrolled access order could change from one release of Simulink to the next.

This section describes several strategies for explicitly controlling the order of execution of a data store’s reads and writes. See “Data Store Diagnostics” on page 60-3 for techniques you can use to detect and correct potential data store errors without running simulations.

### Ordering Access Using Function Call Subsystems

You can use function call subsystems to control the execution order of model components that access data stores. The next figure shows this technique:

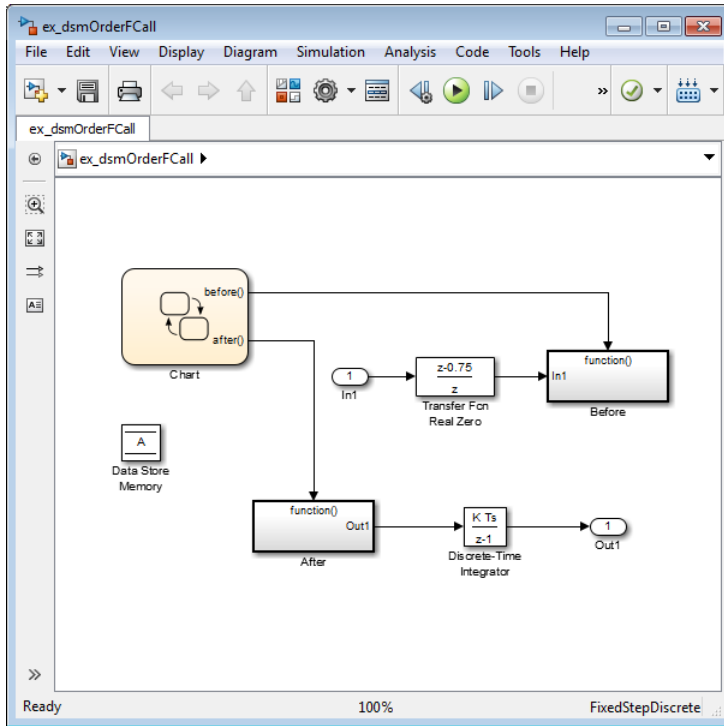

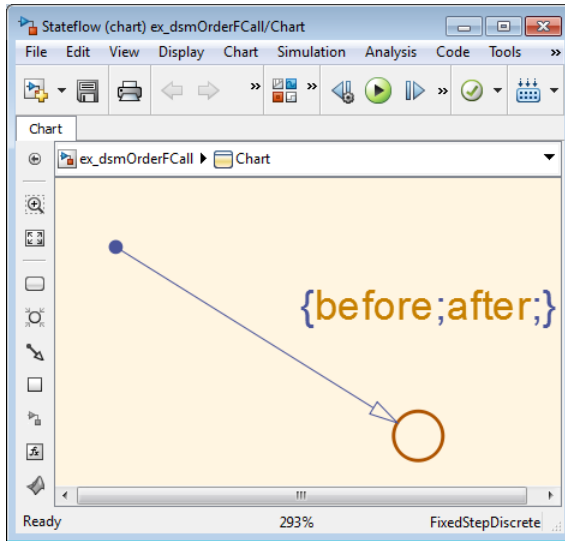

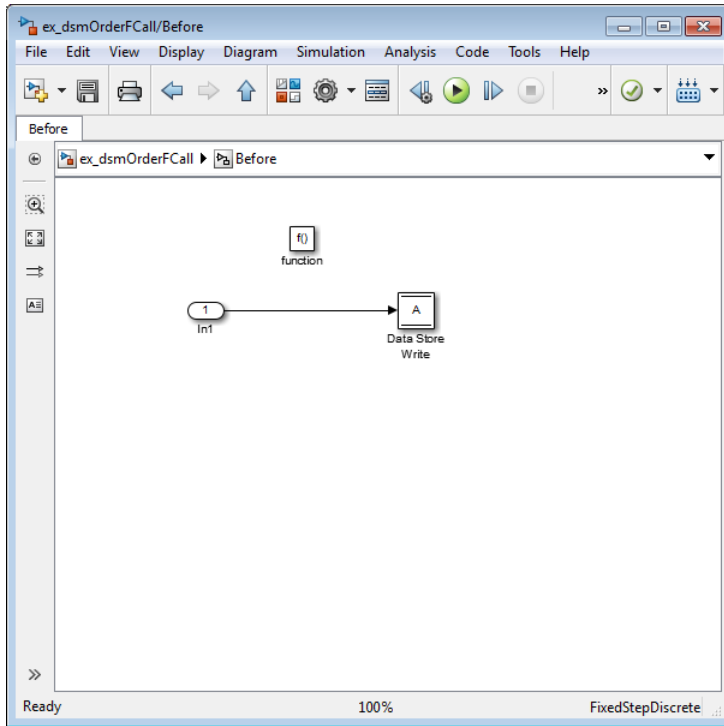

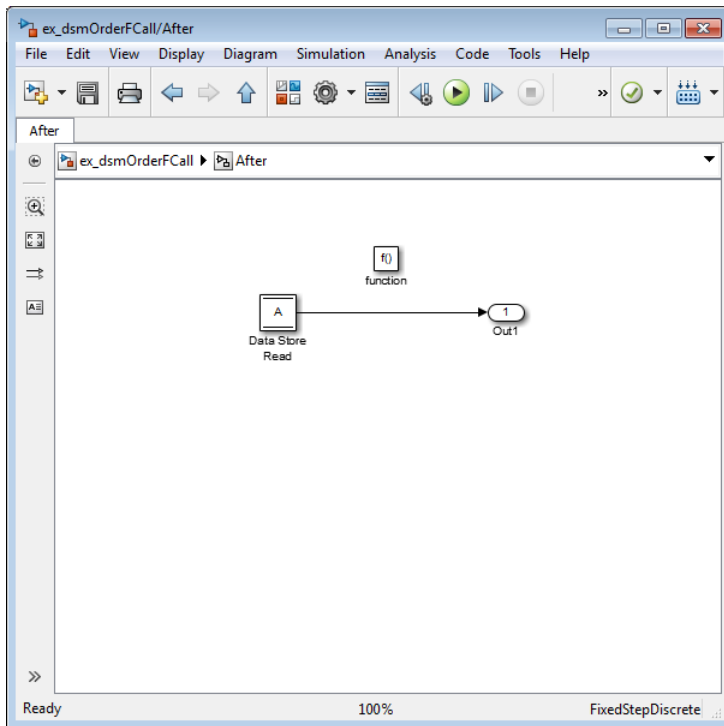

The subsystem **Before** contains the Data Store Write, and the Stateflow chart calls that subsystem before it calls the subsystem **After**, which contains the Data Store Read.

### Ordering Access Using Block Priorities

You can embed data store reads and writes inside atomic subsystems or Model blocks whose priorities specify their relative execution order.

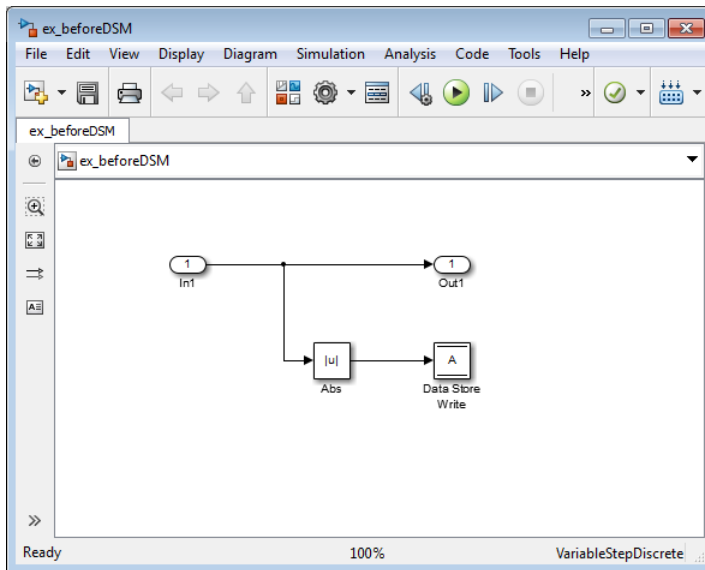
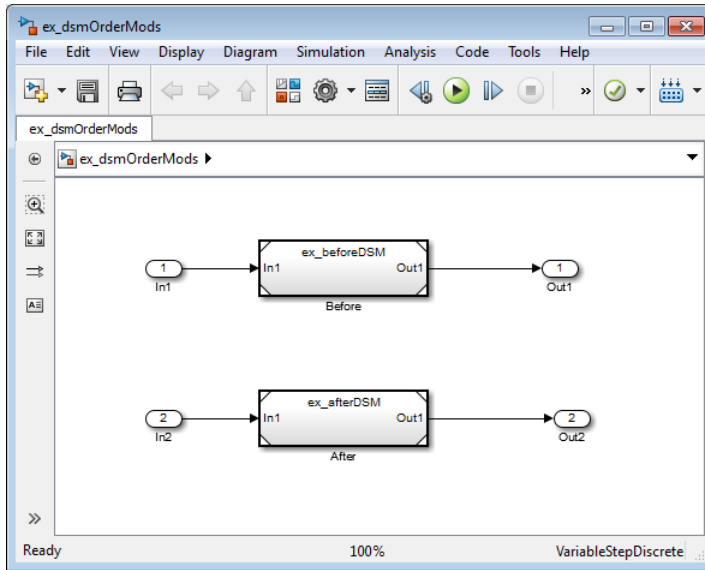

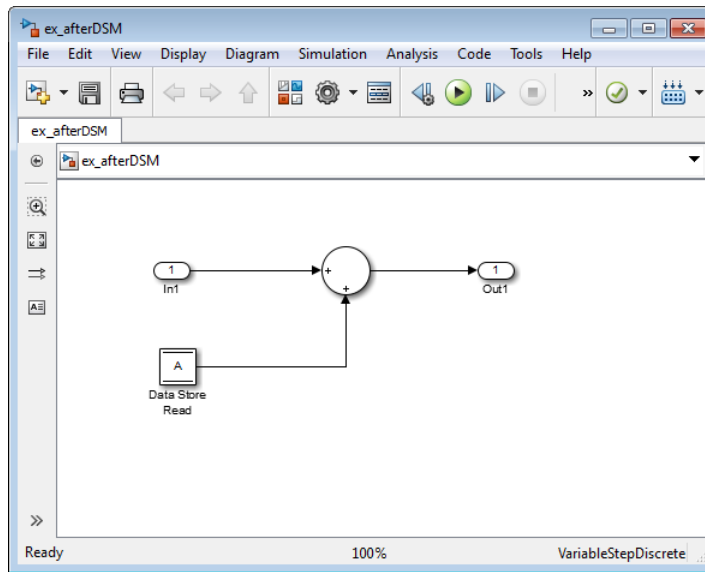

The Model block `beforeDSM` has a lower priority than `afterDSM`, so it is guaranteed to execute first. Since `beforeDSM` is atomic, all of its operations, including the Data Store Write, will execute prior to `afterDSM` and all of its operations, including the Data Store Read.

To assign priorities to blocks, see “Assign Block Priorities” on page 34-41.

## Data Stores with Buses and Arrays of Buses

Benefits of using data stores with buses and arrays of buses include:

- Simplifying the model layout by associating multiple signals with a single data store
- Producing generated code that represents the data in the store data as structures that reflect the bus hierarchy
- Writing to and reading from data stores without creating data copies, which results in more efficient data access

You cannot use a bus or array of buses that contains:

- Variable-dimension signals



- Frame-based signals

## Setting Up a Model to Use Data Stores with Buses and Arrays of Buses

This procedure applies to local and global data stores, and to data stores defined with a Data Store Memory block or a `Simulink.Signal` object. Before performing the procedure, you must understand how to use data stores in a model, as described in “Create and Apply Data Stores” on page 60-15.

To use buses and arrays of buses with data stores:

- 1 Use the Bus Editor to define a bus object whose properties match the bus data that you want to write to and read from a data store. For details, see “Create Bus Objects with the Bus Editor” on page 63-63.
- 2 Add a data store (using a Data Store Memory block or a `Simulink.Signal` object) for storing the bus data.
- 3 Specify the bus object as the data type of the data store. For details, see “Specify a Bus Object Data Type” on page 57-55.
- 4 In the **Model Configuration Parameters > Diagnostics > Connectivity** pane, set the **Mux blocks used to create bus** diagnostic to **error**.
- 5 If you use a MATLAB structure for the initial value of the data store, then set **Configuration Parameters > All Parameters > Underspecified initialization detection** to **Simplified**. For details, see “Specify Initial Conditions for Bus Signals” on page 63-99 and “Underspecified initialization detection”.
- 6 (Optional) Select individual bus elements to write to or read from a data store. For details, see “Accessing Specific Bus and Matrix Elements” on page 60-31.

## Accessing Specific Bus and Matrix Elements

### Selecting Specific Bus or Matrix Elements

By default, a model writes and reads all bus and matrix elements to and from a data store.

To select specific bus or matrix elements to write to or read from a data store, use the **Element Assignment** pane of the Data Store Write block and the **Element Selection** pane of the Data Store Read block. Selecting specific bus or matrix elements offers the following benefits:

- Reducing the number of blocks in the model. For example, you can eliminate a Data Store Read and Bus Selector block pair or a Data Store Write and Bus Assignment block pair for each specific bus element that you want to access).
- Faster simulation of models with large buses and arrays of buses.

### Writing Specific Elements to a Data Store

**Note:** The following procedure describes how to use the Data Store Write block interface to write specific elements to a data store. You can also perform this task at the command line, using the `DataStoreElements` parameter to specify elements. For details, see “Specification using the command line” on page 60-36.

To assign specific bus or matrix elements to write to a data store:

- 1 Select the Data Store Write block and in the parameters dialog box, select the **Element Assignment** pane. For example, suppose you are using a bus with a data store named DSM:

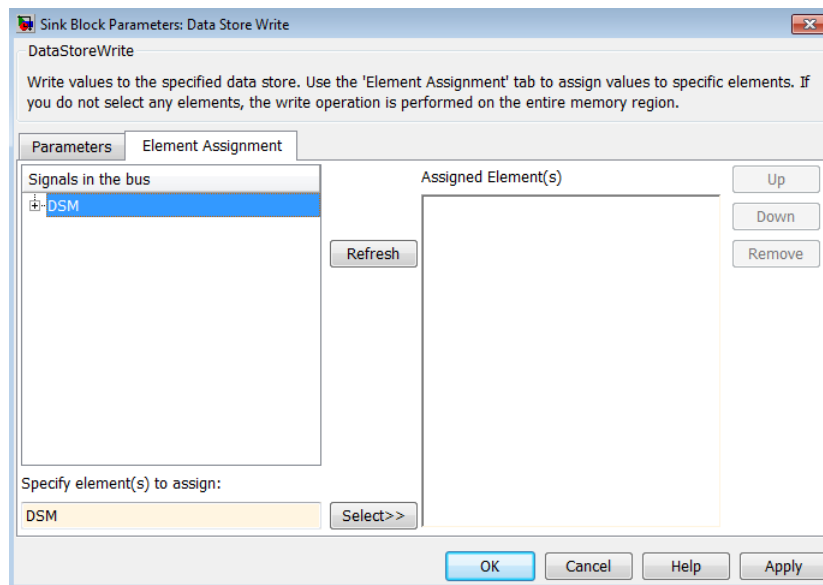

- 2 Expand all the elements in the **Signals in the bus** list.

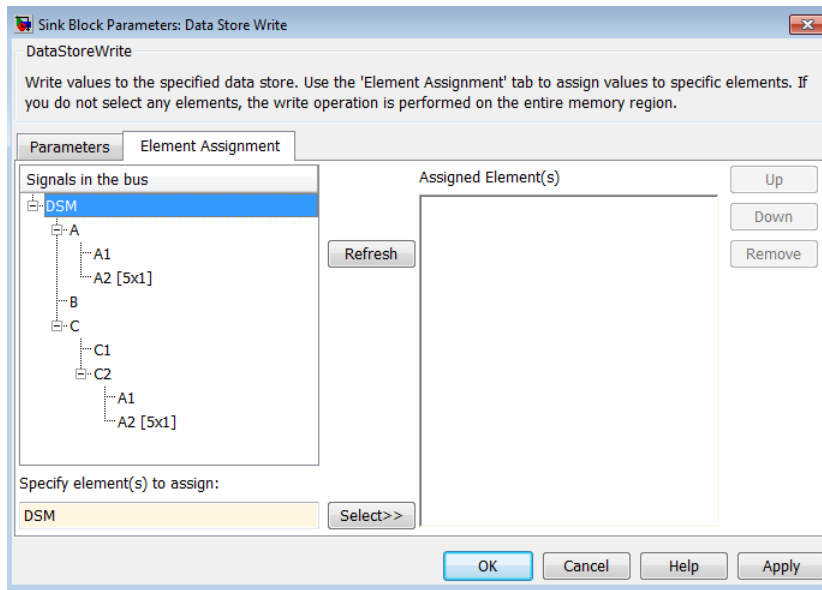

- 3 Specify the elements that you want to write to the data store. For example:
- In the **Signals in the bus** list, click B. Then click **Select>>** to select the element B.
  - To write all the elements of A2 (in the A subbus), select A2 [5x1]. Then click **Select>>**.
  - To write the second element of A2 in the C2 subbus, select the A2 [5x1] element. In the **Specify element(s) to assign** text box, edit the text to say DSM.C.C2.A2(2,1).

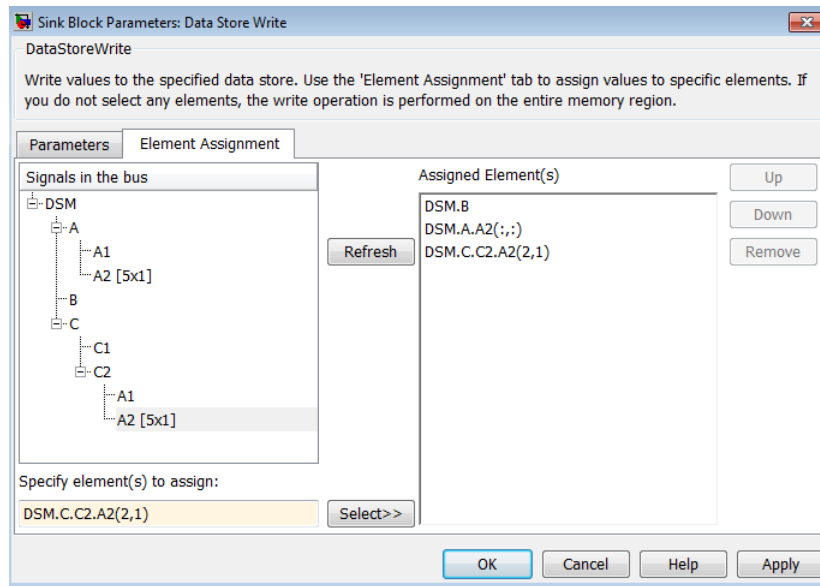

For more examples, see “Specifying Elements to Assign or Select” on page 60-35.

- 4 (Optional) Reorder the assigned elements, which changes the order of the ports of the Data Store Write block.
  - To reorder an assigned element, in the **Assigned element(s)** list, select the element that you want to move, and click **Up** or **Down**.
  - To remove an assigned element, click **Remove**.
- 5 To apply the assigned elements, click **OK**.

The Data Store Write block has a port for each assigned element. The names of the selected elements that correspond to each port appear in the block icon. If you assign several signals, these additions may diminish the readability of the model. To improve readability, you can expand the size of the block or create multiple Data Store Write blocks.

### Reading Specific Elements from a Data Store

Reading specific elements from a data store involves very similar steps as described in “Writing Specific Elements to a Data Store” on page 60-32. The Data Store Read block differs slightly from the Data Store Write block. A Data Store Read block has:

- An **Element Selection** pane instead of an **Element Assignment** pane
- A **Selected element(s)** list instead of an **Assigned element(s)** list

### Specifying Elements to Assign or Select

Use MATLAB matrix element syntax to specify specific elements. For details about specifying matrices in MATLAB, see “Creating and Concatenating Matrices” (MATLAB).

---

**Note:** To select matrix elements, you cannot use dynamic indexing with the **Element Assignment** and **Element Selection** panes of Data Store Read and Bus Assignment block pairs or Data Store Write and Bus Selector block pairs. You can, however, use a MATLAB Function block for dynamic indexing.

---

### Valid element specifications

The following table shows examples of valid syntax for specifying elements to assign or select. These examples use the A2 subbus of the A bus, as shown in the bus hierarchy used in “Writing Specific Elements to a Data Store” on page 60-32.

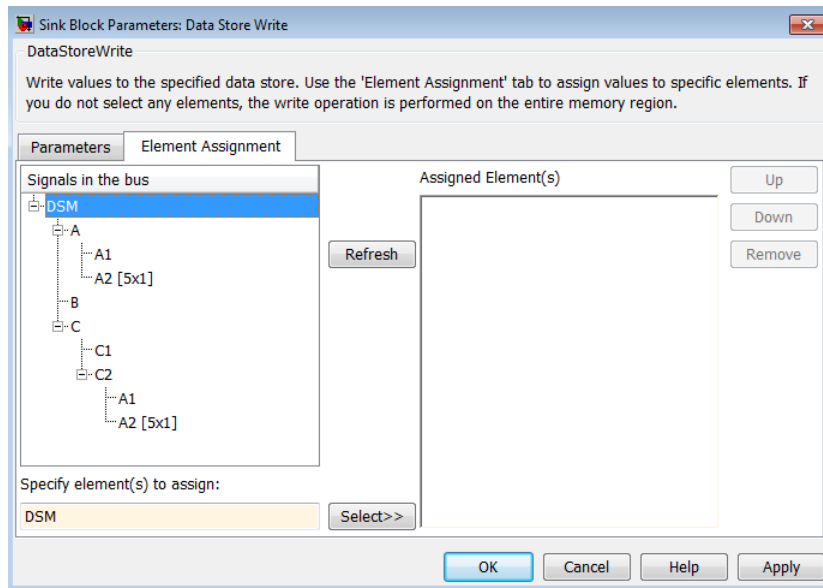

Valid Syntax	Description
<code>DSM.A.A2 (:, :)</code>	Selects all elements in every dimension
<code>DSM.A.A2 ([ 1, 3, 5 ], 1)</code>	Selects the first, third, and fifth elements
<code>DSM.A.A2 (2:5, 1)</code>	Selects the second through the fifth element

### Invalid element specifications

The following table shows examples of invalid syntax for specifying elements to assign or select. These examples use the A2 subbus of the A bus, as shown in the bus hierarchy used in “Writing Specific Elements to a Data Store” on page 60-32.

Invalid Syntax	Reason the Syntax Is Invalid
<code>DSM.A.A2 (:)</code>	You must specify a colon for each dimension. For the bus hierarchy used in these examples, you must use two colons.
<code>DSM.A.A2 (2:end, 1)</code>	You cannot use the <code>end</code> operator.
<code>DSM.A.A2 (idx, 1)</code>	You cannot use variables to specify indices. Consider using a MATLAB Function block.
<code>DSM.A.A2 (-1, 1)</code>	The dimension <code>-1</code> is not within the valid dimension bounds.

### Specification using the command line

To set the elements to write to or read from, use the `DataStoreElements` parameter. Use a pound sign (`#`) to delimit multiple elements. For example, select the Data Store Write or Data Store Read block for which you want to specify elements and enter a command such as:

```
set_param(gcb, 'DataStoreElements', 'DSM.A#DSM.B#DSM.C(3,4)')
```

This specification results in the block now having three ports corresponding to the elements that you specified.

### Rename Data Stores

- “Rename Data Store Defined by Block” on page 60-37
- “Rename Data Store Defined by Signal Object” on page 60-37

## Rename Data Store Defined by Block

Rename a data store everywhere it is used by Data Store Read and Data Store Write blocks in a model.

- 1 In a Data Store Memory block dialog box, type a new name in the **Data store name** box, and click **Rename All**.
- 2 In the **Rename All** dialog box, confirm the new data store name in the **New name** field, and click **OK**

---

**Note:** You cannot use **Rename All** to rename a data store if you create a `Simulink.Signal` object in a workspace to control the code generated for the data store. Instead, you must rename the corresponding `Simulink.Signal` object using Model Explorer. For an example, see “Rename Data Store Defined by Signal Object” on page 60-37.

---

## Rename Data Store Defined by Signal Object

This example shows how to rename a data store defined by a `Simulink.Signal` object. You can use Model Explorer to rename the object everywhere it is used by Data Store Read and Data Store Write blocks in a model or in a model reference hierarchy.

- 1 Open the model `sldemo_mdhref_dsm`. The model creates a `Simulink.Signal` object `ErrorCond` in the MATLAB base workspace and uses the object as a global data store in a model reference hierarchy.
- 2 Open Model Explorer.
- 3 In the **Model Hierarchy** pane, select the base workspace.
- 4 In the **Contents** pane, right-click the data store `ErrorCond` and select **Rename All**.
- 5 In the **Select a system** dialog box, click the name of the model `sldemo_mdhref_dsm` to select it as the context for renaming the data store `ErrorCond`.
- 6 Select **Search in referenced models** since `ErrorCond` is a global data store that is used in a referenced model. Click **OK**.

The **Update diagram to include recent changes** check box is cleared by default to save time by avoiding unnecessary model diagram updates. Select the check box to incorporate recent changes you made to the model by forcing a diagram update.

- 7 Click **OK** in response to the message to update the model diagram.

Since you just opened the model, you must update the model diagram at least once before renaming a variable such as `ErrorCond`. You could have selected **Update diagram to include recent changes** in the **Select a system** dialog box to force an initial diagram update, though you typically use that option when you make changes to the model while performing multiple variable renaming operations.

- 8 In the **Rename All** dialog box, type the new name for the data store in the **New name** box and click **OK**.

## Customized Data Store Access Functions in Generated Code

Embedded Coder provides a custom storage class that you can use to specify customized data store access functions in generated code. See “Control Data Representation by Applying Custom Storage Classes” (Embedded Coder) and “Access Data Through Functions with Custom Storage Class GetSet” (Embedded Coder).

### See Also

Data Store Write | Data Store Memory | Data Store Read | `Simulink.Signal`

### Related Examples

- “Data Stores in Generated Code” (Simulink Coder)
- “Log Data Stores” on page 60-39
- “Data Store Basics” on page 60-2
- “Data Objects” on page 57-59
- “Signal Basics” on page 62-2
- “Buses” on page 63-3



## Log Data Stores

### In this section...

“Logging Local and Global Data Store Values” on page 60-39

“Supported Data Types, Dimensions, and Complexity for Logging Data Stores” on page 60-39

“Data Store Logging Limitations” on page 60-40

“Logging Data Stores Created with a Data Store Memory Block” on page 60-40

“Logging Icon for the Data Store Memory Block” on page 60-40

“Logging Data Stores Created with a Simulink.Signal Object” on page 60-41

“Accessing Data Store Logging Data” on page 60-41

### Logging Local and Global Data Store Values

You can log the values of a local or global data store data variable for all the steps in a simulation. Two common uses of data store logging are for:

- Model debugging – view the order of all data store writes
- Confirming a model modification – use the logged data to establish a baseline for comparing results for identifying the impact of a model modification

For an example of logging a global data store, see “Using Data Stores Across Multiple Models”.

### Supported Data Types, Dimensions, and Complexity for Logging Data Stores

You can log data stores that use the following data types:

- All built-in data types
- Enumerated data types
- Fixed-point data types

You can log data stores that use any dimension level or complexity.

## Data Store Logging Limitations

Limitations for using data store logging in a model are:

- To log data for a data store memory:
  - Simulate the top-level model in Normal mode.
  - For local data stores, the model containing the Data Store Memory block must be in Model Reference Normal mode.
  - Any block in a referenced model that writes to the data store memory must be executed in model reference Normal mode.
- In the Solver pane of the Configuration Parameters dialog box, if **Treat each discrete rate as a separate task** is selected, you cannot log Data Store Memory blocks that use asynchronous sample times or hybrid sample times (that is, sample times resulting from when different data sources for the data store have different sample times).

For details about viewing information about sample times, see “View Sample Time Information” on page 7-9.

- You cannot log data stores that use custom data types.

## Logging Data Stores Created with a Data Store Memory Block

To log a local data store that you create with a Data Store Memory block:

- 1 In the Block Parameters dialog box for the Data Store Memory block that you want to log, select the **Logging** pane.
- 2 Select the **Log signal data** check box.
- 3 Optionally, specify limits for the amount of data logged, using the **Minimum** and **Maximum** parameters.
- 4 Enable data store logging with the **Model Configuration Parameters > Data Import/Export > Data stores** parameter.
- 5 Simulate the model.

## Logging Icon for the Data Store Memory Block

When you enable logging for a model, and you configure a local data store for logging, the Data Store Memory block displays a blue icon. If you do not enable logging for the model, then the icon is gray.

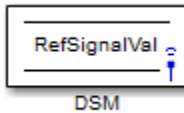

## Logging Data Stores Created with a Simulink.Signal Object

You can create local and global data stores using a `Simulink.Signal` object. See “Data Stores with Signal Objects” on page 60-20 for details.

To log a data store that you create with a `Simulink.Signal` object:

- 1 Create a `Simulink.Signal` object in a workspace that is visible to every component that needs to access the data store, as described in “Data Stores with Signal Objects” on page 60-20.
- 2 Use the name of the `Simulink.Signal` object in the **Data store name** block parameters of the Data Store Read and Data Store Write blocks that you want to write to and read from the data store.
- 3 From the MATLAB command line, set `DataLogging` (which is a property of the `LoggingInfo` property of `Simulink.Signal`) to 1.

For example, if you use a `Simulink.Signal` object called `DataStoreSignalObject` to create a data store, use the following command:

```
DataStoreSignalObject.LoggingInfo.DataLogging = 1
```

- 4 Optionally, specify limits for the amount of data logged, using the following properties, which are properties of the `LoggingInfo` property of the `Simulink.Signal` object: `Decimation`, `LimitDataPoints`, and `MaxPoints`.
- 5 Enable data store logging with the **Model Configuration Parameters > Data Import/Export > Data stores** parameter.
- 6 Simulate the model.

## Accessing Data Store Logging Data

The following Simulink classes represent data from data store logging and provide methods for accessing that data:

Class	Description
<code>Simulink.SimulationData.BlockPath</code>	Represents a fully specified Simulink block path; use for capturing the full model reference hierarchy
<code>Simulink.SimulationData.Dataset</code>	Stores logged data elements and provides searching capabilities; use to group <code>Simulink.SimulationData.Element</code> objects in a single object
<code>Simulink.SimulationData.DataStoreMemory</code>	Stores logging information from a data store during simulation

You can also convert data logged in formats other than Dataset. For more information, see “Dataset Conversion for Logged Data” on page 59-24.

### Viewing Data Store Data

To view data store logging data from the command line, view the output data set in the base workspace. The default variable for the data store logging data set is `dsmout`.

The `sldemo_mdref_dsm` model illustrates approaches for viewing data store logging data.

### Accessing Elements in the Data Store Logging Data

To find an element in the data store logging data, based on the `Name` or `BlockType` property, use the `getElement` method of `Simulink.SimulationData.Dataset`. For example:

```
dsmout.getElement('RefSignalVal')

ans =
Simulink.SimulationData.DataStoreMemory
Package: Simulink.SimulationData

Properties:
    Name: 'RefSignalVal'
    Blockpath: [1x1 Simulink.SimulationData.BlockPath]
    Scope: 'local'
    DSMWriterBlockPaths: [1x2 Simulink1.SimulationData.BlockPath]
    DSMWriters: [101x1 uint32]
    Values: 101x1 timeseries]
```

To access an element by index, use the `Simulink.SimulationData.Dataset.getElement` method.

### **See Also**

`Simulink.SimulationData.Dataset` | `Simulink.SimulationData.BlockPath` | `Simulink.SimulationData.DataStoreMemory`

### **Related Examples**

- “Model Global Data by Creating Data Stores” on page 60-13
- “Data Store Basics” on page 60-2



# Simulink Data Dictionary

---

- “What Is a Data Dictionary?” on page 61-2
- “Migrate Models to Use Simulink Data Dictionary” on page 61-6
- “Enumerations in Data Dictionary” on page 61-14
- “Import and Export Dictionary Data” on page 61-20
- “View and Revert Changes to Dictionary Data” on page 61-27
- “Partition Dictionary Data Using Referenced Dictionaries” on page 61-34
- “Partition Data for Model Reference Hierarchy Using Data Dictionaries” on page 61-37
- “Store Data in Dictionary Programmatically” on page 61-52

## What Is a Data Dictionary?

A data dictionary is a persistent repository of data that are relevant to your model. You can also use the base workspace to store design data that are used by your model during simulation. However, a data dictionary provides more capabilities.

The dictionary stores design data, which define parameters and signals, and include data that define the behavior of the model. The dictionary does not store simulation data, which are inputs or outputs of model simulation that enter and exit Inport and Outport blocks.

In this section...
“Dictionary Capabilities” on page 61-2
“Sections of a Dictionary” on page 61-3
“Manage and Edit Entries in a Dictionary” on page 61-4
“Dictionary Referencing” on page 61-4
“Import and Export File Formats” on page 61-4

## Dictionary Capabilities

Dictionary Capability	Benefit
Dictionary as data source	All entries in a dictionary are persistent. You do not need to reload data during development.
Explicit data-model linkage	You can define a data dictionary as the data source for a model. During model simulation and code generation, the model retrieves design data from the data dictionary.
Change tracking	When you modify an entry, its status is updated in the dictionary and stored as metadata that can be tracked. The dictionary also tracks who made the changes and when. You can also view or revert changes.
Entry comparison	Compare values of entries in two dictionaries.
Data grouping into reference dictionaries	Partition and organize data items into reference dictionaries.



Dictionary Capability	Benefit
Model-data dependency	Discover how entries are used in the model.
Store and partition reference data	Store and partition data that are relevant to a model, such as equipment specifications, but not used by the model during simulation.
Unified interface for defining data	Use the Model Explorer to work with design data in a dictionary.
Incremental update in memory	Improved performance and scalability with minimal footprint on memory.
Requirements traceability linking	Navigate from a data dictionary entry to a location in a requirements document.

## Sections of a Dictionary

A Simulink data dictionary is made up of three parts called sections.

- 1 **Design Data:** Contains the variables and data types that define parameters, signals, and design data that determine the behavior of the model. Design data created or imported in a dictionary are stored in this section.

This section can store only certain classes and data types. See “Valid Design Data Classes” on page 61-11 for more information.

- 2 **Configurations:** Contains configuration sets, which are objects of the `Simulink.ConfigSet` class, that determine how the model is configured during simulation. These objects control attributes such as sample time and simulation start time.

When you store configuration sets in a data dictionary, you use configuration references to access the configuration sets. Models that are linked to a dictionary resolve configuration references to configuration sets in the dictionary. For more information about configuration references, see “About Configuration References” on page 13-28.

This section can also store variant configuration objects, which belong to the `Simulink.VariantConfigurationData` class. These objects store information about variant configurations, active and default variant settings, and definitions of the control variable associated with each configuration.

---

**Note:** If you load a configuration set from the data dictionary that contains a component that is not available on your system, the parameters in the missing component are reset to their default values.

---

- 3 Other Data:** Contains information that is relevant to your model but not used by the model during simulation. Use this section to store reference information such as data that describe physical equipment and processes that are represented by your model.

This section can store almost any built-in or custom class or data type. See “Invalid Other Data Classes” on page 61-12 for more information.

## Manage and Edit Entries in a Dictionary

To create, modify, and view the entries in a data dictionary, use the Model Explorer. For more information, see “Edit and Manage Workspace Variables Used by Models” on page 57-92 and “View and Revert Changes to Dictionary Data” on page 61-27.

To manage entries in a dictionary programmatically, see “Store Data in Dictionary Programmatically” on page 61-52.

## Dictionary Referencing

You can reference one or more dictionaries in a parent dictionary. The data in the referenced dictionaries are visible in the parent dictionary. Use this technique to meaningfully partition data, especially for model reference hierarchies. For more information, see “Partition Dictionary Data Using Referenced Dictionaries” on page 61-34 and “Partition Data for Model Reference Hierarchy Using Data Dictionaries” on page 61-37.

## Import and Export File Formats

File Format	Import to Dictionary	Export from Dictionary
MAT-file	✓	✓
MATLAB script	✓	✓

## **Related Examples**

- “Determine Where to Store Variables and Objects for Simulink Models” on page 57-85
- “Using a Data Dictionary to Manage the Data for a Fuel Control System”
- “Migrate Models to Use Simulink Data Dictionary” on page 61-6
- “View and Revert Changes to Dictionary Data” on page 61-27
- “Store Data in Dictionary Programmatically” on page 61-52
- “Link Requirements to Simulink Data Dictionary Entries” (Simulink Verification and Validation)

## Migrate Models to Use Simulink Data Dictionary

A Simulink data dictionary permanently stores model data including MATLAB variables, data objects, and data types. For basic information about data dictionaries, see “What Is a Data Dictionary?” on page 61-2.

In this section...
“Migrate Single Model to Use Dictionary” on page 61-6
“Migrate Model Reference Hierarchy to Use Dictionary” on page 61-8
“Considerations before Migrating to Data Dictionary” on page 61-9

### Migrate Single Model to Use Dictionary

This example shows how to link a single standalone model to a single data dictionary.

---

**Note:** Simulink does not import simulation data such as Timeseries objects into the data dictionary.

---

- 1 Open the f14 model, which loads design data into the base workspace.
- 2 Save a copy of the model to your current folder. Open the copy.
- 3 In the Simulink Editor, click **File > Model Properties > Link to Data Dictionary**.
- 4 In the **Model Properties** dialog box, set **Defined in** to **Data Dictionary** and click **New** to create a data dictionary.

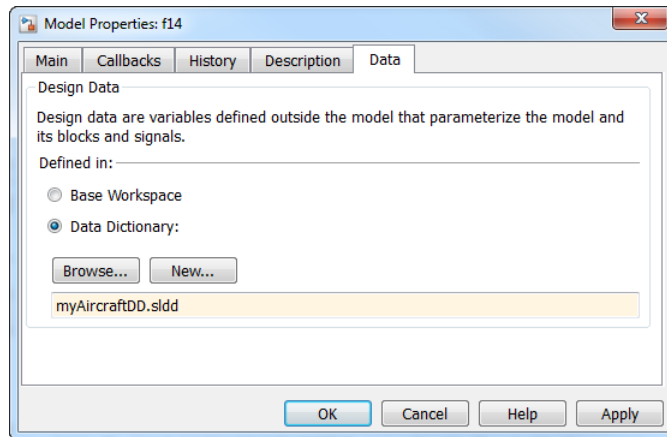

- 5 Name the data dictionary, save it, and click **Apply**.
- 6 Click **Add path**, if you see the message to add the dictionary location to the MATLAB path.
- 7 Click **Yes** in response to the message that explains how Simulink migrates design data stored in the base workspace.

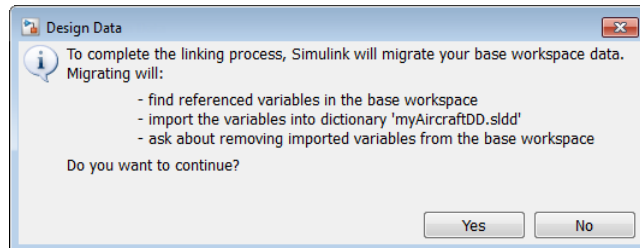

- 8 Click **Yes** in response to the message about removing imported items from the base workspace.
- 9 Click **OK** in the **Model Properties** dialog box.

A notification appears in the Simulink Editor, reporting that your model is now linked to the data dictionary.

- 10 In the Simulink Editor, click the data dictionary badge  in the bottom left corner to open the dictionary.

## Migrate Model Reference Hierarchy to Use Dictionary

This example shows how to link a parent model and all its referenced models to a single data dictionary.

- 1 Open the example model `sldemo_mdhref_datamngt`, which references the model `sldemo_mdhref_counter_datamngt`.
- 2 Save copies of the models to your current folder.
- 3 Open the top model, `sldemo_mdhref_datamngt`.
- 4 In the Simulink Editor, click **File > Model Properties > Link to Data Dictionary**.
- 5 In the **Model Properties** dialog box, set **Defined in** to **Data Dictionary** and click **New** to create a data dictionary.

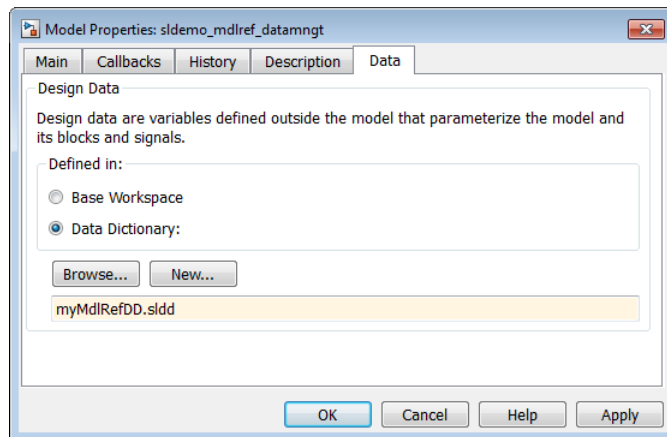

- 6 Name the data dictionary, save it, and click **Apply**.
- 7 Click **Yes** in response to the message that explains how Simulink migrates design data stored in the base workspace.

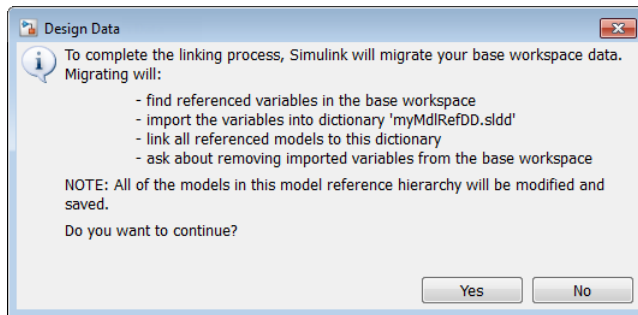

- 8 Click **Yes** in response to the message about removing the imported items from the base workspace.
- 9 Click **OK** in response to the message about migrating enumerated types.

## Considerations before Migrating to Data Dictionary

- “Check for Data-Loading Callbacks” on page 61-9
- “Check Scripts” on page 61-10
- “Check Tunable Parameters for Code Generation” on page 61-10
- “Data Shared by Model References” on page 61-11
- “Valid Design Data Classes” on page 61-11
- “Invalid Other Data Classes” on page 61-12
- “Migration With From Workspace Blocks” on page 61-12
- “Data Dictionary Limitations” on page 61-12

### Check for Data-Loading Callbacks

You can use model callbacks such as the `PreLoadFcn` callback to load design data from a file into the base workspace when a model is loaded. For example, the following callback loads design data from the MAT file `myData.mat`.

```
load myData
```

After you migrate to a data dictionary, these callbacks will continue to load design data into the base workspace. Since the model then derives design data from the dictionary, manually remove or comment out these data-loading callbacks.

You can use the Simulink Manifest Tools to find data-loading callbacks. See “Analyze Model Dependencies” on page 18-25.

## Check Scripts

If you make explicit references to the base workspace by using the handle `base` in your scripts, consider changing these references. When you move any of your data to a data dictionary, the model no longer looks into the base workspace to find design data.

After you migrate design data to a data dictionary, explicit references to the base workspace cannot resolve and errors can occur.

Consider this example. Here, the script searches the base workspace for variable `sensor` and sets the parameter `enable` depending on the value of `sensor.noiseEnable`.

```
if evalin('base','sensor.noiseEnable')
    enable = 'Enabled';
else
    enable = 'Disabled';
end
```

When you migrate to a data dictionary, replace these explicit references to `base` as follows:

```
if Simulink.data.evalinGlobal(myExampleModel,...
'sensor.noiseEnable')
    enable = 'Enabled';
else
    enable = 'Disabled';
end
```

The `Simulink.data.evalinGlobal` function evaluates an expression in the global scope of the specified model. Here, the global scope can be in a data dictionary or the base workspace, if the model is not linked to a dictionary.

## Check Tunable Parameters for Code Generation

- If your model is linked to a data dictionary, Simulink ignores storage class information specified in the Model Parameter Configuration dialog box.
- If you use the Simulink interface to migrate a model to use a data dictionary, Simulink also migrates the storage class information of the model. If your model contains storage class information for variables in the base workspace, Simulink converts these variables into `Simulink.Parameter` objects during migration. Then, Simulink sets the storage class of these `Simulink.Parameter` objects using the storage class information from the model.
- If you migrate this model back to the base workspace, Simulink does not restore the storage class information in the model. To preserve the storage class for these



variables, use the parameter objects from the data dictionary. You can also manually reset the storage class information in the model.

- If you set the `DataDictionary` property of a model from the command line, convert tunable variables to `Simulink.Parameter` objects using the `tunablevars2parameterobjects` function.

### Data Shared by Model References

When you use model referencing to break a large system of models into smaller components and subcomponents, you can create data dictionaries to segregate the *design data*. Design data is the set of workspace variables that the models use to specify block parameters and signal characteristics.

The models in a model reference hierarchy typically share data. Data ownership, the number of shared variables, and the complexity of your sharing strategy can influence the way that you use dictionaries. For more information, see “Determine Where to Store Variables and Objects for Simulink Models” on page 57-85.

### Valid Design Data Classes

You can import, store, or create MATLAB variables that use Simulink supported data types, such as `boolean` and `int32`, and structures in the **Design Data** section of a Simulink data dictionary. You can also use objects of these classes and objects of most classes that subclass these classes:

- `Simulink.AliasType`
- `Simulink.Bus`
- `Simulink.NumericType`
- `Simulink.Parameter`
- `Simulink.LookupTable`
- `Simulink.Breakpoint`
- `Simulink.Signal`
- `Simulink.Variant`
- `Simulink.data.dictionary.EnumTypeDefinition`
- `embedded.fi`
- `embedded.fimath`
- `numlti`

In addition, you can import, store, or create configuration objects of the following classes in the **Configurations** section of a Simulink data dictionary.

- `Simulink.ConfigSet`
- `Simulink.VariantConfigurationData`

### **Invalid Other Data Classes**

You can import, store, or create data objects of many built-in and custom classes or data types in the **Other Data** section of a Simulink data dictionary, except for the following:

- Arrays of objects created from built-in or custom classes
- Custom classes that have a property with any of these names:
  - `LastModified`
  - `LastModifiedBy`
  - `DataSource`
  - `Status`
  - `Variant`

### **Migration With From Workspace Blocks**

If a model contains a From Workspace block that refers to a variable in the base workspace, you can migrate the model to a data dictionary. However, the migration process takes different actions depending on the nature of the variable that the block refers to:

- If the value of the variable is not a `timeseries` object, the migration process imports the variable to the Design Data section of the data dictionary. The block can still refer to the variable.
- If the value of the variable is a `timeseries` object (which a data dictionary cannot store), the migration process does not import the variable. Then, when you try to update the diagram or simulate the model, the From Workspace block cannot find the variable and issues an error. In such a case, you can configure the block to refer to the base workspace variable by using the `evalin` function. See “Use With Data Dictionary”.

### **Data Dictionary Limitations**

- Simulink cannot automatically migrate variables used only by inactive variant models into a data dictionary.

- You cannot import certain kinds of design data such as `meta` class objects and `timeseries` objects into the Design Data section of a data dictionary.
- Simulink does not allow implicit signal resolution for a model linked to a data dictionary. To use a data dictionary, set the model configuration parameter **Signal resolution** to `Explicit only` or `None`.
- If a model reference hierarchy is already linked to a data dictionary, you can protect a referenced model that is part of the hierarchy. However, if you migrate a model reference hierarchy that includes a protected model, simulation will fail.

In other words, migrate a model to use a data dictionary before protecting it.

## See Also

“Protected Model” on page 8-90 | From Workspace

## Related Examples

- “Import and Export Dictionary Data” on page 61-20
- “View and Revert Changes to Dictionary Data” on page 61-27
- “Partition Data for Model Reference Hierarchy Using Data Dictionaries” on page 61-37
- “Programmatically Migrate Single Model to Use Dictionary” on page 61-57
- “Determine Where to Store Variables and Objects for Simulink Models” on page 57-85
- “Analyze Model Dependencies” on page 18-25

## Enumerations in Data Dictionary

A Simulink data dictionary permanently stores model data including MATLAB variables, data objects, and data types including enumerated types. For basic information about data dictionaries, see “What Is a Data Dictionary?” on page 61-2.

### In this section...

“Migrate Enumerated Types into Data Dictionary” on page 61-14

“Manipulate Enumerations in Data Dictionary” on page 61-18

## Migrate Enumerated Types into Data Dictionary

This example shows how to migrate enumerated types that are used by a model into a data dictionary.

### Import Design Data

- 1 Open a model that uses enumerated types for design data or for blocks in the model.
- 2 In the Simulink Editor, click **File > Model Properties > Link to Data Dictionary**.
- 3 In the **Model Properties** dialog box, set **Defined in** to **Data Dictionary** and click **New** to create a data dictionary.

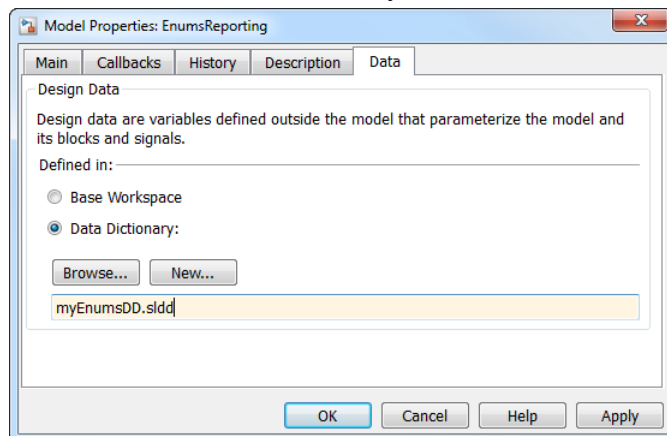

- 4 Name the data dictionary, save it, and click **Apply**.
- 5 Click **Add path**, if you see the message to add the dictionary location to the MATLAB path.

- Click **Yes** in response to the message that explains how Simulink migrates design data stored in the base workspace.

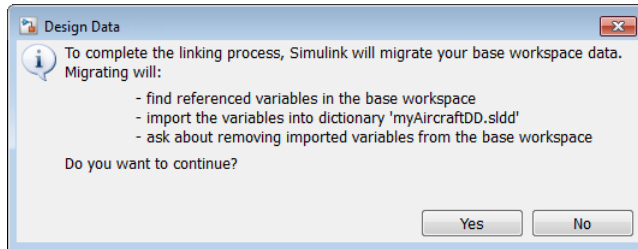

A message appears, reporting the number of items imported from the base workspace to the data dictionary.

- Simulink reports the enumerated types that were not imported into the data dictionary.

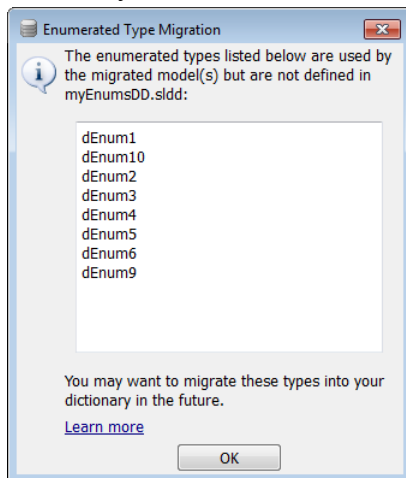

- Click **OK**.

A notification appears in the Simulink Editor, reporting that your model is now linked to the data dictionary.

### Import Enumerated Types

Import the definitions of enumerated types only after you import all the design data that were creating using the types. When you import enumerated types to a data dictionary,

Simulink disables MATLAB files or P-files that contain the type definitions, causing variables that remain in the MATLAB base workspace to lose their definitions.

- 1 At the MATLAB command prompt, get the names of enumerated types that are used in model blocks.

```
% Find all variables and enumerated types used in model blocks
usedTypesVars = Simulink.findVars('EnumsReporting','IncludeEnumTypes',true);
% Here, EnumsReporting is the name of the model and
% usedTypesVars is an array of Simulink.VariableUsage objects

% Find indices of enumerated types that are defined by MATLAB files or P-files
enumTypesFile = strcmp({usedTypesVars.SourceType},'MATLAB file');

% Find indices of enumerated types that are defined using the function
% Simulink.defineIntEnumType
enumTypesDynamic = strcmp({usedTypesVars.SourceType},'dynamic class');

% In one array, represent indices of both kinds of enumerated types
enumTypesIndex = enumTypesFile | enumTypesDynamic;

% Use logical indexing to return the names of used enumerated types
enumTypeNames = {usedTypesVars(enumTypesIndex).Name}'

enumTypeNames =

    'dEnum1'
    'dEnum10'
    'dEnum2'
    'dEnum3'
    'dEnum4'
    'dEnum5'
    'dEnum6'
    'dEnum9'
```

- 2 Open the data dictionary, and represent it with a `Simulink.data.Dictionary` object.

```
ddConnection = Simulink.data.dictionary.open('myEnumsDD.sidd')

ddConnection =

    Dictionary with properties:

        DataSources: {0x1 cell}
```

```

    HasUnsavedChanges: 0
    NumberOfEntries: 3

```

**3** Import the enumerated types that are used by blocks in the model.

```

[successfulMigrations, unsuccessfulMigrations] = ...
importEnumTypes(ddConnection,enumTypeNames)

```

```

successfulMigrations =

```

```

1x6 struct array with fields:

```

```

    className
    renamedFiles

```

```

unsuccessfulMigrations =

```

```

1x2 struct array with fields:

```

```

    className
    reasons

```

When enumerated types are imported, `importEnumTypes` renames the enumerated class definition file by appending `.save` to the file name. For example, if the original enumerated class definition is named `Enum1.m`, Simulink renamed the file as `Enum1.m.save`.

The structure `unsuccessfulMigrations` reports enumerated types that are not be migrated. In this example, two enumerated type instances are defined in the model workspace and can be imported after closing the model. Close the model to import these enumerated types.

**4** Open the dictionary to view the migrated enumerated types.

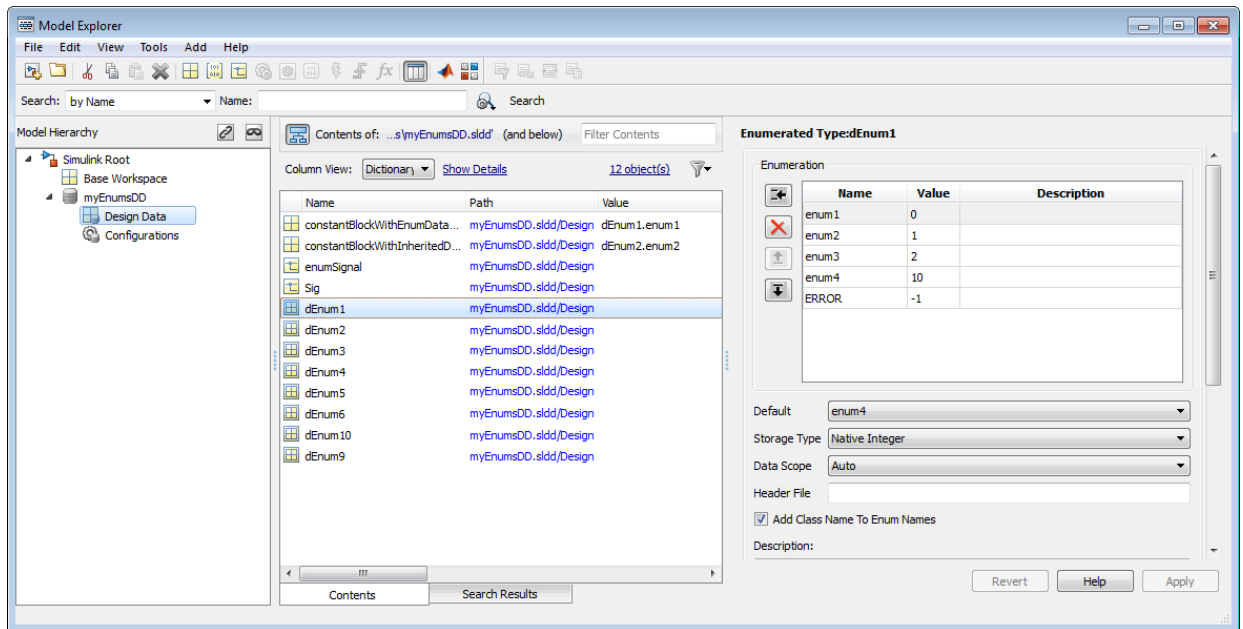

## Manipulate Enumerations in Data Dictionary

These examples show how to operate on existing enumerations in a data dictionary.

- “Rename Enumerated Type Definition” on page 61-18
- “Rename Enumeration Members” on page 61-19
- “Delete Enumeration Members” on page 61-19
- “Change Underlying Value of Enumeration Member” on page 61-19

### Rename Enumerated Type Definition

- 1 In the data dictionary, create a copy of the enumerated type, and rename the copy instead.
- 2 Find enumeration objects used by your model that are derived from the type with the old name.
- 3 Replace these objects with those derived from the renamed type.
- 4 Delete the type with the old name.



### **Rename Enumeration Members**

Use one of the following approaches.

- Select the enumeration within the dictionary, and rename one or more enumeration members.
- If your model references enumeration members, change these references to match the renamed member.

### **Delete Enumeration Members**

- 1 Find references in your model to an enumeration member you want to delete.
- 2 Replace these references with an alternate member.
- 3 Delete the original member from the enumeration.

### **Change Underlying Value of Enumeration Member**

You can change the values of enumeration members when you represent these values as MATLAB variables or by using **Value** field of **Simulink.Parameter** objects.

- 1 Find references in your model to an enumeration member whose value you want to change.
- 2 Make a note of these references.
- 3 Change the value of the enumeration member.
- 4 Manually update references to the enumeration member in your model.

### **See Also**

`Simulink.data.dictionary.EnumTypeDefinition`

### **Related Examples**

- “Use Enumerated Data in Simulink Models” on page 58-7
- “Simulink Enumerations” on page 58-2

## Import and Export Dictionary Data

A Simulink data dictionary permanently stores model data including MATLAB variables, data objects, and data types. For basic information about data dictionaries, see “What Is a Data Dictionary?” on page 61-2.

In this section...
“Import Data to Dictionary from File” on page 61-20
“Export Design Data from Dictionary” on page 61-25

### Import Data to Dictionary from File

You can import data from a MATLAB file or MAT-file to a data dictionary using the Model Explorer window. Import variables and data objects that are used by a model during simulation to the Design Data section of a dictionary. Import variables and objects that you want to store with a model, but that are not used by the model during simulation, to the Other Data section of a dictionary.

#### Import Design Data from File

This example shows how to import design data from a file into the Design Data section of a dictionary.

- 1 In the Simulink Editor, select **View > Model Explorer** to open the Model Explorer.
- 2 Click **File > Open**. Then browse to an existing dictionary.
- 3 In the **Model Hierarchy** pane, right-click the **Design Data** section of the dictionary and select **Import from File**. Then browse to and select the MAT-file or MATLAB file that contains the data to import.

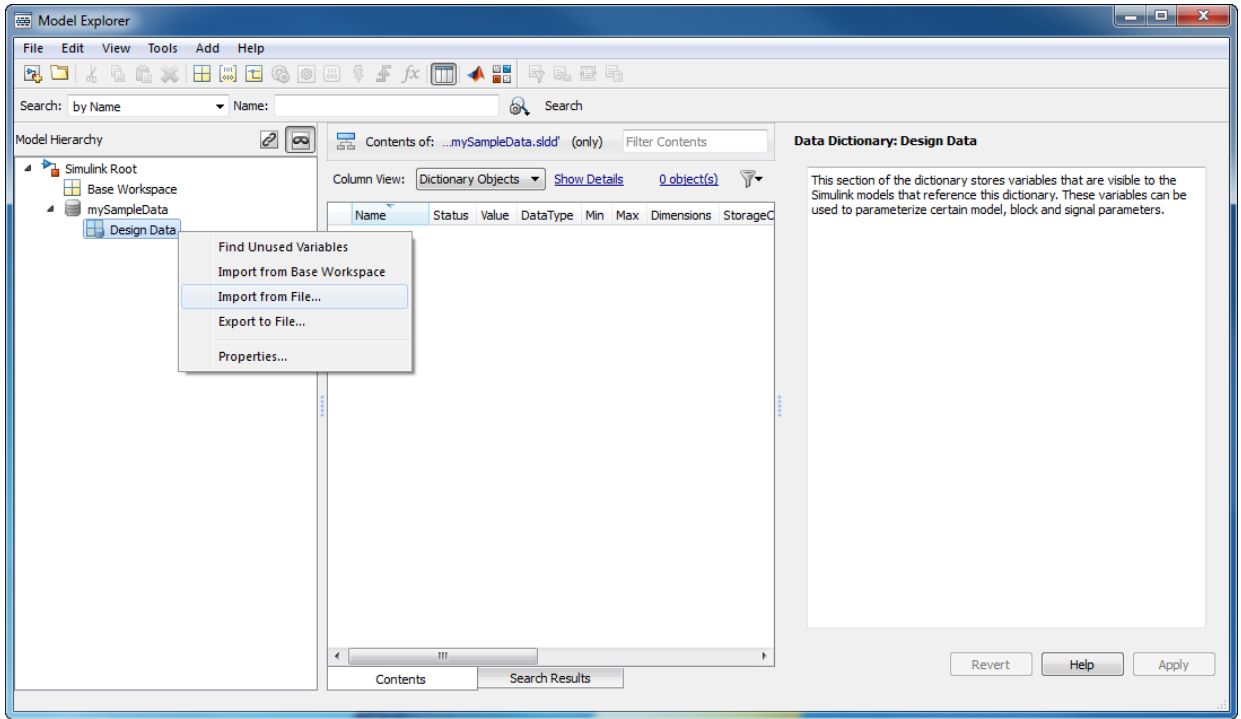

Design data from the MAT-file populate the dictionary. Data appear with **DataSource** set to the name of the dictionary.

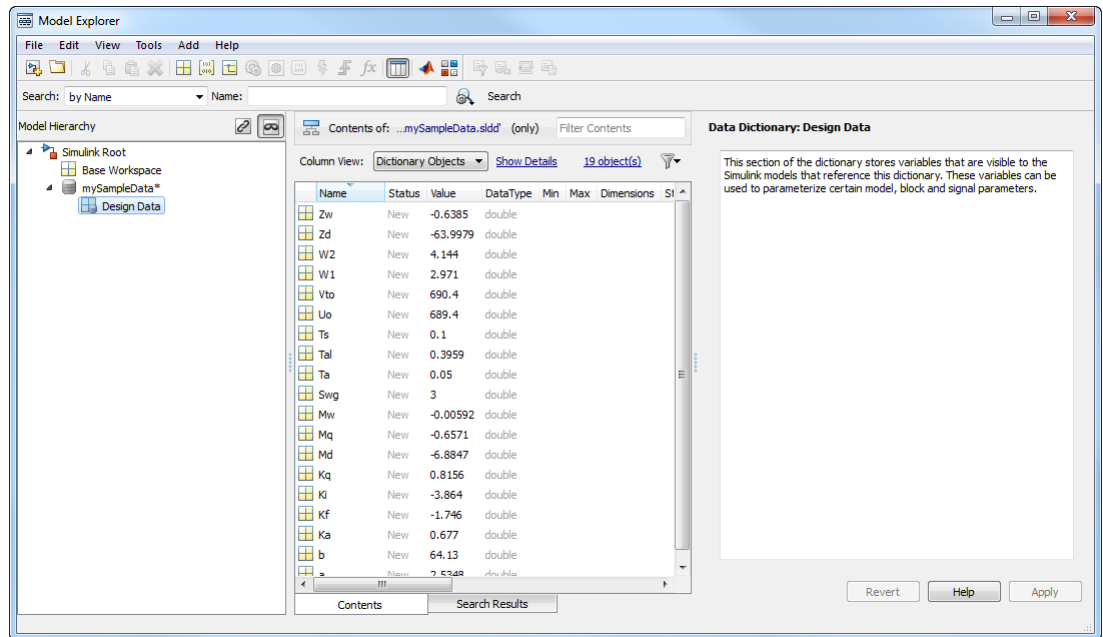

If you import from the same MAT-file again, Simulink only imports changed or new entries into the dictionary.

### Import Other Data from File

This example shows how to import data from a file into the Other Data section of a data dictionary. Use this section to store reference information that is not used by Simulink during simulation, such as data that describe physical equipment and processes that are represented by your model.

- 1 In the Simulink Editor, select **View > Model Explorer** to open the Model Explorer.
- 2 Click **File > Open**. Then browse to an existing dictionary.
- 3 In the **Model Hierarchy** pane, right-click the dictionary node and select **Show Empty Sections**. Model Explorer reveals the **Other Data** and **Configurations** sections of the dictionary, even if they are empty, in addition to the **Design Data** section.

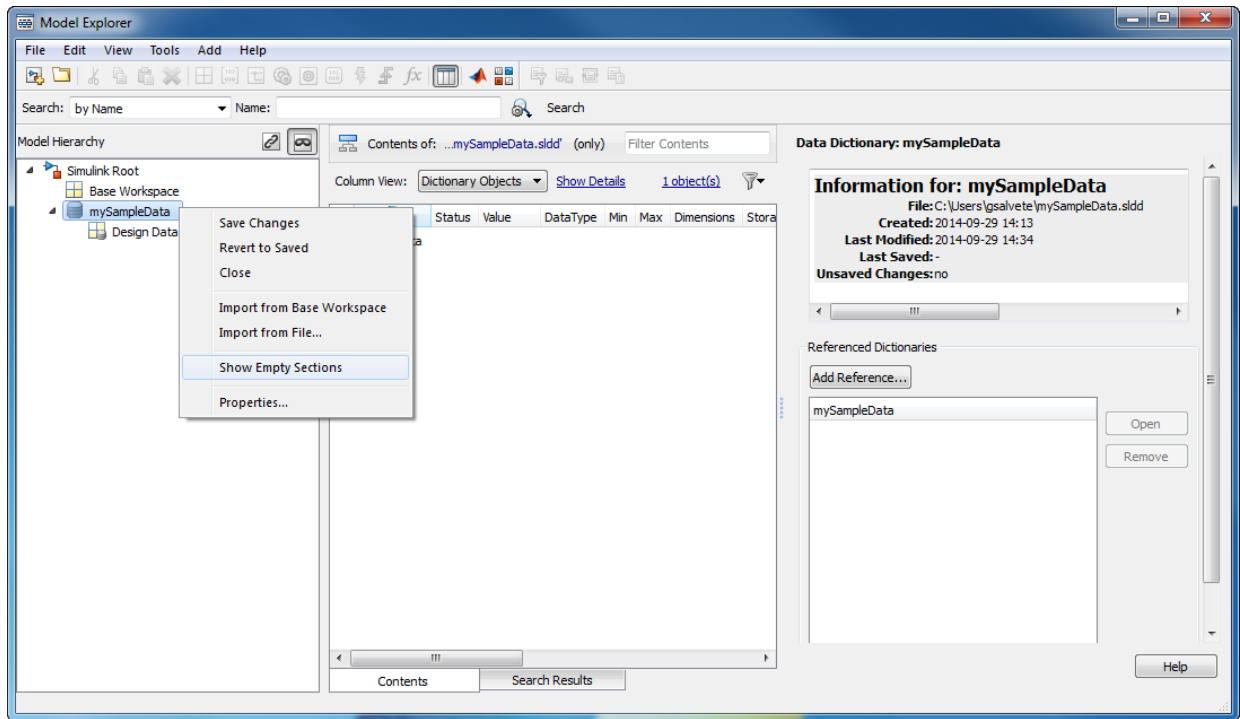

- 4 In the **Model Hierarchy** pane, right-click the **Other Data** section of the dictionary and select **Import from File**. Then browse to and select the MAT-file or MATLAB file that contains the reference data to import.

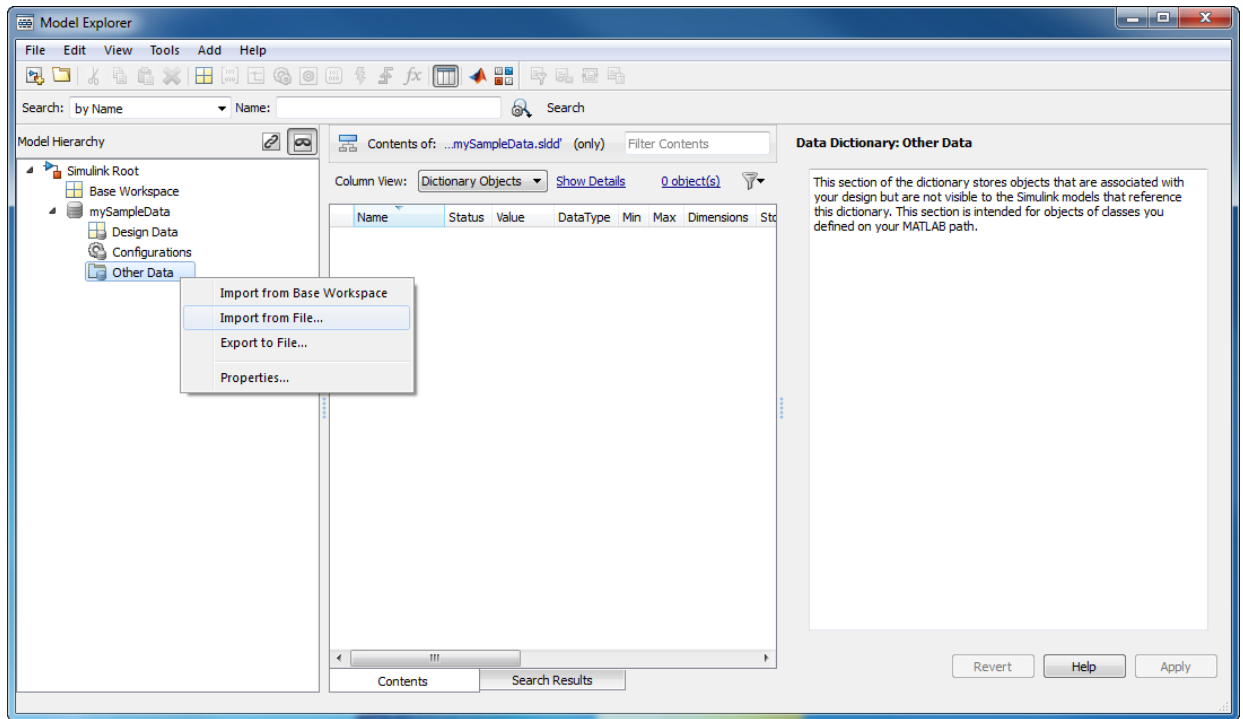

Data from the MAT-file populate the Other Data section of the dictionary. Data appear with **DataSource** set to the name of the dictionary.

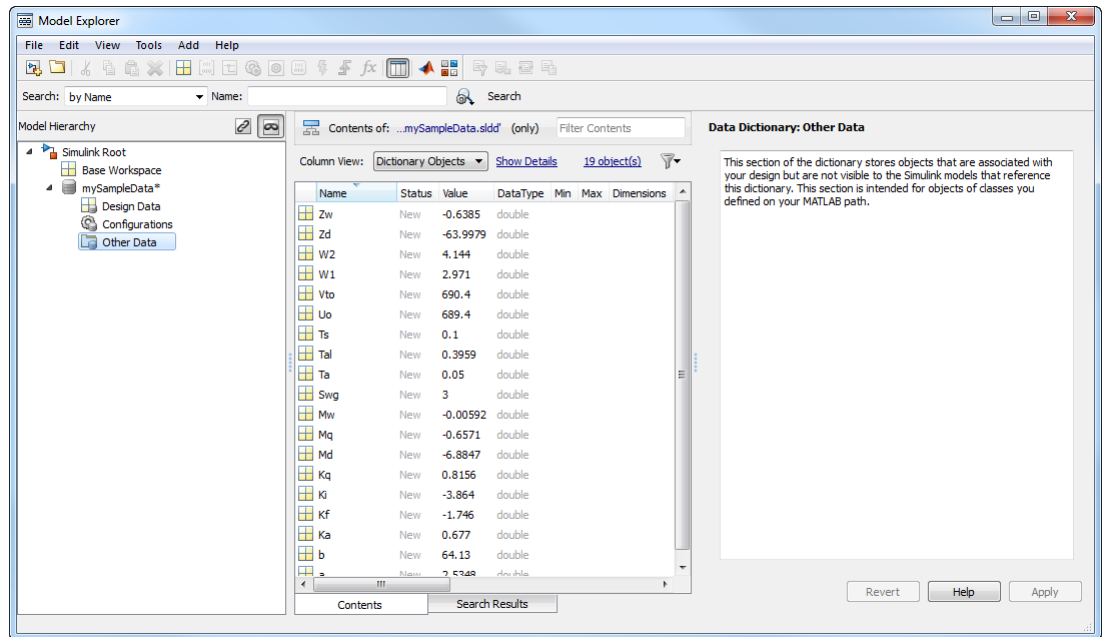

If you import from the same MAT-file again, Simulink only imports changed or new entries into the dictionary.

## Export Design Data from Dictionary

This example shows how to export model design data from a data dictionary into a MAT-file or MATLAB script.

- 1 In the Simulink Editor, select **View > Model Explorer** to open the Model Explorer.
- 2 Open a data dictionary using **File > Open Data Dictionary**.
- 3 In the **Model Hierarchy** pane, expand the dictionary node and select **Design Data > Export to File**. Then save the design data to a MAT-file or MATLAB script.

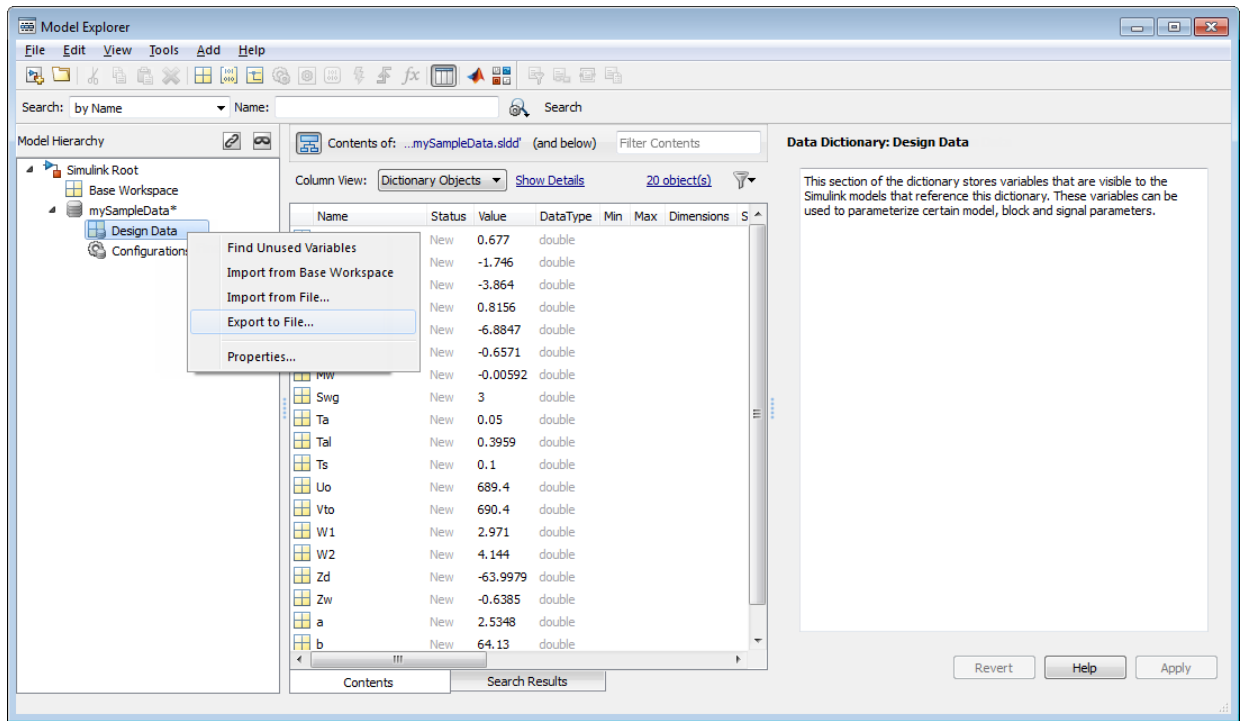

The dictionary does not export enumerated data types (which are stored as `Simulink.data.dictionary.EnumTypeDefinition` objects). To transfer or copy an enumerated type from one dictionary to another, use the Model Explorer to cut or copy and paste the object.

## Related Examples

- “View and Revert Changes to Dictionary Data” on page 61-27
- “Migrate Models to Use Simulink Data Dictionary” on page 61-6



## View and Revert Changes to Dictionary Data

A Simulink data dictionary permanently stores model data including MATLAB variables, data objects, and data types. For basic information about data dictionaries, see “What Is a Data Dictionary?” on page 61-2.

### In this section...

“View and Revert Changes to Dictionary Entries” on page 61-27

“View and Revert Changes to Entire Dictionary” on page 61-31

## View and Revert Changes to Dictionary Entries

This example shows how to view unsaved changes to dictionary entries, who made them, and when. You can view changes to entries in any section, including data stored in the Other Data section and configuration sets stored in the Configurations section.

- 1 Open the `sldemo_fuelsys_dd_controller` model.
- 2 Open the data dictionary linked to this model by clicking the data dictionary badge  in the bottom left corner of each model.

- 3 In the **Contents** pane, change `st_range` to `0.0002` and `zero_thresh` to `200`.

The **Status** column of these entries changes to **Mod**, indicating that they have been modified.

- 4 Click the heading of the **Status** column to sort the entries. Then, select the modified entries, which are indicated by the **Mod** status.

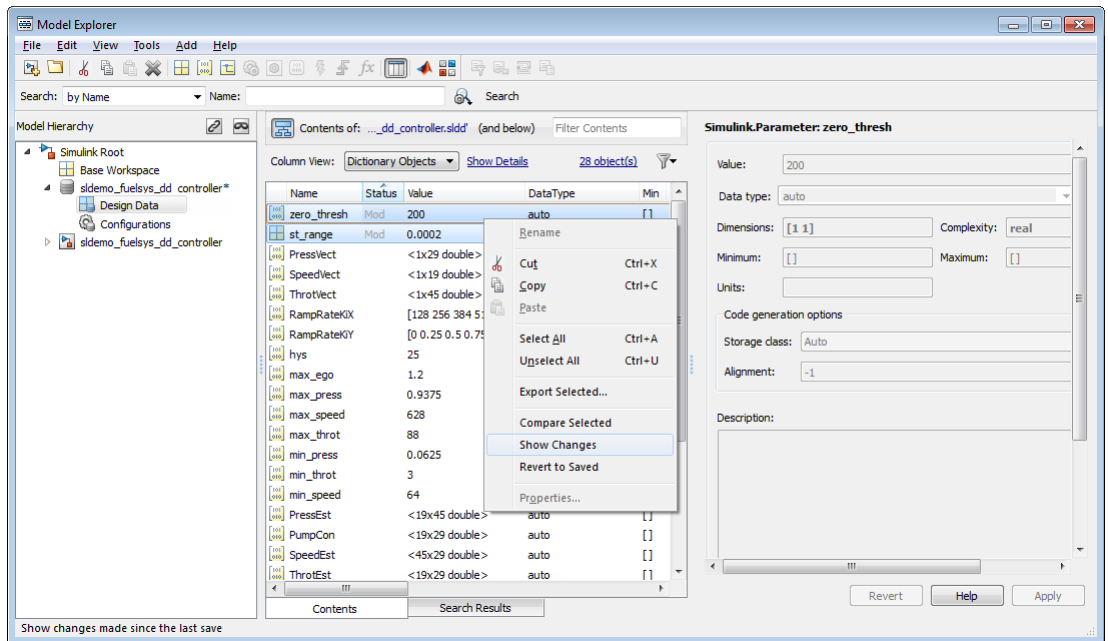

## 5 Right-click and select **Show Changes**.

The Comparison Tool appears, displaying changed entries in separate tabs. The tool highlights changed values.

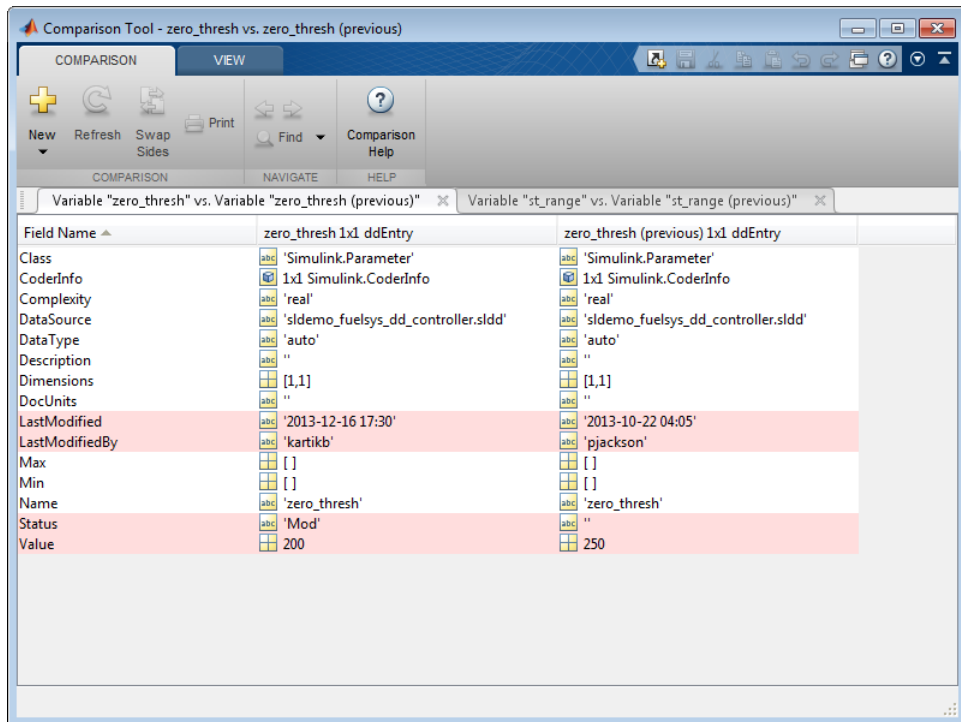

- 6 In the **Contents** pane of the Model Explorer, right-click `zero_thresh` and select **Revert to Saved**.

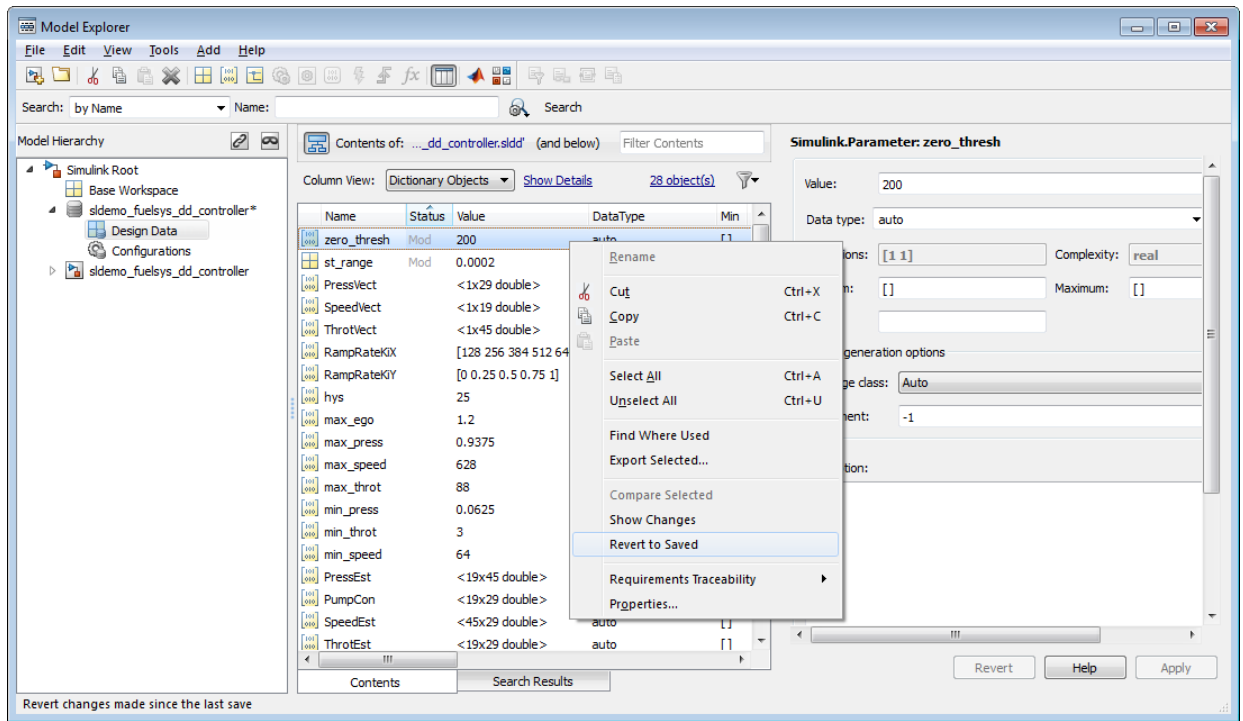

Simulink reverts `zero_thresh` to its value at the time of the last save action.

- 7 You can merge entries between dictionaries using the Comparison Tool. From the MATLAB desktop, on the **Home** tab, in the **File** section, click **Compare**.
- 8 Select the dictionaries to compare and merge.

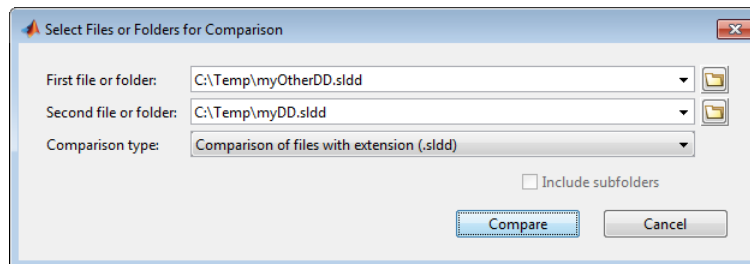

- 9 In the comparison report, select the merge direction for each dictionary entry.

Comparison - C:\Temp\myDD.sldd vs. C:\Temp\myOtherDD.sldd

COMPARISON VIEW

myDD.sldd vs. myOtherDD.sldd

### Dictionary File Comparison - myDD.sldd vs. myOtherDD.sldd

<b>Left file</b>	C:\Temp\myDD.sldd
<b>Right file</b>	C:\Temp\myOtherDD.sldd

Click on a column header to sort the table

Variables in myDD.sldd				Variables in myOtherDD.sldd				Change Summary	Merge (no undo)
Name	Scope	Size	Class	Name	Scope	Size	Class		
<a href="#">max_ego</a>	Design Data	1x1	Simulink.Parameter	<a href="#">max_ego</a>	Design Data	1x1	Simulink.Parameter	modified	
<a href="#">max_press</a>	Design Data	1x1	Simulink.Parameter	<a href="#">max_press</a>	Design Data	1x1	Simulink.Parameter	modified	
<a href="#">max_speed</a>	Design Data	1x1	Simulink.Parameter	<a href="#">max_speed</a>	Design Data	1x1	Simulink.Parameter	modified	
<a href="#">max_throt</a>	Design Data	1x1	Simulink.Parameter	<a href="#">max_throt</a>	Design Data	1x1	Simulink.Parameter	modified	
<a href="#">min_press</a>	Design Data	1x1	Simulink.Parameter	<a href="#">min_press</a>	Design Data	1x1	Simulink.Parameter	modified	
<a href="#">min_speed</a>	Design Data	1x1	Simulink.Parameter	<a href="#">min_speed</a>	Design Data	1x1	Simulink.Parameter	modified	
<a href="#">min_throt</a>	Design Data	1x1	Simulink.Parameter	<a href="#">min_throt</a>	Design Data	1x1	Simulink.Parameter	modified	
<a href="#">st_range</a>	Design Data	1x1	double	<a href="#">st_range</a>	Design Data	1x1	double	modified	
<a href="#">zero_thresh</a>	Design Data	1x1	Simulink.Parameter	<a href="#">zero_thresh</a>	Design Data	1x1	Simulink.Parameter	modified	

Dictionaries referenced by myDD.sldd		Dictionaries referenced by myOtherDD.sldd	
Name		Name	

Open C:\Temp\myDD.sldd

## View and Revert Changes to Entire Dictionary

If you store model variables in a data dictionary, you can view and manage the changes that you make while you work. You can use the Comparison Tool to see the changes made to a dictionary, which compares the modified dictionary with the most recent saved version.

When you view the changes to a dictionary, you can choose to discard changes to individual entries or dictionary references, which reverts to the last saved state. You can use this technique to recover entries that you delete in your modified version or dictionary references that you remove.

If you view changes to a dictionary that references other dictionaries, the Comparison Tool also reports changes made to the entries in the referenced dictionaries.

- 1 View the example data dictionary `sldemo_fuelsys_dd` in Model Explorer.

```
dictionary = Simulink.data.dictionary.open('sldemo_fuelsys_dd.sldd');
show(dictionary)
```

The dictionary contains entries that are defined in several referenced dictionaries, including `sldemo_fuelsys_dd_controller` and `sldemo_fuelsys_dd_plant`.

- 2 Run the script `ex_dictionary_changes`, which makes changes to `sldemo_fuelsys_dd`. Later, you can use the Comparison Tool to investigate the changes.
- 3 In the **Model Hierarchy** pane of Model Explorer, right-click the node `sldemo_fuelsys_dd` and select **Show Changes**.

The Comparison Tool displays the changes made to the dictionary.

sldemo\_fuelsys\_dd.sldd

### Show Changes in Dictionary - sldemo\_fuelsys\_dd.sldd

*Click on a column header to sort the table*

Saved Entries				Unsaved Changes				Change Summary	Last Modified	Action (no undo)
Name	Section	Data Source	Class	Name	Section	Data Source	Class			
<a href="#">PressVect</a>	Design Data	sldemo_fuelsys_dd_controller.sldd	Simulink Parameter					deleted	2013-10-22 04:05	<a href="#">Recover from Saved</a>
<a href="#">min_throt</a>	Design Data	sldemo_fuelsys_dd_controller.sldd	Simulink Parameter	<a href="#">min_throt</a>	Design Data	sldemo_fuelsys_dd_controller.sldd	Simulink Parameter	modified ( <a href="#">compare</a> )	2015-03-11 09:05	<a href="#">Revert to Saved</a>

Dictionary references in sldemo_fuelsys_dd.sldd			
Saved References		Unsaved Changes	
Name	Name	Change Summary	Action (no undo)
sldemo_fuelsys_dd_plant.sldd		removed	<a href="#">Recover Reference</a>

- 4 In the table at the top of the report, click **compare** in the Change Summary column of the row that corresponds to the entry `min_throt`.

A new tab shows the changes made to `min_throt`. The script changed the parameter data type from `auto` to `int8` and the parameter value from `3` to `4`.

- 5 Click the tab that shows the changes made to the dictionary. In the Action column of the row that corresponds to the entry `min_throt`, click **Revert to Saved**.

The entry reverts to the definition from the last saved version of the dictionary.

- 6 The remaining row in the report shows that the script deleted the entry `PressVect`, which was defined in the referenced dictionary `sldemo_fuelsys_dd_controller`. Click **Recover from Saved**, which recovers the entry in the referenced dictionary.

- 7 The table **Dictionary references in sldemo\_fuelsys\_dd.sldd** shows that the script removed the reference to the dictionary `sldemo_fuelsys_dd_plant`. In the Action column, click **Recover Reference**.

The report shows that there are no more unsaved changes to `sldemo_fuelsys_dd`.

### **Related Examples**

- “Compare Revisions” on page 19-44
- “Import and Export Dictionary Data” on page 61-20
- “Migrate Models to Use Simulink Data Dictionary” on page 61-6
- “What Is a Data Dictionary?” on page 61-2

## Partition Dictionary Data Using Referenced Dictionaries

This example shows how to partition a data dictionary into reference dictionaries that can be shared in a team. A Simulink data dictionary permanently stores model data including MATLAB variables, data objects, and data types.

### Open dictionary for partitioning

- 1 Open the Model Explorer. In the Simulink Editor, select **View > Model Explorer**.
- 2 Click **File > Open**.

Browse and locate your dictionary.

### Create reference dictionary

Use a reference dictionary to store a subset of entries from the main dictionary.

- 1 Click **File > New > Data Dictionary**.

Name the reference dictionary and save it.

Both dictionaries appear as nodes in the **Model Hierarchy** pane.

- 2 In the **Model Hierarchy** pane, select the dictionary that serves as the parent.
- 3 In the dialog box pane, in the **Referenced Dictionaries** section, click **Add Reference**. Browse to the location of the reference dictionary and add it as a reference.



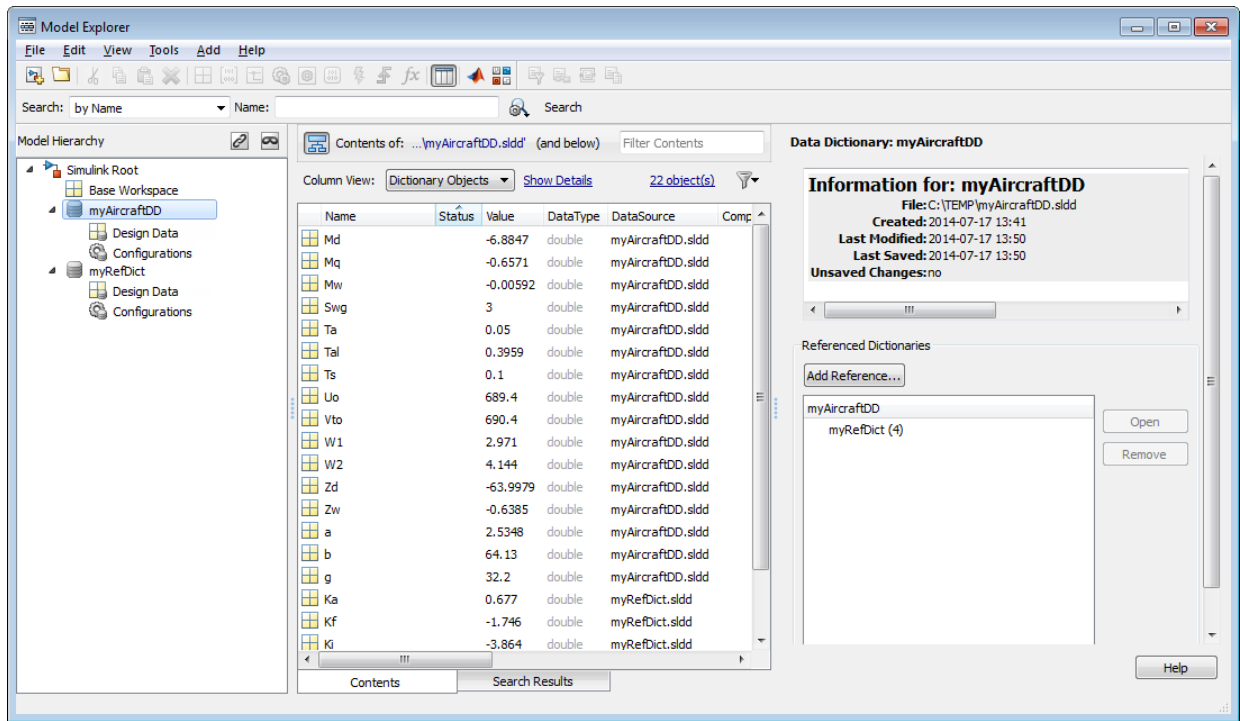

### Move entries into reference dictionary

- 1 In the **Model Hierarchy** pane, select the **Design Data** node of the parent dictionary.
- 2 In the **Contents** pane, select the entries you want to move to the reference dictionary.
- 3 For one of the selected entries, set **DataSource** to the reference dictionary using the dropdown menu. You can also drag and drop entries between dictionaries.

To make the **DataSource** column visible, click **Show Details** in the **Contents** pane. In the text box, enter **DataSource**, and add **DataSource** to the list of displayed columns.

### Organize display of entries

- 1 Click the name of the **DataSource** column to sort the entries by the dictionaries that define them.

- 2 Right-click the name of the **DataSource** column and select **Group by This Column** to group the entries. The **Contents** pane creates a group for each dictionary that defines the entries.

### **Related Examples**

- “Migrate Models to Use Simulink Data Dictionary” on page 61-6
- “Partition Data for Model Reference Hierarchy Using Data Dictionaries” on page 61-37
- “What Is a Data Dictionary?” on page 61-2

## Partition Data for Model Reference Hierarchy Using Data Dictionaries

When you use model referencing to break a large system of models into smaller components and subcomponents, you can create data dictionaries to segregate the *design data*. Design data is the set of workspace variables that the models use to specify block parameters and signal characteristics. For basic information about data dictionaries, see “What Is a Data Dictionary?” on page 61-2.

You can migrate all of the models in a model reference hierarchy to use one or more data dictionaries using either of these techniques:

- Migrate all of the models in the hierarchy at once to use a single dictionary. Then, create separate referenced dictionaries to organize the design data.
- Incrementally migrate by beginning with the models at the bottom of the hierarchy. Use this technique if you cannot migrate all of the models at once.

### Create a Dictionary for Each Component

This example shows how to partition design data into dictionaries. When you finish, each component and subcomponent in the system has a dictionary, and dictionary references allow the components and subcomponents to share data.

#### Explore Example Model Hierarchy

- 1 Navigate to the folder `matlabroot/help/toolbox/simulink/examples` (open).
- 2 Copy these files to a writable folder:
  - `ProjectData.mat`
  - `ex_SystemModel`
  - `ex_PlantComp_Lv11`
  - `ex_PlantComp_Lv12`
  - `ex_ContrComp`
  - `ex_ContrComp_Sub1_Lv11`
  - `ex_ContrComp_Sub1_Lv12`
  - `ex_ContrComp_Sub2_Lv11`
  - `ex_ContrComp_Sub2_Lv12`

- 3 Load the MAT-file `ProjectData.mat` to create design data in the base workspace.
- 4 Open the example model `ex_SystemModel`. This model is at the top of a reference hierarchy that includes the other example models.
- 5 Select **Analysis > Model Dependencies > Model Dependency Viewer > Models Only**. The model reference hierarchy contains a system model, a plant component with two models, and a controller component. The controller component contains two subcomponents, each of which consist of two models.

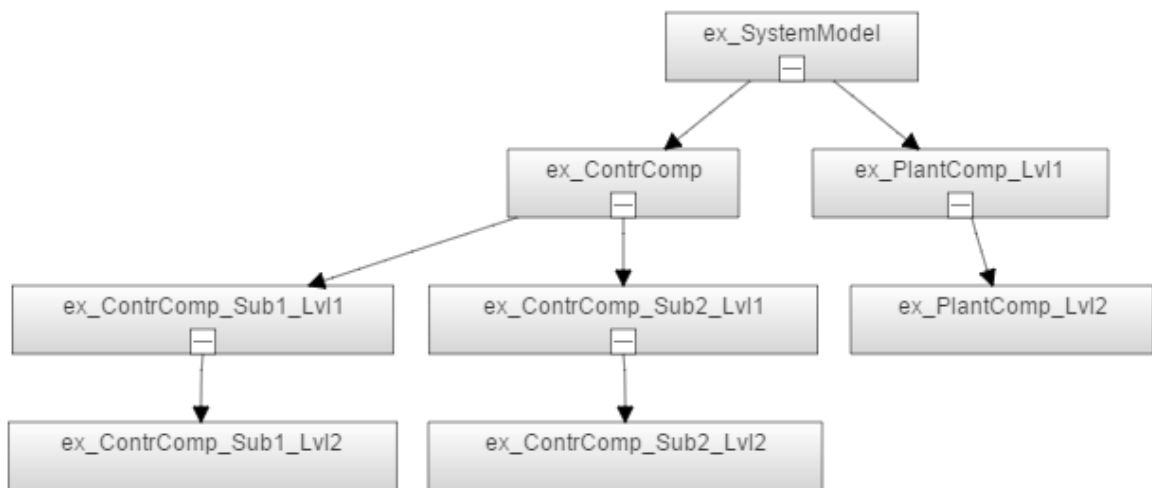

- 6 In the model, update the diagram. Each bus signal in the model uses a `Simulink.Bus` object as a data type. The objects, `SensorBus` and `CtrlBus`, are in the base workspace.

The referenced models `ex_PlantComp_Lvl1` and `ex_ContrComp` use the bus objects for root-level inputs and outputs, which means the plant and controller components share the objects.

- 7 In the base workspace, double-click the `Simulink.NumericType` object named `FloatType`. Signals, parameters, and other data items in the controller component use this shared data type.
- 8 In the Model Explorer **Model Hierarchy** pane, expand the node `ex_SystemModel`.

The node Reference to `SimConfigSet` appears. `SimConfigSet` is a `Simulink.ConfigSet` object in the base workspace. To maintain configuration

parameter uniformity for simulation, all of the models in the hierarchy refer to `SimConfigSet`.

- 9 Right-click the node `Controller (ex_ContrComp)` and select **Open**.
- 10 In the Model Explorer **Model Hierarchy** pane, expand the new node `ex_ContrComp`. Expand the node `Model (ex_ContrComp_Sub1_Lvl1)`.

The node `Reference to CodeGenConfigSet` appears. `CodeGenConfigSet` is a `Simulink.ConfigSet` object in the base workspace. To maintain configuration parameter uniformity for code generation, the models in the controller component refer to `CodeGenConfigSet`. The models in the plant component do not use `CodeGenConfigSet`.

- 11 In the **Model Hierarchy** pane, select **Base Workspace**. In the **Contents** pane, right-click the variable `diff` and select **Find Where Used**. In the **Select a system** dialog box, select `ex_SystemModel` and click **OK**. If you see a message about updating the diagram, click **OK**.

In the **Contents** pane, the variable `diff` is used by Constant blocks in the models `ex_ContrComp_Sub1_Lvl1` and `ex_ContrComp_Sub1_Lvl2`, which make up the first controller subcomponent. Similarly, other models in the hierarchy share the base workspace variables `coeff`, `init`, `mu`, and `rho`.

The table shows the models that share each variable in the base workspace.

Variable Name	Models Using the Variable	Scope of Sharing
<code>CtrlBus</code>	Top-level models in the plant and controller components	Shared globally by entire system
<code>SensorBus</code>	Top-level models in the plant and controller components	Shared globally by entire system
<code>SimConfigSet</code>	All models in the hierarchy	Shared globally by entire system
<code>rho</code>	<code>ex_PlantComp_Lvl2</code> , <code>ex_ContrComp_Sub1_Lvl2</code> and <code>ex_ContrComp_Sub2_Lvl2</code>	Shared globally by entire system
<code>mu</code>	<code>ex_PlantComp_Lvl1</code> and <code>ex_PlantComp_Lvl2</code>	Shared by models in the plant component

Variable Name	Models Using the Variable	Scope of Sharing
FloatType	All models in the controller component	Shared by controller component and subcomponents
CodeGenConfigSet	All models in the controller component	Shared by controller component and subcomponents
init	ex_ContrComp_Sub1_Lv12 and ex_ContrComp_Sub2_Lv11	Shared by controller subcomponents
diff	ex_ContrComp_Sub1_Lv11 and ex_ContrComp_Sub1_Lv12	Shared by models in the first controller subcomponent
coeff	ex_ContrComp_Sub2_Lv11 and ex_ContrComp_Sub2_Lv12	Shared by models in the second controller subcomponent

Suppose that three teams of developers maintain the plant component and the two controller subcomponents. You can use data dictionaries to store and scope the shared design data.

### Create System Dictionary

- 1 In the model `ex_SystemModel`, select **File > Model Properties > Link to Data Dictionary**.
- 2 In the dialog box, under **Defined in**, select **Data Dictionary**. Click **New**.
- 3 Set the new dictionary name to **System** and click **Save**.
- 4 In the **Model Properties** dialog box, click **OK**.
- 5 Click **Yes** in response to the message about migrating workspace data.
- 6 Click **Yes** in response to the message about removing imported items from the base workspace.
- 7 Save the model.

You can simulate and generate code from the models in the hierarchy. All of the models in the hierarchy are linked to the dictionary. All of the variables in the base workspace now reside in the new dictionary `System.sldd`.

### Create Dictionary for Plant Component

- 1 Open the model `ex_PlantComp_Lv11`.
- 2 Select **File > Model Properties > Link to Data Dictionary**.
- 3 In the dialog box, under **Defined in**, click **New**.
- 4 Set the new dictionary name to `Plant` and click **Save**.
- 5 In the **Model Properties** dialog box, click **OK**.
- 6 In response to the message, click **Move Data**.
- 7 Click **Yes** in response to the message about migrating data.
- 8 Save the model.

The models in the plant component, `ex_PlantComp_Lv11` and `ex_PlantComp_Lv12`, are linked to the new dictionary `Plant.sldd`. The other models in the hierarchy remain linked to `System.sldd`. Because the model `ex_PlantComp_Lv11` uses globally shared variables such as `CtrlBus` and `SensorBus`, the migration process moves these variables to `Plant.sldd`. However, `System.sldd` now references `Plant.sldd`, so all of the models in the hierarchy can continue to use the globally shared variables.

The variable that the plant models share, `mu`, also resides in `Plant.sldd`. Other variables that the controller models share, such as `init` and `diff`, remain in `System.sldd`.

The plant component can stand alone from the rest of the system because all of its data is in `Plant.sldd`. However, the controller component depends on the shared data that is also stored in `Plant.sldd`.

### Create Dictionary for Controller Component

Open the model `ex_ContrComp`, which is the top model in the controller component. Link this model to a new dictionary named `Contr.sldd`. Then, save the model.

When you finish, the five models in the controller component are linked to `Contr.sldd`. Because the globally shared variables such as `CtrlBus` and `SensorBus` still reside in the dictionary `Plant.sldd`, the dictionary `Contr.sldd` references `Plant.sldd`. Due to this reference, the models in the controller component can continue to use the globally shared variables.

The variables that the controller models share, such as `diff`, `init`, and `CodeGenConfigSet`, now reside in `Contr.sldd`.

### Create Dictionary for First Controller Subcomponent

Open the model `ex_ContrComp_Sub1_Lvl1`. Link this model to a new dictionary named `ContrSub1.sldd`. Then, save the model.

When you finish, the models in the first controller subcomponent, `ex_ContrComp_Sub1_Lvl1` and `ex_ContrComp_Sub1_Lvl2`, are linked to `ContrSub1.sldd`. The models in the second subcomponent remain linked to the dictionary `Contr.sldd`.

### Create Dictionary for Second Controller Subcomponent

Open the model `ex_ContrComp_Sub2_Lvl1`. Link this model to a new dictionary named `ContrSub2.sldd`. Then, save the model.

The controller dictionary `Contr.sldd` references the subcomponent dictionaries, `ContrSub1.sldd` and `ContrSub2.sldd`. Therefore, the controller dictionary and the top model in the controller component (`ex_ContrComp`) can use all of the data defined in these subcomponent dictionaries.

The first subcomponent dictionary, `ContrSub1.sldd`, defines data that the subcomponents share, such as `CodeGenConfigSet`. The second subcomponent dictionary, `ContrSub2.sldd`, references `ContrSub1.sldd` so that the models in the second subcomponent can use this shared data.

The subcomponent dictionaries `ContrSub1.sldd` and `ContrSub2.sldd` reference `Plant.sldd`. Therefore, all of the models in the hierarchy can continue to use globally shared variables such as `SensorBus` and `SimConfigSet`, which are stored in `Plant.sldd`.

### Inspect Data Storage

In the Model Explorer **Model Hierarchy** pane, select the dictionary node `System`. In the **Contents** pane, to view the contents of `System.sldd`, click the **Show Current System**

**and Below** button . The contents of the Design Data and Configurations sections appear.



Column View: Dictionary Objects [Show Details](#) 12 object(s)

Name	DataType	Argument	Variant	Status	Description	DataTypeMode	DataSource
FloatType						Single	ContrSub1.slidd
diff	FloatType						ContrSub1.slidd
init	FloatType						ContrSub1.slidd
CodeGenConfigSet							ContrSub1.slidd
coeff	FloatType						ContrSub2.slidd
CtrlBus							Plant.slidd
SensorBus							Plant.slidd
mu	auto						Plant.slidd
rho	auto						Plant.slidd
SimConfigSet							Plant.slidd

The **DataSource** column shows the variables and objects that each dictionary stores.

All of the globally shared variables, such as **CtrlBus** and **SensorBus**, reside in **Plant.slidd**. The variable **init**, which both of the controller subcomponents share, resides in **ContrSub1.slidd**. Due to dictionary references created by the migration process, the components and subcomponents can still share these variables.

If the development teams assigned to the controller component must make changes to the globally shared variables, they must access the plant dictionary file. Similarly, if the team assigned to the second controller subcomponent must make changes to the variable **init**, they must access the first subcomponent dictionary file.

### Optimize Data Sharing Using Reference Dictionaries

To share global variables such as **CtrlBus**, and **SensorBus** by clearly defining variable scope, you can create a reference dictionary. Add the new dictionary as a reference to all of the component and subcomponent dictionaries that require the shared data.

- 1 Close all of the models that you have open.
 

```
bdclose all
```
- 2 In Model Explorer, select **File > New > Data Dictionary**.
- 3 Set the new dictionary name to **GlobalShare** and click **Save**.

- 4 In the **Model Hierarchy** pane, select the node `ContrSub2`. In the Dialog pane, click **Add Reference**.
- 5 Double-click `GlobalShare.sldd`.
- 6 In the **Model Hierarchy** pane, right-click the node `ContrSub2` and select **Save Changes**.
- 7 Add `GlobalShare.sldd` as a reference to the dictionaries `ContrSub1.sldd` and `Plant.sldd`. Save each dictionary after you add the reference.
- 8 In the **Model Hierarchy** pane, select the node `System`.
- 9 In the **Contents** pane, select the globally shared variables:
  - `CtrlBus`
  - `SensorBus`
  - `SimConfigSet`
  - `rho`
- 10 In the **DataSource** column, select `GlobalShare.sldd` for any of the selected variables.

All of the variables move from `Plant.sldd` to `GlobalShare.sldd`.
- 11 Save changes to the dictionary `System.sldd`.

Now, if any of the three development teams need to make changes to the globally shared variables such as `SimConfigSet` and `CtrlBus`, they can access the dictionary `GlobalShare.sldd`. This dictionary contains only the variables that all of the models in the system share. Because the component and subcomponent dictionaries `Plant.sldd`, `ContrSub1.sldd`, and `ContrSub2.sldd` all reference the globally shared dictionary `GlobalShare.sldd`, all of the models in the hierarchy can use the data.

To further partition and scope the shared data, create another reference dictionary to contain the variables that the controller subcomponents share.

- 1 In Model Explorer, select **File > New > Data Dictionary**.
- 2 Set the new dictionary name to `ContrShare` and click **Save**.
- 3 In the **Model Hierarchy** pane, select the dictionary node `ContrSub2`. In the Dialog pane, select **Add Reference**.
- 4 In the dialog box, double-click `ContrShare.sldd`.
- 5 In the **Model Hierarchy** pane, right-click the node `ContrSub2` and select **Save Changes**.

- 6 Add `ContrShare.sldd` as a reference to `ContrSub1.sldd` and save the dictionary `ContrSub1.sldd`.
- 7 Add `GlobalShare.sldd` as a reference to `ContrShare.sldd` and save the dictionary `ContrShare.sldd`.
- 8 In the **Model Hierarchy** pane, select the node `System`.
- 9 In the **Contents** pane, select these variables:
  - `CodeGenConfigSet`
  - `init`
  - `FloatType`
- 10 In the **DataSource** column, select `ContrShare.sldd` for any of the selected variables.

All of the selected variables move from `ContrSub1.sldd` to `ContrShare.sldd`.
- 11 Save changes to the dictionary `System.sldd`.

To further optimize the dictionary hierarchy, remove the unnecessary references that the migration process created. Also, remove the unnecessary references that you created from `ContrSub1.sldd` and `ContrSub2.sldd` to `GlobalShare.sldd`. Because `ContrShare.sldd` references `GlobalShare.sldd`, the controller subcomponent dictionaries can use the data in `GlobalShare.sldd` without directly referencing `GlobalShare.sldd`.

- 1 In the Model Explorer **Model Hierarchy** pane, select the dictionary node `Contr`. In the Dialog pane, in the **Referenced Dictionaries** list, select `Plant` and click **Remove**. Save the change to `Contr.sldd`.
- 2 Remove the references to `GlobalShare.sldd` and `Plant.sldd` from `ContrSub1.sldd`. Save the changes to `ContrSub1.sldd`.
- 3 Remove the references to `GlobalShare.sldd`, `Plant.sldd`, and `ContrSub1.sldd` from `ContrSub2.sldd`. Save the changes to `ContrSub2.sldd`.

### Inspect Dictionary Hierarchy

To view the entire dictionary and model hierarchy, you can perform a dependency analysis in a Simulink project.

- 1 Open your saved model `ex_SystemModel`. Select **File > Simulink Project > Create Project from Model**.

- 2 Specify a name for the project in the **Project name** box. Click **Create**.
- 3 In the Simulink Project, click **Dependency Analysis**. Click **Analyze**.

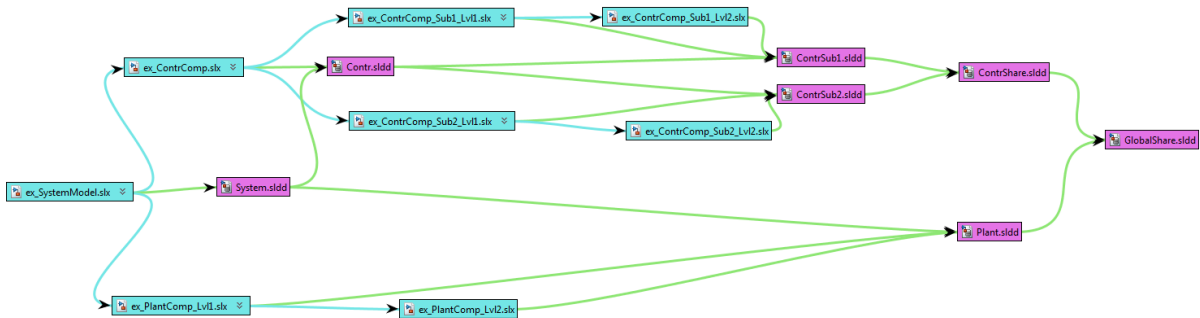

The system model, `ex_SystemModel`, is linked to the dictionary `System.sldd`. The plant component, the controller component, and the controller subcomponents are each linked to a separate dictionary. These dictionaries form a reference hierarchy. To access the shared data, the component and subcomponent dictionaries reference the dictionaries `ContrShare.sldd` and `GlobalShare.sldd`.

To inspect the data in the dictionaries, use Model Explorer.

- 1 In your saved model `ex_SystemModel`, click the data dictionary badge .
- 2 In the Model Explorer **Contents** pane, click the column name **DataSource** to sort the design data. The dictionaries in the hierarchy partition the variables based on the shared scope of each variable.

You can also right-click the column name and select **Group by This Column** to group the entries by the dictionaries that define them.

- 3 In the **Model Hierarchy** pane, under the node `System`, click the node `Configurations`. In the **Contents** pane, the `Simulink.ConfigSet` object `CodeGenConfigSet` is stored in the shared dictionary for the controller component. `SimConfigSet` is stored in the globally shared dictionary.

### Strategies to Discover Shared Data

To learn how the models in a model reference hierarchy share data, use these techniques:

- In an open model, select **Edit > Find Referenced Variables**. The Model Explorer displays the variables that the model uses, as well as the variables that referenced

models use. You can then right-click a variable and select **Find Where Used** to display all of the models that use the variable. For more information, see “Edit and Manage Workspace Variables Used by Models” on page 57-92.

- At the command prompt, use the function `Simulink.findVars` to determine the variables a model uses. You can then use the function `intersect` to determine the variables two models, components, or subcomponents share.

## Migrate Model Hierarchy to Dictionaries Incrementally

If you cannot migrate all of the models in a model reference hierarchy to a single dictionary at once, you can migrate an individual model, component, or subcomponent at the bottom of the hierarchy. Over time, you can migrate the entire hierarchy.

If you want to simulate and generate code from the hierarchy after you migrate each component, the components that you migrate cannot share any design data with other models in the hierarchy. In the example “Create a Dictionary for Each Component” on page 61-37, the components and subcomponents of a model reference hierarchy share data in the base workspace, such as `Simulink.Bus` and `Simulink.Parameter` objects. Due to these dependencies, if you migrate the hierarchy incrementally from the bottom, you cannot simulate or generate code from the hierarchy until you migrate all of the models.

Similarly, if you use configuration set references to maintain configuration parameter uniformity throughout the hierarchy, the component that you choose to migrate cannot share a configuration set with other models in the hierarchy. To permit simulation and code generation after you migrate the component, you must eliminate the dependency that the component has on the shared configuration set.

For example, when you migrate the component, copy the shared configuration set from the base workspace into the new dictionary. Then, rename the configuration set in the data dictionary, and set all of the models in the migrated component to use this renamed configuration set. The models in the migrated component use the configuration set in the data dictionary, while the rest of the models in the hierarchy use the configuration set in the base workspace. As you migrate additional components, set the models in each component to use the configuration set in the data dictionary.

If you choose to migrate a model reference hierarchy incrementally by using this technique, you must begin with the models or components at the bottom of the hierarchy. In the example “Create a Dictionary for Each Component” on page 61-37, a

controller model references two subcomponents, each of which contains two models. You cannot migrate the controller model before you migrate the models in the controller subcomponents.

### Explore Example Model Hierarchy

- 1 Navigate to the folder `matlabroot/help/toolbox/simulink/examples` (open).
- 2 Copy these files to a writable folder:
  - `ProjectData_ind.mat`
  - `ex_SystemModel_ind`
  - `ex_Plant_L1_ind`
  - `ex_Plant_L2_ind`
  - `ex_Contr_L1_ind`
  - `ex_Contr_L2_ind`
- 3 Load the MAT-file `ProjectData_ind.mat` to create design data in the base workspace.
- 4 Open the example model `ex_SystemModel_ind`. This model is at the top of a reference hierarchy that includes the other example models.
- 5 Select **Analysis > Model Dependencies > Model Dependency Viewer > Models Only**. The model reference hierarchy contains a system model, a plant component with two models, and a controller component with two models.

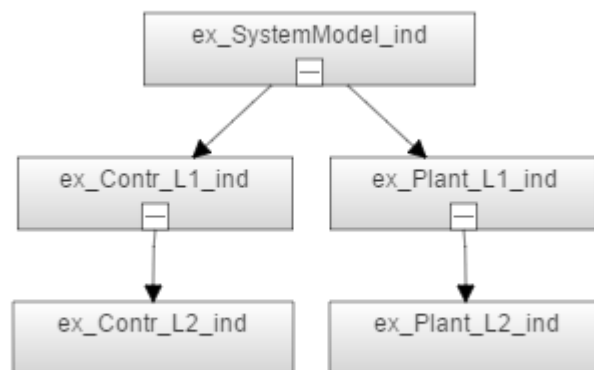

- 6 In the Model Explorer **Model Hierarchy** pane, select **Base Workspace**. In the **Contents** pane, right-click the variable `diff` and select **Find Where Used**. In the **Select a system** dialog box, select `ex_SystemModel_ind` and click **OK**. If you see a message about updating the diagram, click **OK**.

In the **Contents** pane, the variable `diff` is used by Constant blocks in the models `ex_Contr_L1_ind` and `ex_Contr_L2_ind`, which make up the controller component. Similarly, other models in the hierarchy share the base workspace variable `mu`.

The table shows the models that share each workspace variable.

Variable Name	Models Using the Variable	Scope of Sharing
<code>diff</code>	<code>ex_ContrComp_Lv11</code> and <code>ex_ContrComp_Lv12</code>	Shared by models in the controller component
<code>mu</code>	<code>ex_PlantComp_Lv11</code> and <code>ex_PlantComp_Lv12</code>	Shared by models in plant component

Suppose that two teams of developers maintain the plant component and the controller component. You can use data dictionaries to store and scope the design data. The teams can incrementally migrate the components to use data dictionaries.

### Create Data Dictionary for Controller Component

Suppose that only the controller component team is ready to migrate their models to a data dictionary. You can independently migrate these two models.

- 1 Open the example model `ex_Contr_L1_ind`. This model is at the top of the controller component.
- 2 Select **File > Model Properties > Link to Data Dictionary**.
- 3 In the dialog box, under **Defined in**, select **Data Dictionary** and click **New**.
- 4 Set the new dictionary name to `Contr` and click **Save**.
- 5 In the **Model Properties** dialog box, click **OK**.
- 6 Click **Yes** in response to the message about migrating workspace data.
- 7 Click **Yes** in response to the message about removing imported items from the base workspace.
- 8 Save the model.

You can simulate and generate code from the model hierarchy. The models in the controller component use the data in the dictionary `Contr`, which contains the variable `diff`. The other models in the hierarchy continue to use the data in the base workspace.

### Create Data Dictionary for Plant Component

Open the example model `ex_Plant_L1_ind`. Link this model to a new data dictionary `Plant.sldd`. After you link the model to the new dictionary, save the model.

The migration process moves the variable `mu` into the new dictionary.

### Create Data Dictionary for System Model

Open the example model `ex_SystemModel_ind`. Link this model to a new data dictionary `System.sldd`. After you link the model to the new dictionary, save the model.

The migration process causes the new dictionary, `System.sldd`, to reference the other dictionaries that you created.

### Inspect Dictionary Hierarchy

Each of the components has a data dictionary. To view the entire dictionary and model hierarchy, you can perform a dependency analysis in a Simulink project.

- 1 In your saved model `ex_SystemModel_ind`, select **File > Simulink Project > Create Project from Model**.
- 2 Specify a name for the project in the **Project name** box. Click **Create**.
- 3 In the Simulink Project, click **Dependency Analysis**. Click **Analyze**.

Each team's models are linked to the appropriate dictionaries. The system dictionary references the component dictionaries.

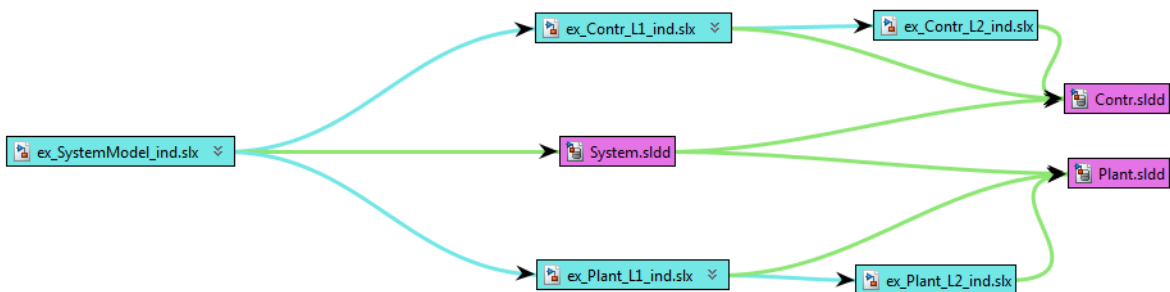



To inspect the data in the dictionaries, use the Model Explorer.

- 1 In your saved model `ex_SystemModel_ind`, click the data dictionary badge .
- 2 In the Model Explorer **Contents** pane, the data source for each entry is the dictionary for the appropriate component.

## Related Examples

- “Determine Where to Store Variables and Objects for Simulink Models” on page 57-85
- “Using a Data Dictionary to Manage the Data for a Fuel Control System”
- “Introduction to Managing Data with Model Reference”
- “Store Data in Dictionary Programmatically” on page 61-52
- “Componentization Guidelines” on page 15-29
- “What Are Simulink Projects?” on page 16-3

## Store Data in Dictionary Programmatically

### In this section...

- “Add Entry to Design Data Section of Data Dictionary” on page 61-52
- “Increment Value of Data Dictionary Entry” on page 61-53
- “Data Dictionary Management” on page 61-53
- “Dictionary Section Management” on page 61-54
- “Dictionary Entry Manipulation” on page 61-55
- “Transition to Using Data Dictionary” on page 61-56
- “Programmatically Migrate Single Model to Use Dictionary” on page 61-57
- “Import Directly From External File to Dictionary” on page 61-57
- “Programmatically Partition Data Dictionary” on page 61-59

A data dictionary stores Simulink model data and offers more data management features than the MATLAB base workspace or the model workspace (see “What Is a Data Dictionary?” on page 61-2). To interact with the data in a dictionary programmatically:

- 1 Create a `Simulink.data.Dictionary` object that represents the target dictionary.
- 2 Create a `Simulink.data.dictionary.Section` object that represents the target section, for example the Design Data section. Use the object to interact with the entries stored in the section and to add entries.
- 3 Optionally, create `Simulink.data.dictionary.Entry` objects that each represent an entry in the target section. Use these objects to interact with individual entries in the target section.

To programmatically access variables for the purpose of sweeping block parameter values, consider using `Simulink.SimulationInput` objects instead of modifying the variables through the programmatic interface of the data dictionary. See “Optimize, Estimate, and Sweep Block Parameter Values” on page 35-50.

### Add Entry to Design Data Section of Data Dictionary

- 1 Represent the Design Data section of the data dictionary `myDictionary_ex_API.sldd` with a `Simulink.data.dictionary.Section` object named `dDataSectObj`.

```
myDictionaryObj = Simulink.data.dictionary.open('myDictionary_ex_API.sldd');
dDataSectObj = getSection(myDictionaryObj, 'Design Data');
```

- 2 Add an entry to the Design Data section of myDictionary\_ex\_API.sldd an entry myNewEntry with value 237.

```
addEntry(dDataSectObj, 'myNewEntry', 237)
```

## Increment Value of Data Dictionary Entry

- 1 Represent the data dictionary entry fuelFlow with a Simulink.data.dictionary.Entry object named fuelFlowObj. fuelFlow is defined in the data dictionary myDictionary\_ex\_API.sldd.

```
myDictionaryObj = Simulink.data.dictionary.open('myDictionary_ex_API.sldd');
dDataSectObj = getSection(myDictionaryObj, 'Design Data');
fuelFlowObj = getEntry(dDataSectObj, 'fuelFlow');
```

- 2 Store the value of the target entry in a temporary variable. Increment the value of the temporary variable by one.

```
temp = getValue(fuelFlowObj);
temp = temp+1;
```

- 3 Set the value of the target entry by using the temporary variable.

```
setValue(fuelFlowObj, temp)
```

## Data Dictionary Management

Use Simulink.data.Dictionary objects to interact with entire data dictionaries.

Goal	Use
Represent existing data dictionary with Simulink.data.Dictionary object	Simulink.data.dictionary.open
Create and represent data dictionary with Simulink.data.Dictionary object	Simulink.data.dictionary.create
Interact with data dictionary	Simulink.data.Dictionary class

Goal	Use
Import variables to data dictionary from MATLAB base workspace	<code>Simulink.data.Dictionary.importFromBaseWorkspace</code> method
Add reference dictionary to a data dictionary	<code>Simulink.data.Dictionary.addDataSource</code> method
Remove reference dictionary from a data dictionary	<code>Simulink.data.Dictionary.removeDataSource</code> method
Save changes to data dictionary	<code>Simulink.data.Dictionary.saveChanges</code> method
Discard changes to data dictionary	<code>Simulink.data.Dictionary.discardChanges</code> method
View a list of entries stored in data dictionary	<code>Simulink.data.Dictionary.listEntry</code> method
Import enumerated type definitions to data dictionary	<code>Simulink.data.Dictionary.importEnumTypes</code> method
Return file name and path of data dictionary	<code>Simulink.data.Dictionary.filepath</code> method
Show data dictionary in Model Explorer window	<code>Simulink.data.Dictionary.show</code> method
Hide data dictionary from Model Explorer window	<code>Simulink.data.Dictionary.hide</code> method
Close connection between data dictionary and <code>Simulink.data.Dictionary</code> object	<code>Simulink.data.Dictionary.close</code> method
Identify data dictionaries that are open	<code>Simulink.data.dictionary.getOpenDictionaryPaths</code>
Close all connections to all open data dictionaries	<code>Simulink.data.dictionary.closeAll</code>

## Dictionary Section Management

Data dictionaries store data as entries contained in sections, and by default all dictionaries have at least three sections named Design Data, Other Data, and

Configurations. Use `Simulink.data.dictionary.Section` objects to interact with data dictionary sections.

Goal	Use
Represent data dictionary section with <code>Section</code> object.	<code>Simulink.data.Dictionary.getSection</code> method
Interact with data dictionary section	<code>Simulink.data.dictionary.Section</code> class
Import variables to data dictionary section from MAT-file or MATLAB file	<code>Simulink.data.dictionary.Section.importFromFile</code> method
Export entries in data dictionary section to MAT-file or MATLAB file	<code>Simulink.data.dictionary.Section.exportToFile</code> method
Delete entry from data dictionary section	<code>Simulink.data.dictionary.Section.deleteEntry</code> method
Evaluate MATLAB expression in data dictionary section	<code>Simulink.data.dictionary.Section.evalIn</code> method
Search for entries in data dictionary section	<code>Simulink.data.dictionary.Section.find</code> method
Determine whether entry exists in data dictionary section	<code>Simulink.data.dictionary.Section.exist</code> method

## Dictionary Entry Manipulation

A variable that is stored in a data dictionary is called an entry of the dictionary. Entries have additional properties that store status information, such as the time and date the entry was last modified. Use `Simulink.data.dictionary.Entry` objects to manipulate data dictionary entries.

Goal	Use
Represent data dictionary entry with <code>Entry</code> object	<code>Simulink.data.dictionary.Section.getEntry</code> method
Add data dictionary entry to section and represent with <code>Entry</code> object	<code>Simulink.data.dictionary.Section.addEntry</code> method

Goal	Use
Manipulate data dictionary entry	<code>Simulink.data.dictionary.Entry</code> class
Assign new value to data dictionary entry	<code>Simulink.data.dictionary.Entry.setValue</code> method
Display changes made to data dictionary entry	<code>Simulink.data.dictionary.Entry.showChanges</code> method
Save changes made to data dictionary	<code>Simulink.data.Dictionary.saveChanges</code> method
Discard changes made to data dictionary entry	<code>Simulink.data.dictionary.Entry.discardChanges</code> method
Search in an array of data dictionary entries	<code>Simulink.data.dictionary.Entry.find</code> method
Return value of data dictionary entry	<code>Simulink.data.dictionary.Entry.getValue</code> method
Delete data dictionary entry	<code>Simulink.data.dictionary.Entry.deleteEntry</code> method
Store enumerated type definition in dictionary	<code>Simulink.data.dictionary.EnumTypeDefinition</code> class

## Transition to Using Data Dictionary

These functions help you transition to data dictionaries by operating on Simulink model data either in the base workspace or in a data dictionary, as appropriate for the model.

Goal	Use
Change value of data dictionary entry or workspace variable in context of Simulink model	<code>Simulink.data.assignInGlobal</code>
Evaluate MATLAB expression in context of Simulink model	<code>Simulink.data.evalInGlobal</code>
Determine existence of data dictionary entry or workspace variable in context of Simulink model	<code>Simulink.data.existsInGlobal</code>

## Programmatically Migrate Single Model to Use Dictionary

To change the data source of a Simulink model from the MATLAB base workspace to a new data dictionary, use this example code as a template.

```
% Define the model name and the data dictionary name
modelName = 'f14';
dictionaryName = 'myNewDictionary.slidd';

% Load the target model
load_system(modelName);

% Identify all model variables that are defined in the base workspace
varsToImport = Simulink.findVars(modelName, 'SourceType', 'base workspace');
varNames = {varsToImport.Name};

% Create the data dictionary
dictionaryObj = Simulink.data.dictionary.create(dictionaryName);

% Import to the dictionary the model variables defined in the base
% workspace, and clear the variables from the base workspace
[importSuccess,importFailure] = importFromBaseWorkspace(dictionaryObj,...
    'varList',varNames,'clearWorkspaceVars',true);

% Link the dictionary to the model
set_param(modelName,'DataDictionary',dictionaryName);
```

---

**Note:** This code does not migrate the definitions of enumerated data types that were used to define model variables. If you import model variables of enumerated data types to a data dictionary but do not migrate the enumerated type definitions, the dictionary is less portable and might not function properly if used by someone else. To migrate enumerated data type definitions to a data dictionary, see “Enumerations in Data Dictionary” on page 61-14.

---

## Import Directly From External File to Dictionary

This example shows how to use a custom MATLAB function to import data directly from an external file to a data dictionary without creating or altering variables in the base workspace.

- 1 Create a two-dimensional lookup table in one sheet of a Microsoft Excel workbook. Use the upper-left corner of the sheet to provide names for the two breakpoints and for the table. Use column B and row 2 to store the two breakpoints, and use the rest of the sheet to store the table. For example, your lookup table might look like this:

	A	B	C	D	E	F	G	H
1		bkpt2Name						
2	bkpt1Name	tableName	0.1	0.2	0.3	0.4	0.5	
3		0.25	0.35	0.6	0.85	1.1	1.35	
4		0.5	0.45	0.7	0.95	1.2	1.45	
5		0.75	0.55	0.8	1.05	1.3	1.55	
6		1	0.65	0.9	1.15	1.4	1.65	
7		1.25	0.75	1	1.25	1.5	1.75	
8								

Save the workbook in your current folder as `my2DLUT.xlsx`.

- 2 Copy this custom function definition into a MATLAB file, and save the file in your current folder as `importLUTToDD.m`.

```
function importLUTToDD(workbookFile,dictionaryName)
% IMPORTLUTTODD(workbookFile,dictionaryName) imports data for a
% two-dimensional lookup table from a workbook directly into a data
% dictionary. The two-dimensional lookup table in the workbook can be
% any size but must follow a standard format.

% Read in the entire first sheet of the workbook.
[data,names,-] = xlsread(workbookFile,1, '');

% Divide the raw imported data into the breakpoints, the table, and their
% names.
% Assume breakpoint 1 is in the first column and breakpoint 2 is in the
% first row.
% Assume cells A1, B1, and B2 define the breakpoint names and table name.
bkpt1 = data(2:end,1);
bkpt2 = data(1,2:end);
table = data(2:end,2:end);
bkpt1Name = names{2,1};
bkpt2Name = names{1,2};
tableName = names{2,2};

% Prepare to import to the Design Data section of the target data
% dictionary.
myDictionaryObj = Simulink.data.dictionary.open(dictionaryName);
dDataSectObj = getSection(myDictionaryObj,'Design Data');
```



```

% Create entries in the dictionary to store the imported breakpoints and
% table. Name the entries using the breakpoint and table names imported
% from the workbook.
addEntry(dDataSectObj,bkpt1Name,bkpt1);
addEntry(dDataSectObj,bkpt2Name,bkpt2);
addEntry(dDataSectObj,tableName,table);

% Save changes to the dictionary and close it.
saveChanges(myDictionaryObj)
close(myDictionaryObj)

```

- 3 At the MATLAB command prompt, create a data dictionary to store the lookup table data.

```
myDictionaryObj = Simulink.data.dictionary.create('myLUTDD.sldd');
```

- 4 Call the custom function to import your lookup table to the new data dictionary.

```
importLUTToDD('my2DLUT.xlsx','myLUTDD.sldd')
```

- 5 Open the data dictionary in Model Explorer.

```
show(myDictionaryObj)
```

Three new entries store the imported breakpoints and lookup table. These entries are ready to use in a 2-D Lookup Table block.

## Programmatically Partition Data Dictionary

To partition a data dictionary into reference dictionaries, use this example code as a template. You can use reference dictionaries to make large data dictionaries more manageable and to contain standardized data that is useful for multiple models.

```

% Define the names of a parent data dictionary and two
% reference data dictionaries
parentDDName = 'myParentDictionary.sldd';
typesDDName = 'myTypesDictionary.sldd';
paramsDDName = 'myParamsDictionary.sldd';

% Create the parent data dictionary and a
% Simulink.data.Dictionary object to represent it
parentDD = Simulink.data.dictionary.create(parentDDName);

% Create a Simulink.data.dictionary.Section object to represent
% the Design Data section of the parent dictionary

```

```
designData_parentDD = getSection(parentDD, 'Design Data');

% Import some data to the parent dictionary from the file partDD_Data_ex_API.m
importFromFile(designData_parentDD, 'partDD_Data_ex_API.m');

% Create two reference dictionaries
Simulink.data.dictionary.create(typesDDName);
Simulink.data.dictionary.create(paramsDDName);

% Create a reference dictionary hierarchy by adding reference dictionaries
% to the parent dictionary
addDataSource(parentDD, typesDDName);
addDataSource(parentDD, paramsDDName);

% Migrate all Simulink.Parameter objects from the parent data dictionary to
% a reference dictionary
paramEntries = find(designData_parentDD, '-value', '-class', 'Simulink.Parameter');
for i = 1:length(paramEntries)
    paramEntries(i).DataSource = 'myParamsDictionary.sldd';
end

% Migrate all Simulink.NumericType objects from the parent data dictionary
% to a reference dictionary
typeEntries = find(designData_parentDD, '-value', '-class', 'Simulink.NumericType');
for i = 1:length(typeEntries)
    typeEntries(i).DataSource = 'myTypesDictionary.sldd';
end

% Save all changes to the parent data dictionary
saveChanges(parentDD)
```

## See Also

[set\\_param](#) | [Simulink.data.dictionary.cleanupWorkerCache](#) |  
[Simulink.data.dictionary.setupWorkerCache](#) | [Simulink.findVars](#)

## Related Examples

- “Enumerations in Data Dictionary” on page 61-14
- “Migrate Model Reference Hierarchy to Use Dictionary” on page 61-8
- “What Is a Data Dictionary?” on page 61-2
- “Optimize, Estimate, and Sweep Block Parameter Values” on page 35-50

# Managing Signals



# Working with Signals

---

- “Signal Basics” on page 62-2
- “Signal Types” on page 62-8
- “Virtual Signals” on page 62-11
- “Signal Values” on page 62-15
- “Signal Label Propagation” on page 62-19
- “Signal Dimensions” on page 62-30
- “Determine Output Signal Dimensions” on page 62-32
- “Display Signal Sources and Destinations” on page 62-38
- “Signal Ranges” on page 62-41
- “Initialize Signals and Discrete States” on page 62-48
- “Test Points” on page 62-56
- “Display Signal Attributes” on page 62-59
- “Signal Groups” on page 62-65

## Signal Basics

### In this section...

- “About Signals” on page 62-2
- “Creating Signals” on page 62-3
- “Signal Line Styles” on page 62-3
- “Signal Properties” on page 62-4
- “Store Design Attributes of Signals and States” on page 62-6
- “Testing Signals” on page 62-6

### About Signals

A *signal* is a time-varying quantity that has values at all points in time. You can specify a wide range of signal attributes, including:

- Signal name
- Data type (for example, 8-bit, 16-bit, or 32-bit integer)
- Numeric type (real or complex)
- Dimensionality (one-dimensional, two-dimensional, or multidimensional array)

Many blocks can accept or output signals of any data or numeric type and dimensionality. Other blocks impose restrictions on the attributes of the signals that they can handle.

In Simulink, signals are the outputs of dynamic systems represented by blocks in a Simulink diagram and by the diagram itself. The lines in a block diagram represent mathematical relationships among the signals defined by the block diagram. For example, a line connecting the output of block A to the input of block B indicates that the signal output of B depends on the signal output of A.

Simulink block diagrams represent signals with lines that have an arrowhead. The source of the signal corresponds to the block that writes to the signal during evaluation of its block methods (equations). The destinations of the signal are blocks that read the signal during the evaluation of the block methods (equations).

---

**Note** Simulink signals are mathematical, not physical, entities. The lines in a block diagram represent mathematical, not physical, relationships among blocks. Simulink

signals do not travel along the lines that connect blocks in the same way that electrical signals travel along a wire. Block diagrams do not represent physical connections between blocks.

---

## Creating Signals







Create a signal by adding a source block to your model. For example, you can create a signal that varies sinusoidally with time by adding an instance of the Sine block from the Simulink Sources library into your model. For information about blocks that create signals in a model, see “Sources” .

You can use the Signal & Scope Manager to create signals in your model without using blocks. For more information, see “Signal and Scope Manager” on page 26-77 .

## Signal Line Styles

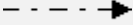
A Simulink model can include many different types of signals. For details, see “Signal Types” on page 62-8. Different line styles help you to differentiate the signal types.

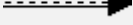
As you construct a block diagram, all signal types appear as a thin, solid line. After you update the diagram or start simulation, the signals appear with the specified line styles. The only line style that you can customize is the nonscalar signal type. For information about this option, see “Wide Nonscalar Lines” on page 62-64.

Signal Type	Line Style
Scalar and nonscalar	
Nonscalar (with the <b>Wide nonscalar lines</b> option enabled—see “Display Signal Attributes” on page 62-59)	
Control signal	
Virtual bus	
Nonvirtual bus	
Array of buses	

Signal Type	Line Style
Variable-size	

## Signal Properties

### Specify Signal Properties

Use the Property Inspector to specify properties for:

- Signal names and labels
- Signal logging
- Simulink Coder to use to generate code
- Documentation of the signal

To access the signal properties in the Property Inspector, first display the Property Inspector. Select **View > Property Inspector**. When you select a signal, the properties appear in the Property Inspector. Alternatively, you can right-click a signal and select **Properties** to use the Signal Properties dialog box. For information about the benefits of each approach, see “Setting Properties and Parameters” on page 1-51.

### Programmatically Specify Signal Properties

To specify signal properties programmatically, use a function such as `get_param` to get a handle to the block output port that creates the signal line. Then, use `set_param` to set the programmatic parameters of the port.

For an example, see “Name a Signal Programmatically” on page 1-18.

To learn how to map signal properties to programmatic port parameters, see “Signal Properties Dialog Box Overview”.

### Signal Names and Labels

You can name a signal. By default, the signal name appears below a signal, displayed as a *signal label*. You can name a signal interactively in the model or by using the Signal Properties dialog box. You can also name the signal at the command prompt (see “Name a Signal Programmatically” on page 1-18). For a summary of how to work with signal names and labels in the Simulink Editor, see “Signal Name and Label Actions” on page 1-92.



The syntactic requirements for a signal name depend on how you use the name. The most common cases are:

- The signal name can resolve to a `Simulink.Signal` object. (See `Simulink.Signal`.) The signal name must then be a legal MATLAB identifier. This identifier starts with an alphabetic character, followed by alphanumeric or underscore characters up to the length given by the function `namelengthmax`.
- The signal has a name so the signal can be identified and referenced by name in a data log. (See “Export Signal Data Using Signal Logging” on page 59-70.) Such a signal name can contain space and newline characters. These characters can improve readability but sometimes require special handling techniques, as described in “Handling Spaces and Newlines in Logged Names” on page 59-108
- The signal name exists only to clarify the diagram and has no computational significance. Such a signal name can contain anything and does not need special handling.
- The signal is an element of a bus object. Use a valid C language identifier for the signal name.
- Inputs to a Bus Creator block must have unique names. If there are duplicate names, the Bus Creator block appends (`signal#`) to all input signal names, where `#` is the input port index.

Making every signal name a legal MATLAB identifier handles a wide range of model configurations. Unexpected requirements can require changing signal names to follow a more restrictive syntax. You can use the function `isvarname` to determine whether a signal name is a legal MATLAB identifier.

### Signal Display Options

Displaying signal attributes in the model diagram can make the model easier to read. For example, in the Simulink Editor, use the **Display > Signals & Ports** menu to include in the model layout information about signal attributes, such as:

- Port data types
- Design ranges
- Signal dimensions
- Signal resolution

For details, see “Display Signal Attributes” on page 62-59.

You can also highlight a signal and its source or destination blocks. For details, see “Display Signal Sources and Destinations” on page 62-38.

## Store Design Attributes of Signals and States

You can use block parameters to specify signal design attributes such as data type, minimum and maximum values, physical unit, and numeric complexity. You can also specify code generation settings by using signal properties, which you access through the Model Data Editor or signal properties dialog boxes. To configure states, you can use block parameters. When you use these block parameters and signal properties, you store the specifications in the model file.

Alternatively, you can specify these attributes by using the properties of a `Simulink.Signal` object that you store in a workspace or data dictionary. See `Simulink.Signal` and “Data Objects” on page 57-59.

Choose which strategy to use based on your modeling goals.

- To improve model portability, readability, and ease of maintenance, store these specifications in the model file. You do not need to save and manage external `Simulink.Signal` objects. Consider setting the model configuration parameter **Signal resolution** to `None`, which disables the use of `Simulink.Signal` objects by the model.
- To separate these specifications from the model so that you can manage each independently, use `Simulink.Signal` objects. You can then configure the specifications in a flat list that you can sort, group, and filter with the Model Explorer. To determine where to permanently store the objects, see “Determine Where to Store Variables and Objects for Simulink Models” on page 57-85.

To configure design attributes and code generation settings for root-level Inport and Outport blocks by using a list that you can sort, group, and filter, consider the Model Data Editor. You can also use the Model Data Editor to configure code generation settings for internal signals. With this technique, you store the specifications in the model file instead of using `Simulink.Signal` objects. See “Configure Data Properties by Using a Table” on page 57-123.

## Testing Signals

You can perform the following kinds of tests on signals:

- “Minimum and Maximum Values” on page 62-7
- “Connection Validation” on page 62-7

### **Minimum and Maximum Values**

For many Simulink blocks, you can specify a range of valid values for the output signals. Simulink provides a diagnostic for detecting when blocks generate signals that exceed their specified ranges during simulation. For details, see “Signal Ranges” on page 62-41.

### **Connection Validation**

Many Simulink blocks have limitations on the types of signals that they accept. Before simulating a model, Simulink checks all blocks to ensure that the blocks can accommodate the types of signals output by the ports to which the blocks connect and reports errors about incompatibilities.

To detect signal compatibility errors before running a simulation, update the diagram.

### **Signal Groups**

The Signal Builder block displays interchangeable groups of signal sources. Use the Signal Builder to create or edit groups of signals and to switch the groups into and out of a model.

Signal groups can help with testing a model, especially when you use them with Simulink Assertion blocks and the Model Coverage Tool in the Simulink Verification and Validation product.

For details, see “Signal Groups” on page 62-65.

### **Related Examples**

- “Control Signal Data Types” on page 57-8
- “Signal Label Propagation” on page 62-19
- “Signal Name and Label Actions” on page 1-92
- “Merging Signals”

## Signal Types

### In this section...

“Summary of Signal Types” on page 62-8

“Control Signals” on page 62-8

“Composite (Bus) Signals” on page 62-9

### Summary of Signal Types

You can use many different kinds of signals in a model. The following table summarizes the signal types, and links to sections that describe each type in detail.

Signal Type	Description
Array of buses	An array whose elements are buses. See “Combine Buses into an Array of Buses” on page 63-110.
Bus (Composite)	A Simulink composite signal made up of other signals, optionally including other bus signals. See “Composite (Bus) Signals” on page 62-9.
Control	Signal used by one block to initiate execution of another block. For example, a signal that executes a function-call or action subsystem. For details, see “Control Signals” on page 62-8.
Nonvirtual	Signal that occupies its own storage. A nonvirtual bus reads inputs and writes outputs by accessing copies of the component signals.
Mux	A virtual vector created with a Mux block. See “Mux Signals” on page 62-11.
Variable-Size	Signal whose size (the number of elements in a dimension), in addition to its values, can change during a model simulation.
Virtual	Signal that represents another signal or set of signals. A virtual signal is used for graphical purposes and has no functional effect. See “Virtual Signals” on page 62-11.

### Control Signals

A *control signal* is a signal used by one block to initiate execution of another block. For example, a signal that executes a function-call or action subsystem is a control signal.

When you update or simulate a block diagram, Simulink uses a dash-dot pattern to redraw lines representing the control signals.

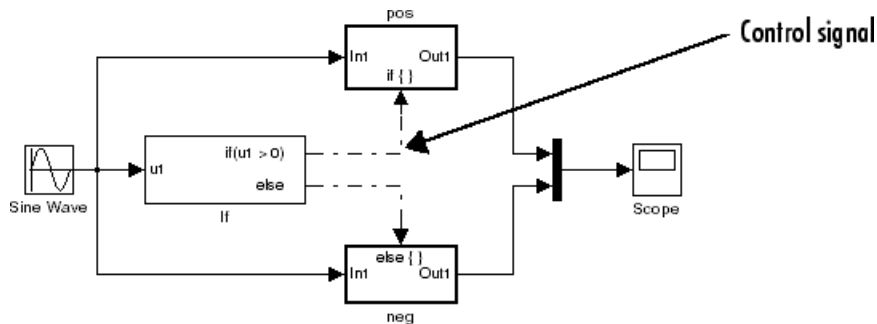

## Composite (Bus) Signals

You can group multiple signals into a hierarchical composite signal, called a *bus*, route the bus from block to block, and extract constituent signals from the bus where needed. When you have many parallel signals, buses can simplify the appearance of a model and help to clarify generated code. A bus can be either virtual or nonvirtual.

For example, if you open and simulate the `Bus Signal` example model, the `bus1`, `bus2`, and `main_bus` signals are bus signals. These virtual bus signals use the triple line style.

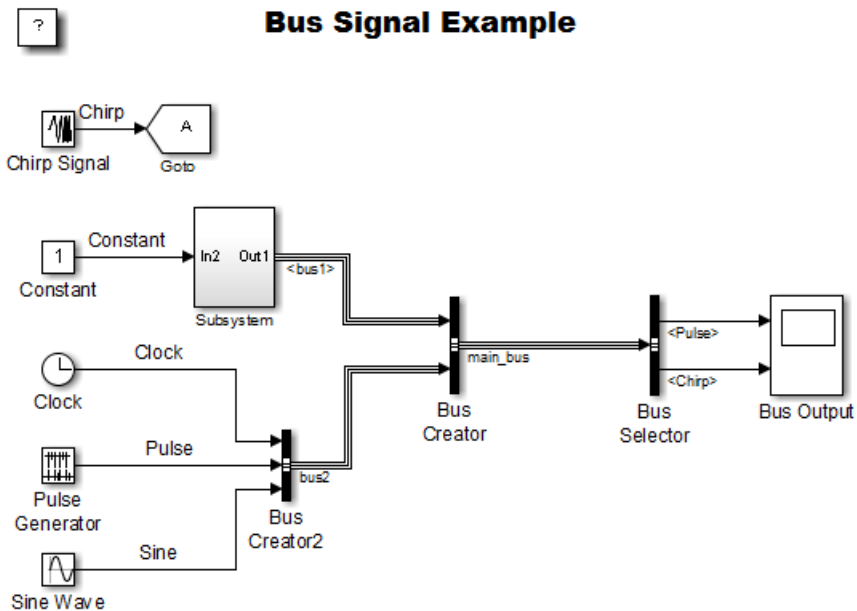

For information about buses, see “Buses” on page 63-3.

## Related Examples

- “Display Signal Attributes” on page 62-59
- “Control Signal Data Types” on page 57-8
- “Signal Basics” on page 62-2

# Virtual Signals

**In this section...**

“About Virtual Signals” on page 62-11

“Mux Signals” on page 62-11

## About Virtual Signals

A *virtual signal* is a signal that graphically represents other signals or parts of other signals. Virtual signals are purely graphical entities; they have no mathematical or physical significance. Simulink ignores them when simulating a model, and they do not exist in generated code. Some blocks, such as the Mux block, always generate virtual signals. Others, such as Bus Creator, can generate either virtual or nonvirtual signals.

The nonvirtual components of a virtual signal are called *regions*. A virtual signal can contain the same region more than once. For example, if the same nonvirtual signal is connected to two input ports of a Mux block, the block outputs a virtual signal that has two regions. The regions behave as they would if they had originated in two different nonvirtual signals, even though the resulting behavior duplicates information.

Bus signals can also be virtual or nonvirtual. For details, see “Virtual and Nonvirtual Buses” on page 63-4.

## Mux Signals

A Simulink *mux* is a virtual signal that graphically combines two or more scalar or vector signals into one signal line. A Simulink mux is not a hardware multiplexer, which combines multiple data streams into a single channel. A Simulink mux does not combine signals in any functional sense: it exists only virtually, and its only purpose is to simplify the visual appearance of a model. Using a mux has no effect on simulation or generated code.

You can use a mux anywhere that you could use an ordinary (contiguous) vector. For example, you can perform calculations on a mux. The computation affects each constituent value in the mux just as if the values existed in a contiguous vector, and the result is a contiguous vector, not a mux. Using a mux to perform computations on multiple vectors avoids the overhead of copying the separate values to contiguous storage.

The Simulink documentation refers, sometimes interchangeably, to “muxes”, “vectors”, and “wide signals”, and all three terms appear in Simulink GUI labels and API names. This terminology can be confusing, because most vector signals, which are also called wide signals, are nonvirtual and hence are not muxes. To avoid confusion, reserve the term “mux” to refer specifically to a virtual vector.

A mux is a *virtual* vector signal. The constituent signals of a mux retain their separate existence in every way, except visually. You can also combine scalar and vector signals into a *nonvirtual* vector signal, by using a Vector Concatenate block. The signal output by a Vector Concatenate block is an ordinary contiguous vector, inheriting no special properties from the fact that it was created from separate signals.

To create a composite signal whose constituent signals retain their identities and can have different data types, use a Bus Creator block rather than a Mux block. For details, see “Overview of Composite Signal Techniques” on page 63-3. Although you can use a Mux block to create a composite signal in some cases, MathWorks discourages this practice.

### Using Muxes

The Signal Routing library provides two virtual blocks for implementing muxes:

#### Mux

Combine several input signals into a mux (virtual vector) signal

#### Demux

Extract and output the values in a mux (virtual vector) signal

To implement a mux signal:

- 1 Select a Mux and Demux block from the Signal Routing library.
- 2 Set the Mux block **Number of inputs** and the Demux block **Number of outputs** block parameters to the desired values.
- 3 Connect the Mux, Demux, and other blocks as needed to implement the desired signal.

The next figure shows three signals that are input to a Mux block, transmitted as a mux signal to a Demux block, and output as separate signals.



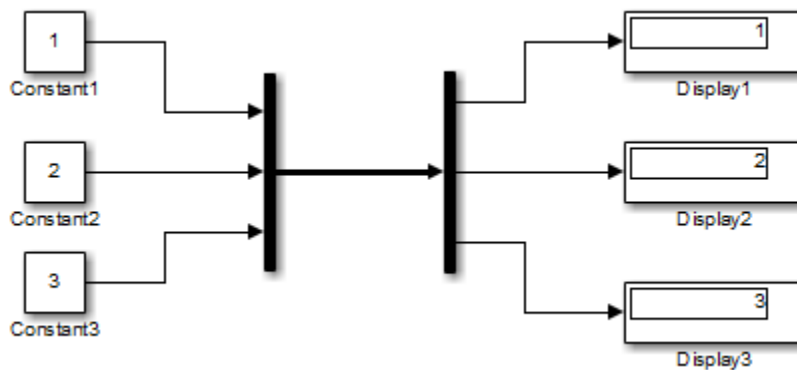

The Mux and Demux blocks are the left and right vertical bars, respectively. To reduce visual complexity, neither block displays a name. In this example, the line connecting the blocks, representing the mux signal, is wide because the model has been built with **Display > Signals & Ports > Wide Nonscalar Lines** option enabled. See “Display Signal Attributes” on page 62-59 for details.

Signals input to a Mux block can be any combination of scalars, vectors, and muxes. The signals in the output mux appear in the order in which they were input to the Mux block. You can use multiple Mux blocks to create a mux in several stages, but the result is flat, not hierarchical, just as if the constituent signals had been combined using a single mux block.

The values in all signals input to a Mux block must have the same data type.

If a Demux block attempts to output more values than exist in the input signal, an error occurs. A Demux block can output fewer values than exist in the input mux, and can group the values it outputs into different scalars and vectors than were input to the Mux block. However, the Demux block cannot rearrange the order of those values. For details, see Demux.

---

**Note:** MathWorks discourages using Mux and Demux blocks to create and access buses under any circumstances.

---

## Related Examples

- “Signal Basics” on page 62-2

- “Signal Types” on page 62-8

# Signal Values

**In this section...**

“Signal Data Types” on page 62-15

“Signal Dimensions, Size, and Width” on page 62-15

“Complex Signals” on page 62-15

“Initializing Signal Values” on page 62-16

“Viewing Signal Values” on page 62-16

“Displaying Signal Values in Model Diagrams” on page 62-17

“Exporting Signal Data” on page 62-18

## Signal Data Types

Data type refers to the format used to represent signal values internally. By default, the data type of Simulink signals is double. You can create signals of other data types. Simulink signals support the same range of data types as MATLAB. See “About Data Types in Simulink” on page 57-3 for more information.

## Signal Dimensions, Size, and Width

Simulink blocks can output one-dimensional, two-dimensional, or multidimensional signals. The Simulink user interface and documentation generally refer to 1-D signals as vectors and 2-D or multidimensional signals as matrices. A one-element array is frequently referred to as a scalar.

The size of a signal refers to the number of elements that a signal contains. The size of a matrix (2-D) signal is generally expressed as M-by-N, where M is the number of columns and N is the number of rows making up the signal. The size of a vector signal is referred to as the width of the signal.

For more information, see “Signal Dimensions” on page 62-30.

## Complex Signals

The values of signals can be complex numbers or real numbers. A signal whose values are complex numbers is a complex signal. Create a complex-valued signal using one of the following approaches:

- Load complex-valued signal data from the MATLAB workspace into the model via a root-level Inport block.
- Create a Constant block in your model and set its value to a complex number.
- Create real signals corresponding to the real and imaginary parts of a complex signal, then combine the parts into a complex signal, using the Real-Imag to Complex conversion block.

Manipulate complex signals via blocks that accept them. If you are not sure whether a block accepts complex signals, see the documentation for the block.

## Initializing Signal Values

If a signal does not have an explicit initial value, the initial value that Simulink uses depends on the data type of the signal.

Signal Data Type	Default Initial Value
Numeric (other than fixed-point)	Zero
Fixed-point	Ground value
Boolean	False
Enumerated	Default value

You can specify the non-default initial values of signals for Simulink to use at the beginning of simulation.

- For any signal, you can define a signal object (`Simulink.Signal`), and use that signal object to specify an initial value for the signal.
- For some blocks, such as Outport, Data Store Memory, and Memory, you can use either a signal object or a block parameter, or both, to specify the initial value of a block state or output.

For details, see “Initialize Signals and Discrete States” on page 62-48.

## Viewing Signal Values

You can use either blocks or the signal viewers (such as the Signal & Scope Manager) to display the values of signals during a simulation. For example, you can use either

the Scope block or the Signal & Scope Manager to graph time-varying signals on an oscilloscope-like display during simulation. For general information about options for viewing signal values, see “Scope Blocks and Scope Viewer Overview” on page 26-8. For detailed information about:

- Blocks that you can use to display signals in a model, see “Sinks”
- Signal viewers, see “Floating Scope and Scope Viewer Tasks” on page 26-69
- The Signal & Scope Manager, see “Signal and Scope Manager” on page 26-77
- Test points, which are signals that Simulink guarantees to be observable when using a Floating Scope block in a model, see “Test Points” on page 62-56.

## Displaying Signal Values in Model Diagrams

To include graphical displays of signal values in a model diagram, use one of the following approaches:

- “Display Data Tips During Simulation” on page 62-17
- “Display Signal Value After Simulation” on page 62-17

### Display Data Tips During Simulation

For many blocks, Simulink can display block output (port values) as data tips on the block diagram while a simulation is running.

- 1 In the Simulink Editor, select **Display > Data Display in Simulation**.
- 2 From the submenu, select either **Show Value Labels When Hovering** or **Show Value Labels When Clicked**.
- 3 To change display options, use the **Options** submenu.

For details, see “Display Port Values for Debugging” on page 34-16.

### Display Signal Value After Simulation

To display, below a specific signal, the signal value after simulation:

- 1 Right-click the signal.
- 2 In the context menu, select **Show Value Label of Selected Port**.

## Exporting Signal Data

You can save signal values to the MATLAB workspace during simulation, for later retrieval and postprocessing. For a summary of different approaches, see “Approaches for Exporting Signal Data” on page 59-5.

## Related Examples

- “Control Signal Data Types” on page 57-8
- “Initialize Signals and Discrete States” on page 62-48
- “Signal Basics” on page 62-2
- “Signal Types” on page 62-8
- “Signal Ranges” on page 62-41
- “Test Points” on page 62-56

## Signal Label Propagation

### In this section...

“Propagated Signal Labels” on page 62-19

“Blocks That Support Signal Label Propagation” on page 62-19

“Display Propagated Signal Labels” on page 62-20

“How Simulink Propagates Signal Labels” on page 62-21

### Propagated Signal Labels

When you enable the display of signal label propagation for output signals of the blocks listed in “Blocks That Support Signal Label Propagation” on page 62-19:

- If there is a user-specified signal name that Simulink can propagate, the propagated signal label includes the name in angle brackets (for example, <sig1>).
- If there is no signal name to propagate, Simulink displays an empty set of angle brackets (<>) for the label.

For example, in the following model, the output signal from the Subsystem block is configured for signal label propagation. The propagated signal label (<const>) is based on the name of the upstream output signal of the Constant block (const).

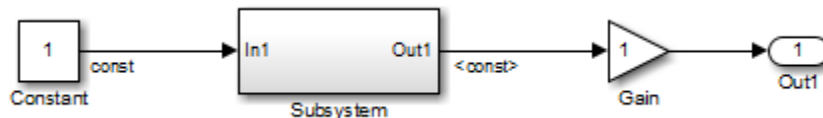

For more information on how Simulink creates propagated signal labels, see “How Simulink Propagates Signal Labels” on page 62-21.

### Blocks That Support Signal Label Propagation

You can use signal label propagation with output signals for several *connection* blocks, which route signals through the model without changing the data. Connection blocks perform no signal transformation.

Also, Model blocks support signal label propagation.

The connection blocks that support signal label propagation are:

- Enable
- From
- Function Call Split
- Goto
- Inport (subsystem only; not root inports)
- Signal Specification
- Subsystem (through subsystem Inport and Outport blocks)
- Trigger
- Two-Way Connection (a Simscape block)

The Bus Creator and Bus Selector blocks do *not* support signal label propagation. However, if you want to view the hierarchy for any bus signal, use the “Signal Hierarchy Viewer” on page 63-37.

The Signal Properties dialog box for a signal indicates whether that signal supports signal label propagation. The **Show propagated signals** parameter is available only for blocks that support signal label propagation. For details, see “Display Propagated Signal Labels” on page 62-20.

## Display Propagated Signal Labels

To display a propagated signal label:

- 1 Right-click the signal for which you want to display a propagated signal label and select **Properties**.
- 2 In the Signal Properties dialog box, select **Show propagated signals**.

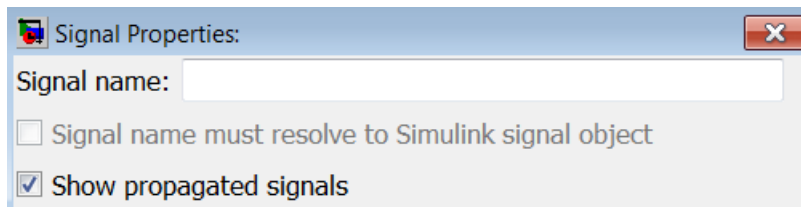



The **Show propagated signals** parameter is available only for output signals from blocks that support signal label propagation.

To enable this signal property programmatically, create a handle to the signal line, and specify `signalPropagation` as 'on'. For example, you can use this code to enable or disable the property for all of the signals in a model diagram.

```
% Create an array of handles to every signal line in the diagram
signalLines = find_system(gcs, 'FindAll', 'on', 'type', 'line');

% Enable or disable the property for each signal line
for i = 1:length(signalLines)

    % set(signalLines(i), 'signalPropagation', 'off');
    set(signalLines(i), 'signalPropagation', 'on');
end
```

If a signal already has a label, then an *alternative* approach for displaying a propagated signal label is:

- 1 In the model diagram, click the signal label.
- 2 Remove the label text.
- 3 In the signal label text box, enter an angle bracket (<).
- 4 Click outside the signal label.

Simulink displays the propagated signal label.

## How Simulink Propagates Signal Labels

Understanding how Simulink propagates signal labels helps you to:

- Anticipate the scope of the signal label propagation, from source to final destination
- Configure your model to display signal labels for the signals that you want

For output signals from supported blocks, you can choose to have Simulink display propagated signal labels. For a list of supported blocks, see “Blocks That Support Signal Label Propagation” on page 62-19.

In general, Simulink performs signal label propagation consistently:

- For different modeling constructs (for example, non-bus and bus signals, virtual and nonvirtual buses, subsystem and model variants, model referencing, and libraries)
- In models with or without hidden blocks, which Simulink inserts in certain cases to enable simulation
- At model load, edit, update, and simulation times

For information about some special cases, see:

- “Processing for Referenced Models” on page 62-26
- “Processing for Variants and Configurable Subsystems” on page 62-28

### **General Signal Label Propagation Processing**

In general, when you enable signal label propagation for an output signal of a block (for example, BlockA), Simulink performs the following processing to find the source signal name to propagate:

- 1** Checks the block whose output signal connects to BlockA, and if necessary, continues checking upstream blocks, working backward from the closest block to the farthest block.
- 2** Stops when it encounters a block that either:
  - Supports signal label propagation and has a signal name
  - Does not support signal label propagation
- 3** Obtains the signal name, if any, of the output signal for the block at which Simulink stops.
- 4** Uses that signal name for the propagated signal label of any output signals of downstream blocks for which you enable signal label propagation.

For example, in the following model, suppose that you enable signal label propagation for the output signal for the Subsystem block (that is, the signal connected to the **Out1** port).

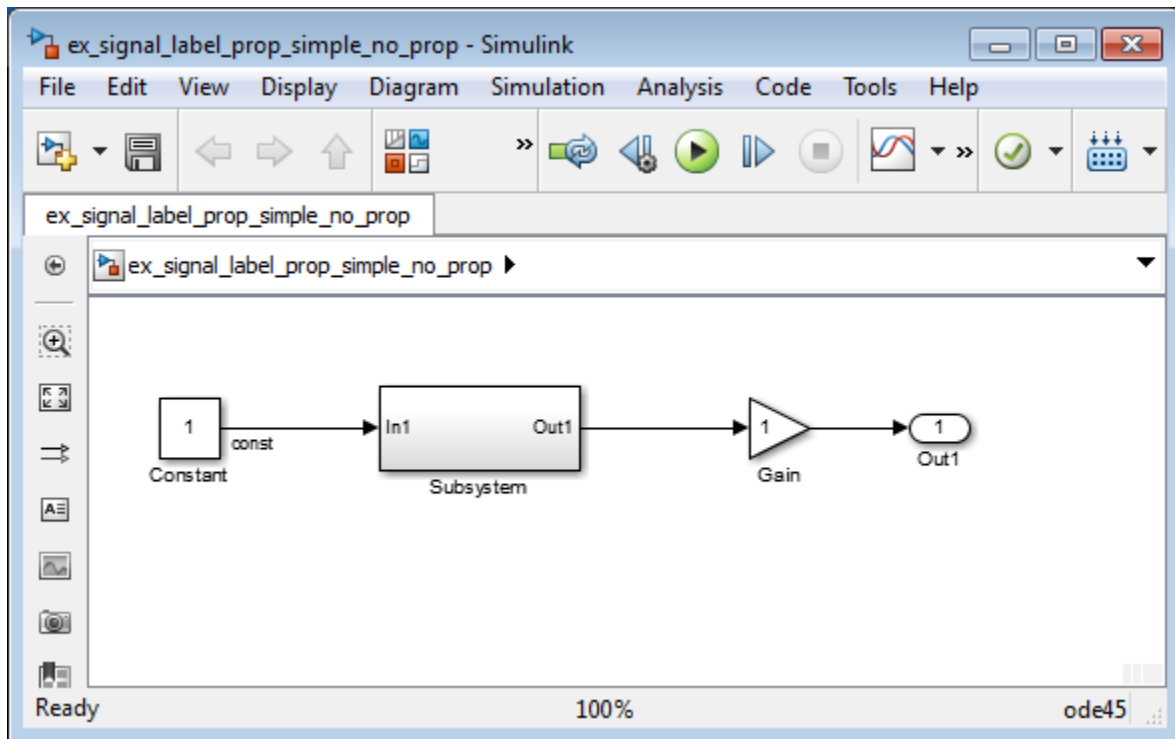

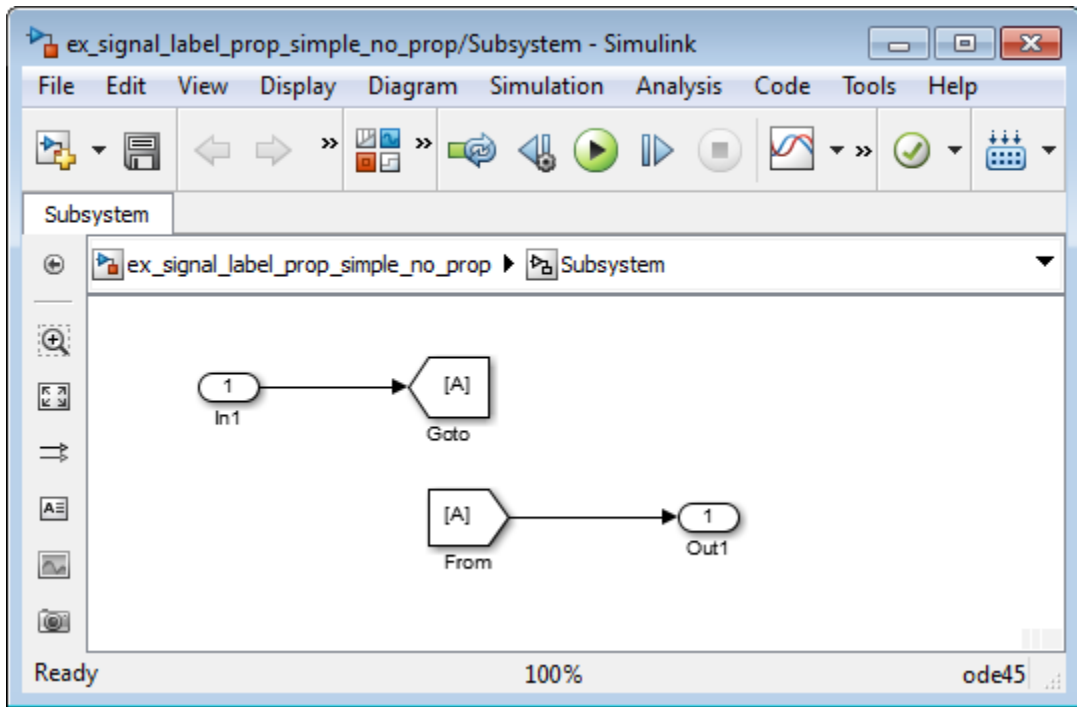

Simulink checks inside the subsystem, checks upstream from the From and GoTo blocks (which support signal label propagation and do not have a name), and then checks farther upstream, to the Constant block, which does not support signal label propagation.

Simulink uses the signal name of the Constant block output signal, `const`. The propagated signal label for the Subsystem output signal is `<const>`.

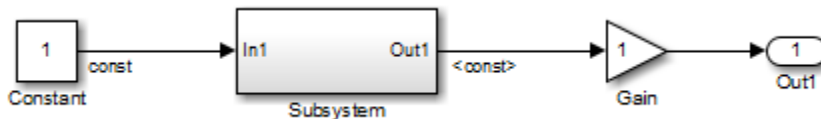

If the output signal from the Constant block did not have a signal name, then the propagated signal label would be an empty set of angle brackets (`<>`).

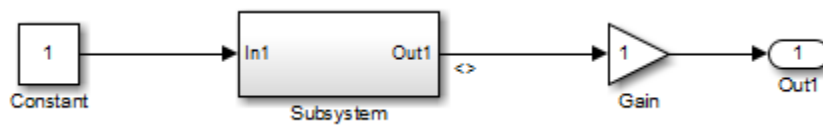

Suppose that in the Subsystem block you enable signal label propagation for the output signal from the In1 block, and you use the Signal Properties dialog box to specify the signal name `const - from` for the output signal of the From block, as shown below.

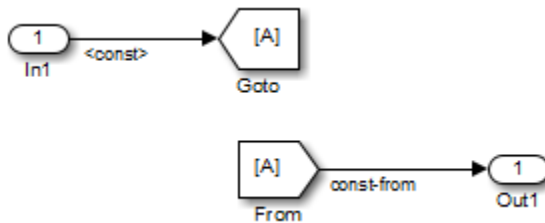

The propagated signal label for the Subsystem output signal changes to `<const - from>`, because that is the first named signal that Simulink encounters in its signal label propagation processing.

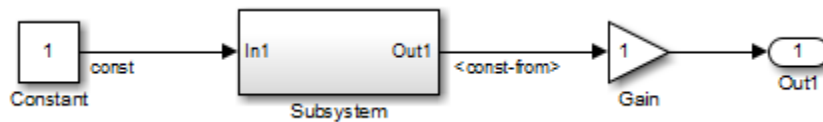

In the following model, the signal label propagation for the output signal of the Subsystem block uses the signal name `bus1`, which is the name of the output bus signal of the Bus Creator block. The propagated signal label does not include the names of the bus element signals (`a` and `b`).

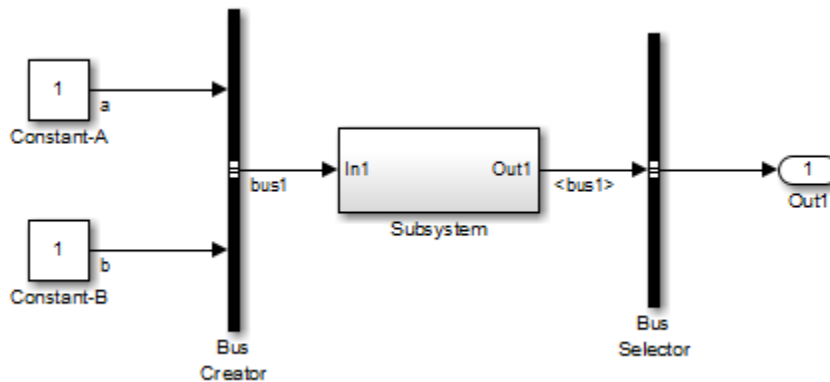

### Processing for Referenced Models

To enable signal label propagation for referenced models, in addition to the steps described in “Display Propagated Signal Labels” on page 62-20, use the default setting for the **Model Configuration Parameters > Model Referencing > Propagate all signal labels out of the model** parameter. In other words, make sure the parameter is enabled.

If you make a change inside a referenced model that affects signal label propagation, the propagated signal labels outside of the referenced model do not reflect those changes until after you update the diagram or simulate the model.

For example, the model `ex_signal_label_prop_model_ref` has a referenced model that includes an output signal from the `In1` block that has a signal name of `input_1`.

If you enable signal label propagation for the signal from the `Out1` port of the Model block, that signal does *not* reflect the name `input_1` until after you update the diagram or simulate the model.

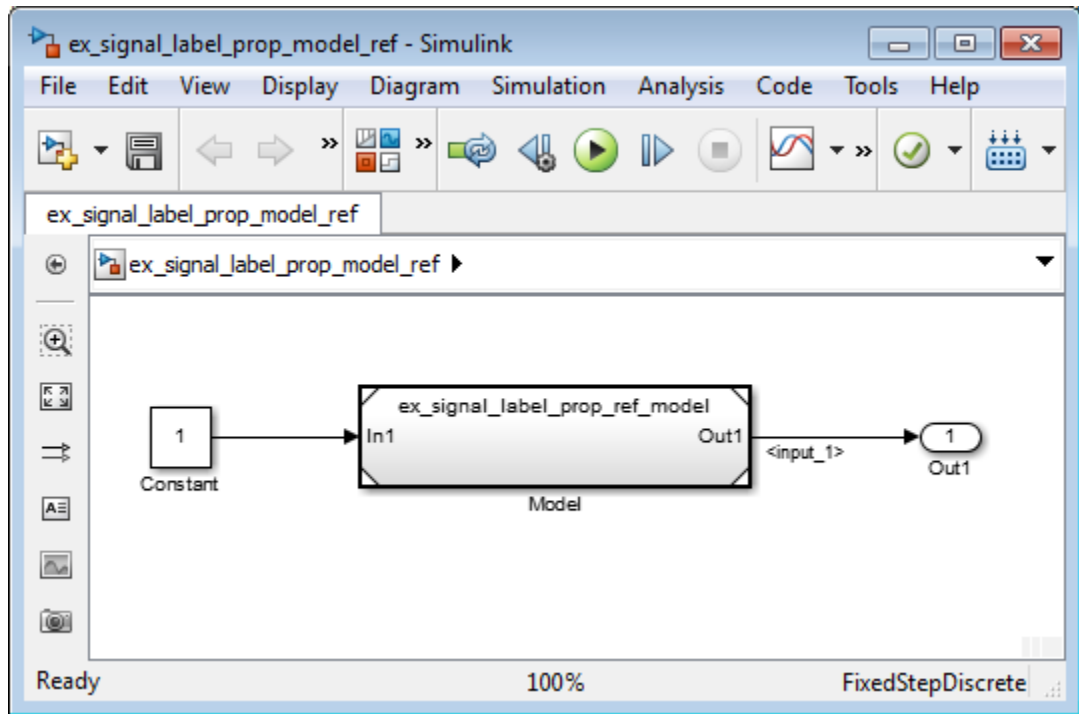

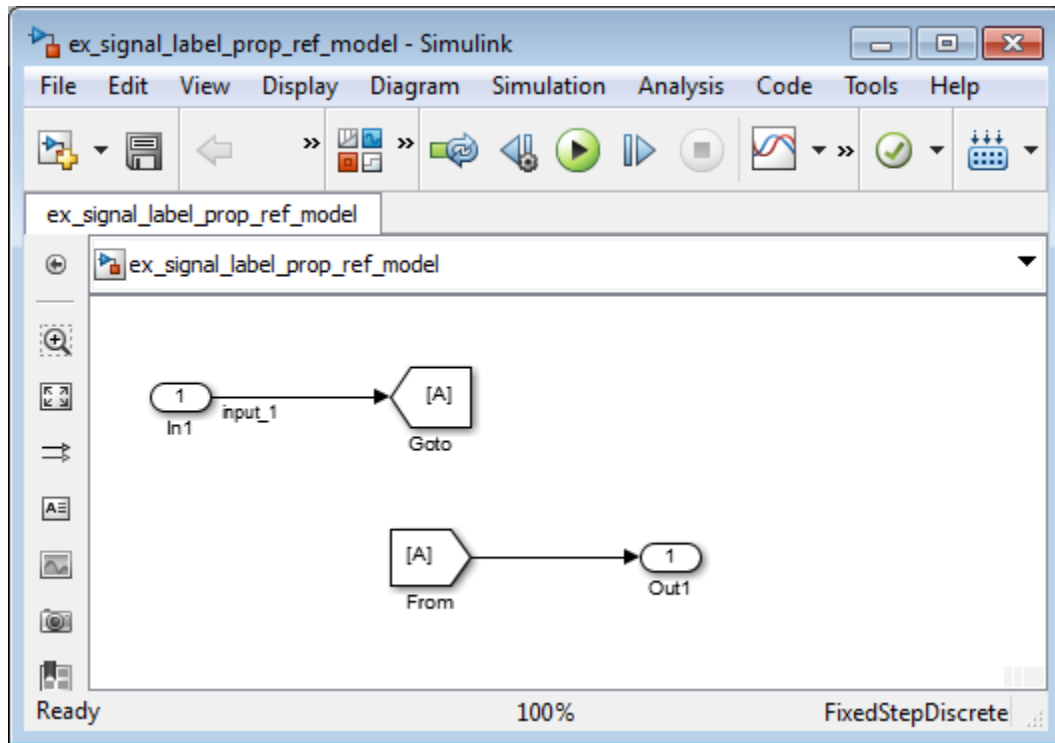

### Processing for Variants and Configurable Subsystems

Simulink updates the propagated signal label (if enabled) for the output signal of the Subsystem or Model block, when *both* of these conditions occur:

- The output signals for model reference variants have different signal names.
- You change the active variant model or variant subsystem.

For Subsystem blocks, the signal label updates at edit time. For Model blocks, the update occurs when you update diagram or simulate the model.

### Related Examples

- “Display Signal Attributes” on page 62-59
- “Display Signal Sources and Destinations” on page 62-38
- “Signal Basics” on page 62-2



- “Virtual Signals” on page 62-11

## Signal Dimensions

**In this section...**

“About Signal Dimensions” on page 62-30

“Simulink Blocks that Support Multidimensional Signals” on page 62-31

### About Signal Dimensions

Simulink blocks can output one-dimensional, two-dimensional, or multidimensional signals. The Simulink user interface and documentation generally refer to 1-D signals as *vectors* and 2-D or multidimensional signals as *matrices*. A one-element array is frequently referred to as a *scalar*. A *row vector* is a 2-D array that has one row. A *column vector* is a 2-D array that has one column.

- A one-dimensional (1-D) signal consists of a series of one-dimensional arrays output at a frequency of one array (vector) per simulation time step.
- A two-dimensional (2-D) signal consists of a series of two-dimensional arrays output at a frequency of one 2-D array (matrix) per block sample time.
- A multidimensional signal consists of a series of multidimensional (two or more dimensions) arrays output at a frequency of one array per block sample time. You can specify multidimensional arrays with any valid MATLAB multidimensional expression, such as [4 3]. See “Multidimensional Arrays” (MATLAB) for information on multidimensional arrays.

Simulink blocks vary in the dimensionality of the signals they can accept or output. Some blocks can accept or output signals of any dimension. Some can accept or output only scalar or vector signals. To determine the signal dimensionality of a particular block, see the block documentation. See “Determine Output Signal Dimensions” on page 62-32 for information on what determines the dimensions of output signals for blocks that can output nonscalar signals.

---

**Note:** Simulink does not support dynamic signal dimensions during a simulation. That is, the dimension of a signal must remain constant while a simulation is executing. However, you can change the size of a signal during a simulation. See “Variable-Size Signal Basics” on page 64-2.

---

## Simulink Blocks that Support Multidimensional Signals

The Simulink Block Data Type Support table includes a column identifying the blocks with multi-dimension signal support.

- 1 In the Simulink editor, from the **Help** menu, click **Simulink > Block Data Types & Code Generation Support > All Tables**.

A separate window with the Simulink Block Data Type Support table opens.

- 2 In the Block column, locate the name of a Simulink block. Columns to the right are data types or features. An **X** in a column indicates support for that feature.

Simulink supports signals with up to 32 dimensions. Do not use signals with more than 32 dimensions.

### Related Examples

- “Matrix Signals”
- “Determine Output Signal Dimensions” on page 62-32
- “Display Signal Attributes” on page 62-59
- “Signal Basics” on page 62-2
- “Signal Values” on page 62-15

## Determine Output Signal Dimensions

### In this section...

“About Signal Dimensions” on page 62-32

“Determining the Output Dimensions of Source Blocks” on page 62-32

“Determining the Output Dimensions of Nonsource Blocks” on page 62-33

“Signal and Parameter Dimension Rules” on page 62-33

“Scalar Expansion of Inputs and Parameters” on page 62-34

### About Signal Dimensions

If a block can emit nonscalar signals, the dimensions of the signals that the block outputs depend on the block parameters, if the block is a source block; otherwise, the output dimensions depend on the dimensions of the block input and parameters.

### Determining the Output Dimensions of Source Blocks

A *source* block is a block that has no inputs. Examples of source blocks include the Constant block and the Sine Wave block. See “Sources” for a complete listing of Simulink source blocks. The output dimensions of a source block are the same as those of its output value parameters if the block's **Interpret vector parameters as 1-D** parameter is off (that is, not selected in the block parameter dialog box). If the **Interpret vector parameters as 1-D** parameter is on, the output dimensions equal the output value parameter dimensions unless the parameter dimensions are N-by-1 or 1-by-N. In the latter case, the block outputs a vector signal of width N.

As an example of how a source block's output value parameter(s) and **Interpret vector parameters as 1-D** parameter determine the dimensionality of its output, consider the Constant block. This block outputs a constant signal equal to its **Constant value** parameter. The following table illustrates how the dimensionality of the **Constant value** parameter and the setting of the **Interpret vector parameters as 1-D** parameter determine the dimensionality of the block's output.

Constant Value	Interpret vector parameters as 1-D	Output
scalar	off	one-element array
scalar	on	one-element array

Constant Value	Interpret vector parameters as 1-D	Output
1-by-N matrix	off	1-by-N matrix
1-by-N matrix	on	N-element vector
N-by-1 matrix	off	N-by-1 matrix
N-by-1 matrix	on	N-element vector
M-by-N matrix	off	M-by-N matrix
M-by-N matrix	on	M-by-N matrix

Simulink source blocks allow you either to specify the dimensions of the signals that they output or specify values from which Simulink infers the dimensions. You can therefore use the source blocks to introduce signals of various dimensions into your model.

## Determining the Output Dimensions of Nonsource Blocks

If a block has inputs, the dimensions of its outputs are, after scalar expansion, the same as those of its inputs. (All inputs must have the same dimensions, as discussed in “Signal and Parameter Dimension Rules” on page 62-33).

## Signal and Parameter Dimension Rules

When creating a Simulink model, you must observe the following rules regarding signal and parameter dimensions.

### Input Signal Dimension Rule

All nonscalar inputs to a block must have the same dimensions.

A block can have a mix of scalar and nonscalar inputs as long as all the nonscalar inputs have the same dimensions. Simulink expands the scalar inputs to have the same dimensions as the nonscalar inputs (see “Scalar Expansion of Inputs and Parameters” on page 62-34).

### Block Parameter Dimension Rule

In general, block parameters must have the same dimensions as the dimensions of the inputs to the block. Simulink performs some processing that provides flexibility relating to that general rule.

- A block can have scalar parameters corresponding to nonscalar inputs. In this case, Simulink expands a scalar parameter to have the same dimensions as the corresponding input (see “Scalar Expansion of Inputs and Parameters” on page 62-34).
- If an input is a vector, the corresponding parameter can be either an N-by-1 or a 1-by-N matrix. In this case, Simulink applies the N matrix elements to the corresponding elements of the input vector. This exception allows use of MATLAB row or column vectors, which are actually 1-by-N or N-by-1 matrices, respectively, to specify parameters that apply to vector inputs.

### Vector or Matrix Input Conversion Rules

Simulink converts vectors to row or column matrices and row or column matrices to vectors under the following circumstances:

- If a vector signal is connected to an input that requires a matrix, Simulink converts the vector to a one-row or one-column matrix.
- If a one-column or one-row matrix is connected to an input that requires a vector, Simulink converts the matrix to a vector.
- If the inputs to a block consist of a mixture of vectors and matrices and the matrix inputs all have one column or one row, Simulink converts the vectors to matrices having one column or one row, respectively.

---

**Note** You can configure Simulink to display a warning or error message if a vector or matrix conversion occurs during a simulation. See “Vector/matrix block input conversion” for more information.

---

### Scalar Expansion of Inputs and Parameters

*Scalar expansion* is the conversion of a scalar value into a nonscalar array. Many Simulink blocks support scalar expansion of inputs and parameters. Block-specific descriptions indicate whether Simulink applies scalar expansion to a block's inputs and parameters.

Scalar expansion of inputs refers to the expansion of scalar inputs to match the dimensions of other nonscalar inputs or nonscalar parameters. When the input to a block is a mix of scalar and nonscalar signals, Simulink expands the scalar inputs into nonscalar signals having the same dimensions as the other nonscalar inputs. For

example, a scalar of 4 is expanded to the vector [4 4 4] if the associated nonscalar has a dimension of 3.

Scalar expansion of parameters refers to the expansion of scalar block parameters to match the dimensions of nonscalar inputs.

Input(s)	Associated Block Parameter	Scalar Expansion
Scalar	Nonscalar	Input expanded to match parameter dimensions.  See “Scalar Input and Nonscalar Parameter” on page 62-35.
Nonscalar	Scalar	Scalar parameter expanded to match number of elements of input.  See “Nonscalar Input and Scalar Parameter” on page 62-36.
Combination of scalar and nonscalar	No corresponding parameter	Scalar inputs expanded to match dimensions of largest nonscalar input.  See “Scalar and Nonscalar Inputs and No Associated Parameter” on page 62-36.

### Scalar Input and Nonscalar Parameter

In this example, the Constant block input to the Gain block is scalar. The Gain block **Gain** parameter is a nonscalar. Simulink expands the scalar input to match the dimensions of a nonscalar **Gain** parameter, as reflected in the simulation results in the Display block.

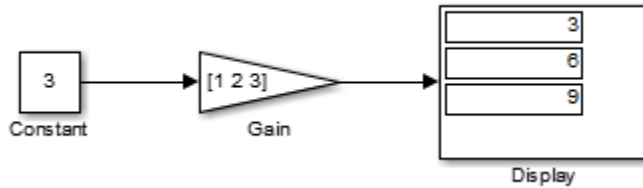

### Nonscalar Input and Scalar Parameter

In this example, the Constant block input to the Gain block is nonscalar. The Gain block **Gain** parameter is a scalar. Simulink expands the scalar parameter to match the dimensions of a nonscalar input from the Constant block, as reflected in the simulation results in the Display block.

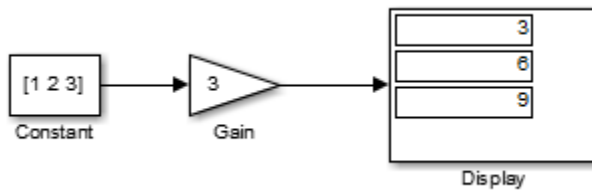

### Scalar and Nonscalar Inputs and No Associated Parameter

In this example, the Constant1 block input to the Sum block is nonscalar, and the Constant2 block input is scalar. The Sum block has no associated parameter. Simulink expands the scalar input from Constant2 to match to the dimensions of the nonscalar Constant1 block input. The input is expanded to the vector [3 3 3].

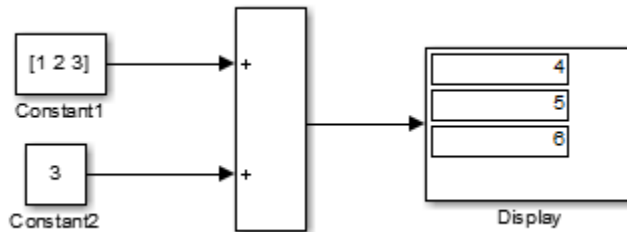



## **Related Examples**

- “Display Signal Attributes” on page 62-59
- “Signal Dimensions” on page 62-30
- “Signal Basics” on page 62-2
- “Signal Values” on page 62-15

## Display Signal Sources and Destinations

In this section...
“About Signal Highlighting” on page 62-38
“Highlighting Signal Sources” on page 62-38
“Highlighting Signal Destinations” on page 62-39
“Removing Highlighting” on page 62-40
“Resolving Incomplete Highlighting to Library Blocks” on page 62-40

### About Signal Highlighting

You can highlight a signal and its source or destination block(s), then remove the highlighting once it has served its purpose. Signal highlighting crosses subsystem boundaries, allowing you to trace a signal across multiple subsystem levels. Highlighting does not cross the boundary into or out of a referenced model. If a signal is composite, all source or destination blocks are highlighted. (See “Overview of Composite Signal Techniques” on page 63-3.)

### Highlighting Signal Sources

To display the source block(s) of a signal, select the **Highlight Signal to Source** option from the context menu for the signal. This option highlights:

- All branches of the signal anywhere in the model
- All virtual blocks through which the signal passes
- The nonvirtual block(s) that write the value of the signal

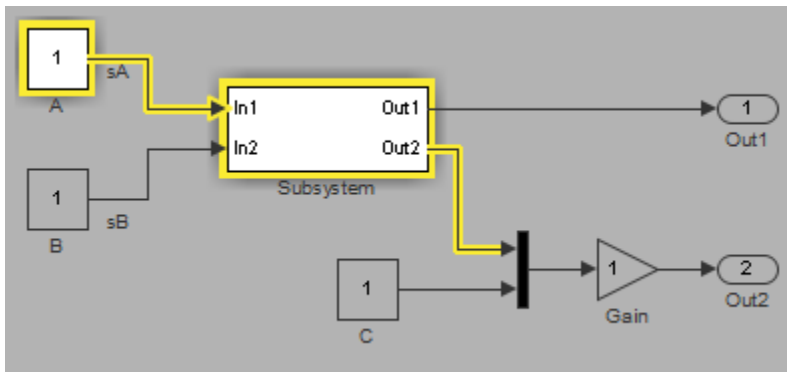

## Highlighting Signal Destinations

To display the destination blocks of a signal, select the **Highlight Signal to Destination** option from the context menu for the signal. This option highlights:

- All branches of the signal anywhere in the model
- All virtual blocks through which the signal passes
- The nonvirtual block(s) that read the value of the signal
- The signal and destination block for all blocks that are duplicates of the inport block for the line that you select

In this example, the selected signal highlights the Gain block as the destination block.

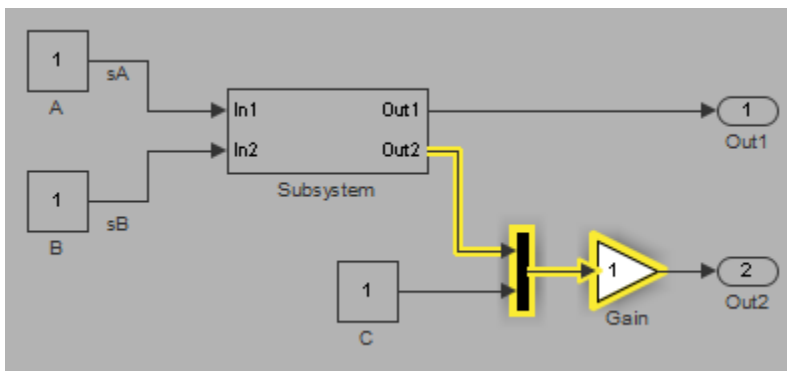

In the next example, selecting the signal from In2 and choosing the **Highlight Signal to Destination** option highlights the signal and destination block for In2 and In1, because In1 and In2 are duplicate import blocks.

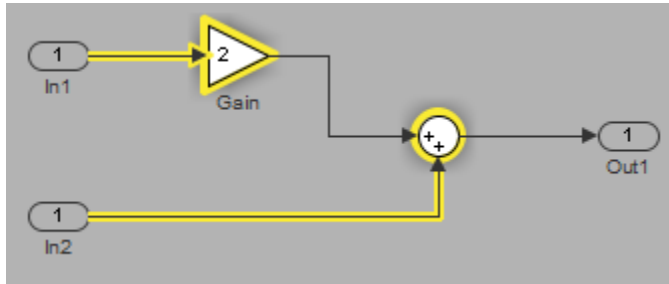

## Removing Highlighting

To remove all highlighting, select **Remove Highlighting** from the model's context menu, or select **Display > Remove Highlighting**.

## Resolving Incomplete Highlighting to Library Blocks

If the path from a source block or to a destination block includes an unresolved reference to a library block, the highlighting options highlight the path from or to the library block, respectively. To display the complete path, first update the diagram (for example, by pressing **Ctrl+D**). The update of the diagram resolves all library references and displays the complete path to a destination block or from a source block.

## Related Examples

- “Display Signal Attributes” on page 62-59
- “Signal Label Propagation” on page 62-19
- “Signal Basics” on page 62-2

# Signal Ranges

## In this section...

“About Signal Ranges” on page 62-41

“Blocks That Allow Signal Range Specification” on page 62-41

“Specify Ranges for Signals” on page 62-42

“Check for Signal Range Errors” on page 62-44

“Unexpected Errors or Warnings for Data with Greater Precision or Range than **double**” on page 62-46

“Optimize Generated Code” on page 62-47

## About Signal Ranges

Many Simulink blocks allow you to specify a range of valid values for their output signals. Simulink provides a diagnostic that you can enable to detect when blocks generate signals that exceed their specified ranges during simulation. See the sections that follow for more information.

## Blocks That Allow Signal Range Specification

The following blocks allow you to specify ranges for their output signals:

- Abs
- Constant
- Data Store Memory
- Data Type Conversion
- Difference
- Discrete Derivative
- Discrete-Time Integrator
- Gain
- Inport
- Interpolation Using Prelookup

- 1-D Lookup Table
- 2-D Lookup Table
- n-D Lookup Table
- Math Function
- MinMax
- Multiport Switch
- Outport
- Product, Divide, Product of Elements
- Relay
- Repeating Sequence Interpolated
- Repeating Sequence Stair
- Saturation
- Saturation Dynamic
- Signal Specification
- Sum, Add, Subtract, Sum of Elements
- Switch

## Specify Ranges for Signals

In general, use the **Output minimum** and **Output maximum** parameters that appear on a block parameter dialog box to specify a range of valid values for the block output signal. Exceptions include the Data Store Memory, Inport, Outport, and Signal Specification blocks, for which you use their **Minimum** and **Maximum** parameters to specify a signal range. See “Blocks That Allow Signal Range Specification” on page 62-41 for a list of applicable blocks.

Specify a minimum or maximum as an expression that evaluates to a scalar, real number with **double** data type. For example, you can use:

- A literal number such as **98.884**. Implicitly, the data type is **double**.
- A numeric workspace variable (see “Share and Reuse Block Parameter Values by Creating Variables” on page 35-11) whose data type is **double**. Use this technique to share a minimum or maximum value between multiple data items.

However, you cannot use variables to set the `Min` or `Max` properties of a `Simulink.Signal` object.

The scalar value that you specify applies to each element of a composite signal (for example, when the signal is nonscalar or a bus). For information about scalar expansion, see “Scalar Expansion of Inputs and Parameters” on page 62-34.

To leave the minimum or maximum of a signal unspecified, use an empty matrix `[]`, which is the default value.

### Specify Ranges for Modeling Constructs

If you use modeling constructs such as bus signals, data stores, and Stateflow charts, you can use different techniques to specify design range information. Use the information in the table.

Description of Target Signal	Technique and More Information
Numerically complex signal	When you specify an <b>Output minimum</b> or <b>Output maximum</b> for a signal that is numerically complex, the specified minimum and maximum values apply separately to the real part and to the imaginary part of the complex number. If the value of either part of the number is less than the minimum, or greater than the maximum, the complex number is outside the specified range. No range checking occurs against any combination of the real and imaginary parts, such as $(\text{sqrt}(a^2+b^2))$ .
Signal elements in a bus	If you assemble the bus by using a Bus Creator block, you can specify range information on the upstream blocks that feed the Bus Creator.  Regardless of the technique you use to assemble the bus, you can create a <code>Simulink.Bus</code> object and use it as the data type of the bus signal. In this case, consider specifying range information by using the <code>Min</code> and <code>Max</code> properties of the <code>Simulink.BusElement</code> objects that reside in the bus object. For more information, see “When to Use Bus Objects” on page 63-59.
Signal in a MATLAB Function block	Use the Ports and Data Manager to specify the <b>Minimum</b> and <b>Maximum</b> properties of the data. See “Setting General Properties” on page 40-41.
Signal in a Stateflow chart	Set the <b>Minimum</b> and <b>Maximum</b> properties of the corresponding Stateflow data. See “Limit range properties” (Stateflow).

Description of Target Signal	Technique and More Information
Signal that you associate with a signal object (such as <code>Simulink.Signal</code> )	Set the <code>Min</code> and <code>Max</code> properties of the signal object. See <code>Simulink.Signal</code> .
Data store (Data Store Memory block or <code>Simulink.Signal</code> object)	For a Data Store Memory block, set the <b>Minimum</b> and <b>Maximum</b> block parameters. For a signal object, set the <code>Min</code> and <code>Max</code> properties.

## Check for Signal Range Errors

Simulink provides a diagnostic named **Simulation range checking**, which you can enable to detect when signals exceed their specified ranges during simulation. When enabled, Simulink compares the signal values that a block outputs with both the specified range (see “Specify Ranges for Signals” on page 62-42) and the block data type. That is, Simulink performs the following check:

$$\text{DataTypeMin} \leq \text{MinValue} \leq \text{VALUE} \leq \text{MaxValue} \leq \text{DataTypeMax}$$

where

- `DataTypeMin` is the minimum value representable by the block data type.
- `MinValue` is the minimum value the block should output, specified by, e.g., **Output minimum**.
- `VALUE` is the signal value that the block outputs.
- `MaxValue` is the maximum value the block should output, specified by, e.g., **Output maximum**.
- `DataTypeMax` is the maximum value representable by the block data type.

---

**Note:** It is possible to overspecify how a block handles signals that exceed particular ranges. For example, you can specify values (other than the default values) for both signal range parameters and enable the **Saturate on integer overflow** parameter. In this case, Simulink displays a warning message that advises you to disable the **Saturate on integer overflow** parameter.

---



## Enable Simulation Range Checking

To enable the **Simulation range checking** diagnostic:

- 1 In your model window, select **Simulation > Model Configuration Parameters**.  
Simulink displays the Configuration Parameters dialog box.
- 2 In the **Select** tree on the left side of the Configuration Parameters dialog box, click the **Diagnostics > Data Validity** category. On the right side under **Signals**, set the **Simulation range checking** diagnostic to error or warning.

Signals			
Signal resolution:	Explicit only	Wrap on overflow:	warning
Division by singular matrix:	none	Saturate on overflow:	warning
Underspecified data types:	none	Inf or NaN block output:	none
Simulation range checking:	none	"rt" prefix for identifiers:	error
Detect when signals exceed specified minimum/maximum values			
Parameters			

- 3 Click **OK** to apply your changes and close the Configuration Parameters dialog box.  
See “Simulation range checking” for more information.

## Simulate Models with Simulation Range Checking

To check for signal range errors or warnings:

- 1 Enable the **Simulation range checking** diagnostic for your model (see “Enable Simulation Range Checking” on page 62-45).
- 2 In your model window, select **Simulation > Run** to simulate the model.

Simulink simulates your model and performs signal range checking. If a signal exceeds its specified range when the **Simulation range checking** diagnostic specifies **error**, Simulink stops the simulation and generates an error (for example, in the Diagnostic Viewer).

Otherwise, if a signal exceeds its specified range when the **Simulation range checking** diagnostic specifies **warning**, Simulink generates a warning message in the MATLAB Command Window. Each message identifies the block whose output signal exceeds its specified range, and the time step at which this violation occurs.

### Signal Range Propagation for Virtual Blocks

Some virtual blocks (see “Nonvirtual and Virtual Blocks” on page 34-2) allow you to specify ranges for their output signals, for example, the Inport and Outport blocks. When the **Simulation range checking** diagnostic is enabled for a model that contains such blocks, the signal range of the virtual block propagates backward to the first instance of a nonvirtual block whose output signal it receives. If the nonvirtual block specifies different values for its own range, Simulink performs signal range checking with the *tightest* range possible. That is, Simulink checks the signal using the larger minimum value and the smaller maximum value.

For example, consider the following model:

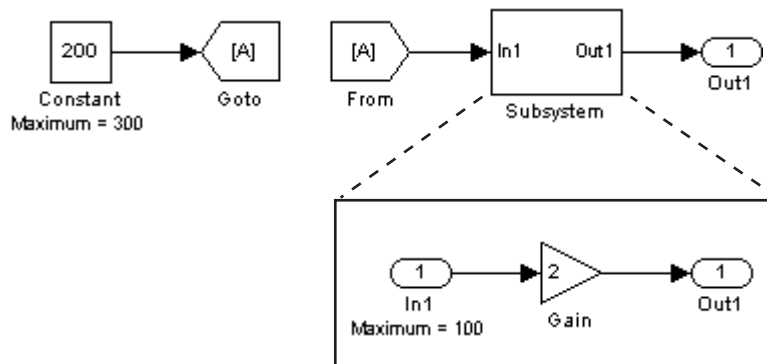

In this model, the Constant block specifies its **Output maximum** parameter as 300, and that of the Inport block is set to 100. Suppose you enable the **Simulation range checking** diagnostic and simulate the model. The Inport block back propagates its maximum value to the nonvirtual block that precedes it, i.e., the Constant block. Simulink then uses the smaller of the two maximum values to check the signal that the Constant block outputs. Because the Constant block outputs a signal whose value (200) exceeds the tightest range, Simulink generates an error.

### Unexpected Errors or Warnings for Data with Greater Precision or Range than double

When a data item (signal or parameter) uses a data type other than `double`, before comparison, Simulink casts the data item and each design limit (minimum or maximum value that you specify) to the `nondouble` data type. This technique helps prevent the generation of unnecessary, misleading errors and warnings.

However, Simulink stores design limits as `double` before comparison. If the data type of the data item has higher precision than `double` (for example, a fixed-point data type with a 128-bit word length and a 126-bit fraction length) or greater range than `double`, and `double` cannot exactly represent the value of a design limit, Simulink can generate unexpected warnings and errors.

If the nondouble type has higher precision, consider rounding the design limit to the next number furthest from zero that `double` can represent. For example, suppose that a signal generates an error after you set the maximum value to `98.8847692348509014`. At the command prompt, calculate the next number furthest from zero that `double` can represent.

```
format long
98.8847692348509014 + eps(98.8847692348509014)

ans =

    98.884769234850921
```

Use the resulting number, `98.884769234850921`, to replace the maximum value.

## Optimize Generated Code

If you have Embedded Coder, Simulink Coder can optimize the code that you generate from the model by taking into account the minimum and maximum values that you specify for signals and parameters. This optimization can remove algorithmic code and affect the results of some simulation modes such as SIL or external mode. For more information, see “Optimize using the specified minimum and maximum values”.

## Related Examples

- “Display Signal Attributes” on page 62-59
- “Control Signal Data Types” on page 57-8
- “Signal Basics” on page 62-2
- “Signal Values” on page 62-15
- “Fixed Point”

## Initialize Signals and Discrete States

In this section...
“About Initialization” on page 62-48
“Using Block Parameters to Initialize Signals and Discrete States” on page 62-49
“Use Signal Objects to Initialize Signals and Discrete States” on page 62-49
“Using Signal Objects to Tune Initial Values” on page 62-51
“Example: Using a Signal Object to Initialize a Subsystem Output” on page 62-52
“Initialization Behavior Summary for Signal Objects” on page 62-53

### About Initialization

---

**Note:** For information about initializing bus signals, see “Specify Initial Conditions for Bus Signals” on page 63-99.

---

Simulink allows you to specify the initial values of signals and discrete states, i.e., the values of the signals and discrete states at the **Start time** of the simulation. You can use signal objects to specify the initial values of any signal or discrete state in a model. In addition, for some blocks, e.g., Outport, Data Store Memory, or Memory, you can use either a signal object or a block parameter or both to specify the initial value of a block state or output. In such cases, Simulink checks to ensure that the values specified by the signal object and the parameter are consistent.

When you specify a signal object for signal or discrete state initialization, or a variable as the value of a block parameter, Simulink resolves the name that you specify to an appropriate object or variable, as described in “Symbol Resolution” on page 57-118.

A given signal can be associated with at most one signal object under any circumstances. The signal can refer to the object more than once, but every reference must resolve to exactly the same object. A different signal object that has exactly the same properties will not meet the requirement for uniqueness. A compile-time error occurs if a model associates more than one signal object with any signal. For more information, see `Simulink.Signal` and the Merge block.

## Using Block Parameters to Initialize Signals and Discrete States

For blocks that have an initial value or initial condition parameter, you can use that parameter to initialize a signal. For example, the following Block Parameters dialog box initializes the signal for a Unit Delay block with an initial condition of 0.

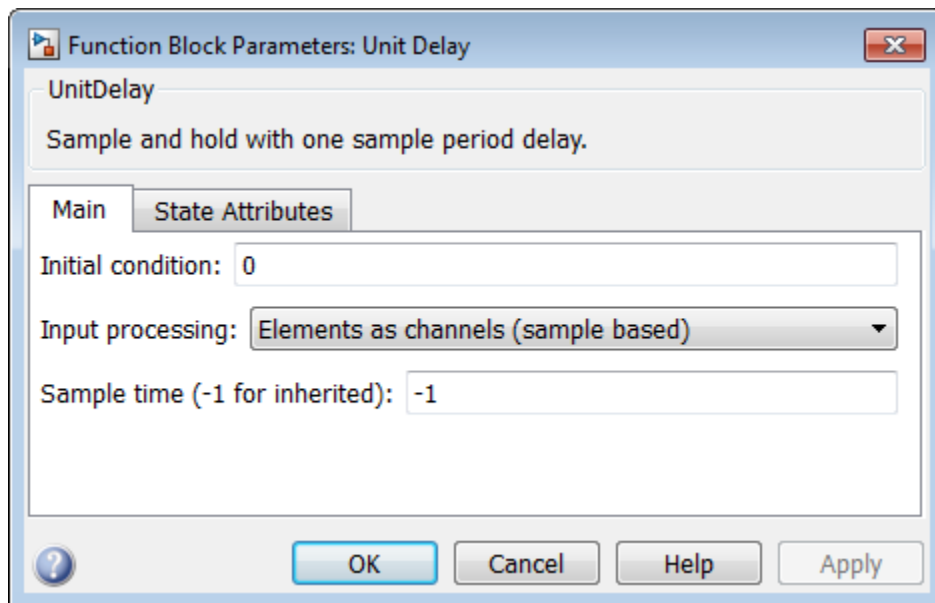

## Use Signal Objects to Initialize Signals and Discrete States

You can use signal objects that have a storage class other than 'auto' or 'SimulinkGlobal' to initialize

- Discrete states with an initial condition parameter
- Signals in a model except bus signals and blocks that output constant value

To specify an initial value, use the Model Explorer or MATLAB commands to do the following:

- 1 Create the signal object.

On the Model Explorer toolbar, select **Add > Simulink Signal**. The signal object appears in the base workspace with a default name. Rename the object as **S1**. Alternatively, use this command at the command prompt:

```
S1 = Simulink.Signal;
```

The name of the signal object must be the same as the name of the signal that the object is initializing. Although not required, consider setting the **Signal name must resolve to Simulink signal object** option in the Signal Properties dialog box. This setting makes signal objects in the MATLAB workspace consistent with signals that appear in your model.

Consider using the Data Object Wizard to create signal objects. The Data Object Wizard searches a model for signals for which signal objects do not exist. You can then selectively create signal objects for multiple signals listed in the search results with a single operation. For more information about the Data Object Wizard, see “Create Data Objects for a Model Using Data Object Wizard” on page 57-68.

- 2 Set the signal object's storage class to a value other than **auto** or **SimulinkGlobal**. In the Model Explorer **Contents** pane, select the signal object. In the Dialog pane, set **Storage class** to **ExportedGlobal**. Alternatively, use this command at the command prompt:

```
S1.CoderInfo.StorageClass = 'ExportedGlobal';
```

- 3 Set the initial value. You can specify a MATLAB expression, including the name of a workspace variable, that evaluates to a numeric scalar value or array.

The Simulink engine converts the initial value so the type, complexity, and dimension are consistent with the corresponding block parameter value. If you specify an invalid value or expression, an error message appears when you update the model.

In the Model Explorer Dialog pane, set **Initial value** to **0.5**. Alternatively, use this command at the command prompt:

```
S1.InitialValue = '0.5'
```

If you can also use a block parameter to set the initial value of the signal or state, you should set the parameter either to empty (`[]`) or to the same value as the initial value of the signal object. If you set the parameter value to empty, Simulink uses the value specified by the signal object to initialize the signal or state. If you set the

parameter to any other value, Simulink compares the parameter value to the signal object value and displays an error if they differ.

Some initial value settings may depend on the initialization mode. For more information, see “Underspecified initialization detection”.

**Classic initialization mode:** In this mode, initial value settings for signal objects that represent the following signals and states override the corresponding block parameter initial values if undefined (specified as [ ]):

- Output signals of conditionally executed subsystems and Merge blocks
- Block states

**Simplified initialization mode:** In this mode, initial values of signal objects associated with the output of the following blocks are ignored. The initial values of the corresponding blocks are used instead.

- Output signals of conditionally executed subsystems
- Merge blocks

## Using Signal Objects to Tune Initial Values

Simulink allows you to use signal objects as an alternative to parameter objects (see `Simulink.Parameter`) to tune the initial values of block outputs and states that can be specified via a tunable parameter. To use a signal object to tune an initial value, create a signal object with the same name as the signal or state and set the signal object's initial value to an expression that includes a variable defined in the MATLAB workspace. You can then tune the initial value by changing the value of the corresponding workspace variable during the simulation.

For example, suppose you want to tune the initial value of a Memory block state named M1. To do this, you might create a signal object named M1, set its storage class to 'ExportedGlobal', set its initial value to K (`M1.InitialValue='K'`), where K is a workspace variable in the MATLAB workspace, and set the corresponding initial condition parameter of the Memory block to [ ] to avoid consistency errors. You could then change the initial value of the Memory block's state any time during the simulation by changing the value of K at the MATLAB command line and updating the block diagram (e.g., by typing **Ctrl+D**).

## Example: Using a Signal Object to Initialize a Subsystem Output

The following example shows a signal object specifying the initial output of an enabled subsystem.

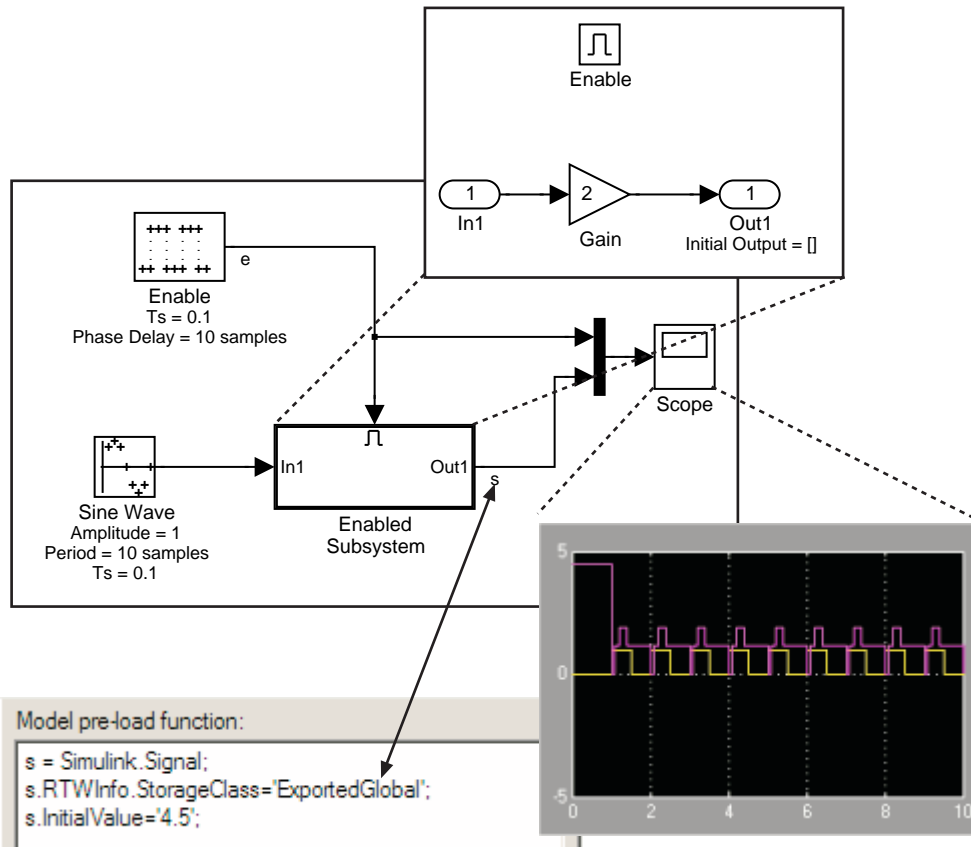

Signal `s` is initialized to 4.5. To avoid a consistency error, the initial value of the enabled subsystem's Outputport block must be `[]` or 4.5.

If you need a signal object and its initial value setting to persist across Simulink sessions, see “Create Persistent Data Objects” on page 57-78.



## Initialization Behavior Summary for Signal Objects

The following model and table show different types of signals and discrete states that you can initialize and the simulation behavior that results for each.

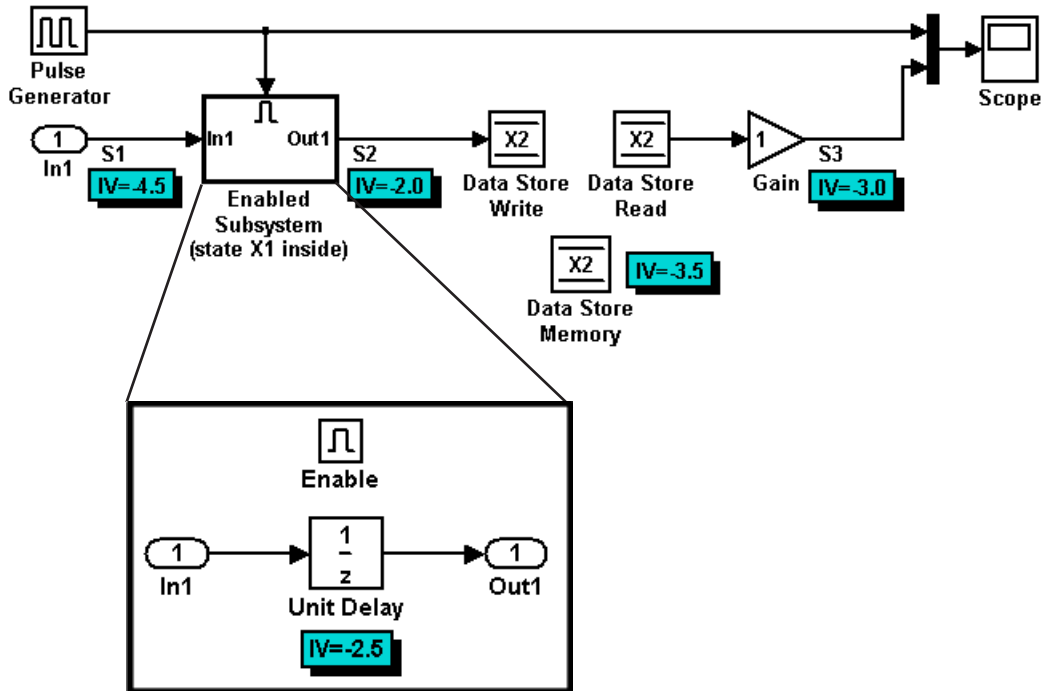

Signal or Discrete State	Description	Behavior
S1	Root inport	<ul style="list-style-type: none"> <li>• Initialized to <code>S1.InitialValue</code>.</li> <li>• If you use the <b>Data Import/Export</b> pane of the Configuration Parameters dialog to specify values for the root inputs, the initial value is overwritten and may differ at each time step. Otherwise, the value remains constant.</li> </ul>
X1	Unit Delay block — Block with a discrete state that	<ul style="list-style-type: none"> <li>• Initialized to <code>X1.InitialValue</code>.</li> <li>• Simulink checks whether <code>X1.InitialValue</code> matches the initial condition specified for the block and displays an error if a mismatch occurs.</li> </ul>

Signal or Discrete State	Description	Behavior
	has an initial condition	<ul style="list-style-type: none"> <li>At first write, the output equals <code>X1.InitialValue</code> and the state equals <code>S1</code>.</li> <li>At each time step after the first write, the output equals the state and the state is updated to equal <code>S1</code>.</li> <li>If the block is inside an enabled subsystem, you can use the initial value as a reset value if the subsystem's Enable block parameter <b>States when enabling</b> is set to <b>reset</b>.</li> </ul>
X2	Data Store Memory block	<ul style="list-style-type: none"> <li>Data type work (DWork) vector initialized to <code>X2.InitialValue</code>. For information on work vectors, see “DWork Vector Basics”.</li> <li>Simulink checks whether <code>X2.InitialValue</code> matches the initial condition specified for the block, and displays an error if a mismatch occurs.</li> <li>Data Store Write blocks overwrite the value.</li> </ul>
S2	Output of an enabled subsystem	<ul style="list-style-type: none"> <li>Initialized to <code>S2.InitialValue</code> or the value of the Outputport block. If multiple initial values are specified for the same signal, all initial values must be the same.</li> <li>The first write occurs when the subsystem is enabled. The block feeding the subsystem output sets the value.</li> <li>The initial value is also used as a reset value if the subsystem's Enable block parameter <b>States when enabling</b> or Outputport block parameter <b>Output when disabled</b> is set to <b>reset</b>.</li> </ul>
S3	Persistent signals	<ul style="list-style-type: none"> <li>Initialized to <code>S3.InitialValue</code>.</li> <li>The output value is reset by the block at each time step.</li> <li>Affects code generation only. For simulation, setting the initial value for <code>S3</code> is irrelevant because the values are overwritten at the model's simulation start time.</li> </ul>

## Related Examples

- “Create Model to Initialize, Reset, and Terminate State” on page 10-139
- “Set Block Parameter Values” on page 35-2
- “Specify Initial Conditions for Bus Signals” on page 63-99

- “Signal Basics” on page 62-2
- “Signal Values” on page 62-15

## Test Points

### In this section...

“What Is a Test Point?” on page 62-56

“Configure Signals as Test Points” on page 62-56

“Displaying Test Point Indicators” on page 62-57

### What Is a Test Point?

A *test point* is a signal that Simulink guarantees to be observable when using a Floating Scope block in a model. Simulink allows you to designate any signal in a model as a test point.

Designating a signal as a test point exempts the signal from model optimizations, such as signal storage reuse (see “Signal storage reuse”) and block reduction (see “Implement logic signals as Boolean data (vs. double)”). These optimizations render signals inaccessible and hence unobservable during simulation.

Signals designated as test points will not have algebraic loops minimized, even if **Minimize algebraic loop occurrences** is selected (for more information about algebraic loops, see “Algebraic Loops” on page 3-38).

Test points are primarily intended for use when generating code from a model with Simulink Coder. For more information about test points in the context of code generation, see “Signals with Test Points” (Simulink Coder).

Marking a signal as a test point has no impact on signal logging that uses the **Dataset** logging format. For information about logging signals, see “Export Signal Data Using Signal Logging” on page 59-70.

### Configure Signals as Test Points

Use one of the following ways to designate a signal as a test point:

- Open the signal's **Signal Properties** dialog and check **Test Point** in the **Logging and accessibility** section.
- Use the Model Data Editor for batch configuration and for signals that are difficult to locate in a large model or hierarchy of subsystems. On the **Signals** tab, set the

**Change View** drop-down list to **Instrumentation** and use the **Test point** column. For information about the Model Data Editor, see “Configure Data Properties by Using a Table” on page 57-123.

- To configure Stateflow data in a chart as test points, see “Monitor Test Points in Stateflow Charts” (Stateflow).

To configure a signal as a test point programmatically:

- 1 Get handles to the ports of the block.

```
portHandles = get_param('myModel/myBlock','portHandles');
```

portHandles is a structure. Each field stores a handle to a block port.

- 2 Extract a handle to the output port that creates the target signal line.

```
outportHandle = portHandles.Outport;
```

- 3 Set the port parameter TestPoint to 'on'.

```
set_param(outportHandle,'TestPoint','on')
```

## Displaying Test Point Indicators

By default, Simulink displays an indicator on each signal whose **Signal Properties** > **Test point** option is enabled. For example, in the following model signals **s2** and **s3** are test points:





---

**Note:** Simulink does not display an indicator on a signal that is specified as a test point by a `Simulink.Signal` object, because such a specification is external to the graphical model.

---

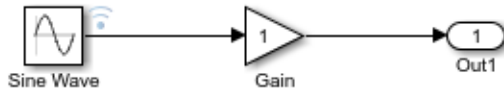
A signal that is a test point can also be logged. See “Export Signal Data Using Signal Logging” on page 59-70 for information about signal logging. The appearance of the indicator changes to indicate signals for which logging is also enabled.



To turn display of test point indicators on or off, in the Simulink Editor, select or clear **Display > Signals & Ports > Testpoint & Logging Indicators**.

### Related Examples

- “Signal Values” on page 62-15
- “Signal Basics” on page 62-2

## Display Signal Attributes

### In this section...

- “Ports & Signals Menu” on page 62-59
- “Port Data Types” on page 62-60
- “Design Ranges” on page 62-61
- “Signal Dimensions” on page 62-62
- “Signal to Object Resolution Indicator” on page 62-63
- “Wide Nonscalar Lines” on page 62-64

### Ports & Signals Menu

The **Display > Signals & Ports** submenu of the Simulink Editor offers the following options for displaying signal properties on the block diagram:

- Linearization Indicators
- Port Data Types (See “Port Data Types” on page 62-60)
- Design Ranges (See “Design Ranges” on page 62-61)
- Signal Dimensions (See “Signal Dimensions” on page 62-62)
- Storage Class
- Testpoint/Logging Indicators
- Signal Resolution Indicators (See “Signal to Object Resolution Indicator” on page 62-63)
- Viewer Indicators
- Wide Nonscalar Lines (See “Wide Nonscalar Lines” on page 62-64)

In addition, you can display sample time information. If you first select **Display > Sample Time**, a submenu provides the choices of **Colors**, **Annotations** and **All**. The **Colors** option allows the block diagram signal lines and blocks to be color-coded based on the sample time types and relative rates. The **Annotations** option provides black codes on the signal lines which indicate the type of sample time. **All** causes both the colors and the annotations to display. All of these options cause a Sample Time Legend to appear. The legend contains a description of the type of sample time and the sample time rate. If **Colors** is turned 'on', color codes also appear in the legend. The same is true if **Annotations** are turned 'on'.

## Port Data Types

Displays the data type that each signal uses for simulation and code generation. The data type appears next to the output port that emits the signal.

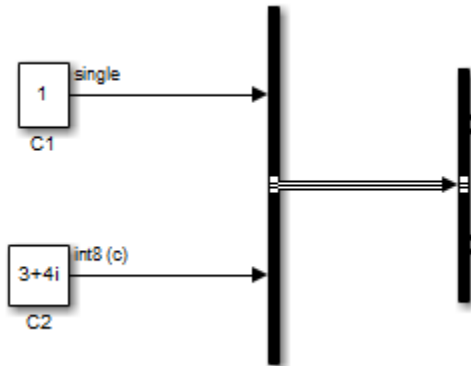

The notation (c) indicates that the signal is numerically complex (i).

If you use data type aliases (such as a `Simulink.AliasType` objects in the base workspace or a data dictionary) to set output data types in your model, by default, the diagram displays the aliases.

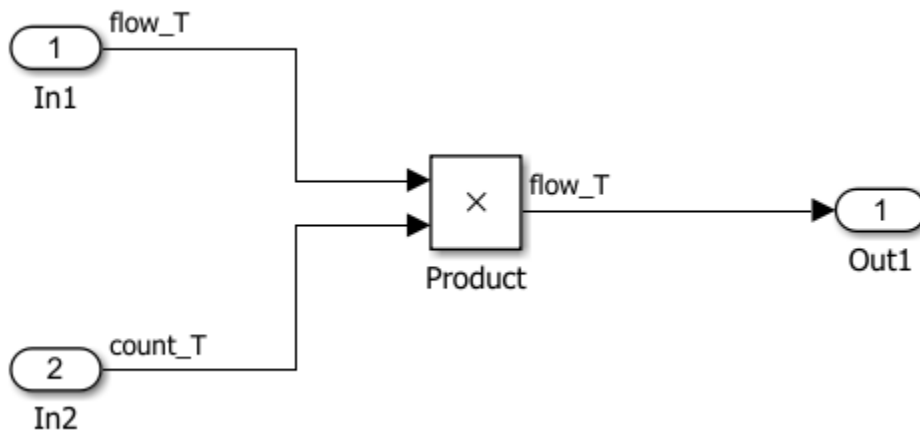



If you create a chain of aliases (for example, by using one `Simulink.AliasType` object as the base type of another `Simulink.AliasType` object), the diagram displays only the alias that you use to set the output data type of each signal. The diagram does not display the underlying aliases in the chain.

To display the lowest underlying base data type (such as `int8`, `single`, or `s16En14`) as well as the alias, in the model, select **Display > Signals and Ports > Port Data Type Display Format > Base and Alias Types**.

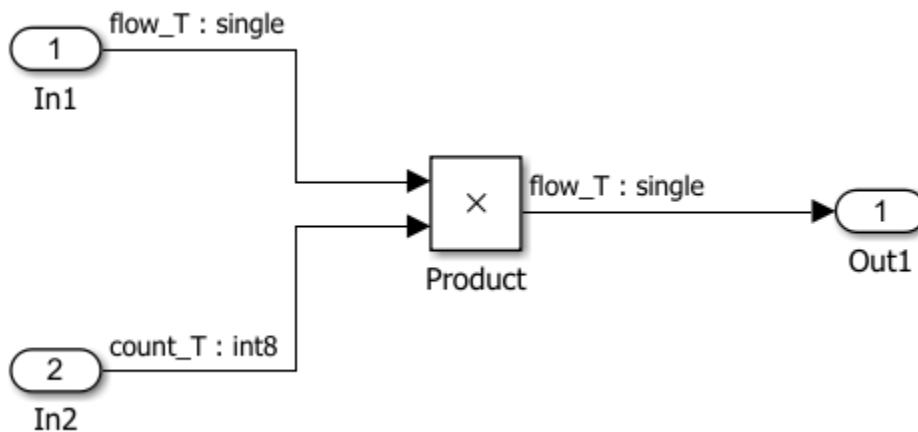

Alternatively, you can display the base type and not the alias by selecting **Base Type**.

When you use a fixed-point data type, the diagram displays the base type by using a standard notation that indicates the characteristics of the type (such as signedness and binary fraction length). To interpret this notation, see “Fixed-Point Data Type and Scaling Notation” (Fixed-Point Designer).

## Design Ranges

Displays the compiled design range of a signal next to the output port that emits the signal. The ranges are computed during an update diagram.

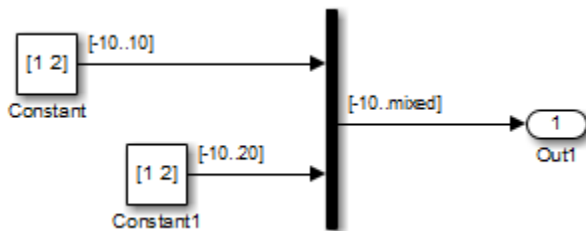

Ranges are displayed in the format  $[\text{min} \dots \text{max}]$ . In the above example, the design range at the output port of the Mux block is displayed as  $[-10 \dots \text{mixed}]$ , because the two signals the Mux block combines have the same design minimum but different design maximums.

You can also use command-line parameters `CompiledPortDesignMin` and `CompiledPortDesignMax` to access the design minimum and maximum of port signals, respectively, at compile time. For more information, see “Common Block Properties”.

## Signal Dimensions

Display the dimensions of nonscalar signals next to the line that carries the signal.

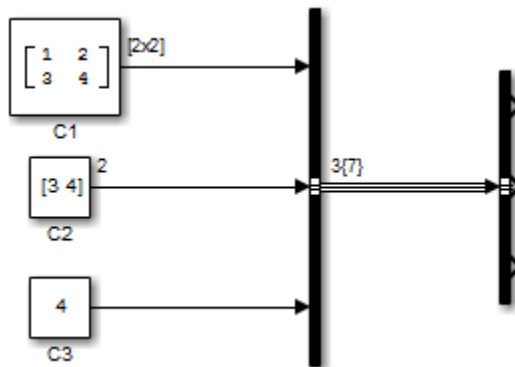

The format of the display depends on whether the line represents a single signal or a bus. If the line represents a single vector signal, Simulink displays the width of the signal. If the line represents a single matrix signal, Simulink displays its dimensions as  $[N_1 \times N_2]$  where  $N_i$  is the size of the  $i$ th dimension of the signal. If the line represents a bus carrying signals of the same data type, Simulink displays  $N\{M\}$  where  $N$  is the

number of signals carried by the bus and  $M$  is the total number of signal elements carried by the bus. If the bus carries signals of different data types, Simulink displays only the total number of signal elements  $\{M\}$ .

## Signal to Object Resolution Indicator

The Simulink Editor by default graphically indicates signals that must resolve to signal objects. For any labeled signal whose **Signal name must resolve to signal object** property is enabled, a signal resolution icon appears to the left of the signal name. The icon looks like this:



A signal resolution icon indicates only that a signal's **Signal name must resolve to signal object** property is enabled. The icon does not indicate whether the signal is actually resolved, and does not appear on a signal that is implicitly resolved without its **Signal name must resolve to signal object** property being enabled.

Where multiple labels exist, each label displays a signal resolution icon. No icon appears on an unlabeled branch. In the next figure, signal  $x2$  must resolve to a signal object, so a signal resolution icon appears to the left of the signal name in each label:

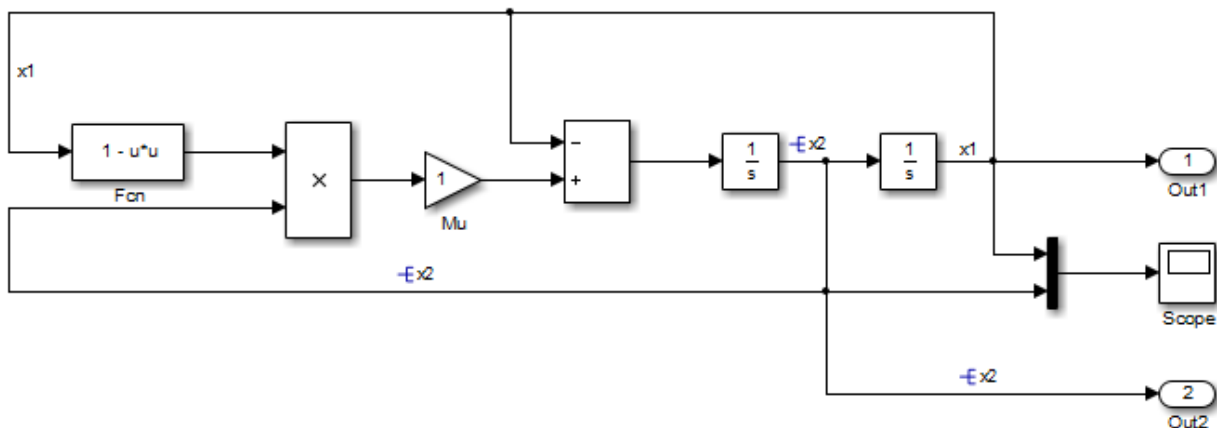

To suppress the display of signal resolution icons, in the model window deselect **Display > Signals & Ports > Signal to Object Resolution Indicator**, which is selected

by default. To restore signal resolution icons, reselect **Signal to Object Resolution Indicator**. Individual signals cannot be set to show or hide signal resolution indicators independently of the setting for the whole model. For additional information, see:

- “Symbol Resolution” on page 57-118
- “Initialize Signals and Discrete States” on page 62-48
- Simulink.Signal

## Wide Nonscalar Lines

Draws lines that carry vector or matrix signals wider than lines that carry scalar signals.

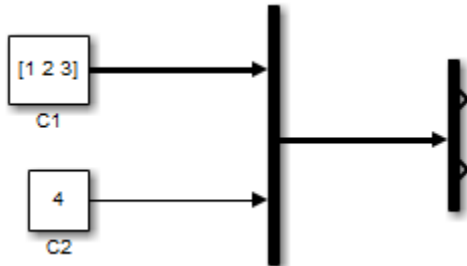

See “Mux Signals” on page 62-11 for more information about vector and matrix signals.

## Related Examples

- “Determine Output Signal Dimensions” on page 62-32
- “Display Signal Sources and Destinations” on page 62-38
- “Signal Basics” on page 62-2

# Signal Groups

## In this section...

“About Signal Groups” on page 62-65

“Using the Signal Builder Block with Fast Restart” on page 62-65

“Signal Builder Window” on page 62-66

“Creating Signal Group Sets” on page 62-80

“Editing Waveforms” on page 62-106

“Signal Builder Time Range” on page 62-111

“Exporting Signal Group Data” on page 62-112

“Printing, Exporting, and Copying Waveforms” on page 62-114

“Simulating with Signal Groups” on page 62-114

“Simulation Options Dialog Box” on page 62-115

## About Signal Groups

The Signal Builder block displays and allows you to create or edit interchangeable groups of signal sources and quickly switch the groups into and out of a model.

Signal groups can greatly facilitate testing a model, especially when you use them with conjunction with Simulink Assertion blocks and the Model Coverage Tool from the Simulink Verification and Validation. For a description of the Model Coverage Tool, see “Model Coverage Collection Workflow” (Simulink Verification and Validation).

Model Configuration Parameter **Solver** pane settings can affect the Signal Builder block output. See “Simulation Phases in Dynamic Systems” on page 3-17 and “Solvers” on page 3-21 for a description of how solvers affect simulation.

## Using the Signal Builder Block with Fast Restart

After you turn on fast restart:

- In between runs, you can change data, rename signals and signal groups, and add new groups. You cannot:
  - Import signals or signal groups

- Change signal output settings
- You can click the **Run all** button once. To reenale the **Run all** button, toggle the fast restart button on the Simulink Editor tool bar. However, **Run all** does not use fast restart.

## Signal Builder Window

The Signal Builder block window allows you to define the shape of the signals (waveform) output by the block. You can specify any waveform that is piecewise linear.

To open the window, double-click the block. The Signal Builder window appears.

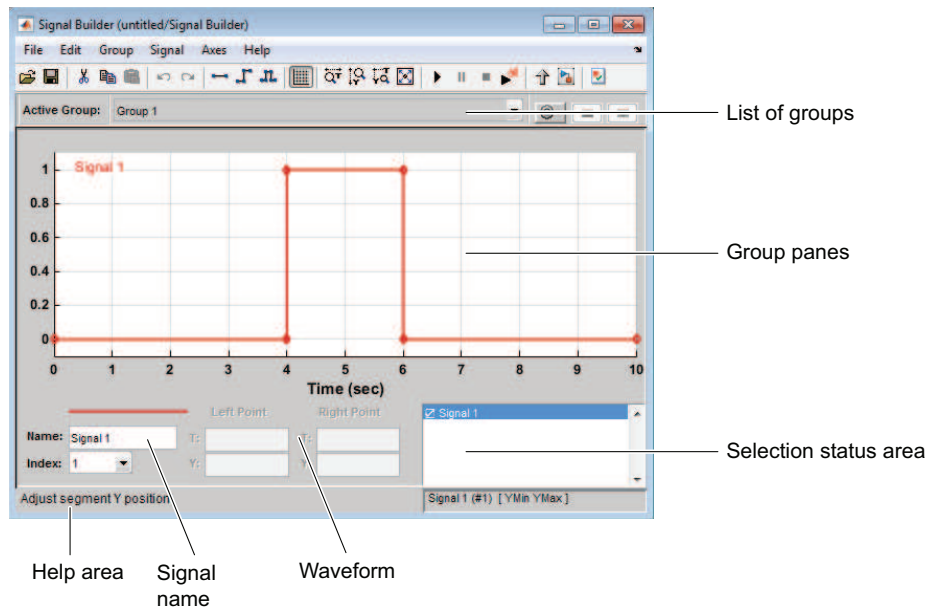

The Signal Builder window allows you to create and modify signal groups represented by a Signal Builder block. The Signal Builder window includes the following controls.

---

**Note:** The Signal Builder block adds a port for each signal you create. The block **Position** parameter limits the number of ports the Signal Builder block can have, and therefore the number of signals you can create. For more information, see the **Position** parameter at “Common Block Properties”.

---

**Group Pane**

Displays the set of interchangeable signal source groups represented by the block. The pane for each group displays an editable representation of each waveform in the group. The name of the group appears at the top of the pane. Only one pane is visible at a time. To display a group that is not visible, from the list, select the group name. The block outputs the group of signals whose pane is currently visible. Each pane occupies a pane in the Signal Builder block dialog box.

**Signal Axes**

The signals appear on separate axes that share a common time range (see “Signal Builder Time Range” on page 62-111). This presentation allows you to compare the relative timing of changes in each signal. The Signal Builder automatically scales the range of each axis to accommodate the signal that it displays. Use the Signal Builder **Axes** menu to change the time (T) and amplitude (Y) ranges of the selected axis.

**Signal List**

Displays the names and visibility (see “Editing Signals” on page 62-69) of the signals that belong to the currently selected signal group. Clicking an entry in the list selects the signal. Double-clicking a signal entry in the list hides or displays the waveform on the group pane.

**Selection Status Area**

Displays the name of the currently selected signal and the index of the currently selected waveform segment or point.

**Waveform Coordinates**

Displays the coordinates of the currently selected waveform segment or point. You can change the coordinates by editing the displayed values (see “Editing Waveforms” on page 62-106).

**Name**

Name of the currently selected signal. You can change the name of a signal by editing this field (see “Renaming a Signal” on page 62-76).

**Index**

Index of the currently selected signal. The index indicates the output port at which the signal appears. An index of 1 indicates the topmost output port, 2 indicates the second

port from the top, and so on. You can change the index of a signal by editing this field (see “Changing a Signal Index” on page 62-79).

### **Help Area**

Displays context-sensitive tips on using Signal Builder window features.

### **Editing Signal Groups**

The Signal Builder window allows you to create, rename, move, then delete signal groups from the set of groups represented by a Signal Builder block.

#### **Creating and Deleting Signal Groups**

To create a signal group:

- 1** In Signal Builder, copy an existing signal group.
- 2** Modify it to suit your needs.

To copy an existing signal group:

- 1** In Signal Builder, select the group from the list.
- 2** Select **Group > Copy**.

A new group is created.

To delete a group, select the group from the list, and select **Group > Delete**.

#### **Renaming Signal Groups**

To rename a signal group:

- 1** In Signal Builder, select the group from the list,
- 2** Select **Group > Rename**.

A dialog box appears.

- 3** Edit the existing name in the dialog box or enter a new name. Click **OK**.

#### **Moving Signal Groups**

To reposition a group in the stack of group panes:

- 1** In Signal Builder, select the pane.
- 2** To move the group lower in the stack, select **Group > Move Down**.
- 3** To move the pane higher in the stack, select **Group > Move Up**.



## Editing Signals

Signal Builder allows you to create, cut and paste, hide, and delete signals from signal groups.

## Creating Signals

To create a signal in the currently selected signal group:

- 1 In Signal Builder, from the Active Group list, select the group you want to add the signal to.
- 2 Select **Signal > New**.

The menu lists the waveforms you can add.

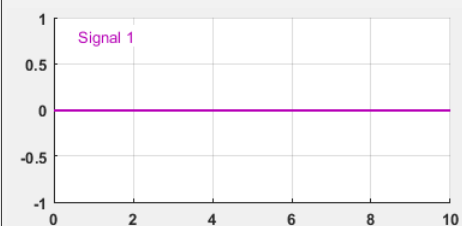
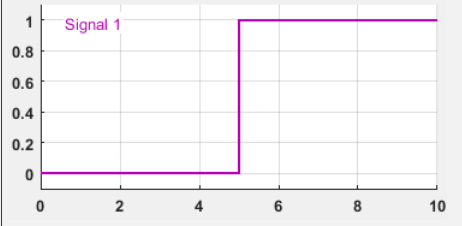
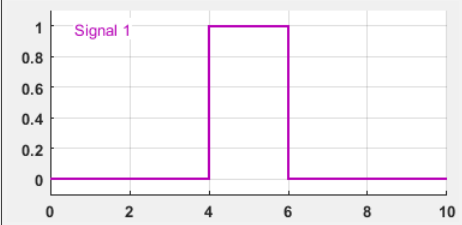
Waveform	Description	Inputs	Output
Constant	Constant waveform	None.	 <p>The graph shows a horizontal purple line at y=0 on a coordinate system where the x-axis ranges from 0 to 10 and the y-axis ranges from -1 to 1. The line is labeled 'Signal 1'.</p>
Step	Step waveform	None.	 <p>The graph shows a purple line that is at y=0 until x=5, then jumps vertically to y=1 and remains constant until x=10. The line is labeled 'Signal 1'.</p>
Pulse	Pulse waveform	None.	 <p>The graph shows a purple line that is at y=0 until x=4, jumps to y=1, stays at y=1 until x=6, and then jumps back to y=0. The line is labeled 'Signal 1'.</p>

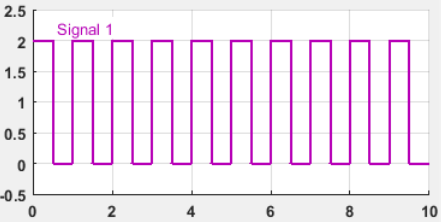
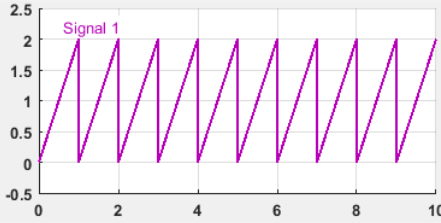
Waveform	Description	Inputs	Output
Square	Square waveform	<ul style="list-style-type: none"> <li>• <b>Frequency (Hz)</b> Waveform frequency, in hertz</li> <li>• <b>Amplitude</b> Waveform amplitude</li> <li>• <b>Y Offset</b> Waveform vertical offset</li> <li>• <b>% Duty cycle</b> Percent of the period the signal is positive (a value between 0 and 100)</li> </ul>	
Sawtooth	Sawtooth waveform	<ul style="list-style-type: none"> <li>• <b>Frequency (Hz)</b> Waveform frequency, in hertz.</li> <li>• <b>Amplitude</b> Waveform amplitude</li> <li>• <b>Y Offset</b> Waveform vertical offset</li> </ul>	

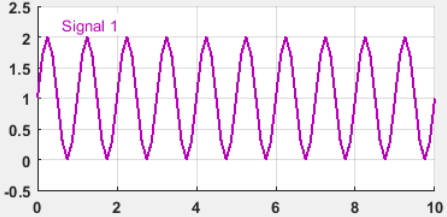
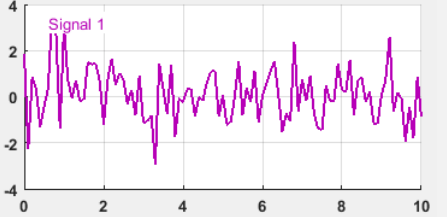
Waveform	Description	Inputs	Output
Sampled Sin	Sampled sinewave waveform	<ul style="list-style-type: none"> <li>• <b>Frequency (Hz)</b> Waveform frequency, in hertz</li> <li>• <b>Amplitude</b> Waveform amplitude</li> <li>• <b>Y Offset</b> Waveform vertical offset</li> <li>• <b>Samples Per Period</b> Number of samples per waveform period</li> </ul>	
Sampled Gaussian Noise	Sampled Gaussian noise waveform based on a Gaussian distribution with input mean and standard deviation at input frequency	<ul style="list-style-type: none"> <li>• <b>Frequency (Hz)</b> Waveform frequency, in hertz</li> <li>• <b>Mean</b> The mean value of the random variable output</li> <li>• <b>Standard Deviation</b> The standard deviation squared of the random variable output</li> <li>• <b>Seed (empty to use current state)</b> The initial seed value for the random number generator</li> </ul>	

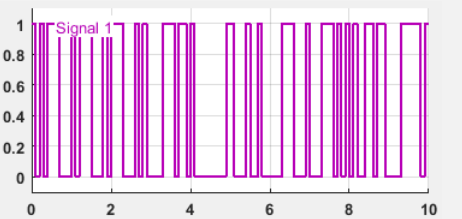
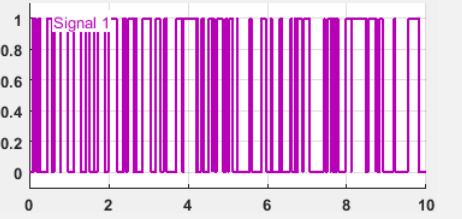
Waveform	Description	Inputs	Output
Pseudorandom Noise	Pseudorandom noise waveform based on a binomial distribution with upper and lower values at input frequency	<ul style="list-style-type: none"> <li>• <b>Frequency (Hz)</b> Frequency with which waveform fluctuates between <b>Upper value</b> and <b>Lower value</b>, in hertz</li> <li>• <b>Upper value</b> Upper limit of signal</li> <li>• <b>Lower value</b> Lower limit of signal</li> <li>• <b>Seed</b> The initial seed value for the random number generator</li> </ul>	 <p>The graph shows a square wave signal labeled 'Signal 1' over a time interval from 0 to 10. The vertical axis ranges from 0 to 1. The signal fluctuates between 0 and 1 with a non-uniform frequency, characteristic of a binomial distribution.</p>
Poisson Random Noise	Poisson random noise waveform that alternates between 0 and 1	<ul style="list-style-type: none"> <li>• <b>Avg rate (1/sec)</b> Average rate of transition between 0 and 1</li> <li>• <b>Seed (empty to use current state)</b> The initial seed value for the random number generator</li> </ul>	 <p>The graph shows a square wave signal labeled 'Signal 1' over a time interval from 0 to 10. The vertical axis ranges from 0 to 1. The signal alternates between 0 and 1 with a higher frequency than the pseudorandom noise, showing a more regular but still random pattern.</p>

Waveform	Description	Inputs	Output
Custom	Custom piecewise linear waveform; custom values must fit within the display area	<ul style="list-style-type: none"> <li>• <b>Time values</b> Vector of two or more time coordinates</li> <li>• <b>Y values</b> Vector of two or more signal amplitudes that correspond to the values in <b>Time values</b></li> </ul> <p>The entries in either field can be any MATLAB expression that evaluates to a vector, including the results from the evaluation of a MATLAB workspace variable. The resulting vectors must be of equal length.</p> <hr/> <p><b>Note:</b> Signal Builder displays a warning if you add a custom waveform with a large number of data points (100,000,000 or more).</p>	

- 3 Select the waveform you want to add.
- 4 Specify the inputs (in prompt), and click **OK**.

If you select a standard waveform, Signal Builder adds a signal with that waveform to the group. If you select a custom waveform, you are prompted for **Time values** and **Y values**.

You can also use MATLAB workspace variables to create new signals.

- 1 In the MATLAB Command Window, create data for two variables,  $t$  and  $y$ .

```
t = 1:10  
y = 1:10
```

These vectors must be the same size.

- 2 Create a model and add a Signal Builder block.
- 3 Double-click the Signal Builder block.
- 4 Select **Signal > New > Custom**.
- 5 In the Custom Waveform window, enter  $t$  in the **Time values** field and  $y$  in the **Y values** field and then click **OK**.

The Signal Builder block window displays the new signal as Signal 2.

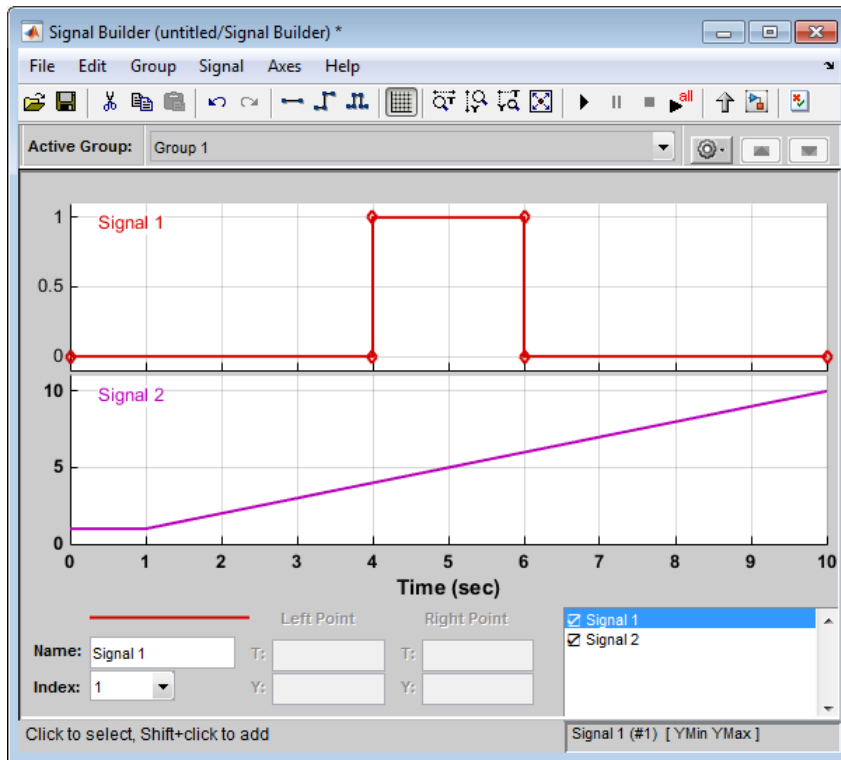

### Defining Signal Output

To specify the type of output to use for sending test signals:

1 In Signal Builder, select **Signal > Output**.

2 From the list, select:

- **Ports**

Default. Sends individual signals from the block. An output port named Signal *N* appears for each Signal *N*.

- **Bus**

Sends single, virtual, nonhierarchical bus of signals from the block. An output port named Bus appears.

---

**Tip:**

- You cannot use the **Bus** option to create a bus of nonvirtual signals.
  - The **Bus** option enables you to change your model layout without having to reroute Signal Builder block signals. Use the Bus Selector block to select the signals from this bus.
  - If you create a Signal Builder block using the Signal & Scope Manager or using the **Create & Connect Generator** option from a signal line context menu, you cannot define signal output. In these cases, the block sends individual signals.
- 

### Copying and Pasting Signals

To copy a signal from one group and paste it into another group as a new signal:

1 In Signal Builder, select the signal you want to copy.

2 Select **Edit > Copy**.

3 Select the group you want to paste the signal into.

4 Select **Edit > Paste**.

To copy a signal from one axis and paste it into another axis to replace its signal:

1 Select the signal you want to copy.

- 2 Select **Edit > Copy**.
- 3 Select the signal on the axis that you want to update.
- 4 Select **Edit > Paste**.

### Deleting Signals

To delete a signal, in Signal Builder, select the signal and choose **Delete** or **Cut** from the **Edit** menu. Signal Builder deletes the signal from the current group. Because each signal group must contain the same number of signals, Signal Builder also deletes all signals sharing the same index in the other groups.

### Renaming a Signal

To rename a signal:

- 1 In Signal Builder, select **Signal > Rename**.  
A dialog box appears with an edit field that displays the current name of the signal.
- 2 Edit or replace the current name with a new name.
- 3 Click **OK**.

You can also edit the signal name in the **Name** field in the lower-left corner of the Signal Builder window.

### Replacing a Signal

To replace a signal:

- 1 In Signal Builder, select the signal, then select **Signal > Replace with**.  
A menu of waveforms appears. It includes a set of standard waveforms (**Constant**, **Step**, and so on) and a **Custom** waveform option.
- 2 Select one of the waveforms.

If you select a standard waveform, the Signal Builder replaces a signal in the currently selected group with that waveform. For other waveforms, the Signal Builder displays a dialog to allow you to provide input for the requested waveform.

Waveform	Description	Inputs
Constant	Constant waveform.	None.
Step	Step waveform.	None.
Pulse	Pulse waveform.	None.



Waveform	Description	Inputs
Square	Square waveform.	<ul style="list-style-type: none"> <li>• <b>Frequency (Hz)</b> Waveform frequency, in Hertz.</li> <li>• <b>Amplitude</b> Waveform amplitude.</li> <li>• <b>Y Offset</b> Waveform vertical offset.</li> <li>• <b>% Duty cycle</b> Percent of the period in which the signal is positive. Enter a value between 0 and 100.</li> </ul>
Sawtooth	Sawtooth waveform.	<ul style="list-style-type: none"> <li>• <b>Frequency (Hz)</b> Waveform frequency, in Hertz.</li> <li>• <b>Amplitude</b> Waveform amplitude</li> <li>• <b>Y Offset</b> Waveform vertical offset.</li> </ul>
Sampled Sin	Sampled sinewave waveform.	<ul style="list-style-type: none"> <li>• <b>Frequency (Hz)</b> Waveform frequency, in Hertz.</li> <li>• <b>Amplitude</b> Waveform amplitude</li> <li>• <b>Y Offset</b> Waveform vertical offset.</li> <li>• <b>Samples Per Period</b> Number of samples per waveform period.</li> </ul>

Waveform	Description	Inputs
Sampled Gaussian Noise	Sampled Gaussian noise waveform based on a Gaussian distribution with input mean and standard deviation at input frequency.	<ul style="list-style-type: none"> <li>• <b>Frequency (Hz)</b> Waveform frequency, in Hertz.</li> <li>• <b>Mean</b> The mean value of the random variable output.</li> <li>• <b>Standard Deviation</b> The standard deviation squared of the random variable output.</li> <li>• <b>Seed (empty to use current state)</b> The initial seed value for the random number generator.</li> </ul>
Pseudorandom Noise	Pseudorandom noise waveform based on a binomial distribution with upper and lower values at input frequency.	<ul style="list-style-type: none"> <li>• <b>Frequency (Hz)</b> Frequency with which waveform fluctuates between <b>Upper value</b> and <b>Lower value</b>, in Hertz.</li> <li>• <b>Upper value</b> Upper limit of signal.</li> <li>• <b>Lower value</b> Lower limit of signal.</li> <li>• <b>Seed</b> The initial seed value for the random number generator</li> </ul>
Poisson Random Noise	Poisson random noise waveform that alternates between 0 and 1.	<ul style="list-style-type: none"> <li>• <b>Avg rate (1/sec)</b> Average rate of transition between 0 and 1.</li> <li>• <b>Seed (empty to use current state)</b> The initial seed value for the random number generator</li> </ul>

Waveform	Description	Inputs
Custom	Custom piecewise linear waveform. Custom values must fit within the display area.	<ul style="list-style-type: none"> <li>• <b>Time values</b> Vector of two or more time coordinates.</li> <li>• <b>Y values</b> Vector of two or more signal amplitudes that correspond to the values in <b>Time values</b>.</li> </ul> <p>The entries in either field can be any MATLAB expression that evaluates to a vector. The resulting vectors must be of equal length.</p> <hr/> <p><b>Note:</b> Signal Builder returns a warning if you add a custom waveform with a large number of data points (100,000,000 or more). You can then cancel the action.</p>

You can also edit the signal name in the **Name** field in the lower-left corner of the Signal Builder window.

### Changing a Signal Index

To change a signal index:

- 1 In Signal Builder, select the signal, then select **Signal > Change Index**.

A dialog box appears with a drop-down list field containing the existing index of the signal.

- 2 From the drop-down list, another index and select **OK**. Or select an index from the **Index** list in the lower-left corner of the Signal Builder window.

### Hiding Signals

By default, the Signal Builder window displays the group waveforms in the group pane. To hide a waveform:

- 1 In Signal Builder, select the waveform, then select **Signal > Hide**.
- 2 To redisplay a hidden waveform, select the **Group** pane, then select **Signal > Show**.

- 3 Select the signal from the list. Alternatively, you can hide and redisplay a hidden waveform by double-clicking its name in the Signal Builder signal list (see “Signal List” on page 62-67).

## Creating Signal Group Sets

You can create signal groups in the Signal Builder block by:

- “Creating Signal Group Sets Manually” on page 62-80
- “Importing Signal Group Sets” on page 62-81
- “Importing Data with Custom Formats” on page 62-105

You can also use the `signalbuilder` function to populate the Signal Builder block.

### Creating Signal Group Sets Manually

This topic describes how to create signal group sets manually. If you have signal data files, such as those from test cases, consider importing this data as described in “Importing Signal Group Sets” on page 62-81.

To create an interchangeable set of signal groups:

- 1 Drag an instance of the Signal Builder block from the Simulink Sources library and drop it into your model.

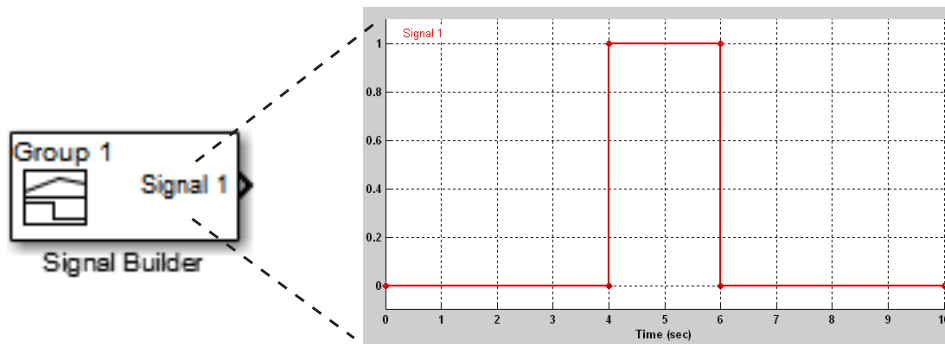

By default, the block represents a single signal group containing a single signal source that outputs a square wave pulse.

- 2 Use the block signal editor (see “Signal Builder Window” on page 62-66) to create additional signal groups, add signals to the signal groups, modify existing signals and signal groups, and select the signal group that the block outputs.

---

**Note:** Each signal group must contain the same number of signals.

---

- 3 Connect the output of the block to your diagram.

The block displays an output port for each signal that the block can output.

You can create as many Signal Builder blocks as you like in a model, each representing a distinct set of interchangeable groups of signal sources. When a group has multiple signals, the signals might have different end times. However, Signal Builder block requires the end times of signals within a group to match. If a mismatch occurs, Signal Builder block matches the end times by holding the last value of the signal with the smaller end time.

See “Simulating with Signal Groups” on page 62-114 for information on using signal groups in a model.

### Importing Signal Group Sets

The topics in this section describe how to import signal data into the Signal Builder block. You should already have a signal data file whose contents you want to import. For example, you might have signal data from previously run test cases. See “Importing Signal Groups from Existing Data Sets” on page 62-81 for a description of the data formats that the Signal Builder block accepts. The procedures in the following topics use the file `3Grp_3Sig.xls` in the folder `matlabroot\help\toolbox\simulink\ug\examples\signals` (open).

Signal Builder accepts signals only of type double.

### Importing Signal Groups from Existing Data Sets

You might have existing signal data sets that you want to enter into the Signal Builder block. The **File > Import from File** command on the Signal Builder window starts the Import File dialog box. This dialog box is modal, which means that focus cannot change to another MATLAB window while the dialog box is running. If you want to see changes in the Signal Builder window after you import data, do one of the following:

- Close the Import File dialog box.
- Set up the Import File dialog box and Signal Builder window side by side.

---

**Note:** You cannot undo the results of importing a signal data file. In addition, you cannot undo the last action performed before opening the Import File dialog box. When you close the Import File dialog box, the **Undo last edit** and **Redo last edit** buttons on the Signal Builder window are grayed out. These buttons are grayed out regardless of whether you imported a data file.

---

The Import File dialog box accepts the following appropriately formatted file types:

- Microsoft Excel (.xls, .xlsx)
- Comma-separated value (CSV) text files (.csv)
- MAT-files (.mat)

---

**Note:** Signal Builder block uses the `xlsread` function. See the `xlsread` documentation for information on supported platforms.

---

You can import your data set file only if it is appropriately formatted.

For Microsoft Excel spreadsheets:

- The Signal Builder block interprets the first row as signal name. If you do not specify a signal name, the Signal Builder block assigns a default one with the format `Imported_Signal #`, where `#` increments with each additional unnamed signal.
- The Signal Builder block interprets the first column as time. In this column, the time values must increase.
- The Signal Builder block interprets the remaining columns as signals.
- If there are multiple sheets:
  - Each sheet must have the same number of signals (columns).
  - Each sheet must have the same set of signal names (if any).
  - Each column on each sheet must have the same number of rows.
- Signal Builder block interprets each worksheet as a signal group.

This example contains an acceptably formatted Microsoft Excel spreadsheet. It has three worksheets named Group1, Group2, and Group3, representing three signal groups.

Time must be first column

1	Time	DC In	Trigger	AC In	
2		0	1	2	3
3		1	2	3	4
4		2	3	4	5
5		3	4	5	6
6		4	5	6	7
7		5	6	7	8
8		6	7	8	9
9		7	8	9	10
10		8	9	10	11
11		9	10	11	12
12		10	11	12	13
13		11	12	13	14
14		12	13	14	15
15		13	14	15	16
16		14	15	16	17
17		15	16	17	18
18					

Signal names (optional)

Worksheets - equivalent to signal group

For CSV text files:

- Each file contains only numbers. Do not name signals in a CSV file.
- The Signal Builder block interprets the first column as time. In this column, the time values must increase.
- The Signal Builder block interprets the remaining columns as signals.
- Each column must have the same number of entries.
- The Signal Builder block interprets each file as one signal group.
- The Signal Builder block assigns a default signal name to each signal with the format `Imported_Signal #`, where `#` increments with each additional signal.

This example contains an acceptably formatted CSV file. The contents represent one signal group.

```
0,0,0,5,0
1,0,1,5,0
2,0,1,5,0
3,0,1,5,0
4,5,1,5,0
5,5,1,5,0
6,5,1,5,0
7,0,1,5,0
8,0,1,5,1
9,0,1,5,1
10,0,1,5,0
```

For MAT-files:

- The Signal Builder block supports data store logging that the Simulink.SimulationData.Dataset object represents and interprets this data as a single group.
- The Signal Builder block supports Simulink output saved as a structure with time.
- The Signal Builder block supports the Signal Builder data format. This format is a group of cell arrays that must be labeled:
  - time
  - data
  - sigName
  - groupName

sigName and groupName are optional.

- For backwards compatibility, the Signal Builder block supports logged data from the Simulink.ModelDataLogs object and interprets this data as a single group. The ModelDataLogs format will be removed in a future release.
- Signal Builder block does not support:
  - Simulink output as only a structure
  - Simulink output as only an array



---

**Note:** Signal Builder returns a warning if you import a large number of data points (100,000,000 or more). You can then cancel the action.

---

This example contains an acceptably logged MATLAB workspace. Use the MATLAB workspace **Save** command to save the variables to a MAT-file. Import this file to the Signal Builder block.

#### **Signal Builder Block Import File Dialog Box**

The Signal Builder Import File dialog box allows you to import existing signal data files into the Signal Builder block.

Signal data file to import

Repository of data import status messages

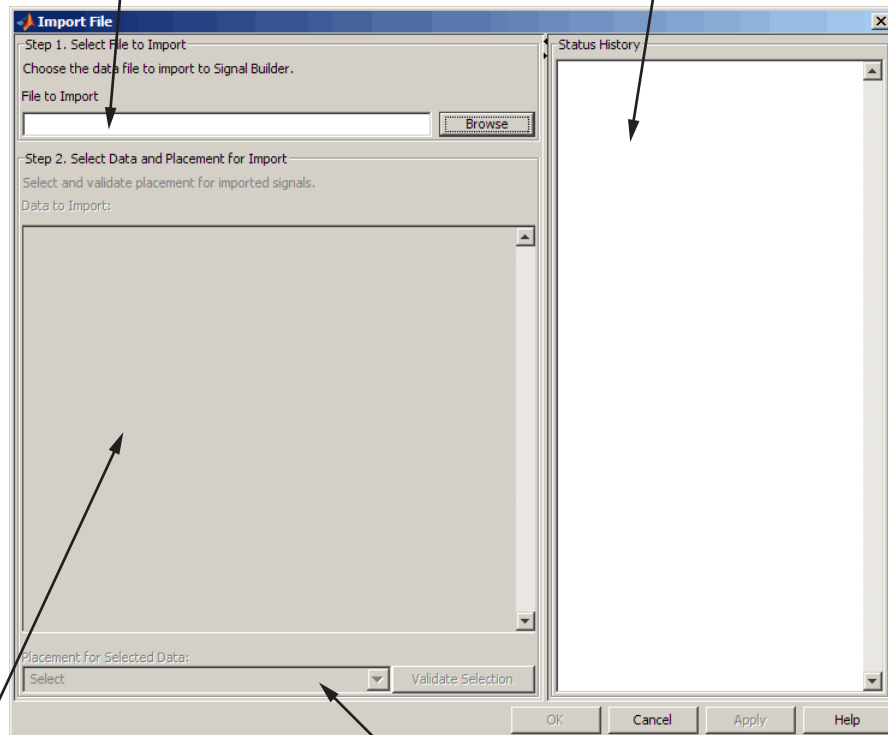

Tree view of signal data file contents

Drop-down list of import actions for signal data

### Replacing All Signal Data with Selected Data

Simulink software creates a default Signal Builder block with one signal. To replace this signal and all other signal data that the block might display:

- 1 Create a model and drag a Signal Builder block into that model.
- 2 Double-click the block.

---

The Signal Builder window appears with its default Signal 1.

- 3 In Signal Builder, select **File > Import from File**.

The Import File dialog box appears.

- 4 In the **File to Import** field, enter a signal data file name or click **Browse**.

The file browser appears.

- 5 If you select the file browser, navigate to and select a signal data file. For example, select 3Grp\_3Sig.xls.

---

**Note:** If you try to import an improperly formatted data file, an error message pops up. When you click to dismiss this window, the **Status History** pane displays a more detailed error message (if there is one). For example:

```
File 'signals.mat' format does not  
comply with Signal Builder required format.  
There is no 'time' parameter defined.
```

```
.....
```

---

The **Data to Import** pane contains the signal data from the file. Click the expander to display all the signals.

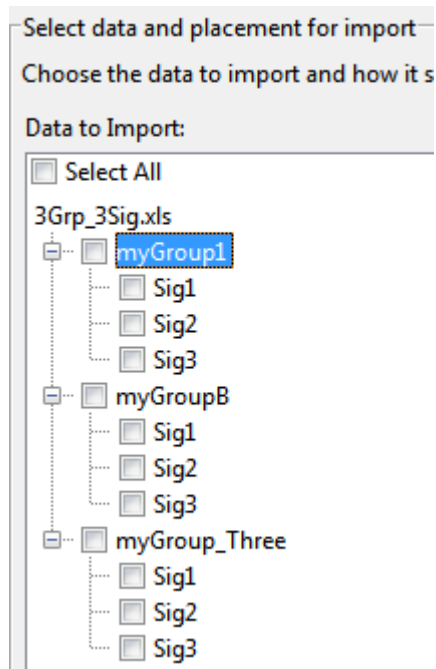

- 6 Select the signals you want to import. To import all the signals, click **Select All**.
- 7 From the **Placement for Selected Data** list, select the action to take on the signal data. For example, select **Replace existing dataset**.

The **Confirm Selection** button is activated. Validate your signal selection before the Signal Builder block performs the specified action. If the signal data selection is not appropriate, **Confirm Selection** remains grayed out. For example, **Confirm Selection** remains grayed out if the number of signals you select is not the same as the number of signals in the Signal Builder group that you want to replace.

- 8 Click the **Confirm Selection** button.

If the requested action is a valid one, the Status History pane displays messages to indicate the status. For example:

Current data in Signal Builder will be replaced  
by new data.

Number of groups: 3

Group name(s):

myGroup1

myGroupB

myGroup\_Three

Number of signals per group: 3

Signal name(s):

Sig1

Sig2

Sig3

(Names may have been renamed for uniqueness.)

.....

The confirmation also enables the **OK** and **Apply** buttons.

- 9 If you are satisfied with the status message, click **Apply** to replace the existing signal data with the contents of this file.

When selecting **Replace existing dataset**, the software gives you the opportunity to save the existing contents of the Signal Builder block.

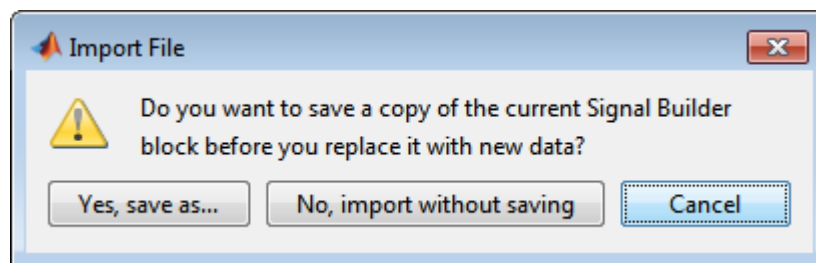

- 10 Click a button, as follows:

To...	Click...
Save the contents of the Signal Builder block before replacing it with the new signal data.	<b>Yes, save as</b>

To...	Click...
<b>Note:</b> This selection prompts you to save the Signal Builder block in a model name of your choice. The software saves only the Signal Builder block and no other model content.	
Replace the contents of the Signal Builder block without saving them first.	<b>No, import without saving</b>
Stop the replacement process.	<b>Cancel</b>

For this example, select **No, import without saving** to replace the contents of the Signal Builder block.

- 11 The Signal Builder block updates with the new signal data. Click **OK** to close the Import File dialog box and inspect the Signal Builder block.

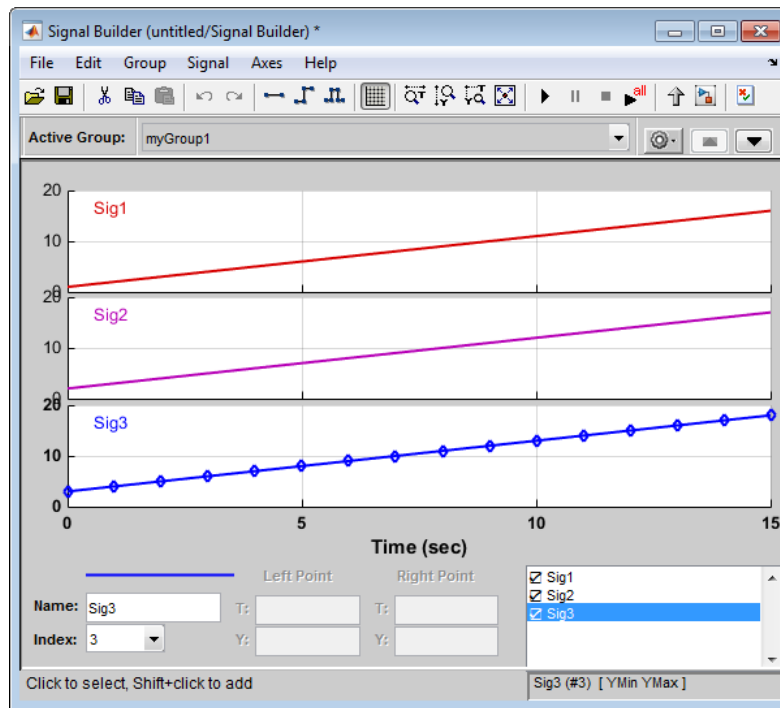

12 Click **OK**.

13 Inspect the updated Signal Builder window to confirm that your signal data is intact.

14 Close the Signal Builder window and save and close the model. For example, save the model as `signalbuilder1`.

### Appending Selected Signals to All Existing Signal Groups

You can import signals from a signal data file and append selected signals to the end of all existing signal groups. If the signal names to be appended are not unique, the software renames them by incrementing each name by 1 or higher until it is a unique signal name. For example, if the block and data file contain signals named `thermostat`, the software renames the imported signal to `thermostat1` upon appending. If you add another signal named `thermostat`, the software names that latest version `thermostat2`.

This topic uses `signalbuilder1` from the procedure in “Replacing All Signal Data with Selected Data” on page 62-86.

- 1 In the MATLAB Command Window, type `signalbuilder1`.
- 2 Double-click the Signal Builder block.

The Signal Builder window appears.

- 3 In the Signal Builder window, select **File > Import from File**.

The Import File dialog box appears.

- 4 In the **File to Import** field, enter a signal data file name or click **Browse**.

The file browser is displayed.

- 5 If you select the file browser, navigate to and select a signal data file. For example, select `3Grp_3Sig.xls`.

---

**Note:** If you try to import an improperly formatted signal data file, an error message pops up. When you click to dismiss this window, the **Status History** pane displays an error message. For example:

```
File 'signals.mat' format does not  
comply with Signal Builder required format.  
There is no 'time' parameter defined.  
.....
```

---

The **Data to Import** pane contains the signal data from the file. Click the expander to display all the signals.

- 6 Select the signals you want to import. In this example, there are three groups, `myGroup1`, `myGroupB`, and `myGroup_Three`. Select all the signals in `myGroup1`.

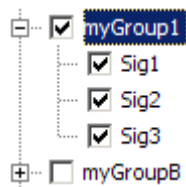

- 7 From the **Placement for Selected Data** list, select the action to take on the signal data. For example, select `Append selected signals to all groups`.



The **Confirm Selection** button is activated. Validate your signal selection before the Signal Builder block performs the specified action. If the signal data selection is not appropriate, **Confirm Selection** remains grayed out. For example, **Confirm Selection** remains grayed out if the number of signals you select is not the same as the number of signals in the Signal Builder group that you want to replace.

- 8 Click the **Confirm Selection** button.

If the requested action is a valid one, the Status History pane displays messages to indicate the state. For example:

```

3 signal(s) will be appended to each group.
Selected signal name(s):
Before:
  Sig1
  Sig2
  Sig3

After:
  Sig4
  Sig5
  Sig6

Signal name(s) in the block:
Before:
  Sig1
  Sig2
  Sig3

After:
  Sig1
  Sig2
  Sig3
  Sig4
  Sig5
  Sig6

(Name(s) may have been renamed for uniqueness.)
.....

```

The confirmation also enables the **OK** and **Apply** buttons.

Observe the **Before** and **After** headings for the signals. These sections indicate the names of the block and imported data signals before and after the append action.

- 9 If you are satisfied with the status message, click **Apply** to append the selected signals to all the signal groups in the Signal Builder block.
- 10 The Signal Builder block updates with the new signal data. Click **OK** to close the Import File dialog box and inspect the Signal Builder block.

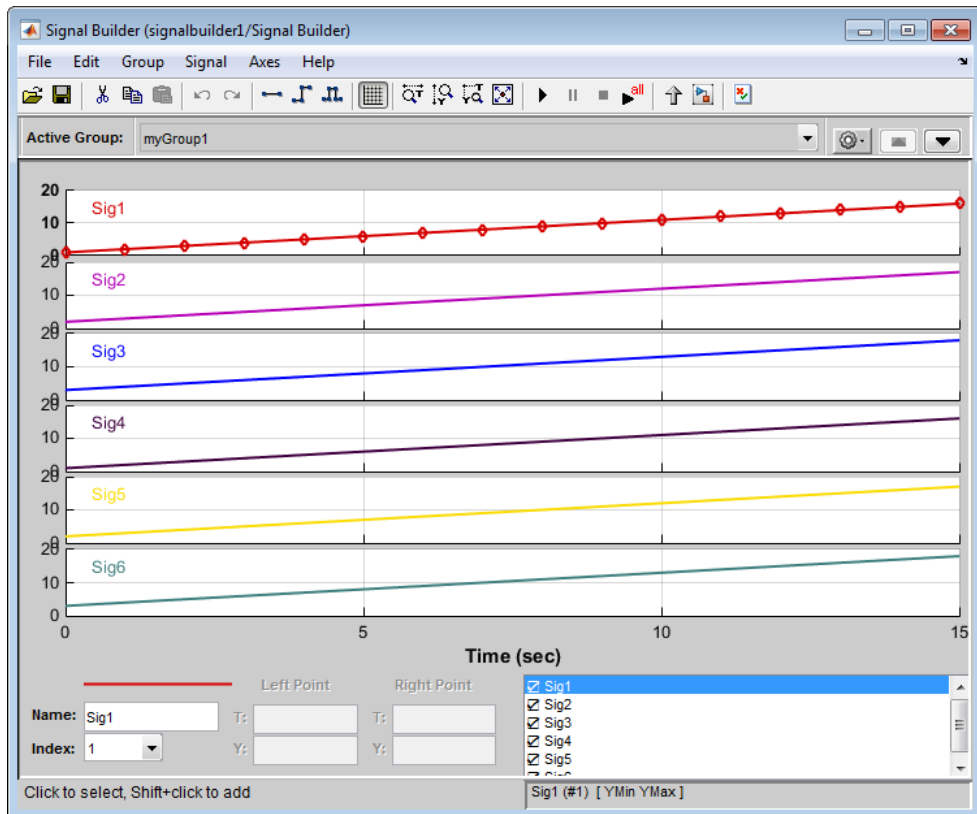

- 11 Click **OK**.
- 12 Inspect the updated Signal Builder window to confirm that your signal data is intact. Notice that the software has renamed the signals Sig1, Sig2, and Sig3 from the signal data file to Sig4, Sig5, and Sig6 in the Signal Builder block.
- 13 Close the Signal Builder window and save and close the model. For example, save the model as `signalbuilder2`.

### Appending Selected Signals to Sequential Existing Signal Groups

You can append signals, in the order in which they are selected, to the end of sequential signal groups. This statement means that you select the same number of signals as there are signal groups, and sequentially append each signal to a different group. The software renames each appended signal to the name of the last appended signal.

This topic uses `signalbuilder1` from the procedure in “Replacing All Signal Data with Selected Data” on page 62-86.

- 1 In the MATLAB Command Window, type `signalbuilder1`.
- 2 Double-click the Signal Builder block.

The Signal Builder window appears.

- 3 Note how many groups exist in the Signal Builder block. For example, this Signal Builder block has three groups, `myGroup1`, `myGroupB`, and `myGroup_Three`.

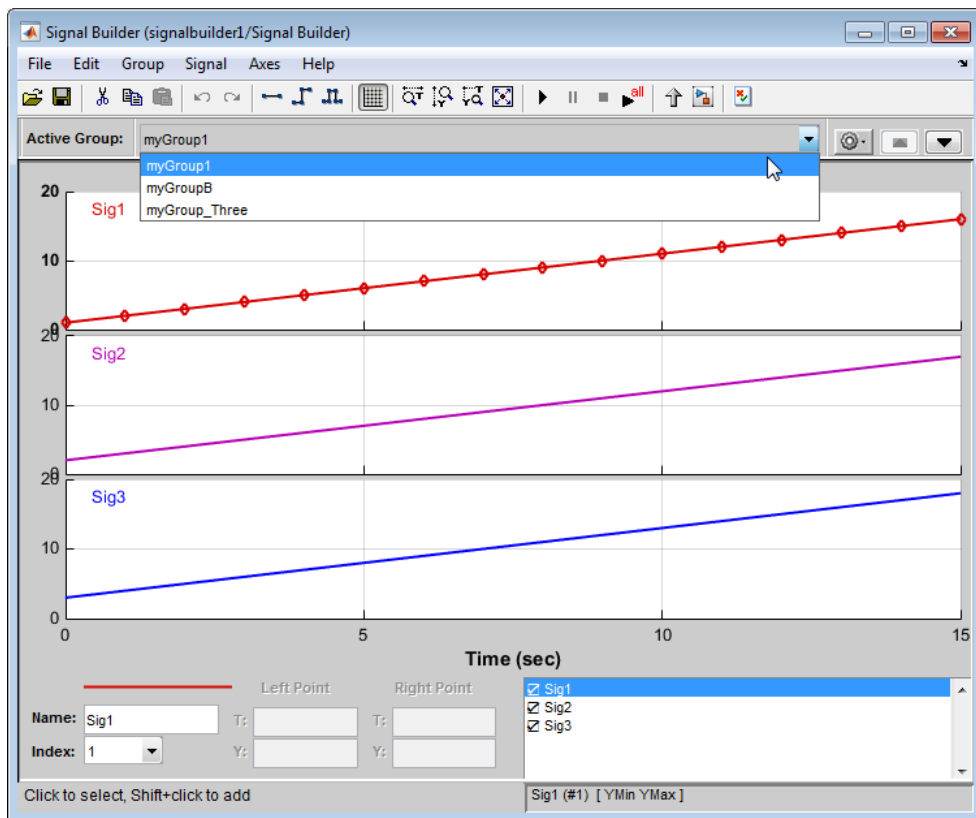

- 4 In the Signal Builder window, select **File > Import from File**.

The Import File dialog box appears.

- 5 In the **File to Import** field, enter a signal data file name or click **Browse**.

The file browser appears.

- 6 If you select the file browser, navigate to and select a signal data file. For example, select 3Grp\_3Sig.xls.

---

**Note:** If you try to import an improperly formatted signal data file, an error message popup window. When you click to dismiss this window, the **Status History** pane displays an error message. For example:

```
File 'signals.mat' format does not  
comply with Signal Builder required format.  
There is no 'time' parameter defined.  
.....
```

---

The **Data to Import** pane contains the signal data from the file. Click the expander to display all the signals.

- 7 Select the signals you want to import. In this example, there are three groups, myGroup1, myGroupB, and myGroup\_Three. Select all the signals in myGroup1.

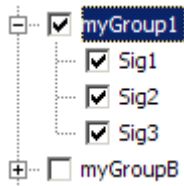

- 8 From the **Placement for Selected Data** list, select the action to take on the signal data. For example, select **Append selected signals to different groups (in order)**.

The **Confirm Selection** button is activated. Validate your signal selection before the Signal Builder block performs the specified action.

- 9 Click the **Confirm Selection** button.

If the requested action is a valid one, the Status History pane displays messages to indicate the state. For example:

1 signal will be appended to each group.

Selected signal names:

Before:

Sig1

Sig2

Sig3

Selected unique signal name:

After:

Sig4

The confirmation also enables the **OK** and **Apply** buttons.

- 10** If you are satisfied with the status message, click **Apply** to append the signals.

The Signal Builder block updates with the new signal data. Click **OK** to close the Import File dialog box and inspect the three groups of the Signal Builder block.

The topmost signal group, myGroup1, shows all signals by default, including the new Sig4.

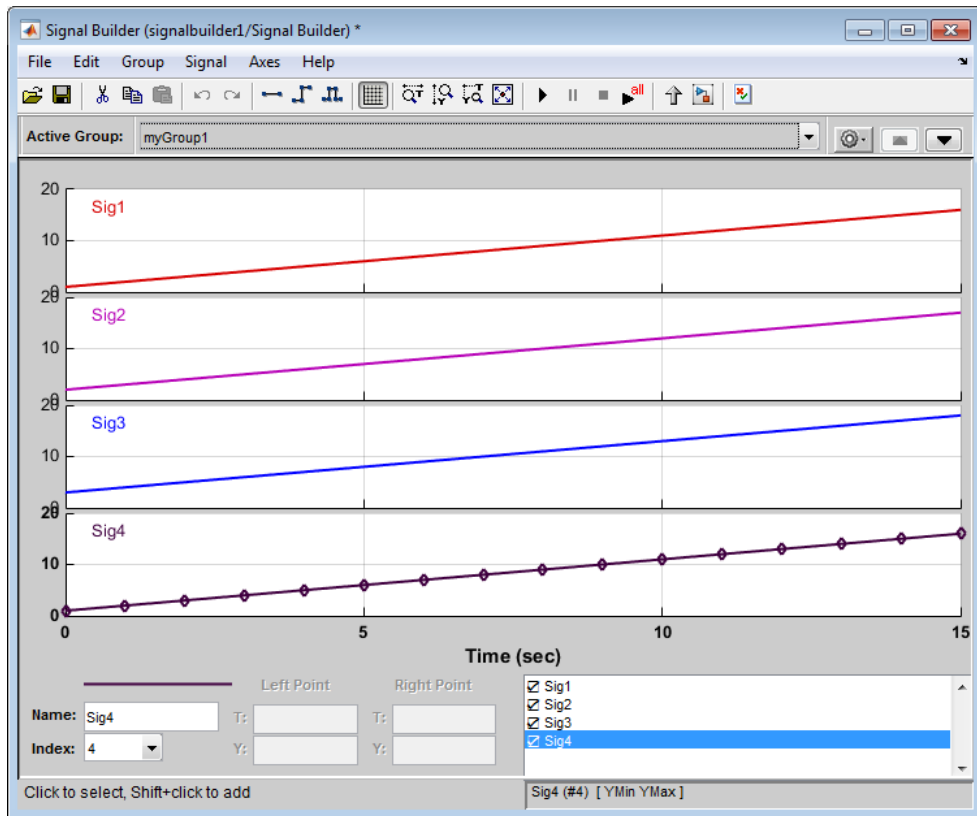

- 11 Click another group name, for example, myGroupB. Notice that Sig4 exists for the group, hidden by default.

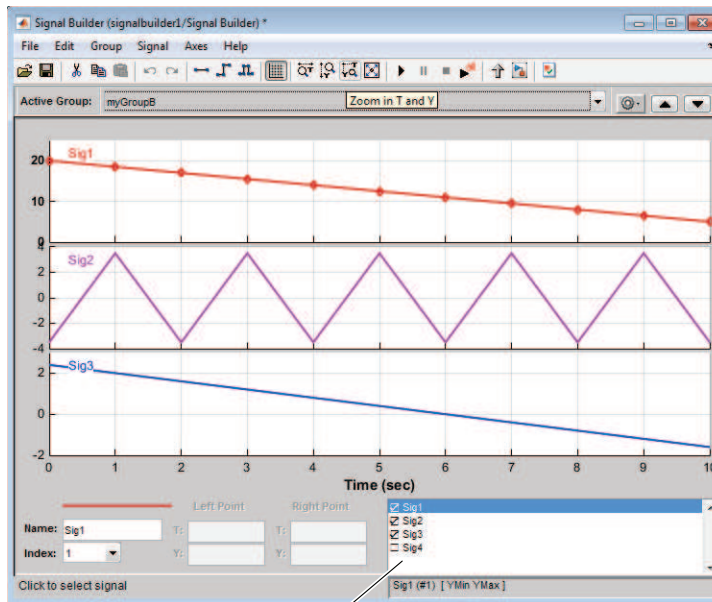

Sig4 appears in signal list, but does not appear in group pane

- 12 To show Sig4 on this pane, double-click Sig4 in the Selection Status area of the pane. The graph is updated to reflect Sig4.

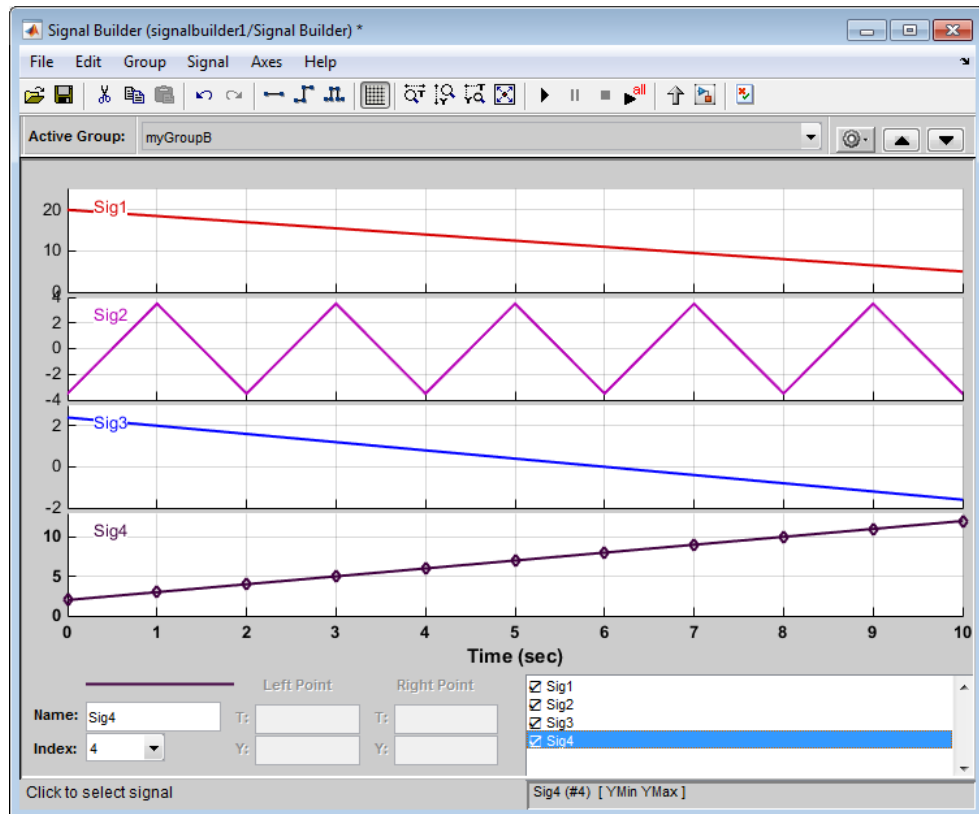

- 13** Close the Signal Builder window and save and close the model. For example, save the model as `signalbuilder3`.

### Appending Signal Groups to Existing Groups

You can append one or more signal groups to the end of the list of existing signal groups. If the block already has a signal group with the same name as the one you are adding, the software increments the group name by 1 or higher until it is unique before adding it. For example, if the block and data file contain groups named `MyGroup1`, the software renames the imported group to `MyGroup2` upon appending. If you add another group named `MyGroup1`, the software names that latest version `MyGroup3`.

This topic uses `signalbuilder1` from the procedure in “Replacing All Signal Data with Selected Data” on page 62-86.



- 1 In the MATLAB Command Window, type `signalbuilder1`.
- 2 Double-click the Signal Builder block.

The Signal Builder window appears.

- 3 Note how many groups exist in the Signal Builder block, and how many signals exist in each group. The Signal Builder block requires that all groups have the same number of signals. For example, this Signal Builder block has three groups, `myGroup1`, `myGroupB`, and `myGroup_Three`. Three signals exist in each group.

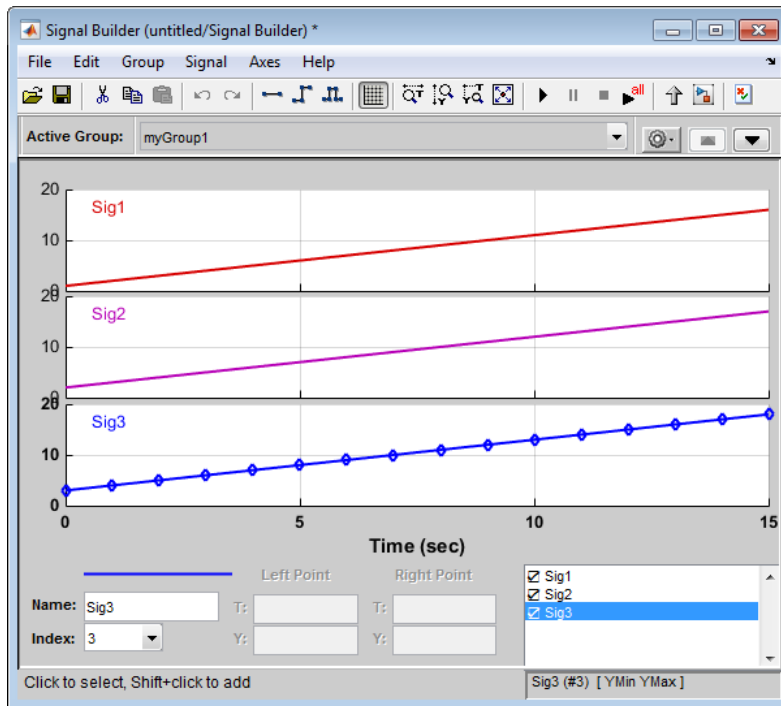

- 4 Double-click the block.
- 5 In the **File to Import** text field, enter a signal data file name or click **Browse**.

The file browser appears.

- 6 If you select the file browser, navigate to and select a signal data file. For example, select `3Grp_3Sig.xls`.

The **Data to Import** pane contains the signal data from the file. Click the expander to display all the signals.

- 7 Evaluate the number of signals in the groups of this data file. If the number of signals in each group equals the number of signals in the groups that exist in the block, you can append one of these groups to the block.
- 8 Select the group you want to import. In this example, there are three groups, myGroup1, myGroupB, and myGroup\_Three. Select myGroupB.

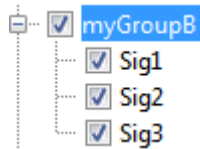

- 9 From the **Placement for Selected Data** list, select the action to take on the signal group. For example, select **Append groups**.

The **Confirm Selection** button is activated. Validate your signal selection before the Signal Builder block performs the specified action.

- 10 Click the **Confirm Selection** button.

If the requested action is a valid one, the Status History pane displays messages to indicate the state. For example:

1 group(s) (each with 3 signal(s)),  
will be appended to the existing block.

Selected group name(s):

Before:

myGroupB

After:

myGroupB1

Signal name(s) in selected group(s):

Before:

Sig1

Sig2

Sig3

Signal name(s) in the block:

Before:

Sig1

Sig2

Sig3

After:

Sig1

Sig2

Sig3

The confirmation also enables the **OK** and **Apply** buttons.

- 11 If you are satisfied with the status message, click **Apply** to append the signals.

The Signal Builder block updates with the new signal data. Click **OK** to close the Import File dialog box and inspect the groups of the Signal Builder block.

Notice the addition of the new signal group as the last pane. Because there is already a signal group named myGroupB, the software automatically increments the new signal group name by 1. Select myGroupB.

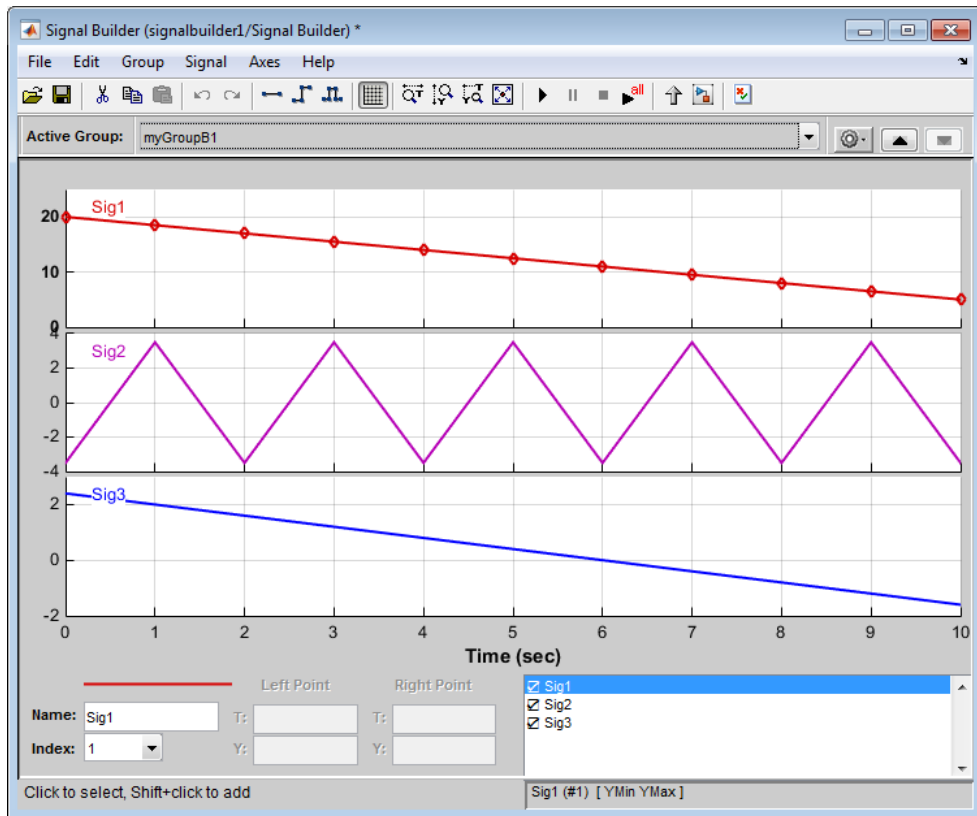

- 12** Close the Signal Builder window and save and close the model. For example, save the model as `signalbuilder4`.

### Appending Signals with the Same Name to Existing Signal Groups

If you append a signal whose name is the same as a signal that exists in the Signal Builder block, the software increments the name of the appended signal by 1. The software repeats incrementing until the appended signal name is unique. For example:

- 1** Assume your Signal Builder block has a signal group, `myGroup1`, with the signals `Sig1`, `Sig2`, and `Sig3`.
- 2** Append a signal named `Sig1` to `myGroup1`.
- 3** Observe that the software increments `Sig1` to `Sig4` before appending it to `myGroup1`.

### Appending a Group of Signals with Different Signal Names

If you append a signal group whose signal names differ from those that exist in the Signal Builder block, the software changes the names of the existing signals to be the same as the appended signals. For example,

- 1 Assume your Signal Builder block has a signal group, `myGroup1`, with the signals `Sig1`, `Sig2`, and `Sig3`.
- 2 Append a signal group named `myGroup2` whose signal names are `SigA`, `SigB`, and `SigC`.
- 3 Observe that the software:
  - Appends `myGroup2`.
  - Renames the signals in `myGroup1` to be the same as those in `myGroup2`.

### Importing Data with Custom Formats

This topic describes how to import signal data formatted in a custom format. You should already have a signal data from a file whose contents you want to import. See “Importing Signal Groups from Existing Data Sets” on page 62-81 for a description of the data formats that the Signal Builder block accepts. If your data is not formatted using one of these data formats, use the following workflow to import the custom formatted data. This workflow uses the following files, located in the folder `matlabroot\help\toolbox\simulink\ug\examples\signals` (open), as examples:

- `SigBldCustomFile.xls` — Signal data Microsoft Excel file using a format that Signal Builder block does not accept, for example:

<b>Group1</b>	Time	0	1	2	3	4	5	6	7	8	9	10	11	12	13	14	15
	Signal1	1	2	3	4	5	6	7	8	9	10	11	12	13	14	15	16
	Signal2	1	2	3	4	5	6	7	8	9	10	11	12	13	14	15	16
	Signal3	1	2	3	4	5	6	7	8	9	10	11	12	13	14	15	16
	Signal4	1	2	3	4	5	6	7	8	9	10	11	12	13	14	15	16
<b>Group2</b>	Signal1	1.6	2.6	3.6	4.6	5.6	6.6	7.6	8.6	9.6	10.6	11.6	12.6	13.6	14.6	15.6	16.6
	Signal2	1.8	2.8	3.8	4.8	5.8	6.8	7.8	8.8	9.8	10.8	11.8	12.8	13.8	14.8	15.8	16.8
	Signal3	2	3	4	5	6	7	8	9	10	11	12	13	14	15	16	17
	Signal4	2.2	3.2	4.2	5.2	6.2	7.2	8.2	9.2	10.2	11.2	12.2	13.2	14.2	15.2	16.2	17.2

- `createSignalBuilderSupportedFormat.m` — Custom MATLAB function that uses `xlsread` to read Microsoft Excel spreadsheets. This example function reformats the custom data, in a format that the Signal Builder block supports, as follows:
  - `grpNames` — Cell array that contains group name character vectors with number of rows = 1, number of columns = number of groups.

- *sigNames* — Cell array that contains signal name character vectors with number of rows = 1, columns = number of signals.
- *time* — Cell array that contains time data with number of rows = number of signals, columns = number of groups.
- *data* — Cell array that contains signal data with number of rows = number of signals, columns = number of groups.

Signal Builder has the following requirements for this custom function:

- Number of signals in each group must be the same.
- Signal names in each group must be the same.
- Number of data points in each signal must be the same.
- Each element in the *time* and *data* cell array holds a matrix of real numbers. This matrix can be [1xN] or [Nx1], where *N* is the number of data points in every signal.

- 1 Identify the format of your custom signal data, for example:

```
SigBldCustomFile.xls
```

- 2 Create a custom MATLAB function that:

- a Uses a MATLAB I/O function, such as `xlsread`, to read your custom formatted signal data. For example, `createSignalBuilderSupportedFormat.m`.
- b Formats the custom formatted signal data to one that the Signal Builder block accepts, for example, a MAT-file.

- 3 Use your custom MATLAB function to write your custom formatted signal data to a file that Signal Builder block accepts. For example:

```
createSignalBuilderSupportedFormat('SigBldCustomFile.xls', 'OutputData.mat')
```

- 4 Import the reformatted signal data file, `OutputData.mat`, into the Signal Builder block (see “Importing Signal Group Sets” on page 62-81).

## Editing Waveforms

Signal Builder allows you to change the shape, color, and line style and thickness of the waveforms output by a group.

## Reshaping a Waveform

Signal Builder allows you to change the waveform by selecting and dragging its line segments and points with the mouse or arrow keys or by editing the coordinates of segments or points.

### Selecting a Waveform

To select a waveform, left-click the mouse on any point on the waveform.

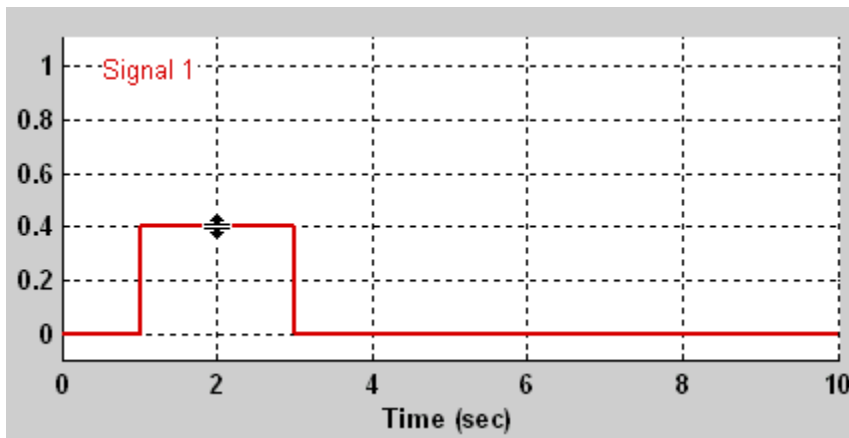

The Signal Builder displays the waveform points to indicate that the waveform is selected.

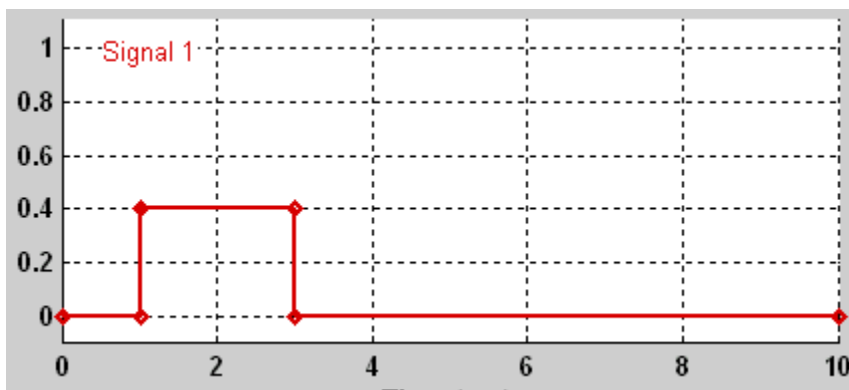

To deselect a waveform, left-click any point on the waveform axis that is not on the waveform itself or press the **Esc** key.

### Working with Points

You can work with points in a waveform:

- To select a point of a waveform, first select the waveform. Then position the mouse cursor over the point. The cursor changes shape to indicate that it is over a point.

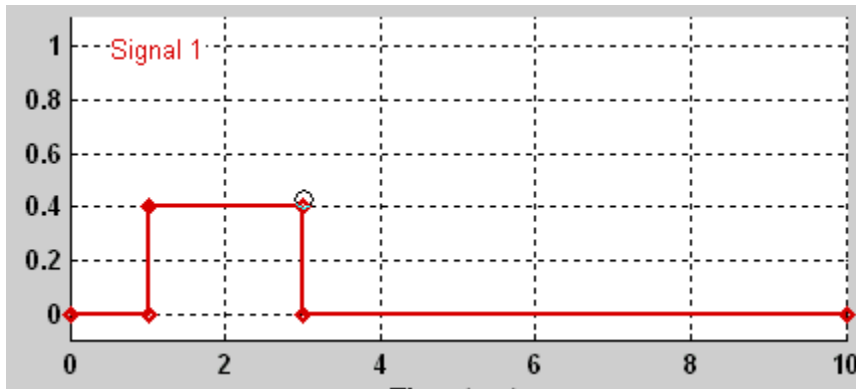

Left-click the point with the mouse. The Signal Builder draws a circle around the point to indicate your selection.

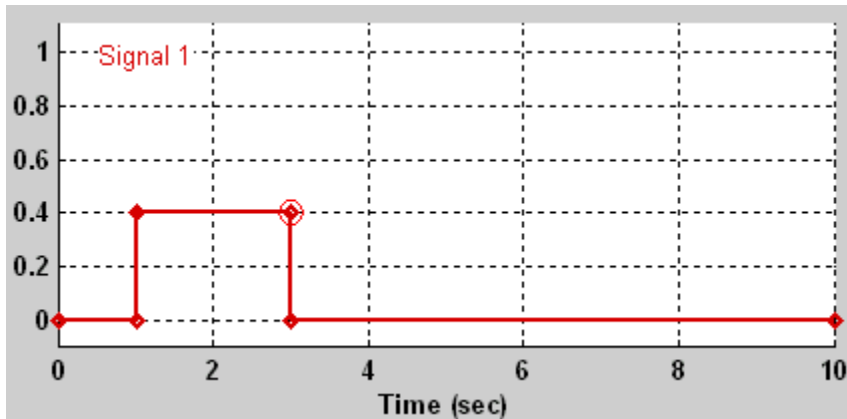

- To insert a point, select the waveform and **Shift**+click the section for the point.
- To deselect the point, press the **Esc** key.
- To delete a point, select the point and press the **Backspace** or **Delete** keys.



- To edit a point with the `signalbuilder` function, use the `signalbuilder set` function to replace the waveform. You cannot programmatically remove a point.

### Selecting Segments

To select a line segment, first select the waveform that contains it. Then left-click the segment. The Signal Builder thickens the segment to indicate that it is selected.

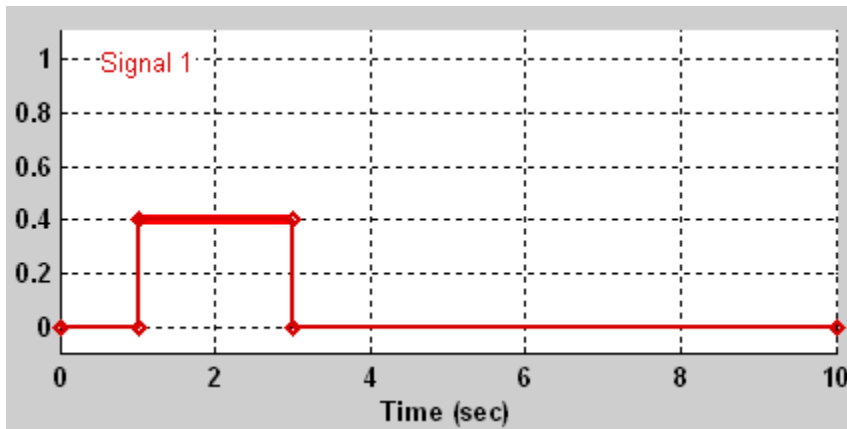

To deselect the segment, press the **Esc** key.

### Moving Waveforms

To move a waveform, select it and use the arrow keys on your keyboard to move the waveform in the desired direction. Each key stroke moves the waveform to the next location on the snap grid (see “Snap Grid” on page 62-110) or by 0.1 inches if the snap grid is not enabled.

### Dragging Segments

To drag a line segment to a new location, position the mouse cursor over the line segment. The mouse cursor changes shape to show the direction in which you can drag the segment.

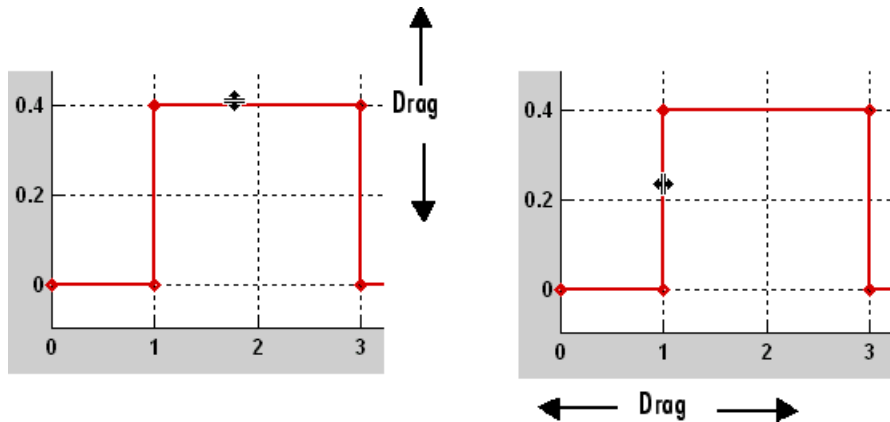

Press the left mouse button and drag the segment in the direction indicated to the desired location. You can also use the arrow keys on your keyboard to move the selected line segment.

### Dragging points

To drag a point along the signal amplitude (vertical) axis, move the mouse cursor over the point. The cursor changes shape to a circle to indicate that you can drag the point. Drag the point parallel to the  $y$ -axis to the desired location. To drag the point along the time (horizontal) axis, press the **Shift** key while dragging the point. You can also use the arrow keys on your keyboard to move the selected point.

### Snap Grid

Each waveform axis contains an invisible snap grid that facilitates precise positioning of waveform points. The origin of the snap grid coincides with the origin of the waveform axis. When you drop a point or segment that you have been dragging, the Signal Builder moves the point or the segment points to the nearest point or points on the grid, respectively. The Signal Builder **Axes** menu allows you to specify the grid horizontal (time) axis and vertical (amplitude) axis spacing independently. The finer the spacing, the more freedom you have in placing points but the harder it is to position points precisely. By default, the grid spacing is 0, which means that you can place points anywhere on the grid; i.e., the grid is effectively off. Use the **Axes** menu to select the spacing that you prefer.

### Inserting and Deleting points

To insert a point, first select the waveform. Then hold down the **Shift** key and left-click the waveform at the point where you want to insert the point. To delete a point, select the point and press the **Del** key.

### Editing Point Coordinates

To change the coordinates of a point, first select the point. The Signal Builder displays the current coordinates of the point in the **Left Point** edit fields at the bottom of the Signal Builder window. To change the amplitude of the selected point, edit or replace the value in the **Y** field with the new value and press **Enter**. The Signal Builder moves the point to its new location. Similarly edit the value in the **T** field to change the time of the selected point.

### Editing Segment Coordinates

To change the coordinates of a segment, first select the segment. The Signal Builder displays the current coordinates of the endpoints of the segment in the **Left Point** and **Right Point** edit fields at the bottom of the Signal Builder window. To change a coordinate, edit the value in its corresponding edit field and press **Enter**.

### Changing the Color of a Waveform

To change the color of a waveform, select the waveform and then select **Color** from the Signal Builder **Signal** menu. The Signal Builder displays the MATLAB color chooser. Choose a new color for the waveform. Click **OK**.

### Changing a Waveform Line Style and Thickness

The Signal Builder can display a waveform as a solid, dashed, or dotted line. It uses a solid line by default. To change the line style of a waveform, select the waveform, then select **Line Style** from the Signal Builder **Signal** menu. A menu of line styles pops up. Select a line style from the menu.

To change the line thickness of a waveform, select the waveform, then select **Line Width** from the **Signal** menu. A dialog box appears with the line current thickness. Edit the thickness value and click **OK**.

## Signal Builder Time Range

The Signal Builder time range determines the span of time over which its output is explicitly defined. By default, the time range runs from 0 to 10 seconds. You can change

both the beginning and ending times of a block time range (see “Changing a Signal Builder Time Range” on page 62-112).

If the simulation starts before the start time of a block time range, the block extrapolates its initial output from its first two defined outputs. If the simulation runs beyond the block time range, the block by default outputs values extrapolated from the last defined signal values for the remainder of the simulation. The Signal Builder **Simulation Options** dialog box allows you to specify other final output options (see “Signal values after final time” on page 62-116 for more information).

---

**Note:** When you click the **Start simulation** button on the Signal Builder block toolbar, the simulation uses the stop time of the model. The end of the time range specified in the waveform is not the stop time for the model.

---

### Changing a Signal Builder Time Range

To change the time range, select **Change Time Range** from the Signal Builder **Axes** menu. A dialog box appears.

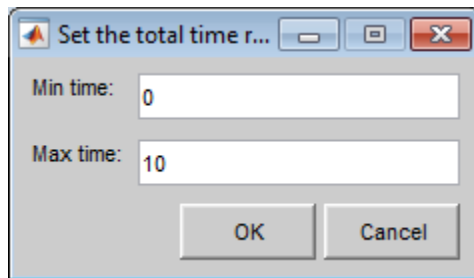

Edit the **Min time** and **Max time** fields as necessary to reflect the beginning and ending times of the new time range, respectively. Click **OK**.

### Exporting Signal Group Data

To export the data that define a Signal Builder block signal groups to the MATLAB workspace, select **Export to Workspace** from the block **File** menu. A dialog box appears.

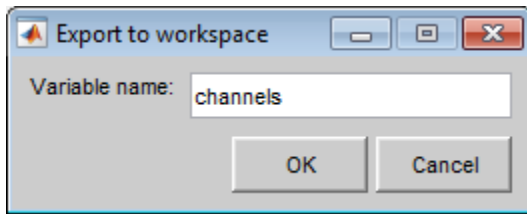

The Signal Builder exports the data by default to a workspace variable named `channels`. To export to a differently named variable, enter the variable name in the **Variable name** field. Click **OK**. The Signal Builder exports the data to the workspace as the value of the specified variable.

The exported data is an array of structures. The structure `xData` and `yData` fields contain the coordinate points defining signals in the currently selected signal group.

To access all the data in the signal groups of a Signal Builder block, use the `signalbuilder get` function:

```
[time, data]=signalbuilder(block,'get',signal,group)
```

For example:

```
% For time 0 to 5, create three signal groups.
block = signalbuilder([], 'create', [0 5], {[2 2] [4 4] [7 8];[0 2] [0 4] [7 10]});
% Get the signals for all three groups.
[time, data]=signalbuilder(block,'get',[1 2],[1:3])
```

```
time =
```

```
2×3 cell array
```

```
    [1×2 double]    [1×2 double]    [1×2 double]
    [1×2 double]    [1×2 double]    [1×2 double]
```

```
data =
```

```
2×3 cell array
```

```
    [1×2 double]    [1×2 double]    [1×2 double]
    [1×2 double]    [1×2 double]    [1×2 double]
```

## Printing, Exporting, and Copying Waveforms

Signal Builder allows you to print, export, and copy the waveforms visible in the active signal group.

To print the waveforms to a printer, select **Print** from the block **File** menu.

You can also export the waveforms to other destinations by using the **Export** option from the block **File** menu. From this submenu, select one of the following destinations:

- **To File** — Converts the current view to a graphics file.

Select the format of the graphics file from the **Save as type** drop-down list on the resulting **Export** dialog box.

- **To Figure** — Converts the current view to a MATLAB figure window.

To copy the waveforms to the system clipboard for pasting into other applications, select **Copy Figure To Clipboard** from the block **Edit** menu.

## Simulating with Signal Groups

You can use standard simulation commands to run models containing Signal Builder blocks or you can use the **Run** or **Run all** button in the Signal Builder window (see “Running All Signal Groups” on page 62-115).

If you want to capture inputs and outputs that the **Run all** button generates, consider using the SystemTest™ software.

### Activating a Signal Group

During a simulation, a Signal Builder block always outputs the active signal group. The active signal group is the group selected in the Signal Builder window for that block, if the dialog box is open. Otherwise, the active group is the group that was selected when the dialog box was last closed. To activate a group, open the group Signal Builder window and select the group.

### Running Different Signal Groups in Succession

The Signal Builder toolbar includes the standard Simulink buttons for running a simulation. This facilitates running several different signal groups in succession. For example, you can open the dialog box, select a group, run a simulation, select another group, run a simulation, etc., all from the Signal Builder window.

## Running All Signal Groups

To run all the signal groups defined by a Signal Builder block, open the block dialog box and click the **Run all** button



from the Signal Builder toolbar. The **Run all** button runs a series of simulations, one for each signal group defined by the block. If you installed Simulink Verification and Validation on your system and are using the Model Coverage Tool, the **Run all** button configures the tool to collect and save coverage data for each simulation in the MATLAB workspace and display a report of the combined coverage results at the end of the last simulation. This allows you to quickly determine how well a set of signal groups tests your model.

---

**Note** To stop a series of simulations started by the **Run all** command, enter **Ctrl+C** at the MATLAB command line.

---

## Simulation Options Dialog Box

The **Simulation Options** dialog box allows you to specify simulation options pertaining to the Signal Builder. To display the dialog box, select **Simulation Options** from the **File** menu of the Signal Builder window. The dialog box appears.

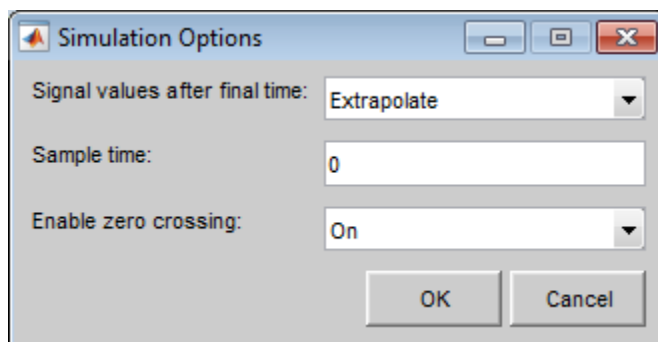

The dialog box allows you to specify the following options.

### Signal values after final time

The setting of this control determines the output of the Signal Builder block if a simulation runs longer than the period defined by the block. The options are

- Hold final value

Selecting this option causes the Signal Builder block to output the last defined value of each signal in the currently active group for the remainder of the simulation.

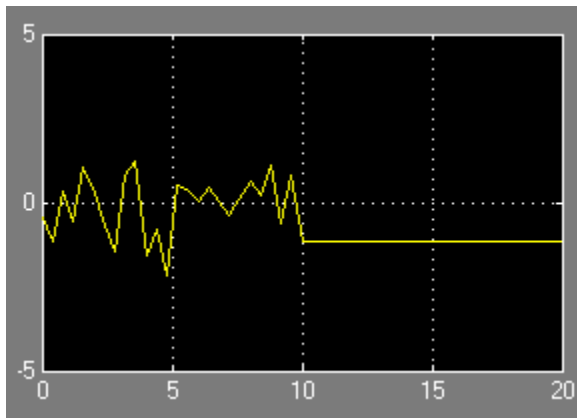

- Extrapolate

Selecting this option causes the Signal Builder block to output values extrapolated from the last defined value of each signal in the currently active group for the remainder of the simulation.



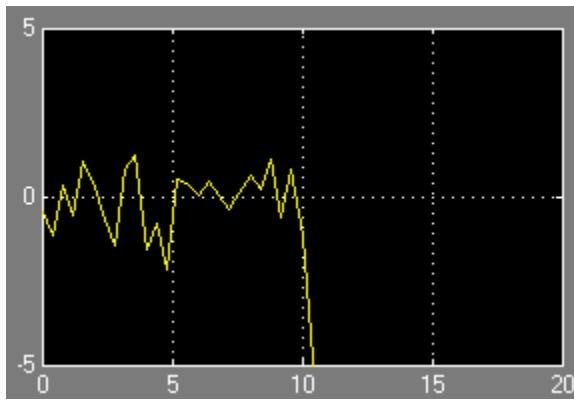

- Set to zero

Selecting this option causes the Signal Builder block to output zero for the remainder of the simulation.

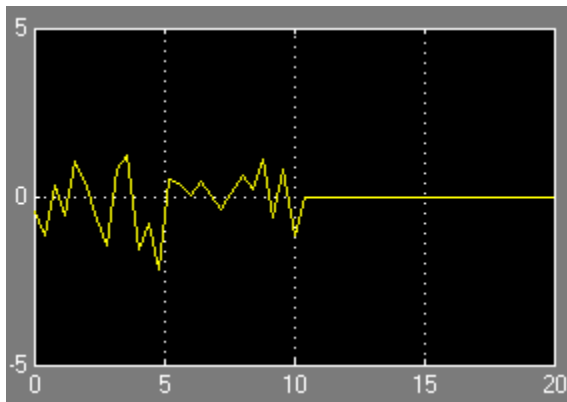

### Sample time

Determines whether the Signal Builder block outputs a continuous (the default) or a discrete signal. If you want the block to output a continuous signal, enter 0 in this field. For example, the following display shows the output of a Signal Builder block set to output a continuous Gaussian waveform over a period of 10 seconds.

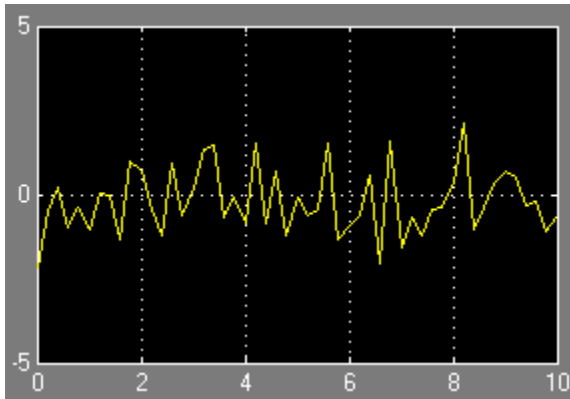

If you want the block to output a discrete signal, enter the sample time of the signal in this field. The following example shows the output of a Signal Builder block set to emit a discrete Gaussian waveform having a 0.5 second sample time.

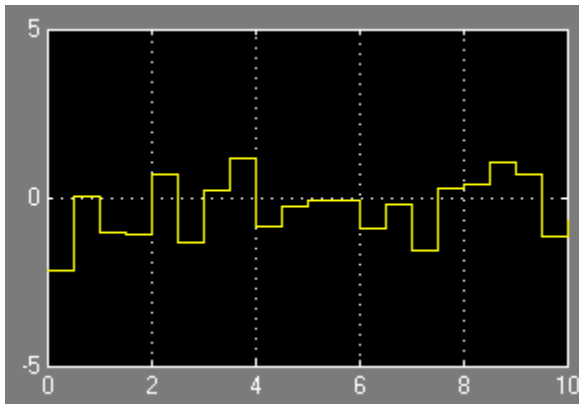

### Enable zero crossing

Specifies whether the Signal Builder block detects zero-crossing events (enabled by default). This block sets the zero-crossing detection on the From Workspace block that you use to create the Signal Builder signal groups. For more information, see “Zero-Crossing Detection” on page 3-24.

### Related Examples

- “Export Simulation Data” on page 59-4

- “Initialize Signals and Discrete States” on page 62-48
- “Signal Basics” on page 62-2
- “Signal Values” on page 62-15



# Using Composite Signals

---

- “Overview of Composite Signal Techniques” on page 63-3
- “Select a Composite Signal Technique” on page 63-11
- “Getting Started with Buses” on page 63-16
- “Simplify Subsystem Bus Interfaces” on page 63-26
- “Display Information About Buses” on page 63-37
- “Bus-Capable Blocks” on page 63-43
- “Nested Buses” on page 63-46
- “Assign Signal Values to a Bus” on page 63-48
- “Correct Buses Used as Vectors” on page 63-51
- “Specify Bus Signal Sample Times” on page 63-55
- “When to Use Bus Objects” on page 63-59
- “Create Bus Objects with the Bus Editor” on page 63-63
- “Create Bus Objects Programmatically” on page 63-73
- “Modify Bus Objects” on page 63-76
- “Save and Import Bus Objects” on page 63-82
- “Map Bus Objects to Models” on page 63-88
- “Customize Bus Object Import and Export” on page 63-90
- “Use Buses for Inports and Outports” on page 63-95
- “Specify Initial Conditions for Bus Signals” on page 63-99
- “Combine Buses into an Array of Buses” on page 63-110
- “Use Arrays of Buses in Models” on page 63-115
- “Work with Array of Buses Signals” on page 63-120
- “Convert Models to Use Arrays of Buses” on page 63-127
- “Repeat an Algorithm Using a For Each Subsystem” on page 63-131
- “Bus Data Crossing Model Reference Boundaries” on page 63-142

- “Bus Conversion” on page 63-145
- “Buses and Libraries” on page 63-146
- “Buses in the Generated Code” on page 63-147

## Overview of Composite Signal Techniques

### In this section...

“Buses” on page 63-3

“Bus Element Ports” on page 63-6

“Arrays of Buses” on page 63-7

“Muxes” on page 63-9

“Concatenated Contiguous Output Signals” on page 63-9

You can use composite signals to reduce visual complexity in a model. A *composite signal* is a signal that is composed of other signals. The individual element signals originate separately and join to form the composite signal. You can extract individual signals from the composite signal downstream and use the extracted signal as if it never was part of a composite signal.

Use one or more of these techniques to combine signals into a composite signal.

- “Buses” on page 63-3
- “Arrays of Buses” on page 63-7
- “Muxes” on page 63-9
- “Concatenated Contiguous Output Signals” on page 63-9

To select a composite signal technique that meets your modeling requirements, see “Select a Composite Signal Technique” on page 63-11.

### Buses

A *bus signal* (also called a *bus*) is analogous to a bundle of wires held together by tie wraps. Simulink implements a bus as a name-based hierarchical structure. A Simulink bus is not like a hardware bus, such as the bus in computer hardware architecture. A Simulink bus is more like a programmatic structure defined in a language such as MATLAB or C.

A bus is composed of signals that are called *elements*. The constituent signals retain their separate identities within the bus and can be of any type or types, including other buses nested to any level. The elements of a bus can be:

- Mixed data type signals (for example, double, integer, fixed-point)
- Mixed scalar and vector elements
- Mixed of real and complex signals
- Other buses
- Multidimensional signals

Not all blocks can accept buses. See “Bus-Capable Blocks” on page 63-43 for more information about which blocks can handle which types of buses. Also, see “Use Buses for Inports and Outports” on page 63-95.

For example, this model has a bus signal `bus1`, composed of the bus elements `Clock`, `Pulse`, and `Sine`.

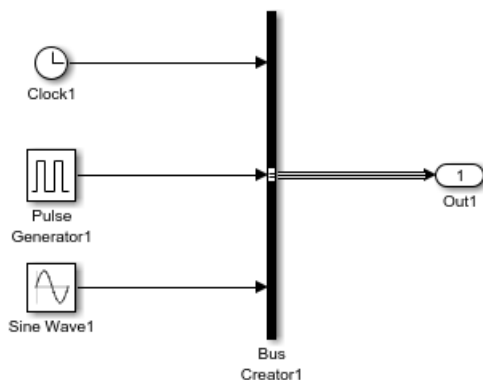

For complete examples using buses, see “Getting Started with Buses” on page 63-16.

### Virtual and Nonvirtual Buses



A bus can be either *virtual* or *nonvirtual*. Virtual and nonvirtual buses provide the same visual simplification, but Simulink handles them differently.

Bus	Functional Effect	Signal Storage	Generated Code
Virtual	Exists only graphically; has no functional effect.	Each bus element signal occupies its own storage in memory, but the bus signal is not stored in memory.	Do not appear in generated code; only the constituent signals appear.



Bus	Functional Effect	Signal Storage	Generated Code
		<p>A block connected to a <i>virtual</i> bus reads inputs and writes outputs by accessing the memory allocated to the component signals. These signals are typically noncontiguous.</p> <p>Information about the size and data type of signals propagates from the signal sources.</p>	
Nonvirtual	Can have functional effects.	<p>Bus signal occupies its own storage in contiguous memory.</p> <p>A block connected to a <i>nonvirtual</i> bus reads inputs and writes outputs by accessing copies of the component signals. The copies are maintained in a contiguous area of memory allocated to the bus.</p>	Appear as structures in generated code.

When you simulate or perform an update diagram operation for a model that contains buses, Simulink uses different line styles for virtual and nonvirtual bus signals.

Virtual Bus	
Nonvirtual Bus	

### Bus Objects

A bus can have an associated *bus object*, which provides bus properties that Simulink uses to validate the bus signal. Bus objects are optional for virtual buses, but required for nonvirtual buses.

A bus object is an instance of class `Simulink.Bus` that can be stored in a location such as the base workspace. The object defines the structure of the bus and the properties of its elements, such as nesting, data type, and size. See “When to Use Bus Objects” on page 63-59 for more information. You can create bus objects programmatically or by using the Simulink Bus Editor, which you can use to interactively create and manage bus objects. You can save bus objects as MATLAB code or as a MAT-file. For more information, see “Create Bus Objects with the Bus Editor” on page 63-63.

### **Generated Code for Buses**

For simulation, virtual buses and nonvirtual buses are similar, except that all elements of a nonvirtual bus must have the same sample time. However, the type of bus can make a significant difference in the efficiency, size, and readability of generated code. For an example of this difference, see “Generate Code for Buses” on page 63-22.

If you intend to generate code for a model that uses buses, for information about the best techniques to use, see “Generate Efficient Code for Bus Signals” (Simulink Coder).

### **Bus Element Ports**

The In Bus Element and Out Bus Element blocks provide a simplified and flexible way to use bus signals as inputs and outputs to subsystems. Here is model that uses bus element port blocks.

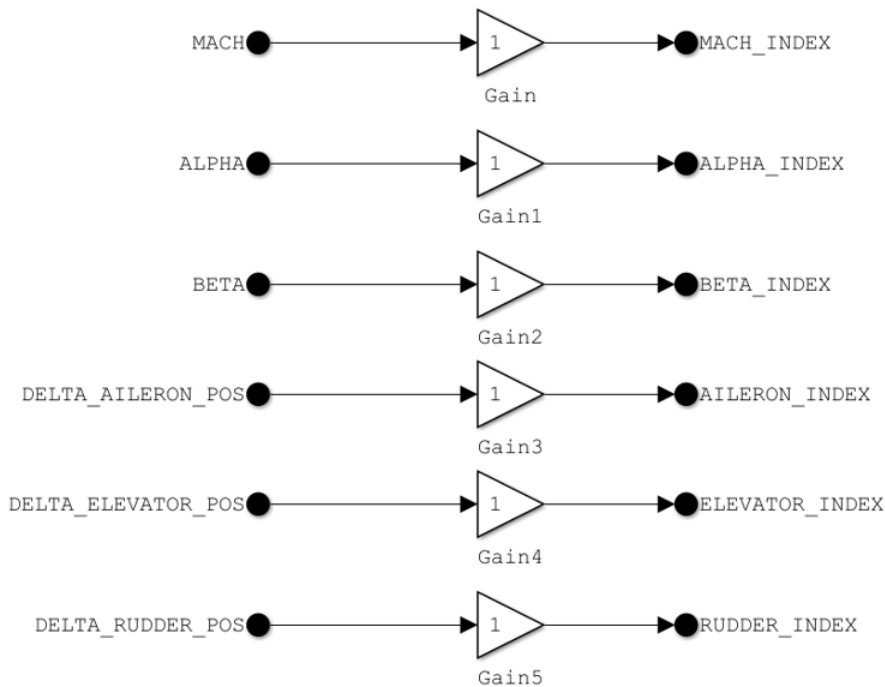

You can refactor a subsystem interface that uses Inport, Bus Selector, Bus Creator, and Outport blocks to use In Bus Element and Out Bus Element blocks. Conversion operations are supported only when the signal lines or blocks do not have any extra specification. You can use single-click operations to:

- Convert Inport and Bus Selector blocks in a subsystem to In Bus Element blocks.
- Convert Outport and Bus Creator blocks in a subsystem to Out Bus Element blocks.
- Transform input or output interfaces of subsystems to use bus element port blocks.

See “Simplify Subsystem Bus Interfaces” on page 63-26.

## Arrays of Buses

You can combine multiple nonvirtual buses with identical properties into an array of buses. An array of buses is an array whose elements are buses. Each bus object has the same signal name, hierarchy, and attributes for its bus elements. An array of buses is equivalent to an array of structures in MATLAB.

An example of using an array of buses is to model a multi-channel system. You can model all the channels using the same bus object, although each of the channels could have a different value.

For an example of a model that uses an array of buses, open the `sldemo_bus_arrays` model. In this example, the nonvirtual bus input signals connect to a Vector Concatenate or Matrix Concatenate block that creates an array of bus signals. Here is how the simulated model appears.

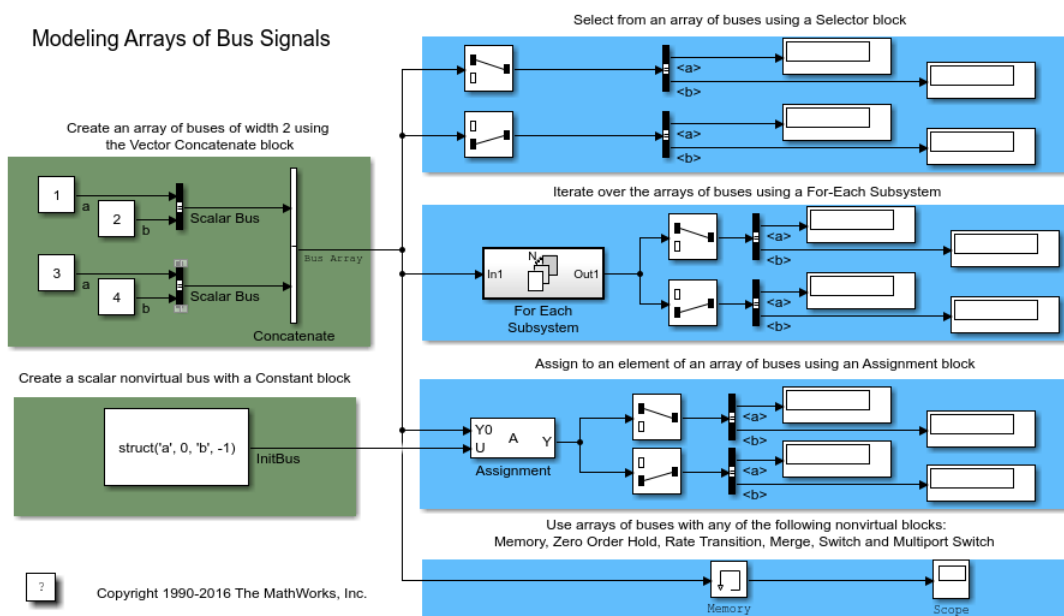

The model uses the array of buses with:

- An Assignment block, to assign values to a bus in the array
- A For Each Subsystem block, to perform iterative processing over each bus in the array
- A Memory block, to output the array of buses input from the previous time step

See “Combine Buses into an Array of Buses” on page 63-110.

## Muxes

If all signals in a composite signal have the same type, generally you can use a mux, which is a special type of noncontiguous vector (virtual) vector. If a block or modeling configuration requires a bus, then do not use a mux.

This model has three signals that are input to a Mux block, transmitted as a mux signal to a Demux block, and output as separate signals.

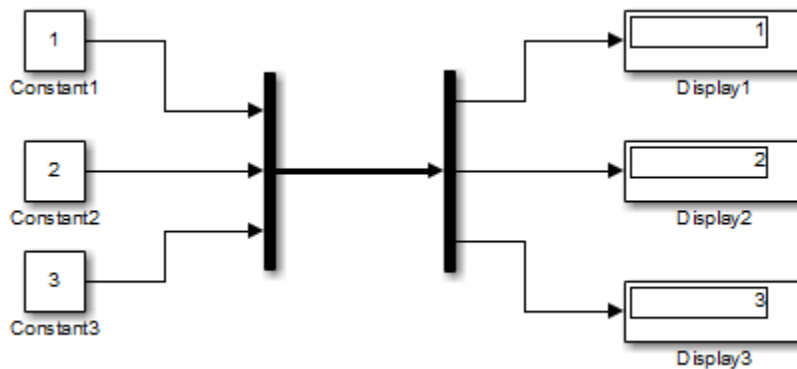

The Mux and Demux blocks are the left and right vertical bars, respectively. To reduce visual complexity, neither block displays a name.

For more information, see “Mux Signals” on page 62-11.

## Concatenated Contiguous Output Signals

You can concatenate input signals of same data type to create contiguous output signal. You can use a Vector Concatenate or Matrix Concatenate block to concatenate the signals at its inputs to create an output signal whose elements reside in contiguous locations in memory.

For example, this model sets the Matrix Concatenate block parameter **Concatenate dimension** to 2. Inputs are 2-D matrices. The Matrix Concatenate block performs horizontal matrix concatenation and places the input matrices side by side to create the output matrix.

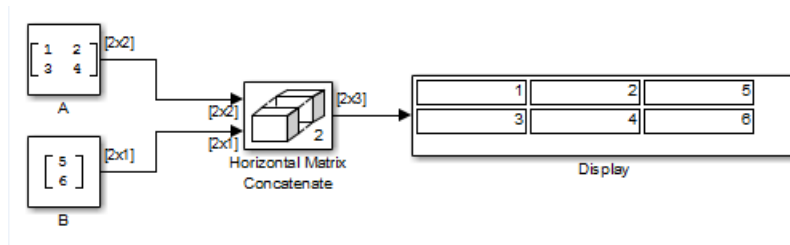

## See Also

### Blocks

Bus Creator | Bus Selector | Bus to Vector | Demux | Matrix Concatenate | Mux | Vector Concatenate

### Functions

Simulink.BlockDiagram.addBusToVector | Simulink.Bus.cellToObject | Simulink.Bus.createMATLABStruct | Simulink.Bus.createObject | Simulink.Bus.objectToCell | Simulink.Bus.save

### Classes

Simulink.Bus | Simulink.BusElement

## Related Examples

- “Select a Composite Signal Technique” on page 63-11
- “Getting Started with Buses” on page 63-16
- “Nested Buses” on page 63-46
- “Bus-Capable Blocks” on page 63-43
- “Display Information About Buses” on page 63-37
- “When to Use Bus Objects” on page 63-59
- “Buses in the Generated Code” on page 63-147
- “Combine Buses into an Array of Buses” on page 63-110
- “Mux Signals” on page 62-11

## Select a Composite Signal Technique

### In this section...

“Virtual Bus Usage Guidelines” on page 63-11

“Nonvirtual Bus Usage Guidelines” on page 63-11

“Bus Element Port Usage Guidelines” on page 63-12

“Array of Buses Usage Guidelines” on page 63-14

“Mux Usage Guidelines” on page 63-14

“Concatenated Contiguous Output Signal Guidelines” on page 63-15

Choose the composite signal technique that meets your modeling requirements. For background information about each technique, see “Overview of Composite Signal Techniques” on page 63-3.

### Virtual Bus Usage Guidelines

Use virtual buses to reduce signal clutter in a block diagram. In general, using a virtual bus is simpler and can be more efficient than using a nonvirtual bus. However, some modeling features require nonvirtual buses, such as bus data that crosses MATLAB Function block or Stateflow chart boundaries. For example, use a virtual bus for bus signals that:

- Have bus elements that have different sample rates
- Cross model reference boundaries, if the referenced model only uses a few of the bus elements.

Compared with nonvirtual buses, virtual buses reduce memory requirements. Virtual buses do not require a separate contiguous storage block. During simulation, virtual buses execute faster because they do not require copying data to and from that block. The generated code also executes faster for virtual buses than for nonvirtual buses.

### Nonvirtual Bus Usage Guidelines

Use nonvirtual buses to:

- Display and log bus signals with a Scope block.

- Construct an array of buses.
- Have bus data cross MATLAB Function block or Stateflow chart boundaries.
- Interface with external code through an S-function.
- Package bus data as structures in the generated C code.

Generated code represents a nonvirtual bus as a structure. The structure can be helpful for tracing the correspondence between the model and the code. Generated code for nonvirtual buses can result in multiple copies of some bus signals. For an example of the difference in generated code for virtual and nonvirtual buses, see “Generate Code for Buses” on page 63-22. For additional guidelines for generating code for nonvirtual buses, see “Group Signals into Structures in the Generated Code Using Buses” (Simulink Coder).

All signals in a nonvirtual bus input to a block must use the same sample time, even if the elements of the associated bus object specify inherited sample times. You can use a Rate Transition block to change the sample time of an individual signal, or of all signals in a bus.

## Bus Element Port Usage Guidelines

For models that include bus signals composed of many bus elements that feed subsystems, consider using the In Bus Element and Out Bus Element blocks. You can use these bus element port blocks instead of Inport with Bus Selector blocks for inputs, and Outport with Bus Creator blocks for outputs. These bus element port blocks:

- Reduce signal line complexity and clutter in a block diagram.
- Make it easier to change the interface incrementally.
- Allow access to a bus element closer to the point of usage, avoiding the use of a Bus Selector and Goto block configuration.

For example, here is a model that uses Inport, Bus Selector, Bus Creator, and Outport blocks.



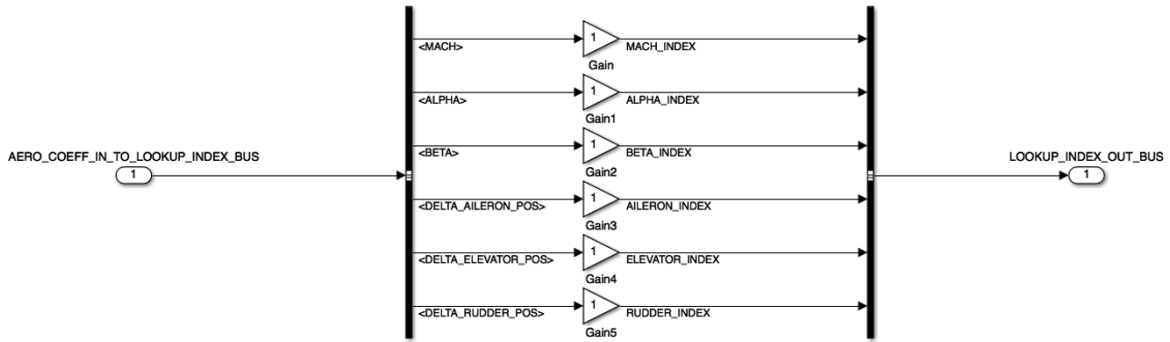

Here is an equivalent model that uses bus element port blocks.

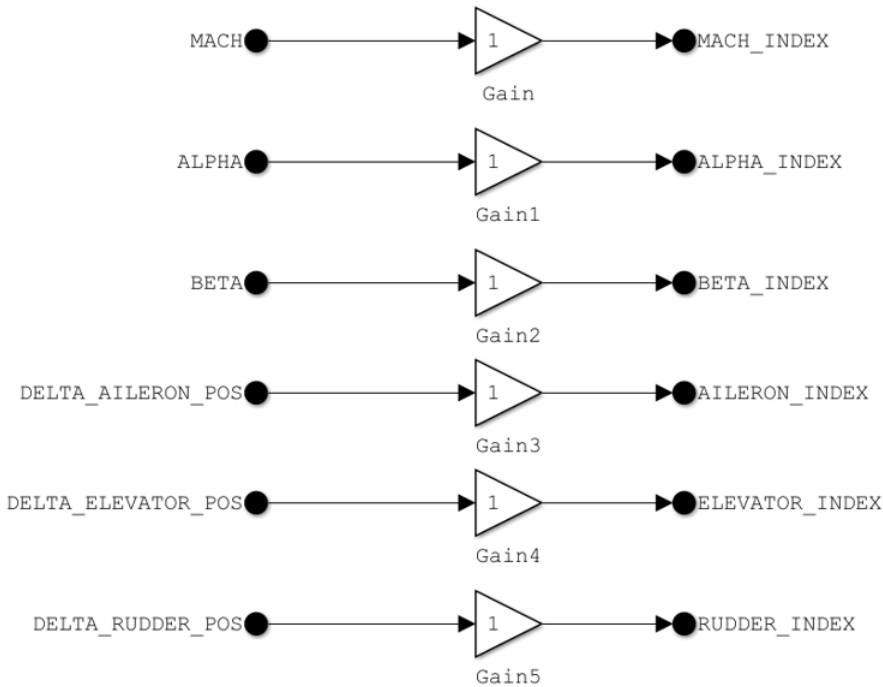

Consider using bus element ports for models with bus signals that you anticipate changing frequently during the model development process.

Bus element port blocks have these restrictions:

- The Out Bus Element output bus is a virtual bus.
- Bus objects associated with signals used with bus element port blocks are ignored.
- You cannot specify the underlying Inport or Outport block specifications, such as word length.

You can refactor a subsystem interface that uses Inport, Bus Selector, Bus Creator, and Outport blocks to use In Bus Element and Out Bus Element blocks. Conversion operations are supported only when the signal lines or blocks do not have any extra specification. You can use single-click operations to:

- Convert Inport and Bus Selector blocks in a subsystem to In Bus Element blocks.
- Convert Outport and Bus Creator blocks in a subsystem to Out Bus Element blocks.
- Transform input or output interfaces of subsystems to use bus element port blocks.

For more information, see “Simplify Subsystem Bus Interfaces” on page 63-26.

## Array of Buses Usage Guidelines

Combine multiple nonvirtual buses into an array. An array of buses is equivalent to an array of structures in MATLAB. An example of using an array of buses is to model a multi-channel system. You can model all the channels using the same bus object, although each of the channels can have a different value.

Each element in an array of buses must be nonvirtual and must have the same bus object. Each bus object has the same signal name, hierarchy, and attributes for its bus elements. Arrays of buses require the use of bus objects. For details, see “Combine Buses into an Array of Buses” on page 63-110.

## Mux Usage Guidelines

To combine signals of same type into a vector, you can use a Mux block. A mux is a special kind of noncontiguous (virtual) vector. You can use a mux anywhere that you could use an ordinary (contiguous) vector. For example, you can perform calculations on a mux. The computation affects each constituent value in the mux, as if the values existed in a contiguous vector. Using a mux to perform computations on multiple vectors avoids the overhead of copying the separate values to contiguous storage. Also, you can use a Mux block to create a vector of function calls.

If you want index-based access, use a Mux block. For name-based access, use a bus.

## Concatenated Contiguous Output Signal Guidelines

You can combine a vector or matrix by using a Vector Concatenate or Matrix Concatenate block. These blocks are useful for creating an output signal that is contiguous. You can use this concatenation in mathematical operations. For examples of using these blocks, see the Vector Concatenate and Matrix Concatenate block documentation.

## See Also

### Blocks

[Bus Creator](#) | [Bus Selector](#) | [Bus to Vector](#) | [Demux](#) | [Matrix Concatenate](#) | [Mux](#) | [Vector Concatenate](#)

### Functions

[Simulink.BlockDiagram.addBusToVector](#) | [Simulink.Bus.cellToObject](#) | [Simulink.Bus.createMATLABStruct](#) | [Simulink.Bus.createObject](#) | [Simulink.Bus.objectToCell](#) | [Simulink.Bus.save](#)

### Classes

[Simulink.Bus](#) | [Simulink.BusElement](#)

## Related Examples

- “Overview of Composite Signal Techniques” on page 63-3
- “Getting Started with Buses” on page 63-16
- “Bus-Capable Blocks” on page 63-43
- “Display Information About Buses” on page 63-37
- “When to Use Bus Objects” on page 63-59
- “Buses in the Generated Code” on page 63-147
- “Combine Buses into an Array of Buses” on page 63-110
- “Mux Signals” on page 62-11

## Getting Started with Buses

**In this section...**

“Create and Use Virtual Buses” on page 63-16

“Create and Use Nonvirtual Buses” on page 63-19

“Generate Code for Buses” on page 63-22

You can combine signals into a bus signal and then access the bus as a whole or select specific signals from the bus. These examples are simple, to focus on the basic steps in creating and using buses. Buses are most useful when you have many signals that make sense to combine to reduce visual complexity. The examples also include steps to label blocks and signals, to clarify the relationship between signals and buses and between blocks. If you choose to build the example models step-by-step, you can skip those steps if you like.

---

**Tip:** For models that include bus signals composed of many bus elements that feed subsystems, consider using the In Bus Element and Out Bus Element blocks. You can use these bus element port blocks instead of Inport with Bus Selector blocks for inputs, and Outport with Bus Creator blocks for outputs. These bus element port blocks:

- Reduce signal line complexity and clutter in a block diagram.
- Make it easier to change the interface incrementally.
- Allow access to a bus element closer to the point of usage, avoiding the use of a Bus Selector and Goto block configuration.

---

For more information, see “Simplify Subsystem Bus Interfaces” on page 63-26

---

### Create and Use Virtual Buses

This example shows how to combine signals into virtual buses. The model selects individual signals (bus elements) from a virtual bus and uses the bus elements as individual signals.

To see the completed model, open the `ex_bus_tutorial_virtual` model. When you simulate the model, the bus signal lines indicate that the buses are virtual.

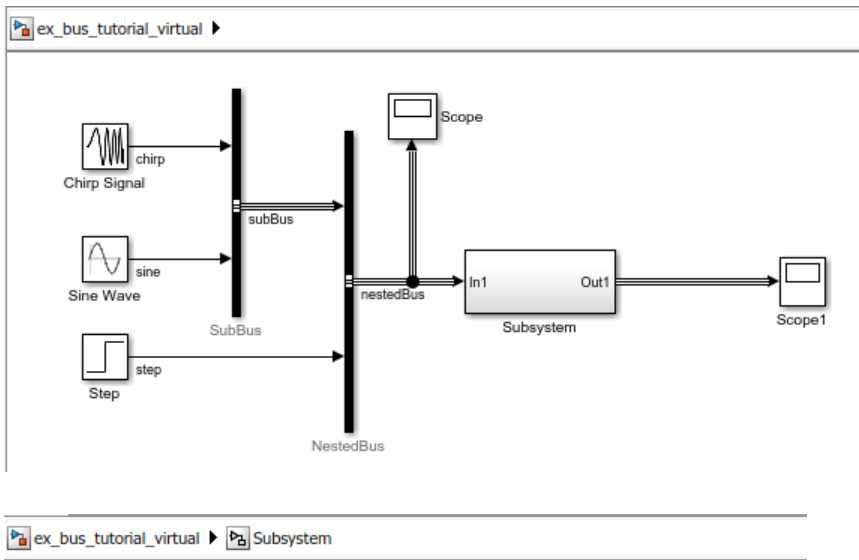

Perform these steps to gain experience creating and using virtual buses.

- 1 From the Simulink Start Page, select a blank model template.
- 2 In the Simulink Editor, add a Chirp Signal block and a Sine Wave block.
- 3 Create a bus for the signals from the two blocks. Drag to select the blocks and in the action bar that appears, click **Create Bus**.

Simulink adds a Bus Creator block and connects the input signals to that block.

- 4 By default, the Bus Creator block name does not appear. To add a block name, select the block and from the action bar that appears, select **Show Block Name**. Then edit the name, changing it from **Bus Creator** to **SubBus**.

- 5 You do not have to label the signals in a bus. However, labeling makes it easier to see the relationship between bus element signals and bus signals. Label the output signal for the Chirp Signal block. Right-click the signal and select **Properties**. In the **Signal name** property, enter `chirp`. Similarly, set the Sine Wave signal name to `sine`.

---

**Note:** Inputs to a Bus Creator block must have unique names. If there are duplicate names, the Bus Creator block appends (`signal#`) to all input signal names, where `#` is the input port index.

---

- 6 Add a Step block below the Sine Wave block.
- 7 To create a nested bus, add a Bus Creator block to the right of the current blocks. Connect the signal from the SubBus block and the signal from the Step block to the second Bus Creator block.
- 8 Label the output signal from the SubBus block `subBus` and the signal from the Step block `step`.
- 9 Show the block name for the Bus Creator block that creates the nested bus. Change the name to `NestedBus`.
- 10 Attach a Scope block to the `nestedBus` signal.
- 11 To the right of the `NestedBus` block, add a Subsystem block and connect the `NestedBus` output signal to the subsystem.
- 12 Connect the Subsystem block output port to a Scope block.
- 13 In the subsystem, disconnect the Inport and Outport blocks and insert a Bus Selector block to the right of the Inport block. Connect the Inport block to a Bus Selector block.
- 14 Show the Bus Selector block name. Change the name to `BusSelector`.
- 15 To the right of the Bus Selector block, add a Saturation block and set its **Lower limit** parameter to `-inf`.
- 16 Combine the `chirp` signal and the Saturation block output signal into a bus.
- 17 Combine the bus signal and the `step` signal into a nested bus.
- 18 Connect the nested bus to the Outport block.
- 19 To see the simulation results, simulate the model and open the Scope blocks.

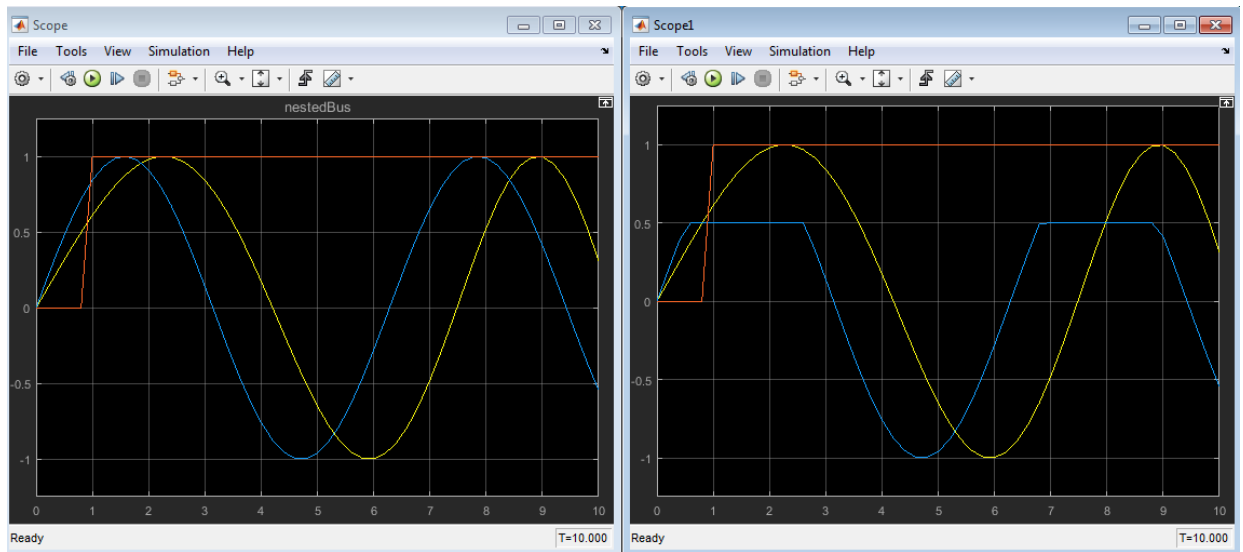

## Create and Use Nonvirtual Buses

This example changes the virtual buses used in the `ex_bus_tutorial_virtual` model to nonvirtual buses. To see the completed model, open the `ex_bus_tutorial_nonvirtual` model. Nonvirtual buses are required for certain modeling situations. Generating code for a nonvirtual bus represents the bus as a structure. For more information about when to use nonvirtual buses, see “Nonvirtual Bus Usage Guidelines” on page 63-11.

When you simulate the model, the bus signal lines indicate that the virtual are converted to nonvirtual buses.

ex\_bus\_tutorial\_nonvirtual ▶

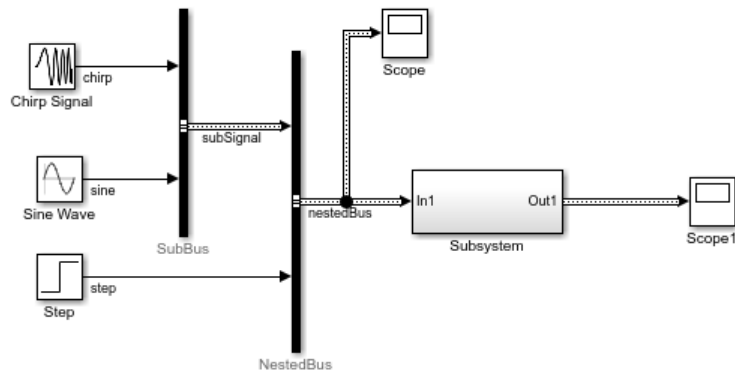

ex\_bus\_tutorial\_nonvirtual ▶ Subsystem

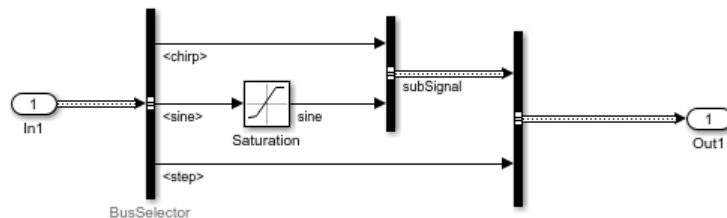

Perform these steps to gain experience creating and using nonvirtual buses.

- 1 Open the `ex_bus_tutorial_virtual` model.
- 2 Bus signals do not specify whether they are virtual or nonvirtual; they inherit that specification from the block in which they originate. Every block that creates or requires a nonvirtual bus must have an associated bus object.

For the **SubBus** block, specify to produce nonvirtual bus output. In the Block Parameters dialog box, set **Output data type** to **Bus: subBus**. This setting uses the `subBus` bus object, which provides bus properties that Simulink uses to validate the bus signal.

Also, select the **Output as nonvirtual bus** parameter.



**Note:** When you use bus objects to create nonvirtual buses, the bus object must be in the base workspace before simulating the model. You need to define the bus object or use an already defined bus object. To simplify this example, when you open the model, a model callback loads the necessary bus objects into the base workspace. To see the callback, open **File > Model Properties > Model Properties** and open the **Callbacks** tab.

For information about creating bus objects, see “Create Bus Objects” on page 63-63.

---

- 3** In the `NestedBus` block, set **Output data type** to `Bus: topBus` and select the **Output as nonvirtual bus** parameter.
- 4** The `subBus` bus object expects the second input signal in the bus to be called `sine`. Although the Bus Selector block selected the `sine` signal from the bus, the default name of the output signal of the Saturation block is not `sine`. Use the **Signal Properties** dialog box to name the Saturation block output signal `sine`.
- 5** The `topBus` bus object expects the first input signal in the bus to be called `subSignal`. Use the **Signal Properties** dialog box to name the bus signal `subSignal`.
- 6** To see the simulation results, simulate the model and open the Scope blocks. The results are the same as when you simulate the `ex_bus_tutorial_virtual` model that you used as a base for this model.

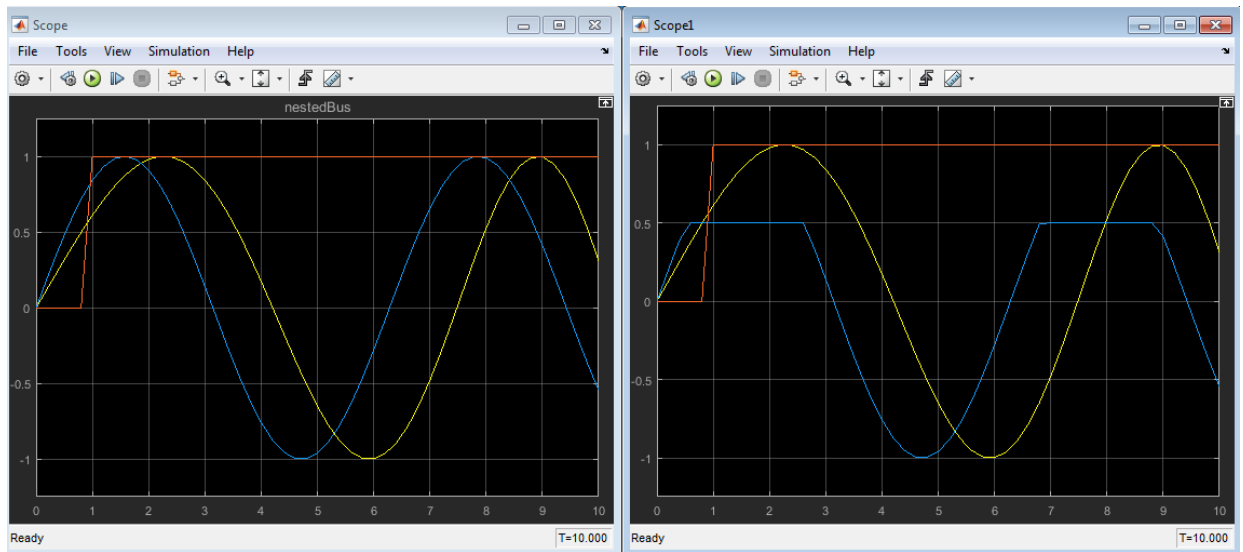

## Generate Code for Buses

The simulation results are the same for the model that uses virtual buses (`ex_bus_tutorial_virtual`) and for the model that uses nonvirtual buses (`ex_bus_tutorial_nonvirtual`). However, the generated code is different.

Adding a Unit Delay block and an Output block after the Subsystem block in each of the models helps to highlight the differences in the generated code.

ex\_bus\_tutorial\_virtual\_code\_gen ▶

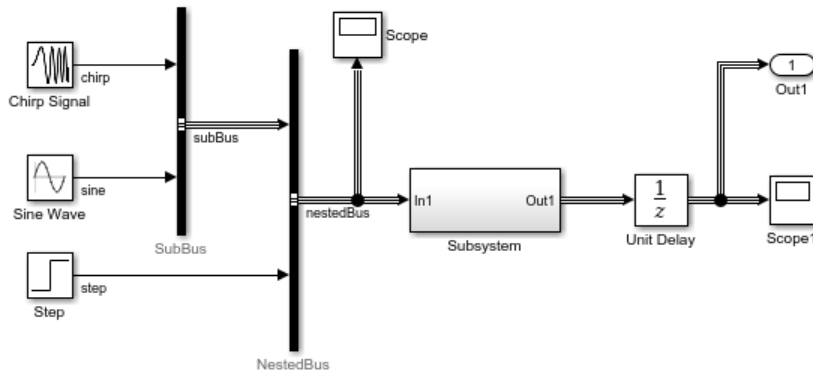

### Generated Code for the Virtual Bus Model

Generate code from the `ex_bus_tutorial_virtual_code_gen` model.

The virtual buses do not affect the generated code. For example, in the generated file `ex_bus_tutorial_virtual_code_gen.c`, the algorithm in the model `step` function effectively implements three Unit Delay blocks (one for each meaningful signal, such as `chirp`, that passes through the block).

```
/* UnitDelay: '<Root>/Unit Delay' */
rtb_chirp = ex_bus_tutorial_virtual_code_DW.UnitDelay_1_DSTATE;

/* UnitDelay: '<Root>/Unit Delay' */
rtb_signal2 = ex_bus_tutorial_virtual_code_DW.UnitDelay_2_DSTATE;

/* UnitDelay: '<Root>/Unit Delay' */
rtb_step = ex_bus_tutorial_virtual_code_DW.UnitDelay_3_DSTATE;
```

### Generated Code for the Nonvirtual Bus Model

For the nonvirtual bus model, the **Output data type** is set to `Bus: topBus` and `Scope` blocks are commented out, because `Scope` blocks are not needed for the generated code and do not support code generation.

Generate code from the `ex_bus_tutorial_nonvirtual_code_gen` model.

The nonvirtual buses appear in the generated code as structures. Each `Simulink.Bus` object appears as a structure type. The type definitions appear in `ex_bus_tutorial_nonvirtual_code_gen_types.h`.

```
typedef struct {
    real_T chirp;
    real_T sine;
} subBus;

typedef struct {
    subBus subSignal;
    real_T step;
} topBus;
```

The algorithm in the model `step` function can implement the Unit Delay block as a single line of code. The block state and output are structures of type `topBus`.

```
/* UnitDelay: '<Root>/Unit Delay' */
rtb_UnitDelay = ex_bus_tutorial_nonvirtual_c_DW.UnitDelay_DSTATE;
```

## See Also

### Blocks

[Bus Creator](#) | [Bus Selector](#) | [Bus to Vector](#) | [Demux](#) | [Matrix Concatenate](#) | [Mux](#) | [Vector Concatenate](#)

### Functions

[Simulink.BlockDiagram.addBusToVector](#) | [Simulink.Bus.cellToObject](#) | [Simulink.Bus.createMATLABStruct](#) | [Simulink.Bus.createObject](#) | [Simulink.Bus.objectToCell](#) | [Simulink.Bus.save](#)

### Classes

[Simulink.Bus](#) | [Simulink.BusElement](#)

## Related Examples

- “Overview of Composite Signal Techniques” on page 63-3
- “Select a Composite Signal Technique” on page 63-11
- “Bus-Capable Blocks” on page 63-43
- “Nested Buses” on page 63-46
- “Display Information About Buses” on page 63-37

- “Specify Bus Signal Sample Times” on page 63-55
- “Assign Signal Values to a Bus” on page 63-48
- “When to Use Bus Objects” on page 63-59
- “Use Buses for Inports and Outports” on page 63-95
- “Specify Initial Conditions for Bus Signals” on page 63-99
- “Buses in the Generated Code” on page 63-147

## Simplify Subsystem Bus Interfaces

### In this section...

“Bus Element Ports” on page 63-27

“Create Bus Element Ports” on page 63-28

“Convert Models to Use Bus Element Ports” on page 63-30

The In Bus Element and Out Bus Element blocks provide a simplified and flexible way to use bus signals as inputs and outputs to subsystems. The In Bus Element block is equivalent to an Inport block combined with a Bus Selector block. The Out Bus Element block is equivalent to an Outport block combined with a Bus Creator block.

This model uses Inport, Bus Selector, Bus Creator, and Outport blocks.

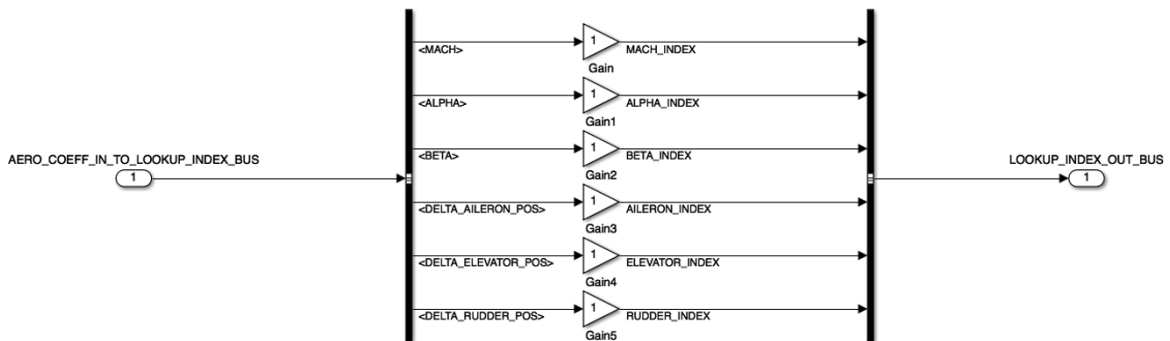

Here is an equivalent model using bus element port blocks.

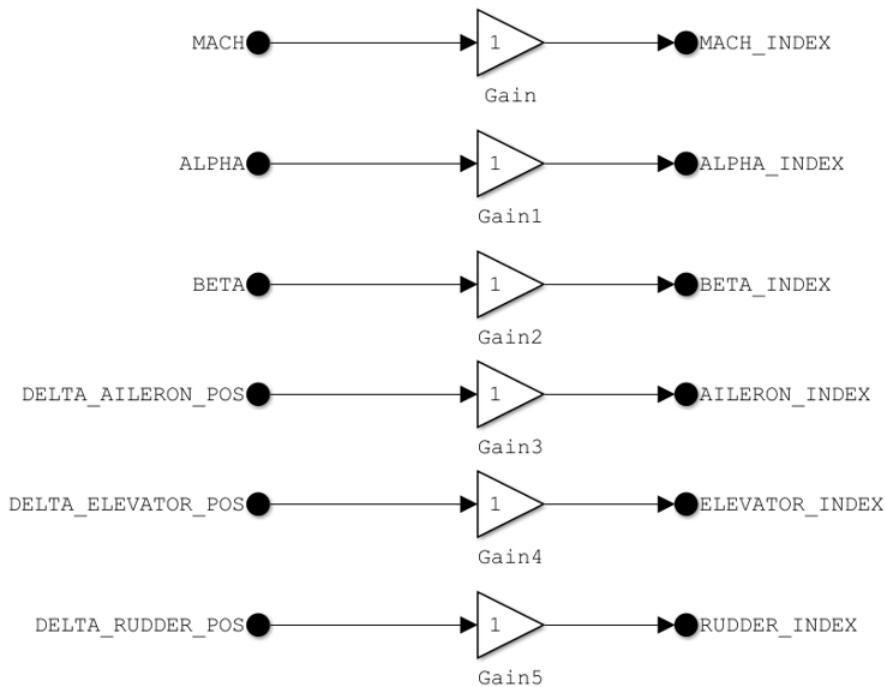

To work with buses at subsystem interfaces, consider using In Bus Element and OutBusElement blocks. This bus element port block combination:

- Reduces signal line complexity and clutter in a block diagram.
- Makes it easy to change the interface incrementally.
- Allows access to a bus element closer to the point of usage.
  - For input, avoid a configuration that contains duplicate Inport blocks and a Bus Selector, Goto, and From blocks.
  - For output, avoid a configuration that contains duplicate Goto, From, and Bus Creator blocks.

## Bus Element Ports

Use In Bus Element blocks to select bus elements from a bus signal that is input to a subsystem. For nonbus signals (including array of buses signals) that feed a subsystem,

the In Bus Element block passes through the value of the input signal for use within the subsystem.

Use Out Bus Element blocks to combine subsystem signals into a virtual bus to output from the subsystem.

You can use bus element port blocks with virtual or nonvirtual bus signals, array of buses signals, and nonbus signals.

- For array of bus signals and nonbus signals, the bus element port blocks can only pass through the whole signal, rather than selecting individual elements of the signal.
- An Out Bus Element block outputs a virtual bus signal from the subsystem.

The In Bus Element block is of block type Inport. The Out Bus Element block is of block type Outport. The bus element port blocks support inherited workflows. You cannot use the Block Parameters dialog box of a bus element port block to specify bus element attributes, such as data type or dimensions.

In the same subsystem, you can use a combination of bus element port blocks with Inport and Outport blocks. However, to improve the readability of the model, define a bus interface for a subsystem by using bus element port blocks throughout the subsystem.

---

**Note:** If you save a model containing bus element port blocks to a version of Simulink earlier than R2017a, Simulink stubs out the subsystem bus ports and displays a warning.

---

## Create Bus Element Ports

For a new subsystem, creating bus element ports involves adding In Bus Element blocks to select subsystem input signals and Out Bus Element blocks to create virtual bus output signals for the subsystem. For an example showing the workflow for adding bus element ports, see the In Bus Element documentation.

---

**Note:** The In Bus Element block has two different names, depending on the library in which it appears. The functionality of both blocks is the same.

- In the Ports & Subsystems library — In Bus Element
- In the Signal Routing library — Bus Element In



The Out Bus Element block has two different names, depending on the library in which it appears. The functionality of both blocks is the same.

- In the Ports & Subsystems library — Out Bus Element
  - In the Signal Routing library — Bus Element Out
- 

### Add In Bus Element Blocks

To add an In Bus Element block, you can:

- Drag the block from the Library Browser. This action adds a port.
- Use quick insert. This action adds a port.
- Copy the block from an existing block. Either use copy and paste or right-click and drag the block. Then specify whether to use the same port as the original block for new block or to add a subsystem port.
- In the Block Parameters dialog box list of input signals, select a signal and click .

To select a signal from the input port, use one of these approaches:

- In the Block Parameters dialog box, select one or more signals from the list of signals and click **Add block**.
- In the Simulink Editor, edit the element part of the block icon text. If the port is already connected outside the subsystem, you can select from a list of available signals. For example, the default icon text is `InBus.signal1`. To specify an element, edit the `signal1` text.

To pass through a whole signal, leave the element section of the block icon text empty.

To select multiple signals from an input bus signal, create multiple In Bus Element blocks, one for each selected signal.



You can specify the background color for bus element port blocks, using the Block Parameters dialog box **Set color** option. This action sets the color of blocks associated with selected elements, or to all blocks if you do not select elements.

### Add Out Bus Element Blocks

To output multiple signals from a subsystem as a bus signal, create multiple Out Bus Element blocks, one for each signal that you want to include in the bus. To add an Out Bus Element block, you can:

- Drag the block from the Library Browser. This action add a port.
- Use quick insert. This action adds a port.
- Copy the block from an existing block. Either copy and paste or right-click and drag the block. Then specify whether to use the same port as the original block for the new block or to add a subsystem port.
- In the Block Parameters dialog box, click . To change the signal name, double-click the signal name in the tree view or in the icon text in the block diagram and edit the text.

If an Out Bus Element block creates a signal A, then another Out Bus Element block for the same port cannot specify signal A (or a child of signal A) as an element.

To add a subbus, in the Block Parameters dialog box, click . To remove blocks associated with selected elements, click .

You can reorder bus elements by dragging and dropping a signal in the list of signals in the Block Parameters dialog box.

You can specify the background color for bus element port blocks, using the Block Parameters dialog box **Set color** option. This action sets the color of blocks associated with selected elements, or to all blocks if you do not select elements.

## Convert Models to Use Bus Element Ports

You can refactor a subsystem interface that uses Inport, Bus Selector, Bus Creator, and Outputport blocks to use In Bus Element and Out Bus Element blocks. Conversion operations are supported only when the signal lines or blocks do not have any extra specification, including signal logging. You can:

- Convert Inport and Bus Selector blocks in a subsystem to In Bus Element blocks.
- Convert Outputport and Bus Creator blocks in a subsystem to Out Bus Element blocks.
- Transform input or output interfaces of subsystems to use bus element port blocks.

### Convert Subsystem Bus Selector Blocks

You can convert a subsystem that uses Bus Selector blocks to use In Bus Element blocks instead.

- 1 Click the Bus Selector block that is connected to the Inport block.

2 From the action bar, select **Bus Element Ports**.

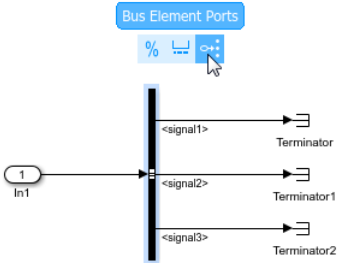

The converted subsystem uses In Bus Element blocks.

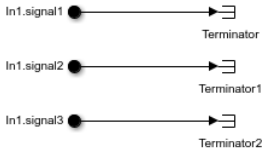

You can do a similar conversion for multiple layers of Bus Selector blocks.

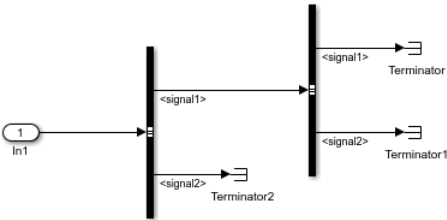

- 1 Perform the conversion on the Bus Selector block that is connected to the Inport block.
- 2 Convert the second Bus Selector block.

**Convert Subsystem Bus Creator Blocks**

You can convert a subsystem that uses Bus Creator blocks to use Out Bus Element blocks instead.

- 1 Click the Bus Creator block that is connected to the Outport block.
- 2 From the action bar, select **Bus Element Ports**.

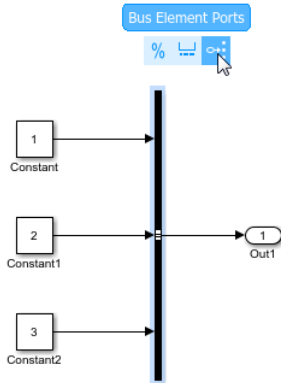

The converted subsystem uses Out Bus Element blocks.

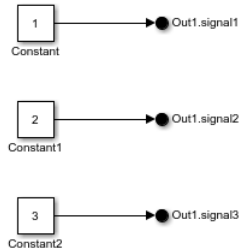

You can do a similar conversion for multiple layers of Bus Creator blocks.

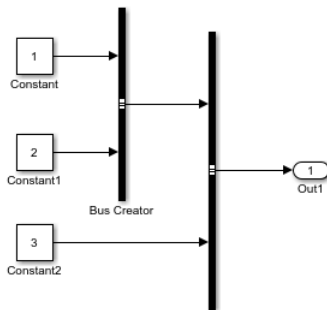

- 1 Perform the conversion on the Bus Creator block that is connected to the Output block.
- 2 Convert the second Bus Creator block.

### Transform Subsystem Input and Output Interfaces

You can convert signals between subsystems to use In Bus Element and Out Bus Element blocks.

---

**Note:** Conversion of existing subsystem inputs and outputs to use bus element ports creates virtual buses. If your model relies on the types of the original signals being nonvirtual buses, array of buses, or scalars, choose one of these options:

- Do not perform the conversion.
  - Modify the model so that it works properly with the newly created virtual buses.
- 

- 1 Perform a marquee selection of the signals that connect two subsystems.
- 2 From the action bar, select **Create Bus**.

The conversion creates Out Bus Element blocks in the left subsystem (the input for the second subsystem) and In Bus Element blocks in the right subsystem.

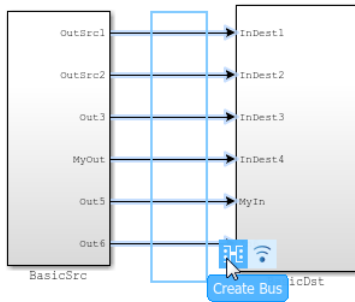

You can convert input signals for a subsystem to use a Bus Creator block to combine the inputs. The subsystem uses In Bus Element blocks.

- 1 Perform a marquee selection of the input signals of the subsystem.
- 2 From the action bar, select **Create Bus**.

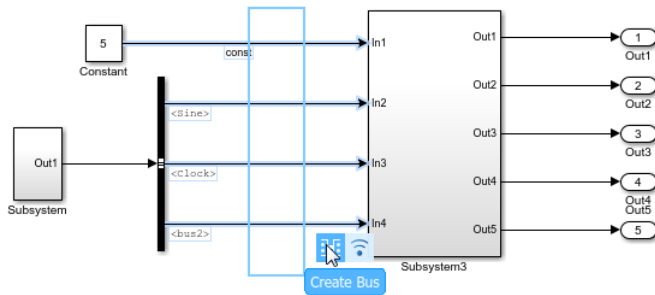

Use a similar approach to convert the subsystem output signals.

The converted model uses Bus Creator blocks for subsystem inputs and Bus Selector blocks for subsystem outputs. The converted subsystem (**Subsystem3**) contains In Bus Element and Out Bus Element blocks.

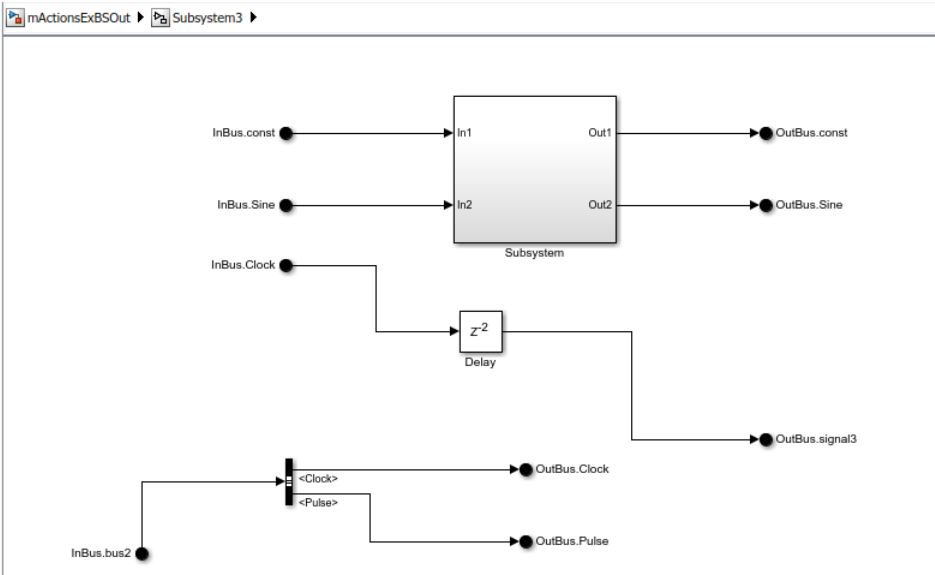
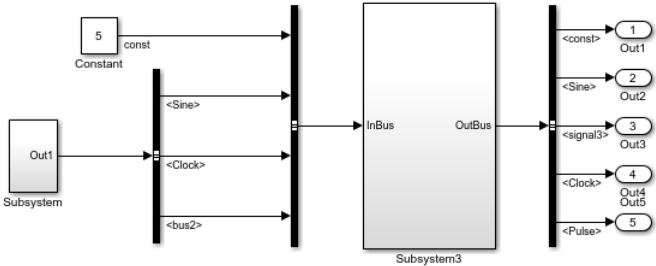

### See Also

#### Blocks

Bus Creator | In Bus Element | Inport | Out Bus Element | Outport

#### Related Examples

- “Overview of Composite Signal Techniques” on page 63-3
- “Select a Composite Signal Technique” on page 63-11

- “Getting Started with Buses” on page 63-16



## Display Information About Buses

In this section...
“Signal Hierarchy Viewer” on page 63-37
“Port Value Display” on page 63-39
“CompiledBusType and SignalHierarchy Parameters” on page 63-41

To view information about buses, use one of these approaches:

- To display bus signals in a bus hierarchy interactively, use the “Signal Hierarchy Viewer” on page 63-37.
- To display the value of a specific port or port values for a block before simulation, right click on the signal and select **Show Value Label of Selected Port**. For details, see “Port Value Display” on page 63-39.
- To display at the MATLAB command line the type and hierarchy of a bus signal use the **CompiledType** and **SignalHierarchy** parameters. For details, see “CompiledBusType and SignalHierarchy Parameters” on page 63-41.

### Signal Hierarchy Viewer

You can use the Signal Hierarchy Viewer to display information about a signal. To display the bus hierarchy:

- 1 Right-click a signal line.
- 2 Select the **Signal Hierarchy** option. The Signal Hierarchy Viewer dialog box appears.

For example, open the `busdemo` model.

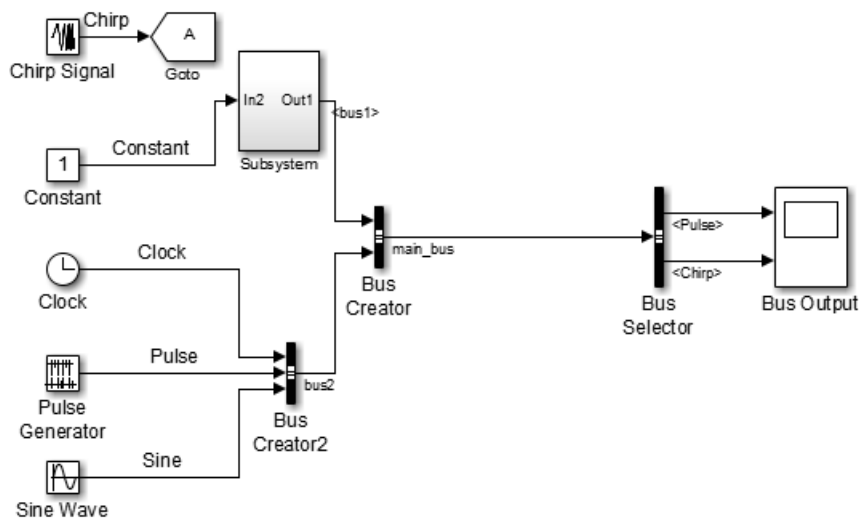

Right-click the `main_bus` signal (output signal for the Bus Creator block), and select **Signal Hierarchy**.

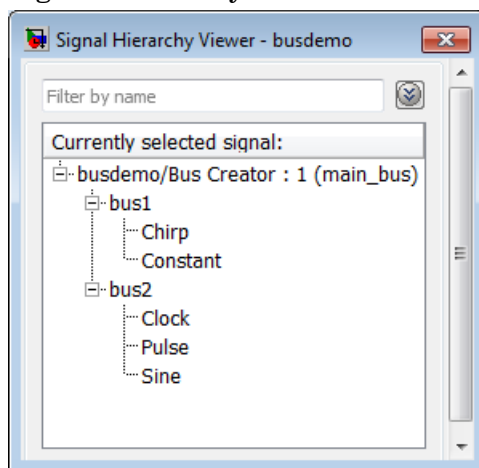

Each Signal Hierarchy Viewer is associated with a specific model. If you edit a model while the associated Signal Hierarchy Viewer is open, the Signal Hierarchy Viewer reflects those updates.

You can also open the Signal Hierarchy Viewer in the Simulink Editor.

- 1 Select **Diagram > Signals & Ports > Signal Hierarchy**.
- 2 Select a signal.

---

**Note:** To produce accurate results at edit time, the Signal Hierarchy Viewer requires that the model compiles successfully.

---

To filter the displayed signals, click the **Options** button on the right-hand side of the **Filter by name** edit box (  ).

- To use MATLAB regular expressions for filtering signal names, select **Enable regular expression**. For example, to display all signals whose names end with a lowercase `r` (and their immediate parents), enter `r$` in the **Filter by name** edit box. For details, see “Regular Expressions” (MATLAB).
- To use a flat list format to display the list of filtered signals, based on the search text in the **Filter by name** edit box, select **Show filtered results as a flat list**. The flat list format uses dot notation to reflect the hierarchy of bus signals. This example shows a flat list format for a filtered set of nested bus signals.

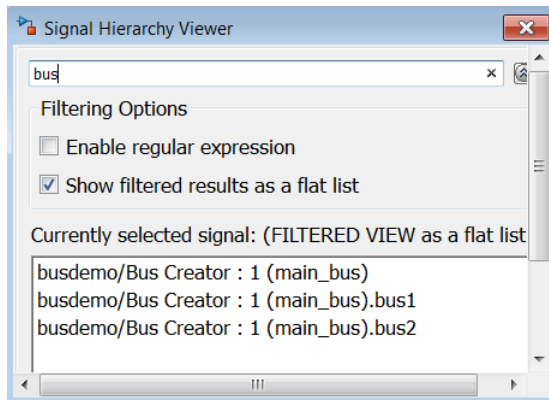

## Port Value Display

To display the value of a specific port or port values for a block before simulation, right click on the signal and select **Show Value Label of Selected Port**.

For bus signals, the **Show Value Label of Selected Port** option opens a dialog box where you can select from all signals in the bus. For example, in this model, you can see the dialog box for all signals that are contained in ModelBus.

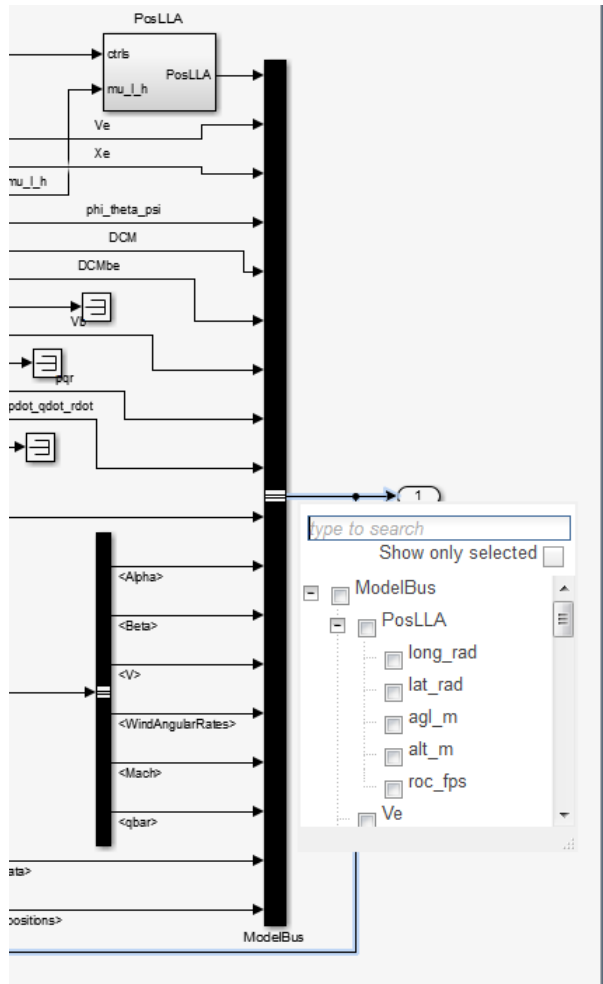

For more information about port value display, see “Display Value for a Specific Port” on page 34-20.

## CompiledBusType and SignalHierarchy Parameters

To get information about the type and hierarchy of a bus signal in a compiled model, use these parameters with the `get_param` command:

- **CompiledBusType** — For a compiled model, returns information about whether the signal connected to a port is a bus and whether the signal is a virtual or nonvirtual bus.
- **SignalHierarchy** — If the signal is a bus, returns the name and hierarchy of the signals in the bus.

Before you use these commands, for **CompiledBusType**, update the diagram or simulate the model.

For example, open and simulate the `busdemo` model.

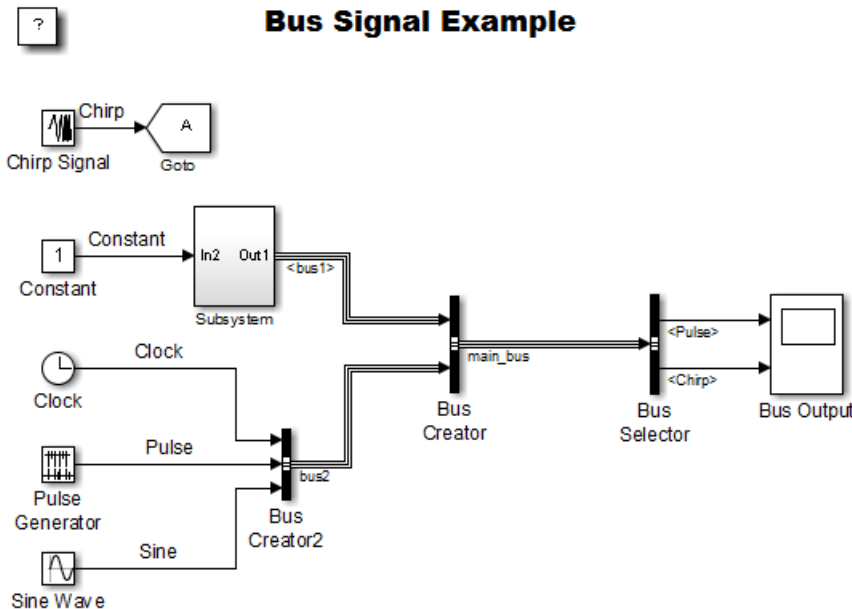

This code illustrates how you can use the `SignalHierarchy` and `CompiledBusType` parameters:

```
mdl = 'busdemo';
```

```
open_system mdl
% Obtain the handle a port
ph = get_param([mdl '/Bus Creator'], 'PortHandles');
% SignalHierarchy is available at edit time
sh = get_param(ph.Outport, 'SignalHierarchy')
% Compile the model
busdemo([],[],[], 'compile');
bt = get_param(ph.Outport, 'CompiledBusType')
% Terminate the model
busdemo([],[],[], 'term');
```

## Related Examples

- “Getting Started with Buses” on page 63-16

## Bus-Capable Blocks

Bus-capable blocks can accept bus signals as input, produce bus signals as output, or both. Some bus-capable blocks work with nonvirtual buses, but not with virtual buses. Some bus-capable blocks have additional requirements for bus signals; see the block documentation for details.

Block	Input	Output
All virtual blocks	✓	✓
Assignment(nonvirtual buses)	✓	✓
Bus Assignment	✓	✓
Bus Creator	✓	✓
Bus Selector	✓	✓
Constant (nonvirtual buses)		✓
Data Store Memory (nonvirtual buses)	Has no input port, can store bus signals	
Data Store Read (nonvirtual buses)		✓
Data Store Write (nonvirtual buses)	✓	
Delay	✓ (special requirements)	✓ (special requirements)
From File (nonvirtual buses)		✓
From Workspace (nonvirtual buses)		✓
Interpolation Using Prelookup	✓	
Manual Switch	✓	✓
Memory	✓ (special requirements)	
Merge	✓ (special requirements))	

Block	Input	Output
Multiport Switch	✓ (special requirements)	
Prelookup		✓ (special requirements)
Rate Transition	✓ (special requirements)	
Signal Conversion	✓	✓ (special requirements)
Signal Specification	✓	✓
Switch	✓ (special requirements)	✓
To File (nonvirtual buses)	✓ (special requirements)	
To Workspace (nonvirtual buses)	✓	
Unit Delay	✓ (special requirements)	✓
Vector Concatenate(nonvirtual buses)	✓	✓
Zero-Order Hold	✓	✓

These modeling patterns support the use of buses. See the documentation for those features for any special considerations relating to the use of buses. Subsystems, models, and S-functions support the use of buses.

- Subsystems
- Model referencing
- S-Functions
- Stateflow charts
- MATLAB Function blocks
- MATLAB System blocks



Buses that contain signals of enumerated data types do not pass through a block that requires a nonzero scalar initial value (such as a Unit Delay block). Use a structure value to initialize signals with enumerated types.

Root level bus outputs are not logged when you select the **Configuration Parameters > Data Import/Export > Output** parameter. Use standard signal logging instead, as described in “Export Signal Data Using Signal Logging” on page 59-70.

Do not use signal logging for bus or array of buses signals directly from within a For Each subsystem. Either use a Bus Selector block to select the bus element signals to log or add an Outport block outside of the subsystem and then log that signal. For details, see “Log Signals in For Each Subsystems” on page 59-111.

## See Also

### Blocks

Bus Creator | Bus Selector

## Related Examples

- “Overview of Composite Signal Techniques” on page 63-3
- “Select a Composite Signal Technique” on page 63-11
- “Getting Started with Buses” on page 63-16

## Nested Buses

You can nest buses to any depth. To create a nested bus, use a Bus Creator block. If one of the inputs to the Bus Creator block is a bus, then the output is a nested bus. To select a signal within a nested bus, use a Bus Selector block.

For example, in the next model, the **Bus3** bus signal combines two signals, **motor3** and **motor4**. The **Bus2** signal combines the **Bus3** bus signal and the **motor1** and **motor2** signals. The **Bus1** signal combines the **Bus2** bus signal and the **motor5** signal.

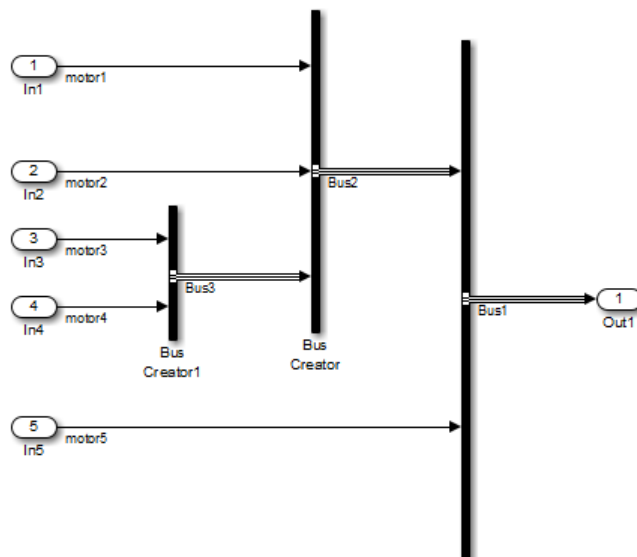

All the signals retain their separate identities, as if no bus creation and selection occurred. You can use Bus Selector blocks to select individual signals from a nested bus.

The Simulink software automatically handles most of the complexities involved. For example, you can have Simulink repair broken selections in the Bus Selector and Bus Assignment block parameter dialog boxes due to upstream bus hierarchy changes. To enable these automatic repairs, in the **Configuration Parameters > Diagnostics > Connectivity** pane, set the **Repair bus selections** diagnostic to **Warn and repair**. The repairs occur when you update a model. To save the repairs, save the model.

## Circular Dependency in Bus Definitions

Nesting buses can produce a loop of Bus Creator, Bus Selector, and bus-capable blocks that inadvertently includes a bus as an element of itself. The resulting circular definition cannot be resolved and therefore causes an error.

The error message that appears specifies the location at which the Simulink software determined that the circular structure exists. The error is not really at any one location: the structure as a whole is in error. Nonetheless, the location cited in the error message can be useful for beginning to trace the definition cycle. However, the circular structure is not always obvious on visual inspection.

- 1 Begin by selecting a signal line associated with the location cited in the error message.
- 2 Right-click a signal and choose **Highlight Signal to Source** or **Highlight Signal to Destination**. See “Display Signal Sources and Destinations” on page 62-38 for more information.
- 3 Continue choosing signals and highlighting their sources and destinations until the cycle becomes clear.
- 4 Restructure the model to eliminate the circular bus definition.

Because the problem is a circular definition rather than a circular computation, the cycle cannot be broken by inserting additional blocks. You cannot fix the circular definition the way that you can break an algebraic loop by inserting a Unit Delay block. Restructure the model to eliminate the circular bus definition.

## See Also

### Blocks

Bus Creator | Bus Selector

## Related Examples

- “Getting Started with Buses” on page 63-16

## Assign Signal Values to a Bus

To assign the values of a signal to bus element, you can use a Bus Assignment block. Use a Bus Assignment block to change bus element values without adding Bus Selector and Bus Creator blocks that select bus elements and reassemble them into a bus.

Connect to the Bus Assignment block ports:

- The bus signal to which you want to assign the signal values
- The signals whose values you want to assign to specified bus elements

Connect the bus signal to the first input port of the Bus Assignment block, and one or more signals to be assigned to the other ports. The Block Parameters dialog box lists the signals available for assignment in the bus. The bus can be virtual or nonvirtual. Select the elements to which you want to assign signal values. If you specify more than one signal to assign values to, the Bus Assignment block adds ports.

The signals that you assign values to can be nonbus or bus signals. The signals must match the attributes of the signals in the original bus.

## Update a Bus Element

This simple example illustrates the mechanics of using the Bus Assignment block. In more complex models, using a Bus Assignment block simplifies updating a bus to reflect the processing that occurs in a separate component, such as a subsystem or referenced model. Here is the model after you simulate it.

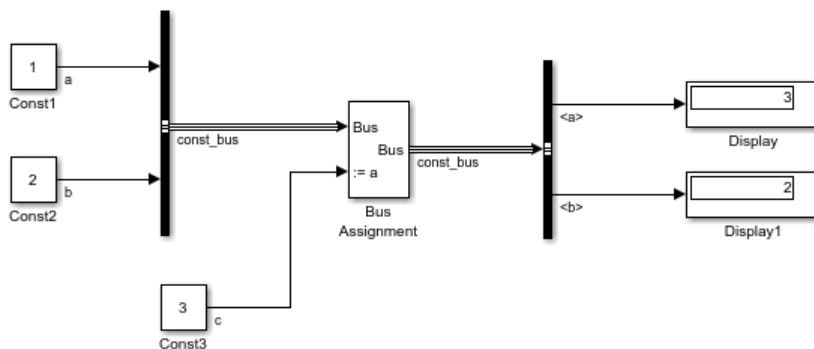

Some key steps in constructing this model are:

- 1 Connect two Constant blocks to a Bus Creator block. The value of signal **a** is 1, and the value of signal **b** is 2.
- 2 Connect the Bus Creator output signal **const\_bus** to the first port of a Bus Assignment block. The bus elements **a** and **b** are available to assign new values to them.
- 3 Connect the Constant block output signal **c** to the second port of the Bus Assignment block.
- 4 For the Bus Assignment block, in the Block Parameters dialog box **Signals in the bus** list, select the **a** signal and click **Select>>**.

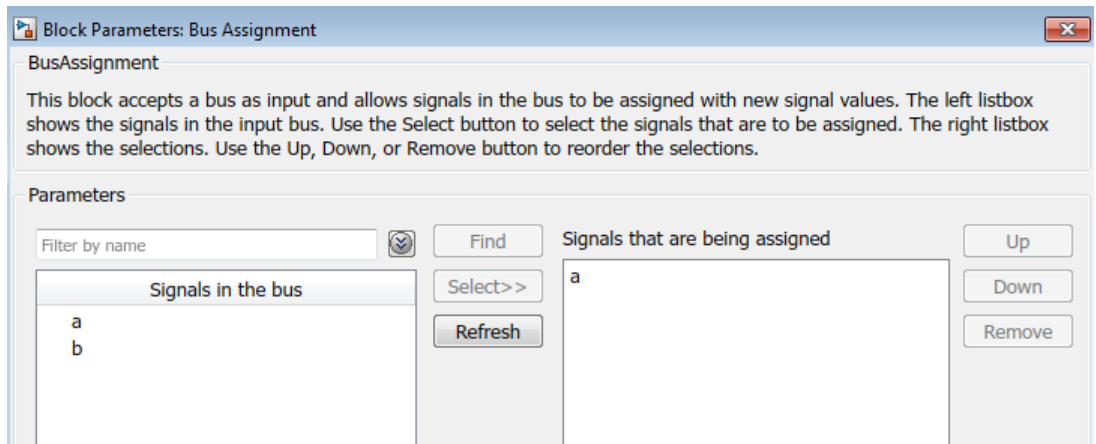

- 5 Use a Bus Selector to select signals **a** and **b** from the **const\_bus** signal and connect those signals to Display blocks.
- 6 Simulate the model. The Display blocks show that the value of signal **a**, which was 1 when the **const\_bus** bus was created, is now 3, reflecting the assignment of the **c** signal from the **Const3** block.

## See Also

### Blocks

Bus Assignment

## **Related Examples**

- “Getting Started with Buses” on page 63-16

## Correct Buses Used as Vectors

### Three Approaches

The three approaches that you can use to correct bus signals used as vectors (muxes) to avoid an error are:

- “Use the Model Advisor” on page 63-51
- “Explicitly Add Bus to Vector Blocks” on page 63-51
- “Reorganize the Model” on page 63-53

Generally, using the Model Advisor is the most efficient approach.

### Use the Model Advisor

- 1 In the Simulink Editor, select **Analysis > Model Advisor > Model Advisor**.
- 2 Select and run the Simulink “**Check bus signals treated as vectors**” check.

The Model Advisor reports any cases of bus signals treated as vectors.

- 3 Follow the Model Advisor suggestions for correcting errors reported by the check.

For additional information about using the Model Advisor, see “Select and Run Model Advisor Checks” on page 5-2.

### Explicitly Add Bus to Vector Blocks

You can explicitly add Bus to Vector blocks to convert the bus signal to a mux (vector), using one of these approaches:

- To convert the bus to a vector explicitly, insert the Bus to Vector block into any bus used implicitly as a vector.
- Use the `Simulink.BlockDiagram.addBusToVector` function, which automatically inserts Bus to Vector blocks wherever needed.

For example, this model treats a bus signal as a vector signal by using the bus as an input to a Gain block. The Scope block shows the simulation results.

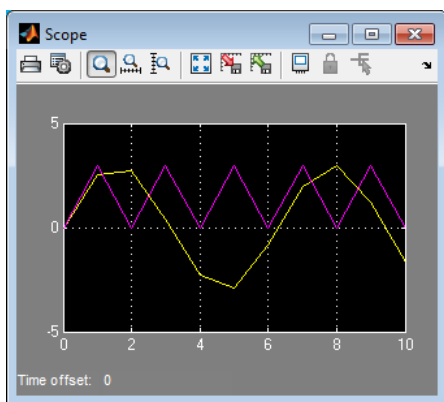
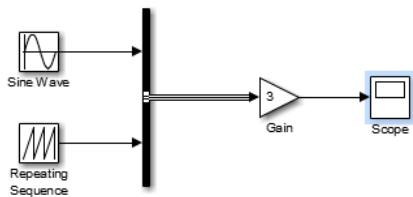

This figure shows the same model, rebuilt after inserting a Bus to Vector block after the Bus Creator block.

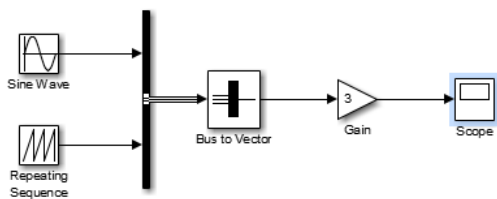



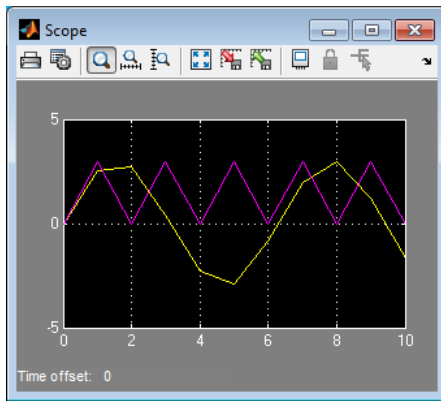

The results of simulation are the same in either case, but adding the Bus to Vector block avoids an error. The Bus to Vector block is virtual, and does not affect simulation results, code generation, or performance.

## Reorganize the Model

You can replace blocks manually. Change the sources for a block that require vector inputs to avoid feeding a bus signal into a block that requires vector input.

For example, in the following model, the Gain block requires a vector signal. However, the input signal is a bus signal created by a Bus Creator block.

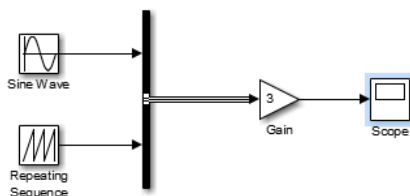

To provide the required vector signal for the Gain block, change the Bus Creator block to a Mux block.

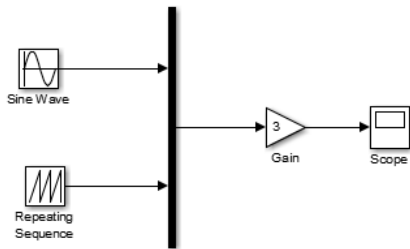

Challenges with reorganizing the model manually include:

- It can be difficult to identify all the occurrences in a model. (The Model Advisor check identifies all occurrences in the model and helps you to correct them.)
- Dealing with many occurrences in a model is time-consuming and error-prone.
- Reorganizing the model to address this issue can interfere with other aspects of the model.

## Bus to Vector Block Compatibility Issues

If you use **Save As** for a model in a version of the Simulink product before R2007a, Simulink replaces each Bus to Vector block with a null subsystem that outputs nothing. Before you can use the model, reconnect or otherwise correct each signal that used to contain a Bus to Vector block but now is interrupted by a null subsystem.

## More About

- “Overview of Composite Signal Techniques” on page 63-3

## Specify Bus Signal Sample Times

In this section...
“Sample Times for Nonvirtual Buses” on page 63-55
“Specify Sample Times for Signal Elements” on page 63-57

The technique that you use to combine signals that use different sample times depends on the virtuality of the bus.

- Virtual buses can combine signals that have different sample times.
- Nonvirtual buses require that every element signal has the same sample time.

### Sample Times for Nonvirtual Buses

All signals in a nonvirtual bus must have the same sample time, even if the elements of the associated bus object specify inherited sample times. Any bus operation that results in a nonvirtual bus that violates this requirement generates an error. All buses and signals input to a Bus Creator block that outputs a nonvirtual bus must have the same sample time.

To include the signal or bus in a nonvirtual bus, you can use a Rate Transition block to change the sample time of an individual signal, or of all signals in a bus. Upstream of the Bus Creator block, use Rate Transition blocks to apply the same sample time to each signal element.

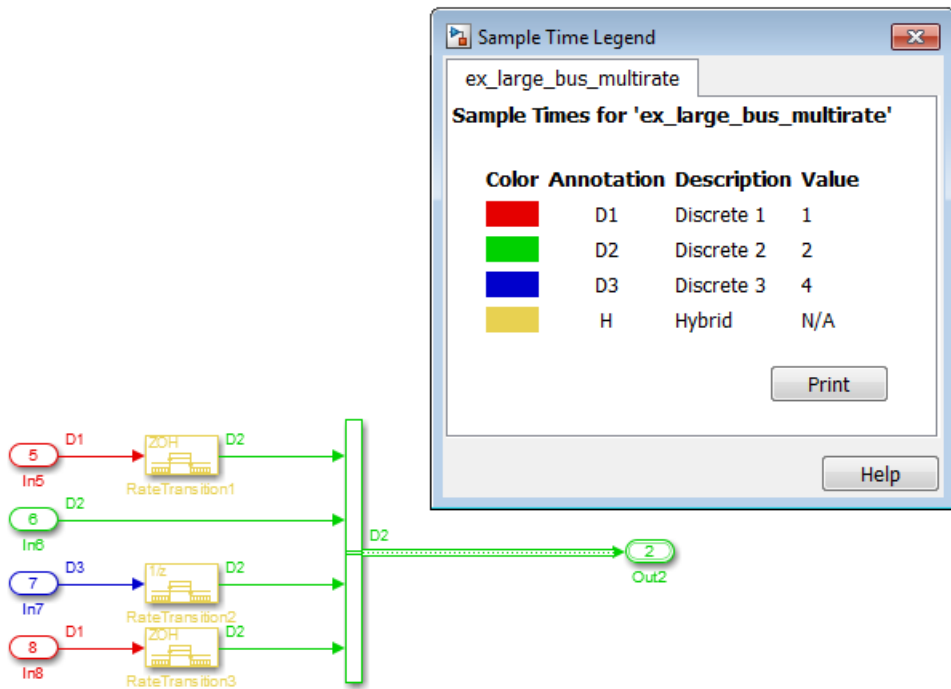

However, some blocks, such as root-level Outport blocks, automatically convert virtual buses to nonvirtual buses. In this case, you can use a single Rate Transition block after a Bus Creator block to transition all the signal elements to a single sample time.

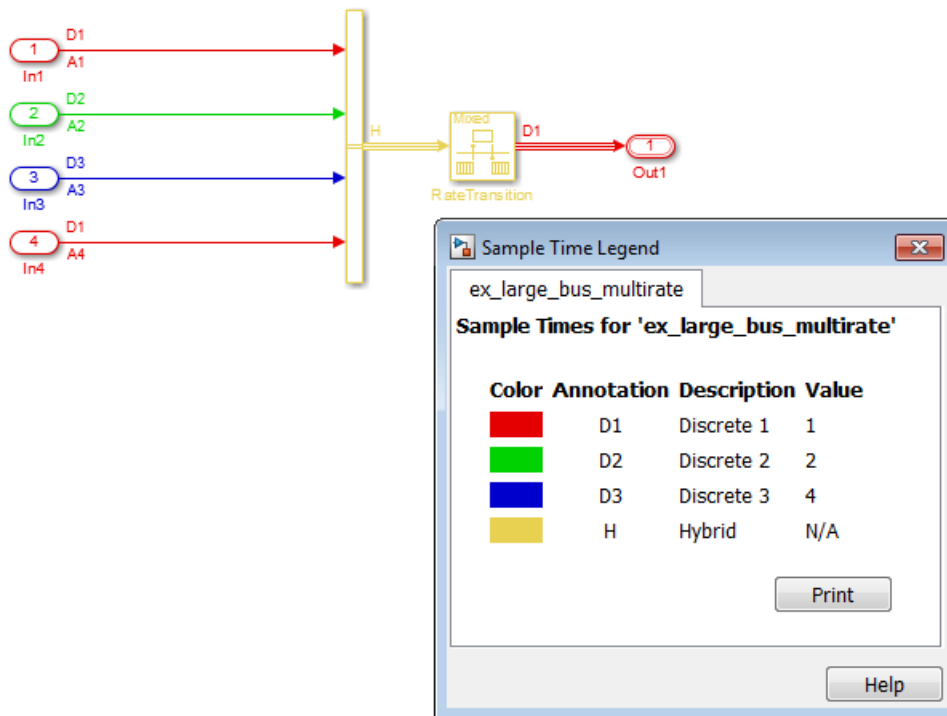

For more information about automatic conversion of virtual buses to nonvirtual buses, see “Bus Conversion” on page 63-145.

## Specify Sample Times for Signal Elements

To control the sample time of each signal element in a bus, specify the sample time in the Block Parameters dialog box of the block that generates the signal element.

To specify a sample time for a signal in a `Simulink.BUS` object, a best practice is to use the default `SampleTime` value of -1.

## See Also

### Blocks

Rate Transition

**Classes**

Simulink.Bus | Simulink.BusElement

**More About**

- “Bus Conversion” on page 63-145
- “Virtual and Nonvirtual Buses” on page 63-4
- “When to Use Bus Objects” on page 63-59
- “Sample Time”

## When to Use Bus Objects

### In this section...

“Required Uses of Bus Objects” on page 63-60

“Optional Uses of Bus Object” on page 63-60

“Bus Object Use with Blocks” on page 63-60

“Bus Object Workflow” on page 63-62

A bus can have an associated bus object, which provides properties that Simulink uses to validate the bus signal. Bus objects are optional for virtual buses, but required for nonvirtual buses.

A bus object specifies only the architectural properties of a bus, as distinct from the values of the signals it contains. For example, a bus object can specify the number of elements in a bus, the order of those elements, whether and how elements are nested, and the data types of constituent signals; but not the signal values. A bus object is analogous to a structure definition in C: it defines the members of the bus but does not create a bus. Another way of thinking of a bus object is that it is similar to a cable connector. The connector defines all the pins and their configuration and controls what types of wires can be connected to it. Similarly, a bus object defines the configuration and properties of the signals that the associated bus must have.

A bus object is an instance of class `Simulink.Bus` that can be stored in a location such as the base workspace. The object defines the structure of the bus and the properties of its elements, such as nesting, data type, and size.

A bus object serves as the root of an ordered hierarchy of bus elements, which are instances of class `Simulink.BusElement`. Each element completely specifies the properties of a signal in a bus, such as its name, data type, and dimensionality. The order of the elements contained in the bus object defines the order of the signals in the bus. A bus object can also specify properties that were not defined by constituent signals, but were left to be inherited.

You can use the Simulink Bus Editor to create and manage bus objects, as described in “Create Bus Objects with the Bus Editor” on page 63-63, or you can use the Simulink API, as described in “Create Bus Objects Programmatically” on page 63-73. After you create a bus object and specify its attributes, you can associate it with any block that needs to use the bus definition that the object provides.

You can save bus objects as MATLAB code or as a MAT-file.

## Required Uses of Bus Objects

You must use bus objects for these modeling configurations:

- Bus data that crosses model reference boundaries
- MATLAB Function block or Stateflow charts that input or output buses
- S-function or Legacy Code Tool interface with external code

## Optional Uses of Bus Object

If you use Bus Creator block parameters to specify bus signal properties, all blocks downstream from the bus inherit the same properties.

You can use Bus Creator block parameters to define virtual buses and perform limited error checking. To perform thorough error checking on a bus, associate a bus object with that bus. Using bus objects to check bus signals for errors is important when you want to create reusable and shareable model components.

To make it easier to trace the correspondence between the model and the generated code for a bus, use a nonvirtual bus. The generated code for a nonvirtual bus produces a structure, but also can result in multiple copies of some bus signals.

## Bus Object Use with Blocks

You can associate a bus object with several blocks. Some blocks require that you specify a bus object if the block has a bus input or bus output. When a bus object governs a signal output by a block, the signal is a bus that has exactly the properties specified by the object. When a bus object governs a signal input by a block, the signal must be a bus that has exactly the properties specified by the object. Any variance causes an error.

Block	Requires Bus Object for Bus Input or Output
Argument Inport	
Argument Outport	
Bus Creator	
Constant	✓



Block	Requires Bus Object for Bus Input or Output
Data Store Memory	✓
Data Store Read	✓
Data Store Write	✓
From File	✓
From Workspace	✓
Function Caller	✓
Inport (root-level)	✓
Interpolation Using Prelookup	✓
MATLAB Function	✓
MATLAB System	✓
Outport (root-level)	✓
Permute Dimensions	
Prelookup	✓
Probe	
Reshape	
S-Function	✓
Signal Conversion	
Signal Specification	
State Reader	✓
Unit Delay	

To associate a block with a bus, in the Block Parameters dialog box, set **Data type to Bus:** <object name> and replace <object name> with the bus object name.

If a subsystem that is in a library contains a block that uses a bus object, all instances of that block must match the bus object specification.

**Note:** Do not set the minimum and maximum values for bus data on blocks with bus object data type. Simulink ignores these settings. Instead, set the minimum and maximum values for bus elements of the bus object specified as the data type. The values should be finite real double scalar.

For information on the `Minimum` and `Maximum` properties of a bus element, see `Simulink.BusElement`.

---

## Bus Object Workflow

Using bus objects in a model involves performing these tasks, in many cases iteratively.

- 1 Determine where you need or want to use bus objects.
- 2 Determine how you want to manage the bus objects, to keep track of the bus objects used by a model and the models that use the bus objects.
- 3 Create the bus objects in the MATLAB base workspace.
- 4 Export the bus objects from the base workspace to a MATLAB code file or a MAT-file.
- 5 Import bus objects from files to models that use the bus objects.

## See Also

### Blocks

Bus Creator

### Classes

`Simulink.Bus` | `Simulink.BusElement`

## Related Examples

- “Create Bus Objects with the Bus Editor” on page 63-63
- “Create Bus Objects Programmatically” on page 63-73
- “Modify Bus Objects” on page 63-76
- “Save and Import Bus Objects” on page 63-82
- “Map Bus Objects to Models” on page 63-88

## Create Bus Objects with the Bus Editor

### In this section...

“Open the Bus Editor” on page 63-63

“Create Bus Objects” on page 63-63

“Create Bus Elements for the Bus Object” on page 63-65

“Nest Bus Object Definitions” on page 63-68

“Use the Bus Objects in the Model” on page 63-71

To create a bus object and its elements interactively, use the Simulink Bus Editor. The bus objects that you create with the Bus Editor are stored in the MATLAB base workspace. To simulate a block that uses a bus object, the bus object must be in the base workspace or in a data dictionary. To save bus object definitions to associate with models, export the bus objects from the base workspace into a MATLAB code file or MAT-file (see “Save and Import Bus Objects” on page 63-82).

You can specify the bus object to be the data type of a block either before or after defining the bus object. However, before you simulate the model, the bus object and the corresponding bus signal must have the same number of bus elements, in the same order. Also, each bus element in the bus object and in the corresponding signal in the model must have the same attributes.

During model development, you can modify bus signals to match bus objects or modify bus objects to match buses.

### Open the Bus Editor

Open the Bus Editor using one of these approaches:

- In the Simulink Editor, select **Edit > Bus Editor**.
- At the MATLAB command line, enter `buseditor`.
- In the Model Explorer, in a bus object dialog box, click the **Launch Bus Editor** button.

### Create Bus Objects

Suppose that your model has two buses, with one bus nested inside the other bus.

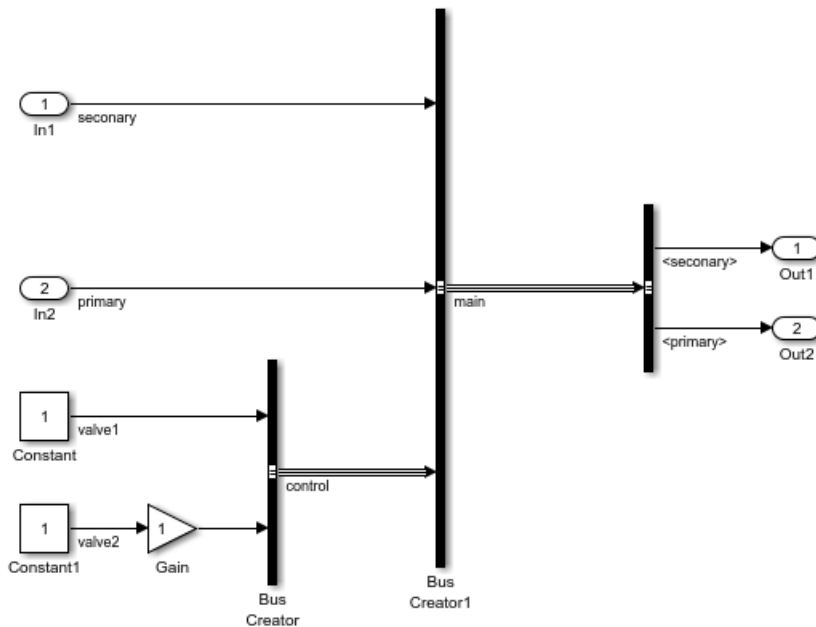

This example shows how to create bus objects corresponding to the `control` and `main` bus signals. To complete the definition of the bus objects and use those objects, also perform the steps in these examples:

- “Create Bus Elements for the Bus Object” on page 63-65
- “Nest Bus Object Definitions” on page 63-68
- “Use the Bus Objects in the Model” on page 63-71

- 1 Open the model.
- 2 In the Simulink Editor, select **Edit > Bus Editor**.
- 3 In the Bus Editor, select **File > Add Bus**.

This action creates a bus object with a default name and properties. The object appears in the **Hierarchy** pane and its properties appear in the **Dialog** pane.

- 4 Specify the name for the bus object, using the **Name** property. To make it easier to see how the bus object is used in a model, use a name that reflects the bus signal

associated with the bus object. The bus signal that combines the valve inputs is named `control`, therefore, name the bus object `CONTROL`.

- 5 You can provide documentation about the bus object by using the **Description** property. Enter `Combines two valve signals`.
- 6 Click **Apply**.
- 7 Create the second bus object. In the **Hierarchy** pane, select the `CONTROL` bus object and in the toolbar select the **Add Bus** button ()
- 8 In the **Dialog** pane, set **Name** to `MAIN` and **Description** to `Defines a bus object for a bus that contains three signals, including the control bus signal`.
- 9 Click **Apply**.

The **Hierarchy** pane displays bus objects in alphabetical order.

Do not close MATLAB without exporting the bus objects to a MATLAB code file or MAT-file. Otherwise, you lose the bus object definitions.

To define bus element objects for the bus objects, perform the steps in “Create Bus Elements for the Bus Object” on page 63-65.

## Create Bus Elements for the Bus Object

This example builds on bus objects that you created in “Create Bus Objects” on page 63-63. The example shows how to define the bus element objects for the `CONTROL` and `MAIN` bus objects for the model.

---

**Note:** In this example, the name for the bus element and the corresponding signals are different, to try to highlight that they are distinct entities. If you change the default value for the **Element name mismatch** diagnostic to error, then the signal name and corresponding bus element name must match exactly to run on all platforms.

Also, the Bus Creator blocks in this model use the default setting for the **Override bus signal names from inputs** block parameter. The default setting of `ON` propagates the signal names of the signals in model, not of the names of the bus elements in the bus object.

---

To complete the definition of the bus objects and use those objects, also perform the steps in these examples:

- “Nest Bus Object Definitions” on page 63-68
- “Use the Bus Objects in the Model” on page 63-71

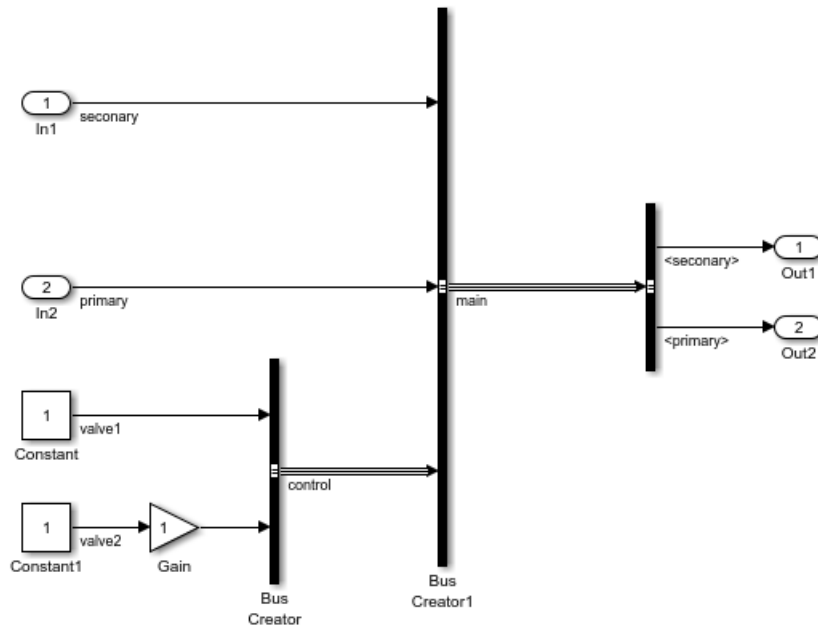

- 1 In the Bus Editor **Hierarchy** pane, select the CONTROL bus object.
- 2 Select **File > Add/Insert BusElement**.

A new bus element with a default name and properties is created in the CONTROL bus object. The bus element appears in the **Hierarchy** pane below the CONTROL bus object.

- 3 In the **Dialog** pane, set **Name** to VALVE1, to reflect the name of the top signal in the bus.
- 4 For the **Constant** block, open the Block Parameters dialog box and select the **Signal Attributes** tab.

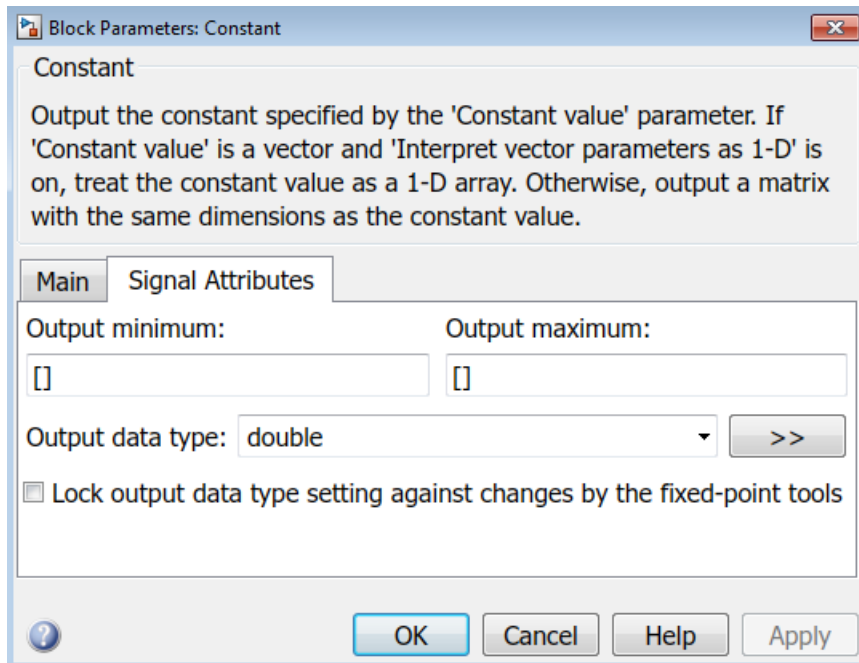

- 5 In the Bus Editor **Dialog** pane, set **DataType** property to **double**, to match the **Output data type** block parameter setting for the Constant block. Use the default setting for the other bus element object properties.
- 6 Click **Apply**.
- 7 Create a second bus element object that corresponds to the **valve2** bus element signal. In the **Hierarchy** pane, select the **VALVE1** bus element object and click the **Add/Insert Bus Element** button (  ).

Set the bus object name to **VALVE2**.

- 8 For the **Constant1** block, open Block Parameters dialog box and select the **Signal Attributes** tab.

The **Output data type** is **int8**.

- 9 In the Bus Editor **Dialog** pane, for the **VALVE2** bus element object, set **DataType** property to **int8**. Use the default setting for the other bus element object properties.
- 10 Click **Apply**.

- 11 Create a bus element object for the **secondary** bus element signal of the **main** bus. In the **Hierarchy** pane, select the **MAIN** bus object and click the **Add/Insert Bus Element** button.
- 12 Set the **Name** property to **SECONDARY** and the **Data type** property to **int32**, matching the **In1** block output signal data type. Click **Apply**.
- 13 Create a bus element object for the **primary** bus element signal of the **main** bus. In the **Hierarchy** pane, select the **SECONDARY** bus element object and click the **Add/Insert Bus Element** button.
- 14 Set the **Name** property to **PRIMARY** and the **Data type** property to **boolean**, matching the **In2** block output signal data type. Click **Apply**.

To define a bus element object for the control bus, which is the third bus element of the main bus, perform the steps in “Nest Bus Object Definitions” on page 63-68.

## Nest Bus Object Definitions

Any signal in a bus can be another bus, which can in turn contain subordinate buses, to any depth. Describing nested buses with bus objects requires nesting the bus object definitions that the objects provide.

Every bus object defines a data type whose properties are specified by the object. To nest one bus object definition in another, assign to a bus element of one bus object a data type that is defined by another bus object. The bus element object represents a nested bus. The bus object that specifies the data type of the bus element object defines the nested bus elements.

A data type defined by a bus object is called a *bus type*. Nesting buses by assigning bus types to elements allows the same bus definition to be used conveniently in multiple contexts without unwanted interactions.

This example builds on the bus objects and bus elements that you created for the model in “Create Bus Objects” on page 63-63 and “Create Bus Elements for the Bus Object” on page 63-65.



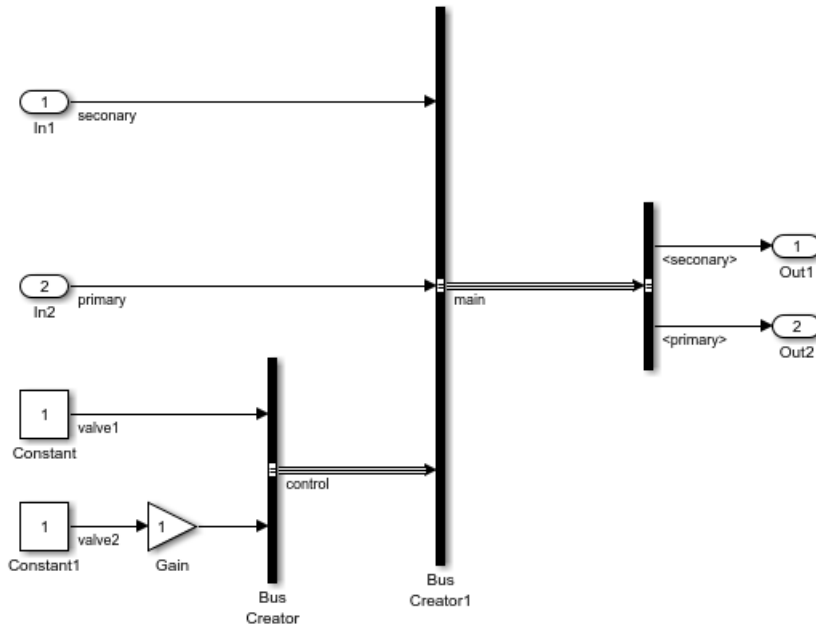

- 1 In the Bus Editor **Hierarchy** pane, select the PRIMARY bus element object and click the **Add/Insert Bus Element** button.
- 2 In the **Dialog** pane, set the **Name** property to VALVES\_BUS.
- 3 For the **Data type** property, use the Bus: <object name> template, replacing <object name> with CONTROL, which is the name of the bus object for the control bus.
- 4 Click **Apply**.

If you expand the VALVES\_BUS bus element object, you see the two bus element objects for the CONTROL bus object, VALVE1 and VALVE2.

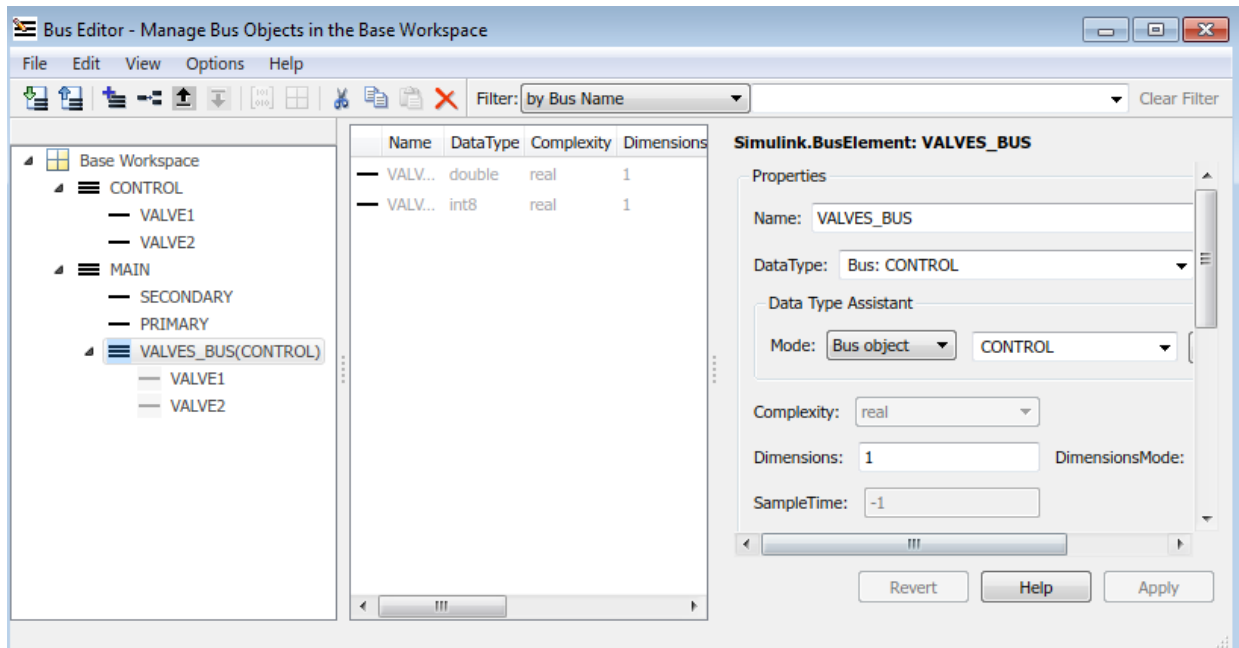

- 5 You have finished defining bus objects for this example. Consider exporting the bus objects to a MATLAB code file. In the Bus Editor, select **File > Export to File**. In the Export dialog box, specify a file name for the bus object MAT-file.

To use the bus objects to create nonvirtual buses, perform the steps in “Use the Bus Objects in the Model” on page 63-71.

### Avoid Circular Nested Bus Object Definitions

You can nest a bus object in as many different bus objects as desired, and as many times in the same bus object as desired. You can nest bus objects to any depth, but you cannot define a circular structure by directly or indirectly nesting a bus object within itself.

If you define a circular structure, the Bus Editor posts a warning and sets the data type of the element that would have completed the cycle to **double**. Click **OK** to close the warning and continue using the editor.

## Use the Bus Objects in the Model

The buses in the `ex_bus_object_tutorial` model that you defined in the “Create Bus Objects” on page 63-63 example and its associated examples are virtual buses. To use the bus objects you defined in those examples to change the virtual buses to nonvirtual buses:

- 1 Open the Bus Creator block parameters dialog box. Set **Output data type** to **Bus: CONTROL** and select **Output as nonvirtual bus**.

---

**Note:** You can use a bus object to specify the data type for a block without specifying that the bus is a nonvirtual bus. You must specify a bus object for a nonvirtual bus, but it is optional for a virtual bus.

---

- 2 Open the `Bus_Creator1` Block Parameters dialog box. Set **Output data type** to **Bus: MAIN** and select **Output as nonvirtual bus**.
- 3 Add another `Outport` block after the `Bus_Creator1` block and connect it to the `main` signal.
- 4 Open the `Out3` Block Parameters dialog box. In the **Signal Attributes** tab, set the **Data type** to **Bus: MAIN** and select **Output as nonvirtual bus in parent model**.

The model uses the bus objects that you defined. When you simulate the model, you see that the buses are now nonvirtual.

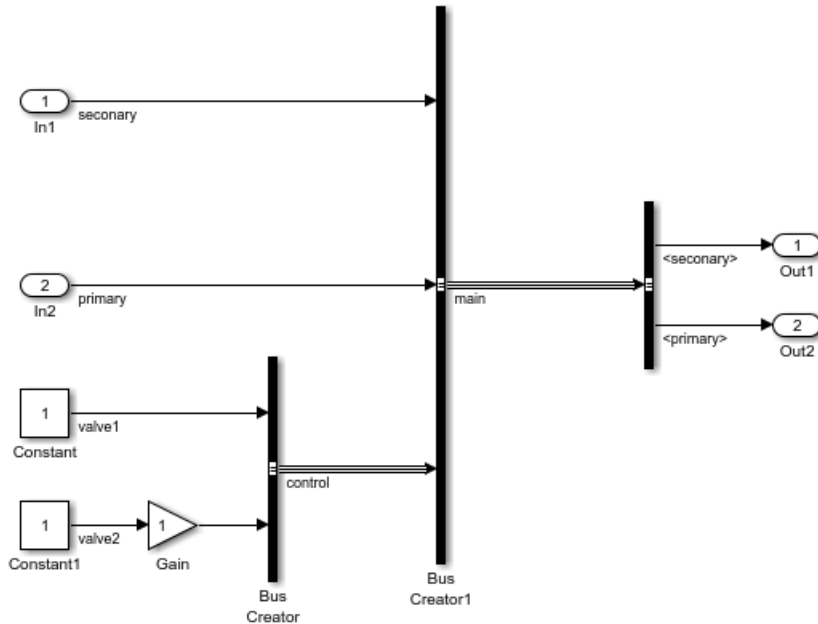

## See Also

### Blocks

Bus Creator

### Classes

Simulink.Bus | Simulink.BusElement

## Related Examples

- “When to Use Bus Objects” on page 63-59
- “Create Bus Objects Programmatically” on page 63-73
- “Modify Bus Objects” on page 63-76
- “Save and Import Bus Objects” on page 63-82
- “Map Bus Objects to Models” on page 63-88

## Create Bus Objects Programmatically

To create a bus object and its bus elements programmatically, use one of these approaches:

- “Create Simulink.Bus and Simulink.BusElement Objects Directly” on page 63-73 — Construct a `Simulink.Bus` object and define its properties. Construct `Simulink.BusElement` objects for the elements of the bus.
- “Create Bus Objects from Blocks” on page 63-74 — Create a bus object and its bus element objects based on a block in a model.
- “Create Bus Objects from MATLAB Data” on page 63-74 — Create a bus object and its bus elements based on a MATLAB structure or cell array.
- “Create Bus Objects from External C Code” on page 63-87 — Create a bus object and its bus elements based on your external C code (`struct`). Use the `Simulink.importExternalTypes` function.

As you create bus objects programmatically, you can store them in either the MATLAB workspace or in a MATLAB code file. After you create a bus object, you can use MATLAB commands to save the bus objects to a MAT-file (see “Save and Load Workspace Variables” (MATLAB)). To simulate a block that uses a bus object, that bus object must be in the base workspace or in a data dictionary.

You can specify the bus object to be the data type of a block either before or after defining the bus object. However, before you simulate the model, the bus object and the corresponding bus signal must have the same number of bus elements, in the same order. Also, each bus element in the bus object and in the corresponding bus element signal must have the same data type and dimensions.

During model development, you can modify bus signals to match bus objects or modify bus objects to match buses.

### Create Simulink.Bus and Simulink.BusElement Objects Directly

You can create a `Simulink.Bus` object and its `Simulink.BusElement` objects programmatically. The bus objects are stored in the base workspace. For each bus element object, specify the name, dimensions, and data type. The other bus element object properties are optional. For the bus object, specify the bus elements. The other bus object properties are optional. For example, this code creates two bus element objects that are then used as the elements of the `CONTROL` bus object.

```
clear elems;
elems(1) = Simulink.BusElement;
elems(1).Name = 'VALVE1';
elems(1).Dimensions = 1;
elems(1).DimensionsMode = 'Fixed';
elems(1).DataType = 'double';
elems(1).SampleTime = -1;
elems(1).Complexity = 'real';

elems(2) = Simulink.BusElement;
elems(2).Name = 'VALVE2';
elems(2).Dimensions = 1;
elems(2).DimensionsMode = 'Fixed';
elems(2).DataType = 'double';
elems(2).SampleTime = -1;
elems(2).Complexity = 'real';

CONTROL = Simulink.Bus;
CONTROL.Elements = elems;
```

This script is similar to the file you get if you save a bus object to a MATLAB file and choose the **Object** format. For information about saving bus objects, see “Save and Import Bus Objects” on page 63-82.

## Create Bus Objects from Blocks

You can create a bus object and its bus elements programmatically based on a block in a model. Use the `Simulink.Bus.createObject` function and specify the model and blocks for which to create bus objects for. Before you use the function, the model must be compilable. For example, if you specify a Bus Creator block that is at the highest level of a nested bus hierarchy, the function creates bus objects for all of the buses in the hierarchy. You can specify to have the bus objects created in the base workspace or to save them in a MATLAB code file.

## Create Bus Objects from MATLAB Data

You can create a bus object from cell arrays of bus information in MATLAB, using the `Simulink.Bus.cellToObject` function. Each cell subordinate cell array represents a bus object and includes the following data, reflecting `Simulink.Bus` object properties:

```
{BusName,HeaderFile,Description,DataScope,Alignment,Elements}
```

The `Elements` field is a cell array defining these properties for each `Simulink.BusElement` object:

```
{ElementName,Dimensions,DataType,SampleTime,Complexity,DimensionsMode,Min,Max,Units,Des
```

You can create a bus object from a MATLAB structure of `timeseries` objects, using the `Simulink.Bus.createObject` function. Alternatively, you can specify a numeric MATLAB structure. You can specify to have the bus objects created in the base workspace or to save them in a MATLAB code file.

## See Also

### Functions

`Simulink.Bus.cellToObject` | `Simulink.Bus.createObject`

### Classes

`Simulink.Bus` | `Simulink.BusElement`

## Related Examples

- “When to Use Bus Objects” on page 63-59
- “Create Bus Objects with the Bus Editor” on page 63-63
- “Save and Import Bus Objects” on page 63-82
- “Modify Bus Objects” on page 63-76
- “Map Bus Objects to Models” on page 63-88

## Modify Bus Objects

**In this section...**

“Edit Bus Objects” on page 63-77

“Edit Bus Element Objects” on page 63-77

“Copy and Paste Bus Objects and Elements” on page 63-77

“Change the Order of Bus Elements” on page 63-77

“Delete Bus Objects and Bus Elements” on page 63-78

“Filter Displayed Bus Objects” on page 63-78

Modify a bus object or its bus element objects if you change the associated bus signal to:

- Add or delete a bus element signal.
- Reorder bus element signals.
- Change the data type or dimensions of a bus element signal.

If you modify a bus object to reflect changes to a bus signal, confirm that the bus object continues to work in other places it is used. To find where a bus object is used in a model, see “Finding Blocks That Use a Specific Variable” on page 57-95.

If you do not want to change the bus object, you can:

- Create a bus object that matches the changes to the bus signal and use the new bus object for the blocks that the changed bus connects to.
- Revert the bus signal changes so that the bus signal continues to match the associated bus object.

You can use the Bus Editor to change and delete existing bus objects and bus elements. The Bus Editor displays all the bus objects in the base workspace. Changes that create, reorder, or delete entities take effect immediately in the base workspace. Changes to properties take effect when you apply them. The Bus Editor does not provide an undo capability.

If you have saved a bus object in a MATLAB code file, you can edit it programmatically. For details, see “Create Simulink.Bus and Simulink.BusElement Objects Directly” on page 63-73.



## Edit Bus Objects

- 1 Open the Bus Editor.
- 2 In the **Hierarchy** pane, expand **Base Workspace** (if necessary) and select the bus object to edit.

---

**Tip:** If the base workspace contains many bus objects, you can reduce the number of displayed bus objects by using a Bus Editor filter. For details, see “Filter Displayed Bus Objects” on page 63-78.

---

- 3 In the **Dialog** pane, edit the bus object properties.
- 4 Click **Apply**.

## Edit Bus Element Objects

- 1 Open the Bus Editor.
- 2 In the **Hierarchy** pane, expand **Base Workspace** (if necessary) and select the bus object whose bus element object you want to modify.
- 3 In the **Contents** pane, select the bus element whose properties you want to edit. You can make the edits in the **Dialog** pane or in the **Contents** pane. To make the same edit to a property in multiple bus elements, use the **Contents** pane. Hold the **Ctrl** key while you select multiple bus elements and enter the new value in the property for one of the selected bus elements. The change applies to all the selected bus elements.
- 4 If you made edits in the **Dialog** pane, click **Apply**.

## Copy and Paste Bus Objects and Elements

You can use the Bus Editor to copy and paste bus objects or bus element objects. Right-click an object and use the context menu to copy and paste the bus object. Copying a bus object also copies its bus elements. The copied objects have the same property values as the original objects. Change the name of the objects and modify other properties as necessary.

## Change the Order of Bus Elements

To change the order of bus elements in a bus object, in the **Hierarchy** pane, select a bus element and move it up or down in the list, using the **Move Element Up**



or the **Move Element Down**  button.

## Delete Bus Objects and Bus Elements

To delete a bus object, in the **Hierarchy** pane, select the bus object and click the **Delete**



button or **Delete** key. Deleting a bus object deletes its bus element objects.

If you delete a bus object, in the Simulink Editor, update any blocks that use that bus object. To find where a bus object is used in a model, see “Finding Blocks That Use a Specific Variable” on page 57-95.

## Filter Displayed Bus Objects

By default, the Bus Editor displays all bus objects that exist in the base workspace, in alphabetical order. When there are many bus objects, you can have the Bus Editor display only those bus objects that have:

- Names that match a given search term or regular expression
- A specified relationship to a specified bus object

To set a filter, specify values in the **Filter** boxes to the right of the tools in the toolbar. Depending on the specified type of filtering, one or two boxes appear to the right of the **Filter Type** box. In this example, the Bus Editor displays the bus objects that are in the base workspace:

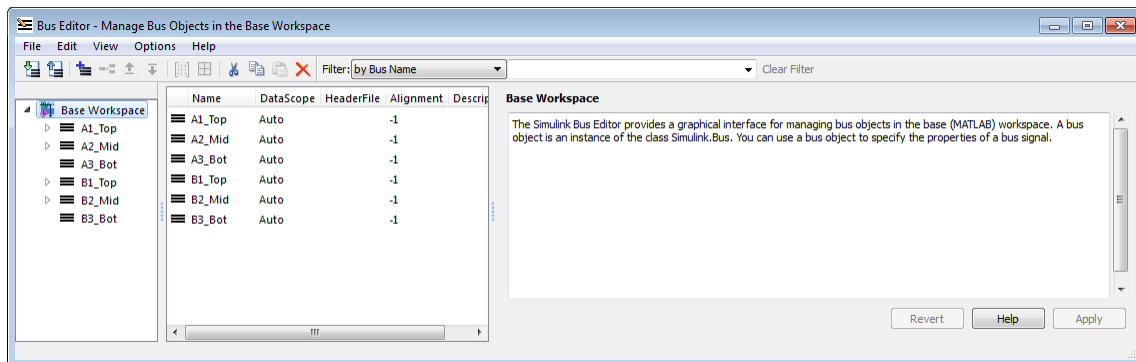

The bus objects shown form two disjoint hierarchies. **A1\_Top** is the parent of **A2\_Mid**, which is the parent of **A3\_Bot**. Similarly, **B1\_Top** > **B2\_Mid** > **B3\_Bot**.

### Filter by Name

Set **Filter Type** to **by Bus Name** and in **Object Name**, enter a character vector. See “Regular Expressions” (MATLAB) for complete information about MATLAB regular expression syntax. As you type, the Bus Editor updates dynamically to show only the bus objects whose names match the expression that you have typed. The comparison is case-sensitive. For example, entering **A** displays:

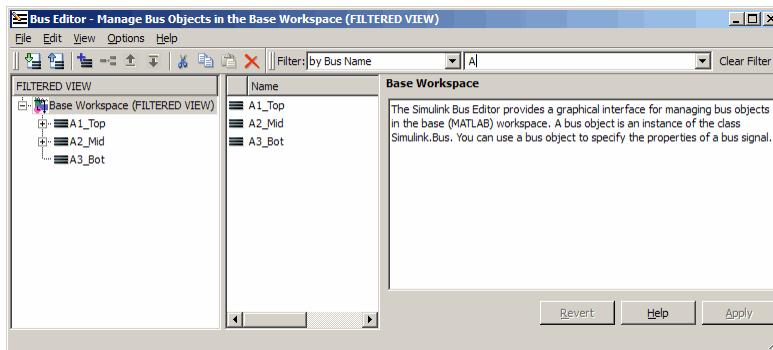

### Filter by Relationship

Set **Filter Type** box to **by Bus Object Dependency**. In the **Relationship** box, select the type of relationship to display:

- **Bus Object and Parents** — Show a specified bus object and all superior bus objects in the hierarchy (default).
- **Bus Object and Dependents** — Show a specified bus object and all subordinate bus objects in the hierarchy.
- **Bus Object and Related Objects** — Show a specified bus object and all superior and subordinate bus objects.

In **Object Name**, specify a bus object by name, using a character vector. Use the list to select any existing bus object name, or type a name. As you type, the editor:

- Dynamically completes the field to indicate the first bus object that alphabetically matches what you have typed

- Updates the display panes to show only the specified object and any objects that have the specified relationship to it

For example, assuming that `A1_Top` is the parent of `A2_Mid`, which is the parent of `A3_Bot`, if you enter `B2`, the Bus Editor displays for **Bus Object and Dependents**:

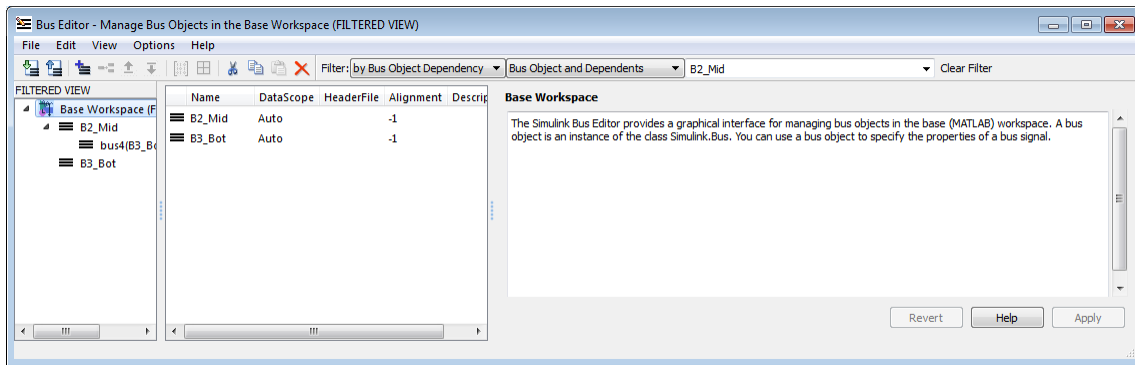

## Change Filtered Objects

You can work with any bus object that is visible in a filtered display exactly as in an unfiltered display. If you change the name or dependency of an object so that it no longer passes the current filter, the object disappears from the display. Conversely, if some activity outside the Bus Editor changes a filtered object so that it passes the current filter, the object immediately becomes visible.

If you create a bus object but do not see it in the editor, check the filter. The new object (whose name always begins with `BusObject`) can exist but be invisible. Bus objects created or imported from outside the Bus Editor are not visible until you reopen the Bus Editor, regardless of whether a filter is in effect.

Operations performed in the **Hierarchy** pane on the **Base Workspace** affect only visible objects. An object that is invisible because a filter is being used is unaffected by the operation. To act on all existing bus objects, clear the filter by clicking **Clear Filter**.

## See Also

### Classes

Simulink.Bus | Simulink.BusElement

## **Related Examples**

- “Create Bus Objects with the Bus Editor” on page 63-63
- “Create Bus Objects Programmatically” on page 63-73
- “Save and Import Bus Objects” on page 63-82
- “Map Bus Objects to Models” on page 63-88
- “When to Use Bus Objects” on page 63-59

## Save and Import Bus Objects

### In this section...

“Locations for Saving Bus Objects” on page 63-83

“Data Dictionary” on page 63-84

“MATLAB Code File” on page 63-84

“MAT-File” on page 63-85

“Database or Other External Files” on page 63-87

When you create bus objects in the base workspace, before you close MATLAB, save (export) the bus objects to one of these locations:

- Data dictionary
- MATLAB code file
- MAT-file
- Database or other external files

If you do not save the bus objects, then when you reopen the model that uses the bus objects, you need to recreate the bus objects.

The technique you use for creating a bus object determines where the bus object is stored initially.

Bus Creation Technique	Initial Storage Location
Bus Editor	Base workspace
<code>Simulink.Bus</code> and <code>Simulink.BusElement</code> object definition	Base workspace
<code>Simulink.Bus.cellToObject</code>	Base workspace
<code>Simulink.createObject</code>	Base workspace or MATLAB code file

When you save bus objects using the Bus Editor, you can save them in a MAT-file or MATLAB code file. When you save bus objects using the `Simulink.Bus.save` or `matlab.io.saveVariablesToScript` function, the bus objects in the base workspace

are saved in a MATLAB code file in object form. You can use any MATLAB technique that saves the contents of the base workspace. However, the resulting file contains everything in the base workspace, not just bus objects.

---

**Tip:** You can configure the Bus Editor so that closing it posts a reminder to save bus objects. To enable the reminder, select **Options > Always Warn Before Closing**. When you select this option and try to close the Bus Editor, a reminder appears about saving bus objects before closing. You can disable the reminder by clearing **Options > Always Warn Before Closing**.

---

You can customize bus object export and import by providing a custom function that writes to or reads from a location outside MATLAB. For example, the exported bus objects could be saved as records in a corporate database. See “Customize Bus Object Import and Export” on page 63-90 for details.

When you import and modify bus objects, resave them and possibly modify the mechanism (such as a model callback) that you use for importing them.

## Locations for Saving Bus Objects

Before you choose where to save bus objects, consider how you want to associate bus objects with models. For more information, see “Map Bus Objects to Models” on page 63-88.

Location	Usage Considerations
Data dictionary	Use for large model componentization.  When you save to a data dictionary from the base workspace, you get all the variables used by the model, not just the bus objects.  Before you save to a data dictionary, read “Considerations before Migrating to Data Dictionary” on page 61-9.
MATLAB code file	Use for when you want to use MATLAB for traceability and model differencing.
MAT-file	Use for faster bus object saving and loading.

Location	Usage Considerations
Database or other external files	Use for comparing bus interface information with design documents stored in an external data source.

## Data Dictionary

### Save Bus Objects

To save bus objects (and other base workspace variables used by the model) to a data dictionary:

- 1 Link the model to a data dictionary, using the **Model Properties** dialog box.
- 2 Create a data dictionary.
- 3 Migrate data from the base workspace to the data dictionary.

For an example showing the complete procedure, see “Migrate Single Model to Use Dictionary” on page 61-6.

## MATLAB Code File

### Save Bus Objects

To use the Bus Editor to export all bus objects from the base workspace to a MATLAB code file:

- 1 In the Bus Editor, choose **File > Export to File**.
- 2 In the Export dialog box, specify the name for the export file. You do not have to specify a file extension.
- 3 Set **Save as type** to **MATLAB files (\*.m)**.
- 4 Click **Save**.
- 5 In the dialog box that appears, select the format:
  - **Cell** — Stores the bus objects in a compressed format.
  - **Object** — Store the bus objects in `Simulink.Bus` object format, which is easier to read and edit.

All the bus objects that are in the base workspace, and nothing else, are exported to the specified MATLAB code file.



---

**Note:** Operations performed on the **Base Workspace** in the **Hierarchy** pane, such as exporting bus objects, affect only visible objects. An object that is invisible because a filter is being used is unaffected by the operation. To export all existing bus objects, before performing the export, clear any filter that is in use.

---

To export only selected bus objects from the base workspace to a file:

- 1 In the Bus Editor **Contents** pane, select one or more bus objects and right-click.
- 2 To export only the selected bus objects, in the context menu, select **Export to File**. To include nested bus objects used by the selected objects, select **Export with Dependent Bus Objects to File**.
- 3 Use the Export dialog box to export the selected bus objects.

When you create bus objects using `Simulink.Bus.createObject`, you can specify a MATLAB code file to store the bus objects. If you store the bus objects in a file, by default the objects are stored in cell format, which is a compressed format. To store the objects in a more readable format, use `'object'` as the last argument, after the file name. For example:

```
Simulink.Bus.createObject('busdemo','busdemo/Bus Creator2',...  
'bus_objs','object'),
```

### Import Bus Objects

You can use a model callback, using the `load` function, to load the MATLAB code file.

If a model uses only a few bus objects, consider copying the bus object code directly into the callback, instead of loading a file. For an example, open the model and examine the callback.

You can use the Bus Editor to import the definitions from a MAT-file to the base workspace. The import loads the complete contents of the file, not just the bus objects.

- 1 Choose **File > Import into Base Workspace**.
- 2 Use the Open File dialog box to navigate to and import the desired file.

## MAT-File

### Save Bus Objects

To export all bus objects from the base workspace to a MAT-file using the Bus Editor:

- 1 In the Bus Editor, choose **File > Export to File**.
- 2 In the Export dialog box, specify the name for the export file. You do not have to specify a file extension.
- 3 Set **Save as type** to **MAT-files (\*.mat)**.
- 4 Click **Save**.

All bus objects in the base workspace, and nothing else, are exported to the specified MAT-file.

---

**Note:** Operations performed on the **Base Workspace** in the **Hierarchy** pane, such as exporting bus objects, affect only visible objects. An object that is invisible because a filter is in use is unaffected by the operation. To export all existing bus objects, before performing the export, clear any filter that is in effect.

---

To export only selected bus objects from the base workspace to a file:

- 1 In the Bus Editor **Contents** pane, select one or more bus objects and right-click.
- 2 To export only the selected bus objects, in the context menu select **Export to File**. To export any nested bus objects used by the selected objects, select **Export with Dependent Bus Objects to File**.
- 3 Use the Export dialog box to export the selected bus objects.

When you create bus objects using `Simulink.Bus.createObject` or `Simulink.Bus.cellToObject`, you can save the bus objects as a MATLAB code file. When you use the `Simulink.saveVars` function to save variables from the base workspace, the objects are saved in a MATLAB code file.

### Import Bus Objects

You can use a model callback, using the `load` function to load the MAT-file.

You can use the Bus Editor to import the definitions from a MAT-file to the base workspace. Importing the file loads the complete contents of the file, not just the bus objects.

- 1 Choose **File > Import into Base Workspace**.
- 2 Use the Open File dialog box to navigate to and import the desired file.

## Database or Other External Files

### Save Bus Objects

You can capture bus interface information in a database or other external source, and use scripts and Database Toolbox™ functionality to read that information into MATLAB.

### Import Bus Objects

You can use `sl_customization.m` to customize the Bus Editor to import bus data from a database or other external source. For details, see “Customize Bus Object Import and Export” on page 63-90.

### Create Bus Objects from External C Code

You can create a bus object that corresponds to a structure type (`struct`) that your existing C code defines. Then, in preparation for integrating existing algorithmic C code for simulation (for example, by using the Legacy Code Tool), you can use the bus object to package signal or parameter data according to the structure type. To create the object, use the `Simulink.importExternalCTypes` function.

## See Also

### Functions

`Simulink.Bus.cellToObject` | `Simulink.Bus.createObject` | `Simulink.saveVars`

### Classes

`Simulink.Bus` | `Simulink.BusElement`

## Related Examples

- “Map Bus Objects to Models” on page 63-88
- “Customize Bus Object Import and Export” on page 63-90
- “Create Bus Objects with the Bus Editor” on page 63-63
- “Create Bus Objects Programmatically” on page 63-73
- “Migrate Models to Use Simulink Data Dictionary” on page 61-6

## Map Bus Objects to Models

As models become complex, it is important to identify the bus objects that a model uses and the models that use a specific bus object.

Before you simulate a model, all the bus objects it uses must be loaded into the base workspace. For automation and consistency across models, it is important to map bus objects to models.

- By identifying all of the bus objects a model needs, you can ensure that those objects are loaded before model execution.
- By identifying all models that use a bus object, you can ensure that changes to a bus object do not cause unexpected changes in any of the models that use that bus object.

To map bus objects to models, consider:

- Including the bus objects in a data dictionary. You can link the data dictionary to one or more models. For details, see “Migrate Single Model to Use Dictionary” on page 61-6.
- Using Simulink Projects:
  - 1 Serialize the files that contain the bus objects as part of a project.
  - 2 Loading that data upon project open.

For details, see “Project Management”.

- Capturing the mapping information in an external data source, such as a database.

To find where a bus object is used in an open model, see “Finding Blocks That Use a Specific Variable” on page 57-95.

## Use a Rigorous Naming Convention

Using a rigorous and standard naming convention is very helpful for mapping bus object usage. For example, consider the model and data required for an actuator control function. Naming the model `Actuator` and the input and output ports `Actuator_bus_in` and `Actuator_bus_out`, respectively, makes the connection between the bus objects and the model clear.

Note that this approach can cause issues if the output from one model reference is fed directly to another model reference. In this case, the naming mismatch results in an error.

## **Related Examples**

- “Save and Import Bus Objects” on page 63-82

## Customize Bus Object Import and Export

### In this section...

“Required Background Knowledge” on page 63-90

“Write a Bus Object Export Function” on page 63-91

“Write a Bus Object Import Function” on page 63-91

“Register Customizations” on page 63-92

“Change Customizations” on page 63-93

You can use the Bus Editor to import bus objects to the base workspace and to export bus objects from the base workspace, as described in “Save and Import Bus Objects” on page 63-82. By default, the Bus Editor can save bus objects to, and import bus objects from, a MATLAB code file or MAT-file. The files must be in a location that is accessible using an ordinary **Open** or **Save** dialog box.

You can write customized MATLAB functions that provide alternative import or export (or both) functionality. For example, you can write a customized function that stores the objects as records in a database, in a format that your organization uses.

After you design and implement a custom bus object import or export function, use the Simulink Customization Manager to register the function. The registration process establishes custom import and export functions as callbacks for the Bus Editor **Import to Base Workspace** and **Export to File** commands. The callbacks replace the default capabilities of the Bus Editor. Customizing the Bus Editor import and export capabilities has no effect on other MATLAB or Simulink functions. Canceling import or export customization restores the default Bus Editor capabilities for that operation without affecting the other.

To create bus objects from external C code, you do not need to make customizations. See “Create Bus Objects from External C Code” on page 63-87.

### Required Background Knowledge

Customizing bus object import or export requires that you understand:

- MATLAB language and programming techniques
- Simulink bus object syntax
- The proprietary format into which you translate bus objects, and the techniques necessary to access the facility that stores the objects.

- Any platform-specific techniques for obtaining data from the user, such as the name of the location in which to store or access bus objects.

## Write a Bus Object Export Function

A custom bus object export function requires at least one argument. You can use additional arguments to handle special actions by the function. The value of the first argument is a cell array containing the names of all bus objects that the Bus Editor has selected. You can use functions, global variables, or any other MATLAB technique, to provide values for any additional arguments. The general algorithm of a customized export function is:

- 1 Iterate over the list of object names in the first argument.
- 2 Obtain the bus object corresponding to each name.
- 3 Translate the bus object to the proprietary syntax.
- 4 Save the translated bus object in the local repository.

This example shows the syntactic shell of such an export callback function is:

```
function myExportCallback(selectedBusObjects)
disp('Custom export was called!');
for idx = 1:length(selectedBusObjects)
    disp([selectedBusObjects{idx} ' was selected for export.']);
end
```

Although this function does not export any bus objects, it is syntactically valid and can be registered. It accepts a cell array of bus object names, iterates over them, and prints each name. An operational export function:

- Uses each name to retrieve the corresponding bus object from the base workspace
- Converts the object to proprietary format
- Stores the converted object

The additional logic is enterprise-specific.

## Write a Bus Object Import Function

A custom bus object import function can take zero or more arguments to perform its task. You can use functions, global variables, or any other MATLAB technique to provide argument values. Also, the function can poll the user for information, such as a

designation of where to obtain bus object information. The general algorithm of a custom bus object import function is:

- 1 Obtain bus object information from the local repository.
- 2 Translate each bus object definition to a `Simulink.Bus` object.
- 3 Save each bus object to the MATLAB base workspace.

This example shows the syntactic shell of an import callback function is:

```
function myImportCallback
disp('Custom import was called!');
```

Although this function does not import any bus objects, it is syntactically valid and can be registered with the Simulink Customization Manager. An operational import function:

- Gets a designation of where to obtain the bus objects to import
- Converts each bus object to a `Simulink.Bus` object
- Stores the object in the base workspace

The additional logic is enterprise-specific.

## Register Customizations

To customize bus object import or export, provide a customization registration function that inputs and configures the Customization Manager whenever you start Simulink software or refresh Simulink customizations. The steps for using a customization registration function are:

- 1 Create a file named `sl_customization.m` to contain the customization registration function. Alternatively, you can use an existing customization file.
- 2 At the top of the file, create a function named `sl_customization` that takes a single argument (or use the customization function in an existing file). When the function is invoked, the value of this argument is the Customization Manager.
- 3 Configure the `sl_customization` function to set `importCallbackFcn` and `exportCallbackFcn` to be function handles that specify your customized bus object import and export functions.
- 4 If `sl_customization.m` is a new customization file, put it anywhere on the MATLAB search path. Two frequently used locations are `matlabroot` and the current working folder. Alternatively, you can extend the search path.



Here is a simple example of a customization registration function:

```
function sl_customization(cm)
disp('My customization file was loaded. ');
cm.BusEditorCustomizer.importCallbackFcn = @myImportCallback;
cm.BusEditorCustomizer.exportCallbackFcn = @(x)myExportCallback(x);
```

When Simulink starts up, it traverses the MATLAB search path looking for files named `sl_customization.m`. Simulink loads each such file that it finds (not just the first file) and executes the `sl_customization` function at its top, establishing the customizations that the function specifies.

Executing the example customization function displays a message (which an actual function probably would not). The function establishes that the Bus Editor uses a function named `myImportCallback()` to import bus objects, and a function named `myExportCallback(x)` to export bus objects.

The function corresponding to a handle that appears in a callback registration can be undefined when the registration occurs. However, it must be defined when the Bus Editor calls the function. The same latitude and requirement applies to any functions or global variables used to provide the values of additional arguments.

Other functions can also exist in the `sl_customization.m` file. However, the Simulink software ignores files named `sl_customization.m`, except when it starts up or refreshes customizations. Any changes to functions in the customization file are ignored until one of those events occurs. By contrast, changes to other MATLAB code files on the MATLAB path take effect immediately.

For more information, see “Registering Customizations” on page 65-26.

## Change Customizations

You can change the handles established in the `sl_customization` function by:

- Changing the function to specify the changed handles
- Saving the function
- Refreshing customizations by executing `sl_refresh_customizations`

Simulink traverses the MATLAB path and reloads all `sl_customization.m` files that it finds, executing the first function in each one, just as it did on Simulink startup.

You can revert to default import or export behavior by setting in the `sl_customization` function the appropriate `BusEditorCustomizer` element to `[]` and then refreshing customizations. Alternatively, you can eliminate both customizations in one operation by executing:

```
cm.BusEditorCustomizer.clear
```

where `cm` was previously set to a customization manager object (see “Register Customizations” on page 63-92).

Changes to the import and export callback functions themselves, as distinct from changes to the handles that register them as customizations, take effect immediately, unless they are in the `sl_customization.m` file itself. If the callback functions are in the `sl_customization.m` file, they take effect next time you refresh customizations. Keeping the callback functions in separate files usually provides more flexible and modular results.

## See Also

### Blocks

Bus Creator

### Functions

`Simulink.BlockDiagram.addBusToVector` | `Simulink.Bus.cellToObject`  
| `Simulink.Bus.createMATLABStruct` | `Simulink.Bus.createObject` |  
`Simulink.Bus.objectToCell` | `Simulink.Bus.save`

### Classes

`Simulink.Bus` | `Simulink.BusElement`

## Related Examples

- “Simulink Environment Customization”
- “Register Customizations” on page 63-92
- “Save and Import Bus Objects” on page 63-82

## Use Buses for Inports and Outports

### In this section...

“Use Buses with Root-Level Inports” on page 63-95

“Use Buses with Root-Level Outports” on page 63-95

“Buses for Atomic Subsystem Nonvirtual Inports” on page 63-96

“Buses with Model Referencing” on page 63-98

For information about using buses as inputs to, or outputs from, a referenced model, see “Bus Data Crossing Model Reference Boundaries” on page 63-142.

### Use Buses with Root-Level Inports

To have a root-level Inport block in a model that does not specify a bus object produce a bus signal, in the Inport block:

- Set the **Data type** parameter to **Bus: <object name>**
- Replace **<object name>** with the name of the bus object name that defines the bus that the Inport produces.

For more information, see “Import Bus Data to Top-Level Input Ports” on page 59-166.

### Use Buses with Root-Level Outports

A root level Outport of a model can accept a virtual bus only if all elements of the bus have the same data type. The Outport block automatically unifies the bus to a vector having the same number of elements as the bus, and outputs that vector.

To have a root-level Outport of a model accept a bus signal that contains mixed data types, use the Block Parameters dialog box of the Outport block.

- Set **Data type** to **Bus: <object name>**.
- Replace **<object name>** with the name of the bus object name that defines the bus that the Outport produces.

If the bus signal in a top-level model in a model reference hierarchy is virtual, the signal is converted to nonvirtual (see “Bus Conversion” on page 63-145).

## Buses for Atomic Subsystem Nonvirtual Inports

By default, an Inport block is a virtual block and accepts a bus as input. However, an Inport block is nonvirtual if:

- The Inport block is in an atomic subsystem.
- The signal or any of its elements (if the signal is a bus) are directly connected to the output of the subsystem.

The Inport block can accept a bus when either of these conditions is true:

- All elements of the bus can be converted to a vector (for example, all the elements must have the same data type).
- The bus is a nonvirtual bus.

If the bus elements have different data types, attempting to simulate the model halts the simulation and produces an error message. To avoid this problem without changing the semantics of your model, insert a Signal Conversion block between the Inport block and the Output block to which it was originally connected.

For example, the following model, which includes an atomic subsystem, does not simulate.

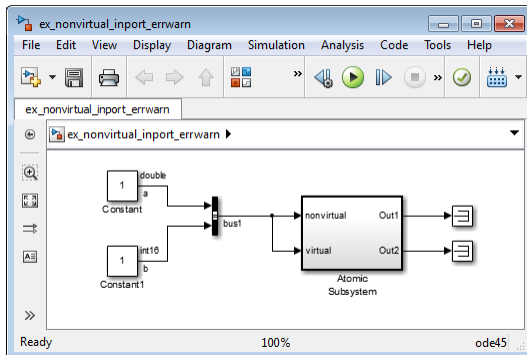

Starting the simulation generates the following error messages:

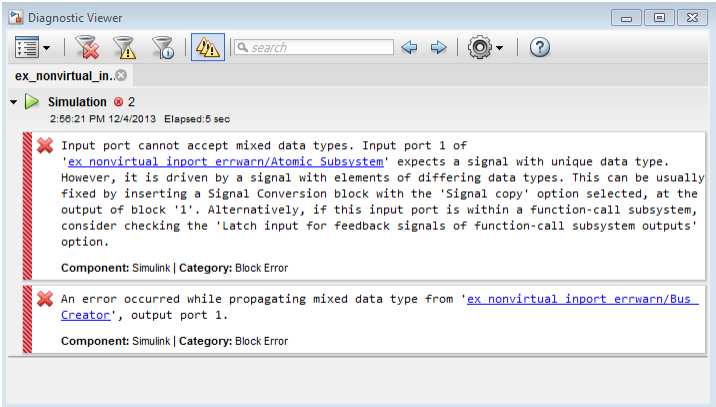

In the subsystem, the Inport block labeled `nonvirtual` is nonvirtual because it resides in an atomic subsystem and one of its bus elements (labeled `a`) is directly connected to one of the subsystem outputs. Further, the bus (`bus1`) connected to the subsystem inputs has elements of differing data types. As a result, you cannot simulate this model.

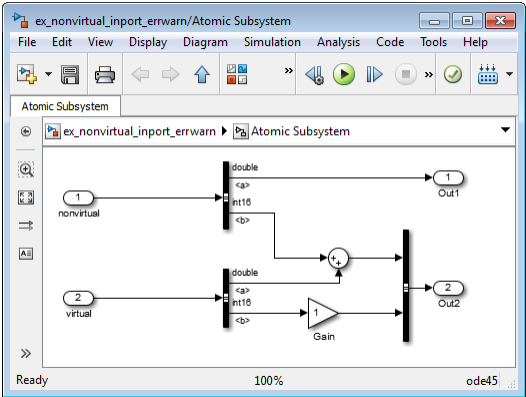

To break the direct connection to the subsystem output, insert a Signal Conversion block. Set the Signal Conversion block **Output** parameter to `Signal copy`. Inserting the Signal Conversion Diagram block enables you to simulate the model.

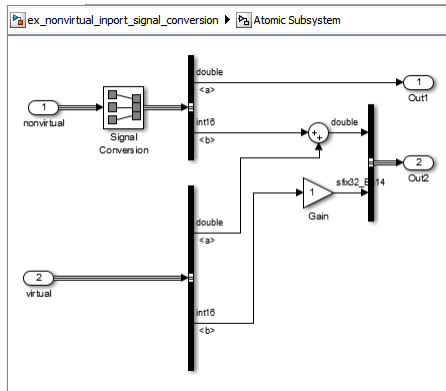

## Buses with Model Referencing

For information about using buses as inputs to, or outputs from, a referenced model, see “Bus Data Crossing Model Reference Boundaries” on page 63-142.

## See Also

### Blocks

Bus Creator | Inport | Outport | Signal Conversion

### Classes

Simulink.Bus

## Related Examples

- “Bus Conversion” on page 63-145
- “Import Bus Data to Top-Level Input Ports” on page 59-166
- “Bus Data Crossing Model Reference Boundaries” on page 63-142
- “Assign Signal Values to a Bus” on page 63-48
- “Specify Initial Conditions for Bus Signals” on page 63-99
- “When to Use Bus Objects” on page 63-59

## Specify Initial Conditions for Bus Signals

### In this section...

“Bus Signal Initialization” on page 63-99

“Create Initial Condition Structures” on page 63-100

“Initialize Bus Signals Using Block Parameters” on page 63-105

“Set Diagnostics to Support Bus Signal Initialization” on page 63-108

### Bus Signal Initialization

Bus signal initialization is a special form of signal initialization. For general information about initializing signals, see “Initialize Signals and Discrete States” on page 62-48.

Bus signal initialization specifies the bus element values that Simulink uses for the first execution of a block that uses that bus signal. By default, the initial value for a bus element is the ground value (represented by 0). Bus initialization involves specifying nonzero initial conditions (ICs).

You can use bus signal initialization features to:

- Specify initial conditions for signals that have different data types
- Apply a different initial condition for each signal in the bus
- Specify initial conditions for a subset of signals in a bus without specifying initial conditions for all the signals
- Use the same initial conditions for multiple blocks, signals, or models

You can initialize array of buses signals. For details, see “Initialize Arrays of Buses” on page 63-124.

### Initialize Bus Signals Using Initial Condition Structures

Setting up your model to use initial condition structures to initialize bus signals properly involves three main tasks. You can vary the order of the tasks.

Task	Documentation
Determine whether you can initialize the bus signal	<ul style="list-style-type: none"> <li>• “Blocks That Support Bus Signal Initialization” on page 63-100</li> <li>• “Buses with Variable-Size or Frame-Based Elements” on page 63-100</li> </ul>

Task	Documentation
Define an IC structure	“Create Initial Condition Structures” on page 63-100
Use an IC structure to specify a nonzero initial condition.	“Initialize Bus Signals Using Block Parameters” on page 63-105
Set Configuration Parameters dialog box diagnostics	“Set Diagnostics to Support Bus Signal Initialization” on page 63-108

### Blocks That Support Bus Signal Initialization

You can initialize bus signal values that input to a block if that block meets both of these conditions:

- It has an initial value or initial condition block parameter.
- It supports bus signals.

The following blocks support bus signal initialization:

- Data Store Memory
- Memory
- Merge
- Output (when the block is inside a conditionally executed context)
- Rate Transition
- Unit Delay

For example, the Unit Delay block is a bus-capable block and the Block Parameters dialog box for the Unit Delay block has an **Initial conditions** parameter.

### buses with Variable-Size or Frame-Based Elements

You cannot initialize a bus that has:

- Variable-size signals
- Frame-based signals

### Create Initial Condition Structures

You can create partial or full IC structures to represent initial values for a bus signal. Create an IC structure by either:



- Defining a MATLAB structure in the MATLAB base or Simulink model workspace
- Using the Block Parameters dialog box for a block that supports bus signal initialization to specify for the initial condition parameter an expression that evaluates to a structure.

For information about defining MATLAB structures, see “Create Structure Array” (MATLAB).

### **Full and Partial Initial Condition Structures**

A full initial condition structure provides an initial value for every element of a bus signal. This IC structure mirrors the bus hierarchy and reflects the attributes of the bus elements.

A partial IC structure provides initial values for a subset of the elements of a bus signal. If you use a partial IC structure, during simulation, Simulink creates a full IC structure to represent all the bus signal elements. Simulink assigns the respective ground value to each element for which the partial IC structure does not explicitly assign a value.

Specifying partial structures for block parameter values can be useful during the iterative process of creating a model. Partial structures enable you to focus on a subset of signals in a bus. When you use partial structures, Simulink initializes unspecified signals implicitly.

Specifying full structures during code generation offers these advantages:

- Generates more readable code
- Supports a modeling style that explicitly initializes all signals

### **Match IC Structure Values to Bus Elements**

The field that you specify in an IC structure must match the following data attributes of the bus element exactly:

- Name
- Dimension
- Complexity

For example, suppose that you define a bus element to be a real [2x2] double array. Then in the IC structure, define the value to initialize that bus element to be a real [2x2] double array.

Explicitly specify fields in the IC structure for every bus element that has an enumerated (enum) data type.

When you define a partial IC structure:

- Include only fields that are in the bus.
- You can omit fields that are in the bus.
- Make the field in the IC structure correspond to the nesting level of the bus element.
- Within the same nesting level in both the structure and the bus, you can specify the structure fields in a different order than the bus elements.

---

**Note:** The value of an IC structure must lie within the design minimum and maximum range of the corresponding bus element. Simulink performs this range checking during an update diagram and when you run the model.

---

### **Examples of Partial Structures**

Suppose that you have a bus, **Top**, composed of three elements: **A**, **B**, and **C**, with these characteristics:

- **A** is a nested bus, with two signal elements.
- **B** is a single signal.
- **C** is a nested bus that includes bus **A** as a nested bus.

The following model, `ex_busic` includes the nested **Top** bus. The screen capture shows the model after it has been updated. .

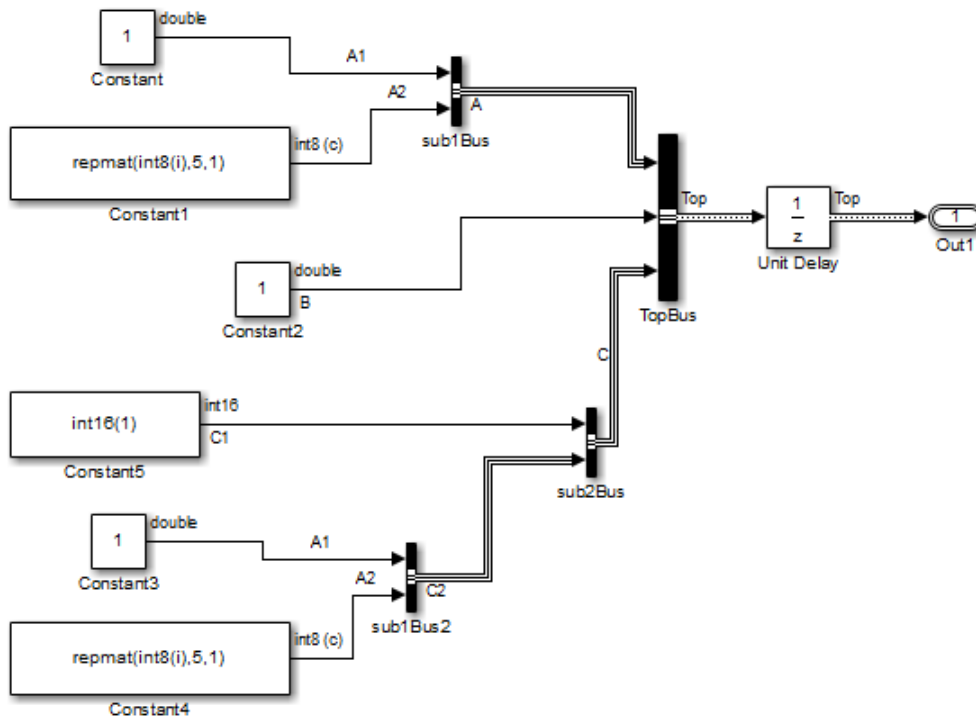

The following diagram summarizes the Top bus hierarchy and the data type, dimension, and complexity of the bus elements.

Top

```

A (sub1)
  A1 (double)
  A2 (int8, 5x1, complex)
B (double)
C (sub2)
  C1 (int16)
  C2 (sub1)
    A1 (double)
    A2 (int8, 5x1, complex)

```

#### Valid Partial IC Structures

In the following examples, K is an IC structure specified for the initial value of the Unit Delay block. The IC structure corresponds to the Top bus in the ex\_busic model.

The following table shows valid initial condition specifications.

Valid Syntax	Description
<code>K.A.A1 = 3</code>	Initializes the bus element <code>Top.A.A1</code> using the value 3.
<code>K = struct('C',struct('C1',int16(4)))</code>	The bus element <code>Top.C.C1</code> is <code>int16</code> . The corresponding structure field explicitly specifies <code>int16(4)</code> . Alternatively, you could specify the field value as 4 without specifying an explicit data type.
<code>K = struct('B',3,'A',struct('A1',4))</code>	Bus element <code>Top.B</code> and <code>Top.A</code> are at the same nesting level in the bus. For bus elements at the same nesting level, the order of corresponding structure fields does not matter.

#### Invalid Partial IC Structures

In the following examples, `K` is an IC structure specified for the initial value of the Unit Delay block. The IC structure corresponds to the `Top` bus in the `ex_busic` model.

These three initial condition specifications are *not* valid:

Invalid Syntax	Reason the Syntax Is Invalid
<code>K.A.A2 = 3</code>	Value dimension and complexity do not match. The bus element <code>Top.A.A2</code> is <code>5x1</code> , but <code>K.A.A2</code> is <code>1x1</code> ; <code>Top.A.A2</code> is complex, but <code>K.A.A2</code> is real.
<code>K.C.C2 = 3</code>	You cannot use a scalar value to initialize IC substructures.
<code>K = struct('B',3,'X',4)</code>	You cannot specify fields that are not in the bus ( <code>X</code> does not exist in the bus).

#### Creating Full IC Structures Using `Simulink.Bus.createMATLABStruct`

Use the `Simulink.Bus.createMATLABStruct` function to streamline the process of creating a full MATLAB initial condition structure with the same hierarchy, names, and data attributes as a bus signal. This function fills all the elements that you do not specify with the ground values for those elements.

You can use several different kinds of input with the `Simulink.Bus.createMATLABStruct` function, including

- A bus object name
- An array of port handles

You can invoke the `Simulink.Bus.createMATLABStruct` function from the Bus Editor. Select the bus object for which you want to create a full MATLAB structure, and then use one of these approaches:

- Select the **File > Create a MATLAB structure** menu item.
- Click the **Create a MATLAB structure** icon () from the toolbar.

You can then edit the MATLAB structure in the MATLAB Editor.

For details, see the `Simulink.Bus.createMATLABStruct` documentation.

### Check for Partial Structures with Model Advisor

To detect when structure parameters are not consistent in shape (hierarchy and names) with the associated bus signal, in the Simulink Editor, use the **Analysis > Model Advisor > By Product > Simulink “Check structure parameter usage with bus signals”** check. This check identifies partial IC structures.

### Control Data Types of Structure Fields

If any of the signal elements of the target bus use a data type other than `double`, you can use different techniques to control the data types of the fields of initial condition structures. The technique that you choose can influence the efficiency and readability of the generated code. See “Control Data Types of Initial Condition Structure Fields” on page 63-148.

### Initialize Bus Signals Using Block Parameters

Initialize a bus signal by setting the initial condition parameter for a block that receives a bus signal as input and that supports bus initialization (see “Blocks That Support Bus Signal Initialization” on page 63-100).

For example, the Block Parameters dialog box for the Unit Delay block has an **Initial conditions** parameter.

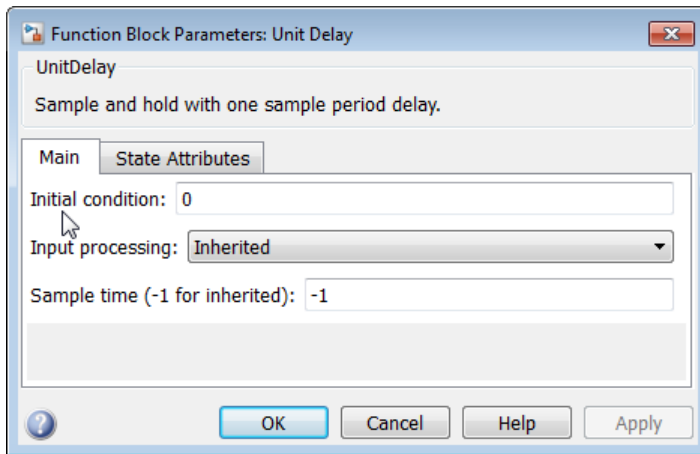

For a block that supports bus signal initialization, you can replace the default value of 0 using one of these approaches:

- “MATLAB Structure for Initialization” on page 63-106
- “MATLAB Variable for Initialization” on page 63-107
- “Simulink.Parameter For Initialization” on page 63-108

All three approaches require that you define an IC structure (see “Create Initial Condition Structures” on page 63-100). You cannot specify a nonzero scalar value or any other type of value other than 0, an IC structure, or `Simulink.Parameter` object to initialize a bus signal.

Defining an IC structure as a MATLAB variable, rather than specifying the IC structure directly in the Block Parameters dialog box offers several advantages, including:

- Reuse of the IC structure for multiple blocks
- Using the IC structure as a tunable parameter in the generated code

### **MATLAB Structure for Initialization**

You can initialize a bus signal using a MATLAB structure that explicitly defines the initial conditions for the bus signal.

For example, in the **Initial conditions** parameter of the Unit Delay block, you could type in a structure.

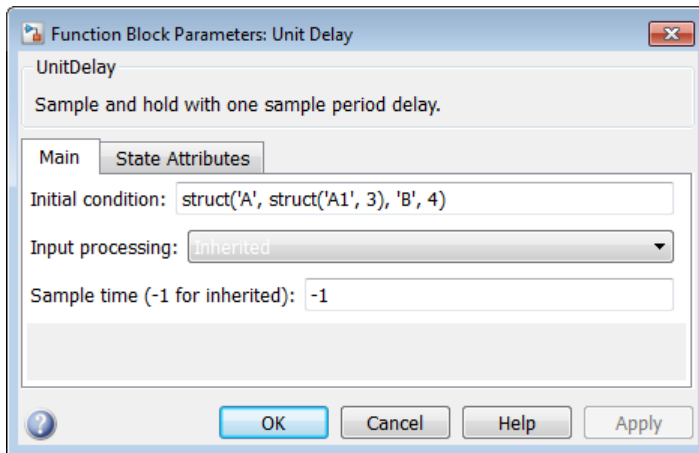

### MATLAB Variable for Initialization

You can initialize a bus signal using a MATLAB variable that you define as an IC structure with the appropriate values.

For example, you could define the following partial structure in the base workspace:

```
K = struct('A', struct('A1', 3), 'B', 4);
```

You can then specify the K structure as the **Initial conditions** parameter of the Unit Delay block:

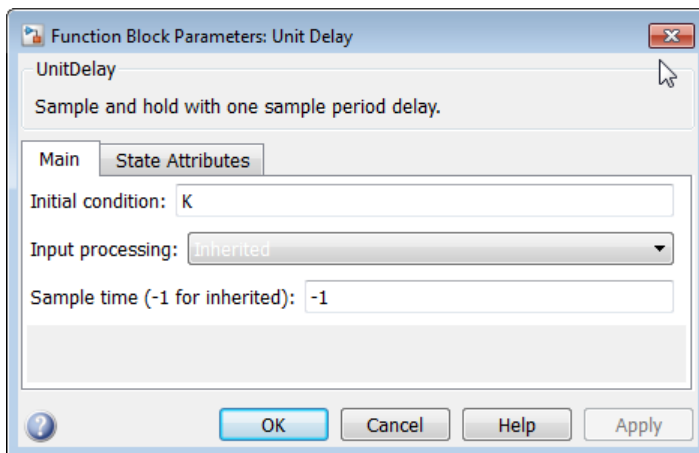

### Simulink.Parameter For Initialization

You can initialize a bus signal using a Simulink.Parameter object that uses an IC structure for the Value property.

For example, you could define the partial structure P in the base workspace (reflecting the ex\_busic model discussed in the previous section):

```
P = Simulink.Parameter;
P.DataType = 'Bus: Top';
P.Value = Simulink.Bus.createMATLABStruct('Top');
P.Value.A.A1 = 3;
P.Value.B = 5;
```

You can then specify the P structure as the **Initial conditions** parameter of the Unit Delay block:

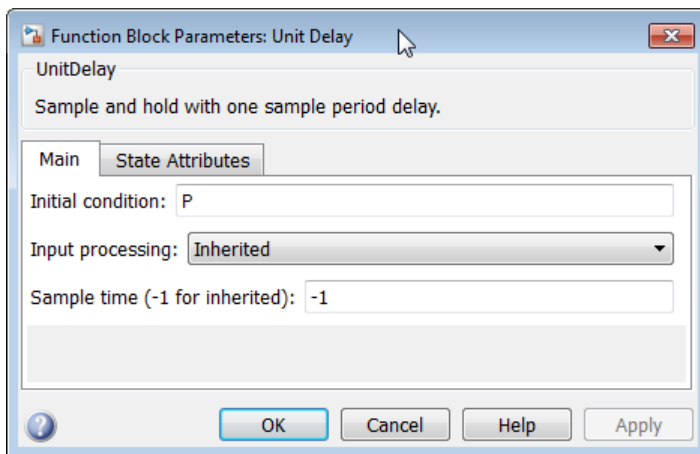

### Set Diagnostics to Support Bus Signal Initialization

To enable bus signal initialization, before you start a simulation, on the **Configuration Parameters > All Parameters** tab, set “**Underspecified initialization detection**” to simplified.

### See Also

#### Blocks

Bus Creator | Bus Selector | Unit Delay



**Functions**

`Simulink.BlockDiagram.addBusToVector` | `Simulink.Bus.cellToObject`  
| `Simulink.Bus.createMATLABStruct` | `Simulink.Bus.createObject` |  
`Simulink.Bus.objectToCell` | `Simulink.Bus.save`

**Classes**

`Simulink.Bus` | `Simulink.BusElement`

**Related Examples**

- “Import Bus Data to Top-Level Input Ports” on page 59-166
- “Bus Data Crossing Model Reference Boundaries” on page 63-142
- “Initialize Arrays of Buses” on page 63-124
- “Buses” on page 63-3

## Combine Buses into an Array of Buses

In this section...
“What Is an Array of Buses?” on page 63-110
“Benefits of an Array of Buses” on page 63-111
“Define an Array of Buses” on page 63-112

---

**Tip:** Simulink provides several techniques for combining signals into a composite signal. For a comparison of techniques, see “Overview of Composite Signal Techniques” on page 63-3.

---

### What Is an Array of Buses?

An array of nonvirtual buses is an array whose elements are buses. Each bus object has the same signal name, hierarchy, and attributes for its bus elements.

An example of using an array of buses is to model a multi-channel system, such as a communications system. You can model all the channels using the same bus object, although each of the channels could have a different value.

To use an arrays of buses:

- Use a bus object as a data type (see “Specify a Bus Object Data Type” on page 57-55).
- Specify dimensions for the bus and bus elements.

For an example of a model that uses an array of buses, open the `sldemo_bus_arrays` model. In this example, the nonvirtual bus input signals connect to a Vector Concatenate or Matrix Concatenate block that creates an array of bus signals. Here is the diagram after you update it:

## Modeling Arrays of Bus Signals

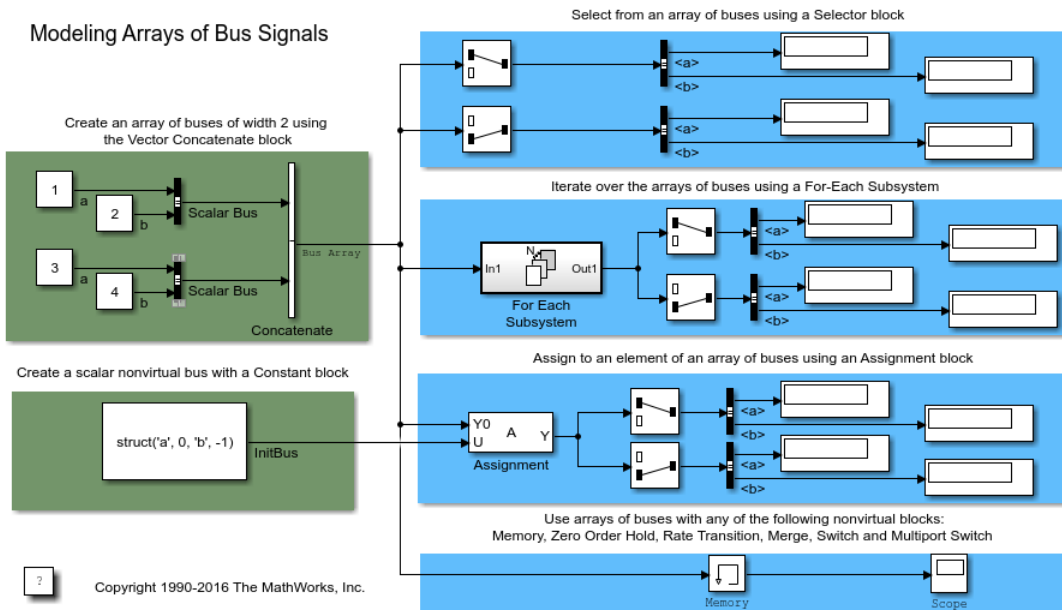

The model uses the array of buses with:

- An Assignment block, to assign a bus in the array
- A For Each Subsystem block, to perform iterative processing over each bus in the array
- A Memory block, to output the array of buses input from the previous time step

## Benefits of an Array of Buses

Use an array of buses to:

- Represent structured data compactly.
  - Reduce model complexity.
  - Reduce maintenance by centralizing algorithms used for processing multiple buses.
- Streamline iterative processing of multiple buses of the same type, for example, by using a For Each Subsystem with the array of buses.

- Simplify changing the number of buses, without your having to restructure the rest of the model or make updates in multiple places in the model.
- Use built-in blocks, such as the Assignment or Selector blocks, to manipulate arrays of buses just like arrays of any other type. Using an array of buses avoids the need for you to create custom S-functions to manage packing and unpacking structure signals.
- Use the combined bus data across subsystem boundaries, model reference boundaries, and into or out of a MATLAB Function block.
- Keep all the logic in the Simulink model, rather than splitting the logic between C code and the Simulink model. This approach supports integrated consistency and correctness checking, maintaining metadata in the model, and avoids the need to manage model components in two different environments.
- Generate code that has an array of C structures, which you can integrate with legacy C code that uses arrays of structures. This approach simplifies indexing into an array for Simulink computations, using a `for` loop on indexed structures.

## Define an Array of Buses

For information about the kinds of buses that you can combine into an array of buses, see “Bus Requirements” on page 63-115.

To define an array of buses, use a Concatenate block. The table describes the array of buses input requirements and output for each of the Vector Concatenate and the Matrix Concatenate versions of the Concatenate block.

Block	Bus Signal Input Requirement	Output
Vector Concatenate	Vectors, row vectors, or column vectors	If any of the inputs are row or column vectors, output is a row or column vector.
Matrix Concatenate	Signals of any dimensionality (scalars, vectors, and matrices)	Trailing dimensions are assumed to be 1 for lower dimensionality inputs.  Concatenation is on the dimension that you specify with the <b>Concatenate dimension</b> parameter.

---

**Note:** Do not use a Mux block or a Bus Creator block to define an array of buses. Instead, use a Bus Creator block to create scalar bus signals.

---

- 1 Define *one* bus object for *all* of the buses that you want to combine into an array of buses. For information about defining bus objects, see “Create Bus Objects” on page 63-63.

The `sldemo_bus_arrays` model defines an `sldemo_bus_arrays_busobject` bus object, which both of the Bus Creator blocks use for the input bus signals (Scalar Bus) for the array of buses.

- 2 Add a Vector Concatenate or Matrix Concatenate block to the model and open the Block Parameters dialog box.

The `sldemo_bus_arrays_busobject` model uses a Vector Concatenate block, because the inputs are scalars.

- 3 Set the **Number of inputs** parameter to be the number of buses that you want to be in the array of buses.

The block icon displays the number of input ports that you specify.

- 4 Set the **Mode** parameter to match the type of the input bus data.

In the `sldemo_bus_arrays` model, the input bus data is scalar, so the **Mode** setting is **Vector**.

- 5 If you use a Matrix Concatenation block, set the **Concatenate dimension** parameter to specify the output dimension along which to concatenate the input arrays. Enter one of the following values:

- 1 — concatenate input arrays vertically
- 2 — concatenate input arrays horizontally
- A higher dimension than 2 — perform multidimensional concatenation on the inputs

- 6 Connect to the Concatenate block all the buses that you want to be in the array of buses.

## See Also

### Blocks

Matrix Concatenate | Vector Concatenate

## Related Examples

- “Use Arrays of Buses in Models” on page 63-115

- “Convert Models to Use Arrays of Buses” on page 63-127
- “Repeat an Algorithm Using a For Each Subsystem” on page 63-131
- “Specify Initial Conditions for Bus Signals” on page 63-99
- “Buses in the Generated Code” on page 63-147
- “Overview of Composite Signal Techniques” on page 63-3
- “Blocks That Support Arrays of Buses” on page 63-116

# Use Arrays of Buses in Models

**In this section...**

“Array of Buses Requirements and Limitations” on page 63-115

“Blocks That Support Arrays of Buses” on page 63-116

“Signal Line Style” on page 63-118

## Array of Buses Requirements and Limitations

### Bus Requirements

All buses combined into an array of buses must:

- Be nonvirtual
- Have the same bus type (that is, same name, hierarchies, and attributes for the bus elements)
- Have no variable-size signals or frame-based signals

### Supported Blocks

You can use arrays of buses with these blocks:

- Virtual blocks
- Several nonvirtual blocks, such as:
  - Some signal routing blocks (for example, Data Store Memory, Merge, and Switch)
  - Rate Transition and Zero-Order Hold blocks
- Several additional blocks, such as Assignment, MATLAB Function, and Signal Conversion

For a complete list, see “Blocks That Support Arrays of Buses” on page 63-116. That section describes requirements for using the supported blocks.

### Structure Parameter Requirements

To initialize an array of buses with structure parameters, you can use:

- The number 0. In this case, all the individual signals in the array of buses use the initial value 0.

- A scalar **struct** that represents the same hierarchy of fields and field names as the bus type. In this case, the scalar structure expands to initialize each of the individual signals in the array of buses.
- An array of structures that specifies an initial value for each of the individual signals in the array of buses.

If you use an array of structures, all the structures in the array must have the same hierarchy of fields. Each field in the hierarchy must have the same characteristics across the array:

- Field name
- Numeric data type, such as **single** or **int32**
- Complexity
- Dimensions

You cannot use partial structures.

For more information about specifying initial conditions for bus signals, see “Initialize Arrays of Buses” on page 63-124.

### **Signal Logging Limitation**

Simulink does not log array of buses signals inside referenced models in rapid accelerator mode.

### **Stateflow Limitations**

Stateflow action language does not support arrays of buses.

## **Blocks That Support Arrays of Buses**

The following blocks support arrays of buses:

- Virtual blocks (see “Nonvirtual and Virtual Blocks” on page 34-2)
- These nonvirtual blocks:
  - Data Store Memory
  - Data Store Read
  - Data Store Write
  - Memory



- Merge
- Multiport Switch
- Rate Transition
- Switch
- Unit Delay
- Zero-Order Hold
- Assignment
- MATLAB Function
- Matrix Concatenate
- Selector
- Signal Conversion
- Vector Concatenate
- Width
- Two-Way Connection (a Simscape block)

---

**Note:** You can use an array of buses as an input to an In Bus Element block, but you cannot use that block to select individual buses. The block passes through the whole array of buses signal.

---

### Block Parameter Settings

Using an array of buses signal with some blocks requires specific block parameter settings.

This information is also in the reference pages for each of these blocks. For usage information for bus-related blocks, see “Work with Array of Buses Signals” on page 63-120.

Block	Block Parameters Settings
Memory	<p><b>Initial condition</b> — You can specify this parameter with:</p> <ul style="list-style-type: none"> <li>• The value 0. In this case, all the individual signals in the array of buses use the initial value 0.</li> </ul>

Block	Block Parameters Settings
	<ul style="list-style-type: none"> <li>• An array of structures that specifies an initial condition for each of the individual signals in the array of buses.</li> <li>• A single scalar structure that specifies an initial condition for each of the elements that the bus type defines. Use this technique to specify the same initial conditions for each of the buses in the array.</li> </ul>
Merge	<ul style="list-style-type: none"> <li>• <b>Allow unequal port widths</b> — Clear this parameter.</li> <li>• <b>Number of inputs</b> — Set to a value of 2 or greater.</li> <li>• <b>Initial condition</b> — You can specify this parameter with: <ul style="list-style-type: none"> <li>• The value 0. In this case, all the individual signals in the array of buses use the initial value 0.</li> <li>• An array of structures that specifies an initial condition for each of the individual signals in the array of buses.</li> <li>• A single scalar structure that specifies an initial condition for each of the elements that the bus type defines. Use this technique to specify the same initial conditions for each of the bus signals in the array.</li> </ul> </li> </ul>
Multiport Switch	<b>Number of data ports</b> — Set to a value of 2 or greater.
Signal Conversion	<b>Output</b> — Set to <code>Signal copy</code> .
Switch	<b>Threshold</b> — Specify a scalar threshold.

## Signal Line Style

After model simulation, the line style for the array of buses signal is a thicker version of the signal line style for a nonvirtual bus signal.

For example, in the `sldemo_bus_arrays` model, the `Scalar Bus` signal is a nonvirtual bus signal, and the `Bus Array` output signal of the `Concatenate` block is an array of buses signal.

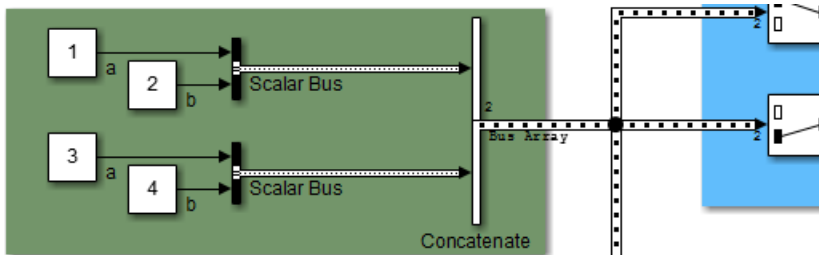

## Related Examples

- “Combine Buses into an Array of Buses” on page 63-110
- “Work with Array of Buses Signals” on page 63-120
- “Convert Models to Use Arrays of Buses” on page 63-127
- “Repeat an Algorithm Using a For Each Subsystem” on page 63-131
- “Specify Initial Conditions for Bus Signals” on page 63-99
- “Access Array of Buses Signal Logging Data” on page 59-34
- “Buses in the Generated Code” on page 63-147

## Work with Array of Buses Signals

### In this section...

- “Set Up Model for Arrays of Buses” on page 63-120
- “Perform Iterative Processing” on page 63-121
- “Assign Values into an Array of Buses” on page 63-122
- “Select Bus Elements from an Array of Buses” on page 63-122
- “Import Array of Buses Data” on page 63-123
- “Log Array of Buses Signals” on page 63-123
- “Initialize Arrays of Buses” on page 63-124
- “Code Generation” on page 63-126

To select a signal within an array of buses, use a:

- 1 Selector block to find the appropriate bus within the array of buses.
- 2 Bus Selector block to select the signal.

To assign a value to a signal within an array of buses, use:

- 1 A Bus Assignment block to assign a value to a bus element
- 2 An Assignment block to assign the bus to the array of buses

Bus Selector and Bus Assignment blocks can only accept scalar buses, not arrays of buses.

A Bus Creator block can accept an array of buses as input, but cannot have an array of buses as output.

### Set Up Model for Arrays of Buses

Setting up a model to use an array of buses usually involves these basic tasks:

- 1 Define the array of buses (see “Define an Array of Buses” on page 63-112).
- 2 Add a subsystem for performing iterative processing on each element of the array of buses. For example, use a For Each Subsystem block or an Iterator block. Connect

the array of buses signal from the Concatenate block to the iterative processing subsystem. See “Perform Iterative Processing” on page 63-121.

- 3 Model your scalar algorithm within the iterative processing subsystem (for example, a For Each subsystem).
  - a Operate on the array of buses (using Selector and Assignment blocks).
  - b Use the Bus Selector and Bus Assignment blocks to select elements from, or assign elements to, a scalar bus within the subsystem.

See “Assign Values into an Array of Buses” on page 63-122 and “Select Bus Elements from an Array of Buses” on page 63-122.

- 4 Optionally, import or log array of buses data. See “Import Array of Buses Data” on page 63-123 and “Log Array of Buses Signals” on page 63-123

The resulting model includes these components.

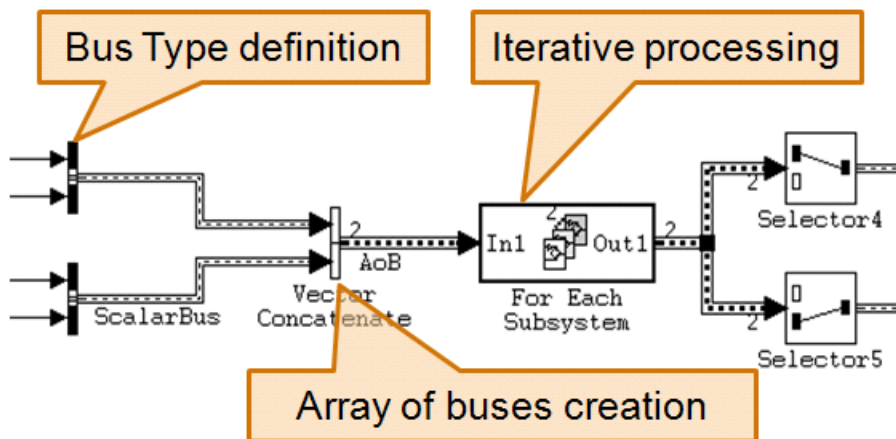

## Perform Iterative Processing

You can perform iterative processing on the bus signal data of an array of buses using blocks such as a For Each Subsystem block, a While Iterator Subsystem block, or a For Iterator Subsystem block. You can use one of these blocks to perform the same kind of processing on:

- Each bus in the array of buses

- A selected subset of buses in the array of buses

## Assign Values into an Array of Buses

Use an Assignment block to assign values to specified elements in a bus array.

For example, in the `sldemo_bus_arrays` model, the Assignment block assigns the value to the first element of the array of buses.

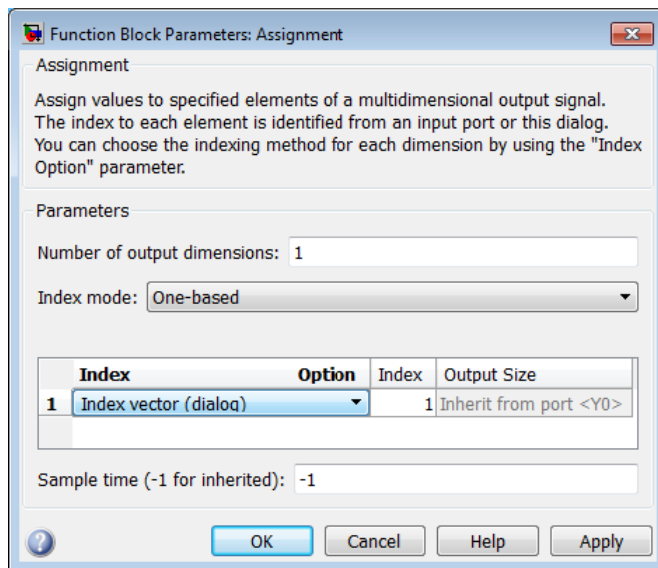

To assign bus elements within a bus signal, use the Bus Assignment block. The input for the Bus Assignment block must be a scalar bus signal.

## Select Bus Elements from an Array of Buses

Use a Selector block to select elements of an array of buses. The input array of buses can have any dimension. The output bus signal of the Selector block is a selected or reordered set of elements from the input array of buses.

For example, the `sldemo_bus_arrays` model uses Selector blocks to select elements from the array of buses signal that the Assignment and For Each Subsystem blocks

outputs. In this example, here is the Block Parameters dialog box for the Selector block that selects the first element:

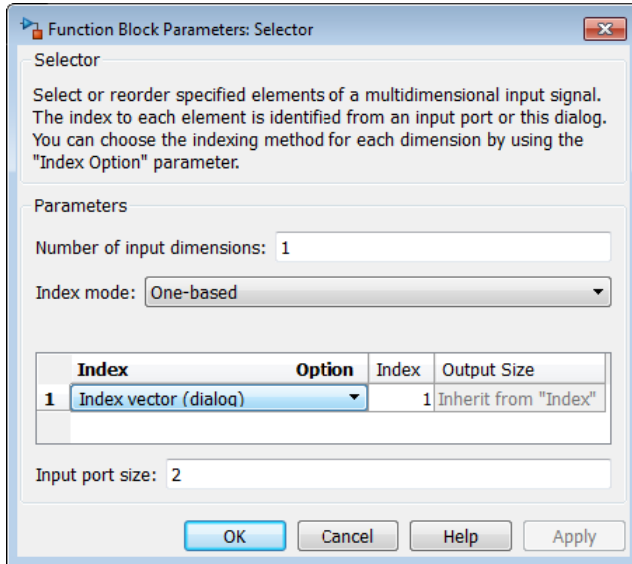

To select bus elements within a bus signal, use the Bus Selector block. The input for the Bus Selector block must be a scalar bus signal.

## Import Array of Buses Data

Use a root Inport block to import (load) an array of structures of MATLAB `timeseries` objects for an array of buses. You can import partial data into the array of buses.

For details, see “Import Array of Buses Data” on page 59-171.

You cannot use a From Workspace or From File block to import data for an array of buses.

## Log Array of Buses Signals

To export an array of buses signal, mark the signal for signal logging. For more information, see “Save Runtime Data from Simulation”.

**Note:** Simulink does not log signals inside referenced models in rapid accelerator mode.

To access the signal logging data for a specific signal in an array of buses, navigate through the structure hierarchy and specify the index to the specific signal. For details, see “Access Array of Buses Signal Logging Data” on page 59-34.

## Initialize Arrays of Buses

To specify a unique initial value for each of the individual signals in an array of buses, you can use an array of initial condition structures. Each structure in the array initializes one of the buses.

Here is an example that shows how to initialize an array of buses. Suppose that you define the bus types `MyData` and `PressureBus`.

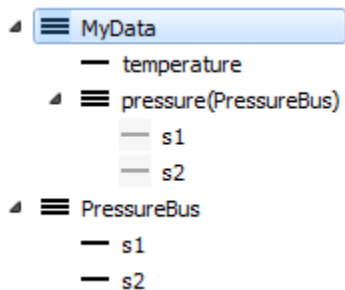

Suppose that you set the data type of the signal element `temperature` to `int16`, and the data type of the elements `s1` and `s2` to `double`.

To specify initial conditions for an array of buses, you can create a variable whose value is an array of initial condition structures.

```
initValues(1).temperature = int16(5);
initValues(1).pressure.s1 = 9.87;
initValues(1).pressure.s2 = 8.71;
```

```
initValues(2).temperature = int16(20);
initValues(2).pressure.s1 = 10.21;
initValues(2).pressure.s2 = 9.56;
```

```
initValues(3).temperature = int16(35);
```



```
initValues(3).pressure.s1 = 8.98;
initValues(3).pressure.s2 = 9.17;
```

The variable `initValues` provides initial conditions for a signal that is an array of three buses. You can use `initValues` to specify the **Initial condition** parameter of a block such as Unit Delay.

Alternatively, you can use a single scalar structure to specify the same initial conditions for all the buses in the array.

```
initStruct.temperature = int16(15);
initStruct.pressure.s1 = 10.32;
initStruct.pressure.s2 = 9.46;
```

If you specify `initStruct` in the **Initial condition** parameter of a block, each bus in the array uses the same initial value, 15, for the signal element `temperature`. Similarly, the buses use the initial value 10.32 for the element `pressure.s1` and the value 9.46 for the element `pressure.s2`.

To create an array of structures for a bus that uses a large hierarchy of signal elements, consider using the function `Simulink.Bus.createMATLABStruct`.

This example shows how to initialize a nested array of buses. Create an initial condition structure for a complicated signal hierarchy that includes nested arrays of buses.

- 1 In the Bus Editor, create the bus objects `MyData` and `PressureBus`.

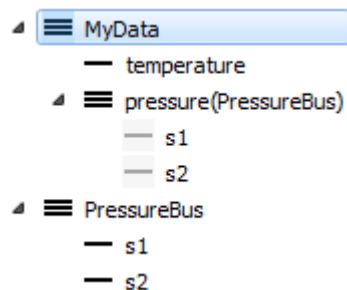

- 2 In the hierarchy pane, select the bus element `pressure`. Set the **Dimensions** property to `[1 3]`.
- 3 Create an array of four initialization structures by using the function `Simulink.Bus.createMATLABStruct`. Store the array in the variable `initStruct`. Initialize all the individual signals to the ground value, 0.

```
initStruct=Simulink.Bus.createMATLABStruct('MyData',[1,4]);
```

- 4 In the base workspace, double-click the variable `initStruct` to view it in the variable editor.

The four structures in the array each have the fields `temperature` and `pressure`.

- 5 To inspect a `pressure`, double-click one of the fields.

The value of each of the four `pressure` fields is an array of three substructures. Each substructure has the fields `s1` and `s2`.

- 6 To provide unique initialization values for the signals in an array of buses, you can specify the values manually using the variable editor.

Alternatively, you can write a script. For example, to access the field `s1` of the second substructure `pressure` in the third structure of `initStruct`, use this code:

```
initStruct(3).pressure(2).s1 = 15.35;
```

## Code Generation

Code generation for array of buses signals produces structures with a specific format. See “Code Generation for Arrays of Buses” on page 63-155.

## Related Examples

- “Combine Buses into an Array of Buses” on page 63-110
- “Use Arrays of Buses in Models” on page 63-115
- “Convert Models to Use Arrays of Buses” on page 63-127
- “Repeat an Algorithm Using a For Each Subsystem” on page 63-131
- “Specify Initial Conditions for Bus Signals” on page 63-99
- “Access Array of Buses Signal Logging Data” on page 59-34
- “Buses in the Generated Code” on page 63-147

## Convert Models to Use Arrays of Buses

There are several reasons to convert a model to use an array of buses (see “Benefits of an Array of Buses” on page 63-111). For example:

- The model was developed before Simulink supported arrays of buses (introduced in R2010b), and the model contains many subsystems that perform the same kind of processing.
- The model has grown in complexity.

### General Conversion Approach

Here is a general approach for converting a model that contains buses to a model that uses an array of buses. The method that you use depends on your model. For details about these techniques, see “Combine Buses into an Array of Buses” on page 63-110 and “Use Arrays of Buses in Models” on page 63-115.

This workflow refers to a stylized example model. The example shows the original modeling pattern and a new modeling pattern that uses an array of buses.

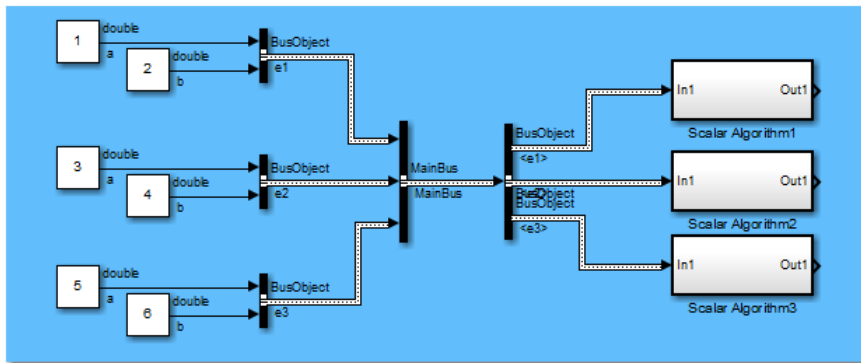

Original modeling pattern

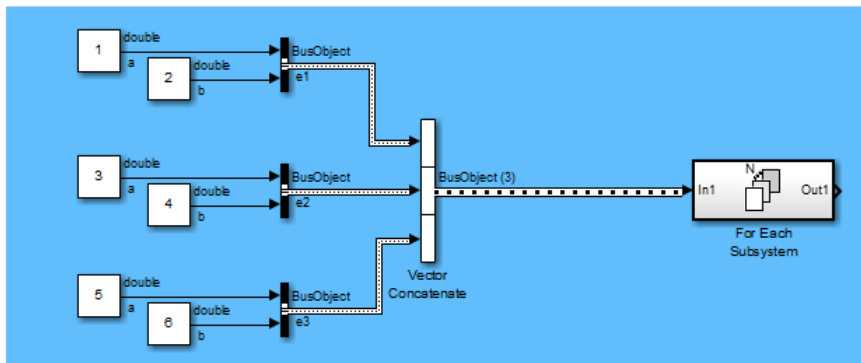

New modeling pattern

In the original modeling pattern:

- The target bus signal to be converted is named **MainBus**, and it has three elements, each of type **BusObject**.
- The **ScalarAlgorithm1**, **ScalarAlgorithm2**, and **ScalarAlgorithm3** subsystems encapsulate the algorithms that operate on each of the bus elements. The subsystems all have the same content.
- A **Bus Selector** block picks out each element of **MainBus** to drive the subsystems.

The construction in the original modeling pattern is inefficient for two reasons:

- A copy of the subsystem that encapsulates the algorithm is made for each element of the bus that is to be processed.
- Adding another element to `MainBus` involves changing the bus object definition and the Bus Selector block, and adding a subsystem. Each of these changes is a potential source of error.

To convert the original modeling pattern to use an array of buses:

- 1 Identify the target bus and associated algorithm that you want to convert. Typically, the target bus signal is a bus of buses, where each element bus signal is of the same type.
  - The bus that you convert must be a nonvirtual bus. If all elements of the target bus have the same sample time (or if the sample time is inherited), you can convert a virtual bus to a nonvirtual bus.
  - The target bus cannot have variable-dimensioned and frame-based elements.
- 2 Use a Concatenate block to convert the original bus of buses signal to an array of buses.

In the example, the new modeling pattern uses a Vector Concatenate block to replace the Bus Creator block that creates the `MainBus` signal. The output of the Vector Concatenate block is an array of buses, where the type of the bus signal is `BusObject`. The new model eliminates the wrapper bus signal (`MainBus`).

- 3 Replace all identical copies of the algorithm subsystem with a single For Each subsystem that encapsulates the scalar algorithm. Connect the array of buses signal to the For Each subsystem.

The new model eliminates the Bus Selector blocks that separate out the elements of the `MainBus` signal in the original model.

- 4 Configure the For Each Subsystem block to iterate over the input array of buses signal and concatenate the output bus signal.

The scalar algorithm within the For Each subsystem cannot have continuous states. For additional limitations, see the For Each Subsystem block documentation.

## Related Examples

- “Combine Buses into an Array of Buses” on page 63-110
- “Use Arrays of Buses in Models” on page 63-115

- “Work with Array of Buses Signals” on page 63-120
- “Repeat an Algorithm Using a For Each Subsystem” on page 63-131

## Repeat an Algorithm Using a For Each Subsystem

If you repeat algorithms in a diagram by copying and pasting blocks and subsystems, maintaining the model can become difficult. Individual signal lines and subsystems can crowd the diagram, reducing readability and making simple changes difficult. At the same time, many variables can crowd workspaces, reducing model portability. A model can develop these efficiency issues as you add to the design over time.

To repeat an algorithm, you can iterate the algorithm over signals, subsystems, and parameters that are grouped into arrays and structures. This example shows how to convert an inefficiently complex repetitive algorithm into a compact form that is easier to manage.

### In this section...

“Explore Example Model” on page 63-131

“Reduce Signal Line Density with Buses” on page 63-132

“Repeat an Algorithm” on page 63-135

“Organize Parameters into Arrays of Structures” on page 63-138

“Inspect the Converted Model” on page 63-140

### Explore Example Model

- 1 Open the example model `ex_repeat_algorithm`. The model creates about 30 variables in the base workspace.
- 2 Inspect the subsystem `Burner_1_Analysis`. This subsystem executes an algorithm by using the base workspace variables as parameters in blocks such as Constant and Discrete-Time Integrator.
- 3 Inspect the subsystems `Burner_2_Analysis` and `Burner_3_Analysis`. All three subsystems execute the same algorithm but use different workspace variables to parameterize the blocks.
- 4 Inspect the three `Analysis_Delay` subsystems. These subsystems repeat a different algorithm from the one in the Analysis subsystems.
- 5 Return to the top level of the model. The Memory blocks delay the input signals before they enter the `Analysis_Delay` subsystems.
- 6 Look at the **Data Import/Export** pane of the Configuration Parameters dialog box. The model uses the variables `SensorsInput` and `t` as simulation inputs.

During simulation, each of the nine columns in the matrix variable `SensorsInput` provides input data for an Inport block at the top level of the model.

## Reduce Signal Line Density with Buses

You can use buses to group related signals into a single structured signal, reducing line density and improving model readability.

Each subsystem in the example model requires three signal inputs. You can combine each group of three signals into a single bus.

You could modify all the subsystems in the example model to use buses. However, because some of the subsystems are identical, you can delete them and later replace them with For Each Subsystem blocks.

- 1 Open the Bus Editor.

```
buseditor
```

- 2 Create a bus type `SensorData` with three signal elements: `sensor1`, `sensor2`, and `sensor3`.

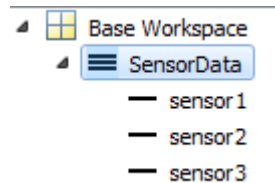

- 3 Delete the blocks as shown in the figure, leaving only the `Burner_1_Sensor1` and `Burner_1_Delay1` blocks as inputs to the two remaining subsystems.



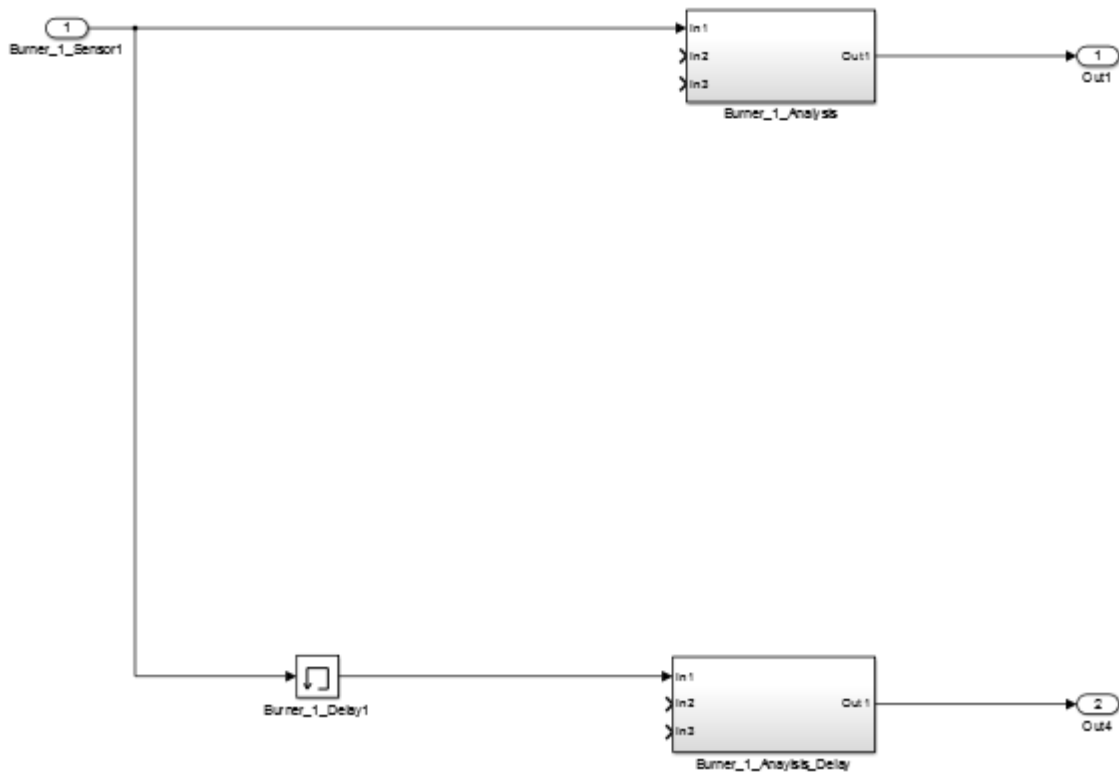

- 4 On the **Signal Attributes** tab of the Burner\_1\_Sensor1 Inport block dialog box, set **Data type** to Bus: SensorData.

The output of the block is a bus signal that contains the three signal elements sensor1, sensor2, and sensor3.

- 5 Open the subsystem Burner\_1\_Analysis. Delete the signal output lines of the three Inport blocks. Delete the In2 and In3 Inport blocks.
- 6 Add a Bus Selector block to the right of the In1 Inport block. Connect the Inport block output to the Bus Selector block.
- 7 In the Bus Selector block dialog box, select the signals sensor1, sensor2, and sensor3.

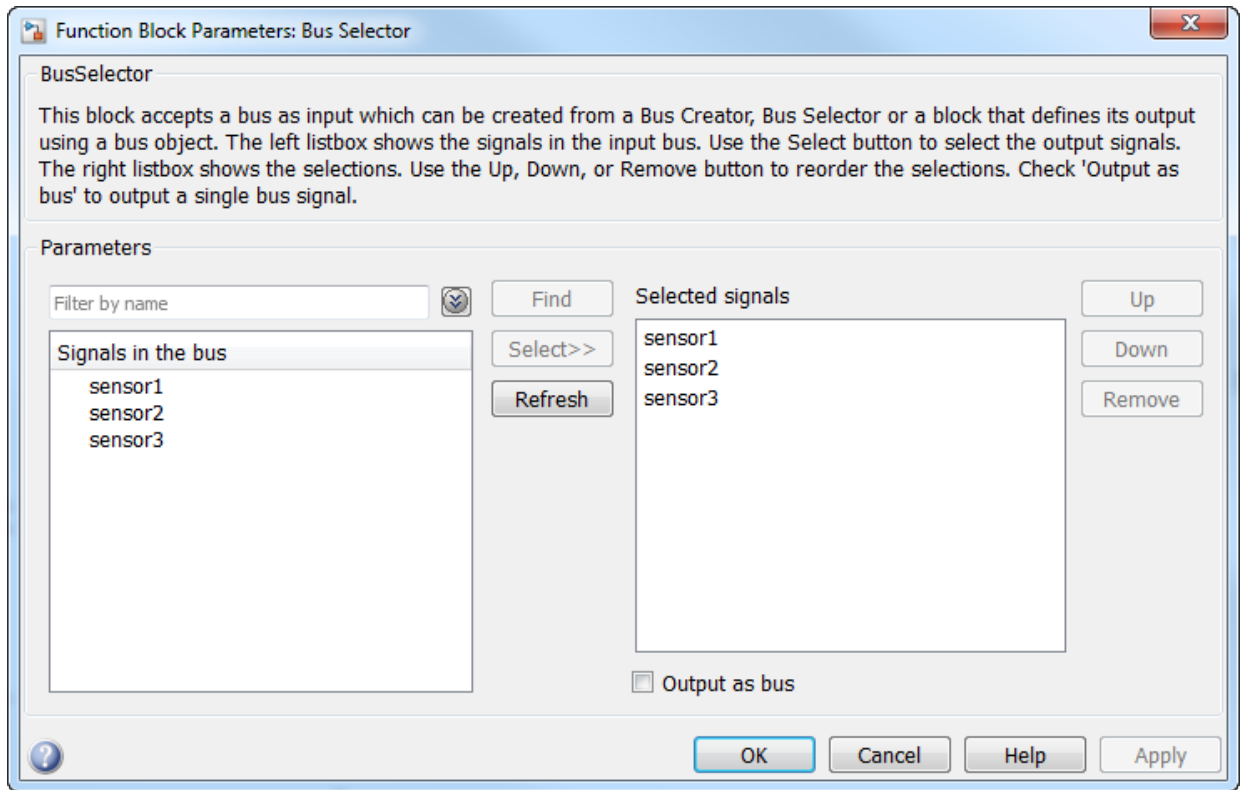

The Bus Selector block extracts the three signal elements from the input bus. Other blocks in the model can use the extracted signal elements.

- 8 In the subsystem, connect the blocks as shown.

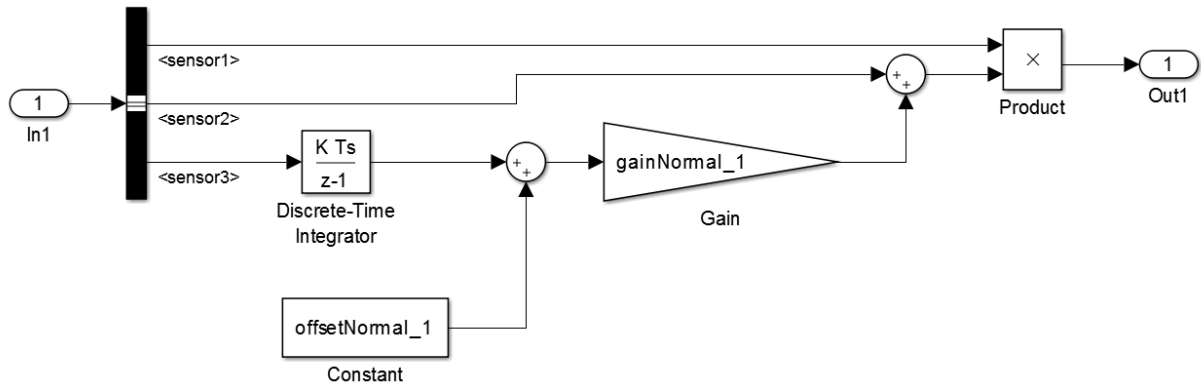

- 9 In the subsystem `Burner_1_Analysis_Delay`, use a Bus Selector block to extract the signals in the bus. Use the same technique as you did in the subsystem `Burner_1_Analysis`.

## Repeat an Algorithm

A For Each Subsystem block partitions an input signal, and sequentially executes an algorithm on each partition. For example, if the input to the subsystem is an array of six signals, you can configure the subsystem to execute the same algorithm on each of the six signals.

You can use For Each subsystems to repeat an algorithm in an iterative fashion. This approach improves model readability and makes it easy to change the repeated algorithm .

- 1 Add two For Each Subsystem blocks to the model. Name one of the subsystems `Burner_Analysis`. Name the other subsystem `Burner_Analysis_Delay`.
- 2 Copy the contents of the subsystem `Burner_1_Analysis` into the subsystem `Burner_Analysis`. Before you paste the blocks, delete the Inport and Outport blocks in the For Each subsystem.
- 3 In the For Each block dialog box in the `Burner_Analysis` subsystem, select the check box to partition the input `In1`.
- 4 Copy the contents of the subsystem `Burner_1_Analysis_Delay` into the subsystem `Burner_Analysis_Delay`.

- 5 In the For Each block dialog box in the Burner\_Analysis\_Delay subsystem, select the check box to partition the input In1.
- 6 At the top level of the model, delete the subsystems Burner\_1\_Analysis and Burner\_1\_Analysis\_Delay. Connect the new For Each Subsystem blocks in their place.
- 7 On the **Signal Attributes** tab of the Burner\_1\_Sensor1 Inport block dialog box, set **Port dimensions** to 3.

The block output is a three-element array of buses. The For Each subsystems in the model repeat an algorithm for each of the three buses in the array.

- 8 Create a Simulink.SimulationData.Dataset object that the Inport block can use to import the simulation data. You can use this code to create the object and store it in the variable SensorsInput.

```
% First, create an array of structures whose field values are
% timeseries objects.

for i = 1:3 % Burner number

    % Sensor 1
    eval(['tempInput(1,' num2str(i) ').sensor1 = ' ...
          'timeseries(t,SensorsInput(:, ' num2str(3*(i-1)+1) ');'])

    % Sensor 2
    eval(['tempInput(1,' num2str(i) ').sensor2 = ' ...
          'timeseries(t,SensorsInput(:, ' num2str(3*(i-1)+2) ');'])

    % Sensor 3
    eval(['tempInput(1,' num2str(i) ').sensor3 = ' ...
          'timeseries(t,SensorsInput(:, ' num2str(3*(i-1)+3) ');'])

end

% Create the Dataset object.

SensorsInput = Simulink.SimulationData.Dataset;
SensorsInput = addElement(SensorsInput,tempInput,'element1');

clear tempInput t i
```

The code first creates a variable `tempInput` that contains an array of three structures. Each structure has three fields that correspond to the signal elements

in the bus type `SensorData`, and each field stores a MATLAB `timeseries` object. Each `timeseries` object stores one of the nine columns of data from the variable `SensorsInput`, which stored the simulation input data for each of the sensors.

The code then overwrites `SensorsInput` with a new `Simulink.SimulationData.Dataset` object, and adds `tempInput` as an element of the object.

- 9 On the **Data Import/Export** pane of the Configuration Parameters dialog box, set **Input** to `SensorsInput`.

Since `SensorsInput` provides simulation input data in the form of `timeseries` objects, you do not need to specify a variable that contains time data.

- 10 Create an array of structures that initializes the remaining Memory block, and store the array in the variable `initForDelay`. Specify the structure fields with the values of the existing initialization variables such as `initDelay_1_sensor1`.

```
for i = 1:3 % Burner number

    % Sensor 1
    eval(['initForDelay(' num2str(i) ').sensor1 = ' ...
          'initDelay_' num2str(i) '_sensor1;'])

    % Sensor 2
    eval(['initForDelay(' num2str(i) ').sensor2 = ' ...
          'initDelay_' num2str(i) '_sensor2;'])

    % Sensor 3
    eval(['initForDelay(' num2str(i) ').sensor3 = ' ...
          'initDelay_' num2str(i) '_sensor3;'])
end
```

To view the contents of the new variable `initForDelay`, double-click the variable name in the base workspace. The variable contains an array of three structures that each has three fields: `sensor1`, `sensor2`, and `sensor3`.

Fields	sensor1	sensor2	sensor3
1	17.5000	13.2000	27.8000
2	5.2000	6.9000	1.7000
3	19.4000	14.9000	22.3000

- In the Memory block dialog box, set **Initial condition** to `initForDelay`.

The Memory block output is an array of buses that requires initialization. Each signal element in the array of buses acquires an initial value from the corresponding field in the array of structures.

## Organize Parameters into Arrays of Structures

The base workspace contains many variables that the example model uses for block parameters. To reduce the number of workspace variables, package them into arrays of structures, and use the individual structure fields to specify block parameters.

A For Each Subsystem block can partition an array of values that you specify as a mask parameter. Each iteration of the subsystem uses a single partition of the array to specify block parameters. If you specify the parameter as an array of structures, each iteration of the subsystem can use one of the structures in the array.

- Create an array of structures that parameterizes the Burner\_Analysis For Each subsystem, and store the array in the variable `paramsNormal`. Specify the structure fields by using the values of existing parameter variables such as `gainNormal_1`, `offsetNormal_1`, and `initDelayed_1`.

```
for i = 1:3
    eval(['paramsNormal(' num2str(i) ').gain = gainNormal_' num2str(i) ';' ])
    eval(['paramsNormal(' num2str(i) ').offset = offsetNormal_' num2str(i) ';' ])
    eval(['paramsNormal(' num2str(i) ').init = initNormal_' num2str(i) ';' ])
end
```

The variable contains an array of three structures that each has three fields: `gain`, `offset`, and `init`.

- 2 In the model, right-click the Burner\_Analysis For Each subsystem and select **Mask > Create Mask**.
- 3 On the **Parameters & Dialog** pane of the dialog box, under **Parameter**, click **Edit**. For the new mask parameter, set **Prompt** to `Parameter` structure and **Name** to `paramStruct`. Click **OK**.
- 4 In the mask for the Burner\_Analysis subsystem, set **Parameter structure** to `paramsNormal`.
- 5 Open the subsystem. In the For Each block dialog box, on the **Parameter Partition** pane, select the check box to partition the parameter `paramStruct`. Set **Partition dimension** to 2.
- 6 For the blocks in the subsystem, set these parameters.

Block	Parameter Name	Parameter Value
Gain	<b>Gain</b>	<code>paramStruct.gain</code>
Discrete-Time Integrator	<b>Initial condition</b>	<code>paramStruct.init</code>
Constant	<b>Constant value</b>	<code>paramStruct.offset</code>

- 7 Create an array of structures that parameterizes the Burner\_Analysis\_Delay For Each subsystem, and store the array in the variable `paramsForDelay`.

```
for i = 1:3
    eval(['paramsForDelay(' num2str(i) ').gain = gainDelayed_' num2str(i) ';' ])
    eval(['paramsForDelay(' num2str(i) ').offset = offsetDelayed_' num2str(i) ';' ])
    eval(['paramsForDelay(' num2str(i) ').init = initDelayed_' num2str(i) ';' ])
end
```

- 8 At the top level of the model, right-click the Burner\_Analysis\_Delay For Each subsystem and select **Mask > Create Mask**.
- 9 On the **Parameters & Dialog** pane of the dialog box, under **Parameter**, click **Edit**. For the new mask parameter, set **Prompt** to `Parameter` structure and **Name** to `paramStruct`. Click **OK**.
- 10 In the mask for the For Each Subsystem block, set **Parameter structure** to `paramsForDelay`.
- 11 Open the subsystem. In the For Each block dialog box, on the **Parameter Partition** pane, select the check box to partition the parameter `paramStruct`. Set **Partition dimension** to 2.
- 12 For the blocks in the subsystem, set these parameters.

Block	Parameter Name	Parameter Value
Gain	Gain	paramStruct.gain
Discrete-Time Integrator	Initial condition	paramStruct.init
Constant	Constant value	paramStruct.offset

- 13 Clear the unnecessary variables from the base workspace.

```
% Clear the old parameter variables that you replaced
% with arrays of structures
clear -regexp _

% Clear the iteration variables
clear i
```

The model requires few variables in the base workspace.

## Inspect the Converted Model

To view the new signal and subsystem organization, update the diagram.

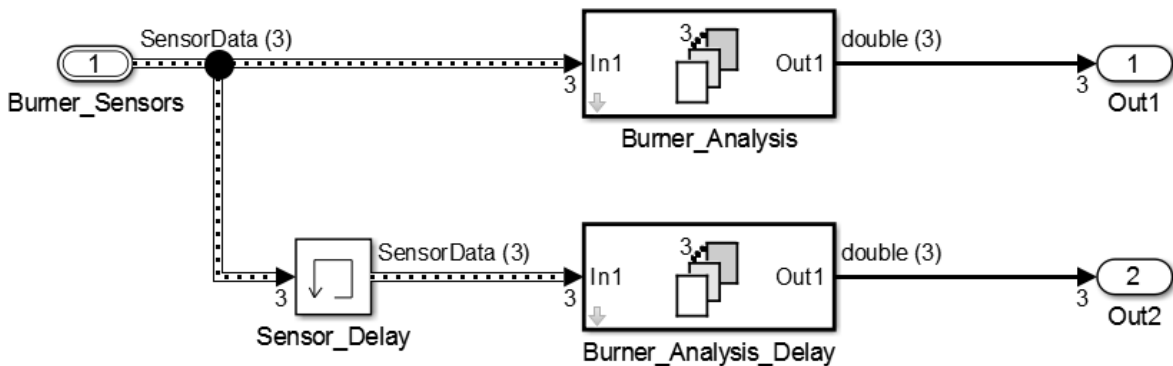

The model input is an array of three bus signals. The model uses two For Each subsystems to execute the two algorithms on each of the three bus signals in the input array.



In the base workspace, arrays of structures replace the many variables that the model used. Mathematically, the modified model behaves the same way it did when you started because the arrays of structures contain the values of all the old variables.

To view the completed model, open the example model `ex_repeat_algorithm_complete`.

---

**Tip:** You can log nonbus signals in a For Each subsystem. However, you cannot use signal logging for bus or array of buses signals from within a For Each subsystem. Either use a Bus Selector block to select the bus element signals that you want to log or add an Output block outside of the subsystem and then log that signal. For details, see “Log Signals in For Each Subsystems” on page 59-111.

---

## See Also

For Each Subsystem | Simulink.Bus

## Related Examples

- “Convert Models to Use Arrays of Buses” on page 63-127
- “Import Bus Data to Top-Level Input Ports” on page 59-166
- “Specify Initial Conditions for Bus Signals” on page 63-99
- “Organize Related Block Parameter Definitions in Structures” on page 35-22
- “Log Signals in For Each Subsystems” on page 59-111
- “Create a Custom Library” on page 39-4

## More About

- “Buses” on page 63-3
- “When to Use Bus Objects” on page 63-59

## Bus Data Crossing Model Reference Boundaries

A model reference boundary refers to the boundary between a model that contains a Model block and the referenced model. If you have bus data in a model that is passed to a Model block, then that data crosses the boundary to the referenced model. You need to set up your model so that the bus data input to the Model block is consistent with the bus data that the referenced model requires.

For bus data that crosses model reference boundaries:

- 1 Use a bus object (`Simulink.Bus`) to define the bus. For details, see “When to Use Bus Objects” on page 63-59 and “Create Bus Objects” on page 63-63.

You can use a nonvirtual or a virtual bus as an input to a referenced model.

- 2 Decide whether to use a virtual or nonvirtual bus. Using a nonvirtual bus provides a well-defined data interface for code generation. See “Virtual and Nonvirtual Buses” on page 63-4.

To use a multi-rate bus signal across a model referenced boundary requires a specific configuration of parameters in the parent and referenced models.

## Connect Multi-Rate Buses to Referenced Models

You can input a single-rate bus to a referenced model. To input the signals in a multi-rate bus to a referenced model, insert blocks into the parent and referenced model as follows:

- 1 **In the parent model:** To convert the multi-rate bus to a single-rate bus, insert a Rate Transition block. The Rate Transition block must specify a rate in its **Block Parameters > Output port sample time** field unless one of the following is true:
  - The **Configuration Parameters > Solver** pane specifies a rate with these settings:
    - The **Periodic sample time constraint** parameter is set to **Specified**.
    - The **Sample time properties** parameter contains the specified rate.
  - The Inport block that accepts the bus in the referenced model specifies a rate in its **Block Properties > Signal Attributes > Sample time** field.
- 2 **In the referenced model:** Use a Bus Selector block to pick out signals of interest, and use Rate Transition blocks to convert the signals to the desired rates.

## Limitations for Virtual Buses

If you use a bus signal as an input to or an output from a referenced model:

- The bus cannot contain a variable-size signal element.

As a workaround, use a nonvirtual bus instead.

- For code generation, you cannot configure the `I/O arguments step method` style of C++ class interface for the referenced model.

As a workaround, use a nonvirtual bus instead. Alternatively, use the `Default` style of C++ class interface.

- For code generation, you cannot configure function prototype control for the referenced model.

As a workaround, use a nonvirtual bus instead.

Use the Upgrade Advisor to fix models saved before R2016a that engage these limitations. See “Update Models Saved Before R2016a” on page 63-143.

## Update Models Saved Before R2016a

The behavior of models that meet these criteria is different than it is in R2016a and later releases:

- The model was saved in a release earlier than R2016a.
- The model has referenced models with bus inputs and outputs configured to be treated as virtual buses.

Use the Upgrade Advisor **Check for virtual bus across model reference boundaries** check to avoid errors that the behavior differences can trigger. Run the **Analyze model hierarchy and continue upgrade sequence** check on the top-level model and then down through the model reference hierarchy.

## See Also

### Blocks

Bus Assignment | Bus Creator | Bus Selector | Bus to Vector | Rate Transition

### Classes

Simulink.Bus | Simulink.BusElement

### **Related Examples**

- “Use Buses for Inports and Outports” on page 63-95
- “Virtual and Nonvirtual Buses” on page 63-4
- “Getting Started with Buses” on page 63-16
- “Nested Buses” on page 63-46

### **More About**

- “Buses” on page 63-3
- “When to Use Bus Objects” on page 63-59

## Bus Conversion

When updating a diagram prior to simulation or code generation, Simulink automatically converts a virtual bus to a nonvirtual bus ( and nonvirtual buses to virtual buses) in cases such as when the virtual bus is an input to, or output from:

- An S-Function block
- A Stateflow chart

When you pass a bus signal into a referenced model, Simulink makes the bus a virtual or nonvirtual bus to match the type of bus specified for the Inport block it feeds. Bus signal outputs are virtual or nonvirtual, based on the specification for the Outport block. For bus signals driving a root-level Outport block, Simulink performs a similar conversion. For more information, see “Bus Data Crossing Model Reference Boundaries” on page 63-142.

The conversion consists of inserting hidden Signal Conversion blocks into the model where needed. If no bus object is specified at the port to which the virtual bus connects, conversion to a nonvirtual bus fails.

To avoid the need for automatic bus conversion, manually insert a Signal Conversion block. For details, see the Signal Conversion documentation.

### See Also

#### Blocks

Signal Conversion

#### Classes

Simulink.Bus | Simulink.BusElement

### Related Examples

- “Use Buses for Inports and Outports” on page 63-95
- “Bus Data Crossing Model Reference Boundaries” on page 63-142

## Buses and Libraries

When you define a library block, the block can input, process, and output buses just as an ordinary subsystem can.

Provide the appropriate input bus signal if:

- You have a bus routing block (Bus Creator, Bus Selector, or Bus Assignment) block that is in a library.
- That block depends on signals that are input to the library.

To change that block in a library, perform these steps. For details about modifying library links, see “Libraries”.

- 1 Copy the library block that uses that block to a model that connects an input bus.
- 2 Disable the link to the library block in this model.
- 3 Edit the bus routing block within the context of the outside model.
- 4 Resolve the link to the library.
- 5 In the Link Tool, in **Push/Restore Mode**, select **PUSH** to place the edited content into the library.
- 6 Save the library.

Alternatively, to have the library supply an appropriate bus signal, use a bus object to lock in the data type at the interface of a library subsystem block.

### Related Examples

- “Linked Blocks” on page 39-15
- “Getting Started with Buses” on page 63-16

### More About

- “Overview of Composite Signal Techniques” on page 63-3
- “Buses” on page 63-3

## Buses in the Generated Code

If you have Simulink Coder, the various techniques for defining buses are essentially equivalent for simulation, but the techniques can make a significant difference in the efficiency, size, and readability of generated code. For example, a nonvirtual bus appears as a structure in generated code, and only one copy exists of any algorithm that uses the bus. The use of a structure in the generated code can be helpful when tracing the correspondence between the model and the code. For example, here is the generated code for the Bus Creator block in the `ex_bus_logging` model.

```

50
51     /* BusCreator: '<Root>/COUNTERBUSCreator' incorporates:
52      * BusCreator: '<Root>/LIMITBUSCreator'
53      * Constant: '<Root>/lower_saturation_limit'
54      * Constant: '<Root>/upper_saturation_limit'
55      */
56     ex_bus_logging_B.COUNTERBUS_n.data = rtb_data;
57     ex_bus_logging_B.COUNTERBUS_n.limits.upper_saturation_limit = 40;
58     ex_bus_logging_B.COUNTERBUS_n.limits.lower_saturation_limit = 0;
59

```

A virtual bus does not appear as a structure or any other coherent unit in generated code. A separate copy of any algorithm that manipulates the bus exists for each element. In general, virtual buses do not affect the generated code.

To group signals into structures in the generated code, use nonvirtual buses. See “Group Signals into Structures in the Generated Code Using Buses” (Simulink Coder).

When you create a MATLAB structure to initialize a bus that contains non-double signal elements, you need to set the values of structure fields. The technique that you choose to set the values can influence the efficiency and readability of the generated code. See “Control Data Types of Initial Condition Structure Fields” on page 63-148.

When you generate code for a bus signal that is input to or output from a referenced model, there are some code generation limitations. See “Limitations for Virtual Buses Crossing Model Reference Boundaries” on page 63-154.

Code generation for array of buses signals produces structures with a specific format. See “Code Generation for Arrays of Buses” on page 63-155.

## Control Data Types of Initial Condition Structure Fields

You can use a MATLAB structure to initialize the signal elements in a bus. See “Specify Initial Conditions for Bus Signals” on page 63-99.

If the signal elements of the target bus use numeric data types other than `double`, in general:

- To avoid manually matching the field data types with the data types of the signal elements, use untyped expressions to set the field values. As you develop and rapidly prototype a model, use this technique for convenience.
- To generate more efficient production code and to avoid floating-point storage in the code, match the data types of the structure fields with the data types of the corresponding signal elements.

The technique that you choose can influence the efficiency and readability of the generated code.

For examples and more information about tunable initial conditions in the generated code, see “Control Signal and State Initialization in the Generated Code” (Simulink Coder).

### Inline Numeric Values of Structure Fields in the Generated Code

If you set **Configuration Parameters > Optimization > Signals and Parameters > Default parameter behavior** to `Inlined`, by default, the field values of the initial condition structure appear in the generated code as inlined numbers (non-tunable). For these structures, use untyped expressions to set the field values in Simulink. The field values do not require data types because the structure is not tunable in the generated code.

However, if you later set **Default parameter behavior** to `Tunable` or apply a storage class to the structure by using a `Simulink.Parameter` object, the code can contain floating-point storage and inefficient explicit typecasts and bit shifts. To avoid these issues, consider matching the data types of the structure fields with the data types of the corresponding signal elements.

### Generate Tunable Structure Specified Directly in a Block Dialog Box

Suppose that you specify an initial condition structure directly in a block dialog box, or in a `Simulink.Signal` object, with an expression such as



`struct('signal1',5,'signal2',7.2)` (instead of storing the structure in a variable or `Simulink.Parameter` object). In this case, to generate a tunable structure in the code, you set **Default parameter behavior** to `Tunable`.

Use the table to decide how to control the data types of the fields in these initial condition structures.

Goal		Technique
Use a nonvirtual bus.		Use untyped expressions to set the field values.
Use a virtual bus.	Avoid manually matching the field data types with those of the signal elements.	Use untyped expressions to set the field values.
	Generate more efficient code and avoid floating-point storage.	Match the structure field data types with the signal element types. Store the data type information in the <code>struct</code> by using typed expressions to set the field values.

### Generate Tunable Structure Stored in a Variable or Parameter Object

Suppose that you store an initial condition structure in a variable or `Simulink.Parameter` object that you create in the base workspace or a data dictionary. For example, you use this technique to share the structure between multiple blocks, or to generate a tunable structure when you set **Default parameter behavior** to `Inlined`. In this case, use the table to decide how to control the data types of the fields in the initial condition structure.

Goal		Technique
Avoid manually matching the field data types with those of the signal elements.		Use untyped expressions to set the field values. In the generated code, the structure fields use the data type <code>double</code> . The generated algorithm uses explicit typecasts to reconcile the data type mismatches.
Generate more efficient code and avoid floating-point storage.		Match the structure field data types with the signal element types. Store the data type information in the structure fields or use a <code>Simulink.Bus</code> object to control the data types of the fields and the signal elements simultaneously.

Goal	Technique
	To use the Model Advisor to check your model for potentially expensive data type mismatches, see “Check structure parameter usage with bus signals”.
Initialize an array of buses in a referenced model by using an array of structures. Pass the array of structures to the referenced model as the value of a model argument in the Model block.	<p>Match the structure field data types with the signal element types. Store the data type information in the structure fields or use a <code>Simulink.Bus</code> object to control the data types of the structure fields and the signal elements simultaneously.</p> <p>If you do not pass the structure to the referenced model as a model argument, follow the other guidelines for nonvirtual buses to decide how to control the data types.</p>

### Use Untyped Expressions to Set Field Values

You can use untyped expressions to set the structure field values. The fields implicitly use the data type `double`. Set the field values to represent the ideal, real-world initialization values.

You avoid manually matching the field data types with the data types of the corresponding signal elements. However, depending on the virtuality of the bus signal, the method that you use to apply the initial condition, and other factors, you can introduce floating-point storage and potentially inefficient typecasts in the generated code.

Suppose that you create a bus signal `myBusSig` with these signal elements. Each element uses a specific data type.

```
myBusSig
    signalElement1 (int32)
    signalElement2 (boolean)
    signalElement3 (single)
```

Create an initial condition structure `initStruct`. Use untyped expressions to specify the field values. Optionally, to enhance readability of the Boolean field `signalElement2`, use the value `false` instead of `0`.

```
initStruct.signalElement1 = 3;
initStruct.signalElement2 = false;
initStruct.signalElement3 = 17.35;
```

If you use the function `Simulink.Bus.createMATLABStruct` to create the structure, the function stores data type information in the structure fields. After you create the structure, you can optionally use untyped expressions to change the field values. See “Use `Simulink.Bus.createMATLABStruct` to Create Structure” on page 63-152.

### Store Data Type Information in Structure Fields

To store data type information in the structure fields, use typed expressions to set the field values, or use the function `Simulink.Bus.createMATLABStruct` to create the structure. Use these techniques to generate efficient code by eliminating floating-point storage and potentially inefficient explicit typecasts.

To avoid manually applying new data types to the structure fields when you change the data types of the corresponding signal elements, consider using a `Simulink.Bus` object to control the data types in the structure and the bus simultaneously.

### Use Typed Expressions to Set Field Values

Suppose that you create a bus signal `myBusSig` with this hierarchy of signal elements. Each element uses a specific data type.

```
myBusSig
    signalElement1 (int32)
    signalElement2 (boolean)
    signalElement3 (single)
```

Create an initial condition structure `initStruct` by using typed expressions to set the field values. Match the data types of the fields with the data types of the corresponding signal elements.

```
initStruct.signalElement1 = int32(3);
initStruct.signalElement2 = false;
initStruct.signalElement3 = single(17.35);
```

The structure fields store data type information. If you later change the data type of a signal element, manually apply the new data type to the corresponding structure field.

To match a fixed-point data type, set the field value by using a `fi` object.

### Change Field Value by Preserving Data Type Information

Suppose that you change the value of a field in an existing initial condition structure. To preserve the data type information in the field you can use subscripted assignment, with the syntax `(:)`.

```
initStruct.signalElement3(:) = 16.93;
```

If you do not use subscripted assignment, you must remember to preserve the data type by using a typed expression.

```
initStruct.signalElement3 = single(16.93);
```

If you do not use either of these techniques, the field loses the data type information.

```
initStruct.signalElement3 = 16.93; % Field data type is now 'double'.
```

### **Use Simulink.Bus.createMATLABStruct to Create Structure**

You can use the function `Simulink.Bus.createMATLABStruct` to create a structure whose fields all have ground values, typically 0. If you configure the data types of the signal elements before using the function, for example by setting the output data types of the blocks that generate the signal elements, each field in the output structure uses the same data type as the corresponding signal element. The fields store the data type information as if you use typed expressions to set the values.

You can initialize some of the signal elements with a value other than ground by passing a partial structure to the function. When you create this partial structure, match the data type of each field with the data type of the corresponding signal element by using typed expressions. For more information and examples, see `Simulink.Bus.createMATLABStruct`.

When you later change the value of a field in the structure, choose one of these techniques to set the new value:

- Untyped expression. The field value no longer stores the data type information.
- Typed expression or subscripted assignment. The field value continues to store the data type information.

### **Use Bus Object as Data Type of Initial Condition Structure**

Whether you store data type information in the structure fields or use untyped expressions to set the field values, you can use a `Simulink.Bus` object as the data type of the entire initial condition structure. You can then manage the field values and data types independently.

If you use this technique, consider using untyped expressions to set the field values. Then, you do not need to match the field data types manually when you change the

data types of the signal elements. To control the data types of the fields and the signal elements, use the `DataType` property of the elements in the bus object.

Suppose that you use a Bus Creator block to create a bus signal `myBusSig` with these signal elements.

```
myBusSig
  signalElement1 (int32)
  signalElement2 (boolean)
  signalElement3 (single)
```

- 1 Open the Bus Editor.

```
buseditor
```

- 2 Create a bus object, `myBus`, that corresponds to the bus signal.

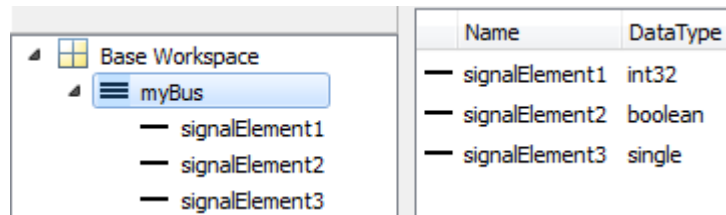

- 3 Create an initial condition structure `initStruct`. Used untyped expressions to set the field values. To enhance readability of the field `signalElement2`, use the Boolean value `false` instead of `0`.

```
initStruct.signalElement1 = 3;
initStruct.signalElement2 = false;
initStruct.signalElement3 = 17.35;
```

- 4 To represent the structure, create a `Simulink.Parameter` object.

```
initStruct = Simulink.Parameter(initStruct);
```

- 5 Use the parameter object to specify an initial condition for the bus signal. For example, in a Unit Delay block dialog box, set **Initial condition** to `initStruct`.
- 6 Use the bus object to specify the data type of the parameter object.

```
initStruct.DataType = 'Bus: myBus';
```

- 7 Use the bus object to specify the data type of the bus signal. For example, in the Bus Creator block dialog box, set **Output data type** to `Bus: myBus`.

During simulation and in the generated code, the structure fields and the signal elements use the data types that you specify in the bus object. Before simulation and code generation, the parameter object casts the structure fields to the data types that you specify in the bus object.

For basic information about bus objects, see “When to Use Bus Objects” on page 63-59.

### **Configure Data Types for Existing Structure**

To remove data type information from all the fields of a structure, you can write a custom function that replaces the field values with `double` numbers. Use the example function `castStructToDbl` as a template.

To convert a structure that uses doubles to one that stores data type information, you can create a reference structure using the function `Simulink.Bus.createMATLABStruct`. You can then write a custom function to cast the field values to the data types in the reference structure. Use the example function `castStructFromDbl` as a template.

### **Check for Mismatched Data Types with Model Advisor**

To detect when the data types of structure fields are not consistent with the associated bus signal elements, in the Simulink Editor, use the **Analysis > Model Advisor > By Product > Simulink “Check structure parameter usage with bus signals”** check.

## **Limitations for Virtual Buses Crossing Model Reference Boundaries**

If you use a bus signal as an input to or an output from a referenced model (Model block):

- You cannot configure the `I/O arguments step method` style of C++ class interface for the referenced model.

As a workaround, use a nonvirtual bus instead. Alternatively, use the `Default` style of C++ class interface.

- You cannot configure function prototype control for the referenced model.

As a workaround, use a nonvirtual bus instead.

For more information about using buses as inputs to or outputs from a referenced model, see “Bus Data Crossing Model Reference Boundaries” on page 63-142. For more information about bus virtuality, see “Virtual and Nonvirtual Buses” on page 63-4.

## Code Generation for Arrays of Buses

When you generate code for a model that includes an array of buses, a `typedef` that represents the underlying bus type appears in the `*_types.h` file.

Code generation produces an array of C structures that you can integrate with legacy C code that uses arrays of structures. As necessary, code for bus variables (arrays) is generated in the following structures:

- Block IO
- States
- External inputs
- External outputs

Here is a simplified example of some generated code for an array of buses.

```
typedef struct {
    real_T a;
    real_T b;
} BusObject;
/* Block signals (auto storage) */
typedef struct {
    BusObject ForEachSubsystem_IterInp_0[2];
} BlockIO_aob1;
```

For basic information about code generation for nonvirtual buses, which appear in the code as structures, see “Group Signals into Structures in the Generated Code Using Buses” (Simulink Coder).

## Related Examples

- “Group Signals into Structures in the Generated Code Using Buses” (Simulink Coder)
- “Bus Data Crossing Model Reference Boundaries” on page 63-142
- “Generate Code for Buses” on page 63-22
- “Virtual and Nonvirtual Buses” on page 63-4
- “Specify Sample Times for Signal Elements” on page 63-57





# Working with Variable-Size Signals

---

- “Variable-Size Signal Basics” on page 64-2
- “Simulink Models Using Variable-Size Signals” on page 64-7
- “S-Functions Using Variable-Size Signals” on page 64-21
- “Simulink Block Support for Variable-Size Signals” on page 64-24
- “Variable-Size Signal Limitations” on page 64-28

## Variable-Size Signal Basics

### In this section...

“About Variable-Size Signals” on page 64-2

“Creating Variable-Size Signals” on page 64-2

“How Variable-Size Signals Propagate” on page 64-3

“Programmatically Determine Whether Signal Line Has Variable Size” on page 64-4

“Empty Signals” on page 64-5

“Subsystem Initialization of Variable-Size Signals” on page 64-5

### About Variable-Size Signals

A Simulink signal can be a scalar, vector (1-D), matrix (2-D), or N-D. For information about these types of signals, see “Signal Basics” on page 62-2 in the *Simulink User's Guide*.

A Simulink variable-size signal is a signal whose size (the number of elements in a dimension), in addition to its values, can change during a model simulation. However, during a simulation, the number of dimensions cannot change. This capability allows you to model systems with varying resources, constraints, and environments.

### Creating Variable-Size Signals

You can create variable-size signals in your Simulink model by using:

- Switch or Multiplex blocks with different input ports having fixed-size signals with different sizes. The output is a variable-size signal.
- A selector block and the **Starting and ending indices (port)** indexing option. The index port signal can specify different subregions of the input data signal which produce an output signal of variable size as the simulation progresses.
- The S-function block with the output port configured for a variable-size signal. The output includes not only the values but also the dimension of the signal.

## How Variable-Size Signals Propagate

In the Simulink environment, variable-size signals can change their size during model execution in one of two ways:

- **At every step of model execution.**

Various blocks in the model modify the sizes of the signals during execution of the output method.

- **Only during initialization of conditionally executed subsystems.**

Size changes occur during distinct mode-switching events in subsystems such as Action, Enable, and Function-Call subsystems.

You can see the key difference by considering a Discrete 2-Tap Filter block with states.

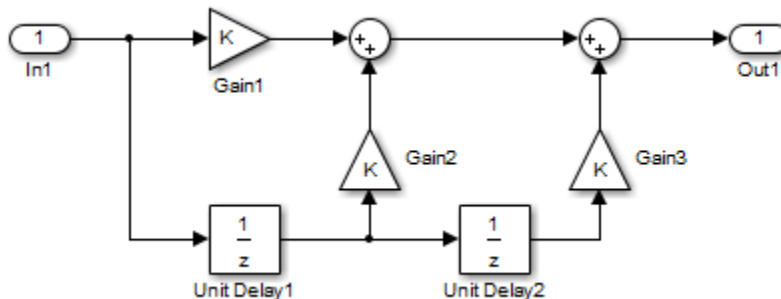

### Discrete 2-Tap Filter

Assume that the input signal dimension to this filter changes from 4 to 1 during simulation. It is ambiguous when and how the states of the Unit Delay blocks should adapt from 4 to 1 to continue processing the input. To ensure consistency, both Unit Delay blocks must change their state behavior synchronously. To prevent ambiguity, Simulink generally disallows blocks whose number of states depends on input signal sizes in contexts where signal sizes change at any point during execution.

In contrast, consider the same Discrete 2-Tap Filter block in a Function-Call subsystem. Assume that this subsystem is using the second way to propagate variable-size signals. In this case, the size of the input signal changes from 4 to 1 only at the initialization

of the subsystem. At initialization, the subsystem resets all of its states (including the states of the two Unit Delay blocks) to their initial values. Resetting the subsystem ensures no ambiguity on the assignment of states to the input signal of the filter.

“Mode-Dependent Variable-Size Signals” on page 64-15 shows how you can use the two ways of propagating variable-size signals in a complementary fashion to model complex systems.

## Programmatically Determine Whether Signal Line Has Variable Size

This example shows how to use commands at the command prompt or in a script to determine whether a signal line has a variable size. In a large model or hierarchy of subsystems or referenced models, use this technique to determine whether a signal has a variable size due to an upstream block.

The example model `sldemo_varsize_basic` contains a signal `a` that is downstream of a Switch block. Use commands at the command prompt to determine whether `a` has a variable size.

- 1 Open the example model.
- 2 Select the Sum block whose output signal is labeled `a`.
- 3 At the command prompt, set the model to a compiled state (similar to a diagram update).

```
sldemo_varsize_basic([],[],[],'compile')
```

- 4 Get a handle to the block output port.

```
portHandles = get_param(gcf,'portHandles');  
outPortHandle = portHandles.Outport;
```

- 5 Query the programmatic parameter `CompiledPortDimensionsMode` of the output port.

```
varSize = get_param(outPortHandle,'CompiledPortDimensionsMode')
```

```
varSize =
```

```
1
```

The value of the variable `varSize` is 1, which indicates that the signal `a` has variable size.

The value 0 indicates that a signal does not have variable size.

- 6 Terminate the model compilation.

```
sldemo_varsize_basic([],[],[], 'term')
```

## Empty Signals

An empty signal is a signal with a length of 0. For example, signals with size [0], [0x3], [2x0], and [2x0x3] are all empty signals. Simulink allows empty signals with variable-size signals and supports most element-wise operations. However, Simulink does not support empty signals for blocks that modify signal dimensions. Unsupported blocks include Reshape, Permute, and Sum along a specified dimension.

## Subsystem Initialization of Variable-Size Signals

The initial signal size from an Outputport block in a conditionally executed subsystem varies depending on the parameters you select.

If you set the **Propagate sizes of variable-size signals** parameter in the parent subsystem to **During execution**, the **Initial output** parameter for the Output block must not exceed the maximum size of the input port. If the **Initial output** parameter value is:

Initial output parameter	Initial output signal size
A nonscalar matrix	The initial output signal size is the size of the <b>Initial output</b> parameter.
A scalar	The initial output signal size is a scalar.
The default []	The initial output size is an empty signal (dimensions are all zeros).

If you set the **Propagate sizes of variable-size signals** parameter in the parent subsystem to **Only when enabling**, the **Initial output** parameter for the Output block must be a scalar value.

- When size is repropagated for the input of the Outputport block, the initial output value is set using scalar expansion from the scalar parameter value.
- If the **Initial output** parameter is the default value [], Simulink treats the initial output as a grounded value.

- If the model does not activate the parent subsystem at start time ( $t = 0$ ), the current size of the subsystem output corresponding to the Outport block is set to maximum size.
- When its parent subsystem repropagates signal sizes, the values of the subsystem variable-size output signals are also reset to their initial output parameter values.

### **Related Examples**

- “Signal Basics” on page 62-2
- “Simulink Models Using Variable-Size Signals” on page 64-7
- “S-Functions Using Variable-Size Signals” on page 64-21
- “Simulink Block Support for Variable-Size Signals” on page 64-24
- “Variable-Size Signal Limitations” on page 64-28

## Simulink Models Using Variable-Size Signals

### In this section...

“Variable-Size Signal Generation and Operations” on page 64-7

“Variable-Size Signal Length Adaptation” on page 64-11

“Mode-Dependent Variable-Size Signals” on page 64-15

### Variable-Size Signal Generation and Operations

This example model shows how to create a variable-size signal from multiple fixed-size signals and from a single data signal. It also shows some of the operations you can apply to variable-size signals.

For a complete list of blocks that support variable-size signals, see “Simulink Block Support for Variable-Size Signals” on page 64-24.

- 1 In the MATLAB Command Window, type  
`sldemo_varsize_basic`
- 2 In the Simulink Editor, select **Display > Signals & Ports > Signal Dimensions**. Run a simulation or press **Ctrl-D**.

The Simulink Editor displays the signal dimensions and line styles. See “Signal Basics” on page 62-2 for an interpretation of signal line styles.

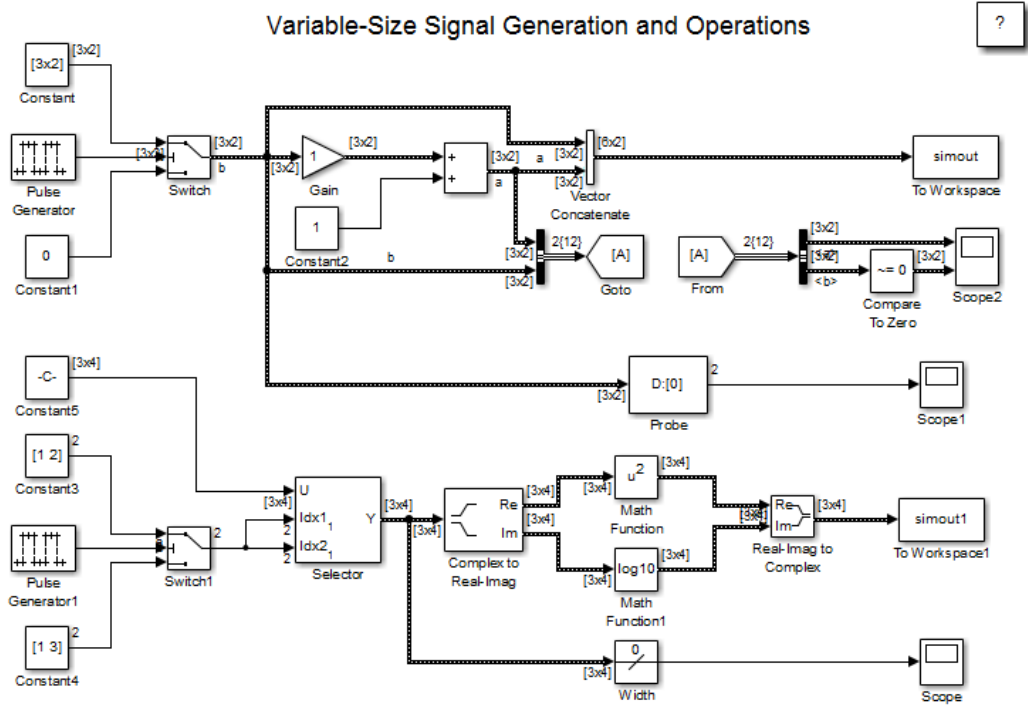

### Creating a Variable-Size Signal from Fixed-Size Signals

One way to create a variable-size signal is to use the Switch block. The input signals to the Switch block can differ in their number of dimensions and in their size.



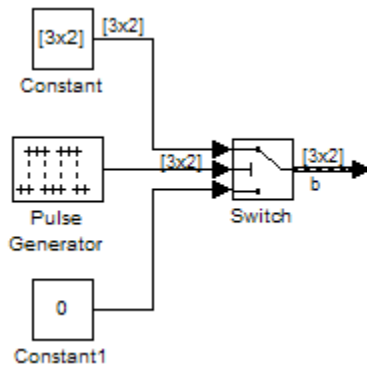

Output from the Switch block is a 2-D variable-size signal with a maximum size of  $3 \times 2$ . When you select the **Allow different data input sizes** parameter on the Switch block, Simulink does not expand the scalar value from the Constant1 block.

### Saving Variable-Size Signal Data

You could add a To Workspace block to the output from the Switch block. Since the model already has a To Workspace block, the second To Workspace block would save data to a signal array named `simout2`. The `values` field logs the actual signal values. If logged signal data is smaller than the maximum size, values are padded with NaNs or appropriate values. To obtain these signal values, type:

```
simout2.signals.values
```

```
ans(:,:,1) =
```

```
    1    -1
   -2     2
   -3     3
```

```
ans(:,:,2) =
```

```
    1    -1
   -2     2
   -3     3
```

```
ans(:,:,3) =
```

```

0    NaN
NaN  NaN
NaN  NaN

```

The `valueDimensions` field logs the dimensions of a variable-size signal. To obtain the dimensions, type:

```
simout2.signals.valueDimensions
```

The signal dimensions for the first three time steps are shown.

```
ans =
```

```

3    2
3    2
1    1

```

### Creating a Variable-Size Signal from a Single Data Signal

The data signal (Constant5) is a  $3 \times 4$  matrix. The Pulse Generator represents a control signal that selects a starting and ending index value ( $[1 \ 2]$  or  $[1 \ 3]$ ). The Selector block then uses the index values to select different parts of the data signal at each time step and output a variable-size signal.

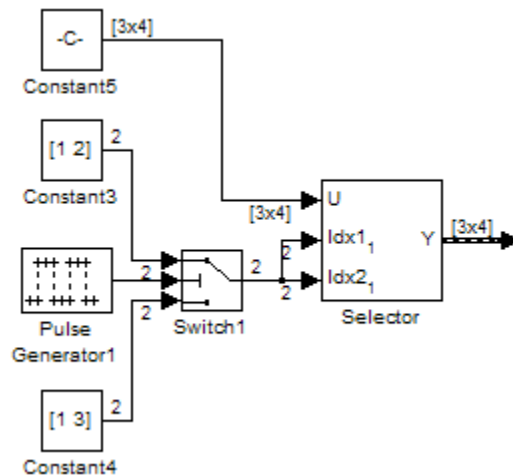

## Viewing Changes in Signal Size

The output from the Selector block is either a 2x2 or 3x3 matrix. Because the maximum dimension for a variable-size signal is the 3x4 matrix from the data signal, the logged output signals are padded with NaNs.

Use the Probe or Width blocks to inspect the current dimensions and width of a variable-size signal. In addition, you can display variable-size signals on Scope blocks and save variable-size signals to the workspace using the To Workspace block.

## Processing Variable-Size Signals

The remainder of the model shows various operations that are possible with variable-size signals. Operations include using the Gain block, the Sum block, the Math Function block, the Matrix Concatenate block. You can connect variable-size signals with the From, Goto, Bus Assignment, Bus Creator, and Bus Selector blocks.

## Variable-Size Signal Length Adaptation

This example model corresponds to a hypothetical system where the model adapts the length of a signal over time. Length adaptation is based on the value of a control signal. When the control signal falls within one of three predefined ranges, the fixed-size raw data signal changes to a variable-size data signal.

The variable-size signal connects to a processing block, where blocks that support variable-size signals operate on it. A MATLAB Function block with both input and output signals of variable size allow more flexibility than other blocks supporting variable-size signals. See “Simulink Block Support for Variable-Size Signals” on page 64-24.

To open the example model, in the MATLAB Command Window, type:

```
sldemo_varsize_dataLengthAdapt
```

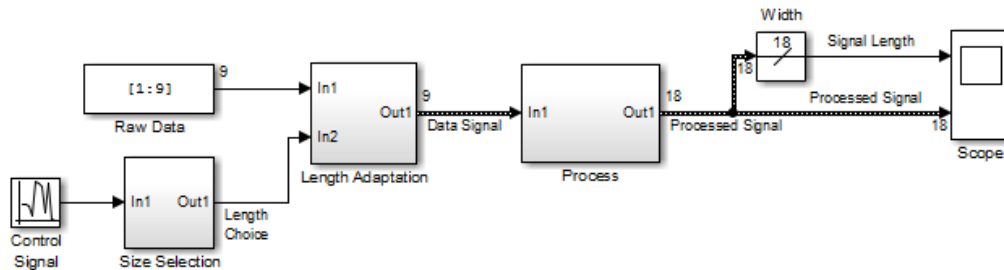

### Creating a Variable-Size Signal by Adapting the Length of a Data Signal

This model generates a data signal and converts the signal to a variable-size signal. The size of the signal depends on the value of a control signal. The raw data signal is a column vector with values from 1 to 9.

```
[1:9].'
```

```
ans =
```

```
1
2
3
4
5
6
7
8
9
```

The Size Selection subsystem determines the quality of the data signal and outputs a quality value ( 1, 2, or 3). This value helps to select the length of the data signal in the Length Adaptation subsystem.

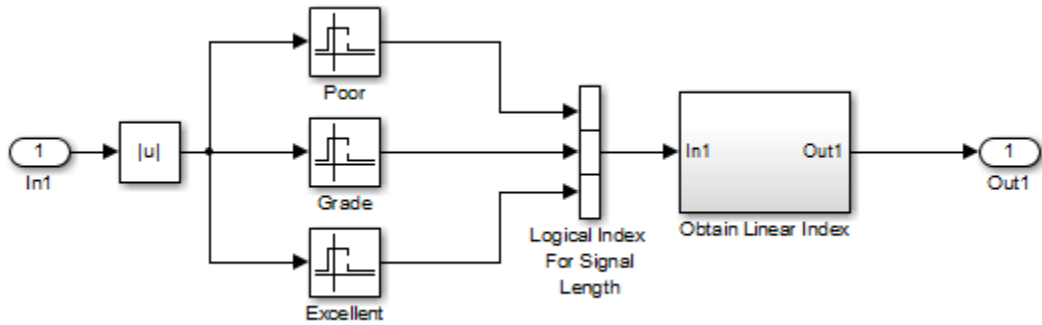

In the Length Adaptation subsystem, the Signal Size subsystem generates an index based on the quality value from the Size Selection subsystem (In2). The Data Selector block uses the starting and ending indices to adapt the length of the data signal (In1) and output a variable-size signal.

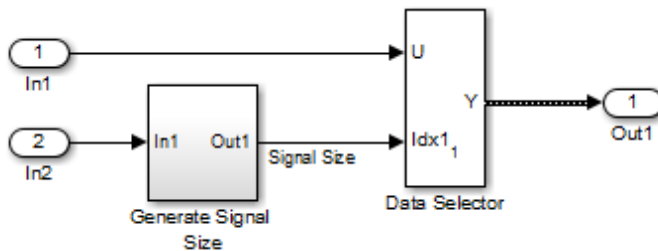

### Processing a Variable-Size Signal

The center section of the model processes the variable-size signal. The MATLAB Function block adds zeros between the data values in a way that is similar to upsampling a signal. The dimension of the signal changes from 9 to 18. The Math Function blocks shows various manipulations you can do with variable-size signals.

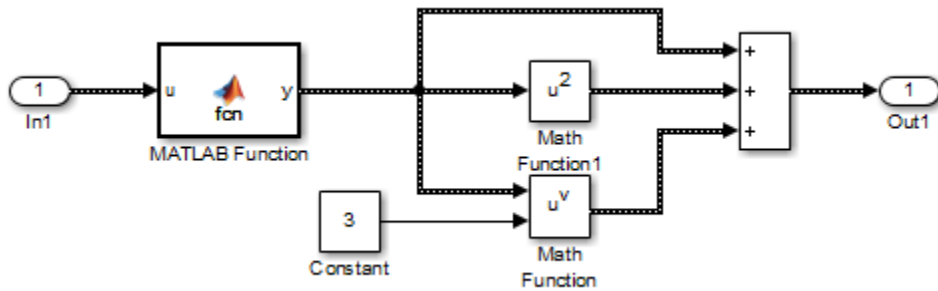

### Visualizing a Variable-Size Signal

The right section of the model determines the signal width (size) and uses a scope to visualize the width and the processed data signal.

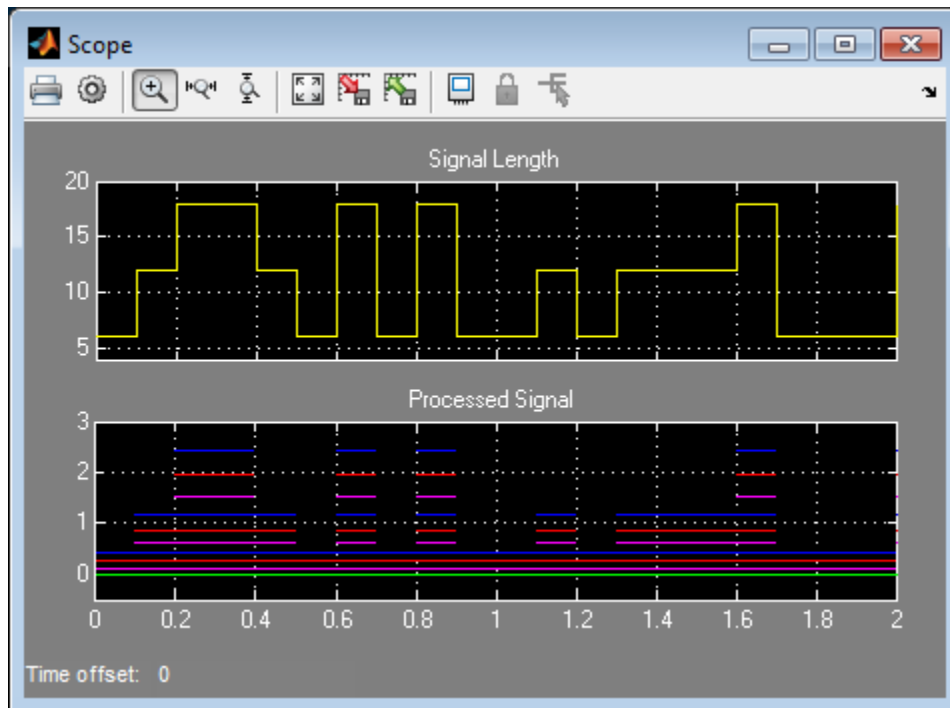

## Mode-Dependent Variable-Size Signals

This example model represents a system that has three operation modes. For each mode, the data signal to process has a different size.

The Process subsystem in this model receives a variable-size signal where the size of the signal depends on the operation mode of the system. For each mode change, the Stateflow chart, Mode Control Logic, detects when the data signal size changes. It then generates a function call to reset the blocks in the Process subsystem.

To open the model, In the MATLAB Command Window, type:

```
sldemo_varsize_multimode
```

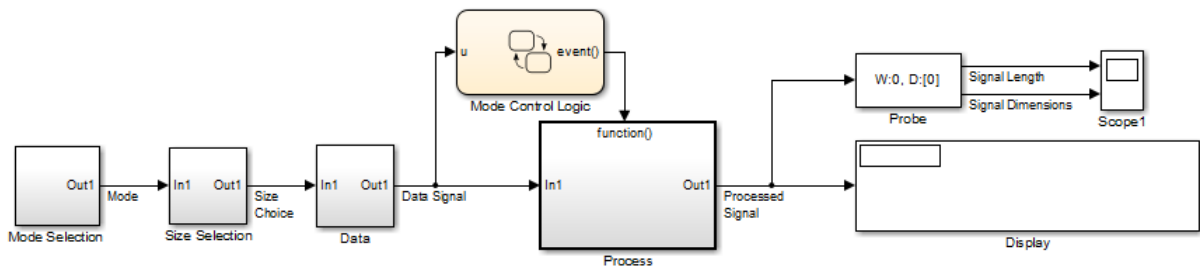

### Creating a Variable-Size Signal Based on Mode

The Mode Selection subsystem determines the mode for processing a data signal and outputs a mode value ( 1, 2, or 3). This value helps to select the length of the data signal using the Size Selection and Data subsystems.



The Size Selection subsystem creates an index value from the mode value. In this example, the index values are [1 3], [1 2], and [1 1].

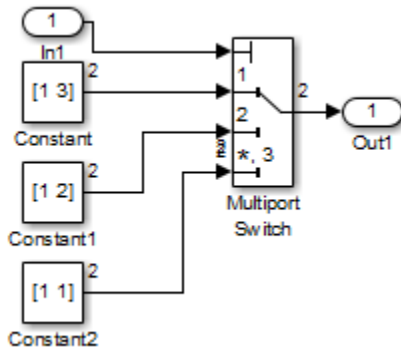

The Data subsystem takes a data signal (Constant block) and selects part of the data signal dependent on the mode. The output is a variable-size signal with a matrix size of 3x3, 2x2, and 1x1.

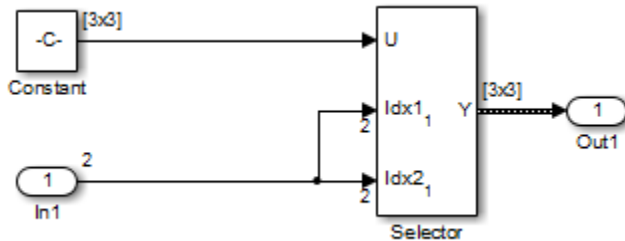

The dimensions of the raw data signal (Constant block) is a 3x3. After connecting a To Workspace block to a signal line, you can view the signal in the MATLAB Command Window by typing:

```
simout.signals.values
```

```
ans(:,:,1) =
```

```

1     4     7
2     5     8
3     6     9
```

The variable-size signal generated from the Data subsystem is also a 3x3 matrix. For shorter signals, the matrix is padded with NaNs.



```
simout.signals.values
```

```
ans(:,:,1) =
```

```
    1   NaN   NaN
   NaN   NaN   NaN
   NaN   NaN   NaN
```

```
ans(:,:,2) =
```

```
    1    4   NaN
    2    5   NaN
   NaN   NaN   NaN
```

```
ans(:,:,3) =
```

```
    1    4    7
    2    5    8
    3    6    9
```

### Processing a Variable-Size Signal with a Conditionally Executed Subsystem

Because the Process subsystem contains a Delay block, the subsystem resets and repropagates the signal at each time step. This model uses a Stateflow chart to detect a signal size change and reset the Process subsystem.

In the function block dialog, and from the **Propagate sizes of variable-size signals** list, choose **Only when enabling**. When the model enables this subsystem, selecting this option directs the Simulink software to propagate sizes for variable-size signals inside the conditionally executed subsystem. Signal sizes can change only when they transition from disabled to enabled. For an explanation of handling signal-size changes with blocks containing states, see “How Variable-Size Signals Propagate” on page 64-3.

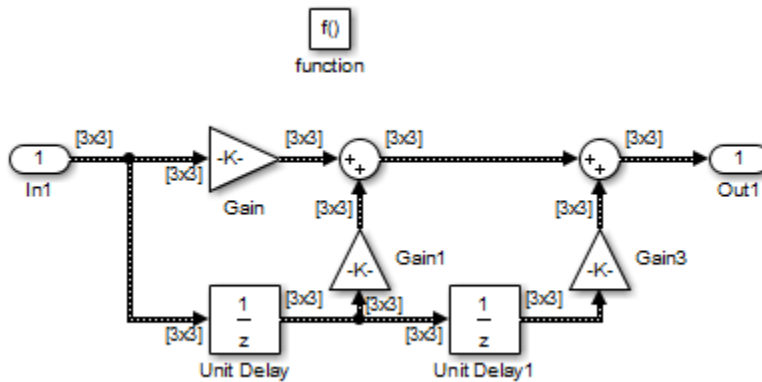

The Stateflow chart determines if there is a change in the size of the signal. The function `size_detect` calculates the width of the variable-size signal at each time step, and compares the current width to the previous width. If there is a change in signal size, the chart outputs a function-call output event that resets and repropagates the signal sizes within the Process subsystem.

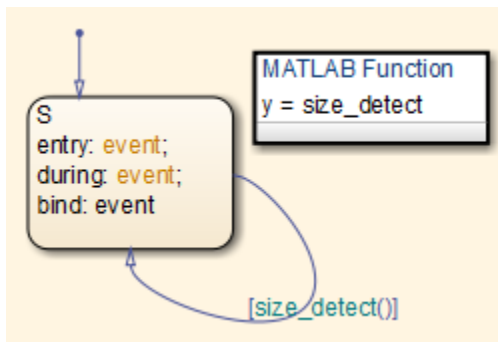

### Visualizing Data

Use the Probe block to visualize signal size and signal dimension.

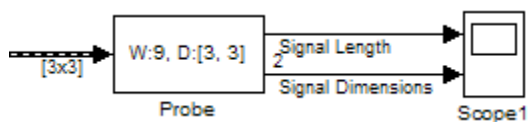

Since the signals are  $n \times n$  matrices, the signal dimension lines overlap in the Scope display.

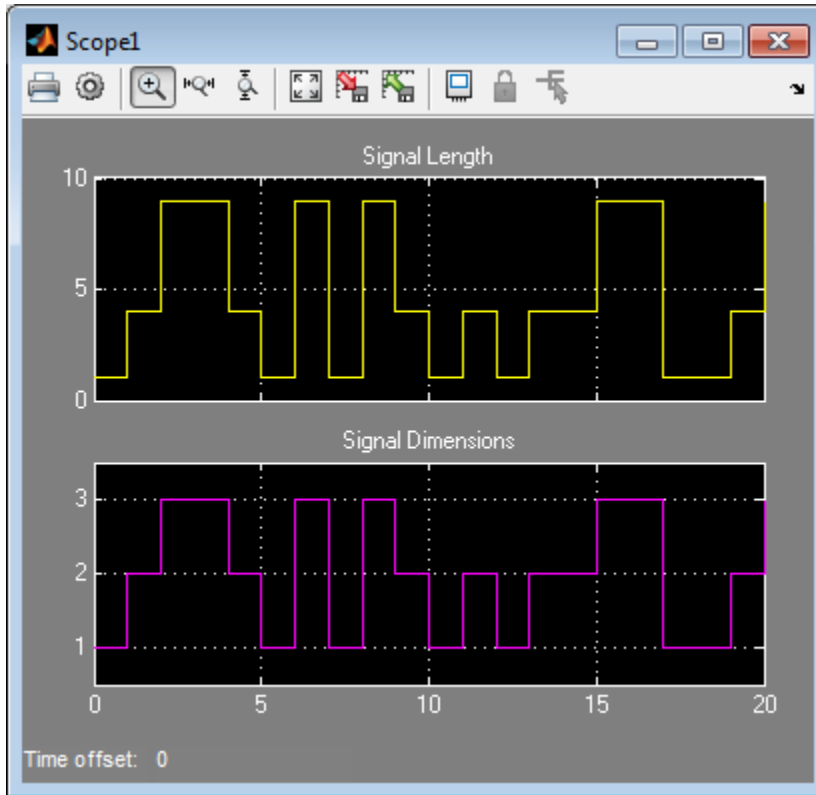

You can use a Display block and the Simulink Debugger to visualize signal values at each time step.

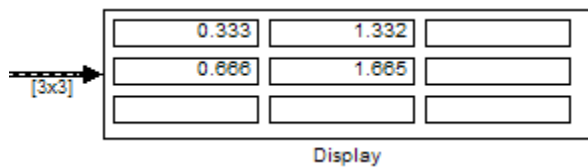

## **Related Examples**

- “Parallel Channel Power Allocation”
- “Variable-Size Signal Basics” on page 64-2
- “S-Functions Using Variable-Size Signals” on page 64-21
- “Simulink Block Support for Variable-Size Signals” on page 64-24
- “Variable-Size Signal Limitations” on page 64-28

## S-Functions Using Variable-Size Signals

### In this section...

“Level-2 MATLAB S-Function with Variable-Size Signals” on page 64-21

“C S-Function with Variable-Size Signals” on page 64-22

### Level-2 MATLAB S-Function with Variable-Size Signals

Both Level-2 MATLAB S-Functions and C S-Functions support variable-size signals when you set the **DimensionMode** for the output port to **Variable**. You also need to consider the current dimension of the input and output signals in the input and output update methods.

To open this example model, in the MATLAB Command Window, type:

```
msfcdemo_varsize
```

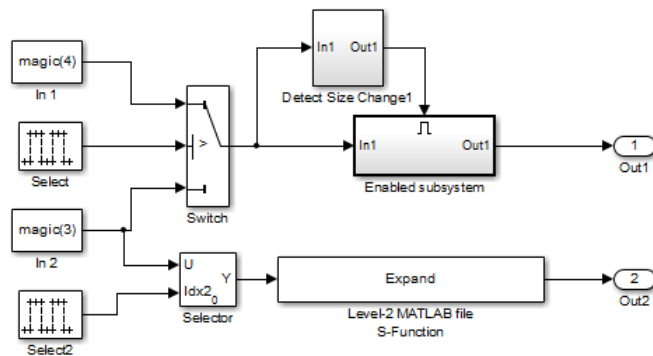

matlabroot\toolbox\simulink\simdemos\simfeatures\msfcn\_varsize\_expand.m

matlabroot\toolbox\simulink\simdemos\simfeatures\tlc\_c\msfcn\_varsize\_expand.tlc

matlabroot\toolbox\simulink\simdemos\simfeatures\msfcn\_varsize\_holdStatesUntilReset.m

matlabroot\toolbox\simulink\simdemos\simfeatures\tlc\_c\msfcn\_varsize\_holdStatesUntilReset.tlc

The Enabled subsystem includes a Level-2 MATLAB S-Function which shows how to implement a block that holds its states until reset. Because this block contains states and delays the input signal, the input size can change only when a reset occurs.

The Expand block is a Level-2 MATLAB S-Function that takes a scalar input and outputs a vector of length indicated by its input value. The output is by  $1:n$  where  $n$  is the input value.

## C S-Function with Variable-Size Signals

To open this example model, in the MATLAB Command Window, type:

```
sfcn_demo_varsize
```

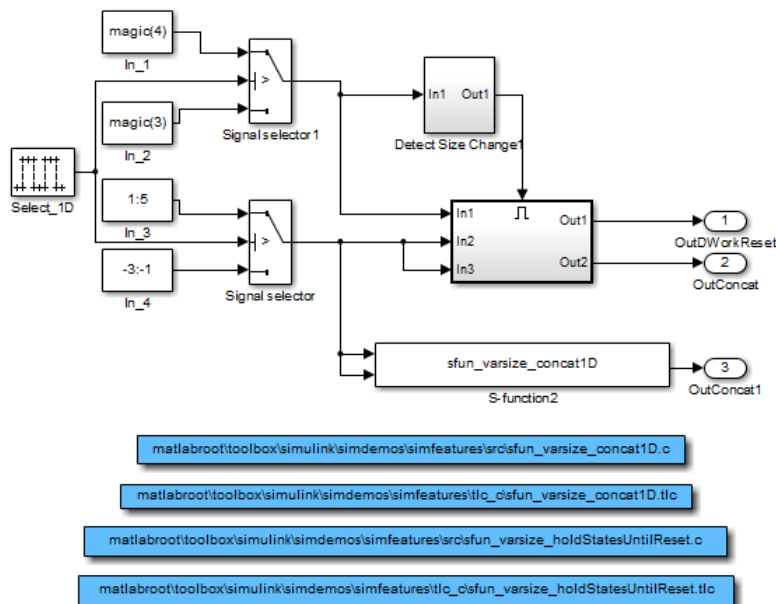

The enabled subsystems have two S-Functions:

- `sfun_varsize_holdStatesUntilReset` is a C S-Function that has states and requires its DWorks vector to reset whenever the sizes of the input signal changes.

- `sfun_varsize_concat1D` is a C S-function that implements the concatenation of two unoriented vectors. You can use this function within an enabled subsystem by itself.

## Related Examples

- “Variable-Size Signal Basics” on page 64-2
- “Simulink Models Using Variable-Size Signals” on page 64-7
- “Simulink Block Support for Variable-Size Signals” on page 64-24
- “Variable-Size Signal Limitations” on page 64-28

## Simulink Block Support for Variable-Size Signals

<b>In this section...</b>
“Simulink Block Data Type Support” on page 64-24
“Conditionally Executed Subsystem Blocks” on page 64-24
“Switching Blocks” on page 64-25

### Simulink Block Data Type Support

The Simulink Block Data Type Support table includes a complete list of blocks that support variable-size signals.

To view the table:

- 1 Open a Simulink model.
- 2 Select **Help > Simulink > Block Data Types & Code Generation Support > Simulink**.

An X in the **Variable-Size Support** column indicates support for that block.

---

**Tip:** You can also view the table by entering `showblockdatatypetable` at the command prompt.

---

### Conditionally Executed Subsystem Blocks

Control port blocks are in conditionally executed subsystems. You can set the **Propagate sizes of variable-size signals** parameter for these blocks to **During execution**, **Only when execution is resumed** (Action Port), and **Only when enabling** (Enable and Trigger or Function-Call).



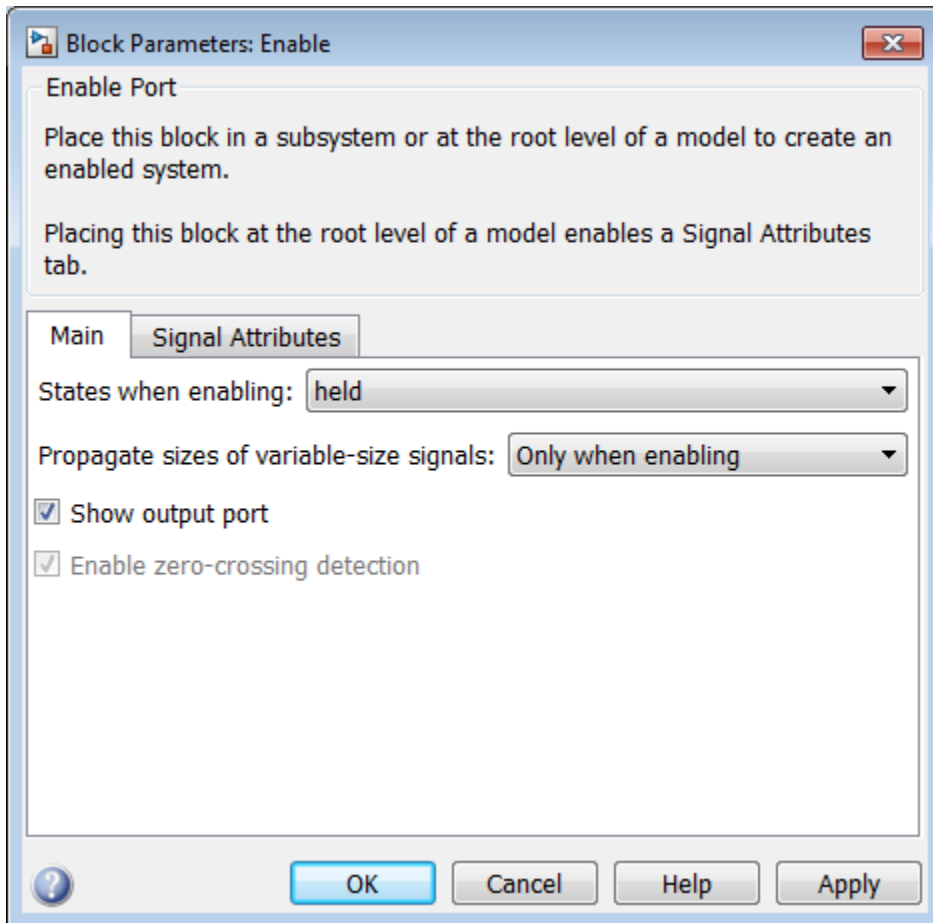

- Action Port
- Enable
- Trigger — **Trigger type** set to function-call

## Switching Blocks

Switching blocks support variable-size signals by allowing input signals with different sizes and propagating the size of the input signal to the output signal. You can set the **Allow different data input sizes** parameter for these blocks on the Signal Attributes pane to either on or off.

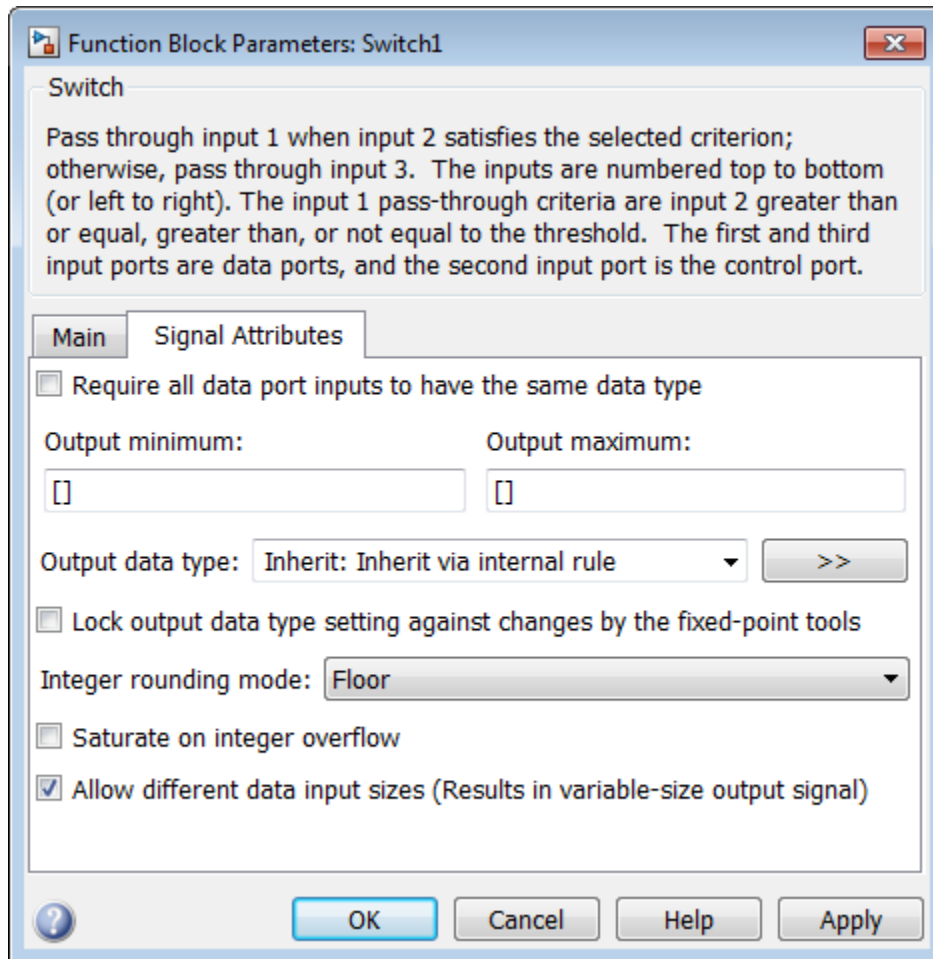

- Switch
- Multiport Switch
- Manual Switch

## Related Examples

- “Variable-Size Signal Basics” on page 64-2
- “Simulink Models Using Variable-Size Signals” on page 64-7

- “S-Functions Using Variable-Size Signals” on page 64-21
- “Variable-Size Signal Limitations” on page 64-28

## Variable-Size Signal Limitations

The following table is a list of known limitations and workarounds.

Limitation	Workaround
Array format logging does not support variable-size signals.	Use a <b>Structure</b> or <b>Structure With Time</b> format for logging variable-size signals.
Right-click signal logging does not support variable-size signals.	Use a <b>To Workspace</b> block (with <b>Structure</b> or <b>Structure With Time</b> format) or a root <b>Outport</b> block for logging variable-size signals.
A frame-based variable-size signal cannot change the frame length (first dimension size), but it can change the second dimension size (number of channels). Using frame-based signals requires DSP System Toolbox software.	Use the <b>Frame Conversion</b> block to convert a signal into sample-based signal.
Variable-size signals must have a discrete sample time.	—
Embedded Coder does not support variable-size signals with ERT S-functions, custom storage classes, function prototype control, the AUTOSAR, C++ interface, and the ERT reusable code interface.	—
Simulink does not support variable-size parameter or DWork vectors.	—
Rapid accelerator mode does not support models having root-level input ports with variable-size signals.	—
Virtual buses that you use as inputs to or outputs from a referenced model (Model block) do not support variable-size signals.	Configure the bus signal as nonvirtual. For more information about using buses as inputs to or outputs from a referenced model, see “Bus Data Crossing Model Reference Boundaries” on page 63-142. For more information about controlling

Limitation	Workaround
	bus virtuality, see “Virtual and Nonvirtual Buses” on page 63-4.
You cannot apply a storage class to a root-level Outport block (see “Use Model Data Editor to Configure Data Interface” (Simulink Coder)) if the signal that enters the block has a variable size.	Apply the storage class to the signal line instead of the Outport block.

## Related Examples

- “Variable-Size Signal Basics” on page 64-2
- “Simulink Models Using Variable-Size Signals” on page 64-7
- “S-Functions Using Variable-Size Signals” on page 64-21
- “Simulink Block Support for Variable-Size Signals” on page 64-24



# **Customizing Simulink Environment and Printed Models**





# Customizing the Simulink User Interface

---

- “Add Items to Model Editor Menus” on page 65-2
- “Disable and Hide Model Editor Menu Items” on page 65-16
- “Disable and Hide Dialog Box Controls” on page 65-18
- “Customize Library Browser Appearance” on page 65-23
- “Registering Customizations” on page 65-26

## Add Items to Model Editor Menus

### In this section...

“About Adding Items” on page 65-2  
“Code for Adding Menu Items” on page 65-2  
“Define Menu Items” on page 65-4  
“Register Menu Customizations” on page 65-10  
“Callback Info Object” on page 65-10  
“Debugging Custom Menu Callbacks” on page 65-11  
“Menu Tags” on page 65-11

### About Adding Items

You can add commands and submenus to these menu locations for the Simulink Editor and Stateflow Editor:

- The end of top-level menus
- The menu bar
- The beginning or end of a context menu

To add an item to an editor menu:

- For each item, create a function, called a *schema function*, that defines the item (see “Define Menu Items” on page 65-4).
- Register the menu customizations with the Simulink customization manager at startup, e.g., in an `sl_customization.m` file on the MATLAB path (see “Register Menu Customizations” on page 65-10).
- Create callback functions that implement the commands triggered by the items that you add to the menus.

### Code for Adding Menu Items

The following `sl_customization.m` file adds four items to the Simulink Editor’s **Tools** menu.

```
function sl_customization(cm)
    %% Register custom menu function.
```

```

    cm.addCustomMenuFcn('Simulink:ToolsMenu', @getMyMenuItems);
end

%% Define the custom menu function.
function schemaFcns = getMyMenuItems(callbackInfo)
    schemaFcns = {@getItem1,...
                 @getItem2,...
                 {@getItem3,3}... %% Pass 3 as user data to getItem3.
                 @getItem4};
end

%% Define the schema function for first menu item.
function schema = getItem1(callbackInfo)
    schema = sl_action_schema;
    schema.label = 'Item One';
    schema.userdata = 'item one';
    schema.callback = @myCallback1;
end

function myCallback1(callbackInfo)
    disp(['Callback for item ' callbackInfo.userdata ' was called']);
end

function schema = getItem2(callbackInfo)
    % Make a submenu label 'Item Two' with
    % the menu item above three times.
    schema = sl_container_schema;
    schema.label = 'Item Two';
    schema.childrenFcns = {@getItem1, @getItem1, @getItem1};
end

function schema = getItem3(callbackInfo)
    % Create a menu item whose label is
    % 'Item Three: 3', with the 3 being passed
    % from getMyItems above.

    schema = sl_action_schema;
    schema.label = ['Item Three: ' num2str(callbackInfo.userdata)];
end

function myToggleCallback(callbackInfo)
    if strcmp(get_param(gcs, 'ScreenColor'), 'red') == 0
        set_param(gcs, 'ScreenColor', 'red');
    else
        set_param(gcs, 'ScreenColor', 'white');
    end
end

%% Define the schema function for a toggle menu item.
function schema = getItem4(callbackInfo)
    schema = sl_toggle_schema;
    schema.label = 'Red Screen';
    if strcmp(get_param(gcs, 'ScreenColor'), 'red') == 1
        schema.checked = 'checked';
    else

```

```
    schema.checked = 'unchecked';  
end  
schema.callback = @myToggleCallback;  
end
```

## Define Menu Items

You define a menu item by creating a function that returns an object, called a *schema* object, that specifies the information needed to create the menu item. The menu item that you define may trigger a custom action or display a custom submenu. See the following sections for more information.

- “Defining Menu Items That Trigger Custom Commands” on page 65-4
- “Defining Custom Submenus” on page 65-7

### Defining Menu Items That Trigger Custom Commands

To define an item that triggers a custom command, your schema function must accept a callback info object (see “Callback Info Object” on page 65-10) and create and return an action schema object (see “Action Schema Object” on page 65-5) that specifies the item's label and a function, called a *callback*, to be invoked when the user selects the item. For example, the following schema function defines a menu item that displays a message when selected by the user.

```
function schema = getItem1(callbackInfo)  
  
    %% Create an instance of an action schema.  
    schema = sl_action_schema;  
  
    %% Specify the menu item's label.  
    schema.label = 'My Item 1';  
    schema.userdata = 'item1';  
    %% Specify the menu item's callback function.  
    schema.callback = @myCallback1;  
  
end  
  
function myCallback1(callbackInfo)  
    disp(['Callback for item ' callbackInfo.userdata  
        ' was called']);  
end
```

## Action Schema Object

This object specifies information about menu items that trigger commands that you define, including the label that appears on the menu item and the function to be invoked when the user selects the menu item. Use the function `sl_action_schema` to create instances of this object in your schema functions. Its properties include:

- `tag`

Optional character vector that identifies this action, for example, so that it can be referenced by a filter function.

- `label`

Character vector specifying the label that appears on a menu item that triggers this action.

- `state`

Property that specifies the state of this action. Valid values are 'Enabled' (the default), 'Disabled', and 'Hidden'.

- `statustip`

Character vector specifying text to appear in the editor's status bar when the user selects the menu item that triggers this action.

- `userdata`

Data that you specify. May be of any type.

- `accelerator`

Character vector specifying a **Ctrl** and key combination to use to trigger this action. You can add a keyboard shortcut only for custom menu items that appear on menu bar menus and cannot redefine accelerators that come with the Simulink Editor. For example, **Ctrl+D** is an accelerator for **Update Diagram** in the Simulink Editor, so you cannot redefine it.

To specify this value, use the form 'Ctrl+K', where *K* is the shortcut key. For example, use 'Ctrl+Alt+T' for an accelerator invoked by holding down **Ctrl** and **Alt** and pressing **T**.

- `callback`

Character vector specifying a MATLAB expression to be evaluated or a handle to a function to be invoked when a user selects the menu item that triggers this action. This function must accept one argument: a callback info object.

- `autoDisableWhen`

Property that controls when a menu item is automatically disabled.

Setting	When Menu Items Are Disabled
'Locked'	(default) When the active editor is locked or when the model is busy
'Busy'	Only if the model is busy
'Never'	Never

### Toggle Schema Object

This object specifies information about a menu item that toggles some object on or off. Use the function `sl_toggle_schema` to create instances of this object in your schema functions. Its properties include:

- `tag`

Optional character vector that identifies this toggle action, for example, so that it can be referenced by a filter function.

- `label`

Character vector specifying the label that appears on a menu item that triggers this toggle action.

- `checked`

Specify whether the menu item displays a check mark. Valid values are 'unchecked' (default) and 'checked'

- `state`

State of this toggle action, specified as 'Enabled' (default), 'Disabled', and 'Hidden'.

- `statustip`

Character vector specifying text to appear in the editor's status bar when the user selects the menu item that triggers this toggle action.

- `userdata`

Data that you specify. May be of any type.

- `accelerator`

Character vector specifying a **Ctrl** and key combination to use to trigger this action. You can add a keyboard shortcut only for custom menu items that appear on menu bar menus and cannot redefine accelerators that come with the Simulink Editor. For example, **Ctrl+D** is an accelerator for **Update Diagram** in the Simulink Editor, so you cannot redefine it.

To specify this value, use the form '`Ctrl+K`', where *K* is the shortcut key. For example, use '`Ctrl+Alt+T`' for an accelerator invoked by holding down **Ctrl** and **Alt** and pressing **T**.

- `callback`

Character vector specifying a MATLAB expression to be evaluated or a handle to a function to be invoked when a user selects the menu item that triggers this action. This function must accept one argument: a callback info object.

- `autoDisableWhen`

Property that controls when a menu item is automatically disabled.

Setting	When Menu Items Are Disabled
'Locked'	(default) When the active editor is locked or when the model is busy
'Busy'	Only if the model is busy
'Never'	Never

## Defining Custom Submenus

To define a submenu, create a schema function that accepts a callback info object and returns a container schema object (see “Container Schema Object” on page 65-8) that specifies the schemas that define the items on the submenu. For example, the following schema function defines a submenu that contains three instances of the menu

item defined in the example in “Defining Menu Items That Trigger Custom Commands” on page 65-4.

```
function schema = getItem2( callbackInfo )
    schema = sl_container_schema;
    schema.label = 'Item Two';
    schema.childrenFcns = {@getItem1, @getItem1, @getItem1};
end
```

### Container Schema Object

A container schema object specifies a submenu’s label and its contents. Use the function `sl_container_schema` to create instances of this object in your schema functions. Properties of the object include

- **tag**  
Optional character vector that identifies this submenu.
- **label**  
Character vector specifying the submenu’s label.
- **state**  
Character vector that specifies the state of this submenu. Valid values are 'Enabled' (the default), 'Disabled', and 'Hidden'.
- **statustip**  
Character vector specifying text to appear in the editor's status bar when the user selects this submenu.
- **childrenFcns**  
Cell array that specifies the contents of the submenu. Each entry in the cell array can be
  - A pointer to a schema function that defines an item on the submenu (see “Define Menu Items” on page 65-4)
  - A two-element cell array whose first element is a pointer to a schema function that defines an item entry and whose second element is data to be inserted as user data in the callback info object (see “Callback Info Object” on page 65-10) passed to the schema function



- 'separator', which causes a separator to appear between the item defined by the preceding entry in the cell array and the item defined in the following entry. The case is ignored for this entry (for example, 'SEPARATOR' and 'Separator' are both valid entries). A separator is also suppressed if it appears at the beginning or end of the submenu and separators that would appear successively are combined into a single separator (for example, as a result of an item being hidden).

For example, the following cell array specifies two submenu entries:

```
{@getItem1, 'separator', {@getItem2, 1}}
```

In this example, a 1 is passed to `getItem2` via a callback info object.

- `generateFcn`

Pointer to a function that returns a cell array defining the contents of the submenu. The cell array must have the same format as that specified for the container schema objects `childrenFcns` property.

---

**Note:** The `generateFcn` property takes precedence over the `childrenFcns` property. If you set both, the `childrenFcns` property is ignored and the cell array returned by the `generateFcn` is used to create the submenu.

---

- `userdata`

Data of any type that is passed to `generateFcn`.

- `autoDisableWhen`

Property that controls when a menu item is automatically disabled.

Setting	When Menu Items Are Disabled
'Locked'	(default) When the active editor is locked or when the model is busy
'Busy'	Only if the model is busy
'Never'	Never

## Register Menu Customizations

You must register custom items to be included on a Simulink menu with the customization manager. Use the `sl_customization.m` file for a Simulink installation (see “Registering Customizations” on page 65-26) to perform this task. In particular, for each menu that you want to customize, your system's `sl_customization` function must invoke the customization manager's `addCustomMenuFcn` method. Each invocation should pass the tag of the menu (see “Menu Tags” on page 65-11) to be customized and a custom menu function that specifies the items to be added to the menu (see “Creating the Custom Menu Function” on page 65-10). For example, the following `sl_customization` function adds custom items to the Simulink Tools menu.

```
function sl_customization(cm)
    %% Register custom menu function.
    cm.addCustomMenuFcn('Simulink:ToolsMenu', @getMyItems);
```

### Creating the Custom Menu Function

The custom menu function returns a cell array of schema functions that define custom items that you want to appear on the model editor menus (see “Define Menu Items” on page 65-4). The custom menu function returns a cell array similar to that returned by the `generateFcn` function.

Your custom menu function should accept a callback info object (see “Callback Info Object” on page 65-10) and return a cell array that lists the schema functions. Each element of the cell array can be either a handle to a schema function or a two-element cell array whose first element is a handle to a schema function and whose second element is user-defined data to be passed to the schema function. For example, the following custom menu function returns a cell array that lists three schema functions.

```
function schemas = getMyItems(callbackInfo)
    schemas = {@getItem1, ...
              @getItem2, ...
              {@getItem3,3} }; % Pass 3 as userdata to getItem3.
end
```

### Callback Info Object

Instances of these objects are passed to menu customization functions. Methods and properties of these objects include:

- `uiObject`

Method to get the handle to the owner of the menu for which this is the callback. The owner can be the Simulink Editor or the Stateflow Editor.

- `model`

Method to get the handle to the model being displayed in the editor window.

- `userdata`

User data property. The value of this property can be any type of data.

## Debugging Custom Menu Callbacks

On systems using the Microsoft Windows operating system, selecting a custom menu item whose callback contains a breakpoint can cause the mouse to become unresponsive or the menu to remain open and on top of other windows. To fix these problems, use the MATLAB code debugger keyboard commands to continue execution of the callback.

## Menu Tags

A menu tag identifies a Simulink Editor or the Stateflow Editor menu bar or menu. You need to know a menu's tag to add custom items to it (see “Register Menu Customizations” on page 65-10). You can configure the editor to display all (see “Displaying Menu Tags” on page 65-13) but these tags.

Tag	What it adds
Simulink tags	
<code>Simulink:MenuBar</code>	Menu to Simulink Editor's menu bar
<code>Simulink:PreContextMenu</code>	Item to the beginning of Simulink Editor's context menu
<code>Simulink:ContextMenu</code>	Item to the end of Simulink Editor's context menu
<code>Simulink:FileMenu</code>	Item near the end of the Simulink Editor's <b>File</b> menu, but before the <b>Exit MATLAB</b> item
<code>Simulink&gt;EditMenu</code>	Item to the end of the Simulink Editor's <b>Edit</b> menu
<code>Simulink:ViewMenu</code>	Item to the end of the Simulink Editor's <b>View</b> menu

Tag	What it adds
Simulink:DisplayMenu	Item to the end of the Simulink Editor's <b>Display</b> menu
Simulink:DiagramMenu	Item to the end of the Simulink Editor's <b>Diagram</b> menu
Simulink:SimulationMenu	Item to the end of the Simulink Editor's <b>Simulation</b> menu
Simulink:AnalysisMenu	Item to the end of the Simulink Editor's <b>Analysis</b> menu
Simulink:CodeMenu	Item to the end of the Simulink Editor's <b>Code</b> menu
Simulink:ToolsMenu	Item to the end of the Simulink Editor's <b>Tools</b> menu
Simulink:HelpMenu	Item to the end of Simulink Editor's <b>Help</b> menu
Stateflow tags	
Stateflow:MenuBar	Menu to Stateflow Editor's menu bar
Stateflow:PreContextMenu	Item to the beginning of Stateflow Editor's context menu.
Stateflow:ContextMenu	Items to the end of Stateflow Editor's context menu.
Stateflow:FileMenu	Item near the end of the Stateflow Editor's <b>File</b> menu, but before the <b>Exit MATLAB</b> item
Stateflow>EditMenu	Item to the end of Stateflow Editor's <b>Edit</b> menu
Stateflow:ViewMenu	Item to the end of the Stateflow Editor's <b>View</b> menu
Stateflow:DisplayMenu	Item to the end of the Stateflow Editor's <b>Display</b> menu
Stateflow:ChartMenu	Item to the end of the Stateflow Editor's <b>Chart</b> menu
Stateflow:SimulationMenu	Item to the end of the Stateflow Editor's <b>Simulation</b> menu
Stateflow:AnalysisMenu	Item to the end of the Stateflow Editor's <b>Analysis</b> menu

Tag	What it adds
Stateflow:CodeMenu	Item to the end of the Stateflow Editor's <b>Code</b> menu
Stateflow:ToolsMenu	Item to the end of the Stateflow Editor's <b>Tools</b> menu
Stateflow:HelpMenu	Item to the end of the Stateflow Editor's <b>Help</b> menu

### Displaying Menu Tags

You can configure the Simulink and Stateflow software to display the tag for a menu item next to the item's label, allowing you to determine at a glance the tag for a menu. The `Simulink:TagName` customizations appear only if the current editor is the Simulink Editor. The `Stateflow:TagName` customizations appear only if the current editor is the Stateflow Editor.

To configure the editor to display menu tags, at the MATLAB command line, set the customization manager's `showWidgetIdAsToolTip` property to `true`. For example:

```
cm = sl_customization_manager;  
cm.showWidgetIdAsToolTip=true;
```

The tag of each menu item appears next to the item's label on the menu:

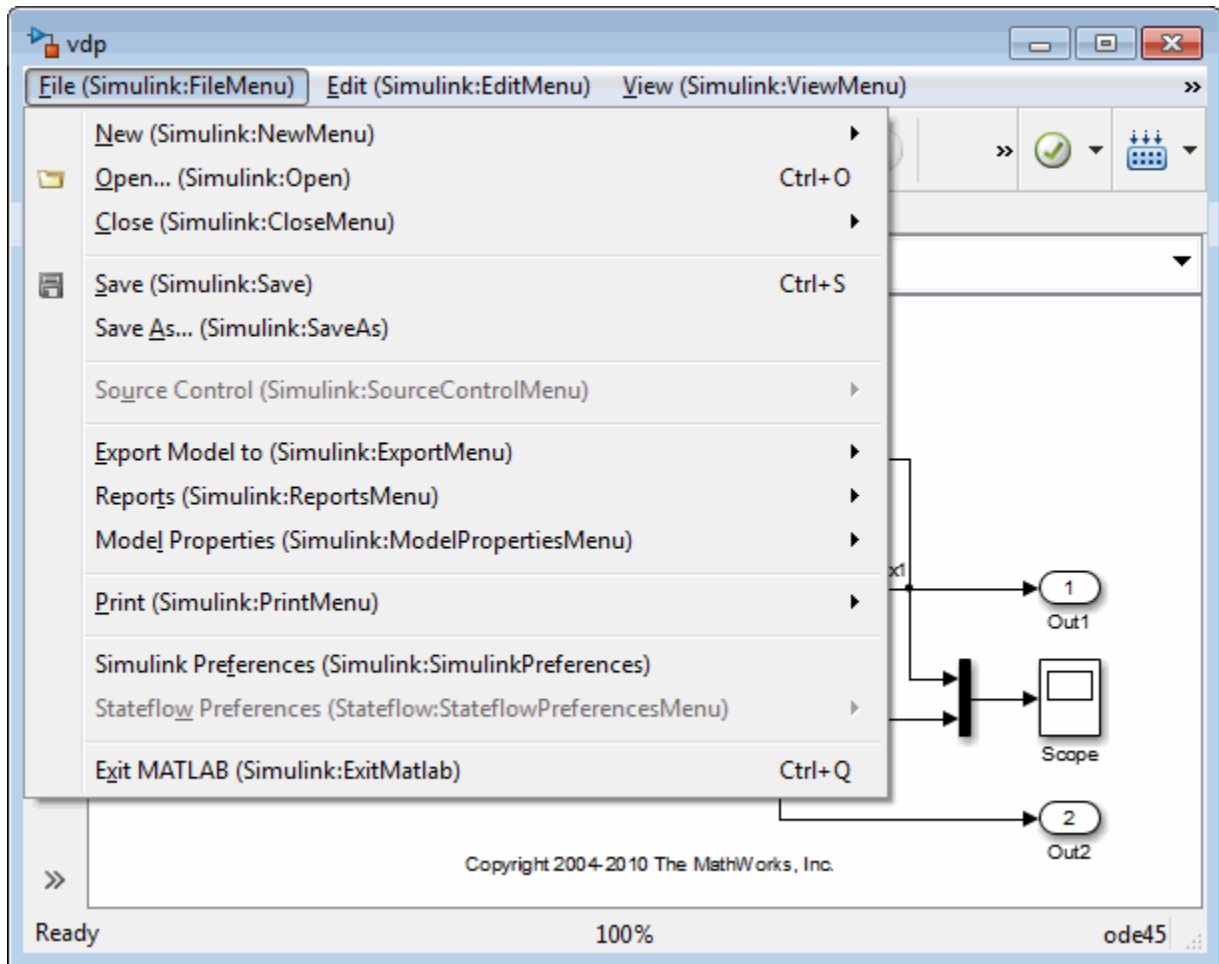

To turn off tag display, enter the following command at the command line:

```
cm.showWidgetIdAsToolTip=false;
```

---

**Note:** Some menu items may not work while menu tag display is enabled. To ensure that all items work, turn off menu tag display before using the menus.

---

## Simulink and Stateflow Editor Menu Customization

Use the same general procedures to customize Stateflow Editor menus as you use for Simulink Editor. The addition of custom menu functions to the ends of top-level menus depends on the active editor:

- Menus bound to `Simulink:FileMenu` only appear when the Simulink Editor is active.
- Menus bound to `Stateflow:FileMenu` only appear when the Stateflow Editor is active.
- To have a menu to appear in both of the editors, call `addCustomMenuFcn` twice, once for each tag. Check that the code works in both editors.

## Related Examples

- “Disable and Hide Model Editor Menu Items” on page 65-16
- “Disable and Hide Dialog Box Controls” on page 65-18
- “Customize Library Browser Appearance” on page 65-23
- “Registering Customizations” on page 65-26

## Disable and Hide Model Editor Menu Items

### In this section...

“About Disabling and Hiding Model Editor Menu Items” on page 65-16

“Example: Disabling the New Model Command on the Simulink Editor's File Menu” on page 65-16

“Creating a Filter Function” on page 65-16

“Registering a Filter Function” on page 65-17

### About Disabling and Hiding Model Editor Menu Items

You can disable or hide items that appear on the Simulink Editor menus. To disable or hide a menu item, you must:

- Create a filter function that disables or hides the menu item (see “Creating a Filter Function” on page 65-16).
- Register the filter function with the customization manager (see “Registering a Filter Function” on page 65-17).

### Example: Disabling the New Model Command on the Simulink Editor's File Menu

```
function sl_customization(cm)
    cm.addCustomFilterFcn('Simulink:NewModel',@myFilter);
end

function state = myFilter(callbackInfo)
    state = 'Disabled';
end
```

### Creating a Filter Function

Your filter function must accept a callback info object and return the state that you want to assign to the menu item. Valid states are

- 'Hidden'
- 'Disabled'



- 'Enabled'

Your filter function may have to compete with other filter functions and with Simulink itself to assign a state to an item. Who succeeds depends on the strength of the state that each assigns to the item. 'Hidden' is the strongest state. If any filter function or Simulink assigns 'Hidden' to the item, it is hidden. 'Enabled' is the weakest state. For an item to be enabled, all filter functions and the Simulink or Stateflow products must assign 'Enabled' to the item. The 'Disabled' state is of middling strength. It overrides 'Enabled' but is itself overridden by 'Hidden'. For example, if any filter function or Simulink or Stateflow assigns 'Disabled' to a menu item and none assigns 'Hidden' to the item, the item is disabled.

---

**Note:** The Simulink software does not allow you to filter some menu items, for example, the **Exit MATLAB** item on the Simulink **File** menu. An error message is displayed if you attempt to filter a menu item that you are not allowed to filter.

---

## Registering a Filter Function

Use the customization manager's `addCustomFilterFcn` method to register a filter function. The `addCustomFilterFcn` method takes two arguments: a tag that identifies the menu or menu item to be filtered (see “Displaying Menu Tags” on page 65-13) and a pointer to the filter function itself. For example, the following code registers a filter function for the **New Model** item on the Simulink **File** menu.

```
function sl_customization(cm)
    cm.addCustomFilterFcn('Simulink:NewModel',@myFilter);
end
```

## Related Examples

- “Add Items to Model Editor Menus” on page 65-2
- “Disable and Hide Dialog Box Controls” on page 65-18
- “Customize Library Browser Appearance” on page 65-23
- “Registering Customizations” on page 65-26

## Disable and Hide Dialog Box Controls

### In this section...

“About Disabling and Hiding Controls” on page 65-18

“Disable a Button on a Dialog Box” on page 65-18

“Write Control Customization Callback Functions” on page 65-19

“Dialog Box Methods” on page 65-20

“Dialog Box and Widget IDs” on page 65-20

“Register Control Customization Callback Functions” on page 65-21

### About Disabling and Hiding Controls

Simulink includes a customization API that allows you to disable and hide controls (also referred to as *widgets*), such as text fields and buttons, on most dialog boxes. The customization API allows you to disable or hide controls on an entire class of dialog boxes, for example, parameter dialog boxes, by way of a single method call.

Before you customize a Simulink dialog box or class of dialog boxes, first make sure that the dialog box or class of dialog boxes is customizable. Any dialog box that appears in the dialog pane of Model Explorer is customizable. In addition, any dialog box that has dialog and widget IDs is customizable. To determine whether a dialog box is customizable, open the dialog box, enable dialog and widget ID display (see “Dialog Box and Widget IDs” on page 65-20), and hover over a widget. If a widget ID appears, you can customize the dialog box.

Once you have determined that a dialog box or class of dialog boxes is customizable, write MATLAB code to customize the dialog boxes. This entails writing callback functions that disable or hide controls for a specific dialog box or class of dialog boxes (see “Write Control Customization Callback Functions” on page 65-19) and registering the callback functions using the customization manager (see “Register Control Customization Callback Functions” on page 65-21). Simulink invokes the callback functions to disable or hide the controls whenever you open the dialog boxes.

### Disable a Button on a Dialog Box

This `sl_customization.m` file disables the **Browse** button on the **Code Generation** pane of the Configuration Parameters dialog box for any model whose name contains engine.

```

function sl_customization(cm)

% Disable for standalone Configuration Parameters dialog box.
cm.addDlgPreOpenFcn('Simulink.ConfigSet',@disableRTWBrowseButton)
% Disable for Configuration Parameters dialog box
cm.addDlgPreOpenFcn('Simulink.RTWCC',@disableRTWBrowseButton)

end

function disableRTWBrowseButton(dialogH)
    hSrc = dialogH.getSource; % Simulink.RTWCC
    hModel = hSrc.getModel;
    modelName = get_param(hModel, 'Name');

    if ~isempty(strfind(modelName, 'engine'))
        % Takes a cell array of widget Factory ID.
        dialogH.disableWidgets({'Tag_ConfigSet_RTW_Browse'})
    end
end
end

```

To test this customization:

- 1 Save the `sl_customization.m` file on the MATLAB path.
- 2 Refresh the customizations by entering `sl_refresh_customizations` at the command line or by restarting MATLAB (see “Registering Customizations” on page 65-26).
- 3 Open the `sldemo_engine` model, for example, by entering the command `sldemo_engine` at the command prompt.
- 4 Open the Configuration Parameters dialog box and look at the **Code Generation** pane to see if the **Browse** button is disabled.

## Write Control Customization Callback Functions

A callback function for disabling or hiding controls on a dialog box accepts one argument: a handle to the dialog box object that contains the controls you want to disable or hide. The dialog box object provides methods that the callback function can use to disable or hide the controls that the dialog box contains.

The dialog box object also provides access to objects containing information about the current model. Your callback function can use these objects to determine whether to disable or hide controls. For example, this callback function uses these objects to disable the **Browse** button on the **Code Generation** pane of the Configuration Parameters dialog box for any model whose name contains `engine`.

```
function disableRTWBrowseButton(dialogH)

    hSrc = dialogH.getSource; % Simulink.RTWCC
    hModel = hSrc.getModel;
    modelName = get_param(hModel, 'Name');

    if ~isempty(strfind(modelName, 'engine'))
        % Takes a cell array of widget Factory ID.
        dialogH.disableWidgets({'Tag_ConfigSet_RTW_Browse'})
    end
```

## Dialog Box Methods

Dialog box objects provide these methods for enabling, disabling, and hiding controls:

- `disableWidgets(widgetIDs)`
- `hideWidgets(widgetIDs)`

`widgetIDs` is a cell array of widget identifiers (see “Dialog Box and Widget IDs” on page 65-20) that specify the widgets to disable or hide.

## Dialog Box and Widget IDs

Dialog box and widget IDs identify a control on a Simulink dialog box. To determine the dialog box and widget ID for a particular control, execute the following code at the command line:

```
cm = sl_customization_manager;
cm.showWidgetIdAsToolTip = true
```

Open the dialog box that contains the control and hover over the control to display a tooltip listing the dialog box and the widget IDs. For example, hovering over the **Start time** field on the **Solver** pane of the Configuration Parameters dialog box shows that the dialog box ID for the **Solver** pane is `Simulink.SolverCC` and the widget ID for the **Start time** field is `Simulink.SolverCC.StartTime`.

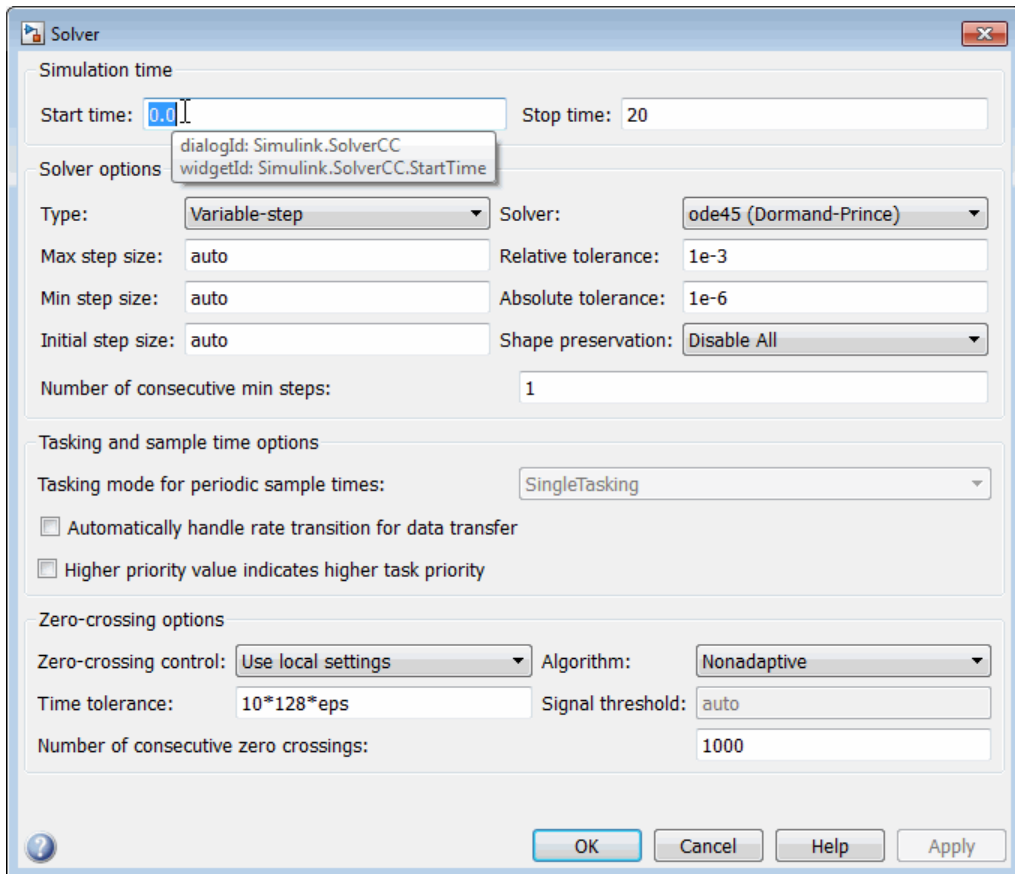

---

**Note:** The tooltip displays not customizable for controls that are not customizable.

---

## Register Control Customization Callback Functions

To register control customization callback functions for an installation of Simulink, include code in the installation's `sl_customization.m` file (see "Registering Customizations" on page 65-26) that invokes the customization manager's `addDlgPreOpenFcn` method on the callbacks.

`addDlgPreOpenFcn` takes two arguments. The first argument is a dialog box ID (see “Dialog Box and Widget IDs” on page 65-20) and the second is a pointer to the callback function to register. Invoking this method causes the registered function to be invoked for each dialog box of the type specified by the dialog box ID. The function is invoked before the dialog box is opened.

This example registers a callback that disables the **Browse** button on the **Code Generation** pane of the Configuration Parameters dialog box (see “Write Control Customization Callback Functions” on page 65-19).

```
function sl_customization(cm)

    % Disable for standalone Configuration Parameters dialog box.
    cm.addDlgPreOpenFcn('Simulink.ConfigSet',@disableRTWBrowseButton)

    % Disable for Configuration Parameters dialog box.
    cm.addDlgPreOpenFcn('Simulink.RTWCC',@disableRTWBrowseButton)

end
```

---

**Note:** Registering a customization callback causes Simulink to invoke the callback for every instance of the class of dialog boxes specified by the method’s dialog box ID argument. You can therefore use a single callback to disable or hide a control for an entire class of dialog boxes. In particular, you can use a single callback to disable or hide the control for a parameter that is common to most built-in blocks. Most built-in block dialog boxes are instances of the same dialog box super class.

---

## Related Examples

- “Add Items to Model Editor Menus” on page 65-2
- “Disable and Hide Model Editor Menu Items” on page 65-16
- “Customize Library Browser Appearance” on page 65-23
- “Registering Customizations” on page 65-26

## Customize Library Browser Appearance

### In this section...

“Reorder Libraries” on page 65-23

“Disable and Hide Libraries” on page 65-24

“Expand or Collapse Library in Browser Tree” on page 65-25

### Reorder Libraries

A library’s name and sort priority determines its order in the tree view of the Library Browser. Libraries appear in ascending order of priority. Libraries that have the same priority are sorted alphabetically.

The Simulink library has a sort priority of -1 by default. All other libraries have a sort priority of 0 by default. These sort priorities cause the Simulink library to display first in the Library Browser by default.

You can reorder libraries by changing their sort priorities. To change library sort priorities, add code in this form to an `sl_customization.m` file on the MATLAB path:

```
cm.LibraryBrowserCustomizer.applyOrder({'LIBNAME1',PRIORITY1, ...
                                         'LIBNAME2',PRIORITY2, ...
                                         .
                                         'LIBNAMEN',PRIORITYN});
```

`LIBNAMEn` is the name of the library (or its model file) and `PRIORITYn` is an integer indicating the library's sort priority. For example, this code moves the Simulink Extras library to the top of the Library Browser’s tree view.

```
cm.LibraryBrowserCustomizer.applyOrder({'Simulink Extras',-2});
```

After adding or modifying the `sl_customization.m` file, enter `sl_refresh_customizations` at the MATLAB command prompt to see the customizations take effect.

For more information on the customization functions, see “Registering Customizations” on page 65-26.

## Disable and Hide Libraries

To disable or hide libraries, sublibraries, or library blocks, insert code in this form in an `sl_customization.m` file (see “Registering Customizations” on page 65-26) on the MATLAB path. Blocks that you hide in a library also do not appear on the quick insert menu that you invoke in the model.

```
cm.LibraryBrowserCustomizer.applyFilter({'Item1', 'State', ...
                                         'Item2', 'State', ...
                                         :
                                         'ItemN', 'State'});
```

- `ItemN` is the library, sublibrary, or block to disable or hide. Specify the item in the form `'LibraryName/Sublibrary/Block'`.
  - `LibraryName` is the library name as it appears in the browser. For a custom library, you set this value in the `slblocks.m` file with the `Browser.Name` property.
  - `Sublibrary` is the name of the sublibrary or, for a custom library, a `Subsystem` block. You can specify a block inside the subsystem in your library or in a library that you open by way of the subsystem’s `OpenFcn` callback. See “Create a Custom Library” on page 39-4.
  - `Block` is the block name.
- `'State'` is `'Disabled'` or `'Hidden'`.

For example, this code hides the `Sources` sublibrary of the `Simulink` library and disables the `Sinks` sublibrary.

```
cm.LibraryBrowserCustomizer.applyFilter({'Simulink/Sources', 'Hidden'});
cm.LibraryBrowserCustomizer.applyFilter({'Simulink/Sinks', 'Disabled'});
```

This code disables the `Sqrt` block in the sublibrary opened by way of the `Subsystem2` block in the custom library `'My Library'`.

```
cm.LibraryBrowserCustomizer.applyFilter({'My Library/Subsystem2/Sqrt', 'Disabled'});
```

After adding or modifying the `sl_customization.m` file, enter `sl_refresh_customizations` at the MATLAB command prompt to see the customizations take effect.



## Expand or Collapse Library in Browser Tree

You can add a customization to expand or collapse any library in the Library Browser tree by default. For example, the Simulink library is expanded by default. You can specify to instead collapse it by default. Add code in this form to your `sl_customization.m` file:

```
cm.LibraryBrowserCustomizer.applyNodePreference({'libraryName' ,logical});
```

Use `true` to expand the library and `false` to collapse it.

For example, this code collapses the Simulink library and expands the Stateflow library:

```
function sl_customization(cm)
    cm.LibraryBrowserCustomizer.applyNodePreference({'Simulink',false,'Simscape',true});
end
```

This code collapses a custom library named 'My Library'.

```
function sl_customization(cm)
    cm.LibraryBrowserCustomizer.applyNodePreference({'My Library',false});
end
```

After adding or modifying the `sl_customization.m` file, enter `sl_refresh_customizations` at the MATLAB command prompt to see the customizations take effect.

## Related Examples

- “Add Items to Model Editor Menus” on page 65-2
- “Disable and Hide Model Editor Menu Items” on page 65-16
- “Disable and Hide Dialog Box Controls” on page 65-18
- “Registering Customizations” on page 65-26
- “Add Libraries to the Library Browser” on page 39-10

## Registering Customizations

### About Registering Customizations in Simulink

Register your customizations using the MATLAB function `sl_customization.m`. Place the function on the MATLAB path of the Simulink installation that you want to customize or in the current folder.

You can have more than one `sl_customization.m` file. The customizations in each file takes effect, with conflicts handled by each customization. For example, if you specify priorities for libraries in multiple `sl_customization` files, only one takes effect. If you add the same menu item twice, it appears twice. To ensure that customizations are loading as expected, refresh the customizations, as described in “Reading and Refreshing the Customization File” on page 65-27.

The `sl_customization` function accepts one argument: a handle to the customization manager object, that is, `cm`. For example:

```
function sl_customization(cm)
```

In your `sl_customization` function, use customization manager object properties and methods specific to your application to register customizations. You can use customization properties and methods to:

- “Add Items to Model Editor Menus” on page 65-2
- “Disable and Hide Model Editor Menu Items” on page 65-16
- “Disable and Hide Dialog Box Controls” on page 65-18
- “Add Libraries to the Library Browser” on page 39-10
- “Customize Library Browser Appearance” on page 65-23
- “Customize Bus Object Import and Export” on page 63-90
- “Import Lookup Table Data from MATLAB” on page 36-31

Additional MathWorks products use the customization manager object and the `sl_customization.m` file. Refer to your product documentation to learn about the methods and properties that apply to your product.

## Reading and Refreshing the Customization File

The `sl_customization.m` file is read when Simulink starts. If you change the `sl_customization.m` file, either restart Simulink or enter this command to see the changes:

```
sl_refresh_customizations
```

This command runs all `sl_customization.m` files on the MATLAB path and in the current folder. Some side-effects of running `sl_refresh_customizations` include:

- Rebuilding all Simulink Editor menus and toolbars
- Rebuilding the Library Browser menus and toolbars
- Clearing the Library Browser cache and refreshing the Library Browser
- Reloading the Signal and Scope Manager data

## Related Examples

- “Add Items to Model Editor Menus” on page 65-2
- “Disable and Hide Model Editor Menu Items” on page 65-16
- “Disable and Hide Dialog Box Controls” on page 65-18
- “Customize Library Browser Appearance” on page 65-23
- “Add Libraries to the Library Browser” on page 39-10



# Frames for Printed Models

---

- “Print Frames” on page 66-2
- “Create a Print Frame” on page 66-6
- “Add Rows and Cells to Print Frames” on page 66-7
- “Add Content to Print Frame Cells” on page 66-9
- “Print Using Print Frames” on page 66-13

## Print Frames

### In this section...

“What Are Print Frames?” on page 66-2

“PrintFrame Editor” on page 66-3

“Single Use or Multiple Use Print Frames” on page 66-4

“Text and Variable Content” on page 66-5

### What Are Print Frames?

Print frames are borders of a printed page that contain information about a block diagram, such as the model name or the date of printing. After you create a print frame, use the Simulink or Stateflow Editor to print a block diagram or chart with that print frame.

The default print frame has two rows:

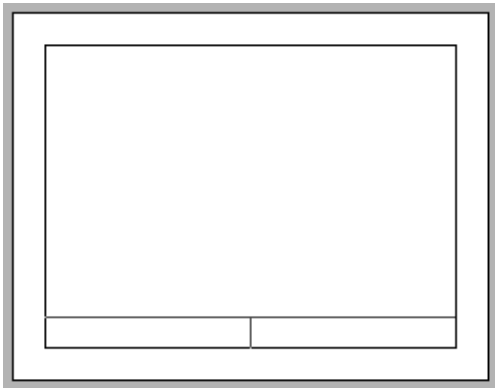

Rows contain one or more cells. You can add content entries to cells. You can also add new rows and cells.

For example, the print frame below includes:

- An additional row at the top of the frame for a title

- A middle row, which includes the block diagram
- A bottom row, in which one cell has the path to the subsystem and another cell has the page number

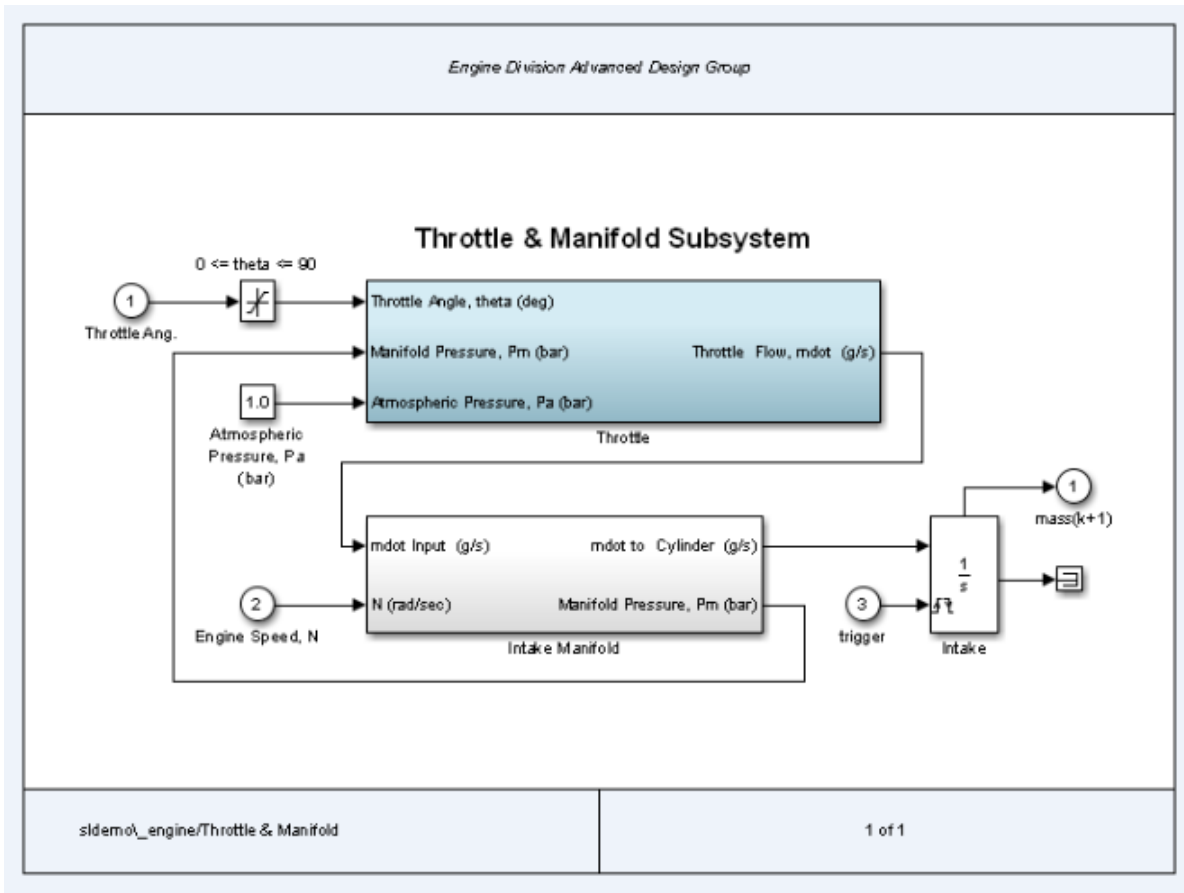

## PrintFrame Editor

Use the PrintFrame Editor to create and edit print frames.

To open the PrintFrame Editor, at the MATLAB command line, enter the `frameedit` command.

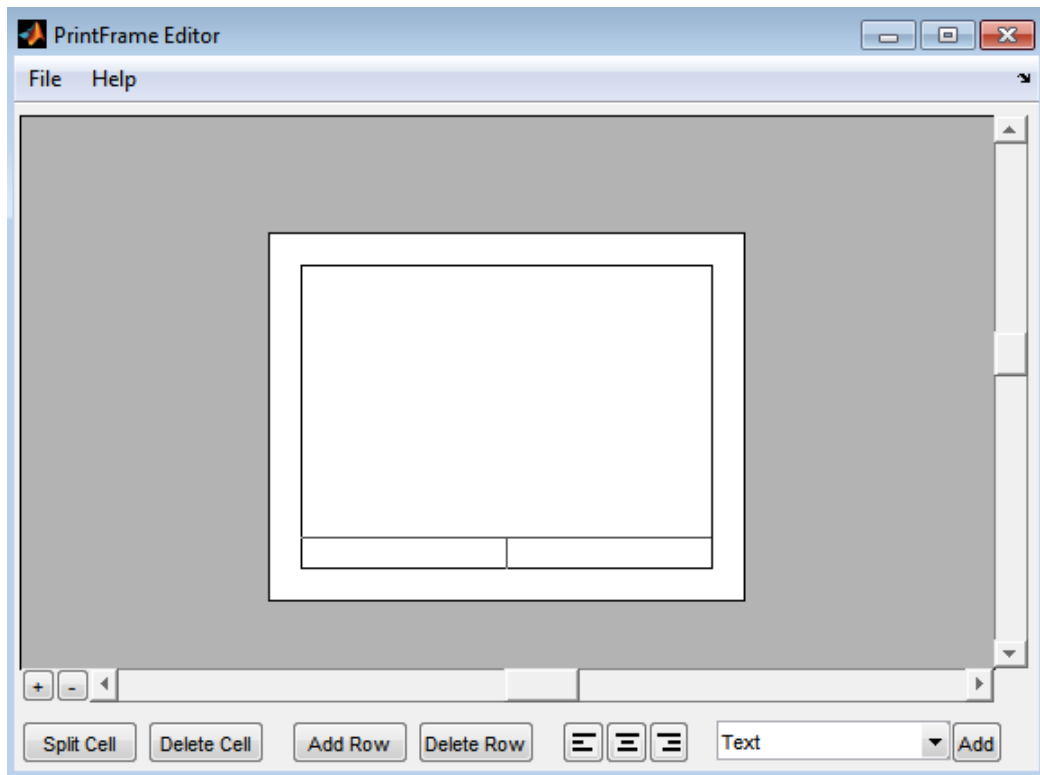

Use the PrintFrame Editor to:

- Set up the printed page
- Add or remove rows and cells in the print frame
- Add content to cells, such as text, the date, and page numbers
- Format cell content

To open an existing print frame, use `frameedit` command with the `filename` parameter, where `filename` is an existing print frame (a `.fig` file).

## Single Use or Multiple Use Print Frames

You can design a print frame for one particular block diagram, or you can design a more generic print frame for printing multiple block diagrams.



## Text and Variable Content

In cells, you can include text (such as the name and address of your organization) and variable content (such as the current date).

### See Also

frameedit

### Related Examples

- “Create a Print Frame” on page 66-6
- “Print Using Print Frames” on page 66-13

## Create a Print Frame

- 1 At the MATLAB prompt, type `frameedit` to open the PrintFrame Editor.
- 2 In the PrintFrame Editor, select **File > Page Setup**.

If necessary, change default page setup for the print frame, which is:

- Paper type — usletter
- Orientation — landscape

---

**Note:** The paper orientation you specify does not control the paper orientation used for printing. For example, assume you specify a landscape-oriented print frame in the PrintFrame Editor. If you want the printed page to have a landscape orientation, you must specify that using the Print Model dialog box.

---

- Margins — .75 inches on all sides
- 3 Set up the layout of the print frame and add content. See:
    - “Add Rows and Cells to Print Frames” on page 66-7
    - “Add Content to Print Frame Cells” on page 66-9
  - 4 Save the print frame as a `.fig` file. Select **File > Save As**.

### Related Examples

- “Add Rows and Cells to Print Frames” on page 66-7
- “Add Content to Print Frame Cells” on page 66-9

### More About

- “Print Frames” on page 66-2

## Add Rows and Cells to Print Frames

### In this section...

“Add and Remove Rows” on page 66-7

“Add and Remove Cells” on page 66-7

“Resize Rows and Cells” on page 66-7

---

**Tip:** Specify the print frame page setup before you create rows and cells or add content (see “Create a Print Frame” on page 66-6).

---

### Add and Remove Rows

You can add a row above the row that you select.

- 1 Click in a cell to select a row.

When you select a row, handles appear on all four corners. If you select only a line, handles appear on two corners.

- 2 Click **Add Row**.

The new row appears above the row that you selected.

To remove a row, select the row and click **Delete Row**.

### Add and Remove Cells

You can add cells within a row.

- 1 Select the cell that you want to split.

- 2 Click **Split Cell**.

The cell splits into two cells.

To remove a cell, select the cell and click **Delete Cell**.

### Resize Rows and Cells

You can change the dimensions of a row or cell by selecting the bordering line.

**1** Click the line you want to move.

A handle appears on both ends of the line.

**2** Drag the line to resize the row or cell.

For example, to make a row taller, click on the top line that forms the row. Then drag the line up and the height of the row increases.

To change the overall dimensions of the print frame, see “Create a Print Frame” on page 66-6.

### **Related Examples**

- “Create a Print Frame” on page 66-6
- “Add Content to Print Frame Cells” on page 66-9
- “Print Using Print Frames” on page 66-13

### **More About**

- “Print Frames” on page 66-2

## Add Content to Print Frame Cells

### In this section...

- “Types of Content” on page 66-9
- “Add Content to Cells” on page 66-9
- “Block Diagram” on page 66-10
- “Variables” on page 66-10
- “Text” on page 66-11
- “Format Content in Cells” on page 66-12

### Types of Content

You can add text or variables, or both, to a cell.

You must add a **Block Diagram** variable to one of the cells.

For details about the types of content, see:

- “Block Diagram” on page 66-10
- “Variables” on page 66-10
- “Text” on page 66-11

### Add Content to Cells

- 1 Select the cell that you want to add content to.
- 2 From the list, select the type of content that you want to add.
- 3 Click **Add**.

The type of content that you added appears in the cell.

---

**Tip:** If you click **Add** and nothing happens, it might be because you did not select a cell first.

---

- 4 If you add text, select the edit box and type in the text. For details, see “Text” on page 66-11.

---

**Tip:** To make it easier to read and edit the content that you add, you can click the **Zoom in +** button.

---

### **Include Multiple Entries in a Cell**

- 1 Select a cell that has a content entry.
- 2 Add another content type item from the list.

The new entry is added after the last entry in that cell.

You can also add descriptive text to any of the variable entries without using the **Text** item.

- 1 Double-click in the cell.
- 2 Type text in the edit box before or after the entry.
- 3 To end editing mode, click outside of the cell.

---

**Note:** You cannot include multiple entries or text in the cell that contains the **Block Diagram** variable. `%<blockdiagram>` must be the only content in that cell.

---

## **Block Diagram**

Use the **Block Diagram** variable to indicate the cell in which to print the block diagram. Every print frame must include one **Block Diagram** variable. If you do not specify a **Block Diagram** in one of the cells, you cannot save the print frame and cannot print a block diagram with it.

Do not add any other content in a cell that contains a **Block Diagram** variable.

## **Variables**

In addition to the **Block Diagram** variable, you can add other variables, such as the current date, to cells. Simulink supplies variable content at the time of printing.

Variable entries include:

- **Block Diagram** — Add this variable in the cell in which you want the block diagram to print. For details, see “Block Diagram” on page 66-10.

- **Date** — The date that the block diagram and print frame are printed, in `dd-mmm-yyyy` format.
- **Time** — The time that the block diagram and print frame are printed, in `hh:mm` format.
- **Page Number** — The page of the block diagram being printed.
- **Total Pages** — The total number of pages being printed for the block diagram, which depends on the printing options specified.
- **System Name** — The name of the block diagram being printed.
- **Full System Name** — The name of the block diagram being printed, including its position from the root system through the current system, for example, `engine/Throttle & Manifold`.
- **File Name** — The file name of the block diagram, for example, `sldemo_engine.mdl`.
- **Full File Name** — The full path and file name for the block diagram, for example, `\matlab\toolbox\simulink\simdemos\automotive\sldemo_engine.mdl`.

When you enter a variable, the cell displays the type of content in brackets, `<>`, preceded by a percent sign, `%`. For example, if you add a **Page Number** variable, it appears as `%<page>`.

---

**Note:** Do not edit the text of a variable entry, because then the variable content does not print. For example, if you accidentally remove the `%` from the `%<page>` entry, the text `<page>` prints, instead of the actual page number.

---

## Text

For **Text** content, type the text that you want to include in that cell (for example, the name of your organization). To type additional text on a new line, press the **Enter** key. When you are finished editing, click outside of the edit box.

You can copy and paste text from another document into a cell. Any formatting of the copied text is lost.

To type special characters (for example, superscripts and subscripts, Greek letters, and mathematical symbols), use embedded TeX sequences. For a list of allowable sequences, see the `text` command **String** property (in **Text Properties**).

## **Format Content in Cells**

You can align cell contents using the left, center, and right alignment buttons. (Block diagrams are always center aligned.)

You can change font properties, such as size or style (for example, italics or bold). To change font properties, select the cell, then right-click the contents and use the context menu to format the text.

## **Related Examples**

- “Create a Print Frame” on page 66-6
- “Add Rows and Cells to Print Frames” on page 66-7
- “Print Using Print Frames” on page 66-13

## **More About**

- “Print Frames” on page 66-2



## Print Using Print Frames

To print using a print frame, you specify an existing print frame. If you want to build a print frame, see “Create a Print Frame” on page 66-6.

---

**Note:** If you enable the print frame option, then Simulink does not use tiled printing.

---

- 1 In the Simulink Editor or Stateflow Editor, select **File > Print > Print**.
- 2 In the Print Model dialog box, select the **Frame** check box.

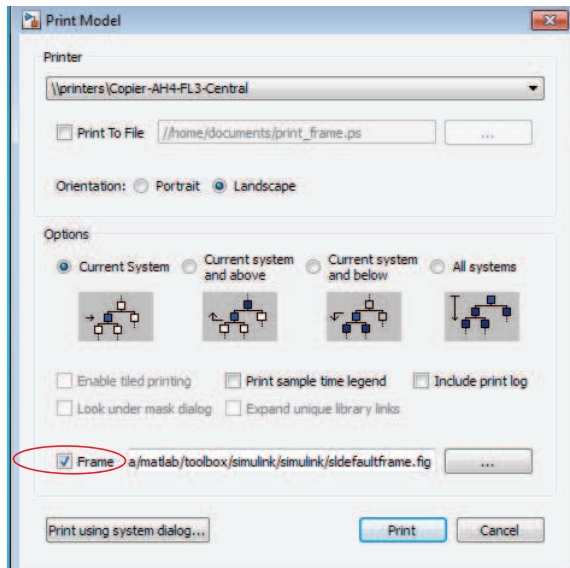

- 3 Supply the file name for the print frame you want to use. Either type the path and file name directly in the edit box, or click the ... button and select a print frame file you saved using the PrintFrame Editor. The default print frame file name, `sldefaultframe.fig`, appears in the file name edit box until you specify a different file name.
- 4 Specify other printing options in the Print Model dialog box.

---

**Note:** The paper orientation you specify with the PrintFrame Editor does not control the paper orientation used for printing. For example, assume you specify a landscape-oriented print frame in the PrintFrame Editor. If you want the printed page to have a landscape orientation, you must specify that using the Print Model dialog box.

---

**5** Click **OK**.

The block diagram prints with the print frame that you specify.

### **Related Examples**

- “Create a Print Frame” on page 66-6
- “Add Rows and Cells to Print Frames” on page 66-7
- “Add Content to Print Frame Cells” on page 66-9

### **More About**

- “Print Frames” on page 66-2
- “Tiled Printing” on page 1-77

# Running Models on Target Hardware



# About Run on Target Hardware Feature

---

- “Simulink Supported Hardware” on page 67-2
- “Tune and Monitor Models Running on Target Hardware” on page 67-3
- “Block Produces Zeros or Does Nothing in Simulation” on page 67-8

## Simulink Supported Hardware

As of this release, Simulink supports the following hardware.

Support Package	Vendor	Earliest Release Available	Last Release Available
Android Devices	Android	R2014a	Current
Apple iOS Devices	Apple	R2015a	Current
Arduino Hardware	Arduino	R2012a	Current
BeagleBoard Hardware	BeagleBoard	R2012a	R2016a
LEGO MINDSTORMS NXT Hardware	LEGO	R2012a	R2016b
LEGO MINDSTORMS EV3 Hardware	LEGO	R2014a	Current
Raspberry Pi Hardware	Raspberry Pi	R2013a	Current

For a complete list of supported hardware, see [Hardware Support](#).

## Tune and Monitor Models Running on Target Hardware

### In this section...

“Overview of Using External Mode” on page 67-3

“Run Your Simulink Model in External Mode” on page 67-4

“Stop External Mode” on page 67-5

“External Mode Control Panel” on page 67-5

### Overview of Using External Mode

You can use External mode to tune parameters and monitor a model running on your target hardware.

External mode enables you to tune model parameters and evaluate the effects of different parameter values on model results in real time. Doing so helps you find the optimal values to achieve desired performance. This process is called *parameter tuning*.

External mode accelerates parameter tuning because you do not have to rerun the model each time you change parameters. You can also use External mode to develop and validate your model using the actual data and hardware for which it is designed. This software-hardware interaction is not available solely by simulating a model.

This workflow lists the tasks usually required to tune parameters with External mode:

- 1 In the model on your host computer, enable External mode.
- 2 (Optional) Place one or more sink blocks in your model. For example, use Display or Scope blocks to visualize data, or use a To File block to log signal data.
- 3 Give the Simulink software command to run the model on the target hardware.
- 4 (Optional) Observe the data External mode sends from the target hardware to sink blocks in the model on the host computer.
- 5 Change and apply parameter values in the model on your host computer.
- 6 Find the optimal parameter values by making adjustments and observing the results.
- 7 Save the new parameter values, disable External mode, and save the model.

## Run Your Simulink Model in External Mode

---

**Note:** If you have the Embedded Coder or Simulink Coder software, you can use External mode with a model that contains Model blocks (uses the “Model reference”).

---

- 1 Connect the target hardware to your host computer.

Different types of target hardware can use different types of connections. Check the External mode topic for your target hardware to determine which type of connection to use.

- 2 On the model toolbar, set **Simulation mode** to External.

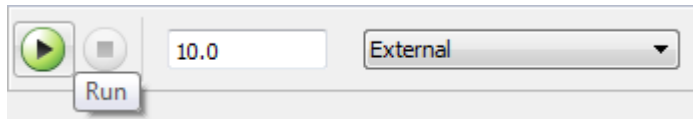

- 3 Set the **Simulation stop time** parameter, located to the left of **Simulation mode** on the model toolbar. The default value is 10.0 seconds. To run the model for an indefinite period, enter `inf`.
- 4 Click the **Run** button.

If your model does not contain a sink block, the MATLAB Command Window displays a warning message. For example:

```
Warning: No data has been selected for uploading.
> In C:\Program Files (x86)\MATLAB\R2013a Student1\toolbox\
realtime\realtime\+realtime\extModeAutoConnect.p>
extModeAutoConnect at 17
In C:\Program Files (x86)\MATLAB\R2013a Student1\toolbox\
realtime\realtime\sl_customization.p>myRunCallback at 149
```

You can disregard this warning or add a sink block to the model.

After several minutes, Simulink starts running your model on the board.

- 5 Change parameter values in the model on your host computer.

Observe the corresponding changes in the model running on the hardware.



Any Simulink Sinks blocks in your model receive data from the hardware and display it on your host computer.

---

**Note:** External mode increases the processing burden of the model running on the board, and can cause overruns.

---

## Stop External Mode

To stop the model running in External mode, click the black square Stop button located on the model toolbar, as shown here.

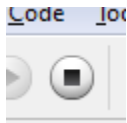

This action stops the process for the model running on the target hardware, and stops the model simulation running on your host computer.

If the **Simulation stop time** parameter is set to a specific number of seconds, External mode stops when that time elapses.

When you are finished using External mode, set **Simulation mode** back to Normal.

## External Mode Control Panel

Using External Mode Control Panel provides additional control of External mode operations, including:

- Connect or disconnect the model on the host computer to/from the model running on the target hardware.
- Start and stop the model running on the target hardware.
- Gather changes to parameter values in a batch before applying them concurrently to the model running on the target hardware.

To open the External Mode Control Panel dialog box, in the model window, select **Code > External Mode Control Panel**.

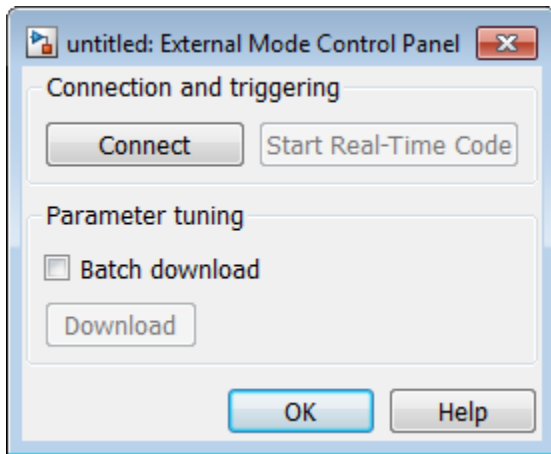

The **Connect/Disconnect** button connects or disconnects the model on your host computer to/from the model running on the target hardware. If the model is not running on the target hardware, clicking **Connect** automatically deploys and runs the model on the target hardware.

- The **Start Real-Time Code/Stop Real-Time Code** button starts or stops the model running on the target hardware.
- **Batch download** enables you to gather changes before using the **Download** button to simultaneously apply those changes to the model running on the hardware:
  - While **Batch download** is disabled, clicking **OK** or **Apply** in a block dialog box sends updated block parameter values from the block to the model running on the target hardware.
  - When you enable **Batch download**, clicking **OK** or **Apply** in a block dialog box stores updated block parameter values on the host computer. You can complete a set of changes before clicking **Download** to simultaneously send all of the updated values to the model running on the target hardware. This feature is useful for avoiding error conditions when a model contains blocks whose parameter values must be changed concurrently.

External Mode Control Panel displays **Parameter changes pending...** to the right of the **Download** button until the model running on the target hardware has applied the new parameter values.

## **See Also**

“Tune and Monitor Model Running on Arduino Mega 2560 Hardware” (Simulink Support Package for Arduino Hardware)

## Block Produces Zeros or Does Nothing in Simulation

If you simulate a model on your host computer without running it on your target hardware:

- Input blocks produce zeros.
- Output blocks do nothing.

This is the expected behavior.

For example, in a model, if you select **Simulation > Mode > Normal** and then select **Simulation > Run**, the following happens:

- The sensor block and Digital Input block send zeros to the model.
- The Digital Output block does nothing.

To see the blocks work normally, run your model on target hardware or use External mode.

To run the model on target hardware, select **Tools > Run on Target Hardware > Prepare to Run**. Then, click the Deploy to Hardware button.

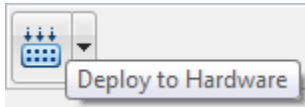

To use External mode, select **Simulation > Mode > External**. Then, select **Simulation > Run**.

### Related Examples

- “Tune and Monitor Models Running on Target Hardware” on page 67-3

# Running Simulations in Fast Restart

---

- “How Fast Restart Improves Iterative Simulations” on page 68-2
- “Fast Restart Workflow” on page 68-4
- “Get Started with Fast Restart” on page 68-6
- “Simulate a Model Using Fast Restart” on page 68-8
- “Stop Simulation and Exit Fast Restart” on page 68-10
- “Fast Restart Methodology” on page 68-11
- “Factors Affecting Fast Restart” on page 68-15

## How Fast Restart Improves Iterative Simulations

In the classic Simulink workflow, when you simulate a model, Simulink:

- 1 Compiles the model
- 2 Simulates the model
- 3 Terminates the simulation

While developing a model, you typically simulate a model repeatedly as you iterate the design. For example, you might calibrate input values or block parameters for a particular response. Changing these values or parameters does not always require compiling the model before simulating again. However, in the classic workflow, each simulation compiles the model, even if the changes do not alter the model structurally. Each compile slows down the process and increases overall simulation time.

Fast restart allows you to perform iterative simulations without compiling a model or terminating the simulation each time. Using fast restart, you compile a model only once. You can then tune parameters and root inputs and simulate the model again without spending time on compiling. Fast restart associates multiple simulation phases to a single compile phase to make iterative simulations more efficient.

Use fast restart when your workflow does not require structural changes to the model. Also, fast restart is better suited if the workflow involves any of these factors:

- The model requires multiple simulations in which simulation inputs or parameters change in every iteration.
- The compile time of the model is several seconds or longer.

You can use fast restart in normal and accelerator simulation modes. When you use fast restart in accelerator mode, you reduce simulation time and perform only a single compilation.

### Related Examples

- “Fast Restart Workflow” on page 68-4
- “Get Started with Fast Restart” on page 68-6
- “Simulate a Model Using Fast Restart” on page 68-8

### More About

- “Simulation Phases in Dynamic Systems” on page 3-17

- “Tune and Experiment with Block Parameter Values” on page 35-38
- “Choosing a Simulation Mode” on page 33-12
- “Factors Affecting Fast Restart” on page 68-15

## Fast Restart Workflow

When you need to simulate a model iteratively to tune parameters, achieve a desired response, or automate testing, use fast restart to avoid compiling again.

- 1 Turn on fast restart using the **Fast restart** button on the Simulink Editor toolbar or from the command line.
- 2 Simulate the model. The first simulation requires the model to compile, initialize and save a `SimState`. Once the simulation is complete, it does not terminate. Instead, the model is initialized again in fast restart.
- 3 Perform any of these actions:
  - Change tunable parameters.
  - Tune root-level inputs.
  - Modify base workspace, model workspace variables and data dictionary entries that are referenced by tunable parameters.
  - Change inputs to From File and From Workspace blocks.
  - Change the **Initial state** parameter for the next simulation.
  - Using the Signal Builder block, change data, rename signals and signal groups, and add new groups.
  - Change the signal logging override values for the model programmatically by using the `set_param` command and the `DataLoggingOverride` parameter. See “Override Signal Logging Settings from MATLAB” on page 59-99.

Once you have initialized a model in fast restart, you cannot

- Change the dimension, type, or complexity of a signal or variable.
- Make changes to a nontunable parameter such as sample time.
- Make structural changes such as adding or deleting blocks or connections.

These changes require you to compile the model again. To make changes like these, turn off fast restart, make your changes, and repeat this procedure.

- 4 Simulate the model. The model uses the new values of parameters and inputs that you provided but does not compile again.
- 5 Once you have achieved the desired response, turn off fast restart.



---

**Note:** When you turn off fast restart, Simulink does not store any compile information for the model. The model compiles when you next simulate the model.

---

## **Related Examples**

- “Get Started with Fast Restart” on page 68-6

## **More About**

- “How Fast Restart Improves Iterative Simulations” on page 68-2
- “Factors Affecting Fast Restart” on page 68-15
- “Save and Restore Simulation State as SimState” on page 23-37

## Get Started with Fast Restart

### In this section...

“Prepare a Model to Use Fast Restart” on page 68-6

“Enable Fast Restart” on page 68-6

### Prepare a Model to Use Fast Restart

Before you simulate a model in fast restart, ensure that the model meets these requirements:

- If you have enabled callbacks in the model, make sure they do not attempt to make structural changes when the model is reinitialized. For example, callbacks such as mask initialization commands get called at the beginning of each simulation. Therefore, avoid using mask initialization code that makes structural changes to the model.
- All blocks in the model must support `SimState`.
- The simulation mode is Normal or Accelerator mode.

---

**Caution:** When fast restart is on, you cannot save changes to the model after it compiles. Saving changes requires Simulink to discard information about the compiled state. To save any changes to the model, turn off fast restart first.

---

### Enable Fast Restart

Use one of these methods to enable fast restart:

- Click the **Fast restart** button  on the Simulink Editor toolbar.
- At the MATLAB Command prompt, use `set_param` to enable fast restart. Type `set_param(model, 'FastRestart', 'on')`

### Related Examples

- “Fast Restart Workflow” on page 68-4

- “Simulate a Model Using Fast Restart” on page 68-8

### **More About**

- “Fast Restart Methodology” on page 68-11
- “Factors Affecting Fast Restart” on page 68-15

## Simulate a Model Using Fast Restart

After you load your model and turn on fast restart, simulate the model.

- 1 Simulate the model by calling `sim` or clicking the **Run** button  in the Simulink Editor toolstrip. The first simulation in fast restart requires the model to compile and save a `SimState`.

Once the simulation is complete, the status bar shows that the model is initialized in fast restart.

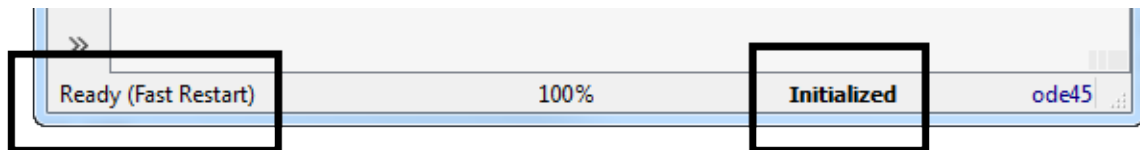

- 2 Adjust tunable parameters in the model, such as the gain value of a Gain block, or tune root-level input values. You can also make changes to base workspace variables. You cannot adjust nontunable parameters such as sample time, because doing so requires the model to compile once more.
- 3 Simulate the model again. This time, the model does not compile. When you click the **Play** button or step forward, Simulink updates blocks that have new values as well as blocks that reference workspace variables.
- 4 When you are satisfied with your results, turn off fast restart by clicking the **Fast restart** button off.
- 5 To keep your changes, save the model.

---

**Note:** After a model is initialized in fast restart, Simulink displays a warning if you attempt to make a structural change to the model. To make such changes, you must turn off fast restart.

---

### Related Examples

- “Fast Restart Workflow” on page 68-4

## **More About**

- “Stop Simulation and Exit Fast Restart” on page 68-10
- “Fast Restart Methodology” on page 68-11

## Stop Simulation and Exit Fast Restart

### In this section...

“Stop a Simulation” on page 68-10

“Exit Fast Restart” on page 68-10

### Stop a Simulation

When you click **Stop** in the middle of a fast restart simulation:

- Simulation does not terminate.
- The model is in the initialized state.
- You can now change tunable parameters in the model
- You can terminate the simulation and exit fast restart by clicking the **Fast restart** button off.

### Exit Fast Restart

You can exit fast restart only when the model is in the initialized state. After simulating, click the **Fast restart** button off. To do this programmatically, type:

```
set_param(model, 'FastRestart', 'off')
```

- Simulink terminates simulation.
- Simulink discards any compiled information about the model.
- The model must compile again the next time you simulate.

### Related Examples

- “Fast Restart Workflow” on page 68-4

### More About

- “Fast Restart Methodology” on page 68-11

# Fast Restart Methodology

## In this section...

“Simulation Modes” on page 68-11

“Tuning Parameters Between Simulations” on page 68-11

“Model Methods and Callbacks in Fast Restart” on page 68-11

“SimState and Initial State Values” on page 68-13

“Analyze Data Using the Simulation Data Inspector” on page 68-13

“Custom Code in the Initialize Function” on page 68-13

## Simulation Modes

You can use fast restart in Normal and Accelerator simulation modes.

## Tuning Parameters Between Simulations

- When a model is initialized in fast restart, in addition to block values and base workspace variables, you can tune parameters in the **Data Import/Export** and **Solver** panes in the **Simulation > Model Configuration Parameters** dialog box.
- Certain parameters are tunable between simulations only when the model is initialized in fast restart. They include:
  - **Initial Value** parameter of the IC block
  - **Initial Output** parameter of the Merge block
  - **Data** parameter of the From Workspace block
  - **Signal** parameter and signal groups of the Signal Builder block.

## Model Methods and Callbacks in Fast Restart

When fast restart is on, Simulink calls model and block methods and callbacks as follows:

- 1 Call model `InitFcn` callback.
- 2 Call model `SetupRuntimeResources` method.
  - a Call `mdlSetupRuntimeResources` S-function method.

- 3 Call model `Start` method.
  - a Call `mdlStart` S-function method.
- 4 Call model `Initialize` method.
  - a Call `mdlInitializeConditions` S-function method.

---

**Note:** Use the `ssIsFirstInitCond` flag to guard code that should run only during the initialization phase of any simulation, including the first and subsequent initializations in fast restart.

---

- 5 Call model and block `StartFcn` callbacks.

---

**Note:** Steps 1–5 apply to all simulations in Simulink (with or without fast restart).

---

- 6 For the first simulation in fast restart, capture a simulation snapshot. A simulation snapshot contains simulation state (`SimState`) and information related to logged data and visualization blocks. As part of the snapshot capture, call `mdlGetSimState` S-function method.
- 7 This is a standard execution phase of any simulation, with or without fast restart.
  - Call model `Outputs`.
  - Call model `Update`.
  - Call model `Derivatives`.
  - Repeat these steps in a loop until stop time or a stop is requested.
- 8 Call model `Terminate` method.
  - a Call `mdlTerminate` S-function method.
- 9 After simulation ends, call model and block `StopFcn` callbacks. This is a standard phase of any simulation, with or without fast restart.
- 10 Restore the simulation snapshot taken for fast restart. As part of the restore, call `mdlSetSimState` S-function method.
- 11 Wait in a reinitialized state until one of these actions:
  - To run another simulation (programmatically or using the Simulink Editor) in fast restart, return to step 3.
  - To end Fast Restart mode and uncompile the model:



- a Call the model method `CleanupRuntimeResources` and the `mdlCleanupRuntimeResources` S-function method.
- b Do not call `StopFcn` callbacks again at this point.

In some cases, the `Start` and `Terminate` methods are only called once and not for each successive Fast Restart simulation. In these cases, these method calls are combined with calls to `SetupRuntimeResources` and `CleanupRuntimeResources`, respectively. These cases are as follows:

- When an S-function contains custom `SimState` save and restore methods.
- When an S-function sets the flag `SS_OPTION_CALL_TERMINATE_ON_EXIT`.
- When an S-function is placed inside the accelerated mode of a referenced model.

For more information on model callbacks, see “Callbacks for Customized Model Behavior” on page 4-46.

## SimState and Initial State Values

You can change initial state values, including `SimState`, in between fast restart simulations.

When a `SimState` object for initial state is used in fast restart, every new simulation resets to the start time of the model and not the snapshot time of each `SimState` object. Thereafter, on the first step forward, Simulink checks to see if a `SimState` has been specified. If yes, Simulink restores it before computing the next step. Thus, the first simulation step effectively fast forwards to the snapshot time of the specified `SimState` object.

## Analyze Data Using the Simulation Data Inspector

Fast restart supports data logging using the Simulation Data Inspector. Every simulation in fast restart creates an SDI object with the name `<modelname> fast restart run <number>`. The value of `number` increments for each simulation.

## Custom Code in the Initialize Function

When you place custom code in the **Configuration Parameters > Simulation Target > Custom Code > Initialize function** pane in the **Model Configuration Parameters** dialog box, this gets called only during the first simulation in fast restart.

## **Related Examples**

- “Fast Restart Workflow” on page 68-4
- “Tune and Experiment with Block Parameter Values” on page 35-38

## **More About**

- “Factors Affecting Fast Restart” on page 68-15
- “What Is a SimState?” (Stateflow)

## Factors Affecting Fast Restart

There are some limitations to simulating in fast restart.

- Fast restart does not support these modes:
  - Rapid Accelerator
  - External
- When a model is in the reinitialized state, you cannot:
  - Make structural changes.
  - Make changes to nontunable parameters such as sample time.
  - Save changes to the model. You must turn off fast restart to save any changes to the model.
- You cannot turn on fast restart in a model if it contains blocks that do not support `SimState`. These blocks include:
  - Legacy (pre-R2016a) `SimEvents` blocks
  - Simscape Multibody First Generation blocks
  - MATLAB function blocks that contain system objects
  - S-functions that do not implement `SimState` `get` and `set` methods but have `Pwork` vectors declared
  - From Multimedia File
  - To Multimedia File
  - From Audio Device
  - To Audio Device
  - Multipath Rician Fading Channel
  - Multipath Rayleigh Fading Channel
  - Derepeat
  - DC Blocker
  - Stack
  - Queue
  - Read Binary File
  - Write Binary File

- Video Viewer
- Frame Rate Display
- Video From Workspace
- Video To Workspace
- Between simulations, fast restart does not handle changes to design data, such as bus properties.
- When you use fast restart for model references in Accelerator mode, you cannot tune block parameters.
- The Fixed-Point Tool provides limited support when a model is simulated in fast restart. You must exit fast restart to collect simulation and derived ranges, and propose data types.
- When fast restart is on, you cannot change the variant that a variant subsystem or variant model uses. This is because the inactive subsystems are not compiled in the first simulation.
- When there are multiple model references to the same submodel, you cannot change the model visibility when the model is in the reinitialized state.
- Fast restart is not compatible with these tools:
  - Simulink Profiler
  - Simulink Debugger
- When simulating a model in fast restart, you cannot run checks using Model Advisor.
- When you enable fast restart, the `sim` command supports only the single output `Simulink.SimulationOutput` form, regardless of the syntax you use in the command.
- When you enable fast restart, you cannot pass non-tunable parameters as arguments to `sim`.

## Related Examples

- “Fast Restart Workflow” on page 68-4

## More About

- “How Fast Restart Improves Iterative Simulations” on page 68-2

# Package Models to Share

---

## Packaged Models

\*\* This is a placeholder for an overview of packaged models \*\*